

**FCC PART 15C TEST REPORT FOR CERTIFICATION**  
On Behalf of

TCL Technoly Electronics (Huizhou) Co.,Ltd.

System Name : Home Theatre System  
(Active Speaker System and Active Subwoofer)

System Model Number : HT-CT260H(SA-CT260H and SA-WCT260H)

EUT Name : ACTIVE SUBWOOFER

Brand Name	Model No.
Sony	SA-WCT260H

FCC ID: ZVASB00006

Prepared for : TCL Technoly Electronics (Huizhou) Co.,Ltd.  
Section 19, Zhongkai High-tech Development Zone,  
Huizhou City, GuangDong Province, China, 516006

Prepared By : Audix Technology (Shenzhen) Co., Ltd.  
No. 6, Ke Feng Rd., 52 Block,  
Shenzhen Science & Industrial Park,  
Nantou, Shenzhen, Guangdong, China

Tel: (0755) 26639496

Report Number : ACS-F13117  
Date of Test : Mar.17~May.06, 2013  
Date of Report : May.15, 2013

**TABLE OF CONTENTS**

<u>Description</u>	<u>Page</u>
<b>1. SUMMARY OF STANDARDS AND RESULTS .....</b>	<b>1-1</b>
1.1. Description of Standards and Results.....	1-1
<b>2. GENERAL INFORMATION.....</b>	<b>2-1</b>
2.1. Description of Device (EUT) .....	2-1
2.2. Special Test information .....	2-2
2.3. Channel List .....	2-2
2.4. Tested Supporting System Details .....	2-3
2.5. Block Diagram of Test Setup .....	2-3
2.6. Test Facility.....	2-4
2.7. Measurement Uncertainty (95% confidence levels, k=2) .....	2-4
<b>3. POWER LINE CONDUCTED EMISSION MEASUREMENT.....</b>	<b>3-1</b>
3.1. Test Equipment .....	3-1
3.2. Block Diagram of Test Setup .....	3-1
3.3. Power Line Conducted Emission Test Limits.....	3-1
3.4. Configuration of EUT on Test .....	3-1
3.5. Operating Condition of EUT.....	3-2
3.6. Test Procedure.....	3-2
3.7. Conducted Emission at Mains Terminals Test Results .....	3-2
<b>4. RADIATED EMISSION MEASUREMENT .....</b>	<b>4-1</b>
4.1. Test Equipment .....	4-1
4.2. Block Diagram of Test Setup .....	4-1
4.3. Radiated Emission Limit Standard: FCC 15.209 .....	4-2
4.4. EUT Configuration on Test.....	4-2
4.5. Operating Condition of EUT.....	4-3
4.6. Test Procedure.....	4-3
4.7. Radiated Emission Test Results .....	4-3
<b>5. CONDUCTED SPURIOUS EMISSIONS .....</b>	<b>5-1</b>
5.1. Test Equipment .....	5-1
5.2. Limit.....	5-1
5.3. Test Procedure.....	5-1
5.4. Test result.....	5-1
<b>6. 6DB BANDWIDTH TEST .....</b>	<b>6-1</b>
6.1. Test Equipment .....	6-1
6.2. Limit.....	6-1
6.3. Test Results .....	6-1
<b>7. MAXIMUM PEAK OUTPUT POWER TEST.....</b>	<b>7-1</b>
7.1. Test Equipment .....	7-1
7.2. Limit.....	7-1
7.3. Test Procedure.....	7-1
7.4. Test Results .....	7-2
<b>8. POWER SPECTRAL DENSITY TEST .....</b>	<b>8-1</b>
8.1. Test Equipment .....	8-1
8.2. Limit.....	8-1
8.3. Test Procedure.....	8-1

<b>9.</b>	<b>BAND EDGE COMPLIANCE TEST .....</b>	<b>9-1</b>
9.1.	Test Equipment .....	9-1
9.2.	Limit.....	9-1
9.3.	Test Produce .....	9-1
9.4.	Test Results .....	9-1
<b>10.</b>	<b>DEVIATION TO TEST SPECIFICATIONS .....</b>	<b>10-1</b>
<b>11.</b>	<b>PHOTOGRAPH OF TEST.....</b>	<b>11-1</b>
11.1.	Photos of Conducted Disturbance at Mains Terminals Test .....	11-1
11.2.	Photos of Radiated Emission Test (30-1000MHz).....	11-2
<b>12.</b>	<b>PHOTOS OF THE EUT .....</b>	<b>12-1</b>

FCC ID: ZVASB00006

## TEST REPORT CERTIFICATION

Applicant : TCL Technoly Electronics (Huizhou) Co.,Ltd.  
Manufacturer : Sony Corporation  
System Name : Home Theatre System (Active Speaker System and Active Subwoofer)  
System Model Number : HT-CT260H (SA-CT260H and SA-WCT260H)  
EUT Name : ACTIVE SUBWOOFER  
FCC ID : ZVASB00006

(A) MODEL NO. & BRAND NAME :

Brand Name	Model No.
Sony	SA-WCT260H

(B) SERIAL NO. : N/A  
(C) POWER SUPPLY : AC 120V/60Hz  
(D) TEST VOLTAGE : AC 120V/60Hz

Tested for comply with:  
FCC Rules and Regulations Part 15 Subpart C: 2012  
Test procedure used:  
ANSI C63.10:2009

The device described above is tested by AUDIX TECHNOLOGY (SHENZHEN) CO., LTD. to confirm comply with all the FCC Part 15 Subpart C requirements. The test results are contained in this test report and AUDIX TECHNOLOGY (SHENZHEN) CO., LTD. is assumed full responsibility for the accuracy and completeness of these tests. Also, this report shows that the Equipment Under Test (EUT) is to be technically compliant with the FCC and IC requirements. This report contains data that are not covered by the NVLAP accreditation.

This Report is made under FCC Part 2.1075. No modifications were required during testing to bring this product into compliance.

This report applies to above tested sample only. This report shall not be reproduced in part without written approval of AUDIX TECHNOLOGY (SHENZHEN) CO., LTD.

The report must not be used by the client to claim product certification, approval, or endorsement by NVLAP, NIST, or any agency of the federal government.

Date of Test : Mar.17~ May.06, 2013 Report of date: May.15, 2013

Prepared by : Julia Zhu Reviewed by : Sunny Lu  
Julia Zhu / Assistant Manager Sunny Lu / Assistant Manager



Approved & Authorized Signer : Ken Lu  
Ken Lu / Manager

## 1. SUMMARY OF STANDARDS AND RESULTS

### 1.1. Description of Standards and Results

The EUT have been tested according to the applicable standards as referenced below.

EMISSION		
Description of Test Item	Standard	Results
Power Line Conducted Emission Test	FCC Part 15: 15.207 ANSI C63.10 :2009	PASS
Radiated Emission Test	FCC Part 15: 15.209 FCC Part 15: 15.247(d) ANSI C63.10 :2009	PASS
Conducted Spurious Emissions	FCC Part 15: 15.247(a)(1) ANSI C63.10 :2009	PASS
6dB Bandwidth Test	FCC Part 15: 15.215 ANSI C63.10 :2009	PASS
Maximum Peak Output Power Test	FCC Part 15: 15.247(b)(1)\ ANSI C63.10 :2009	PASS
Power Spectral Density	FCC Part 15: 15.247 ANSI C63.10: 2009	PASS
Band Edge Compliance Test	FCC Part 15: 15.247(d) ANSI C63.10 :2009	PASS

N/A is an abbreviation for Not Applicable.

## 2. GENERAL INFORMATION

### 2.1. Description of Device (EUT)

System Name : Home Theatre System  
(Active Speaker System and Active Subwoofer)

System Model Number : HT-CT260H (SA-CT260H and SA-WCT260H)

EUT Name : ACTIVE SUBWOOFER

Model Number &  
Brand Name : 

Brand Name	Model No.
Sony	SA-WCT260H

FCC ID : ZVASB00006

Operation frequency : 2404MHz-2476MHz

Antenna : Integrated PCB Antenna, 2.12dBi PK gain

Modulation : GFSK

Applicant : TCL Technoly Electronics (Huizhou) Co.,Ltd.  
Section 19, Zhongkai High-tech Development Zone,  
Huizhou City, GuangDong Province, China, 516006

Manufacturer : Sony Corporation  
1-7-1 Konan, Minato-Ku, Tokyo, 108-0075 Japan

Factory : TCL Technoly Electronics (Huizhou) Co., Ltd  
Address1:Section 19, Zhongkai High-tech Development  
Zone, Huizhou City, GuangDong Province, China, 516006  
Address2:Section 37, Zhongkai High-tech development  
Zone, Huizhou City, GuangDong Province, China, 516006

Remote Controller : Brand: Sony, Model Number: RM-ANP109

Date of Test : Mar.17~May.06, 2013

Date of Receipt : Mar.16, 2013

Sample Type : Prototype production

## 2.2.Special Test information

The test software “bluesuite.exe” was used to control EUT work in Continuous TX mode, and select test channel.

Tested mode, channel, and data rate information			
Mode	data rate (Mbps)	Channel	Frequency (MHz)
Tx Mode GFSK modulation	1	Low :CH 1	2404
	1	Middle: CH13	2440
	1	High: CH25	2476

## 2.3.Channel List

CH	Frequency(MHz)	CH	Frequency(MHz)
1	2404	16	2449
2	2407	17	2452
3	2410	18	2455
4	2413	19	2458
5	2416	20	2461
6	2419	21	2464
7	2422	22	2467
8	2425	23	2470
9	2428	24	2473
10	2431	25	2476
11	2434		
12	2437		
13	2440		
14	2443		
15	2446		

### 2.4. Tested Supporting System Details

	Description	ACS No.	Manufacturer	Model	Serial Number	Approved type
1.	iPod Nano	--	APPLE	A1446	DCYJL600F0GQ	<input checked="" type="checkbox"/> CCC
2.	Monitor	--	SamSung	SA950	--	
3.	Audio Cable	Shielded, Detachable, 1.0m				
4.	HDMI Cable	Shielded, Detachable, 1.5m				
5.	Optical Cable	Unshielded, Detachable, 1.0m				

### 2.5. Block Diagram of Test Setup

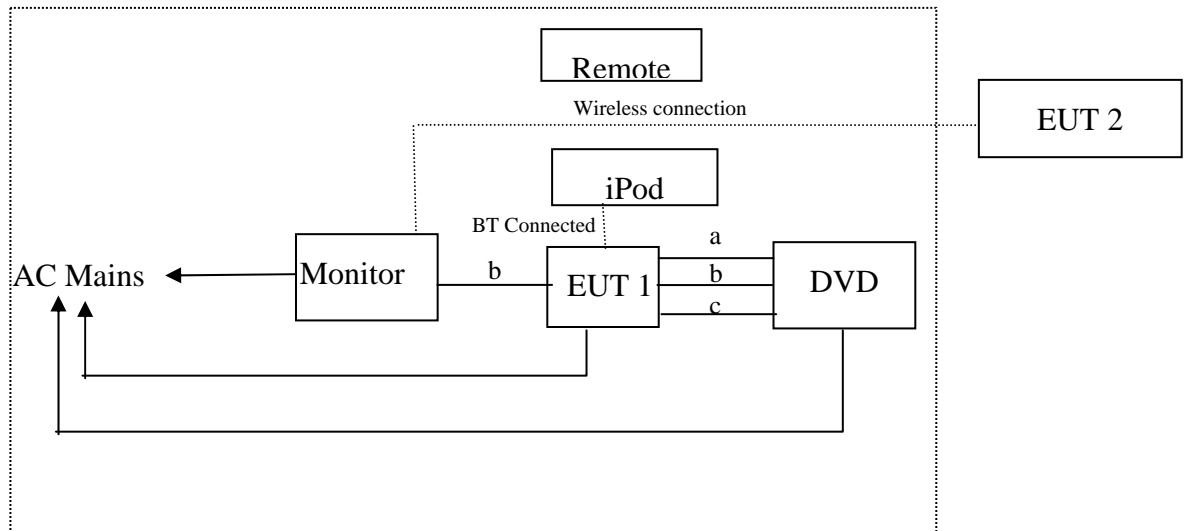

a: Audio Cable  
 b: HDMI Cable  
 c: OPICAL Cable  
 EUT 1: ACTICE SPEAKER SYSTEM  
 EUT 2: ACTIVE SUBWOOFER

**( EUT: ACTIVE SUBWOOFER)**



**2.6. Test Facility**

Site Description

Name of Firm : Audix Technology (Shenzhen) Co., Ltd.  
 No. 6, Ke Feng Rd., 52 Block, Shenzhen Science & Industrial Park, Nantou, Shenzhen, Guangdong, China

3m Anechoic Chamber : Certificated by FCC, USA  
 Registration Number: 90454  
 Valid Date: Feb.22, 2015

3m & 10m Anechoic Chamber : Certificated by FCC, USA  
 Registration Number: 794232  
 Valid Date: Oct.31, 2015

EMC Lab. : Certificated by Industry Canada  
 Registration Number: IC 5183A-1  
 Valid Date: Jun.13, 2014

Certificated by DAkKS, Germany  
 Registration No: D-PL-12151-01-01  
 Valid Date: Feb.01, 2014

Accredited by NVLAP, USA  
 NVLAP Code: 200372-0  
 Valid Date: Mar.31, 2014

**2.7. Measurement Uncertainty (95% confidence levels, k=2)**

Test Item	Uncertainty
Uncertainty for Conduction emission test in No. 1 Conduction	3.48dB(9KHz to 150KHz)
	3.06dB (150KHz to 30MHz)
Uncertainty for Radiation Emission test in 3m chamber	3.6 dB(30~200MHz, Polarize: H)
	3.8 dB(30~200MHz, Polarize: V)
	4.2 dB(200M~1GHz, Polarize: H)
	3.8 dB(200M~1GHz, Polarize: V)
Uncertainty for Radiation Emission test in 3m chamber (1GHz-18GHz)	3.1dB (Distance: 3m Polarize: V)
	3.7 dB (Distance: 3m Polarize: H)
Uncertainty for Radiated Spurious Emission test in RF chamber	3.57 dB
Uncertainty for Conduction Spurious emission test	2.00 dB
Uncertainty for Output power test	0.73 dB
Uncertainty for Bandwidth test	83 kHz
Uncertainty for DC power test	0.038 %
Uncertainty for test site temperature and humidity	0.6°C
	3%

### 3. POWER LINE CONDUCTED EMISSION MEASUREMENT

#### 3.1. Test Equipment

Item	Equipment	Manufacturer	Model No.	Serial No.	Last Cal.	Cal. Interval
1.	Test Receiver	Rohde & Schwarz	ESHS10	838693/001	Oct.31, 12	1 Year
2.	L.I.S.N.#1	Rohde & Schwarz	ESH2-Z5	834066/011	Oct.31, 12	1 Year
3.	L.I.S.N.#3	Kyoritsu	KNW-242C	8-1920-1	May.08, 12	1 Year
4.	Terminator	Hubersuhner	50Ω	No. 1	May.08, 12	1 Year
5.	Terminator	Hubersuhner	50Ω	No. 2	May.08, 12	1 Year
6.	RF Cable	Fujikura	3D-2W	No.1	May.08, 12	1 Year
7.	Coaxial Switch	Anritsu	MP59B	M50564	May.08, 12	1 Year
8.	Pulse Limiter	Rohde & Schwarz	ESH3-Z2	100341	May.08, 12	1 Year
9.	Horn Antenna	EMCO	3116	00060089	Nov.25,11	1.5 Year

#### 3.2. Block Diagram of Test Setup

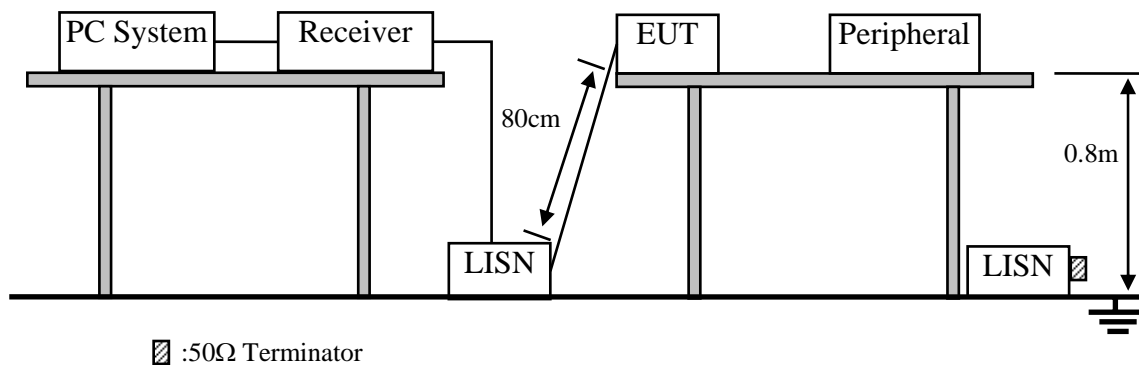

#### 3.3. Power Line Conducted Emission Test Limits

Frequency	Maximum RF Line Voltage	
	Quasi-Peak Level dB(μV)	Average Level dB(μV)
150kHz ~ 500kHz	66 ~ 56*	56 ~ 46*
500kHz ~ 5MHz	56	46
5MHz ~ 30MHz	60	50

Notes: 1. \* Decreasing linearly with logarithm of frequency.  
2. The lower limit shall apply at the transition frequencies.

#### 3.4. Configuration of EUT on Test

The following equipment are installed on Power Line Conducted Emission Test to meet the commission requirement and operating regulations in a manner which tends to maximize its emission characteristics in a normal application.

##### 3.4.1. ACTIVE SUBWOOFER (EUT)

Model Number : SA-WCT260H  
Serial Number : N/A

### 3.5. Operating Condition of EUT

- 3.5.1. Setup the EUT and simulator as shown as Section 3.2.
- 3.5.2. Turn on the power of all equipment.
- 3.5.3. Let the EUT work in test mode (TX Mode) and measure it.

### 3.6. Test Procedure

The EUT was placed on a non-metallic table, 80cm above the ground plane. The EUT Power connected to the power mains through a line impedance stabilization network (L.I.S.N. 1#). this provided a 50-ohm coupling impedance for the EUT (Please refer to the block diagram of the test setup and photographs). Both sides of power line were checked for maximum conducted interference. In order to find the maximum emission, the relative positions of equipments and all of the interface cables were changed according to ANSI C63.4-2009 on conducted Emission test.

The bandwidth of test receiver (R&S TEST RECEIVER ESHS10) is set at 9 kHz.

The frequency range from 150kHz to 30MHz is checked. The test result are reported on Section 3.7.

### 3.7. Conducted Emission at Mains Terminals Test Results

**PASS.** (All emissions not reported below are too low against the prescribed limits.)

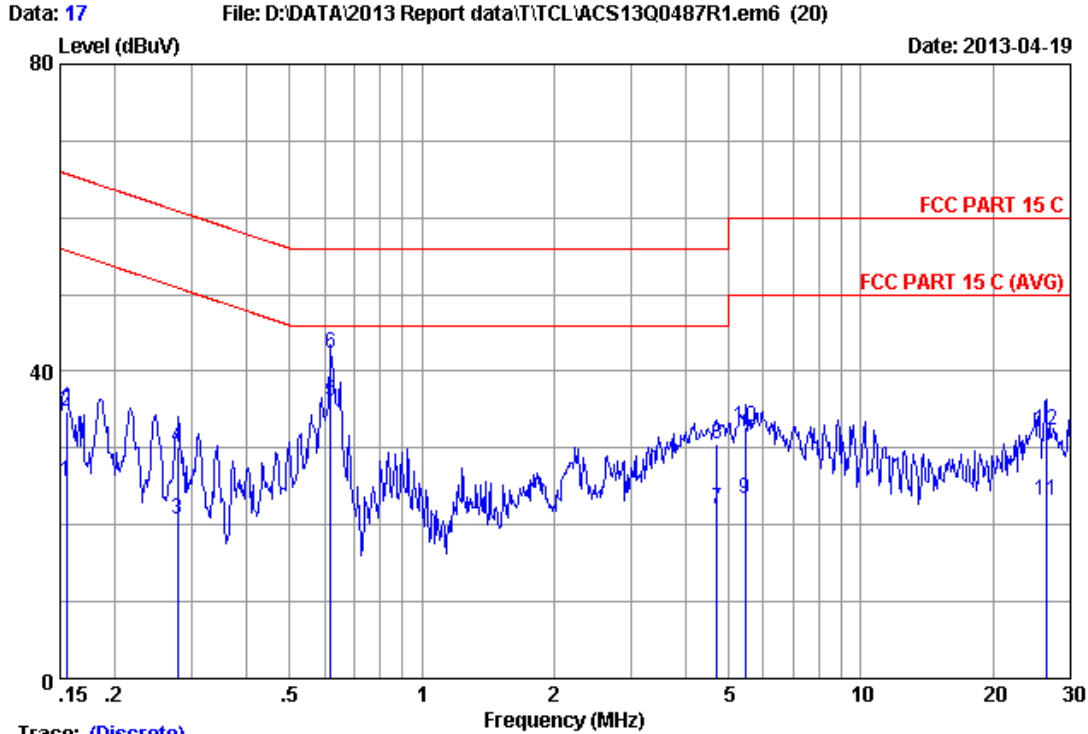

Trace: (Discrete)

Site no :1#conduction Data No :17  
 Dis./Ant. \*\*: 2012 KNW-242C-VA  
 Limit :FCC PART 15 C  
 Env./Ins. :25.8°C/69% Engineer :Leo-Li  
 EUT :ACTIVE SUBWOOFER M/N:SA-WCT260H  
 Power Rating :AC120V/60Hz  
 Test Mode :Tx Mode

No	Freq (MHz)	LISN Factor (dB)	Cable Loss (dB)	Reading (dBuV)	Emission Level (dBuV)	Limits (dBuV)	Margin (dB)	Remark
1	0.15500	0.08	0.14	25.50	25.72	55.73	30.01	Average
2	0.15500	0.08	0.14	34.60	34.82	65.73	30.91	QP
3	0.27800	0.06	0.15	20.50	20.71	50.88	30.17	Average
4	0.27800	0.06	0.15	29.80	30.01	60.88	30.87	QP
5	0.61900	0.06	0.15	35.79	36.00	46.00	10.00	Average
6	0.61900	0.06	0.15	42.09	42.30	56.00	13.70	QP
7	4.696	0.11	0.15	21.70	21.96	46.00	24.04	Average
8	4.696	0.11	0.15	30.30	30.56	56.00	25.44	QP
9	5.447	0.12	0.15	23.10	23.37	50.00	26.63	Average
10	5.447	0.12	0.15	32.40	32.67	60.00	27.33	QP
11	26.410	0.63	0.34	22.19	23.16	50.00	26.84	Average
12	26.410	0.63	0.34	31.29	32.26	60.00	27.74	QP

Remarks: 1.Emission Level=LISN Factor+Cable Loss+Reading.  
 2.If the average limit is met when using a quasi-peak detector, the EUT shall be deemed to meet both limits and measurement with average detector is unnecessary.

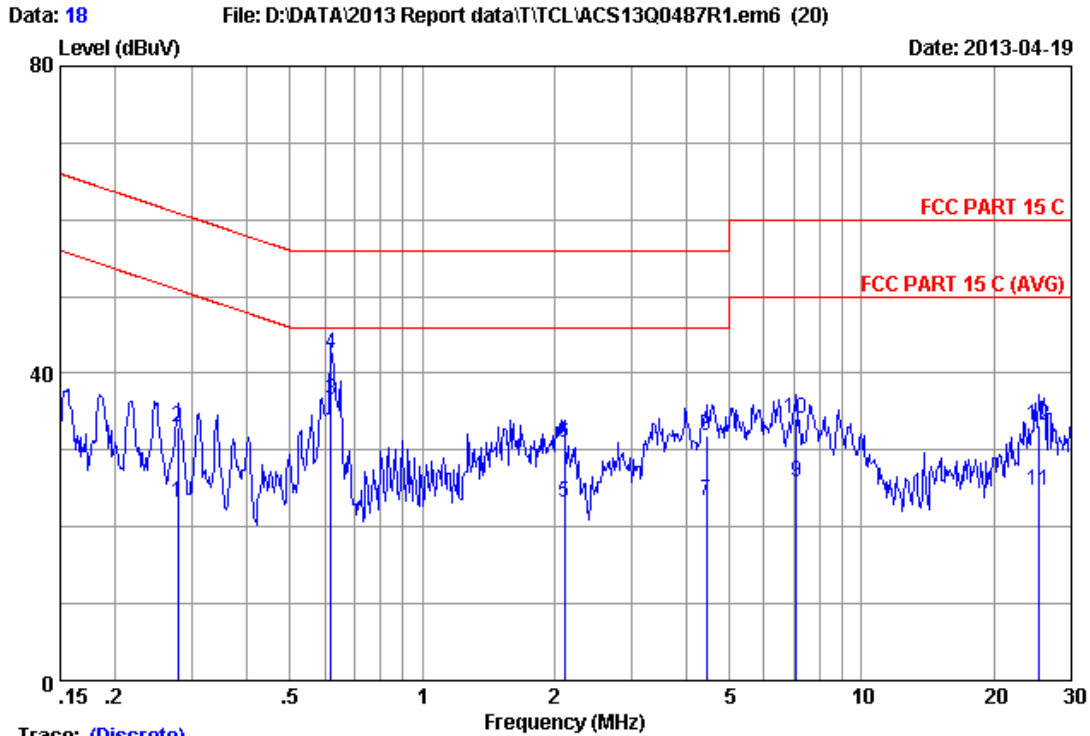

Trace: (Discrete)

Site no :1#conduction Data No :18  
 Dis./Ant. \*\*: 2012 KNW-242C-VB  
 Limit :FCC PART 15 C  
 Env./Ins. :25.8°C/69% Engineer :Leo-Li  
 EUT :ACTIVE SUBWOOFER M/N:SA-WCT260H  
 Power Rating :AC120V/60Hz  
 Test Mode :Tx Mode

No	Freq (MHz)	LISN Factor (dB)	Cable Loss (dB)	Reading (dBuV)	Emission Level (dBuV)	Limits (dBuV)	Margin (dB)	Remark
1	0.27800	0.10	0.15	23.00	23.25	50.88	27.63	Average
2	0.27800	0.10	0.15	32.70	32.95	60.88	27.93	QP
3	0.62000	0.15	0.15	36.20	36.50	46.00	9.50	Average
4	0.62000	0.15	0.15	42.20	42.50	56.00	13.50	QP
5	2.110	0.25	0.14	22.80	23.19	46.00	22.81	Average
6	2.110	0.25	0.14	30.50	30.89	56.00	25.11	QP
7	4.430	0.28	0.15	22.90	23.33	46.00	22.67	Average
8	4.430	0.28	0.15	31.50	31.93	56.00	24.07	QP
9	7.099	0.34	0.15	25.41	25.90	50.00	24.10	Average
10	7.099	0.34	0.15	33.61	34.10	60.00	25.90	QP
11	25.321	0.72	0.32	23.60	24.64	50.00	25.36	Average
12	25.321	0.72	0.32	32.20	33.24	60.00	26.76	QP

Remarks: 1.Emission Level=LISN Factor+Cable Loss+Reading.  
 2.If the average limit is met when using a quasi-peak detector, the EUT shall be deemed to meet both limits and measurement with average detector is unnecessary.

## 4. RADIATED EMISSION MEASUREMENT

### 4.1. Test Equipment

Frequency rang: 30~1000MHz

Item	Equipment	Manufacturer	Model No.	Serial No.	Last Cal.	Cal. Interval
1	3#Chamber	AUDIX	N/A	N/A	Nov.24,12	1 Year
2	EMI Spectrum	Agilent	E4407B	MY41440292	May.08, 12	1 Year
3	Test Receiver	Rohde & Schwarz	ESVS10	834468/011	May.08, 12	1 Year
4	Amplifier	HP	8447D	2648A04738	May.08, 12	1 Year
5	Trilog-Broadband Antenna	SCHWARZBECK	VULB 9168	9168-429	Nov.27, 12	1.0 Year
6	RF Cable	MIYAZAKI	CFD400-N L	3# Chamber No.1	May.08, 12	1 Year
7	Coaxial Switch	Anritsu	MP59B	M74389	May.08, 12	1 Year

Frequency rang: above 1000MHz

Item	Equipment	Manufacturer	Model No.	Serial No.	Last Cal.	Cal. Interval
1	Spectrum Analyzer	Agilent	E4407B	MY41440292	May.08, 12	1 Year
2	Horn Antenna	EMCO	3115	9510-4580	June.05, 12	1 Year
3	Amplifier	Agilent	8449B	3008A00863	May.08, 12	1 Year
4	RF Cable	Hubersuhner	SUCOFLEX106	77980/6	May.08, 12	1 Year
5	RF Cable	Hubersuhner	SUCOFLEX106	77977/6	May.08, 12	1 Year
6	Horn Antenna	EMCO	3116	00060089	Nov.25,11	1.5 Year

### 4.2. Block Diagram of Test Setup

For frequency range 30MHz-1000MHz

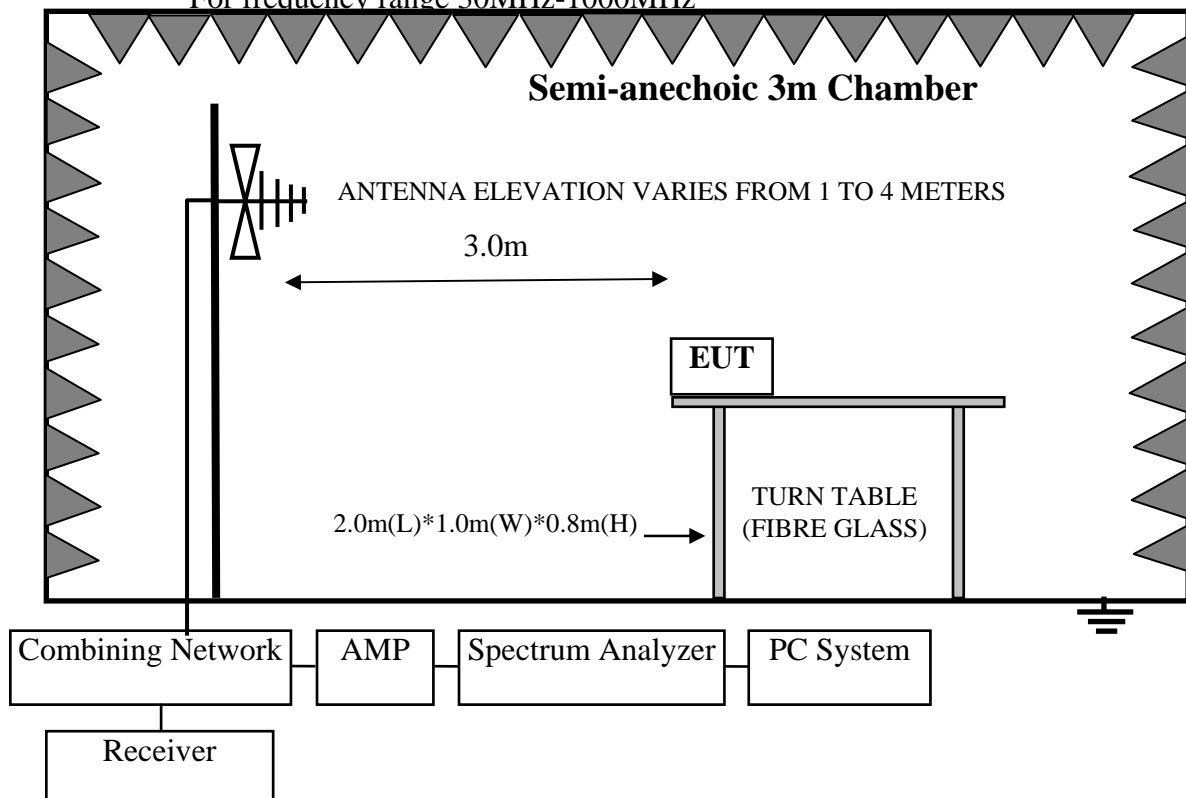

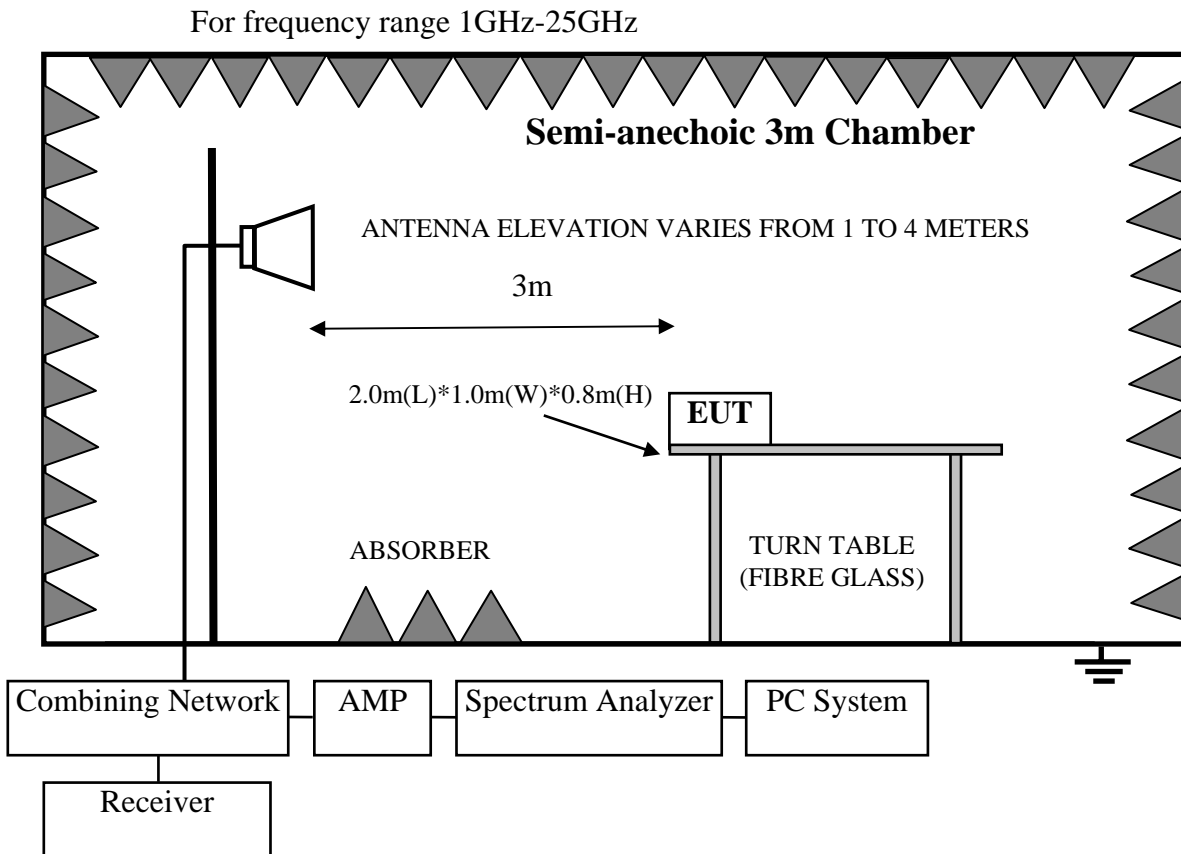

#### 4.3. Radiated Emission Limit Standard: FCC 15.209

FREQUENCY MHz	DISTANCE Meters	FIELD STRENGTHS LIMIT	
		µV/m	dB(µV)/m
30 ~ 88	3	100	40.0
88 ~ 216	3	150	43.5
216 ~ 960	3	200	46.0
960 ~ 1000	3	500	54.0
Above 1000MHz	3	74.0 dB(µV)/m (Peak) 54.0 dB(µV)/m (Average)	

Remark : (1) Emission level  $\text{dB}\mu\text{V} = 20 \log \text{Emission level } \mu\text{V}/\text{m}$

- (2) The smaller limit shall apply at the cross point between two frequency bands.
- (3) Distance is the distance in meters between the measuring instrument, antenna and the closest point of any part of the device or system.
- (4) The emission limits shown in the above table are based on measurements employing a CISPR quasi-peak detector except for the frequency bands 9-90 kHz, 110-490 kHz and above 1000 MHz. Radiated emission limits in these three bands are based on measurements employing an average detector.

#### 4.4.EUT Configuration on Test

The following equipment are installed on Radiated Emission Test to meet the commission requirements and operating regulations in a manner which tends to maximize its emission characteristics in normal application.

#### 4.4.1. ACTIVE SUBWOOFER (EUT)

Model Number : SA-WCT260H  
Serial Number : N/A

#### 4.5. Operating Condition of EUT

4.5.1. Setup the EUT and simulator as shown as Section 3.2.

4.5.2. Turned on the power of all equipment.

4.5.3. Let EUT work in Tx mode.

#### 4.6. Test Procedure

The EUT and its simulators are placed on a turn table, which is 0.8 meter high above ground. The turn table can rotate 360 degrees to determine the position of the maximum emission level. The EUT is set 3 meters away from the receiving antenna, which is mounted on an antenna tower. The antenna can be moved up and down between 1 meter and 4 meters to find out the maximum emission level. Broadband antenna (calibrated bilog antenna) is used as receiving antenna. Both horizontal and vertical polarization of the antenna is set on Test. In order to find the maximum emission levels, all of the interface cables must be manipulated according to ANSI C63.10-2009 on radiated emission Test.

This test was performed with EUT in X, Y, Z position, and the worse case was found when EUT in X position as the test photo indicated.

The bandwidth of the EMI test receiver (R&S ESVS10) is set at 120kHz for frequency range from 30MHz to 1000 MHz.

The bandwidth of the Spectrum's RBW is set at 1MHz and VBW is set at 3MHz for peak emissions measurement above 1GHz, the RBW is set at 1MHz and VBW is set at 10Hz for average emission measurement above 1GHz.

The duty cycle of the test signal is 100%.

The frequency range from 30MHz to 10th harmonic (25GHz) are checked. and no any emissions were found from 18GHz to 25 GHz, So the radiated emissions from 18GHz to 25GHz were not record.

#### 4.7. Radiated Emission Test Results

**PASS.**

All the emissions from 30MHz to 25GHz were comply with the 15.209 Limit.



Frequency: 30MHz~1GHz

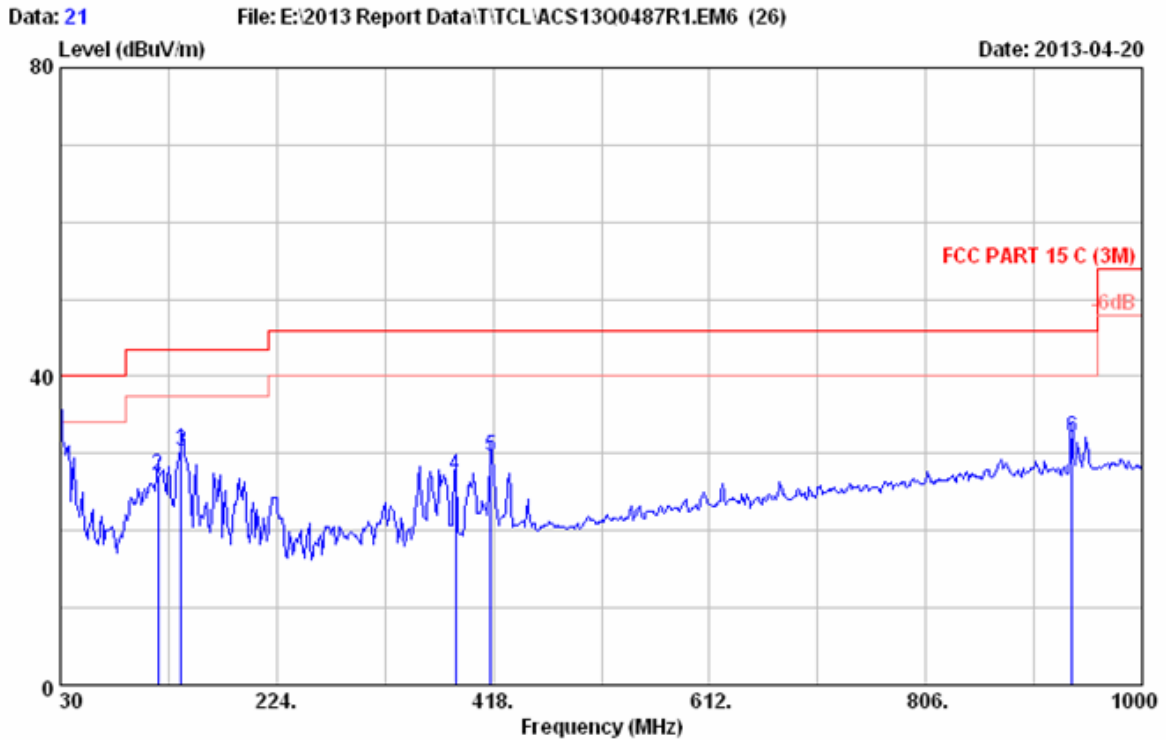

Site no. : 3m Chamber Data no. : 21  
 Dis. / Ant. : 3m 9168-429 Ant. pol. : HORIZONTAL  
 Limit : FCC PART 15 C (3M)  
 Env. / Ins. : 24°C/65% Engineer : Leo-Li  
 EUT : ACTIVE SUBWOOFER M/N:SA-WCT260H  
 Power rating : AC 120V/60Hz  
 Test Mode : Tx Mode

No.	Freq. (MHz)	Ant. Factor (dB/m)	Cable Loss (dB)	Reading (dBuV)	Emission Level (dBuV/m)	Limits (dBuV/m)	Margin (dB)	Remark
1	30.000	13.22	0.45	20.25	33.92	40.00	6.08	QP
2	117.300	11.94	0.88	14.33	27.15	43.50	16.35	QP
3	138.640	13.41	0.93	15.92	30.26	43.50	13.24	QP
4	384.050	14.47	1.52	11.27	27.26	46.00	18.74	QP
5	416.060	15.15	1.60	12.97	29.72	46.00	16.28	QP
6	936.950	22.05	2.85	7.30	32.20	46.00	13.80	QP

Remarks: 1. Emission Level= Antenna Factor + Cable Loss + Reading.  
 2. The emission levels that are 20dB below the official limit are not reported.

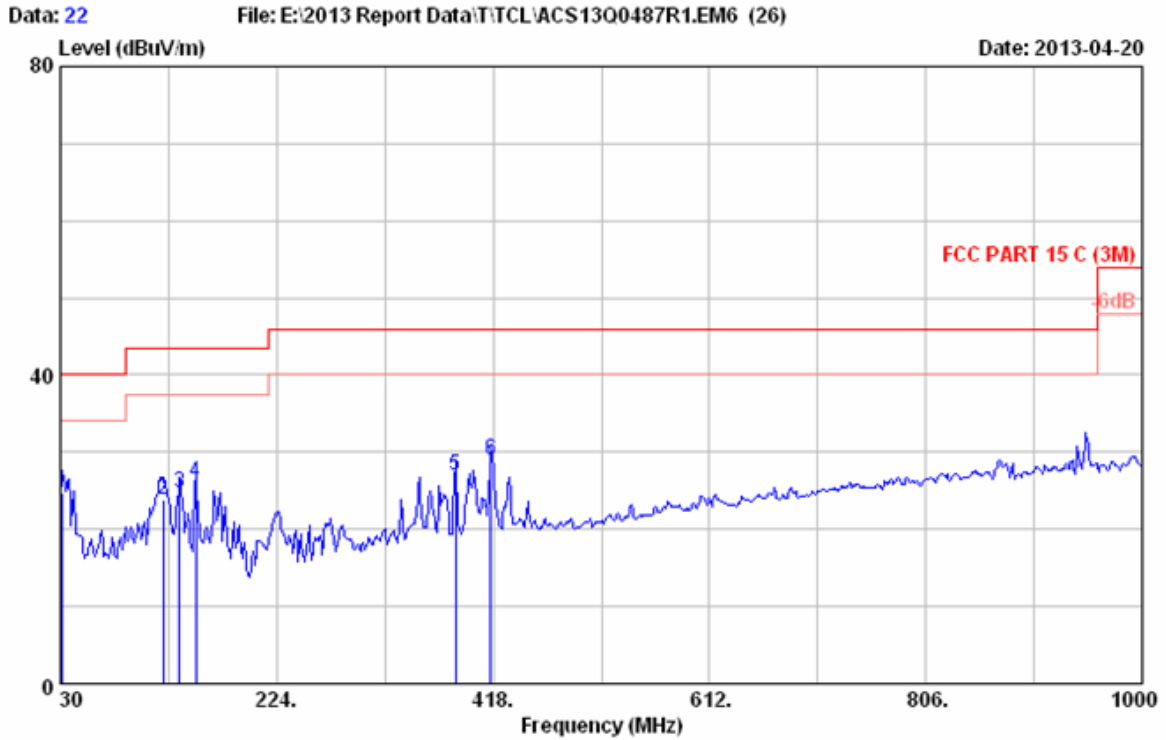

Site no. : 3m Chamber Data no. : 22  
 Dis. / Ant. : 3m 9168-429 Ant. pol. : VERTICAL  
 Limit : FCC PART 15 C (3M)  
 Env. / Ins. : 24°C/65% Engineer : Leo-Li  
 EUT : ACTIVE SUBWOOFER M/N:SA-WCT260H  
 Power rating : AC 120V/60Hz  
 Test Mode : Tx Mode

No.	Freq. (MHz)	Ant. Factor (dB/m)	Cable Loss (dB)	Reading (dBuV)	Emission Level (dBuV/m)	Limits (dBuV/m)	Margin (dB)	Remark
1	31.940	13.29	0.45	10.93	24.67	40.00	15.33	QP
2	122.150	12.36	0.90	10.56	23.82	43.50	19.68	QP
3	136.700	13.27	0.93	10.58	24.78	43.50	18.72	QP
4	151.250	14.16	0.96	10.93	26.05	43.50	17.45	QP
5	384.050	14.47	1.52	10.96	26.95	46.00	19.05	QP
6	416.060	15.15	1.60	12.13	28.88	46.00	17.12	QP

Remarks: 1. Emission Level= Antenna Factor + Cable Loss + Reading.  
 2. The emission levels that are 20dB below the official limit are not reported.

### Frequency: 1GHz~18GHz

Data: 1

File: G:\2013 report\T\TCL\ACS13Q0487R1 -2.EM6 (44)

Date: 2013-04-17

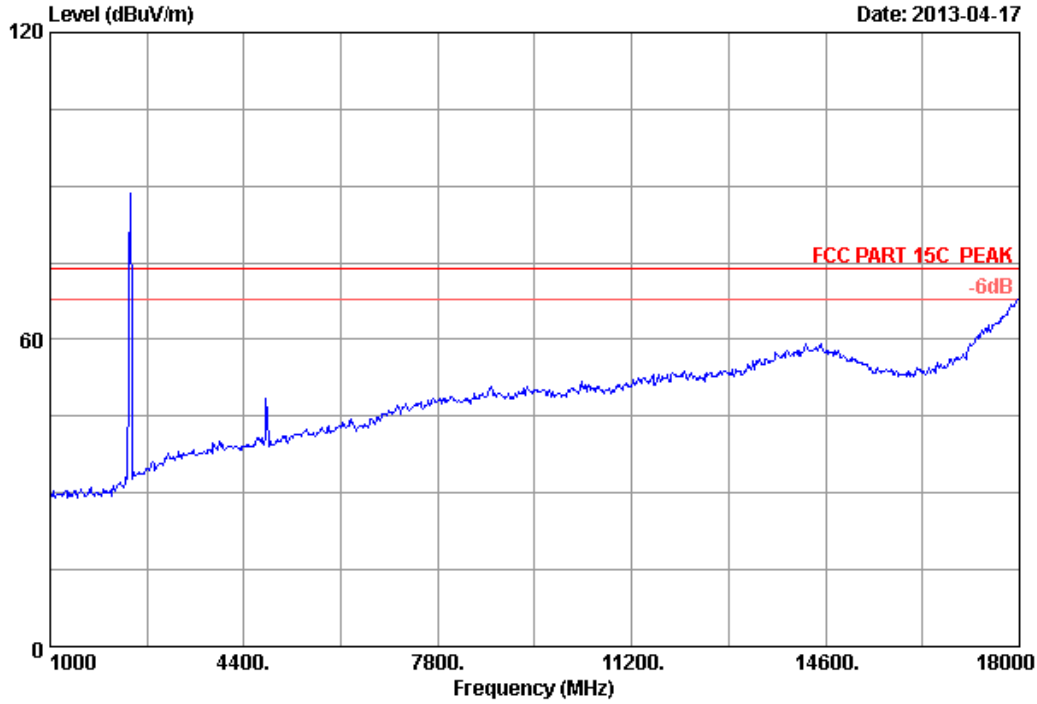

Site no. : 3m Chamber	Data no. : 1
Dis. / Ant. : 3m 2012 3115 (4580)	Ant. pol. : VERTICAL
Limit : FCC PART 15C PEAK	
Env. / Ins. : 23°C/54%	Engineer : Leo-Li
EUT : ACTIVE SUBWOOFER	
Power supply : AC 120V/60Hz	
Test mode : 2404MHz Tx	
M/N : SA-WCT260H	
:	

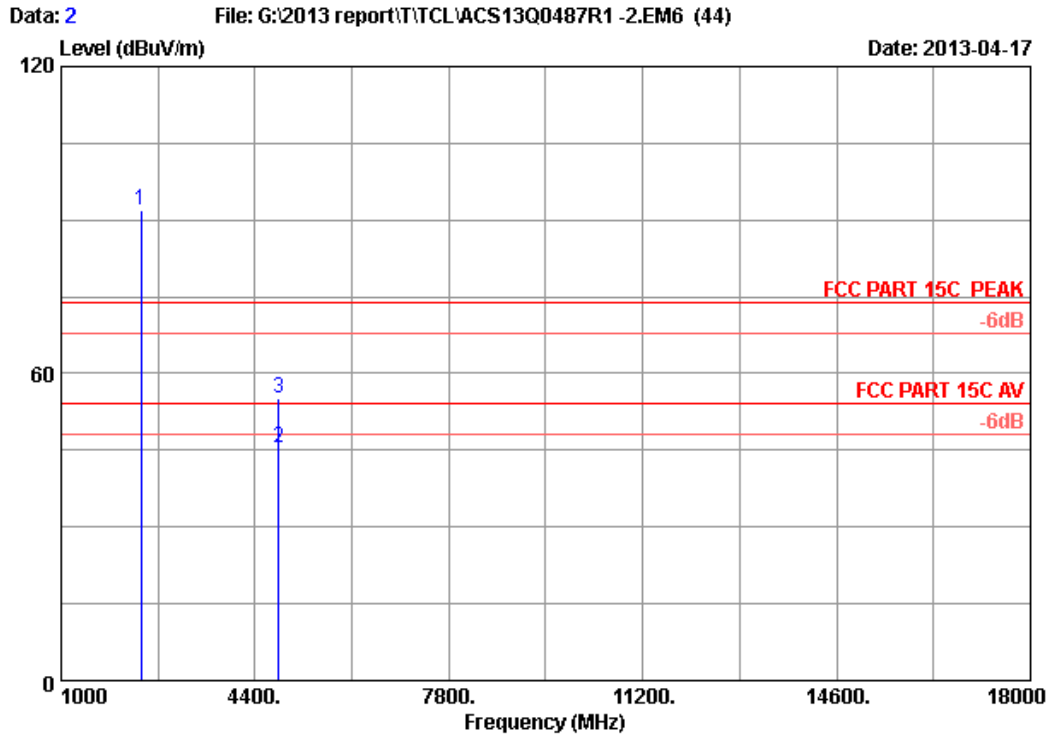

Site no. : 3m Chamber Data no. : 2  
 Dis. / Ant. : 3m 2012 3115 (4580) Ant. pol. : VERTICAL  
 Limit : FCC PART 15C PEAK  
 Env. / Ins. : 23°C/54% Engineer : Leo-Li  
 EUT : ACTIVE SUBWOOFER  
 Power supply : AC 120V/60Hz  
 Test mode : 2404MHz Tx  
 M/N : SA-WCT260H  
 :

	Freq. (MHz)	Ant. Factor (dB/m)	Cable loss (dB)	Amp. Factor (dB)	Reading (dBUV)	Emission Level (dBUV/m)	Limits (dBUV/m)	Margin (dB)	Remark
1	2404.000	26.79	6.02	35.92	95.18	92.07	74.00	-18.07	Peak
2	4808.000	32.48	8.67	35.72	40.05	45.48	54.00	8.52	Average
3	4808.000	32.48	8.67	35.72	49.77	55.20	74.00	18.80	Peak

Remarks:

1. Emission Level= Antenna Factor + Cable Loss -Amp Factor + Reading.
2. The emission levels that are 20dB below the official limit are not reported.

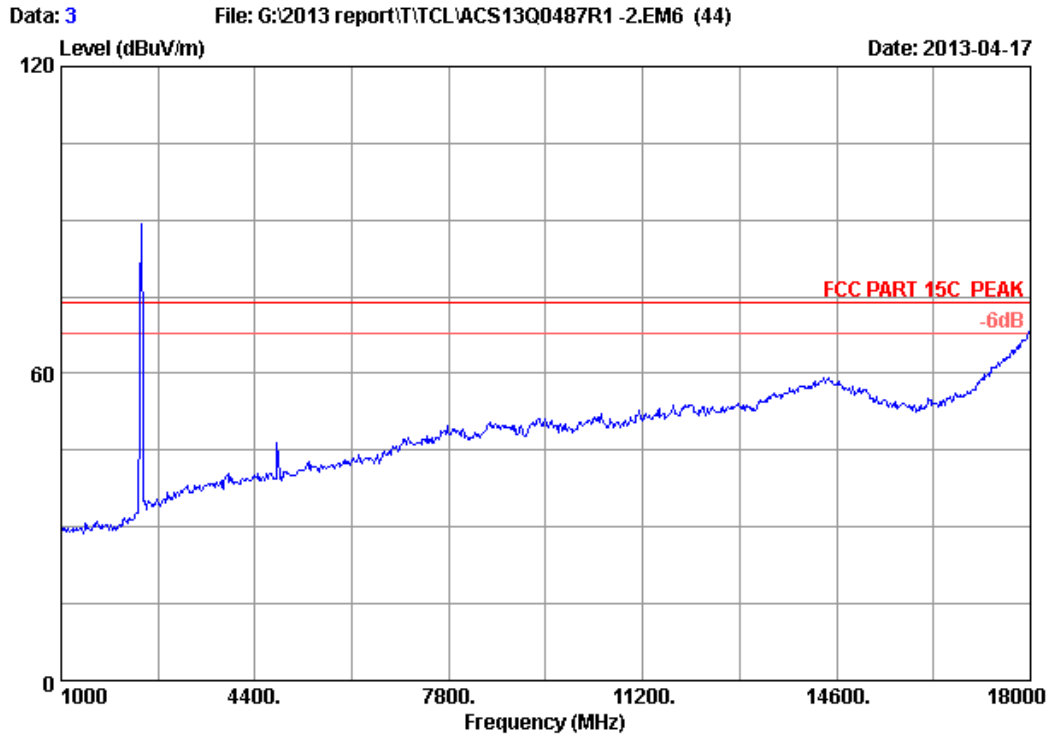

Site no. : 3m Chamber Data no. : 3  
Dis. / Ant. : 3m 2012 3115 (4580) Ant. pol. : HORIZONTAL  
Limit : FCC PART 15C PEAK  
Env. / Ins. : 23°C/54% Engineer : Leo-Li  
EUT : ACTIVE SUBWOOFER  
Power supply : AC 120V/60Hz  
Test mode : 2404MHz Tx  
M/N : SA-WCT260H  
:

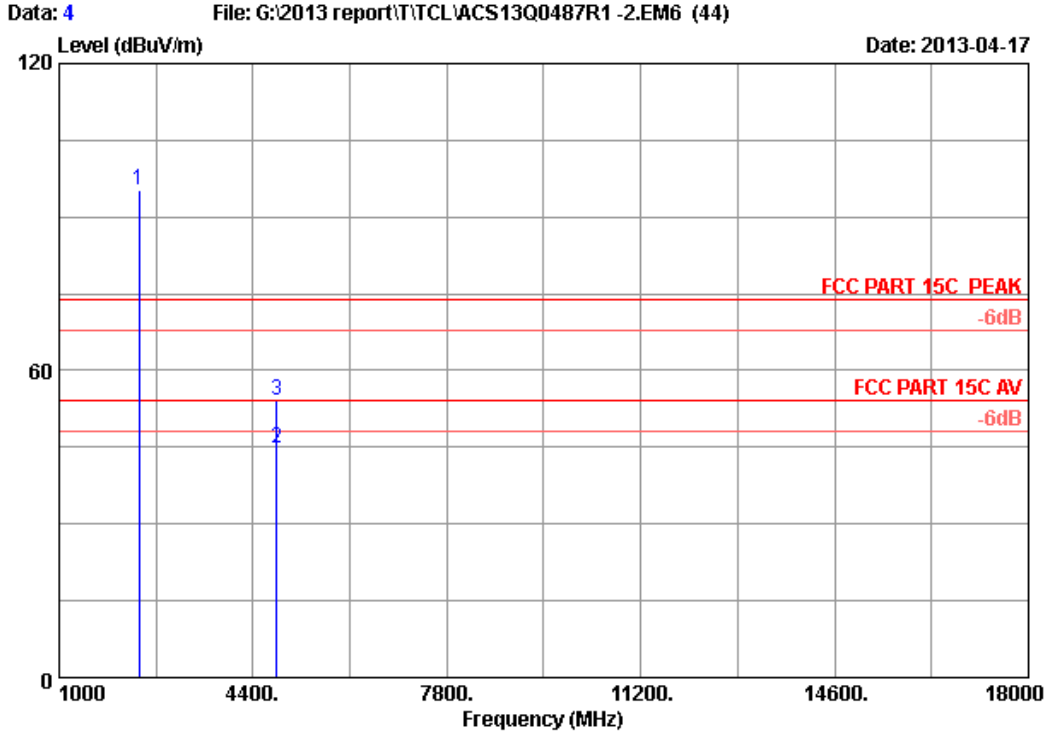

Site no. : 3m Chamber Data no. : 4  
 Dis. / Ant. : 3m 2012 3115 (4580) Ant. pol. : HORIZONTAL  
 Limit : FCC PART 15C PEAK  
 Env. / Ins. : 23°C/54% Engineer : Leo-Li  
 EUT : ACTIVE SUBWOOFER  
 Power supply : AC 120V/60Hz  
 Test mode : 2404MHz Tx  
 M/N : SA-WCT260H  
 :

	Freq. (MHz)	Ant. Factor (dB/m)	Cable loss (dB)	Amp. Factor (dB)	Reading (dBUV)	Emission Level (dBUV/m)	Limits (dBUV/m)	Margin (dB)	Remark
1	2404.000	26.79	6.02	35.92	98.37	95.26	74.00	-21.26	Peak
2	4808.000	32.48	8.67	35.72	39.24	44.67	54.00	9.33	Average
3	4808.000	32.48	8.67	35.72	48.87	54.30	74.00	19.70	Peak

Remarks:  
 1. Emission Level= Antenna Factor + Cable Loss -Amp Factor + Reading.  
 2. The emission levels that are 20dB below the official limit are not reported.

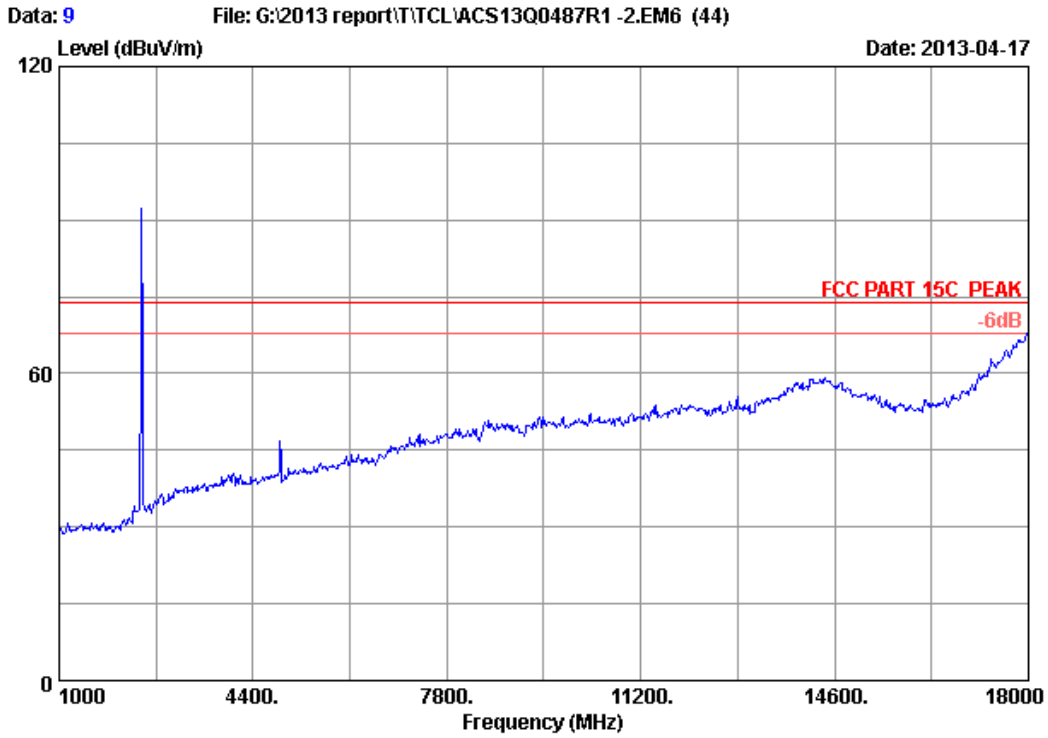

Site no. :	3m Chamber	Data no. :	9
Dis. / Ant. :	3m 2012 3115 (4580)	Ant. pol. :	HORIZONTAL
Limit :	FCC PART 15C PEAK	Engineer :	Leo-Li
Env. / Ins. :	23°C/54%		
EUT :	ACTIVE SUBWOOFER		
Power supply :	AC 120V/60Hz		
Test mode :	2440MHz Tx		
M/N :	SA-WCT260H		
:			

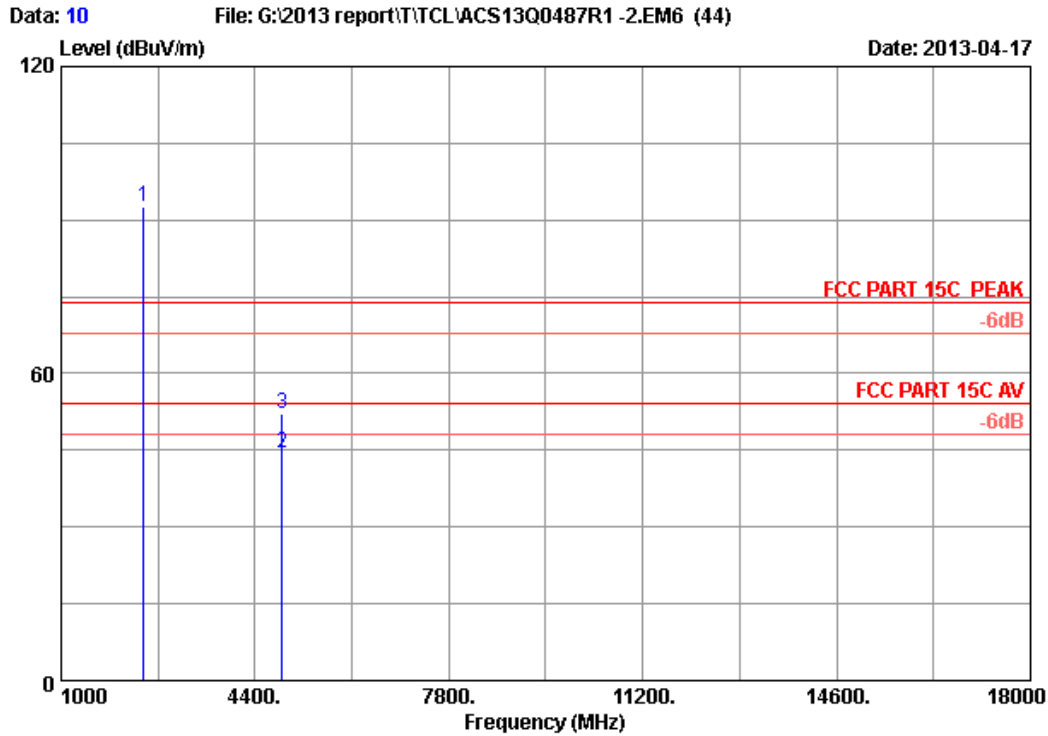

Site no. : 3m Chamber Data no. : 10  
 Dis. / Ant. : 3m 2012 3115 (4580) Ant. pol. : HORIZONTAL  
 Limit : FCC PART 15C PEAK  
 Env. / Ins. : 23°C/54% Engineer : Leo-Li  
 EUT : ACTIVE SUBWOOFER  
 Power supply : AC 120V/60Hz  
 Test mode : 2440MHz Tx  
 M/N : SA-WCT260H  
 :

	Freq. (MHz)	Ant. Factor (dB/m)	Cable loss (dB)	Amp. Factor (dB)	Reading (dBUV)	Emission Level (dBUV/m)	Limits (dBUV/m)	Margin (dB)	Remark
1	2440.000	27.02	6.09	35.92	95.47	92.66	74.00	-18.66	Peak
2	4880.000	32.64	8.74	35.69	38.68	44.37	54.00	9.63	Average
3	4880.000	32.64	8.74	35.69	46.32	52.01	74.00	21.99	Peak

Remarks:

1. Emission Level= Antenna Factor + Cable Loss -Amp Factor + Reading.
2. The emission levels that are 20dB below the official limit are not reported.



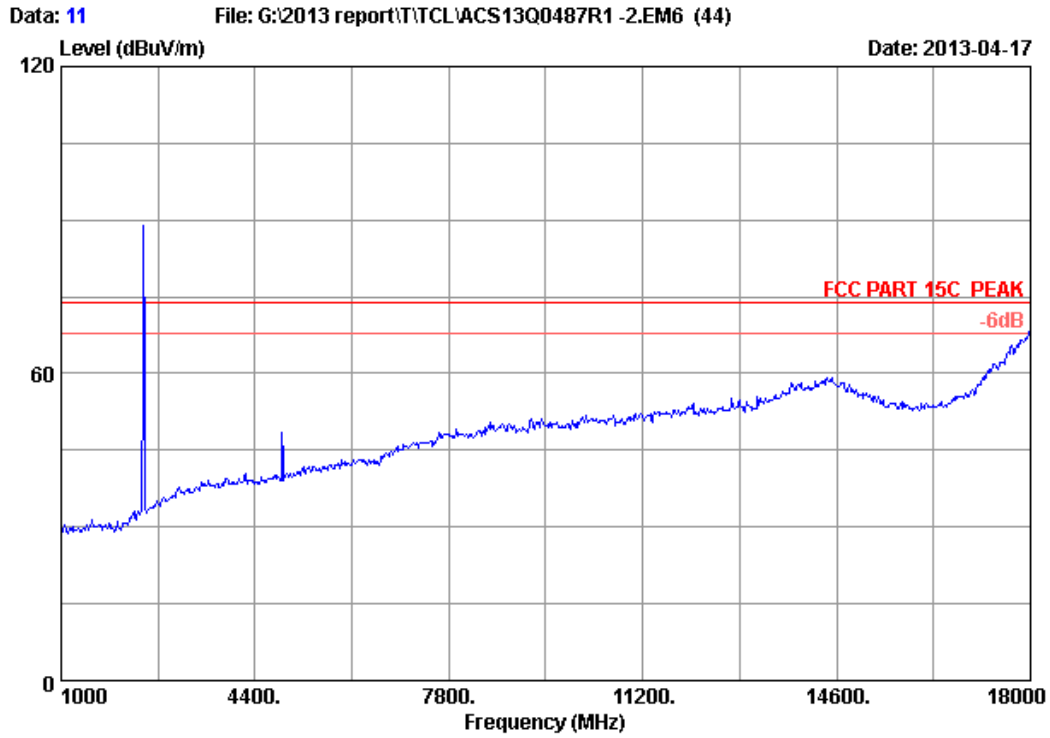

Site no. : 3m Chamber	Data no. : 11
Dis. / Ant. : 3m 2012 3115 (4580)	Ant. pol. : VERTICAL
Limit : FCC PART 15C PEAK	
Env. / Ins. : 23°C/54%	Engineer : Leo-Li
EUT : ACTIVE SUBWOOFER	
Power supply : AC 120V/60Hz	
Test mode : 2440MHz Tx	
M/N : SA-WCT260H	
:	

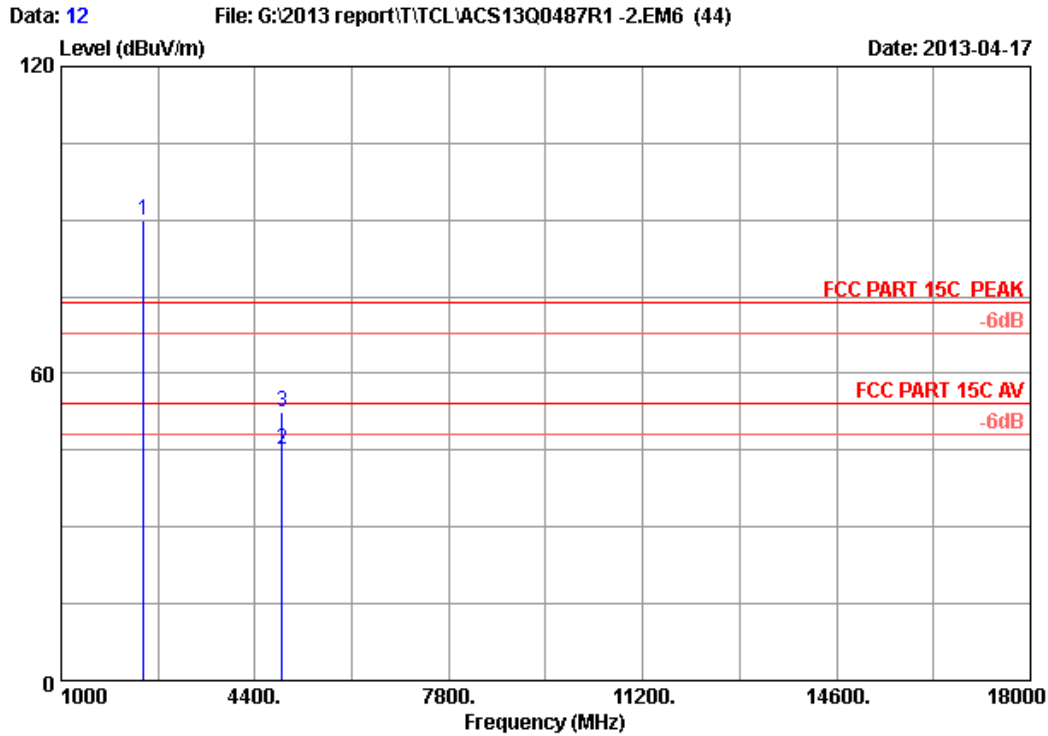

Site no. : 3m Chamber Data no. : 12  
 Dis. / Ant. : 3m 2012 3115 (4580) Ant. pol. : VERTICAL  
 Limit : FCC PART 15C PEAK  
 Env. / Ins. : 23°C/54% Engineer : Leo-Li  
 EUT : ACTIVE SUBWOOFER  
 Power supply : AC 120V/60Hz  
 Test mode : 2440MHz Tx  
 M/N : SA-WCT260H  
 :

	Freq. (MHz)	Ant. Factor (dB/m)	Cable loss (dB)	Amp. Factor (dB)	Reading (dBUV)	Emission Level (dBUV/m)	Limits (dBUV/m)	Margin (dB)	Remark
1	2440.000	27.02	6.09	35.92	92.70	89.89	74.00	-15.89	Peak
2	4880.000	32.64	8.74	35.69	39.53	45.22	54.00	8.78	Average
3	4880.000	32.64	8.74	35.69	46.87	52.56	74.00	21.44	Peak

Remarks:  
 1. Emission Level= Antenna Factor + Cable Loss -Amp Factor + Reading.  
 2. The emission levels that are 20dB below the official limit are not reported.

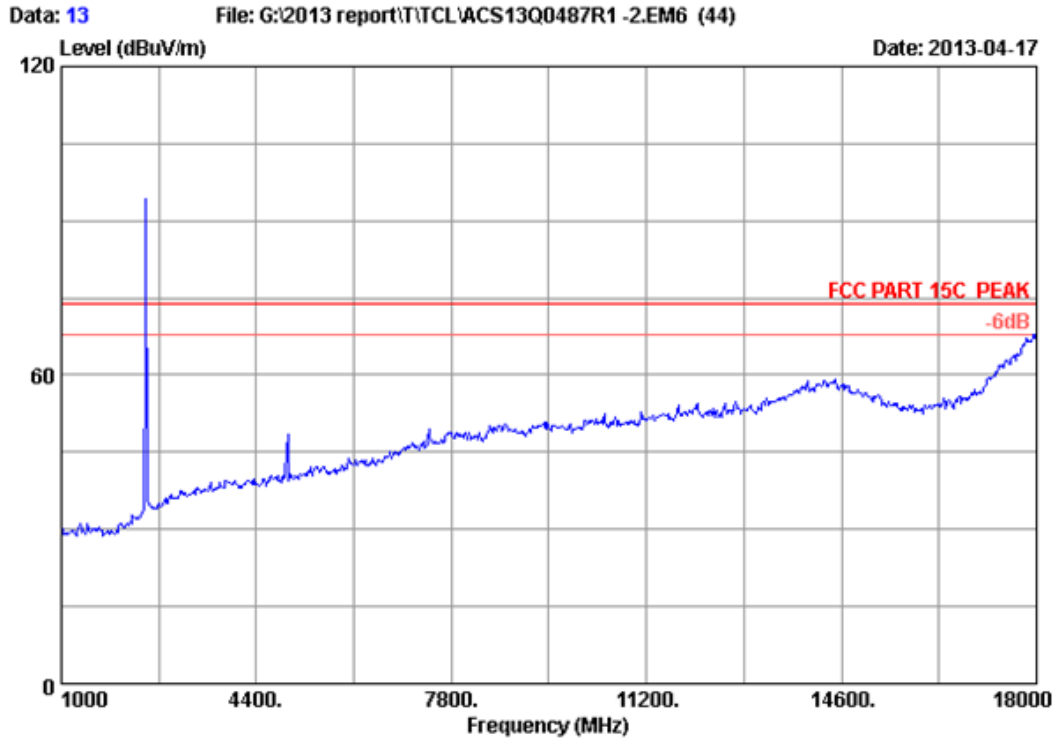

Site no.	: 3m Chamber	Data no.	: 13
Dis. / Ant.	: 3m 2012 3115 (4580)	Ant. pol.	: HORIZONTAL
Limit	: FCC PART 15C PEAK	Engineer	: Leo-Li
Env. / Ins.	: 23°C/54%		
EUT	: ACTIVE SUBWOOFER		
Power supply	: AC 120V/60Hz		
Test mode	: 2476MHz Tx		
M/N	: SA-WCT260H		
	:		

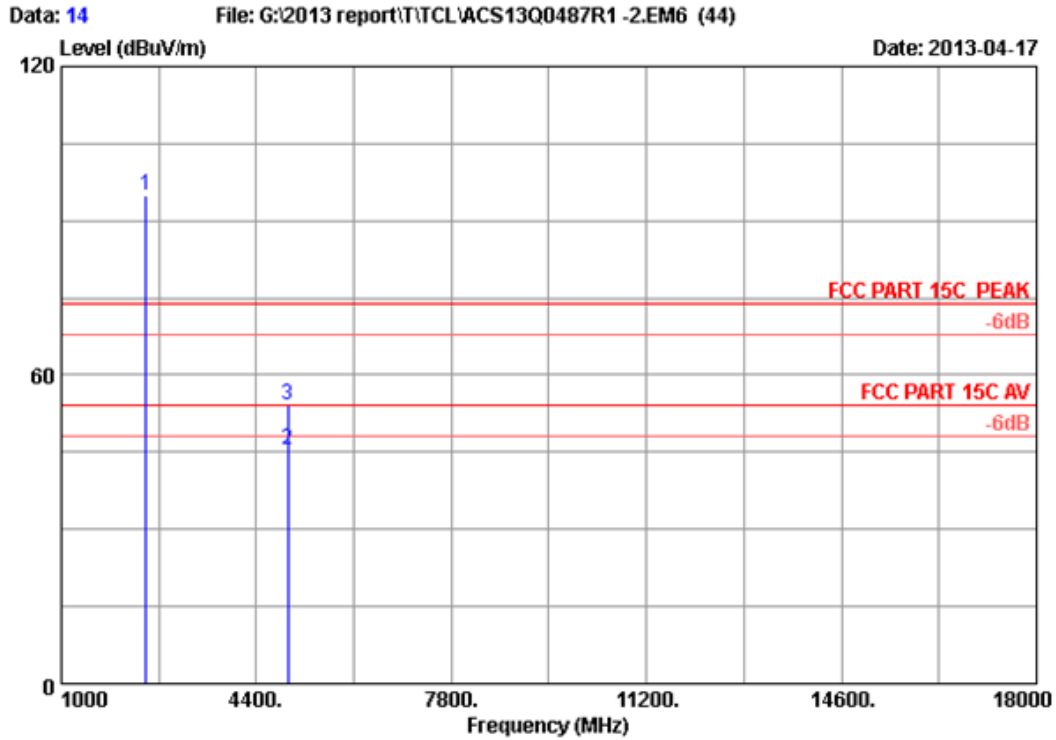

Site no. : 3m Chamber Data no. : 14  
 Dis. / Ant. : 3m 2012 3115 (4580) Ant. pol. : HORIZONTAL  
 Limit : FCC PART 15C PEAK  
 Env. / Ins. : 23°C/54% Engineer : Leo-Li  
 EUT : ACTIVE SUBWOOFER  
 Power supply : AC 120V/60Hz  
 Test mode : 2476MHz Tx  
 M/N : SA-WCT260H  
 :

	Freq. (MHz)	Ant. Factor (dB/m)	Cable loss (dB)	Amp. Factor (dB)	Reading (dBUV)	Emission Level (dBUV/m)	Limits (dBUV/m)	Margin (dB)	Remark
1	2476.000	27.25	6.15	35.92	97.44	94.92	74.00	-20.92	Peak
2	4952.000	32.79	8.80	35.67	39.40	45.32	54.00	8.68	Average
3	4952.000	32.79	8.80	35.67	48.13	54.05	74.00	19.95	Peak

Remarks:

1. Emission Level= Antenna Factor + Cable Loss -Amp Factor + Reading.
2. The emission levels that are 20dB below the official limit are not reported.

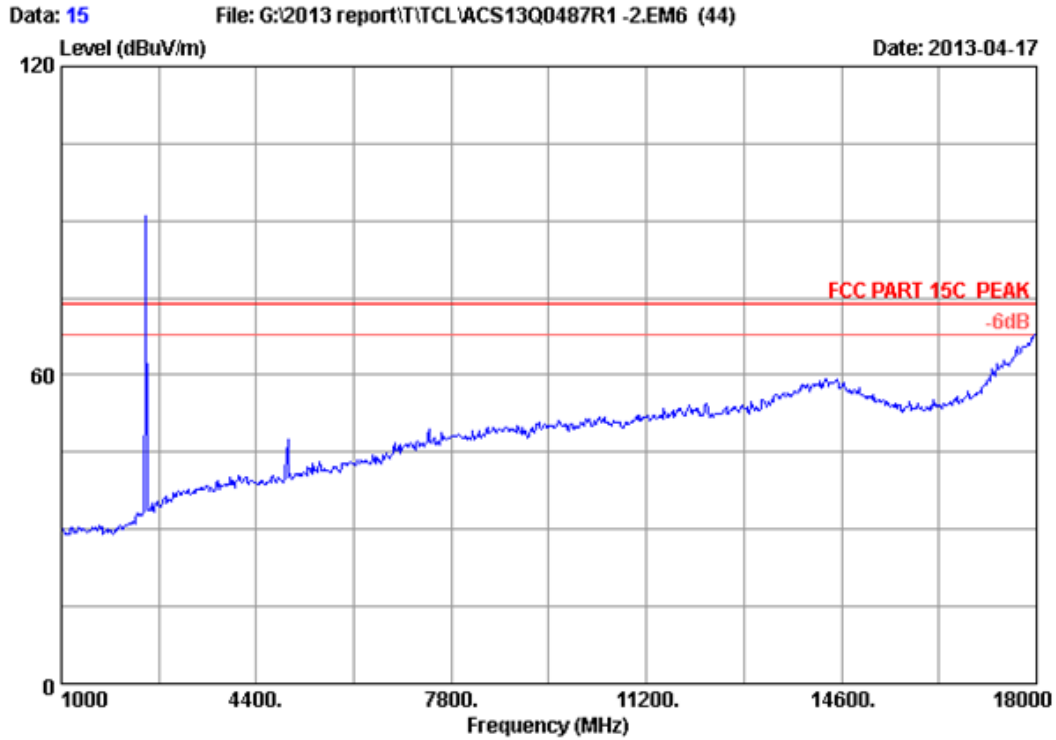

Site no.	: 3m Chamber	Data no.	: 15
Dis. / Ant.	: 3m 2012 3115 (4580)	Ant. pol.	: VERTICAL
Limit	: FCC PART 15C PEAK	Engineer	: Leo-Li
Env. / Ins.	: 23°C/54%		
EUT	: ACTIVE SUBWOOFER		
Power supply	: AC 120V/60Hz		
Test mode	: 2476MHz Tx		
M/N	: SA-WCT260H		
	:		

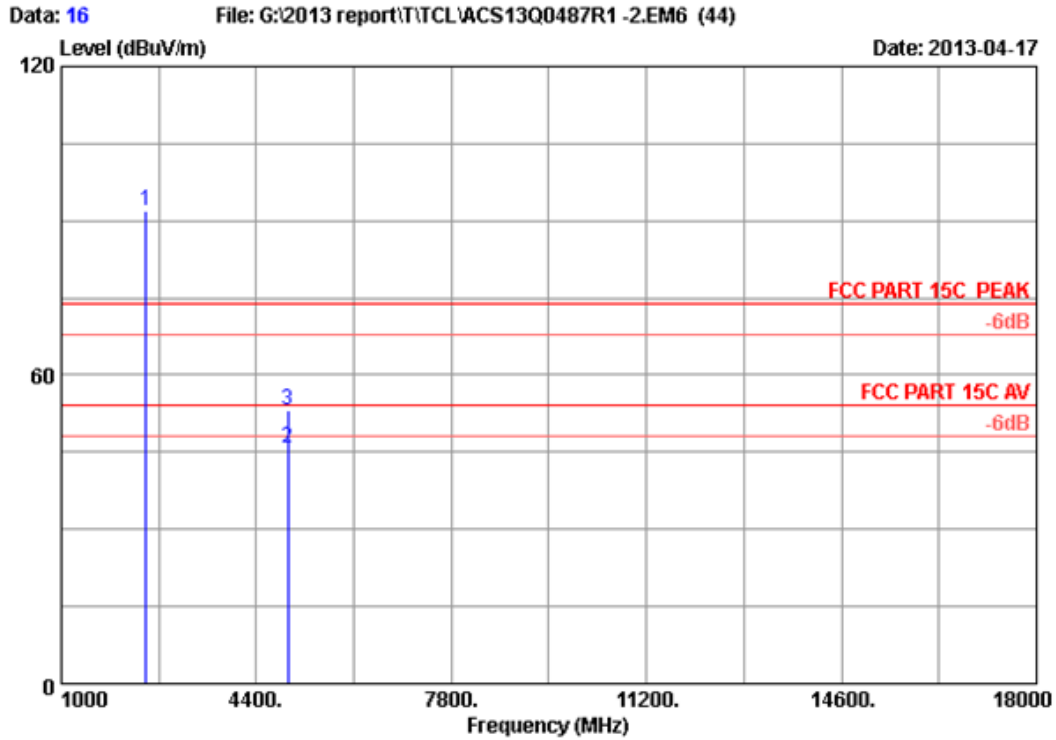

Site no. : 3m Chamber Data no. : 16  
 Dis. / Ant. : 3m 2012 3115 (4580) Ant. pol. : VERTICAL  
 Limit : FCC PART 15C PEAK  
 Env. / Ins. : 23°C/54% Engineer : Leo-Li  
 EUT : ACTIVE SUBWOOFER  
 Power supply : AC 120V/60Hz  
 Test mode : 2476MHz Tx  
 M/N : SA-WCT260H  
 :

	Freq. (MHz)	Ant. Factor (dB/m)	Cable loss (dB)	Amp. Factor (dB)	Reading (dBUV)	Emission Level (dBUV/m)	Limits (dBUV/m)	Margin (dB)	Remark
1	2476.000	27.25	6.15	35.92	94.34	91.82	74.00	-17.82	Peak
2	4952.000	32.79	8.80	35.67	39.73	45.65	54.00	8.35	Average
3	4952.000	32.79	8.80	35.67	47.33	53.25	74.00	20.75	Peak

Remarks:

1. Emission Level= Antenna Factor + Cable Loss -Amp Factor + Reading.
2. The emission levels that are 20dB below the official limit are not reported.

## 5. CONDUCTED SPURIOUS EMISSIONS

### 5.1. Test Equipment

Item	Equipment	Manufacturer	Model No.	Serial No.	Last Cal.	Cal. Interval
1.	Spectrum Analyzer	Agilent	E4446A	US44300459	May.08,12	1 Year
2.	Attenuator	Agilent	8491B	MY39262165	May.08,12	1 Year
3.	RF Cable	Hubersuhner	SUCOFLEX102	28618/2	May.08,12	1 Year

### 5.2. Limit

In any 100kHz bandwidth outside the frequency bands in which the spread spectrum intentional radiator is operating, the radio frequency power that is produced by the intentional radiator shall be at least 20dB below that in the 100kHz bandwidth within the band that contains the highest level of the desired power.

### 5.3. Test Procedure

The transmitter output was connected to a spectrum analyzer, The resolution bandwidth is set to 100 kHz, The video bandwidth is set to 300 kHz and measure all the emissions detected.

### 5.4. Test result

**PASS** (The testing data was attached in the next pages.)

**GFSK**  
2404MHz

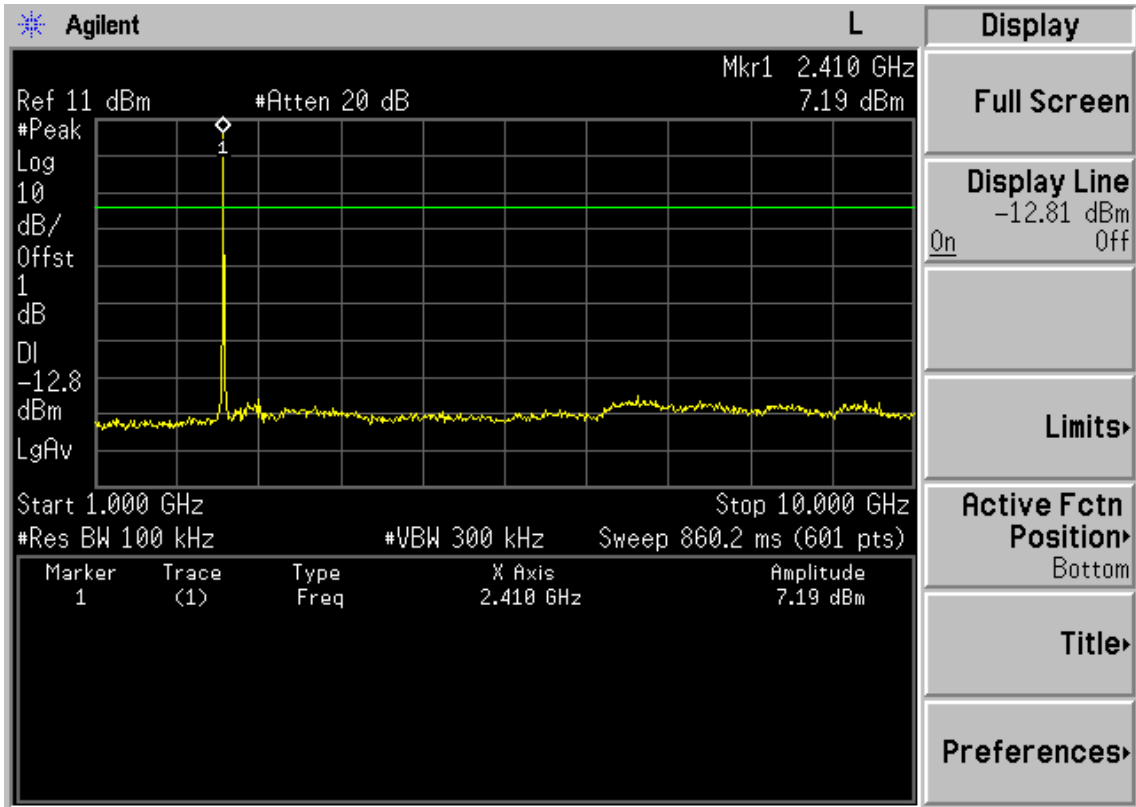

Copyright 2000-2005 Agilent Technologies

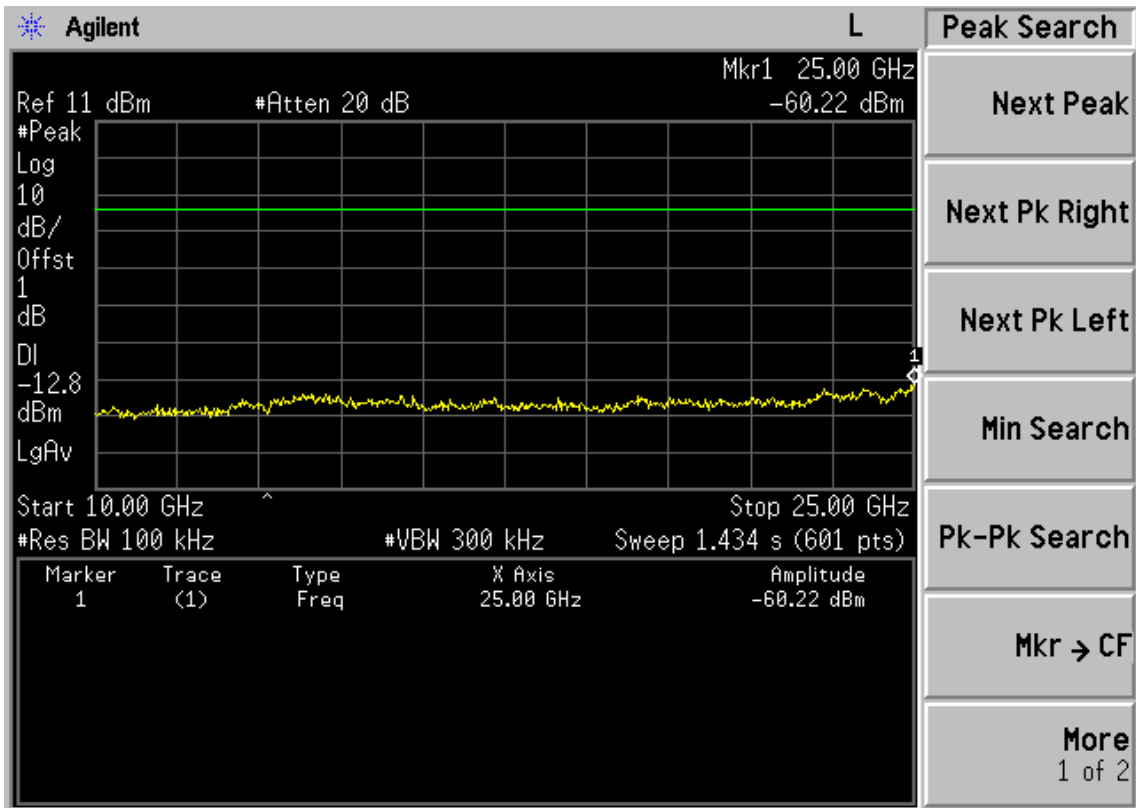

Copyright 2000-2005 Agilent Technologies



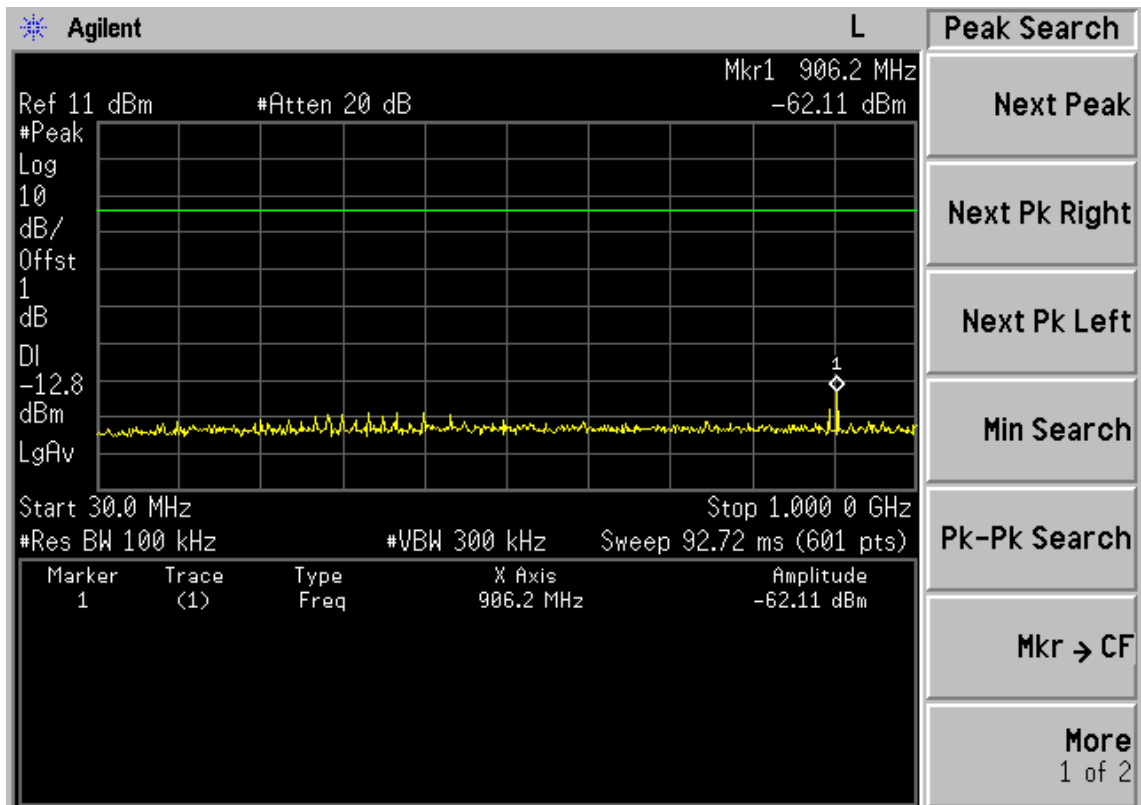

Copyright 2000-2005 Agilent Technologies

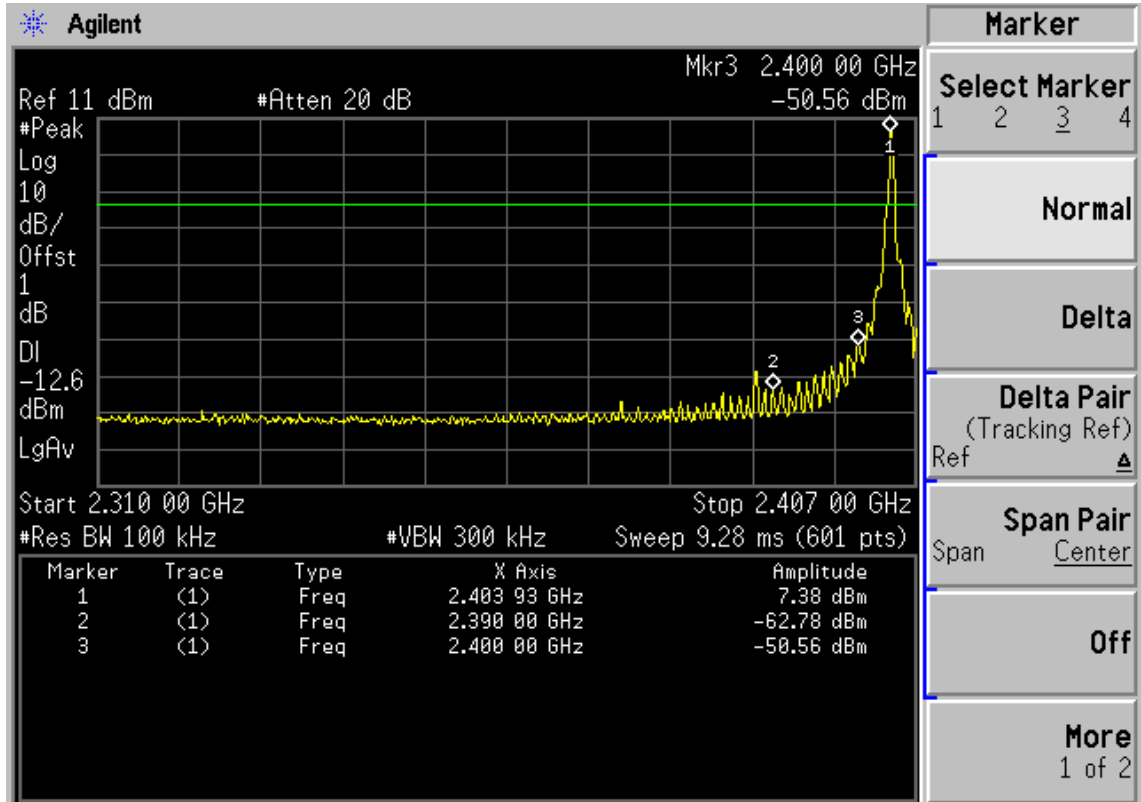

Copyright 2000-2005 Agilent Technologies

2440MHz

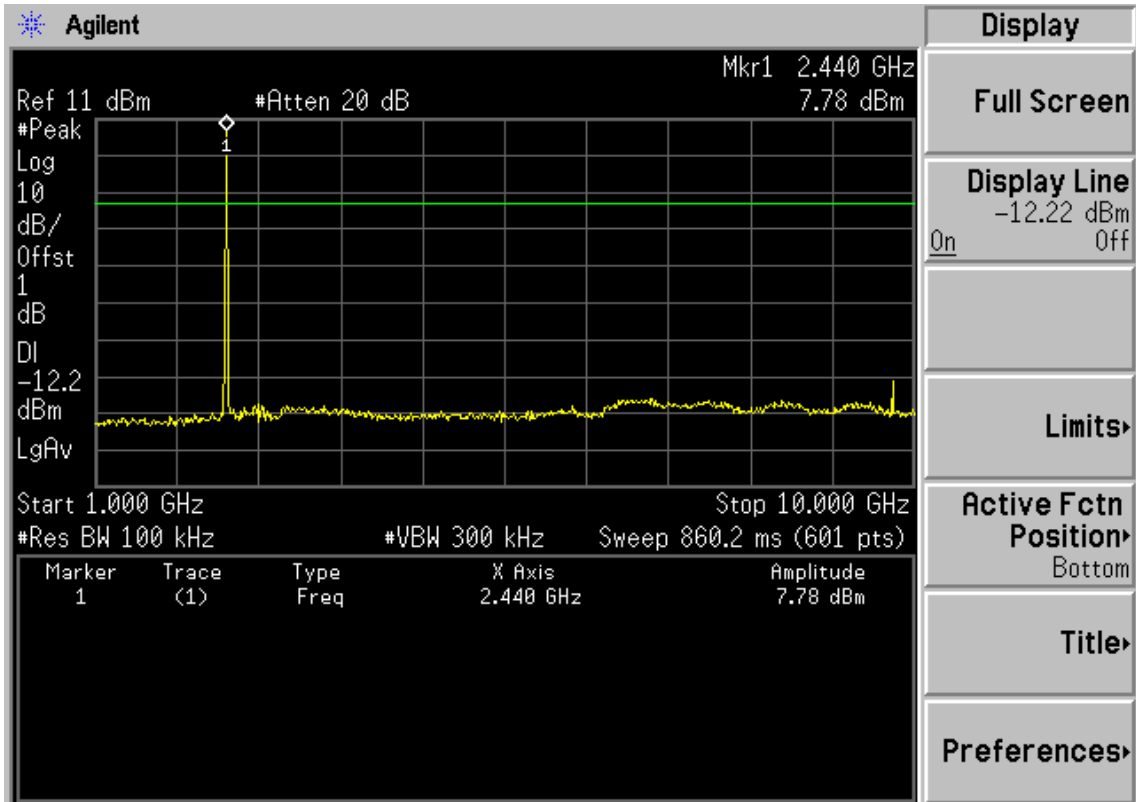

Copyright 2000-2005 Agilent Technologies

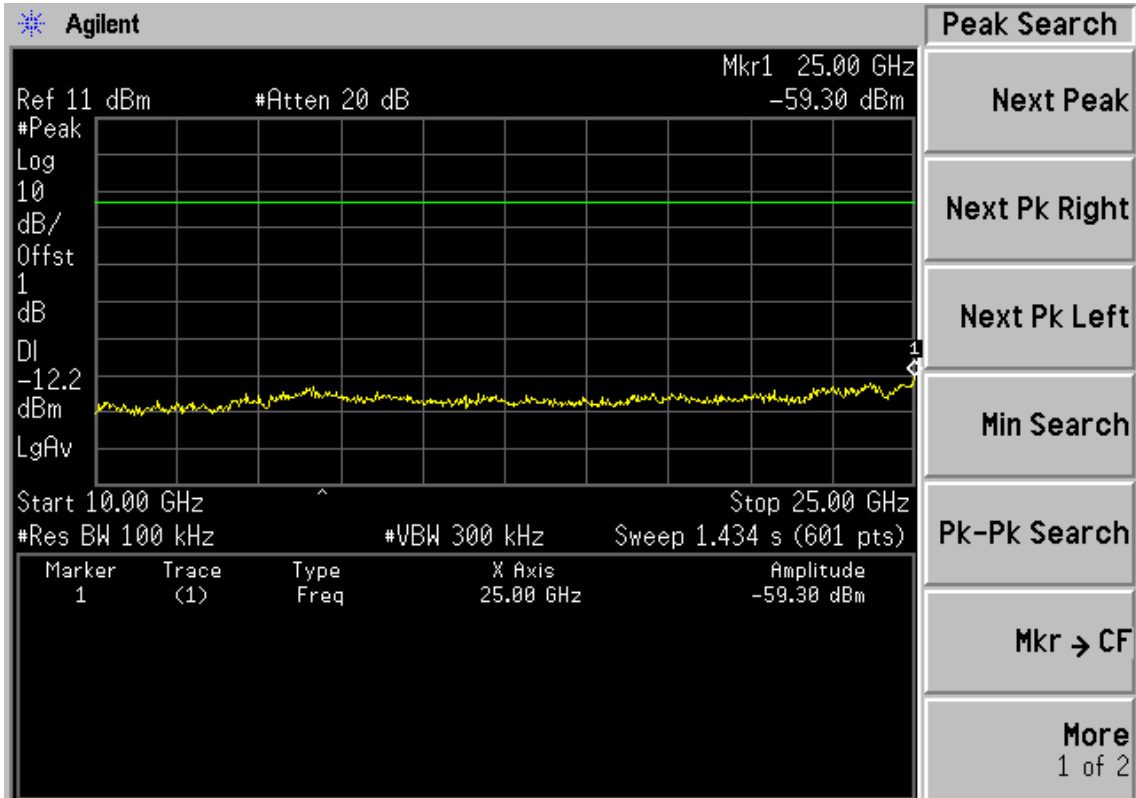

Copyright 2000-2005 Agilent Technologies

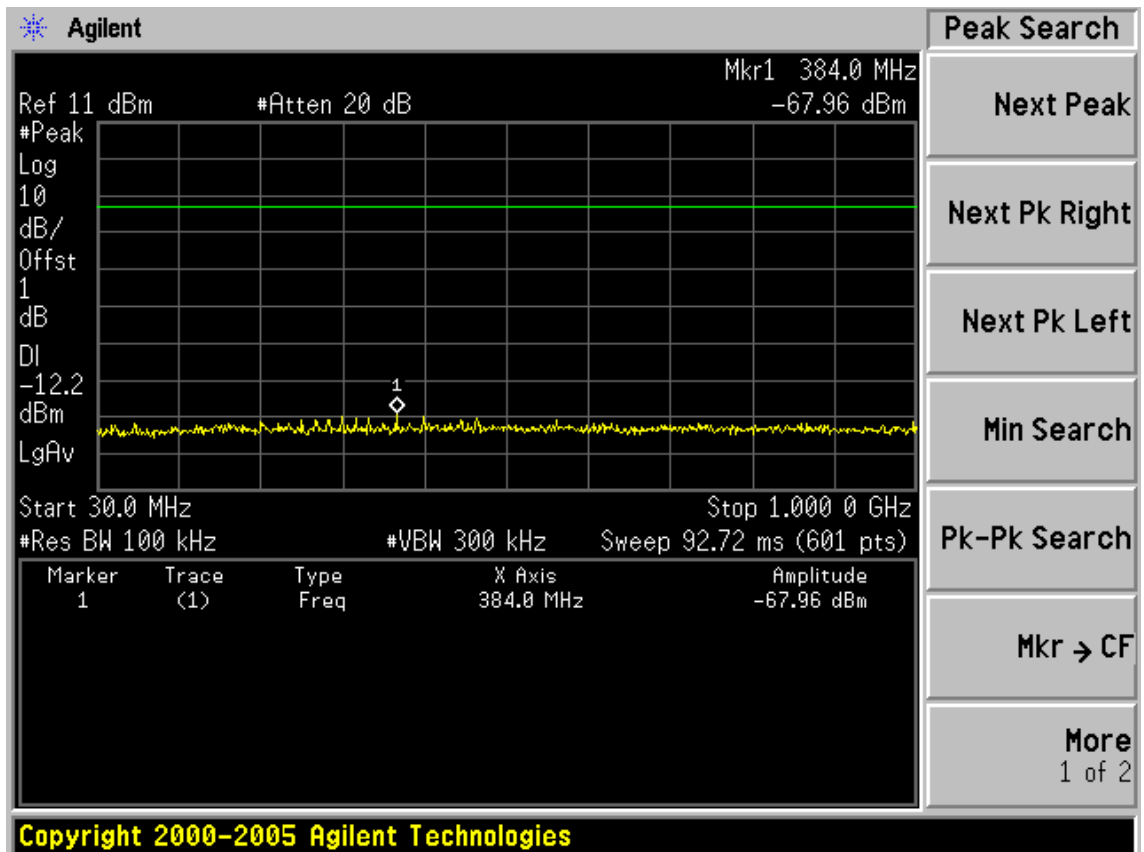

2476MHz

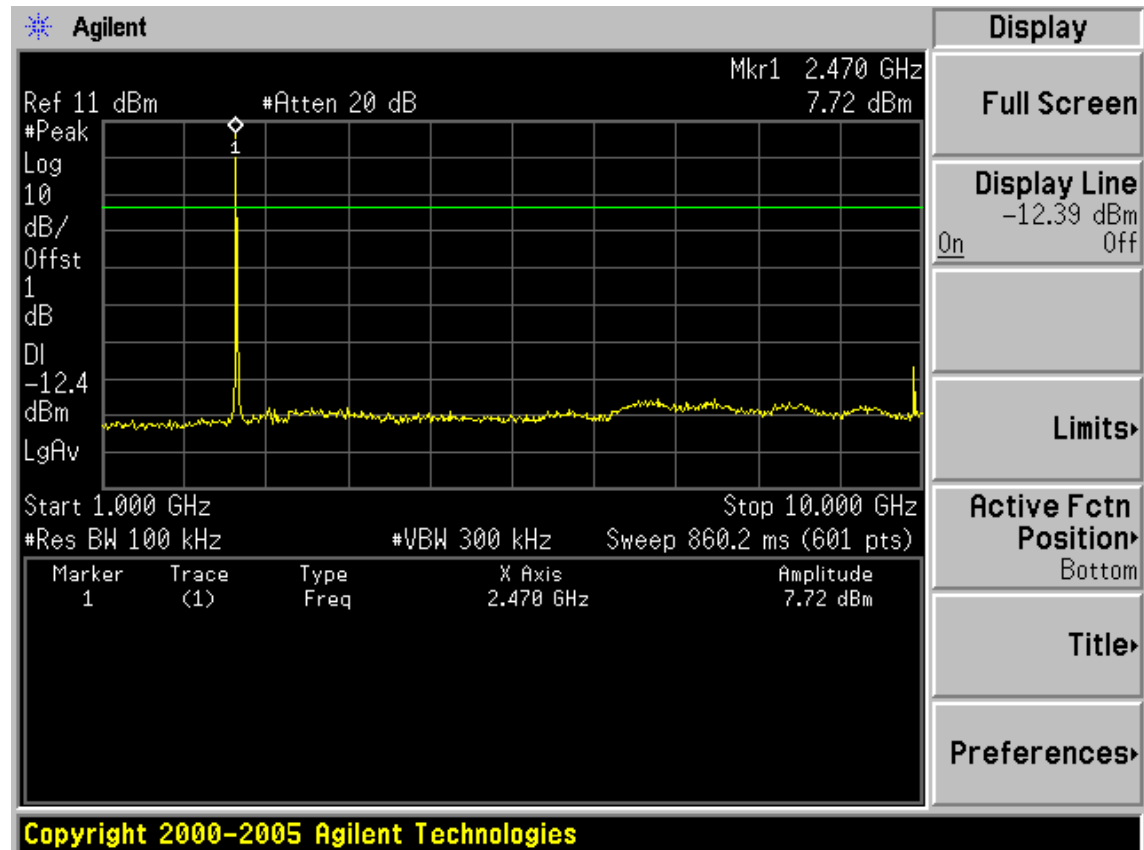

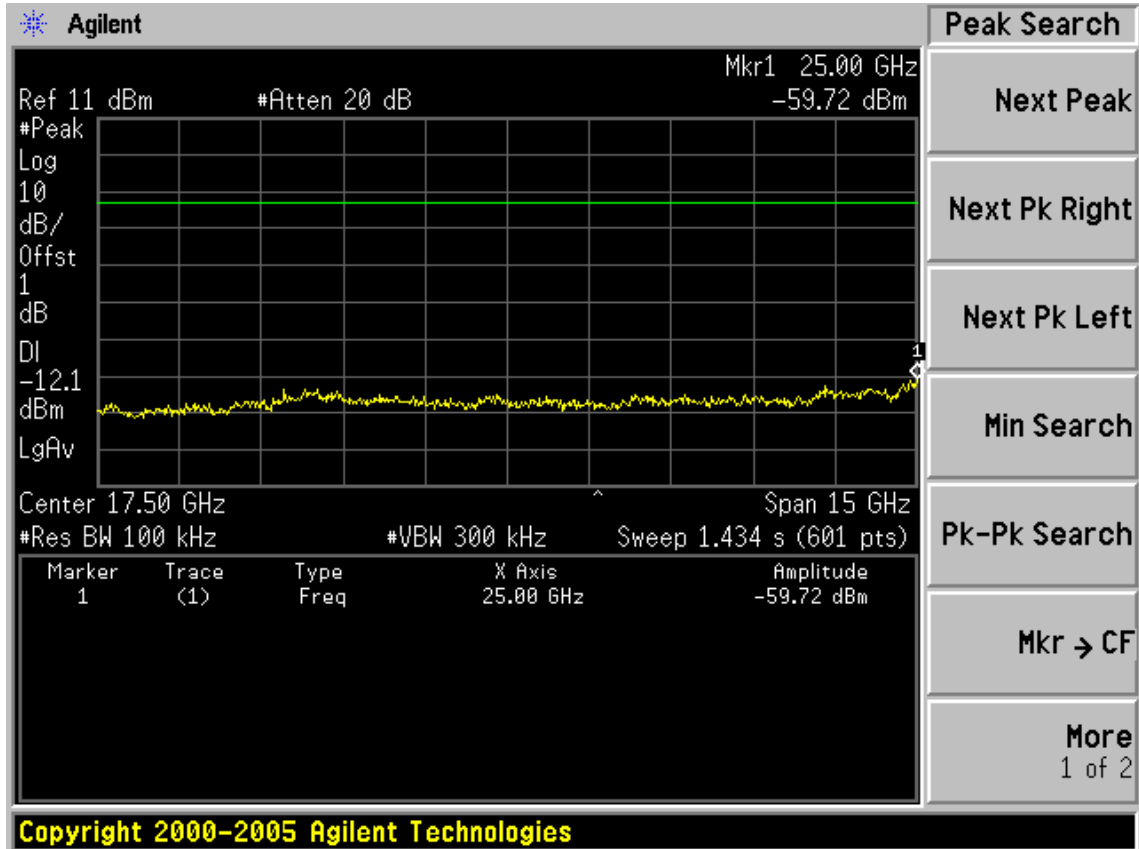
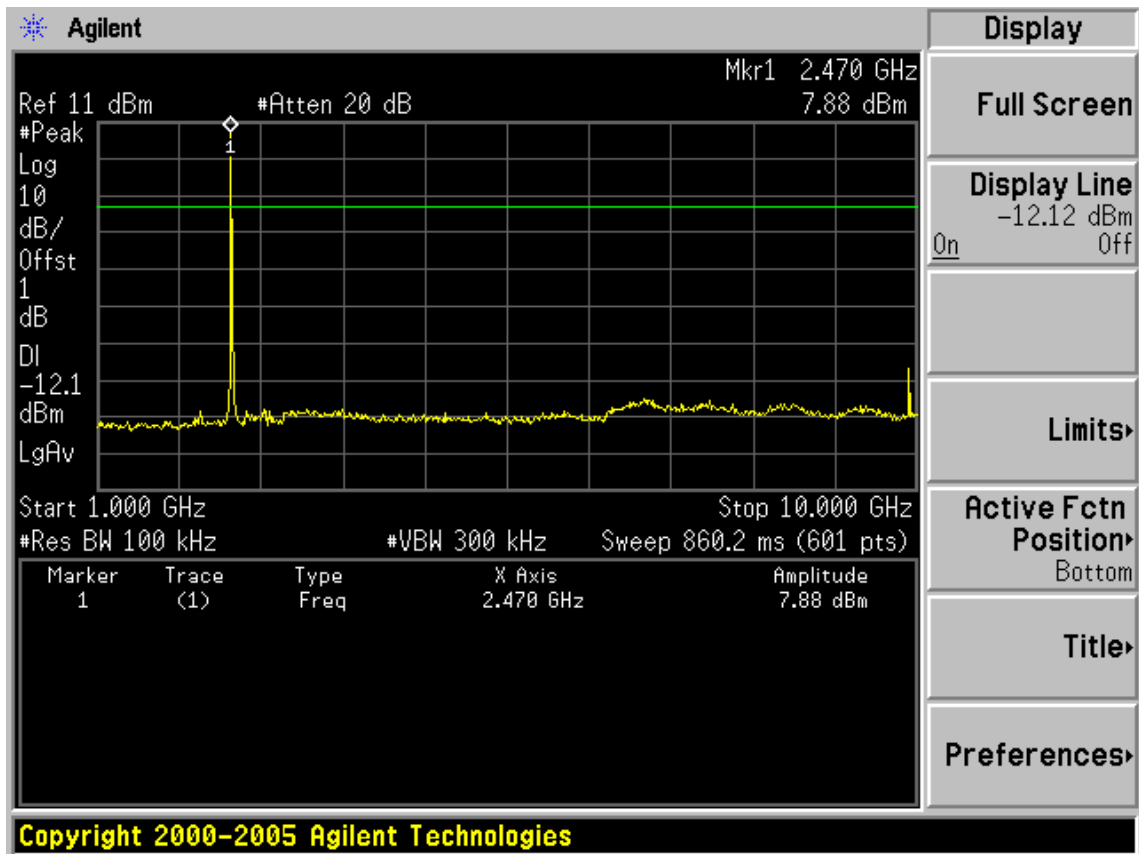

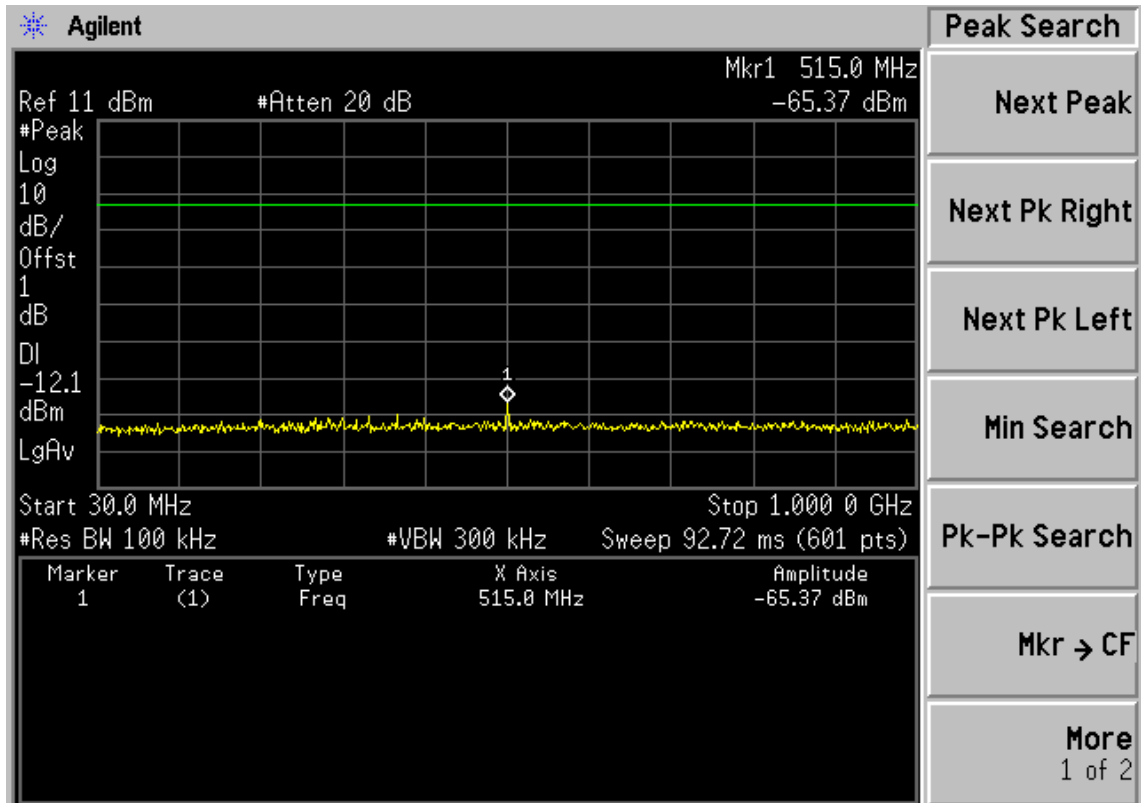

Copyright 2000-2005 Agilent Technologies

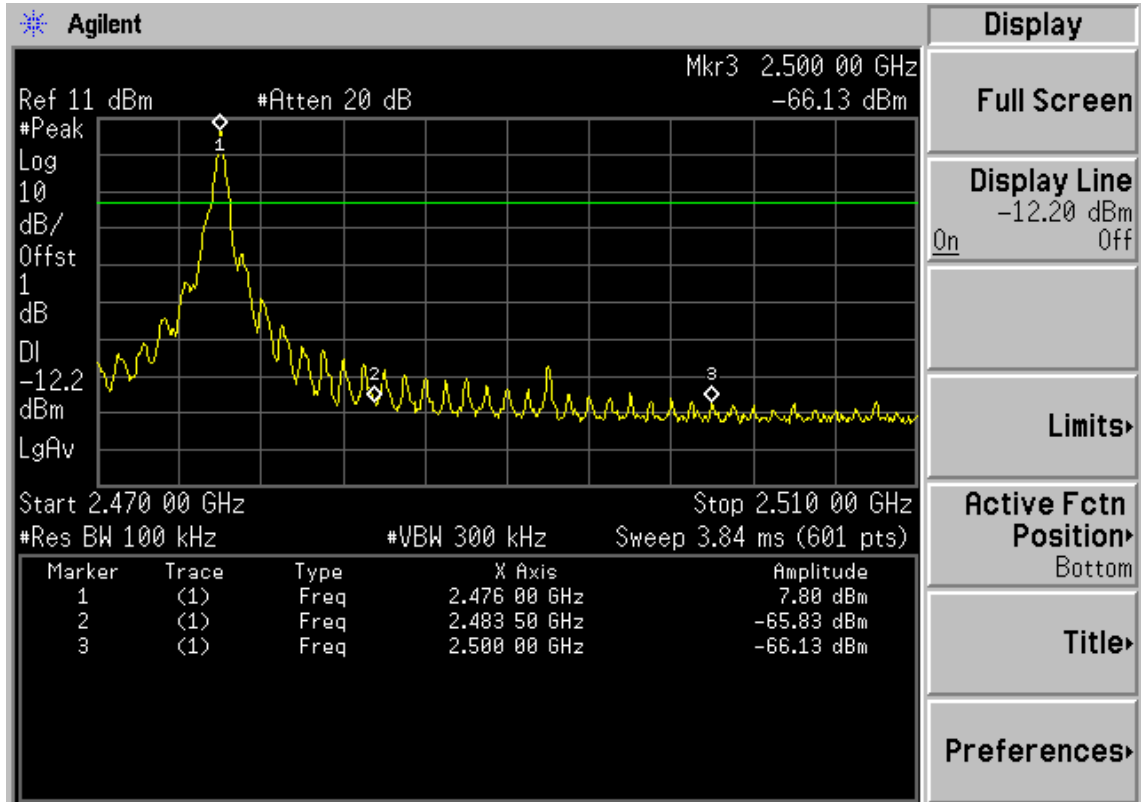

Copyright 2000-2005 Agilent Technologies

## 6. 6DB BANDWIDTH TEST

### 6.1. Test Equipment

Item	Equipment	Manufacturer	Model No.	Serial No.	Last Cal.	Cal. Interval
1.	Spectrum	Agilent	N9030A	MY51380221	Oct.31, 12	1 Year

### 6.2. Limit

Systems using digital modulation techniques may operate in the 902 - 928 MHz, 2400 - 2483.5 MHz, and 5725 - 5850 MHz bands. The minimum 6 dB bandwidth shall be at least 500 kHz.

### 6.3. Test Results

EUT: ACTIVE SUBWOOFER		
M/N:SA-WCT260H		
Test date:2013-05-06	Pressure: 101.2±1.0kpa	Humidity: 53.3±3.0 %
Tested by: Leo-Li	Test site: RF site	Temperature:24.1±0.6 °C

Cable loss: 1 dB		Attenuator loss: 20 dB	
Test Mode	CH (MHz)	6dB bandwidth (MHz)	Limit (KHz)
Tx	2404	1.638	>500
	2440	1.681	>500
	2476	1.785	>500
Conclusion : PASS			

GFSK

Test Frequency: 2404MHz



Test Frequency: 2440MHz



Test Frequency: 2476MHz





## 7. MAXIMUM PEAK OUTPUT POWER TEST

### 7.1. Test Equipment

Item	Equipment	Manufacturer	Model No.	Serial No.	Last Cal.	Cal. Interval
1.	Spectrum	Agilent	E4446A	US44300459	May.08, 12	1 Year
2.	Amp	HP	8449B	3008A08495	May.08, 12	1 Year
3.	Antenna	EMCO	3115	9510-4580	May.31, 12	1Year
4.	HF Cable	Hubersuhne	Sucoflex104	-	May.08, 12	1 Year
5	Power Meter	Anritsu	ML2487A	6K00002472	May.08, 12	1Year
6	Power Sensor	Anritsu	MA2491A	033005	May.08, 12	1Year

### 7.2. Limit

For frequency hopping systems operating in the 2400-2483.5 MHz band employing at least 75 non-overlapping hopping channels, and all frequency hopping systems in the 5725-5850 MHz band: 1 watt. For all other frequency hopping systems in the 2400-2483.5 MHz band: 0.125 watts.

### 7.3. Test Procedure

1. Connected the EUT's antenna port to measure device by appropriate attenuator.
2. Use a PK power meter to measure out each test modes' PK output power.

Note: The cable loss and attenuator loss were offset into measure device as an amplitude offset.

## 7.4. Test Results

EUT: ACTIVE SUBWOOFER			
M/N:SA-WCT260H			
Test date: 2013-03-17		Pressure: 101.2±1.0 kpa	Humidity: 53.3±3.0%
Tested by: Leo-Li		Test site: RF Site	Temperature: 22.9±0.6°C
Cable loss: 1.0 dB		Attenuator loss: 20 dB	
Test Mode	CH (MHz)	Peak output Power (dBm)	Limit (dBm)
Tx	2404	7.35	30
	2440	7.74	30
	2476	7.72	30
Conclusion: PASS			

## 8. POWER SPECTRAL DENSITY TEST

### 8.1. Test Equipment

Item	Equipment	Manufacturer	Model No.	Serial No.	Last Cal.	Cal. Interval
1.	Spectrum	Agilent	N9030A	MY51380221	Oct.31, 12	1 Year
2.	Amp	HP	8449B	3008A08495	May.08, 12	1 Year
3.	Antenna	EMCO	3115	9510-4580	May.31, 12	1Year
4.	HF Cable	Hubersuhne	Sucoflex104	-	May.08, 12	1 Year

### 8.2. Limit

For digitally modulated systems, the power spectral density conducted from the intentional radiator to the antenna shall not be greater than 8dBm in any 3kHz band during any time interval of continuous transmission.

### 8.3. Test Procedure

1. Connected the EUT's antenna port to spectrum analyzer device by 20dB attenuator.
2. Set the test frequency as center frequency,Set RBW=3KHz,VBW=10KHz,Span large enough capture the entire frequency,Read out maximum peak level frequency
3. Set the frequency read from produce 2 as center frequency,then set the span=300KHz, Sweep time=Span/RBW,Then Max hold,read out each mode and each chain's Power density.

Note: The cable loss and attenuator loss were offset into measure device as an amplitude

## Test Results

EUT: ACTIVE SUBWOOFER		
M/N:SA-WCT260H		
Test date:2013-05-06	Pressure: 101.3±1.0kpa	Humidity: 53.7±3.0 %
Tested by: Leo-Li	Test site: RF site	Temperature: 24.3±0.6°C

Duty cycle X: 100%			
Test Mode	CH (MHz)	Result	Limit
		(dBm/MHz)	(dBm/MHz)
Tx	2404	-9.555	8
	2440	-9.110	8
	2476	-9.388	8
Conclusion: PASS			

GFSK  
Test CH1: 2404MHz



Test CH6: 2439MHz

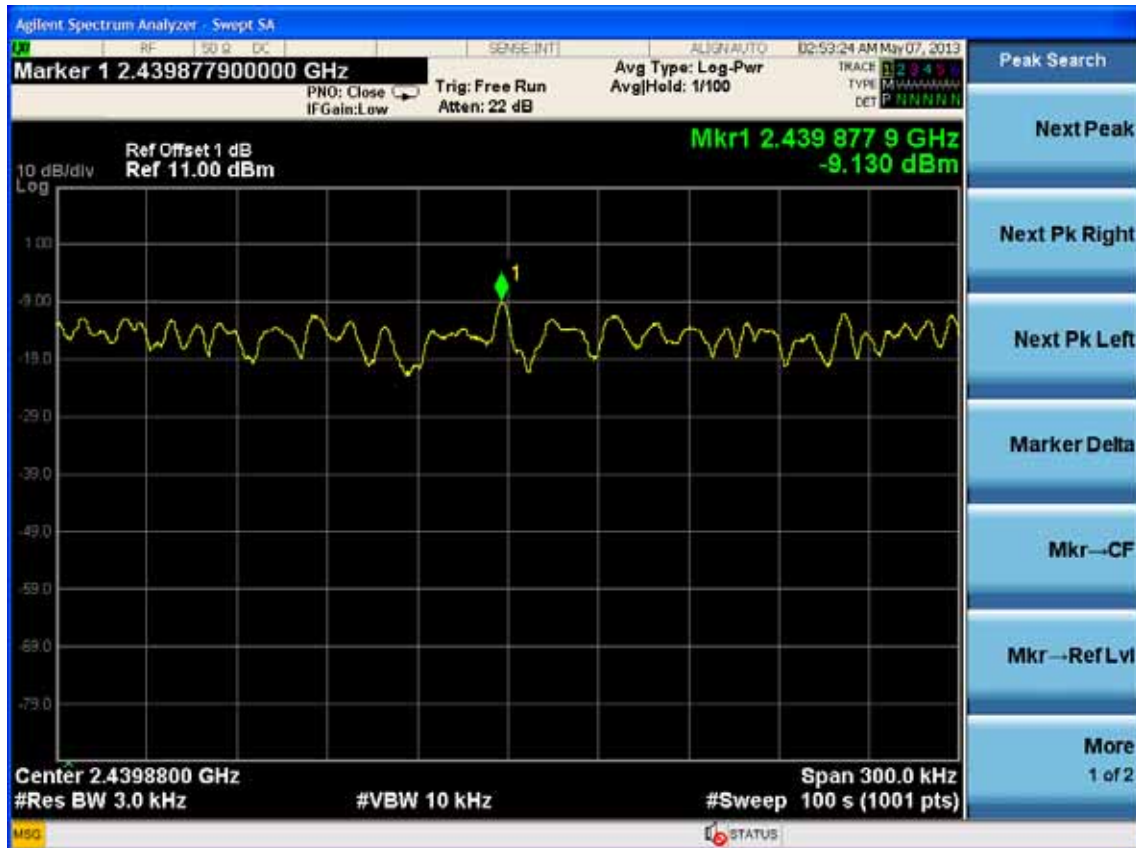

Test CH11: 2476MHz

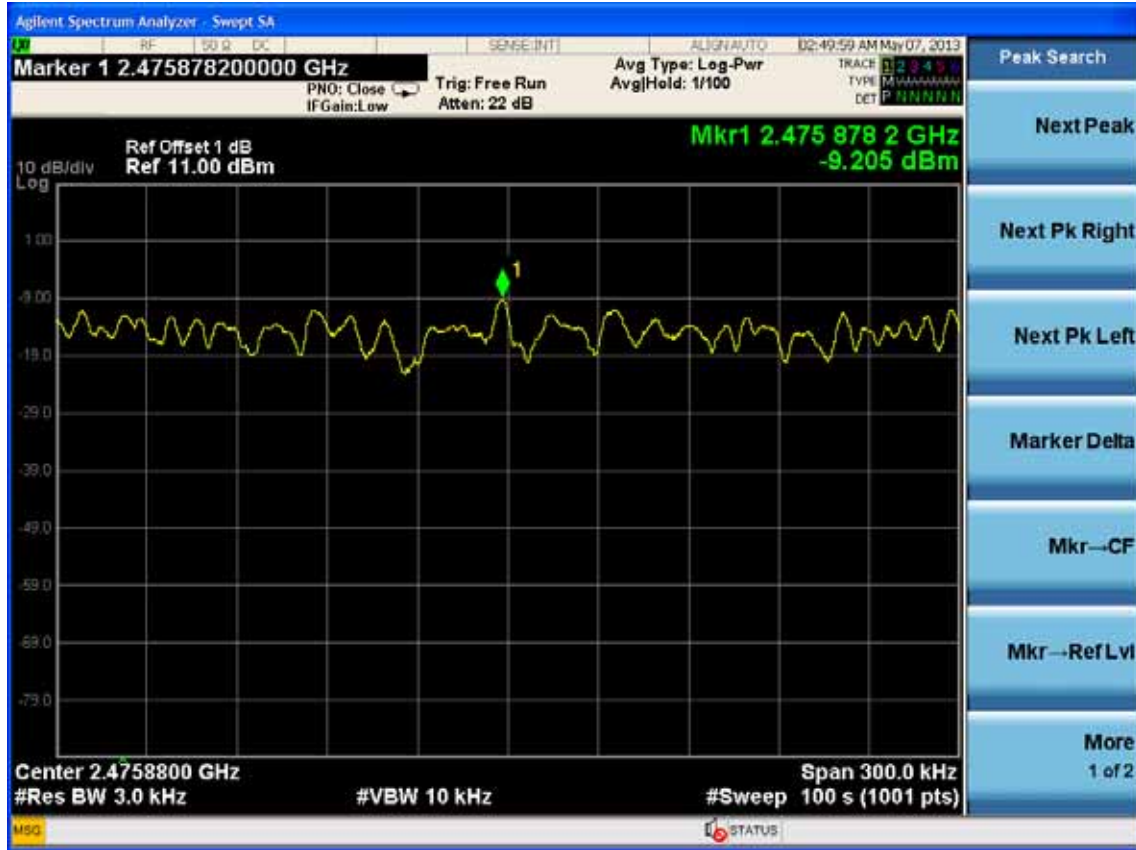

## 9. BAND EDGE COMPLIANCE TEST

### 9.1. Test Equipment

Item	Equipment	Manufacturer	Model No.	Serial No.	Last Cal.	Cal. Interval
1.	Spectrum	Agilent	E4446A	US44300459	May.08, 12	1 Year
2.	Amp	HP	8449B	3008A08495	May.08, 12	1 Year
3.	Antenna	EMCO	3115	4580	May.08, 12	1 Year
4.	HF Cable	Hubersuhne	Sucoflex104	-	May.08, 12	1 Year

### 9.2. Limit

All the lower and upper band-edges emissions appearing within 2310MHz to 2390MHz and 2483.5MHz to 2500MHz restricted frequency bands shall not exceed the limits shown in 15.209, all the other emissions outside operation frequency band 2400MHz to 2483.5MHz shall be at least 20dB below the fundamental emissions, or comply with 15.209 limits.

### 9.3. Test Produce

For upper band emissions that are up to two bandwidths(2MHz) away (2483.5MHz to 2485.5MHz) from the band-edge use below produce:

1. Choose a spectrum analyzer span that encompasses both the peak of the fundamental emission and the band-edge emission under investigation. Set the analyzer RBW to 100KHz and with a video bandwidth 300KHz. Record the peak levels of the fundamental emission and the relevant band-edge emission, Observe the stored trace and measure the amplitude delta between the peak of the fundamental and the peak of the band-edge emission. This is not a field strength measurement, it is only a relative measurement to determine the amount by which the emission drops at the band edge relative to the highest fundamental emission level.
2. Subtract the delta measured in step (1) from the maximum field strengths measured in clause 4 .The resultant field strengths are then used to determine band-edge compliance as required by Section 15.205

For emissions above two bandwidths away from the band-edge use below produce:

1. The EUT is placed on a turntable, which is 0.8m above the ground plane and worked at highest radiated power.
2. The turntable was rotated for 360 degrees to determine the position of maximum emission level.
3. EUT is set 3m away from the receiving antenna, which is varied from 1m to 4m to find out the highest emission.
4. Set the spectrum analyzer in the following setting in order to capture the lower and upperband-edges of the emission:
  - (a) PEAK: RBW=1MHz ;VBW=3MHz, PK detector, Sweep=AUTO
  - (b) AV: RBW=1MHz; VBW=10Hz, Sweep=AUTO

### 9.4. Test Results

Pass (The testing data was attached in the next pages.)

Note: If the PK measured levels comply with average limit, then the average level were deemed to comply with average limit.

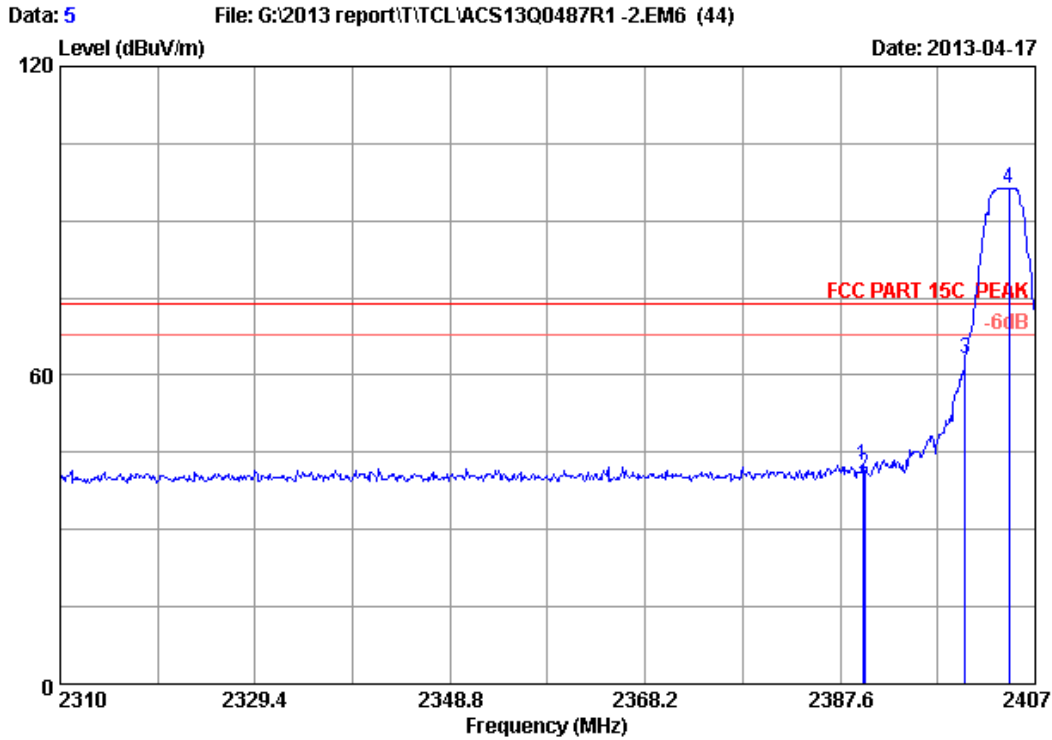

Site no. : 3m Chamber Data no. : 5  
 Dis. / Ant. : 3m 2012 3115 (4580) Ant. pol. : HORIZONTAL  
 Limit : FCC PART 15C PEAK  
 Env. / Ins. : 23°C/54% Engineer : Leo-Li  
 EUT : ACTIVE SUBWOOFER  
 Power supply : AC 120V/60Hz  
 Test mode : 2404MHz Tx  
 M/N : SA-WCT260H  
 :

	Freq. (MHz)	Ant. Factor (dB/m)	Cable loss (dB)	Amp. Factor (dB)	Reading (dBuV)	Emission Level (dBuV/m)	Limits (dBuV/m)	Margin (dB)	Remark
1	2389.831	26.69	6.00	35.92	45.62	42.39	74.00	31.61	Peak
2	2390.000	26.70	6.00	35.92	44.03	40.81	74.00	33.19	Peak
3	2400.000	26.76	6.02	35.92	66.29	63.15	74.00	10.85	Peak
4	2404.381	26.79	6.02	35.92	99.38	96.27	74.00	-22.27	Peak

Remarks:

1. Emission Level= Antenna Factor + Cable Loss -Amp Factor + Reading.
2. The emission levels that are 20dB below the official limit are not reported.



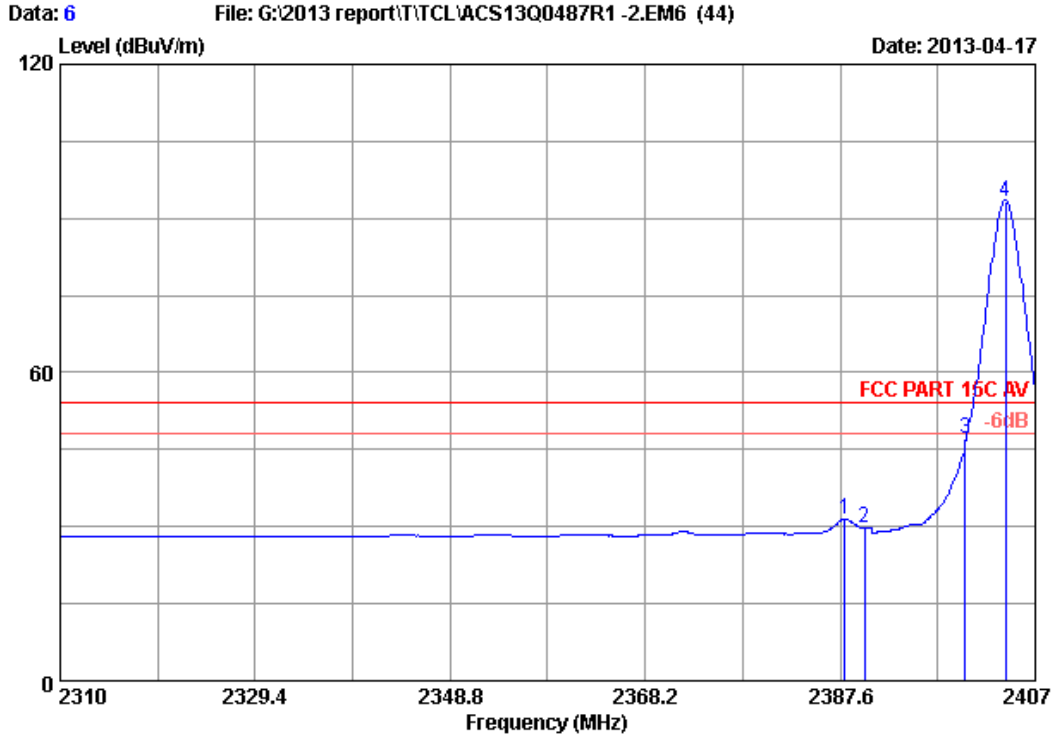

Site no. : 3m Chamber Data no. : 6  
 Dis. / Ant. : 3m 2012 3115 (4580) Ant. pol. : HORIZONTAL  
 Limit : FCC PART 15C AV  
 Env. / Ins. : 23°C/54% Engineer : Leo-Li  
 EUT : ACTIVE SUBWOOFER  
 Power supply : AC 120V/60Hz  
 Test mode : 2404MHz Tx  
 M/N : SA-WCT260H  
 :

	Freq. (MHz)	Ant. Factor (dB/m)	Cable loss (dB)	Amp. Factor (dB)	Reading (dBuV)	Emission Level (dBuV/m)	Limits (dBuV/m)	Margin (dB)	Remark
1	2388.085	26.68	6.00	35.92	34.82	31.58	54.00	22.42	Average
2	2390.000	26.70	6.00	35.92	32.88	29.66	54.00	24.34	Average
3	2400.000	26.76	6.02	35.92	50.26	47.12	54.00	6.88	Average
4	2404.090	26.79	6.02	35.92	96.51	93.40	54.00	-39.40	Average

Remarks:

1. Emission Level= Antenna Factor + Cable Loss -Amp Factor + Reading.
2. The emission levels that are 20dB below the official limit are not reported.

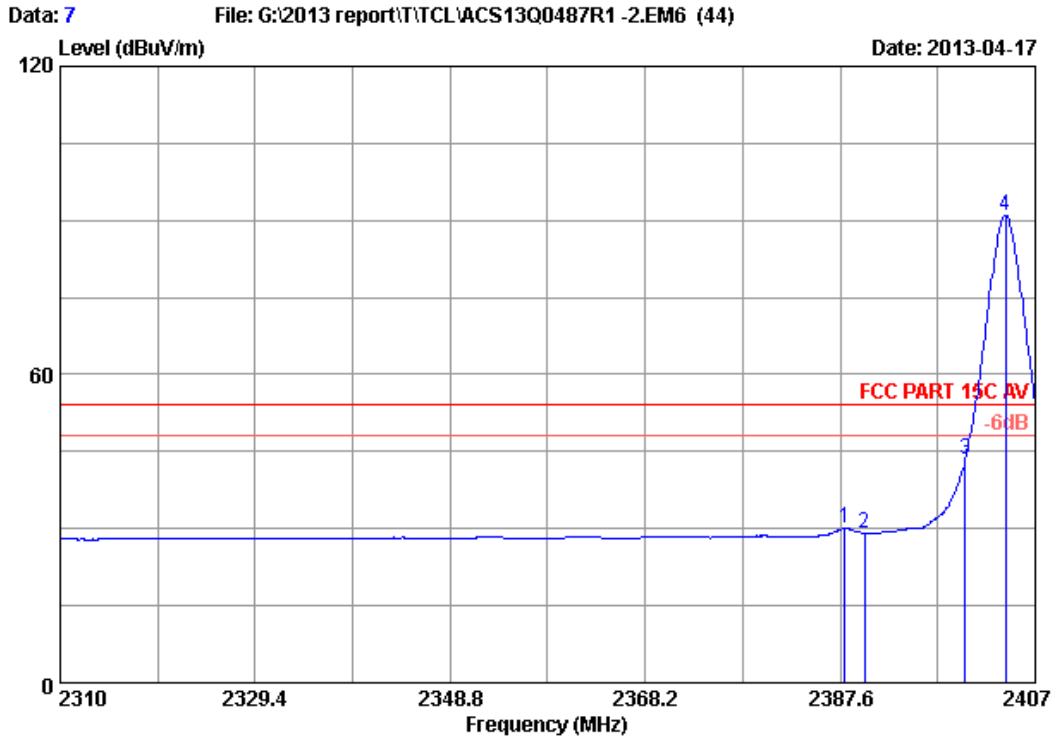

Site no. : 3m Chamber Data no. : 7  
 Dis. / Ant. : 3m 2012 3115 (4580) Ant. pol. : VERTICAL  
 Limit : FCC PART 15C AV  
 Env. / Ins. : 23°C/54% Engineer : Leo-Li  
 EUT : ACTIVE SUBWOOFER  
 Power supply : AC 120V/60Hz  
 Test mode : 2404MHz Tx  
 M/N : SA-WCT260H  
 :

	Freq. (MHz)	Ant. Factor (dB/m)	Cable loss (dB)	Amp. Factor (dB)	Reading (dBuV)	Emission Level (dBuV/m)	Limits (dBuV/m)	Margin (dB)	Remark
1	2388.085	26.68	6.00	35.92	33.26	30.02	54.00	23.98	Average
2	2390.000	26.70	6.00	35.92	32.28	29.06	54.00	24.94	Average
3	2400.000	26.76	6.02	35.92	46.57	43.43	54.00	10.57	Average
4	2404.090	26.79	6.02	35.92	93.98	90.87	54.00	-36.87	Average

Remarks:

1. Emission Level= Antenna Factor + Cable Loss -Amp Factor + Reading.
2. The emission levels that are 20dB below the official limit are not reported.

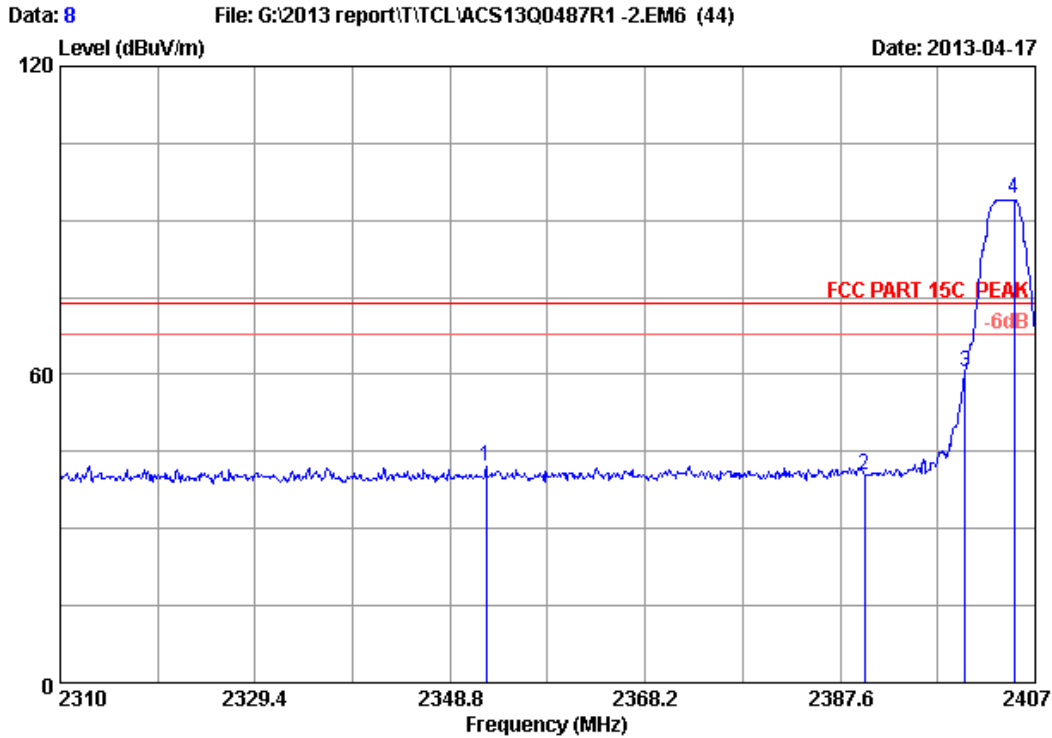

Site no. : 3m Chamber Data no. : 8  
 Dis. / Ant. : 3m 2012 3115 (4580) Ant. pol. : VERTICAL  
 Limit : FCC PART 15C PEAK  
 Env. / Ins. : 23°C/54% Engineer : Leo-Li  
 EUT : ACTIVE SUBWOOFER  
 Power supply : AC 120V/60Hz  
 Test mode : 2404MHz Tx  
 M/N : SA-WCT260H  
 :

	Freq. (MHz)	Ant. Factor (dB/m)	Cable loss (dB)	Amp. Factor (dB)	Reading (dBuV)	Emission Level (dBuV/m)	Limits (dBuV/m)	Margin (dB)	Remark
1	2352.389	26.46	5.94	35.92	45.68	42.16	74.00	31.84	Peak
2	2390.000	26.70	6.00	35.92	43.72	40.50	74.00	33.50	Peak
3	2400.000	26.76	6.02	35.92	63.51	60.37	74.00	13.63	Peak
4	2404.866	26.79	6.03	35.92	97.22	94.12	74.00	-20.12	Peak

Remarks:

1. Emission Level= Antenna Factor + Cable Loss -Amp Factor + Reading.
2. The emission levels that are 20dB below the official limit are not reported.

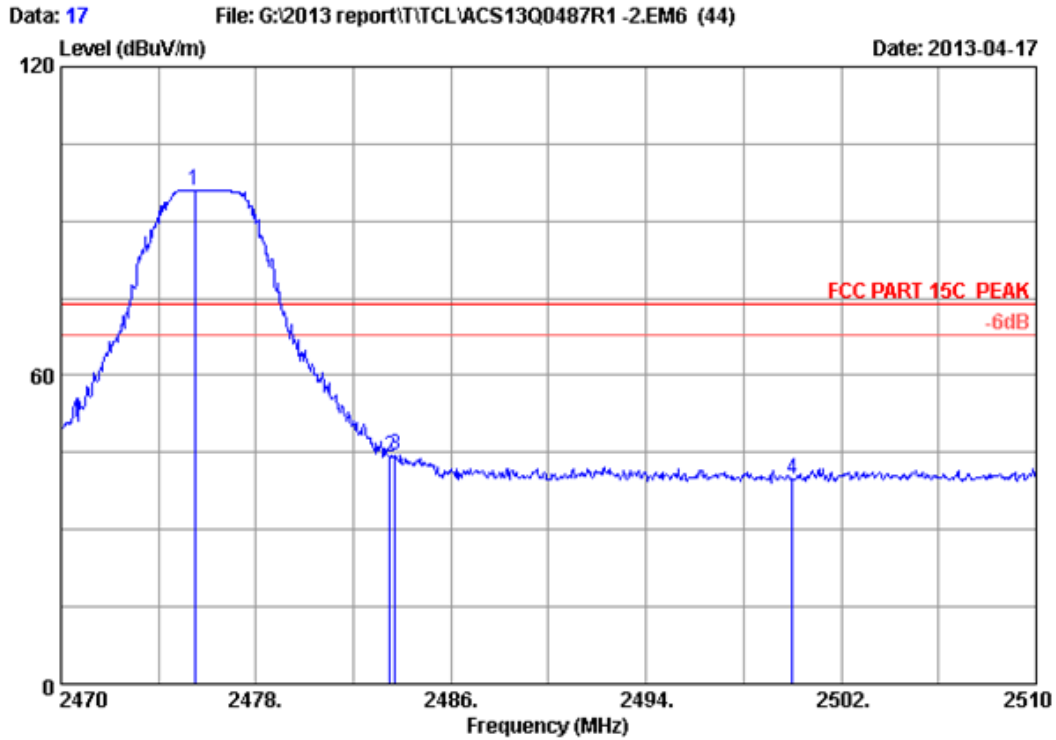

Site no. : 3m Chamber Data no. : 17  
 Dis. / Ant. : 3m 2012 3115 (4580) Ant. pol. : VERTICAL  
 Limit : FCC PART 15C PEAK  
 Env. / Ins. : 23°C/54% Engineer : Leo-Li  
 EUT : ACTIVE SUBWOOFER  
 Power supply : AC 120V/60Hz  
 Test mode : 2476MHz Tx  
 M/N : SA-WCT260H  
 :

	Freq. (MHz)	Ant. Factor (dB/m)	Cable loss (dB)	Amp. Factor (dB)	Reading (dBUV)	Emission Level (dBUV/m)	Limits (dBUV/m)	Margin (dB)	Remark
1	2475.480	27.24	6.15	35.92	98.40	95.87	74.00	-21.87	Peak
2	2483.500	27.29	6.16	35.92	46.71	44.24	74.00	29.76	Peak
3	2483.720	27.30	6.16	35.92	46.97	44.51	74.00	29.49	Peak
4	2500.000	27.40	6.19	35.93	42.08	39.74	74.00	34.26	Peak

Remarks:

1. Emission Level= Antenna Factor + Cable Loss -Amp Factor + Reading.
2. The emission levels that are 20dB below the official limit are not reported.

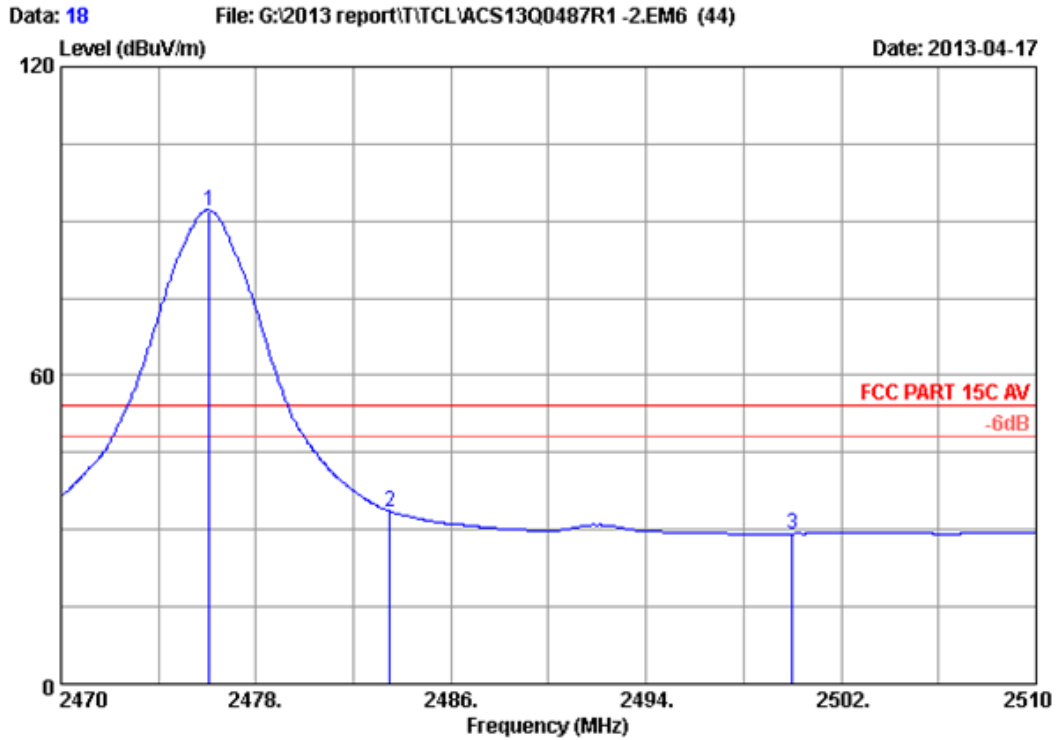

Site no. : 3m Chamber Data no. : 18  
 Dis. / Ant. : 3m 2012 3115 (4580) Ant. pol. : VERTICAL  
 Limit : FCC PART 15C AV  
 Env. / Ins. : 23°C/54% Engineer : Leo-Li  
 EUT : ACTIVE SUBWOOFER  
 Power supply : AC 120V/60Hz  
 Test mode : 2476MHz Tx  
 M/N : SA-WCT260H  
 :

	Freq. (MHz)	Ant. Factor (dB/m)	Cable loss (dB)	Amp. Factor (dB)	Reading (dBUV)	Emission Level (dBUV/m)	Limits (dBUV/m)	Margin (dB)	Remark
1	2476.080	27.25	6.15	35.92	94.42	91.90	54.00	-37.90	Average
2	2483.500	27.29	6.16	35.92	35.87	33.40	54.00	20.60	Average
3	2500.000	27.40	6.19	35.93	31.49	29.15	54.00	24.85	Average

Remarks:

1. Emission Level= Antenna Factor + Cable Loss -Amp Factor + Reading.
2. The emission levels that are 20dB below the official limit are not reported.

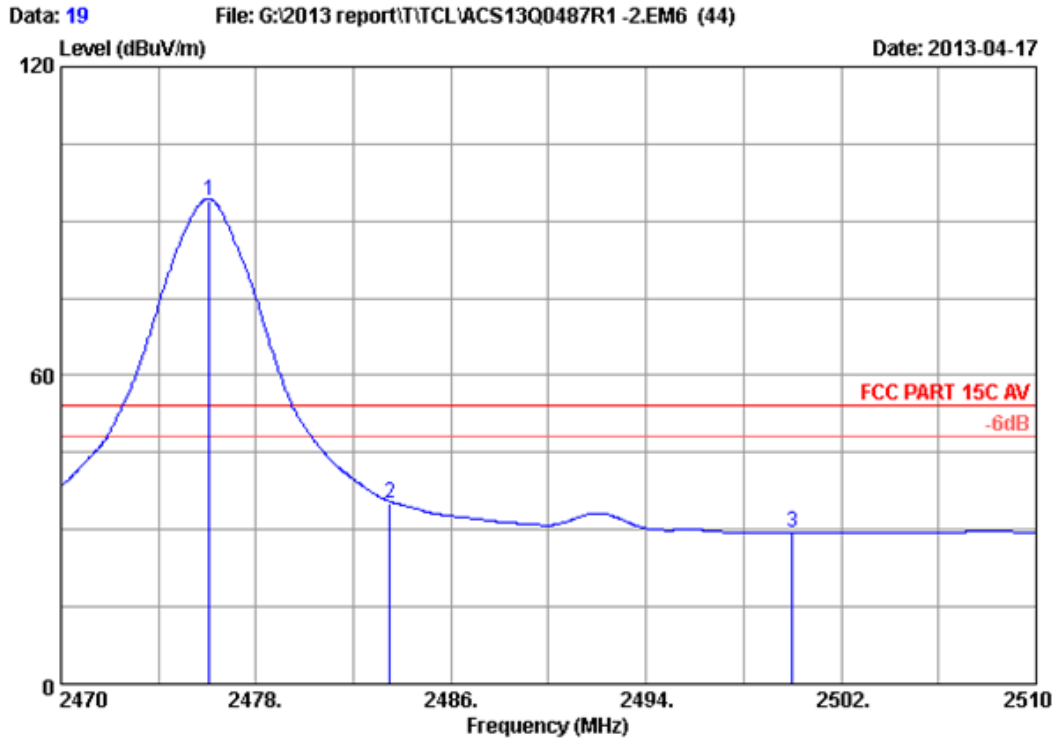

Site no. : 3m Chamber Data no. : 19  
 Dis. / Ant. : 3m 2012 3115 (4580) Ant. pol. : HORIZONTAL  
 Limit : FCC PART 15C AV  
 Env. / Ins. : 23°C/54% Engineer : Leo-Li  
 EUT : ACTIVE SUBWOOFER  
 Power supply : AC 120V/60Hz  
 Test mode : 2476MHz Tx  
 M/N : SA-WCT260H  
 :

	Freq. (MHz)	Ant. Factor (dB/m)	Cable loss (dB)	Amp. Factor (dB)	Reading (dBUV)	Emission Level (dBUV/m)	Limits (dBUV/m)	Margin (dB)	Remark
1	2476.080	27.25	6.15	35.92	96.46	93.94	54.00	-39.94	Average
2	2483.500	27.29	6.16	35.92	37.72	35.25	54.00	18.75	Average
3	2500.000	27.40	6.19	35.93	31.65	29.31	54.00	24.69	Average

Remarks:

1. Emission Level= Antenna Factor + Cable Loss -Amp Factor + Reading.
2. The emission levels that are 20dB below the official limit are not reported.

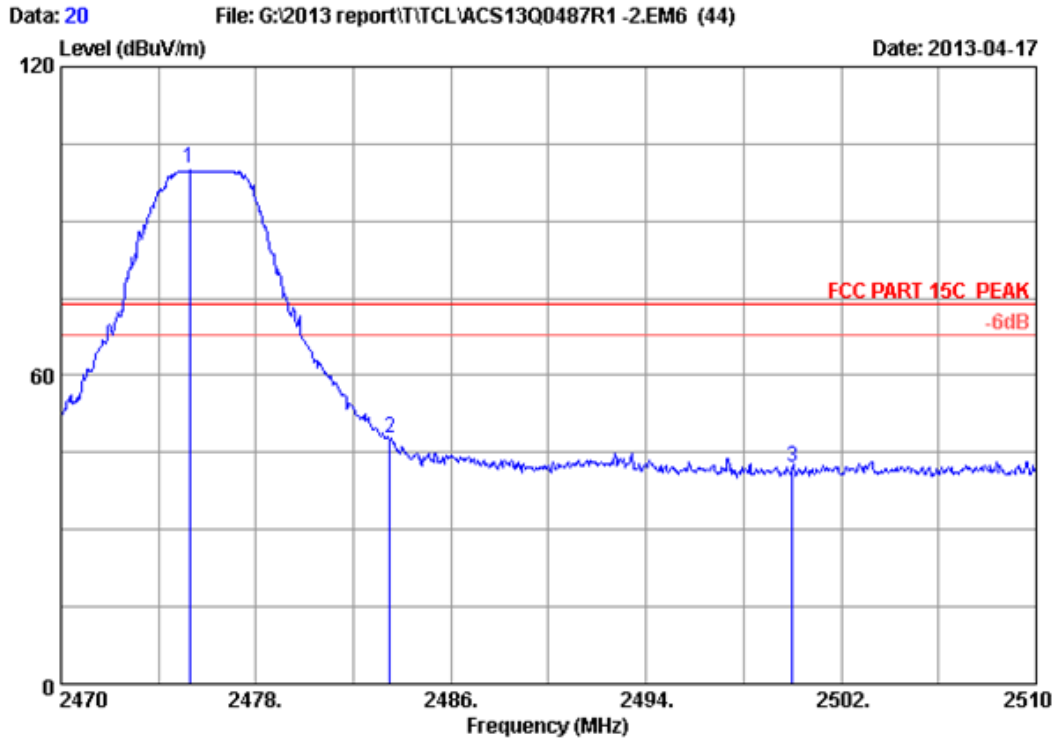

Site no. : 3m Chamber Data no. : 20  
 Dis. / Ant. : 3m 2012 3115 (4580) Ant. pol. : HORIZONTAL  
 Limit : FCC PART 15C PEAK  
 Env. / Ins. : 23°C/54% Engineer : Leo-Li  
 EUT : ACTIVE SUBWOOFER  
 Power supply : AC 120V/60Hz  
 Test mode : 2476MHz Tx  
 M/N : SA-WCT260H  
 :

	Freq. (MHz)	Ant. Factor (dB/m)	Cable loss (dB)	Amp. Factor (dB)	Reading (dBUV)	Emission Level (dBUV/m)	Limits (dBUV/m)	Margin (dB)	Remark
1	2475.280	27.24	6.15	35.92	102.73	100.20	74.00	-26.20	Peak
2	2483.500	27.29	6.16	35.92	50.11	47.64	74.00	26.36	Peak
3	2500.000	27.40	6.19	35.93	44.35	42.01	74.00	31.99	Peak

Remarks:

1. Emission Level= Antenna Factor + Cable Loss -Amp Factor + Reading.
2. The emission levels that are 20dB below the official limit are not reported.

## 10.DEVIATION TO TEST SPECIFICATIONS

[NONE]