

Radiated Emission test (below 1 GHz)

TR-4-E-009 Radiated Emission Test Result

Test Date: 2023-07-13 **Tested By:** Bairong
EUT: 2.0 Soundbar System **Model Number:** SV200M-0808
Test Mode: Tx Mode **Power Supply:** AC 120V/60Hz
Condition: Temp:23.2°C;Humi:64.6% **Test Site:** DDT 3# Chamber
File Path: d:\ts\2023 report data\Q23070309-2E SV200\FCC BELOW 1G\20230713-011647_H
Memo: BLE 1M

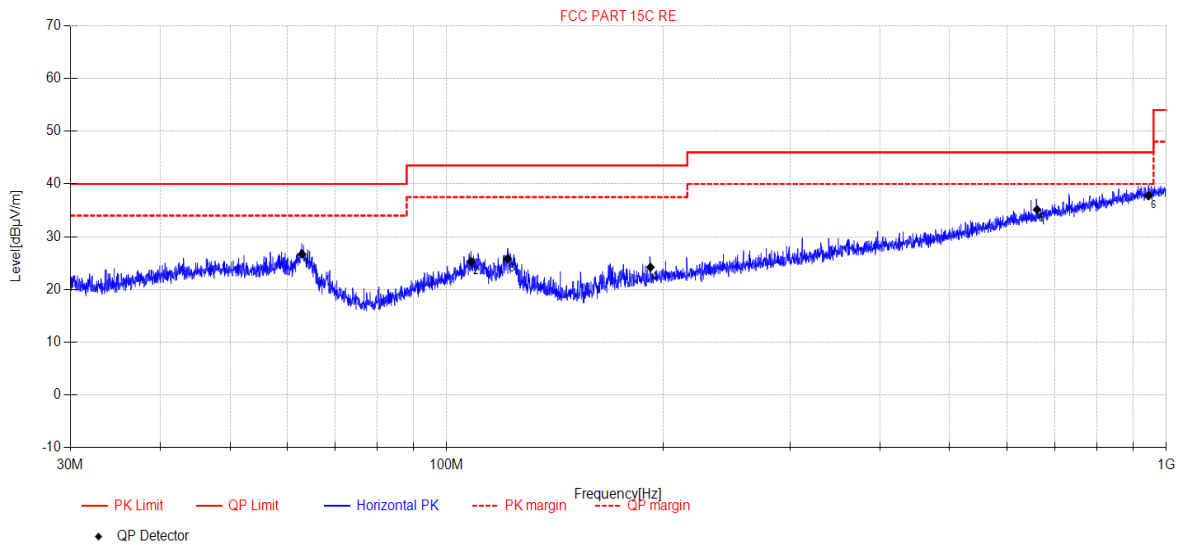

Final Data List										
NO.	Freq. [MHz]	Reading [dBµV/m]	Antenna Factor [dB]	Cable Loss [dB]	AMP [dB]	Result [dBµV/m]	Limit [dBµV/m]	Margin [dB]	Detector	Polarity
1	62.95	10.82	11.12	4.77	0.00	26.71	40.00	13.29	QP	Horizontal
2	108.16	9.46	10.68	5.11	0.00	25.25	43.50	18.25	QP	Horizontal
3	121.60	12.1	8.54	5.18	0.00	25.82	43.50	17.68	QP	Horizontal
4	191.94	8.16	10.39	5.66	0.00	24.21	43.50	19.29	QP	Horizontal
5	661.21	8.13	19.42	7.59	0.00	35.14	46.00	10.86	QP	Horizontal
6	944.79	6.65	22.60	8.50	0.00	37.75	46.00	8.25	QP	Horizontal

Note:

1. Result Level = Reading + Cable loss + Antenna Factor + AMP
2. If Peak Result complies with QP limit, QP Result is deemed to comply with QP limit.
3. Test setup: RBW: 120 kHz, VBW: 300 kHz, Sweep time: auto.

TR-4-E-009 Radiated Emission Test Result

Test Date: 2023-07-13 **Tested By:** Bairong
EUT: 2.0 Soundbar System **Model Number:** SV200M-0808
Test Mode: Tx Mode **Power Supply:** AC 120V/60Hz
Condition: Temp:23.2°C;Humi:64.6% **Test Site:** DDT 3# Chamber
File Path: d:\ts\2023 report data\Q23070309-2E SV200\FCC BELOW 1G\20230713-011733_V
Memo: BLE 1M

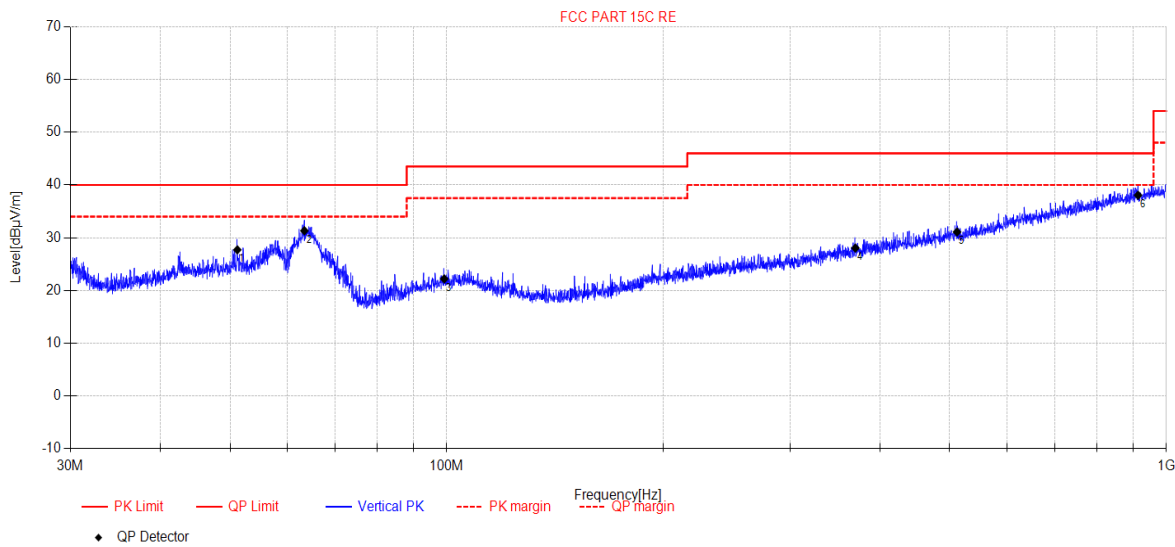

Final Data List										
NO.	Freq. [MHz]	Reading [dBµV/m]	Antenna Factor [dB]	Cable Loss [dB]	AMP [dB]	Result [dBµV/m]	Limit [dBµV/m]	Margin [dB]	Detector	Polarity
1	51.19	9.9	13.08	4.73	0.00	27.71	40.00	12.29	QP	Vertical
2	63.44	15.54	11.01	4.77	0.00	31.32	40.00	8.68	QP	Vertical
3	99.23	6.32	10.82	5.06	0.00	22.20	43.50	21.30	QP	Vertical
4	369.74	6.62	14.89	6.53	0.00	28.04	46.00	17.96	QP	Vertical
5	511.90	6.91	17.20	6.98	0.00	31.09	46.00	14.91	QP	Vertical
6	913.52	7.16	22.50	8.39	0.00	38.05	46.00	7.95	QP	Vertical

Note:

1. Result Level = Reading + Cable loss + Antenna Factor + AMP
2. If Peak Result complies with QP limit, QP Result is deemed to comply with QP limit.
3. Test setup: RBW: 120 kHz, VBW: 300 kHz, Sweep time: auto.

Radiated Emission test (above 1 GHz)

TR-4-E-009 Radiated Emission Test Result

Test Date: 2023-07-13 **Tested By:** Liaowanrong
EUT: 2.0 Soundbar System **Model Number:** SV200M-0808
Test Mode: Tx Mode **Power Supply:** AC 120V/60Hz
Condition: Temp:23.2°C;Humi:64.6% **Test Site:** DDT 3# Chamber
File Path: d:\ts\2023 report data\Q23070309-2E SV200\FCC ABOVE 1G\11
Memo: BLE 1M 2402

Test Graph

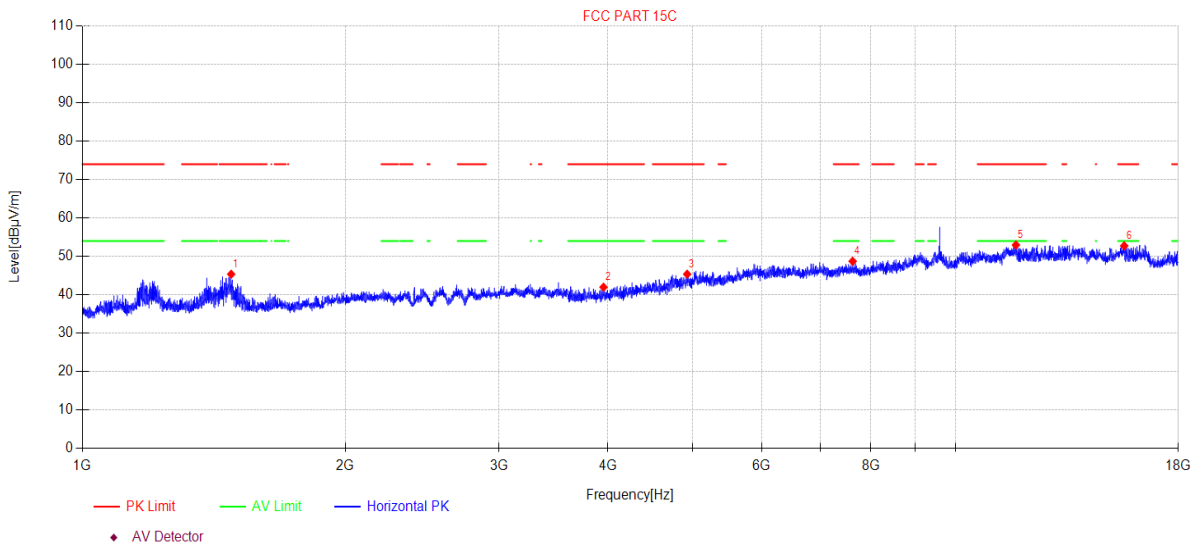

Suspected Data List										
N O.	Freq. [MHz]	Reading [dBµV/m]	Cable loss [dB]	Antenna Factor [dB]	AMP [dB]	Level [dBµV/m]	Limit [dBµV/m]	Margin [dB]	Detector	Polarity
1	1480.64	54.31	4.43	25.54	-38.92	45.36	74.00	28.64	PK	Horizontal
2	3953.19	46.91	5.84	30.61	-41.37	41.99	74.00	32.01	PK	Horizontal
3	4928.51	46.05	7.73	32.71	-41.12	45.37	74.00	28.63	PK	Horizontal
4	7625.05	45.64	7.65	36.45	-41.00	48.74	74.00	25.26	PK	Horizontal
5	11728.97	43.19	10.30	38.80	-39.33	52.96	74.00	21.04	PK	Horizontal
6	15605.16	40.38	14.09	38.39	-40.12	52.74	74.00	21.26	PK	Horizontal

Note:

1. Level = Reading + Cable loss + Antenna Factor + AMP
2. If Peak Result complies with AV limit, AV Result is deemed to comply with AV limit.
3. Test setup: RBW: 1 MHz, VBW: 3 MHz, Sweep time: auto.

TR-4-E-009 Radiated Emission Test Result

Test Date: 2023-07-13 **Tested By:** Liaowanrong
EUT: 2.0 Soundbar System **Model Number:** SV200M-0808
Test Mode: Tx Mode **Power Supply:** AC 120V/60Hz
Condition: Temp:23.2°C;Humi:64.6% **Test Site:** DDT 3# Chamber
File Path: d:\ts\2023 report data\Q23070309-2E SV200\FCC ABOVE 1G\12
Memo: BLE 1M 2402

Test Graph

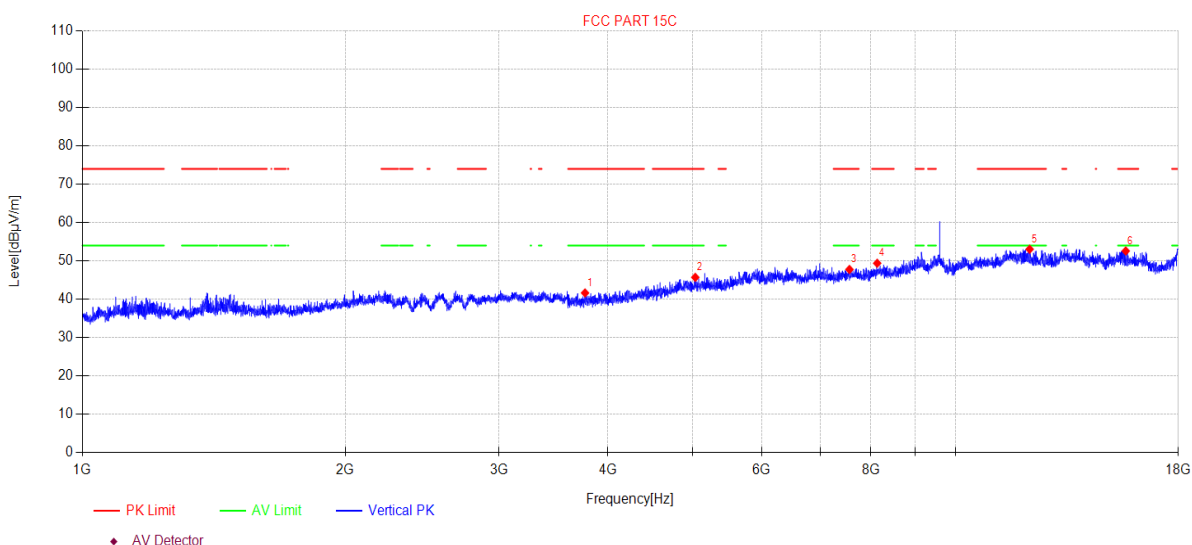

Suspected Data List										
N O.	Freq. [MHz]	Reading [dBµV/m]	Cable loss [dB]	Antenna Factor [dB]	AMP [dB]	Level [dBµV/m]	Limit [dBµV/m]	Margin [dB]	Detector	Polarity
1	3764.75	46.96	5.80	30.16	-41.26	41.66	74.00	32.34	PK	Vertical
2	5035.05	46.01	7.92	32.87	-41.09	45.71	74.00	28.29	PK	Vertical
3	7561.41	44.72	7.65	36.40	-41.00	47.77	74.00	26.23	PK	Vertical
4	8135.01	45.35	7.82	37.00	-40.78	49.39	74.00	24.61	PK	Vertical
5	12160.43	42.47	10.54	39.10	-39.06	53.05	74.00	20.95	PK	Vertical
6	15668.43	40.06	14.38	38.33	-40.17	52.60	74.00	21.40	PK	Vertical

Note:

1. Level = Reading + Cable loss + Antenna Factor + AMP
2. If Peak Result complies with AV limit, AV Result is deemed to comply with AV limit.
3. Test setup: RBW: 1 MHz, VBW: 3 MHz, Sweep time: auto.

TR-4-E-009 Radiated Emission Test Result

Test Date: 2023-07-13 **Tested By:** Liaowanrong
EUT: 2.0 Soundbar System **Model Number:** SV200M-0808
Test Mode: Tx Mode **Power Supply:** AC 120V/60Hz
Condition: Temp:23.2°C;Humi:64.6% **Test Site:** DDT 3# Chamber
File Path: d:\ts\2023 report data\Q23070309-2E SV200\FCC ABOVE 1G\13
Memo: BLE 1M 2440

Test Graph

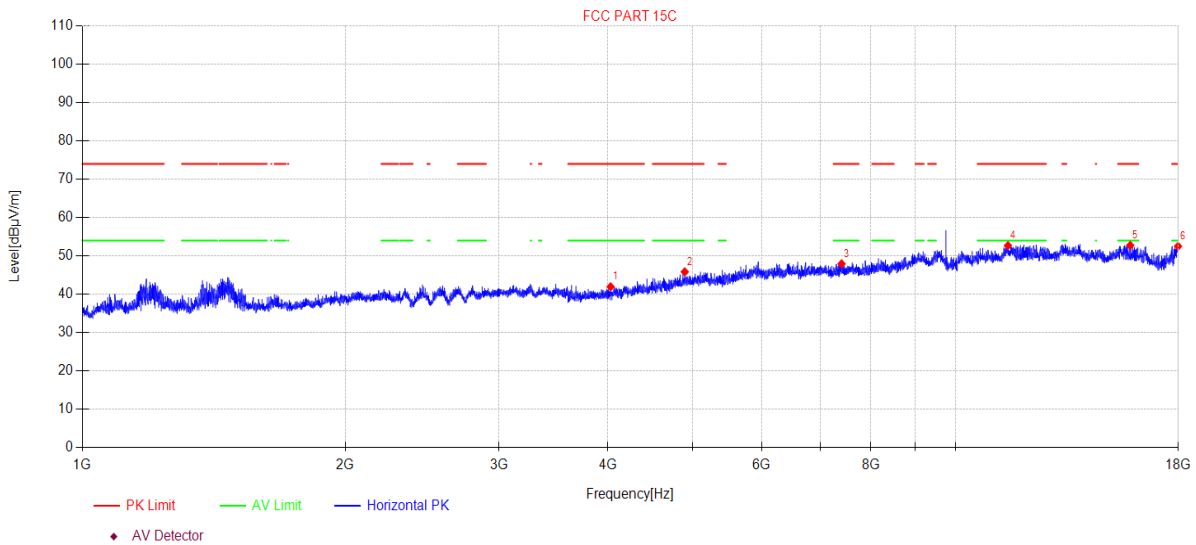

Suspected Data List										
N O.	Freq. [MHz]	Reading [dBµV/m]	Cable loss [dB]	Antenna Factor [dB]	AMP [dB]	Level [dBµV/m]	Limit [dBµV/m]	Margin [dB]	Detector	Polarity
1	4026.99	46.69	5.90	30.75	-41.39	41.95	74.00	32.05	PK	Horizontal
2	4897.27	46.73	7.66	32.59	-41.13	45.85	74.00	28.15	PK	Horizontal
3	7405.70	44.81	7.64	36.50	-41.00	47.95	74.00	26.05	PK	Horizontal
4	11484.10	43.32	10.08	39.02	-39.73	52.69	74.00	21.31	PK	Horizontal
5	15855.19	39.71	15.22	38.14	-40.30	52.77	74.00	21.23	PK	Horizontal
6	17984.40	38.39	13.11	41.71	-40.69	52.52	74.00	21.48	PK	Horizontal

Note:

1. Level = Reading + Cable loss + Antenna Factor + AMP
2. If Peak Result complies with AV limit, AV Result is deemed to comply with AV limit.
3. Test setup: RBW: 1 MHz, VBW: 3 MHz, Sweep time: auto.

TR-4-E-009 Radiated Emission Test Result

Test Date: 2023-07-13 **Tested By:** Liaowanrong
EUT: 2.0 Soundbar System **Model Number:** SV200M-0808
Test Mode: Tx Mode **Power Supply:** AC 120V/60Hz
Condition: Temp:23.2°C;Humi:64.6% **Test Site:** DDT 3# Chamber
File Path: d:\ts\2023 report data\Q23070309-2E SV200\FCC ABOVE 1G\14
Memo: BLE 1M 2440

Test Graph

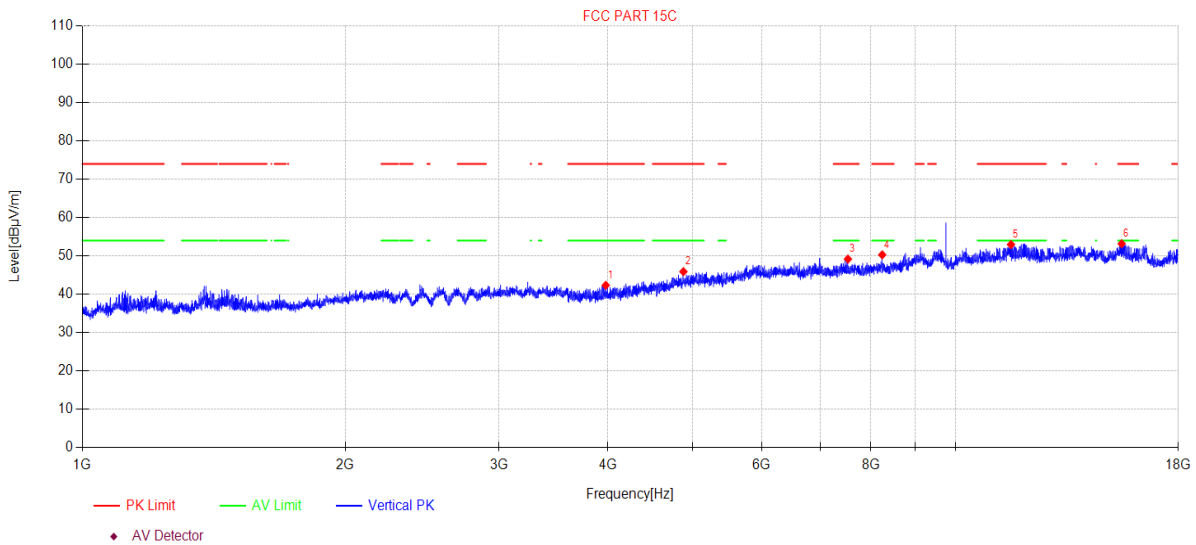

Suspected Data List										
N O.	Freq. [MHz]	Reading [dBµV/m]	Cable loss [dB]	Antenna Factor [dB]	AMP [dB]	Level [dBµV/m]	Limit [dBµV/m]	Margin [dB]	Detector	Polarity
1	3976.11	47.24	5.84	30.65	-41.39	42.34	74.00	31.66	PK	Vertical
2	4880.32	46.85	7.63	32.56	-41.14	45.90	74.00	28.10	PK	Vertical
3	7530.88	46.13	7.65	36.40	-41.00	49.18	74.00	24.82	PK	Vertical
4	8243.88	45.86	7.94	37.10	-40.61	50.29	74.00	23.71	PK	Vertical
5	11577.41	43.46	10.16	38.92	-39.58	52.96	74.00	21.04	PK	Vertical
6	15501.77	41.01	13.62	38.60	-40.05	53.18	74.00	20.82	PK	Vertical

Note:

1. Level = Reading + Cable loss + Antenna Factor + AMP
2. If Peak Result complies with AV limit, AV Result is deemed to comply with AV limit.
3. Test setup: RBW: 1 MHz, VBW: 3 MHz, Sweep time: auto.

TR-4-E-009 Radiated Emission Test Result

Test Date: 2023-07-13 **Tested By:** Liaowanrong
EUT: 2.0 Soundbar System **Model Number:** SV200M-0808
Test Mode: Tx Mode **Power Supply:** AC 120V/60Hz
Condition: Temp:23.2°C;Humi:64.6% **Test Site:** DDT 3# Chamber
File Path: d:\ts\2023 report data\Q23070309-2E SV200\FCC ABOVE 1G\15
Memo: BLE 1M 2480

Test Graph

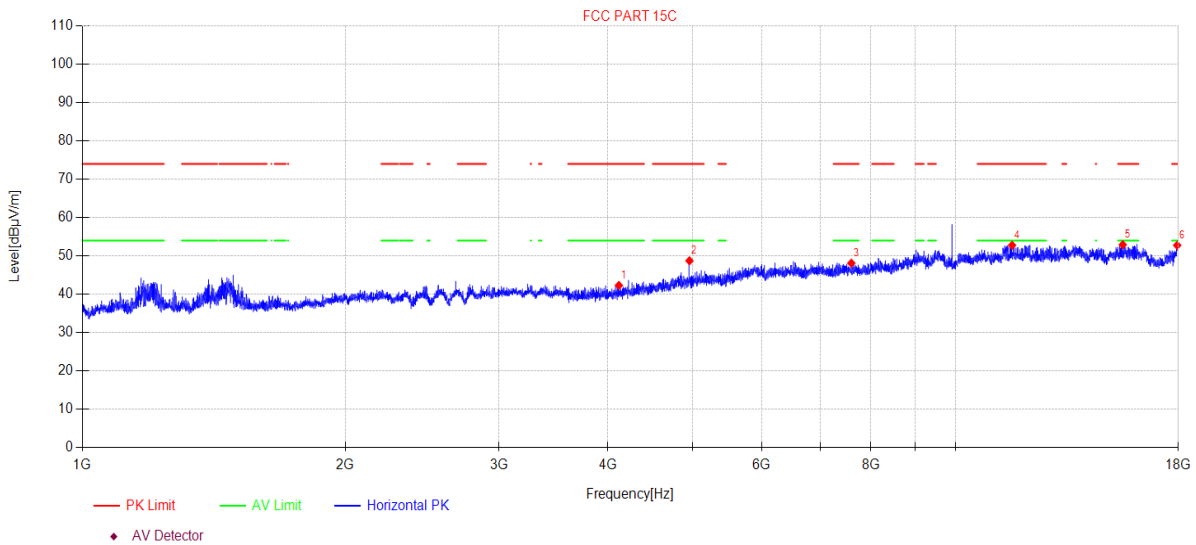

Suspected Data List										
N O.	Freq. [MHz]	Reading [dBµV/m]	Cable loss [dB]	Antenna Factor [dB]	AMP [dB]	Level [dBµV/m]	Limit [dBµV/m]	Margin [dB]	Detector	Polarity
1	4116.42	46.66	6.09	30.93	-41.37	42.31	74.00	31.69	PK	Horizontal
2	4958.51	49.25	7.79	32.80	-41.11	48.73	74.00	25.27	PK	Horizontal
3	7598.65	45.06	7.65	36.40	-41.00	48.11	74.00	25.89	PK	Horizontal
4	11610.92	43.21	10.19	38.89	-39.52	52.77	74.00	21.23	PK	Horizontal
5	15546.64	40.66	13.83	38.51	-40.08	52.92	74.00	21.08	PK	Horizontal
6	17942.87	38.93	13.06	41.46	-40.68	52.77	74.00	21.23	PK	Horizontal

Note:

1. Level = Reading + Cable loss + Antenna Factor + AMP
2. If Peak Result complies with AV limit, AV Result is deemed to comply with AV limit.
3. Test setup: RBW: 1 MHz, VBW: 3 MHz, Sweep time: auto.

TR-4-E-009 Radiated Emission Test Result

Test Date: 2023-07-13 **Tested By:** Liaowanrong
EUT: 2.0 Soundbar System **Model Number:** SV200M-0808
Test Mode: Tx Mode **Power Supply:** AC 120V/60Hz
Condition: Temp:23.2°C;Humi:64.6% **Test Site:** DDT 3# Chamber
File Path: d:\ts\2023 report data\Q23070309-2E SV200\FCC ABOVE 1G\16
Memo: BLE 1M 2480

Test Graph

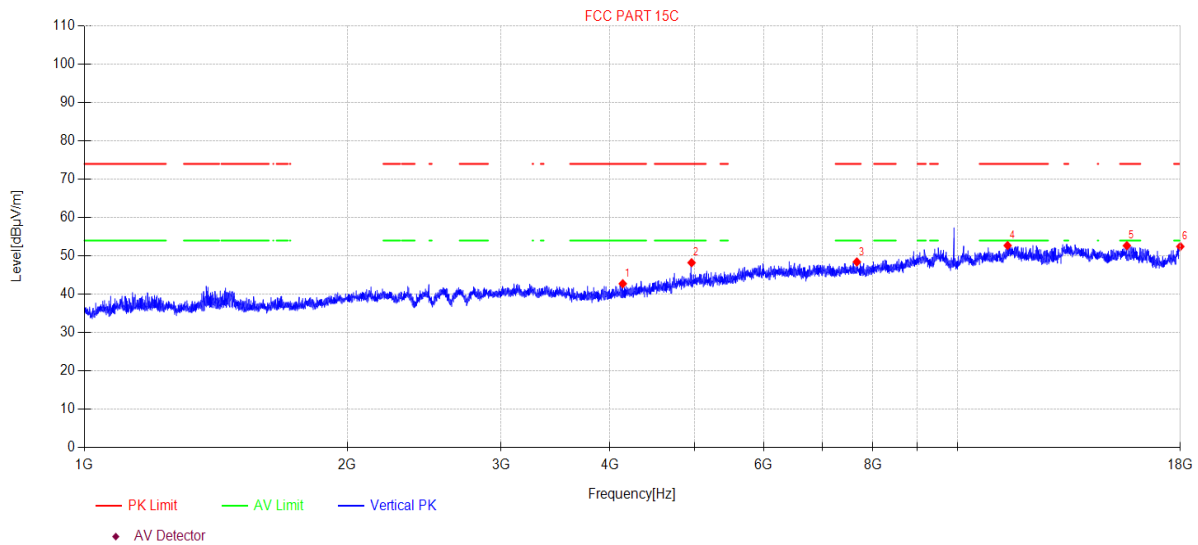

Suspected Data List										
N O.	Freq. [MHz]	Reading [dBµV/m]	Cable loss [dB]	Antenna Factor [dB]	AMP [dB]	Level [dBµV/m]	Limit [dBµV/m]	Margin [dB]	Detector	Polarity
1	4136.70	47.02	6.13	30.97	-41.36	42.76	74.00	31.24	PK	Vertical
2	4959.95	48.75	7.79	32.80	-41.11	48.23	74.00	25.77	PK	Vertical
3	7669.25	45.23	7.66	36.54	-41.00	48.43	74.00	25.57	PK	Vertical
4	11414.62	43.44	10.02	39.09	-39.84	52.71	74.00	21.29	PK	Vertical
5	15632.24	40.23	14.21	38.37	-40.14	52.67	74.00	21.33	PK	Vertical
6	18000.00	38.22	13.13	41.80	-40.70	52.45	74.00	21.55	PK	Vertical

Note:

1. Level = Reading + Cable loss + Antenna Factor + AMP
2. If Peak Result complies with AV limit, AV Result is deemed to comply with AV limit.
3. Test setup: RBW: 1 MHz, VBW: 3 MHz, Sweep time: auto.

TR-4-E-009 Radiated Emission Test Result

Test Date: 2023-07-13 **Tested By:** Liaowanrong
EUT: 2.0 Soundbar System **Model Number:** SV200M-0808
Test Mode: Tx Mode **Power Supply:** AC 120V/60Hz
Condition: Temp:23.2°C;Humi:64.6% **Test Site:** DDT 3# Chamber
File Path: d:\ts\2023 report data\Q23070309-2E SV200\FCC ABOVE 1G\17
Memo: BLE 2M 2402

Test Graph

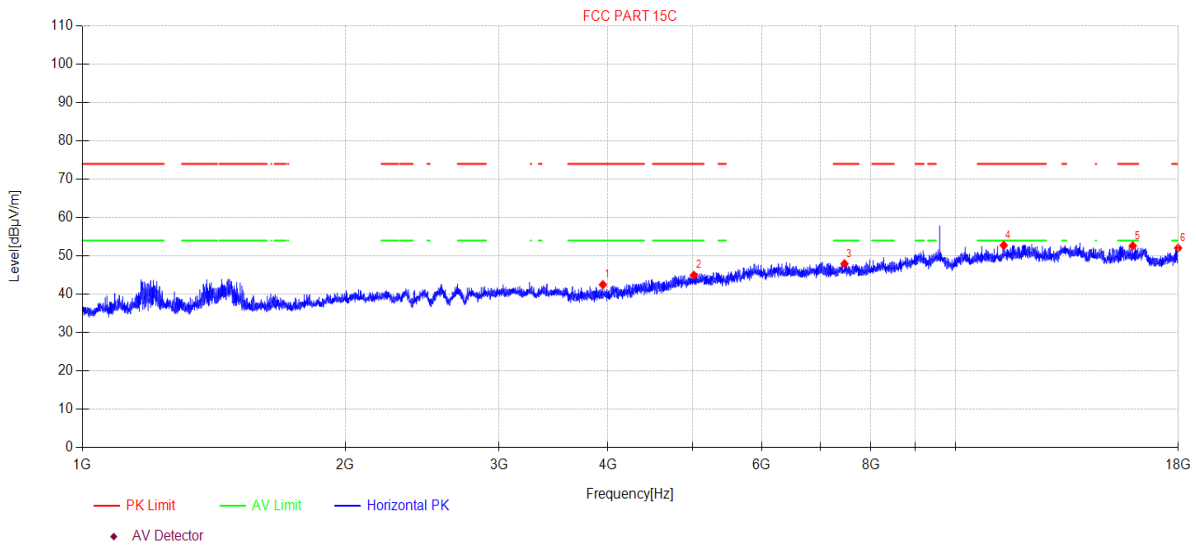

Suspected Data List										
N O.	Freq. [MHz]	Reading [dBµV/m]	Cable loss [dB]	Antenna Factor [dB]	AMP [dB]	Level [dBµV/m]	Limit [dBµV/m]	Margin [dB]	Detector	Polarity
1	3946.34	47.45	5.84	30.59	-41.37	42.51	74.00	31.49	PK	Horizontal
2	5016.17	45.35	7.89	32.83	-41.09	44.98	74.00	29.02	PK	Horizontal
3	7463.71	44.85	7.64	36.47	-41.00	47.96	74.00	26.04	PK	Horizontal
4	11358.67	43.63	9.97	39.10	-39.93	52.77	74.00	21.23	PK	Horizontal
5	15960.94	39.31	15.70	37.98	-40.37	52.62	74.00	21.38	PK	Horizontal
6	17989.60	37.89	13.12	41.74	-40.70	52.05	74.00	21.95	PK	Horizontal

Note:

1. Level = Reading + Cable loss + Antenna Factor + AMP
2. If Peak Result complies with AV limit, AV Result is deemed to comply with AV limit.
3. Test setup: RBW: 1 MHz, VBW: 3 MHz, Sweep time: auto.

TR-4-E-009 Radiated Emission Test Result

Test Date: 2023-07-13 **Tested By:** Liaowanrong
EUT: 2.0 Soundbar System **Model Number:** SV200M-0808
Test Mode: Tx Mode **Power Supply:** AC 120V/60Hz
Condition: Temp:23.2°C;Humi:64.6% **Test Site:** DDT 3# Chamber
File Path: d:\ts\2023 report data\Q23070309-2E SV200\FCC ABOVE 1G\18
Memo: BLE 2M 2402

Test Graph

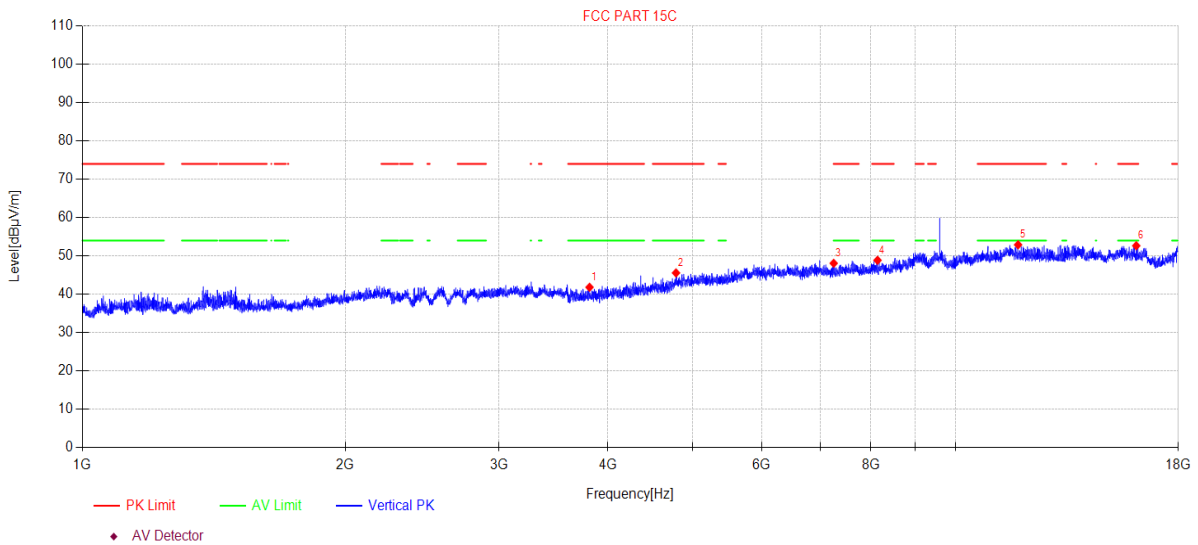

Suspected Data List										
N O.	Freq. [MHz]	Reading [dBµV/m]	Cable loss [dB]	Antenna Factor [dB]	AMP [dB]	Level [dBµV/m]	Limit [dBµV/m]	Margin [dB]	Detector	Polarity
1	3809.62	46.99	5.81	30.32	-41.29	41.83	74.00	32.17	PK	Vertical
2	4785.34	47.05	7.44	32.24	-41.16	45.57	74.00	28.43	PK	Vertical
3	7253.19	44.95	7.63	36.50	-41.00	48.08	74.00	25.92	PK	Vertical
4	8142.07	44.80	7.83	37.00	-40.77	48.86	74.00	25.14	PK	Vertical
5	11796.96	42.96	10.36	38.80	-39.22	52.90	74.00	21.10	PK	Vertical
6	16109.23	39.81	15.45	37.79	-40.39	52.66	74.00	21.34	PK	Vertical

Note:

1. Level = Reading + Cable loss + Antenna Factor + AMP
2. If Peak Result complies with AV limit, AV Result is deemed to comply with AV limit.
3. Test setup: RBW: 1 MHz, VBW: 3 MHz, Sweep time: auto.

TR-4-E-009 Radiated Emission Test Result

Test Date: 2023-07-13 **Tested By:** Liaowanrong
EUT: 2.0 Soundbar System **Model Number:** SV200M-0808
Test Mode: Tx Mode **Power Supply:** AC 120V/60Hz
Condition: Temp:23.2°C;Humi:64.6% **Test Site:** DDT 3# Chamber
File Path: d:\ts\2023 report data\Q23070309-2E SV200\FCC ABOVE 1G\19
Memo: BLE 2M 2440

Test Graph

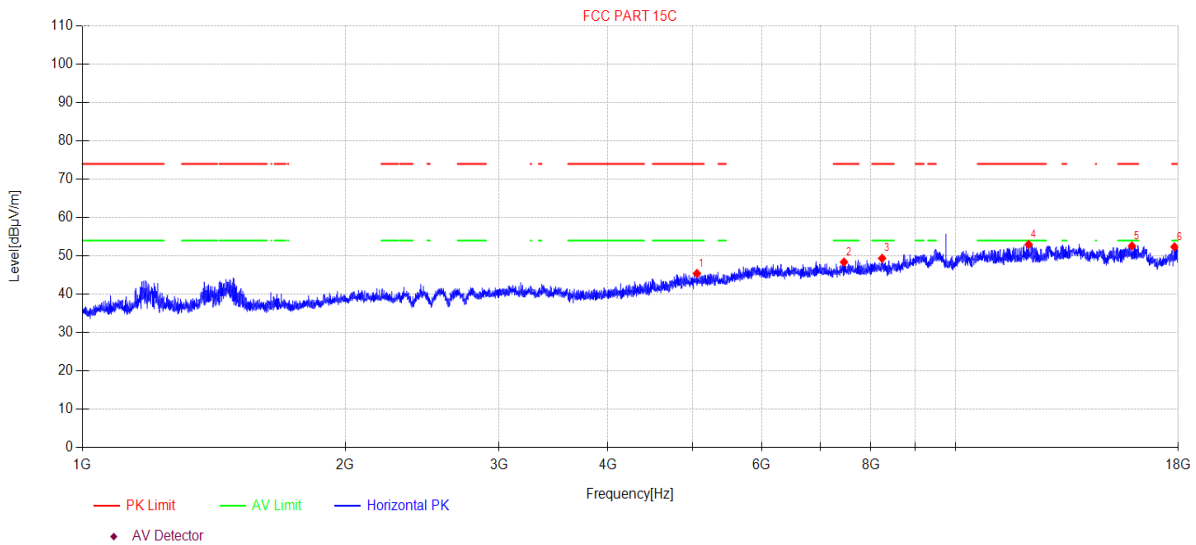

Suspected Data List										
N O.	Freq. [MHz]	Reading [dBµV/m]	Cable loss [dB]	Antenna Factor [dB]	AMP [dB]	Level [dBµV/m]	Limit [dBµV/m]	Margin [dB]	Detector	Polarity
1	5056.92	45.65	7.95	32.90	-41.08	45.42	74.00	28.58	PK	Horizontal
2	7452.93	45.26	7.64	36.49	-41.00	48.39	74.00	25.61	PK	Horizontal
3	8241.50	44.96	7.93	37.10	-40.61	49.38	74.00	24.62	PK	Horizontal
4	12128.84	42.36	10.54	39.10	-39.03	52.97	74.00	21.03	PK	Horizontal
5	15928.68	39.35	15.56	38.04	-40.35	52.60	74.00	21.40	PK	Horizontal
6	17818.84	39.45	12.91	40.63	-40.63	52.36	74.00	21.64	PK	Horizontal

Note:

1. Level = Reading + Cable loss + Antenna Factor + AMP
2. If Peak Result complies with AV limit, AV Result is deemed to comply with AV limit.
3. Test setup: RBW: 1 MHz, VBW: 3 MHz, Sweep time: auto.

TR-4-E-009 Radiated Emission Test Result

Test Date: 2023-07-13 **Tested By:** Liaowanrong
EUT: 2.0 Soundbar System **Model Number:** SV200M-0808
Test Mode: Tx Mode **Power Supply:** AC 120V/60Hz
Condition: Temp:23.2°C;Humi:64.6% **Test Site:** DDT 3# Chamber
File Path: d:\ts\2023 report data\Q23070309-2E SV200\FCC ABOVE 1G\20
Memo: BLE 2M 2440

Test Graph

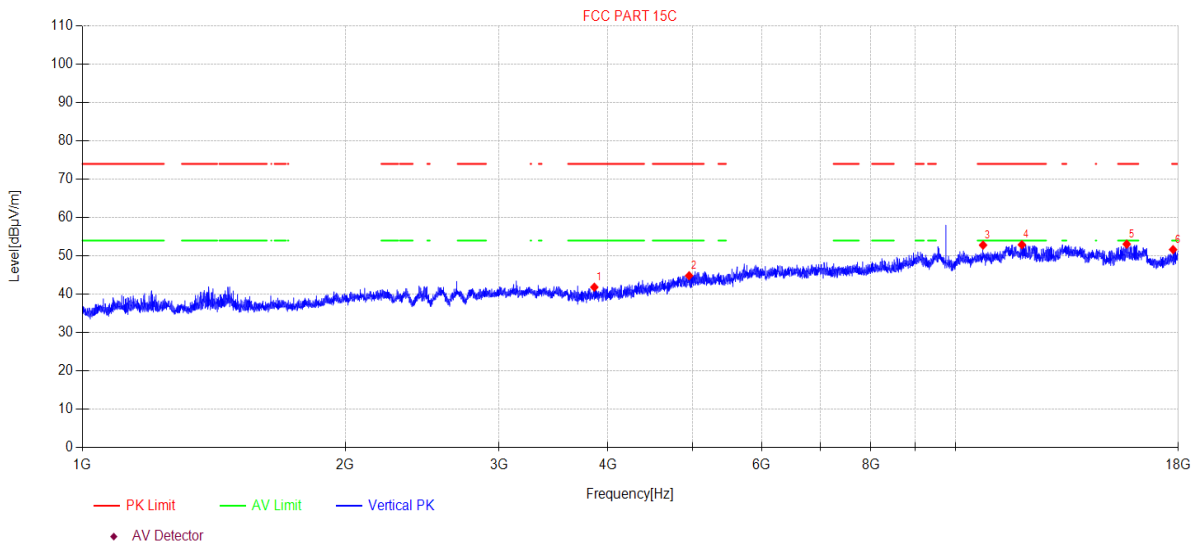

Suspected Data List										
N O.	Freq. [MHz]	Reading [dBµV/m]	Cable loss [dB]	Antenna Factor [dB]	AMP [dB]	Level [dBµV/m]	Limit [dBµV/m]	Margin [dB]	Detector	Polarity
1	3858.38	46.94	5.82	30.42	-41.32	41.86	74.00	32.14	PK	Vertical
2	4954.22	45.37	7.78	32.80	-41.11	44.84	74.00	29.16	PK	Vertical
3	10754.87	44.75	9.48	39.10	-40.52	52.81	74.00	21.19	PK	Vertical
4	11913.45	42.69	10.46	38.81	-39.04	52.92	74.00	21.08	PK	Vertical
5	15709.24	40.42	14.56	38.29	-40.20	53.07	74.00	20.93	PK	Vertical
6	17752.02	39.26	12.83	40.16	-40.60	51.65	74.00	22.35	PK	Vertical

Note:

1. Level = Reading + Cable loss + Antenna Factor + AMP
2. If Peak Result complies with AV limit, AV Result is deemed to comply with AV limit.
3. Test setup: RBW: 1 MHz, VBW: 3 MHz, Sweep time: auto.

TR-4-E-009 Radiated Emission Test Result

Test Date: 2023-07-13 **Tested By:** Liaowanrong
EUT: 2.0 Soundbar System **Model Number:** SV200M-0808
Test Mode: Tx Mode **Power Supply:** AC 120V/60Hz
Condition: Temp:23.2°C;Humi:64.6% **Test Site:** DDT 3# Chamber
File Path: d:\ts\2023 report data\Q23070309-2E SV200\FCC ABOVE 1G\21
Memo: BLE 2M 2480

Test Graph

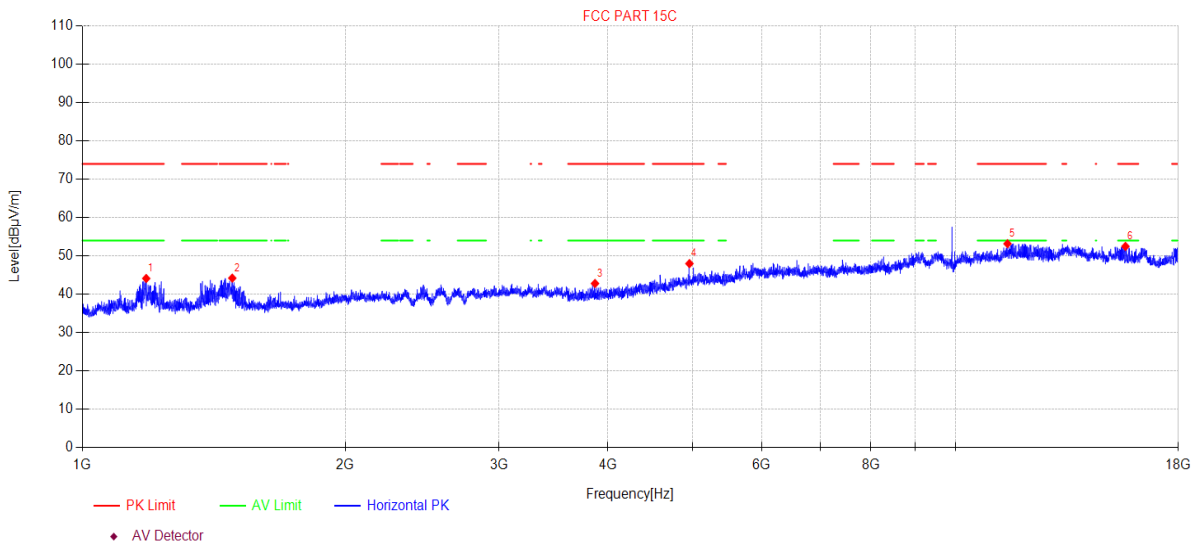

Suspected Data List										
N O.	Freq. [MHz]	Reading [dBµV/m]	Cable loss [dB]	Antenna Factor [dB]	AMP [dB]	Level [dBµV/m]	Limit [dBµV/m]	Margin [dB]	Detector	Polarity
1	1183.52	53.50	3.50	25.60	-38.48	44.12	74.00	29.88	PK	Horizontal
2	1484.92	53.16	4.45	25.53	-38.93	44.21	74.00	29.79	PK	Horizontal
3	3865.07	47.88	5.82	30.43	-41.32	42.81	74.00	31.19	PK	Horizontal
4	4958.51	48.52	7.79	32.80	-41.11	48.00	74.00	26.00	PK	Horizontal
5	11470.84	43.82	10.07	39.03	-39.75	53.17	74.00	20.83	PK	Horizontal
6	15654.85	39.97	14.32	38.35	-40.16	52.48	74.00	21.52	PK	Horizontal

Note:

1. Level = Reading + Cable loss + Antenna Factor + AMP
2. If Peak Result complies with AV limit, AV Result is deemed to comply with AV limit.
3. Test setup: RBW: 1 MHz, VBW: 3 MHz, Sweep time: auto.

TR-4-E-009 Radiated Emission Test Result

Test Date: 2023-07-13 **Tested By:** Liaowanrong
EUT: 2.0 Soundbar System **Model Number:** SV200M-0808
Test Mode: Tx Mode **Power Supply:** AC 120V/60Hz
Condition: Temp:23.2°C;Humi:64.6% **Test Site:** DDT 3# Chamber
File Path: d:\ts\2023 report data\Q23070309-2E SV200\FCC ABOVE 1G\22
Memo: BLE 2M 2480

Test Graph

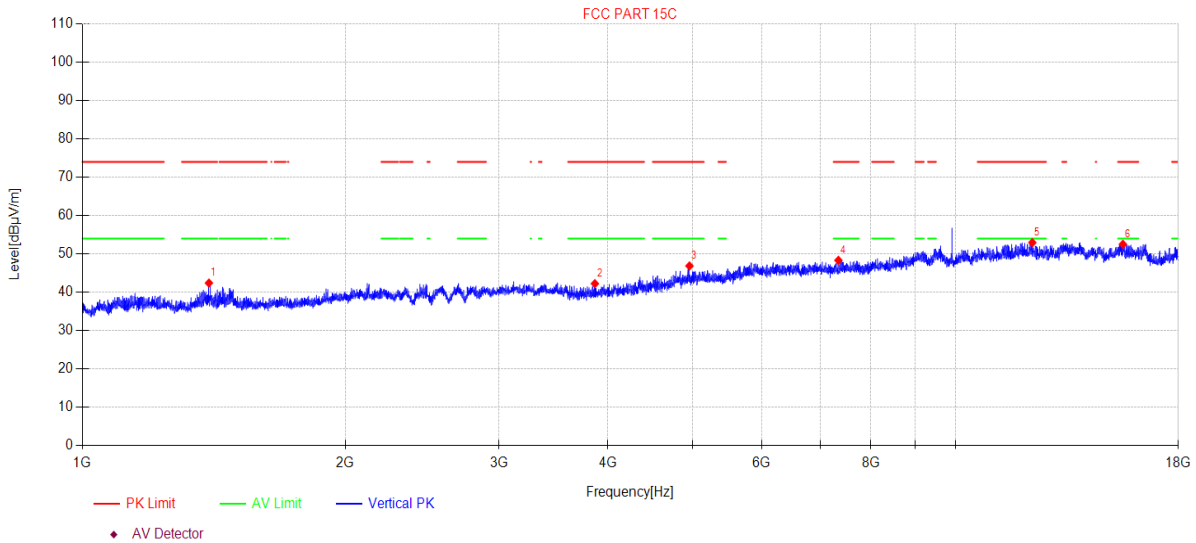

Suspected Data List										
N O.	Freq. [MHz]	Reading [dBµV/m]	Cable loss [dB]	Antenna Factor [dB]	AMP [dB]	Level [dBµV/m]	Limit [dBµV/m]	Margin [dB]	Detector	Polarity
1	1396.27	51.43	4.17	25.60	-38.79	42.41	74.00	31.59	PK	Vertical
2	3863.96	47.32	5.82	30.43	-41.32	42.25	74.00	31.75	PK	Vertical
3	4958.51	47.38	7.79	32.80	-41.11	46.86	74.00	27.14	PK	Vertical
4	7343.89	45.21	7.63	36.50	-41.00	48.34	74.00	25.66	PK	Vertical
5	12248.61	42.47	10.54	39.10	-39.15	52.96	74.00	21.04	PK	Vertical
6	15551.13	40.27	13.85	38.50	-40.09	52.53	74.00	21.47	PK	Vertical

Note:

- Level = Reading + Cable loss + Antenna Factor + AMP
- If Peak Result complies with AV limit, AV Result is deemed to comply with AV limit.
- Test setup: RBW: 1 MHz, VBW: 3 MHz, Sweep time: auto.

12. Emissions in Restricted Frequency Bands

12.1. Block diagram of test setup

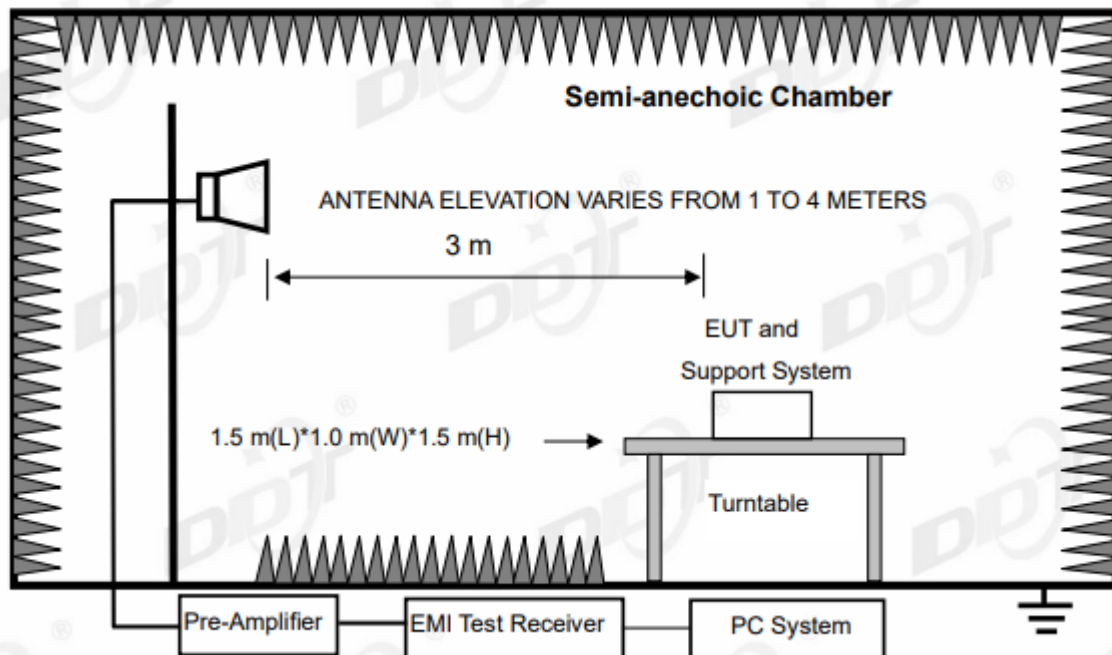

12.2. Limit

All restriction band should comply with 15.209 limits, other emission should be at least 20 dB below the fundamental.

12.3. Test procedure

Same with Radiated Emission except change investigated frequency range from 2310 MHz to 2410 MHz and 2475 MHz to 2500 MHz.

Remark: All restriction band have been tested, and only the worst case is shown in report.

12.4. Test result

Pass. (See below detailed test result)

TR-4-E-009 Radiated Emission Test Result

Test Date: 2023-07-13 **Tested By:** Liaowanrong
EUT: 2.0 Soundbar System **Model Number:** SV200M-0808
Test Mode: Tx Mode **Power Supply:** AC 120V/60Hz
Condition: Temp:23.2°C;Humi:64.6% **Test Site:** DDT 3# Chamber
File Path: d:\ts\2023 report data\Q23070309-2E SV200\FCC ABOVE 1G\31
Memo: BLE 1M 2402

Test Graph

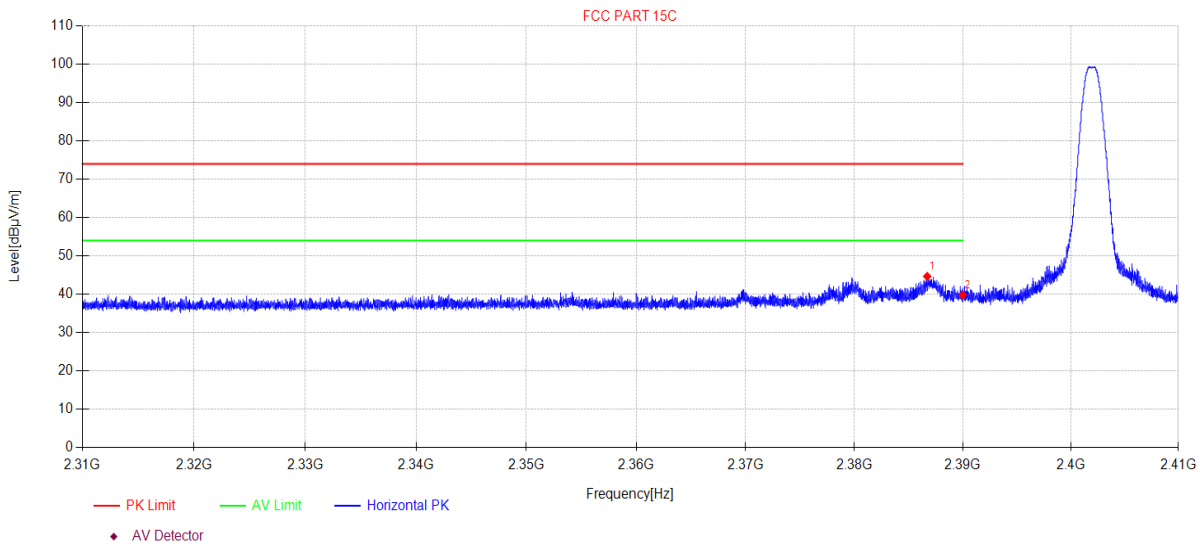

Suspected Data List										
NO	Freq. [MHz]	Reading [dBμV/m]	Cable loss [dB]	Antenna Factor [dB]	AMP [dB]	Level [dBμV/m]	Limit [dBμV/m]	Margin [dB]	Detector	Polarity
1	2386.71	53.46	3.86	27.47	-40.13	44.66	74.00	29.34	PK	Horizontal
2	2390.00	48.60	3.87	27.48	-40.13	39.82	74.00	34.18	PK	Horizontal

Note:

1. Level = Reading + Cable loss + Antenna Factor + AMP
2. If Peak Result complies with AV limit, AV Result is deemed to comply with AV limit.
3. Test setup: RBW: 1 MHz, VBW: 3 MHz, Sweep time: auto.

TR-4-E-009 Radiated Emission Test Result

Test Date: 2023-07-13 **Tested By:** Liaowanrong
EUT: 2.0 Soundbar System **Model Number:** SV200M-0808
Test Mode: Tx Mode **Power Supply:** AC 120V/60Hz
Condition: Temp:23.2°C;Humi:64.6% **Test Site:** DDT 3# Chamber
File Path: d:\ts\2023 report data\Q23070309-2E SV200\FCC ABOVE 1G\32
Memo: BLE 1M 2402

Test Graph

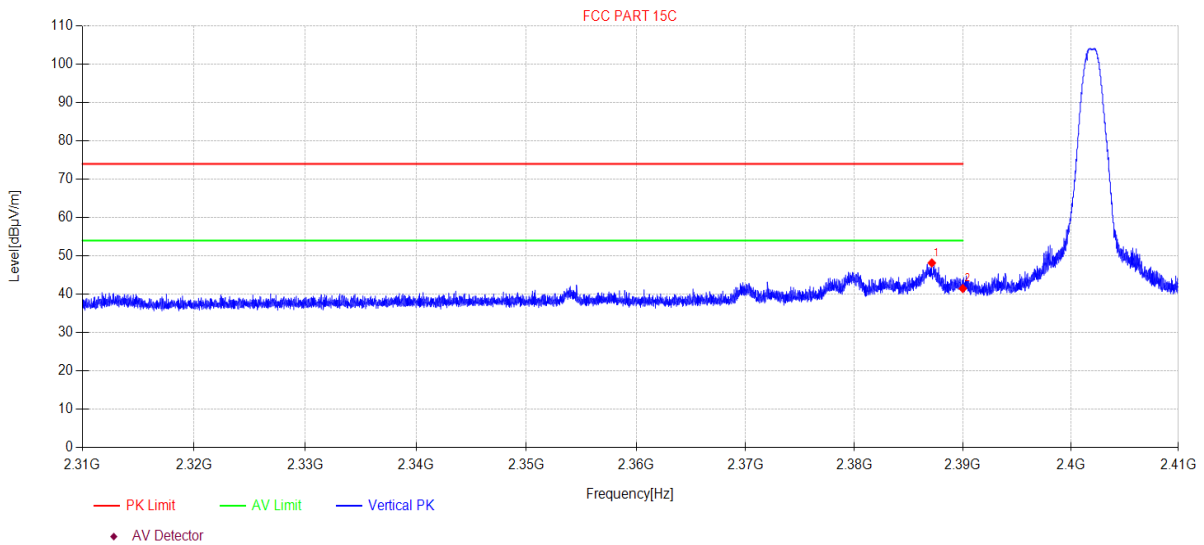

Suspected Data List										
NO	Freq. [MHz]	Reading [dBµV/m]	Cable loss [dB]	Antenna Factor [dB]	AMP [dB]	Level [dBµV/m]	Limit [dBµV/m]	Margin [dB]	Detector	Polarity
1	2387.14	56.97	3.86	27.47	-40.13	48.17	74.00	25.83	PK	Vertical
2	2390.00	50.28	3.87	27.48	-40.13	41.50	74.00	32.50	PK	Vertical

Note:

1. Level = Reading + Cable loss + Antenna Factor + AMP
2. If Peak Result complies with AV limit, AV Result is deemed to comply with AV limit.
3. Test setup: RBW: 1 MHz, VBW: 3 MHz, Sweep time: auto.

TR-4-E-009 Radiated Emission Test Result

Test Date: 2023-07-13 **Tested By:** Liaowanrong
EUT: 2.0 Soundbar System **Model Number:** SV200M-0808
Test Mode: Tx Mode **Power Supply:** AC 120V/60Hz
Condition: Temp:23.2°C;Humi:64.6% **Test Site:** DDT 3# Chamber
File Path: d:\ts\2023 report data\Q23070309-2E SV200\FCC ABOVE 1G\33
Memo: BLE 2M 2402

Test Graph

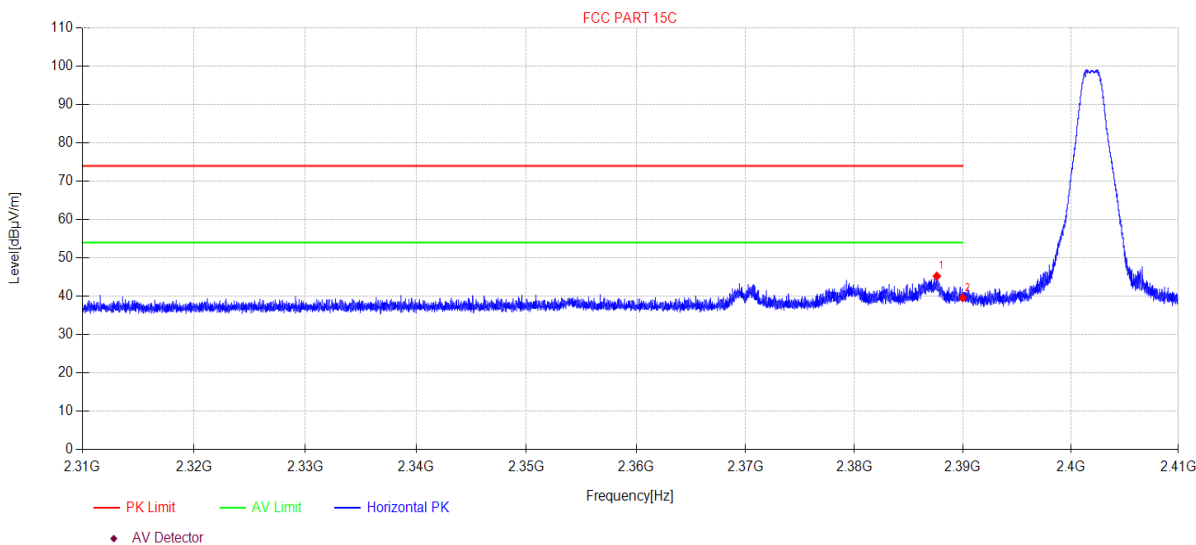

Suspected Data List										
NO	Freq. [MHz]	Reading [dBµV/m]	Cable loss [dB]	Antenna Factor [dB]	AMP [dB]	Level [dBµV/m]	Limit [dBµV/m]	Margin [dB]	Detector	Polarity
1	2387.60	54.04	3.86	27.48	-40.13	45.25	74.00	28.75	PK	Horizontal
2	2390.00	48.39	3.87	27.48	-40.13	39.61	74.00	34.39	PK	Horizontal

Note:

1. Level = Reading + Cable loss + Antenna Factor + AMP
2. If Peak Result complies with AV limit, AV Result is deemed to comply with AV limit.
3. Test setup: RBW: 1 MHz, VBW: 3 MHz, Sweep time: auto.

TR-4-E-009 Radiated Emission Test Result

Test Date: 2023-07-13 **Tested By:** Liaowanrong
EUT: 2.0 Soundbar System **Model Number:** SV200M-0808
Test Mode: Tx Mode **Power Supply:** AC 120V/60Hz
Condition: Temp:23.2°C;Humi:64.6% **Test Site:** DDT 3# Chamber
File Path: d:\ts\2023 report data\Q23070309-2E SV200\FCC ABOVE 1G\34
Memo: BLE 2M 2402

Test Graph

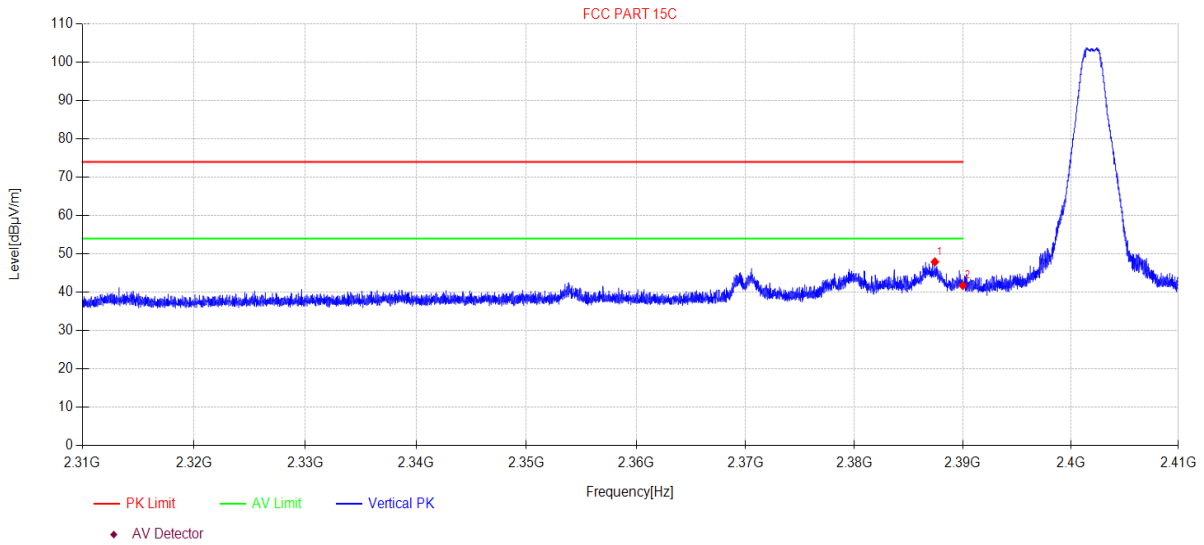

Suspected Data List										
NO	Freq. [MHz]	Reading [dBµV/m]	Cable loss [dB]	Antenna Factor [dB]	AMP [dB]	Level [dBµV/m]	Limit [dBµV/m]	Margin [dB]	Detector	Polarity
1	2387.42	56.72	3.86	27.47	-40.13	47.92	74.00	26.08	PK	Vertical
2	2390.00	50.54	3.87	27.48	-40.13	41.76	74.00	32.24	PK	Vertical

Note:

- Level = Reading + Cable loss + Antenna Factor + AMP
- If Peak Result complies with AV limit, AV Result is deemed to comply with AV limit.
- Test setup: RBW: 1 MHz, VBW: 3 MHz, Sweep time: auto.

TR-4-E-009 Radiated Emission Test Result

Test Date: 2023-07-13 **Tested By:** Liaowanrong
EUT: 2.0 Soundbar System **Model Number:** SV200M-0808
Test Mode: Tx Mode **Power Supply:** AC 120V/60Hz
Condition: Temp:23.2°C;Humi:64.6% **Test Site:** DDT 3# Chamber
File Path: d:\ts\2023 report data\Q23070309-2E SV200\FCC ABOVE 1G\41
Memo: BLE 1M 2480

Test Graph

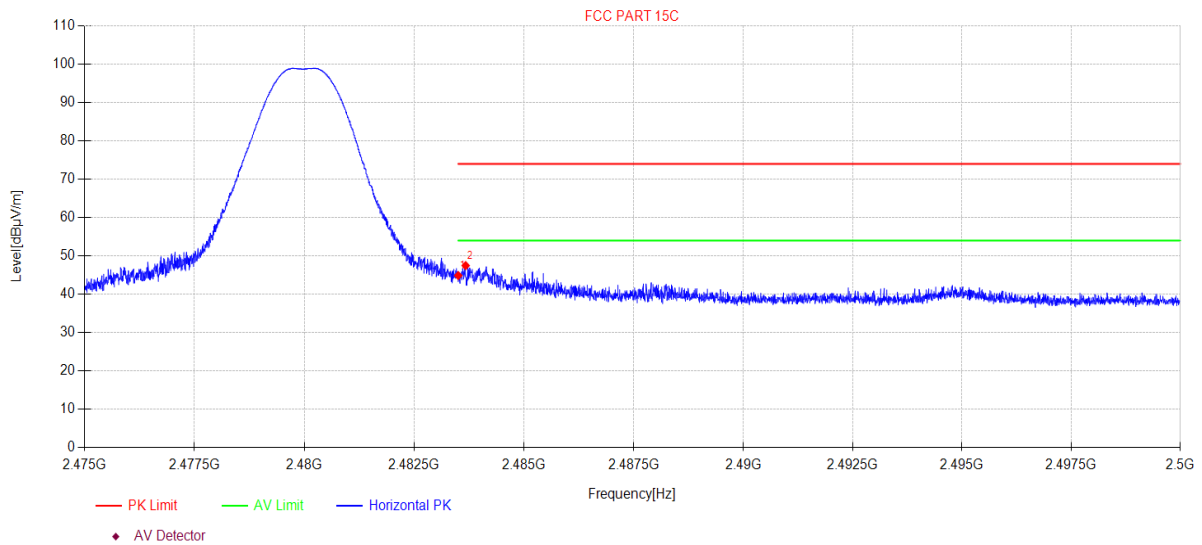

Suspected Data List										
NO	Freq. [MHz]	Reading [dBμV/m]	Cable loss [dB]	Antenna Factor [dB]	AMP [dB]	Level [dBμV/m]	Limit [dBμV/m]	Margin [dB]	Detector	Polarity
1	2483.50	53.45	3.94	27.73	-40.23	44.89	74.00	29.11	PK	Horizontal
2	2483.67	56.04	3.94	27.73	-40.23	47.48	74.00	26.52	PK	Horizontal

Note:

1. Level = Reading + Cable loss + Antenna Factor + AMP
2. If Peak Result complies with AV limit, AV Result is deemed to comply with AV limit.
3. Test setup: RBW: 1 MHz, VBW: 3 MHz, Sweep time: auto.

TR-4-E-009 Radiated Emission Test Result

Test Date: 2023-07-13 **Tested By:** Liaowanrong
EUT: 2.0 Soundbar System **Model Number:** SV200M-0808
Test Mode: Tx Mode **Power Supply:** AC 120V/60Hz
Condition: Temp:23.2°C;Humi:64.6% **Test Site:** DDT 3# Chamber
File Path: d:\ts\2023 report data\Q23070309-2E SV200\FCC ABOVE 1G\42
Memo: BLE 1M 2480

Test Graph

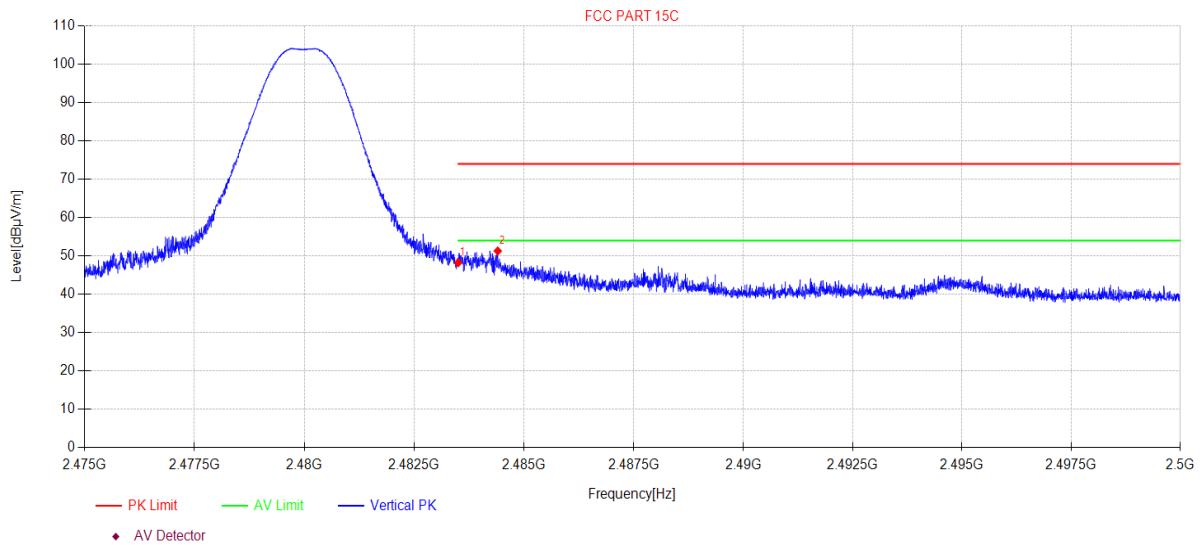

Suspected Data List										
NO	Freq. [MHz]	Reading [dBµV/m]	Cable loss [dB]	Antenna Factor [dB]	AMP [dB]	Level [dBµV/m]	Limit [dBµV/m]	Margin [dB]	Detector	Polarity
1	2483.50	56.81	3.94	27.73	-40.23	48.25	74.00	25.75	PK	Vertical
2	2484.40	59.83	3.94	27.74	-40.23	51.28	74.00	22.72	PK	Vertical

Note:

1. Level = Reading + Cable loss + Antenna Factor + AMP
2. If Peak Result complies with AV limit, AV Result is deemed to comply with AV limit.
3. Test setup: RBW: 1 MHz, VBW: 3 MHz, Sweep time: auto.

TR-4-E-009 Radiated Emission Test Result

Test Date: 2023-07-14 **Tested By:** Liaowanrong
EUT: 2.0 Soundbar System **Model Number:** SV200M-0808
Test Mode: Tx Mode **Power Supply:** AC 120V/60Hz
Condition: Temp:23.2°C;Humi:64.6% **Test Site:** DDT 3# Chamber
File Path: d:\ts\2023 report data\Q23070309-2E SV200\FCC ABOVE 1G\43
Memo: BLE 2M 2480

Test Graph

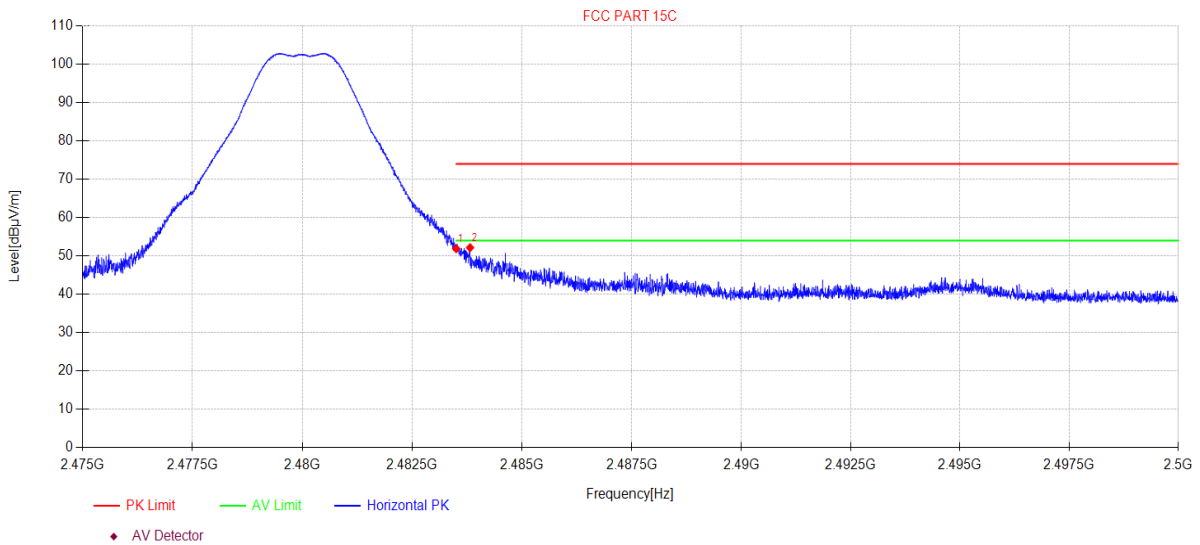

Suspected Data List										
NO	Freq. [MHz]	Reading [dBμV/m]	Cable loss [dB]	Antenna Factor [dB]	AMP [dB]	Level [dBμV/m]	Limit [dBμV/m]	Margin [dB]	Detector	Polarity
1	2483.50	60.44	3.94	27.73	-40.23	51.88	74.00	22.12	PK	Horizontal
2	2483.82	60.69	3.94	27.74	-40.23	52.14	74.00	21.86	PK	Horizontal

Note:

1. Level = Reading + Cable loss + Antenna Factor + AMP
2. If Peak Result complies with AV limit, AV Result is deemed to comply with AV limit.
3. Test setup: RBW: 1 MHz, VBW: 3 MHz, Sweep time: auto.

TR-4-E-009 Radiated Emission Test Result

Test Date: 2023-07-14 **Tested By:** Liaowanrong
EUT: 2.0 Soundbar System **Model Number:** SV200M-0808
Test Mode: Tx Mode **Power Supply:** AC 120V/60Hz
Condition: Temp:23.2°C;Humi:64.6% **Test Site:** DDT 3# Chamber
File Path: d:\ts\2023 report data\Q23070309-2E SV200\FCC ABOVE 1G\44
Memo: BLE 2M 2480

Test Graph

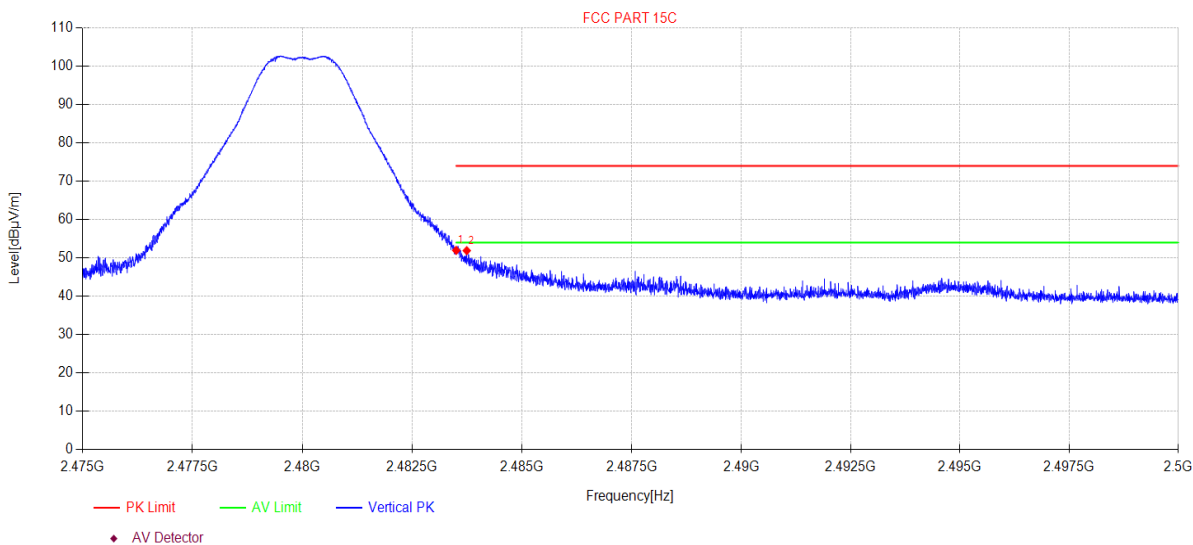

Suspected Data List										
NO	Freq. [MHz]	Reading [dBµV/m]	Cable loss [dB]	Antenna Factor [dB]	AMP [dB]	Level [dBµV/m]	Limit [dBµV/m]	Margin [dB]	Detector	Polarity
1	2483.50	60.52	3.94	27.73	-40.23	51.96	74.00	22.04	PK	Vertical
2	2483.74	60.46	3.94	27.73	-40.23	51.90	74.00	22.10	PK	Vertical

Note:

1. Level = Reading + Cable loss + Antenna Factor + AMP
2. If Peak Result complies with AV limit, AV Result is deemed to comply with AV limit.
3. Test setup: RBW: 1 MHz, VBW: 3 MHz, Sweep time: auto.

13. Power Line Conducted Emission

13.1. Block diagram of test setup

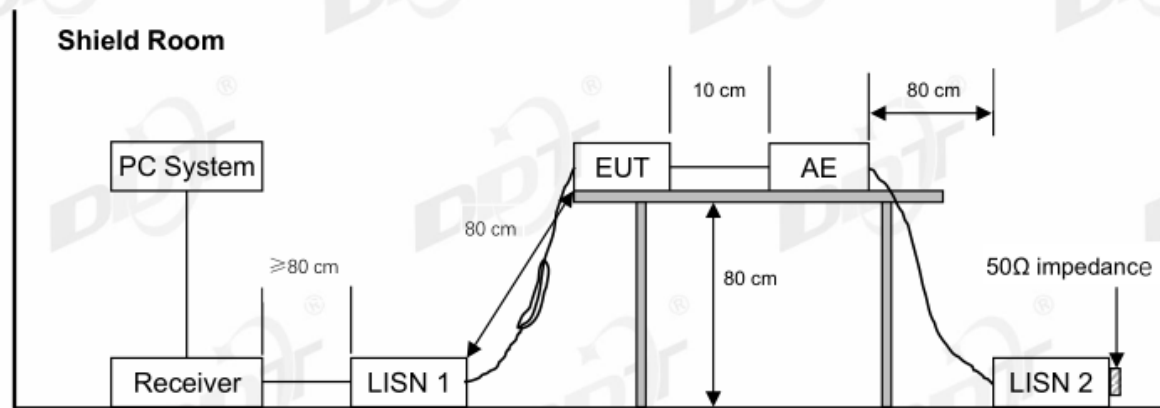

13.2. Power line conducted emission limits

Frequency	Quasi-Peak Level dB(μ V)	Average Level dB(μ V)
150 kHz ~ 500 kHz	66 ~ 56*	56 ~ 46*
500 kHz ~ 5 MHz	56	46
5 MHz ~ 30 MHz	60	50

Note 1: * Decreasing linearly with logarithm of frequency.

Note 2: The lower limit shall apply at the transition frequencies.

13.3. Test procedure

The EUT and Support equipment, if needed, were put placed on a non-metallic table, 80 cm above the ground plane.

All support equipment power received from a second LISN.

Emissions were measured on each current carrying line of the EUT using an EMI Test Receiver connected to the LISN powering the EUT.

The Receiver scanned from 150 kHz to 30 MHz for emissions in each of the test modes.

During the above scans, the emissions were maximized by cable manipulation.

The test mode(s) described in clause 2.4 were scanned during the preliminary test.

After the preliminary scan, we found the test mode producing the highest emission level.

The EUT configuration and worse cable configuration of the above highest emission levels were recorded for reference of the final test.

EUT and support equipment were set up on the test bench as per the configuration with highest emission level in the preliminary test.

A scan was taken on both power lines, Neutral and Line, recording at least the six highest emissions.

Emission frequency and amplitude were recorded into a computer in which correction factors were used to calculate the emission level and compare reading to the applicable limit.

The test data of the worst-case condition(s) was recorded.

The bandwidth of test receiver is set at 9 kHz.

13.4. Test result

Pass. (See below detailed test result)

Note1: All emissions not reported below are too low against the prescribed limits.

Note2: "----" means Peak detection; "----" means Average detection.

Note3: Pre-test AC conducted emission at both voltage AC 120V/60Hz and AC 240V/50Hz, recorded worse case.

TR-4-E-010 Conducted Emission Test Result

Test Site : DDT 1# Shield Room D:\2023 CE report data\Q23070309-2E V200\FCC CE.EM6
Test Date : 2023-07-13 **Tested By** : Bairong
EUT : 2.0 Soundbar System **Model Number** : SV200M-0808
Power Supply : AC 120V/60Hz **Test Mode** : TX mode
Condition : TEMP:24.3°C, RH:60.4% **LISN** : 2022 1# ENV216/NEUTRAL
Memo : BLE 1M

Data: 6

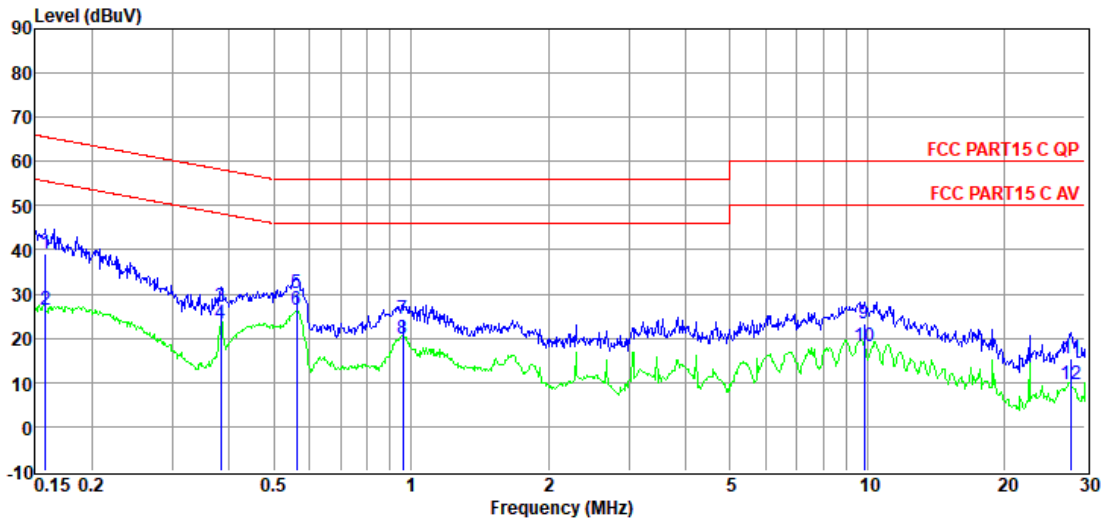

Item (Mark)	Freq. (MHz)	Read Level (dBμV)	LISN Factor (dB)	Cable Loss (dB)	Pulse Limiter Factor (dB)	Result Level (dBμV)	Limit Line (dBμV)	Over Limit (dB)	Detector	Phase
1	0.16	19.27	9.82	0.01	9.93	39.03	65.56	-26.53	QP	NEUTRAL
2	0.16	6.66	9.82	0.01	9.93	26.42	55.56	-29.14	Average	NEUTRAL
3	0.38	7.67	9.69	0.01	9.91	27.28	58.21	-30.93	QP	NEUTRAL
4	0.38	3.82	9.69	0.01	9.91	23.43	48.21	-24.78	Average	NEUTRAL
5	0.56	10.75	9.67	0.01	9.92	30.35	56.00	-25.65	QP	NEUTRAL
6	0.56	6.68	9.67	0.01	9.92	26.28	46.00	-19.72	Average	NEUTRAL
7	0.96	4.66	9.71	0.02	9.91	24.30	56.00	-31.70	QP	NEUTRAL
8	0.96	0.34	9.71	0.02	9.91	19.98	46.00	-26.02	Average	NEUTRAL
9	9.86	3.41	9.79	0.09	9.96	23.25	60.00	-36.75	QP	NEUTRAL
10	9.86	-1.68	9.79	0.09	9.96	18.16	50.00	-31.84	Average	NEUTRAL
11	28.00	-4.57	9.80	0.16	10.00	15.39	60.00	-44.61	QP	NEUTRAL
12	28.00	-10.37	9.80	0.16	10.00	9.59	50.00	-40.41	Average	NEUTRAL

Note:

1. Result Level = Read Level + LISN Factor + Pulse Limiter Factor + Cable loss.
2. If QP Result complies with AV limit, AV Result is deemed to comply with AV limit.
3. Test setup: RBW: 200 Hz (9 kHz—150 kHz), 9 kHz (150 kHz—30 MHz).
4. Step size: 80Hz (0.009MHz-0.15MHz), 4 kHz (0.15MHz-30MHz), Scan time: auto.

TR-4-E-010 Conducted Emission Test Result

Test Site : DDT 1# Shield Room D:\2023 CE report data\Q23070309-2E V200\FCC CE.EM6
Test Date : 2023-07-13 **Tested By** : Bairong
EUT : 2.0 Soundbar System **Model Number** : SV200M-0808
Power Supply : AC 120V/60Hz **Test Mode** : TX mode
Condition : TEMP:24.3°C, RH:60.4% **LISN** : 2022 1# ENV216/LINE
Memo : BLE 1M

Data: 8

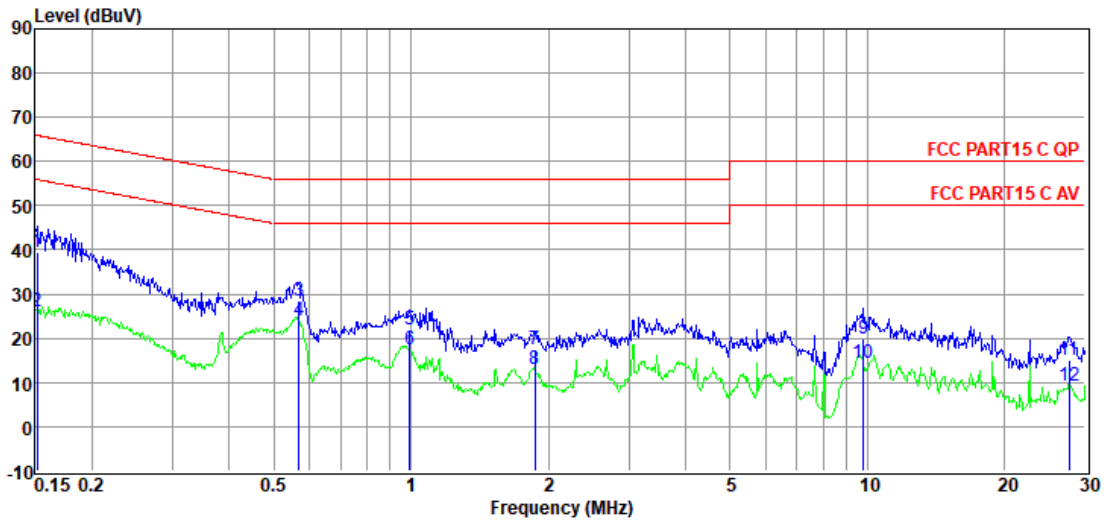

Item (Mark)	Freq. (MHz)	Read Level (dBuV)	LISN Factor (dB)	Cable Loss (dB)	Pulse Limiter Factor (dB)	Result Level (dBuV)	Limit Line (dBuV)	Over Limit (dB)	Detector	Phase
1	0.15	19.85	9.61	0.01	9.94	39.41	65.91	-26.50	QP	LINE
2	0.15	6.64	9.61	0.01	9.94	26.20	55.91	-29.71	Average	LINE
3	0.57	8.87	9.66	0.01	9.92	28.46	56.00	-27.54	QP	LINE
4	0.57	4.58	9.66	0.01	9.92	24.17	46.00	-21.83	Average	LINE
5	0.99	2.57	9.50	0.02	9.91	22.00	56.00	-34.00	QP	LINE
6	0.99	-1.95	9.50	0.02	9.91	17.48	46.00	-28.52	Average	LINE
7	1.87	-2.02	9.59	0.03	9.90	17.50	56.00	-38.50	QP	LINE
8	1.87	-6.58	9.59	0.03	9.90	12.94	46.00	-33.06	Average	LINE
9	9.81	0.24	9.51	0.09	9.96	19.80	60.00	-40.20	QP	LINE
10	9.81	-5.02	9.51	0.09	9.96	14.54	50.00	-35.46	Average	LINE
11	27.71	-4.77	9.66	0.16	10.00	15.05	60.00	-44.95	QP	LINE
12	27.71	-10.74	9.66	0.16	10.00	9.08	50.00	-40.92	Average	LINE

Note:

1. Result Level = Read Level + LISN Factor + Pulse Limiter Factor + Cable loss.
2. If QP Result complies with AV limit, AV Result is deemed to comply with AV limit.
3. Test setup: RBW: 200 Hz (9 kHz—150 kHz), 9 kHz (150 kHz—30 MHz).
4. Step size: 80Hz (0.009MHz-0.15MHz), 4 kHz (0.15MHz-30MHz), Scan time: auto.

TR-4-E-010 Conducted Emission Test Result

Test Site : DDT 1# Shield Room D:\2023 CE report data\Q23070309-2E V200\FCC CE.EM6
Test Date : 2023-07-13 **Tested By** : Bairong
EUT : 2.0 Soundbar System **Model Number** : SV200M-0808
Power Supply : AC 120V/60Hz **Test Mode** : TX mode
Condition : TEMP:24.3°C, RH:60.4% **LISN** : 2022 1# ENV216/NEUTRAL
Memo : BLE 2M

Data: 10

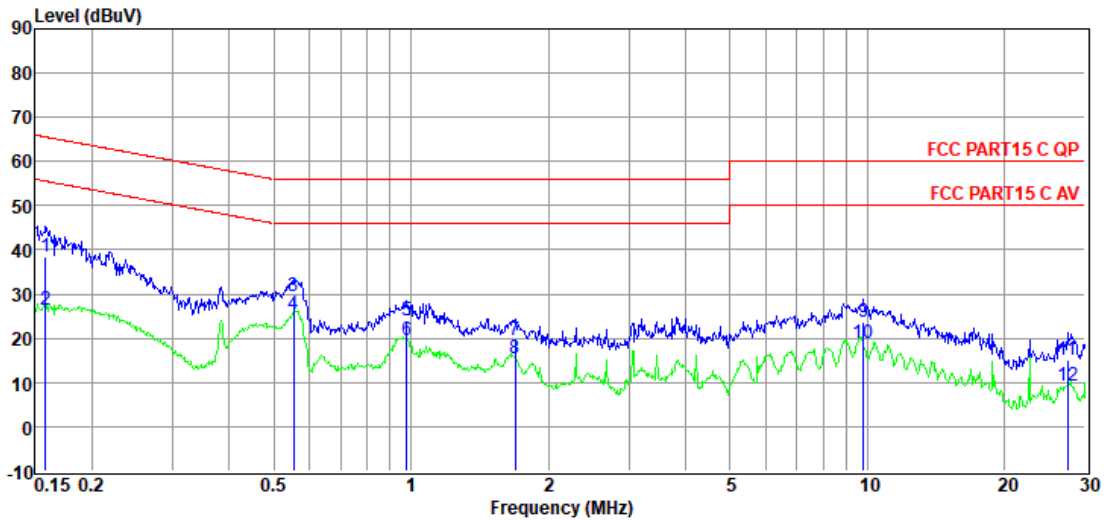

Item	Freq.	Read Level	LISN Factor	Cable Loss	Pulse Limiter Factor	Result Level	Limit Line	Over Limit	Detector	Phase
(Mark)	(MHz)	(dBuV)	(dB)	(dB)	(dB)	(dBuV)	(dBuV)	(dB)		
1	0.16	18.72	9.82	0.01	9.93	38.48	65.56	-27.08	QP	NEUTRAL
2	0.16	6.69	9.82	0.01	9.93	26.45	55.56	-29.11	Average	NEUTRAL
3	0.55	9.81	9.66	0.01	9.92	29.40	56.00	-26.60	QP	NEUTRAL
4	0.55	5.97	9.66	0.01	9.92	25.56	46.00	-20.44	Average	NEUTRAL
5	0.98	4.44	9.71	0.02	9.91	24.08	56.00	-31.92	QP	NEUTRAL
6	0.98	-0.16	9.71	0.02	9.91	19.48	46.00	-26.52	Average	NEUTRAL
7	1.69	0.07	9.70	0.03	9.90	19.70	56.00	-36.30	QP	NEUTRAL
8	1.69	-4.24	9.70	0.03	9.90	15.39	46.00	-30.61	Average	NEUTRAL
9	9.81	3.72	9.79	0.09	9.96	23.56	60.00	-36.44	QP	NEUTRAL
10	9.81	-1.01	9.79	0.09	9.96	18.83	50.00	-31.17	Average	NEUTRAL
11	27.42	-4.82	9.80	0.16	9.99	15.13	60.00	-44.87	QP	NEUTRAL
12	27.42	-10.60	9.80	0.16	9.99	9.35	50.00	-40.65	Average	NEUTRAL

Note:

1. Result Level = Read Level + LISN Factor + Pulse Limiter Factor + Cable loss.
2. If QP Result complies with AV limit, AV Result is deemed to comply with AV limit.
3. Test setup: RBW: 200 Hz (9 kHz—150 kHz), 9 kHz (150 kHz—30 MHz).
4. Step size: 80Hz (0.009MHz-0.15MHz), 4 kHz (0.15MHz-30MHz), Scan time: auto.

TR-4-E-010 Conducted Emission Test Result

Test Site	: DDT 1# Shield Room	D:\2023 CE report data\Q23070309-2E V200\FCC CE.EM6	
Test Date	: 2023-07-13	Tested By	: Bairong
EUT	: 2.0 Soundbar System	Model Number	: SV200M-0808
Power Supply	: AC 120V/60Hz	Test Mode	: TX mode
Condition	: TEMP:24.3°C, RH:60.4%	LISN	: 2022 1# ENV216/LINE
Memo	: BLE 2M		

Data: 12

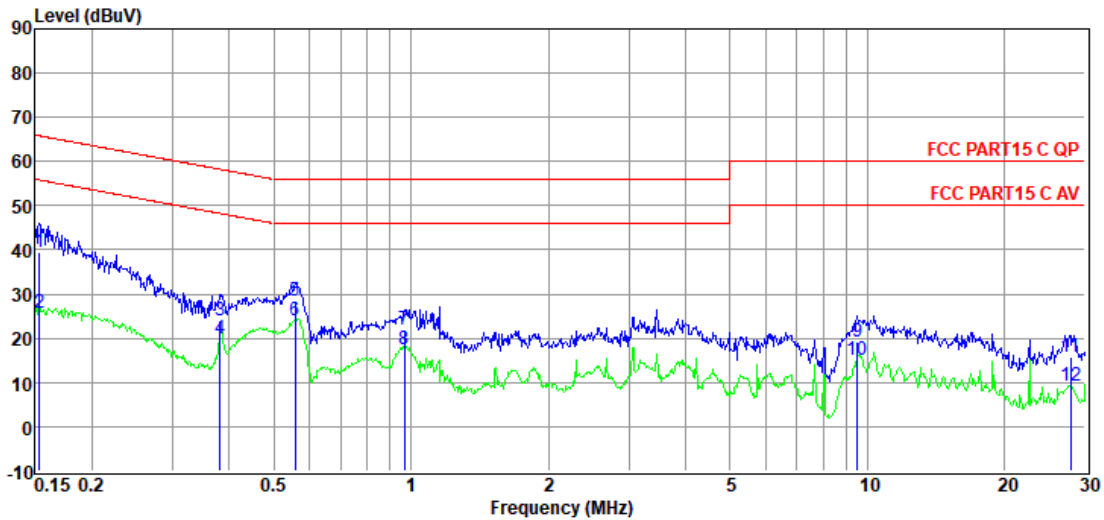

Item (Mark)	Freq. (MHz)	Read Level (dBuV)	LISN Factor (dB)	Cable Loss (dB)	Pulse Limiter Factor (dB)	Result Level (dBuV)	Limit Line (dBuV)	Over Limit (dB)	Detector	Phase
1	0.15	19.79	9.61	0.01	9.94	39.35	65.82	-26.47	QP	LINE
2	0.15	6.28	9.61	0.01	9.94	25.84	55.82	-29.98	Average	LINE
3	0.38	4.52	9.73	0.01	9.91	24.17	58.25	-34.08	QP	LINE
4	0.38	0.12	9.73	0.01	9.91	19.77	48.25	-28.48	Average	LINE
5	0.56	8.88	9.67	0.01	9.92	28.48	56.00	-27.52	QP	LINE
6	0.56	4.59	9.67	0.01	9.92	24.19	46.00	-21.81	Average	LINE
7	0.97	2.49	9.51	0.02	9.91	21.93	56.00	-34.07	QP	LINE
8	0.97	-1.78	9.51	0.02	9.91	17.66	46.00	-28.34	Average	LINE
9	9.50	-0.27	9.51	0.09	9.95	19.28	60.00	-40.72	QP	LINE
10	9.50	-4.50	9.51	0.09	9.95	15.05	50.00	-34.95	Average	LINE
11	27.86	-4.17	9.66	0.16	10.00	15.65	60.00	-44.35	QP	LINE
12	27.86	-10.50	9.66	0.16	10.00	9.32	50.00	-40.68	Average	LINE

Note:

1. Result Level = Read Level + LISN Factor + Pulse Limiter Factor + Cable loss.
2. If QP Result complies with AV limit, AV Result is deemed to comply with AV limit.
3. Test setup: RBW: 200 Hz (9 kHz—150 kHz), 9 kHz (150 kHz—30 MHz).
4. Step size: 80Hz (0.009MHz-0.15MHz), 4 kHz (0.15MHz-30MHz), Scan time: auto.

14. Antenna Requirements

14.1. Limit

For intentional device, according to FCC 47 CFR Section 15.203, an intentional radiator shall be designed to ensure that no antenna other than that furnished by the responsible party shall be used with the device. And according to FCC 47 CFR Section 15.247 (b), if transmitting antennas of directional gain greater than 6 dBi are used, the power shall be reduced by the amount in dB that the directional gain of the antenna exceeds 6 dBi.

14.2. Result

The antenna used for this product is PCB antenna and that no antenna other than that furnished by the responsible party shall be used with the device, the maximum peak gain of the transmit antenna is 2.8 dBi.

16. Photos of the EUT

Please refer to appendix I.

END OF REPORT