

# VIZIO

## V-Series™ 2.1 All-in-One User Manual



Scan to  
learn more.

**Model:** V21d-J8

*Please read this guide before using the product.*

# IMPORTANT SAFETY INSTRUCTIONS

Your Unit is designed and manufactured to operate within defined design limits, and misuse may result in electric shock or fire. To prevent your Unit from being damaged, the following rules should be observed for its installation, use, and maintenance. Please read the following safety instructions before operating your Unit. Keep these instructions in a safe place for future reference.

- Read these instructions.
- Keep these instructions.
- Heed all warnings.
- Follow all instructions.
- Do not use this apparatus near water.
- Clean only with a dry cloth.
- Do not block any ventilation openings. Install in accordance with the manufacturer's instructions.
- Do not install near any heat sources such as radiators, heat registers, stoves, or other apparatus (including amplifiers) that produce heat.
- Do not defeat the safety purpose of the polarized or grounding-type plug. A polarized plug has two blades with one wider than the other. A grounding type plug has two blades and a third grounding prong. The wide blade or the third prong are provided for your safety. If the provided plug does not fit into your outlet, consult an electrician for replacement of the obsolete outlet.
- Protect the power cord from being walked on or pinched, particularly at plugs, convenience receptacles, and the point where they exit from the apparatus.
- Only use attachments/accessories specified by the manufacturer.
- Use only with the cart, stand, tripod, bracket, or table specified by the manufacturer, or sold with the apparatus. When a cart is used, use caution when moving the cart/apparatus combination to avoid injury from tip-over.
- Unplug this apparatus during lightning storms or when unused for long periods of time.
- Refer all servicing to qualified service personnel. Servicing is required when the apparatus has been damaged in any way, such as when the power supply cord or plug is dropped, liquid has been spilled or objects have fallen into the apparatus, the apparatus has been exposed to rain or moisture, does not operate normally, or has been dropped.
- To reduce the risk of electric shock or component damage, switch off the power before connecting other components to your Unit.
- Unplug the power cord before cleaning your Unit. A damp cloth is sufficient for cleaning. Do not use a liquid or a spray cleaner on your Unit. Do not use abrasive cleaners.
- Always use the accessories recommended by the manufacturer to insure compatibility.
- When moving your Unit from an area of low temperature to an area of high temperature, condensation may form in the housing. Wait before turning on your Unit to avoid causing fire, electric shock, or component damage.
- Slots and openings in the back and bottom of the cabinet are provided for ventilation. To ensure reliable operation of your Unit and to protect it from overheating, be sure these openings are not blocked or covered. Do not place your Unit in a bookcase or cabinet unless proper ventilation is provided.
- Never push any object into the slots and openings on your Unit enclosure. Do not place any objects on the top of your Unit. Doing so could short circuit parts causing a fire or electric shock. Never spill liquids on your Unit.
- Do not block the subwoofer ports. Allow for 1-2 inches of space around all sides for ventilation.
- **WARNING:** Exposure to loud sounds can damage your hearing causing hearing loss and tinnitus (ringing or buzzing in the ears). With continued exposure to loud noises, ears may become accustomed to the sound level, which may result in permanent damage to hearing without any noticeable discomfort.
- When connected to a power outlet, power is always flowing into your Unit. To totally disconnect power, unplug the power cord.
- Do not overload power strips and extension cords. Overloading can result in fire or electric shock.



- The wall socket should be located near your Unit and be easily accessible
- Keep your Unit away from moisture. Do not expose your Unit to rain or moisture. If water penetrates into your Unit, unplug the power cord and contact your dealer. Continuous use in this case may result in fire or electric shock.
- Do not use your Unit if any abnormality occurs. If any smoke or odor becomes apparent, unplug the power cord and contact your dealer immediately. Do not try to repair your unit yourself.
- Avoid using dropped or damaged appliances. If your Unit is dropped and the housing is damaged, the internal components may function abnormally. Unplug the power cord immediately and contact your dealer for repair. Continued use of your Unit may cause fire or electric shock.
- Do not install your Unit in an area with heavy dust or high humidity. Operating your Unit in environments with heavy dust or high humidity may cause fire or electric shock.
- Ensure that the power cord and any other cables are unplugged before moving your Unit.
- When unplugging your Unit, hold the power plug, not the cord. Pulling on the power cord may damage the wires inside the cord and cause fire or electric shock. When your Unit will not be used for an extended period of time, unplug the power cord.
- To reduce risk of electric shock, do not touch the connector with wet hands.
- Insert the remote control batteries in accordance with instructions. Incorrect polarity may cause the battery to leak which can damage the remote control or injure the operator.
- See the important note and rating located on the back of the unit.
- **WARNING:** This equipment is not waterproof. To prevent a fire or shock hazard, do not place any container filled with liquid near the equipment (such as a vase or flower pot) or expose it to dripping, splashing, rain, or moisture.
- **CAUTION:** Danger of explosion or fire if batteries are mistreated. Replace only with the same or specified type.
- Do not leave the batteries exposed to direct sunlight for a long period of time with doors and windows closed. Do not disassemble the batteries or dispose of it in fire.
- Where the MAINS plug or appliance coupler is used as the disconnect device, the disconnect device shall remain readily operable.
- No naked flame sources, such as lighted candles, should be placed on the apparatus.
- The ventilation should not be impeded by covering the ventilation openings with items, such as newspapers, table-cloths, curtains, etc.
- The equipment shall be used at maximum 35 degree C ambient temperature.

**WARNING:** To reduce the risk of fire or electric shock, do not expose this apparatus to rain or moisture.



The lightning flash with arrowhead symbol within an equilateral triangle is intended to alert the user to the presence of not isolated dangerous voltage within the product that may be sufficient magnitude to constitute a risk of shock to persons.



The exclamation point within an equilateral triangle is intended to alert the user to the presence of important operating and servicing instructions in the literature accompanying the appliance.



Warning: This equipment is a Class II or double insulated electrical appliance. It has been designed in such a way that it does not require a safety connection to electrical earth.

# TABLE OF CONTENTS

Package Contents .....	1
Controls & Connections .....	2
First-time Setup .....	4
Using the Remote .....	7
Proper Placement .....	8
Mode & Level Settings.....	9
Using Button Combinations.....	11
Programming the Sound Bar .....	12
Bluetooth Pairing.....	13
Using Bluetooth Mode.....	14
Connecting to a Voice Assistant .....	15
Advanced Setup.....	17
Connecting with HDMI ARC .....	18
Wall-mounting.....	20
Register Your Product.....	22
Customer Service .....	23
Help & Troubleshooting.....	24
Limited Warranty .....	25
Legal & Compliance .....	28
Specifications .....	29

# Package Contents



VIZIO  
Sound Bar



Remote Control  
with 2x AAA Batteries



Power Cable

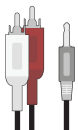

Stereo RCA to  
3.5mm Audio Cable



3.5mm to 3.5mm  
Audio Cable



Digital Optical  
Cable



HDMI Cable



2 x Wall  
Mount Brackets

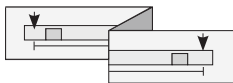

Wall Mount Template



User Manual



Quick Setup Steps

# Controls & Connections

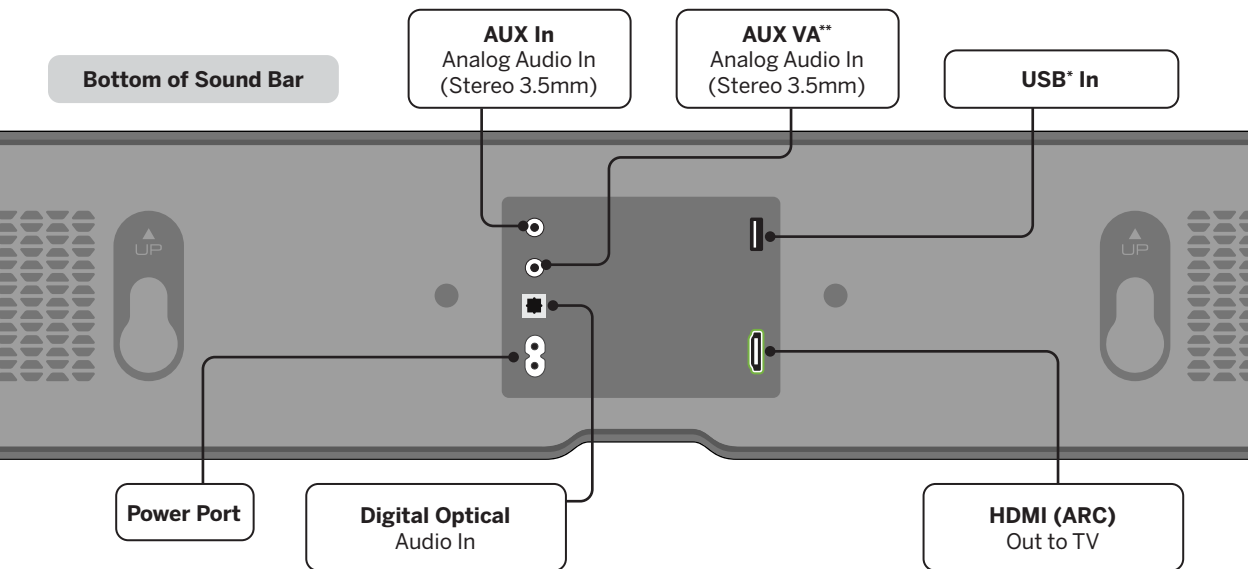

\*Supports .WAV and .MP3 file format playback only.

\*\*Only use this port to connect a Voice Assistant device. See *Connecting to a Voice Assistant* on page 15 for more information.

Front of Sound Bar

Right Side

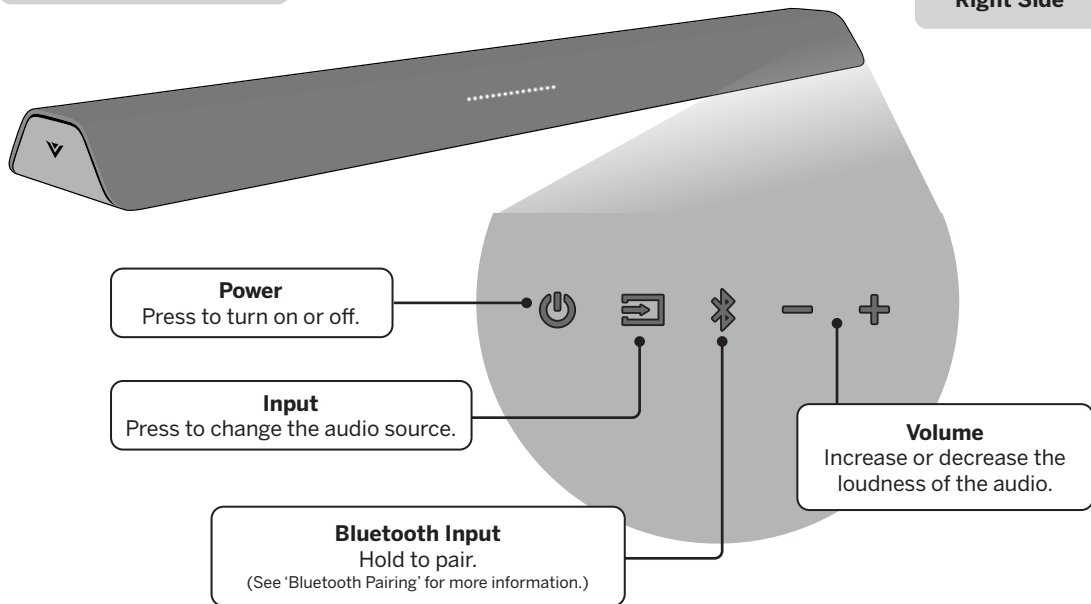

# First-time Setup

1

Choose the best possible connection cable type and connect it to your TV.\*

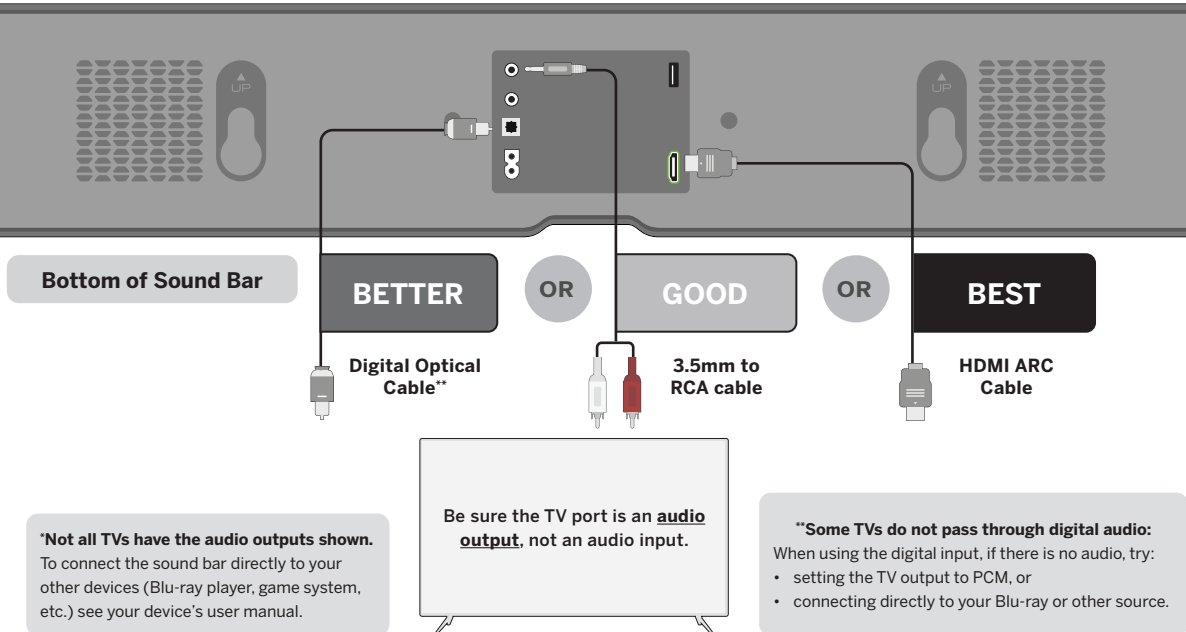

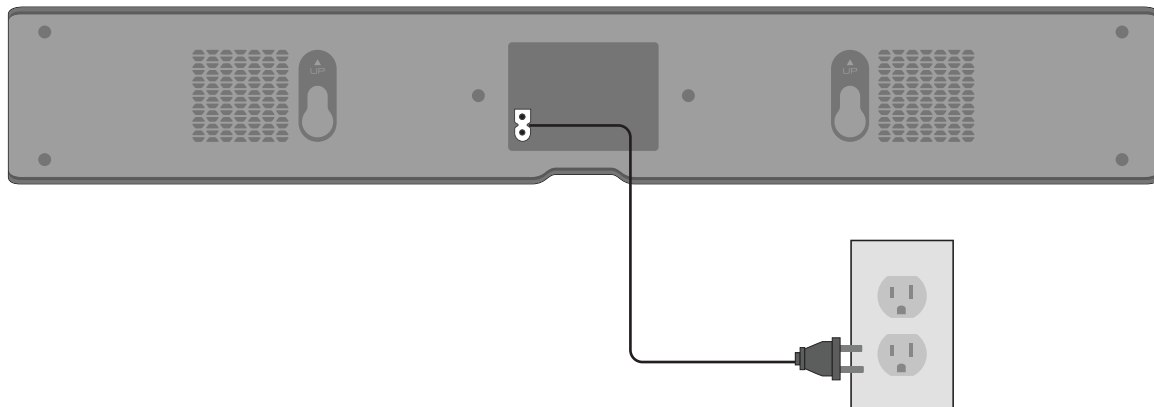

## Bottom of Sound Bar

**2**

Connect the power cable to the sound bar AC IN as shown.  
Plug the power cable into an electrical outlet.

## First-time Setup

3

Remove the battery cover by gently sliding it away from the remote.



4

Insert the included batteries and gently slide the battery cover back into place.



When needed, VIZIO recommends replacing the batteries that came with this remote with two, new Duracell 'AAA' alkaline batteries.

**POWER UP WITH  
DURACELL®**

5

After turning on both your TV and sound bar, it will automatically begin searching for an active input.\* The LED indicator on the front of the sound bar will begin cycling in different colors through inputs until an audio source is detected.\*\*



**Tip:** Pressing the **INPUT** button will stop the auto detect function.

You can press the INPUT button to switch between audio sources. For example, if you connected your TV to AUX, set the sound bar to AUX.

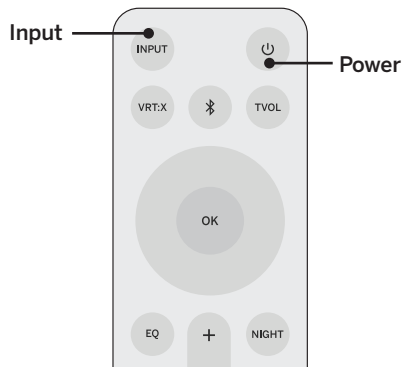

\*Occurs only during first-time set up.

\*\*Auto detect function only occurs once when the sound bar is first powered on. To enable this feature again, you must do a Factory Reset (see the Using Button Combinations section for more information) or press and hold the INPUT button for 3 seconds.

# Using the Remote

## Input

Change the input source.\*  
(Long press for Auto Input Search)  
(Long 10 second press to enable/disable AUX VA)

## Virtual: X

Turn Virtual: X on or off

## Bluetooth

Press to go to Bluetooth Mode  
(Long press for Pairing Mode)  
(Long 10 second press to enable/disable BT VA)

## Previous

Return to previous track.  
(Changes audio settings)

## Up/Down

Change to previous/next track

## EQ Settings

Change equalizer settings

## Bass

Use the **Previous/Next** buttons to increase/decrease the bass level

## Mute

Mute/unmute.  
(Long press to turn LED power indicator and voice notifications on/off)

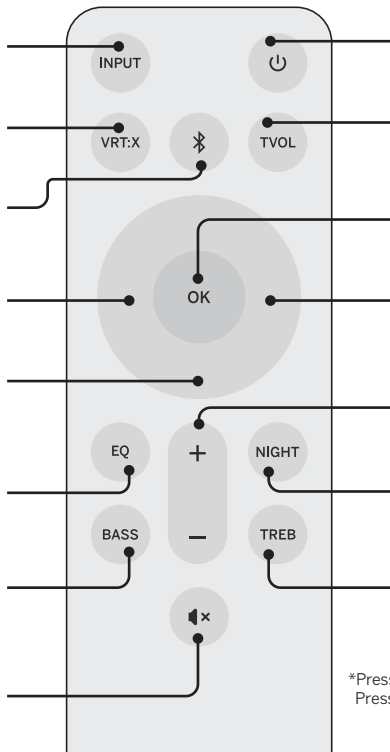

## Power

Turn on or off

## TruVolume

Turns TruVolume on or off.

## OK

Select an option, play or pause.  
(Long press for Info)

## Next

Skip to the next track.  
(Changes audio settings)

## Volume +/-

Increase and decrease volume

## Night Mode

Turns Night Mode on or off

## Treble

Use the **Previous/Next** buttons to increase/decrease the treble level

\*Press **INPUT** then **Previous** to select previous input.  
Press **INPUT** then **Next** to select Bluetooth input.

# Proper Placement

For the best surround sound experience, position the sound bar as shown.  
The sound bar should be close to ear level (approx. 2-3 ft. off the floor).

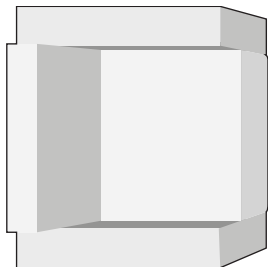

**Sound bar is centered  
below the TV.**

(If your TV permits it, you can also slide  
the sound bar underneath the TV.)

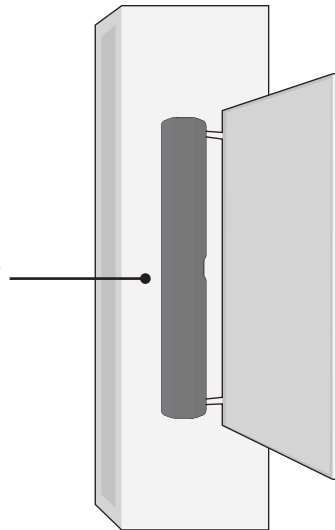

# Mode & Level Settings











The LED indicators will behave differently with each function.



LED Indicators are located here.

Function	LED Behavior	Description
<b>Input</b>	<p>The single LED will show a color according to the input.</p>	<p>Press the <b>INPUT</b> button on the remote to cycle through the available inputs. <b>Press and hold</b> the <b>INPUT</b> button for 3 seconds to enable the auto input detect function. Specific inputs will show a different LED color:</p> <ul style="list-style-type: none"> <li>AUX In: Green</li> <li>AUX VA: Violet</li> <li>Digital Optical: Red</li> <li>HDMI ARC: Magenta</li> <li>Bluetooth: Blue</li> <li>USB: Orange</li> </ul>
<b>Bluetooth Pairing</b>	<p><b>Searching:</b> Flash from left to right continuously.</p>	<p><b>Press and hold</b> the <b>Bluetooth</b> button on the remote. The sound bar will be discoverable for 15 minutes. You can now search for the sound bar (<i>VIZIO V21d</i>) using your Bluetooth Device. The sound bar will power down if no device is found.</p> <p><b>Note:</b> Set your Bluetooth device into pairing mode prior to the sound bar.</p>
<b>DTS Virtual: X</b>	<p><b>On</b></p> <p><b>Off</b></p>	<p>Press the <b>VRT: X</b> button to enable/disable Virtual: X. When ON, all inputs will produce a virtual sound technology that simulates the effect of having overhead sound. When OFF, all sources will play back in stereo.</p>
<b>DTS TruVolume</b>	<p><b>On</b></p> <p><b>Off</b></p>	<p>Press the <b>TVOL</b> button to enable/disable TruVolume. When ON, TruVolume provides a consistent and comfortable volume level for a more enjoyable listening experience.</p>
<b>Equalizer Mode</b>	<p><b>Music</b></p> <p><b>Movie</b></p> <p><b>Game</b></p> <p><b>Dialogue</b></p>	<p>Press the <b>EQ</b> button to toggle between four preset equalizer settings: Music, Movie, Game, Dialogue.</p> <p><b>Note:</b> Movie mode is on by default.</p>

# Mode & Level Settings

Function	LED Behavior	Description
<b>Bass Level</b>	<p>Three center LEDs indicate level 0</p> 	Press the <b>BASS</b> button and then use the <b>Next/Previous</b> buttons to increase/decrease the bass level. The LED indicators will move to the right with increasing levels and down with decreasing levels. Decreasing the bass level to the lowest setting will reduce bass and subwoofer levels on the bar. This is best for watching TV late at night in a quiet environment.
<b>Treble Level</b>	<p>Three center LEDs indicate level 0.</p> 	Press the <b>TREB</b> button and then use the <b>Next/Previous</b> buttons to increase/decrease the treble level. The LED indicators will move to the right with increasing levels and down with decreasing levels.
<b>Night Mode</b>	<p><b>On</b></p>  <p><b>Off</b></p> 	Press the <b>NIGHT</b> button and then use the <b>Next/Previous</b> buttons to enable/disable Night Mode. When enabled (On), the sound bar will lower bass frequency levels to provide a more quiet environment (ideal for apartment living and homes with sleeping children).
<b>Auto VA</b>	<p><b>Off</b></p>  <p><b>Both</b></p>  <p><b>AUX</b></p>  <p><b>BT</b></p> 	<p><b>Press and hold</b> the <b>INPUT</b> button on the remote for 10 seconds to enable/disable AUX VA.</p> <p>—or—</p> <p><b>Press and hold</b> the <b>Bluetooth</b>  button on the remote for 10 seconds to enable/disable Voice Assistant Bluetooth (BT). Refer to <i>Connecting to a Voice Assistant</i> on page 15 for more information.</p>
<b>Dolby Audio or DTS signal</b>	<p>Dolby Audio: white LED DTS signal: amber LED</p> 	Dolby Audio and DTS are available on the <b>HDMI ARC, HDMI In, and Digital Optical</b> audio inputs. When a Dolby Audio or DTS signal is detected, the LED will light up for 5 seconds before fading away.

# Using Button Combinations

There are other functions that are triggered by different button combinations on the sound bar.



Buttons are located here.



Function	LED Behavior	Description
<b>Factory Reset</b>	All LEDs will flash 3 times 	Reset the sound bar to the factory default settings. To perform a Factory Reset, <b>Press and hold</b> the <b>Bluetooth button</b> 📶 and <b>Volume Down</b> (⏮) buttons for 5 seconds. <b>Note:</b> This will erase all settings and preferences that you have set.
<b>VIZIO TV Remote Control</b>	<b>Enabled</b>  <b>Disabled</b> 	Enable/disable the use of a VIZIO TV remote control to power on and adjust the volume of the sound bar. To enable/disable this function, <b>Press and hold</b> the <b>Power</b> (⏻) and <b>Volume Up</b> (⏭) buttons for 5 seconds.
<b>Eco Power Mode</b>	<b>Enabled</b>  <b>Disabled</b> 	When the Eco Power Mode setting is enabled, the sound bar will automatically power down after a period of inactivity. When disabled, the sound bar will remain powered on until you turn it off. To enable/disable this function, <b>Press and hold</b> the <b>Power</b> (⏻) and <b>Volume Down</b> (⏮) buttons for 5 seconds. <b>Note:</b> Eco Power mode is disabled by default.

# Programming the Sound Bar

You can program your sound bar to accept TV remote IR commands.

Function	LED Behavior	Description
<b>Learn Volume Down</b>	<b>Waiting to learn:</b> Flash from left to right and back continuously.	Press the <b>OK and Volume Down</b> buttons at the same time to put the sound bar into learning mode. While the sound bar is in learning mode, press the <b>Volume Down</b> button on the TV remote control.
<b>Learn Volume Up</b>	 <b>Learning confirmed:</b> All of the LEDs will blink twice.	Press the <b>OK and Volume Up</b> buttons at the same time to put the sound bar into learning mode. While the sound bar is in learning mode, press the <b>Volume Up</b> button on the TV remote control.
<b>Learn Mute</b>	 <b>Learning confirmed:</b> All of the LEDs will blink twice.	Press the <b>OK and Volume Mute</b> buttons at the same time to put the sound bar into learning mode. While the sound bar is in learning mode, press the <b>Mute</b> button on the TV remote control.



Point both the sound bar and TV remotes towards the front of the sound bar when programming.

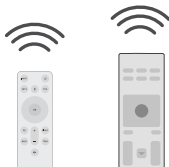

**Turn off your TV speakers** when programming your sound bar.



# Bluetooth Pairing

To pair the sound bar with a Bluetooth device:

1. **Press and hold** the Bluetooth button  on the sound bar or remote for five (5) seconds.
2. Search for the sound bar (*VIZIO V21d*) using your Bluetooth device. For more information, refer to the user documentation that came with the device.
3. Now you can play audio from your Bluetooth device. Volume can be controlled on both your source device and the sound bar.



**Bluetooth Device**

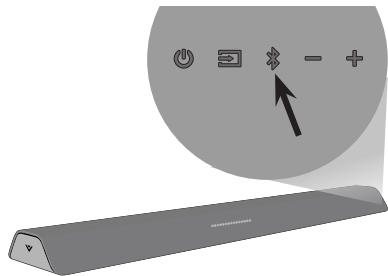

**Button Located on the Side of Sound Bar**



In Bluetooth pairing mode, the LED indicators on the display panel on the front of the sound bar will light up from left to right continuously. Once the device is paired, the LED indicators will stop flashing.

# Using Bluetooth Mode

1. Your sound bar supports music streaming from devices with Bluetooth capability. (Device compatibility will vary, see your device's documentation for more information.)
2. Once you have paired your source device to the sound bar your device should remain paired. (within range)
3. If the source is changed back to Bluetooth, any paired Bluetooth device will reconnect automatically.
4. If the input is changed, the Bluetooth device will disconnect (will stay connected if Auto VA BT is on).

## Maximizing Signal

**A Bluetooth signal has a range of up to 30 feet.** Keep in mind that Bluetooth is a compressed audio format, so streamed music may lose some integrity when compared to a wired connection.

Try the following if your sound quality is less than optimal:

- If you hear any break-up or disconnect while streaming music from your device, move the source device closer to the sound bar.
- Be sure that there are no solid obstructions in the line-of-sight between the sound bar and the source device.
- Other wireless devices can affect Bluetooth range, including wireless security cameras, wireless video baby monitors, cordless phones, and microwave ovens. Turning off or moving these devices may improve Bluetooth range.



Your sound bar is not equipped with a microphone, so it cannot operate as a hands-free device for a smartphone.



Reduce the volume levels on your device and on the sound bar before pressing Play. High volume levels can damage your hearing.

# Connecting to a Voice Assistant

Your sound bar can connect to a Voice Assistant (VA) device through an AUX VA or Bluetooth connection.

Once connected, your sound bar will now act as the VA speaker.

## Features and Benefits:

- **Voice Assistant Dedicated Input:** VA can be active on the sound bar even if the sound bar is set to a different input with audio playing.
- **Auto Muting:** If playing audio from the sound bar, the VA will play over the original source audio for 10 seconds. If continued after the 10 seconds, the VA audio will mute the original source audio. Once the VA audio is stopped the original source audio will resume.



Make sure your sound bar is turned **ON** and Eco Power setting is turned **OFF**. Refer to *Eco Power mode* on page 11 to disable.

## Setup Tips:

- If the VA audio is too low, adjust the volume from the VA device.
- If the start of the response from the VA is cut off, enable “Start of Request” from your VA app settings.
- **To disable the VA function**, press and hold the **INPUT** button on the remote for 10 seconds to turn on or off. Refer to *Auto VA* on page 10 for more information.

# Connecting to a Voice Assistant

## Using the AUX VA Port to Connect

Use a 3.5mm audio cable to connect the **AUX VA port on the sound bar** to an AUX port on your voice assistant device. If there is no AUX port on the VA device, use a Bluetooth connection instead.

### Benefits of this type of connection:

- Simple and easy connection setup.

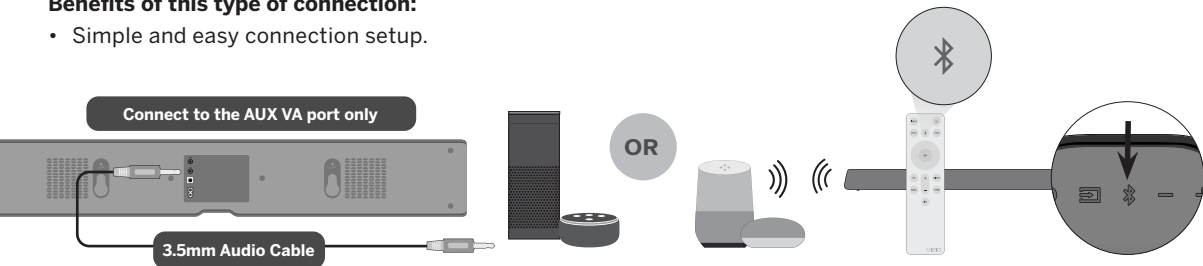

## Using Bluetooth to Connect

Press and hold the **Bluetooth button on the sound bar or remote** for five (5) seconds. Search for the sound bar (VIZIO V21d) using your VA device app. For more information, refer to the user documentation that came with the device.

### Benefits of this type of connection:

- Ability to position the VA device in other locations other than physically connected to the sound bar.
- Ability to place the VA device closer to you so that it can hear commands better.

# Advanced Setup

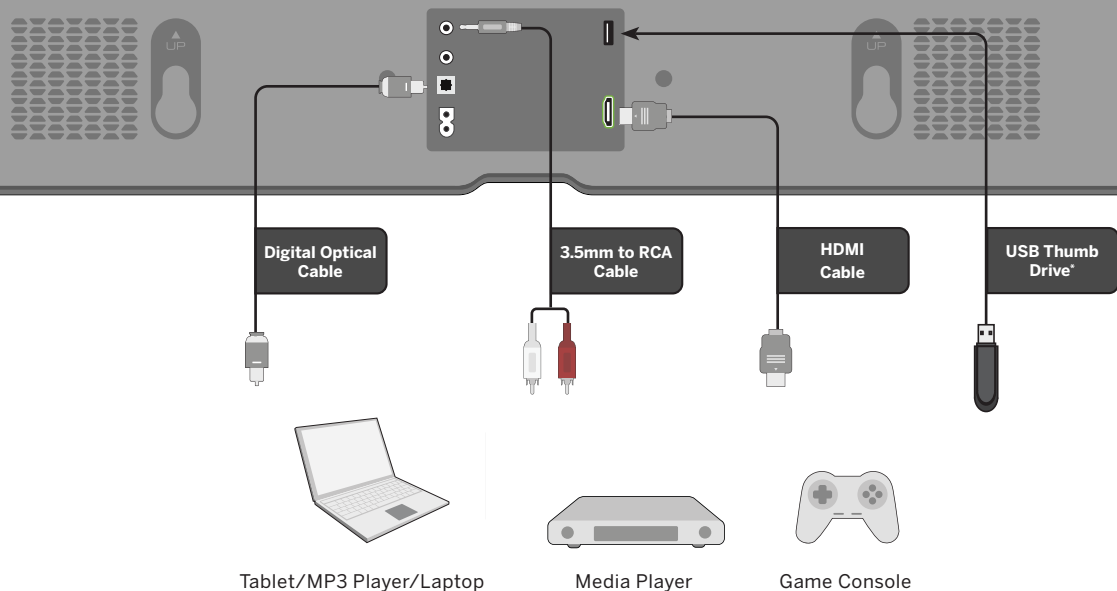

\*Supports .WAV and .MP3 file format playback only.

# Connecting with HDMI ARC

HDMI (ARC) port on your TV\*

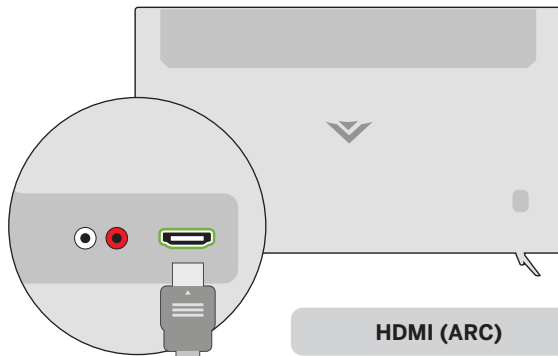

HDMI (ARC)

\* HDMI ARC port location may differ by TV manufacturer. See your TV's user manual for more information.

## What is HDMI Audio Return Channel (ARC)?

- Using HDMI ARC, your TV can send audio to the sound bar using an HDMI cable.
- Connect your sound bar to your TV's HDMI ARC port using an HDMI cable that is ARC compatible.

## To connect using HDMI\*:

1. Connect one end of the HDMI cable to the **HDMI 1 (ARC)** port on the back of your TV.
2. Connect the other end to the **HDMI (ARC)** port on your sound bar.
3. From the AUDIO menu on your TV, change the Digital Audio Setting to **Dolby Digital** or **Bitstream**.
4. From the SYSTEM menu, enable CEC and ARC (SAC)<sup>†</sup> functions.
5. From the CEC menu, select Device Discovery to register the sound bar with the TV.



If you want to use the TV remote to control the sound bar volume:  
Enable System Audio Control from the CEC menu.

\* The following steps are for use with a VIZIO TV, steps may differ by TV manufacturer. See your TV's user manual for more information.

† CEC Function naming may differ by TV manufacturer. See your TV's user manual for more information.

# Wall-mounting

1

Place the included wall mounting template against the wall under your TV. Mark the two bracket holes using a pencil.

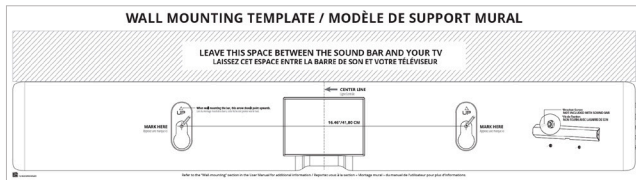

2

Install the wall mount brackets to the wall. Be sure your screws are attached to wood studs, drywall anchors (for drywall), or concrete anchors (for brick/concrete walls).



**Screws for attaching the bracket to the wall are not included.** Choose the screw type and length appropriate to your home's construction. If in doubt, consult a professional installer.

**Bracket Screw\***  
(Not included with sound bar)

Suggested screw size: 3.5 mm diameter,  
1.63" minimum length

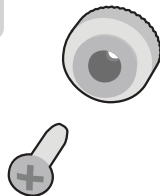

\* Do not use any of the included screws for the wall mount installation. These are not intended for mounting.



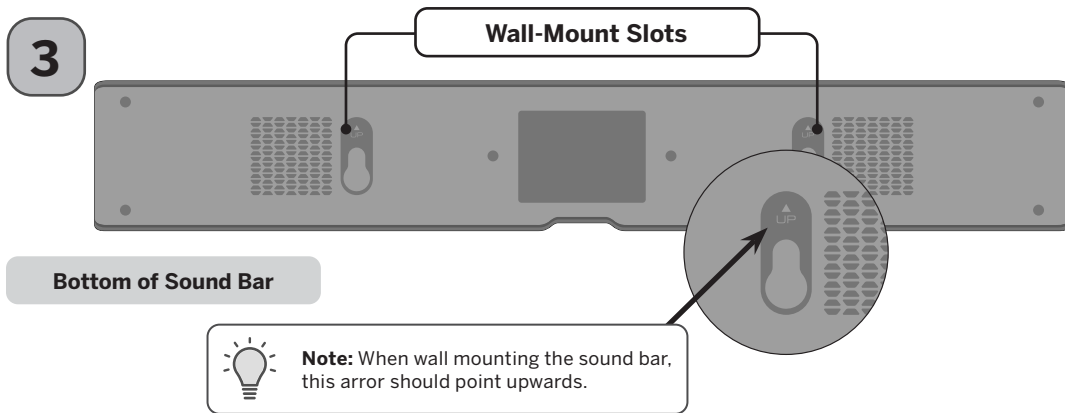

Hang the sound bar on the wall mount brackets then slide down to lock in place.

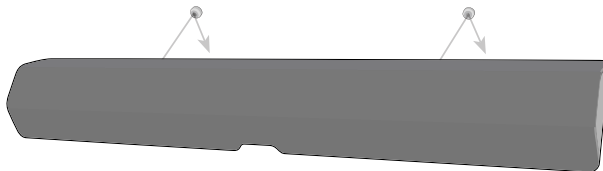

# VIZIO.COM/PRODUCT-REGISTRATION

## *Why register?*



### **Customized Support**

Get assistance quickly with your information on hand.



### **News and Offers**

Take advantage of the latest news and special offers from VIZIO.



### **Safety and Satisfaction**

Stay up-to-date with important product updates and notifications.

## SUPPORT.VIZIO.COM

### Find help with:

- New product setup
- Connecting your devices
- Replacement remotes
- Technical problems
- Bluetooth and streaming
- Product updates and more

# Help & Troubleshooting

## There is no power.

- Press the **POWER** button on the remote control or on the side of your sound bar.
- Ensure the power cord is securely connected.
- Plug a different device into the electrical outlet to verify that the outlet is working correctly.

## There is no sound.

- Increase the volume. Press **VOLUME UP** on the remote control or on the side of your sound bar.
- Press **MUTE** on the remote to ensure the sound bar is not muted.
- Press **INPUT** on the remote or on the side of your sound bar to select a different input source.
- When using either of the Digital Inputs, if there is no audio: (A) try setting the TV output to PCM or (B) connect directly to your Blu-ray/other source, some TVs do not pass through digital audio.
- On digital inputs, there will be a voice announcement if an unsupported format is present. Set the source to output PCM.
- Your TV may be set to variable audio output. Confirm that the audio output setting is set to FIXED or STANDARD, not VARIABLE. Consult your TV's user manual for more detailed information.
- If using Bluetooth, ensure that the volume on your source device is turned up and that the device is not muted.

## I hear buzzing or humming.

- Ensure all cables and wires are securely connected.
- Connect a different source device (TV, Blu-ray player, etc) to see if the buzzing persists. If it does not, the problem may be with the original device.
- Connect your device to a different input on the sound bar.

## The remote isn't working.

- Replace the remote batteries with new ones.
- Point the remote directly at the center of the sound bar when pressing a button.
- If using a Bluetooth connection, some of the buttons on the remote may not be supported by the streaming application (e.g., Pandora doesn't support the BACK button).

## UNITED STATES AND CANADA

BY USING YOUR VIZIO PRODUCT YOU AGREE TO BE BOUND BY ALL THE TERMS OF THIS WARRANTY. BEFORE USING YOUR VIZIO PRODUCT, PLEASE READ THIS WARRANTY CAREFULLY. IF YOU DO NOT AGREE TO THE TERMS OF THIS WARRANTY, DO NOT USE THE VIZIO PRODUCT AND, WITHIN THIRTY (30) DAYS OF THE DATE OF PURCHASE, RETURN IT FOR A REFUND TO THE AUTHORIZED RETAILER WHERE YOU PURCHASED IT.

This warranty contains a binding arbitration agreement and a class action waiver for United States residents. If you live in the United States, the binding arbitration agreement and class action waiver affect your rights under this warranty. Please read the text under the section titled "Binding Arbitration Agreement; Class Action Waiver (U.S. Residents Only)" carefully.

## How Long This Warranty Lasts

For non-commercial use, VIZIO warrants the product on the terms set forth below for one (1) year from the date of original purchase. For commercial use, VIZIO warrants this product on the terms set forth below for ninety (90) days from the date of original purchase.

## What This Warranty Covers

VIZIO warrants the product against defects in materials and workmanship when the product is used normally in accordance with VIZIO's user guides and manuals. Except where restricted by law, this warranty applies only to the original purchaser of a new product. The purchase must have been made from an authorized retailer in the United States (including Puerto Rico) or Canada. The product must also be located in the country where it was purchased at the time of warranty service.

## How to Get Service

Before obtaining warranty service, you may visit [www.vizio.com](http://www.vizio.com) for additional help and troubleshooting. To obtain warranty service, contact VIZIO Customer Support by going to [support.vizio.com](http://support.vizio.com) and selecting Contact Us. You can also call Customer Support: (US) 877-698-4946;(Canada) 877-878-4946.

## Your Obligations Before Service

You must obtain pre-authorization before sending your product to a VIZIO service center. You may be required to supply a purchase receipt (or copy) to show that the product is within the warranty period.

When you return a product to a VIZIO service center, you must ship the product in its original packaging or in packaging that affords an equal degree of protection. VIZIO Technical Support will provide instructions for packing and shipping the product to the VIZIO service center.

ALL USER DATA AND DOWNLOADED APPLICATIONS STORED ON A PRODUCT WILL BE DELETED IN THE COURSE OF SOME IN-HOME AND ALL SHIP-IN WARRANTY SERVICE. If this occurs, your product will be restored to its original state. You will be responsible for restoring all applicable user data and downloaded applications. Recovery and reinstallation of user data and downloaded applications is not covered under this warranty. In order to protect your personal information, VIZIO recommends that you always clear all personal information from the product before it is serviced, regardless of the servicer.

## VIZIO's Responsibilities

If VIZIO determines that a product is covered by this warranty, VIZIO will (at its option) repair or replace it, or refund the purchase price to you. There will be no charge for parts or labor during the warranty period. Replacement parts may be new or recertified at VIZIO's option and sole discretion. Replacement parts and VIZIO's labor are warranted for the remaining portion of the original warranty or for ninety (90) days from warranty service, whichever is longer.

# Limited Warranty

## Types of Service

Products must be sent to a VIZIO service center to obtain warranty service. VIZIO is not responsible for transportation costs to the service center, but VIZIO will cover return shipping to the customer.

## What This Warranty Does Not Cover

This warranty does not cover: (a) cosmetic damage; (b) normal wear and tear; (c) improper operation; (d) improper voltage supply or power surges; (e) signal issues; (f) damage from shipping; (g) acts of God; (h) customer misuse, modifications or adjustments; (i) installation, set-up, or repairs attempted by anyone other than by a VIZIO authorized service center; (j) products with unreadable or removed serial numbers; (k) products requiring routine maintenance; or (l) products sold "AS IS", "CLEARANCE", "FACTORY RECERTIFIED", or by a non-authorized reseller.

## What to Do If You Are Not Satisfied With Service

If you feel VIZIO has not met its obligations under this warranty, you may attempt to resolve the issue informally with VIZIO. If you are unable to resolve the issue informally and wish to file a formal claim against VIZIO, and if you are a resident of the United States, you must submit your claim to binding arbitration according to the procedures described below, unless an exception applies. Submitting a claim to binding arbitration means that you do not have the right to have your claim heard by a judge or jury. Instead your claim will be heard by a neutral arbitrator.

## Binding Arbitration Agreement; Class Action Waiver (U.S. Residents Only)

UNLESS YOU HAVE BROUGHT AN ELIGIBLE CLAIM IN SMALL CLAIMS COURT OR HAVE OPTED OUT AS DESCRIBED BELOW, ANY CONTROVERSY OR CLAIM RELATING IN ANY WAY TO YOUR VIZIO PRODUCT, INCLUDING ANY CONTROVERSY OR CLAIM ARISING OUT OF OR RELATING TO THIS WARRANTY, A BREACH OF THIS WARRANTY, OR THE VIZIO PRODUCT'S SALE, CONDITION OR PERFORMANCE, WILL BE SETTLED BY BINDING ARBITRATION ADMINISTERED BY THE AMERICAN ARBITRATION ASSOCIATION AND CONDUCTED BY A SINGLE ARBITRATOR APPOINTED BY THE AMERICAN ARBITRATION ASSOCIATION, IN ACCORDANCE WITH ITS COMMERCIAL ARBITRATION RULES AND ITS SUPPLEMENTARY PROCEDURES FOR CONSUMER-RELATED DISPUTES. You may learn more about the American Arbitration Association and its rules for arbitration by visiting [www.adr.org](http://www.adr.org) or by calling 800-778-7879. Since this warranty concerns a transaction in interstate or international commerce, the Federal Arbitration Act will apply.

The filing fees to begin and carry out arbitration will be shared between you and VIZIO, but in no event will your fees ever exceed the amount allowable by the American Arbitration Association, at which point VIZIO will cover all additional administrative fees and expenses. VIZIO waives its right to recover attorneys' fees in connection with any arbitration under this warranty. If you are the prevailing party in an arbitration to which the Supplementary Procedures for Consumer-Related Disputes applies, then you are entitled to recover attorneys' fees as the arbitrator may determine.

The dispute will be governed by the laws of the state or territory in which you resided at the time of your purchase (if in the United States). The place of arbitration will be Irvine, California, or your county of residence (if in the United States). The arbitrator will have no authority to award punitive or other damages not measured by the prevailing party's actual damages, except as may be required by statute. The arbitrator will not award consequential damages, and any award will be limited to monetary damages and will include no equitable relief, injunction, or direction to any party other than the direction to pay a monetary amount. Judgment on the award rendered by the arbitrator will be binding and final, except for any right of appeal provided by the Federal Arbitration Act, and may be entered in any court having jurisdiction. Except as may be required by law, neither you nor VIZIO nor an arbitrator may disclose the existence, content, or results of any arbitration under this warranty without the prior written consent of you and VIZIO.

ANY DISPUTE, WHETHER IN ARBITRATION, IN COURT, OR OTHERWISE, WILL BE CONDUCTED SOLELY ON AN INDIVIDUAL BASIS. VIZIO AND YOU AGREE THAT NO PARTY WILL HAVE THE RIGHT OR AUTHORITY FOR ANY DISPUTE TO BE ARBITRATED AS A CLASS ACTION, A PRIVATE ATTORNEY GENERAL ACTION, OR IN ANY OTHER PROCEEDING IN WHICH EITHER PARTY ACTS OR PROPOSES TO ACT IN A REPRESENTATIVE CAPACITY.

NO ARBITRATION OR PROCEEDING WILL BE JOINED, CONSOLIDATED, OR COMBINED WITH ANOTHER ARBITRATION OR PROCEEDING WITHOUT THE PRIOR WRITTEN CONSENT OF ALL PARTIES TO ANY SUCH ARBITRATION OR PROCEEDING.

Exceptions to Binding Arbitration Agreement and Class Action Waiver

IF YOU DO NOT WISH TO BE BOUND BY THE BINDING ARBITRATION AGREEMENT AND CLASS ACTION WAIVER, THEN: (1) you must notify VIZIO in writing within sixty (60) days of the date that you purchased the product; (2) your written notification must be mailed to VIZIO at 39 Tesla, Irvine, CA 92618, Attn: Legal Department; and (3) your written notification must include (a) your name, (b) your address, (c) the date you purchased the product, and (d) a clear statement that you wish to opt out of the binding arbitration agreement and class action waiver.

In addition, you may pursue a claim in small claims court in your county of residence (if in the United States) or in Orange County, California. In such case the provisions of the section titled "Binding Arbitration Agreement; Class Action Waiver (U.S. Residents)" will not apply.

## Exclusions and Limitations

TO THE GREATEST EXTENT PERMITTED BY APPLICABLE LAW, THERE ARE NO EXPRESS WARRANTIES OTHER THAN THOSE DESCRIBED ABOVE. ANY IMPLIED WARRANTIES, INCLUDING ANY IMPLIED WARRANTY OF MERCHANTABILITY AND FITNESS FOR A PARTICULAR PURPOSE, WILL BE LIMITED IN DURATION TO THE WARRANTY PERIOD SET FORTH ABOVE. SOME STATES AND PROVINCES DO NOT ALLOW LIMITATIONS ON HOW LONG AN IMPLIED WARRANTY LASTS, SO THE ABOVE LIMITATION MAY NOT APPLY TO YOU.

VIZIO WILL NOT BE RESPONSIBLE FOR LOSS OF USE, LOSS OF INFORMATION OR DATA, COMMERCIAL LOSS, LOST REVENUE OR LOST PROFITS, OR OTHER INDIRECT, SPECIAL, INCIDENTAL OR CONSEQUENTIAL DAMAGES, EVEN IF VIZIO HAS BEEN ADVISED OF THE POSSIBILITY OF SUCH DAMAGES, AND EVEN IF THE REMEDY FAILS OF ITS ESSENTIAL PURPOSE. SOME STATES AND PROVINCES DO NOT ALLOW THE EXCLUSION OR LIMITATION OF INCIDENTAL OR CONSEQUENTIAL DAMAGES, SO THE ABOVE LIMITATION OR EXCLUSION MAY NOT APPLY TO YOU.

IN LIEU OF ANY OTHER REMEDY FOR ANY AND ALL LOSSES AND DAMAGES RESULTING FROM ANY CAUSE WHATSOEVER (INCLUDING VIZIO'S NEGLIGENCE, ALLEGED DAMAGE, OR DEFECTIVE GOODS, NO MATTER WHETHER SUCH DEFECTS ARE DISCOVERABLE OR LATENT), VIZIO MAY, AT ITS SOLE AND EXCLUSIVE OPTION AND IN ITS DISCRETION, REPAIR OR REPLACE YOUR PRODUCT, OR REFUND ITS PURCHASE PRICE. AS NOTED, SOME STATES AND PROVINCES DO NOT ALLOW THE EXCLUSION OR LIMITATION OF INCIDENTAL OR CONSEQUENTIAL DAMAGES, SO THE ABOVE LIMITATION OR EXCLUSION MAY NOT APPLY TO YOU.

## How the Law Applies

This warranty gives you specific legal rights, and you may also have other rights, which vary from state to state and province to province. This warranty applies to the greatest extent permitted by applicable law.

## General

No employee or agent of VIZIO may modify this warranty. If any term of this warranty, other than the class action waiver, is found to be unenforceable, that term will be severed from this warranty and all other terms will remain in effect. If the class action waiver is found to be unenforceable, then the entire section titled "Binding Arbitration Agreement; Class Action Waiver (U.S. Residents Only)" will not apply. This warranty applies to the maximum extent not prohibited by law.

## Changes to Warranty

This warranty may change without notice, but any change will not affect your original warranty. Check [www.vizio.com](http://www.vizio.com) for the most current version.

# Legal & Compliance

## FCC Class B Radio Interference Statement

NOTE: This equipment has been tested and found to comply with the limits for a Class B digital device, pursuant to Part 15 of the FCC Rules. These limits are designed to provide reasonable protection against harmful interference in a residential installation. This equipment generates, uses and can radiate radio frequency energy, and if not installed and used in accordance with the instructions, may cause harmful interference to radio communications. However, there is no guarantee that interference will not occur in a particular installation. If this equipment does cause harmful interference to radio or television reception, which can be determined by turning the equipment off and on, the user is encouraged to try to correct the interference by one or more of the following measures:

1. Reorient or relocate the receiving antenna.
2. Increase the separation between the equipment and receiver.
3. Connect the equipment into an outlet on a circuit different from that to which the receiver is connected.
4. Consult the dealer or an experienced radio/TV technician for help.

This device complies with Part 15 of the FCC Rules. Operation is subject to the following two conditions: (1) this device may not cause harmful interference, and (2) this device must accept any interference received, including interference that may cause undesired operation.

## Notice:

1. Any Changes or modifications not expressly approved by the party responsible for compliance could void the user's authority to operate the equipment.
2. Shielded interface cables and AC power cord, if any, must be used in order to comply with the emission limits.
3. The manufacturer is not responsible for any radio or TV interference caused by unauthorized modification to this equipment. It is the responsibilities of the user to correct such interference.

## FCC RF Radiation Exposure Statement

1. This transmitter must not be collocated or operating in conjunction with any other antenna or transmitter.
2. This equipment complies with FCC radiation exposure limits set forth for an uncontrolled environment. This equipment should be installed and operated with minimum distance 20cm between the radiator & your body.
3. FCC RF Warning

This equipment must be installed and operated in accordance with provided instructions and the antenna(s) used for this transmitter must be installed to provide a separation distance of at least 20cm from all persons and must not be co-located or operating in conjunction with any other antenna or transmitter. End-users and installers must be provided with antenna installation instructions and transmitter operating conditions for satisfying RF exposure compliance.

## Battery Disposal and Recycling

You must dispose of this product properly, according to local laws and regulations. Because this product contains electronic components and/ or a battery, it must be disposed of separately from household waste. Contact local authorities to learn about disposal and recycling options. For more information, visit [vizio.com/environment](http://vizio.com/environment).

## Software Licenses

All software is provided subject to software license agreements and you agree that you will be bound by such license agreements in addition to other applicable terms of use. By using the VIZIO products, you agree to the VIZIO Terms of Service and Privacy Policy. The VIZIO Terms of Use and Privacy Policy may be updated from time to time and are available to view at [vizio.com/terms](http://vizio.com/terms) and [vizio.com/privacy](http://vizio.com/privacy), respectively.

## Export Regulations

Customer acknowledges that the VIZIO products, which include technology and software, are subject to customs and export control laws in the United States ("US"). The products may also be subject to the customs and export control laws and regulations of the country in which the products are manufactured and/or received.

## © 2020 VIZIO, Inc. All Rights Reserved.

This User Manual may not be copied in whole or in part without the written permission of VIZIO, Inc. VIZIO, Inc. has made reasonable efforts to ensure the accuracy of the information provided herein. All product specifications, functionality, features, configurations, performance, design and other product information described herein are subject to change without notice. VIZIO, Inc. is not responsible for typographical, technical, or descriptive errors. To review the most updated version of this User Manual and the associated Quick Start Setup guide, go to [vizio.com](http://vizio.com).

VIZIO, the VIZIO logo, the V logo, and other terms and phrases are trademarks or registered trademarks of VIZIO, Inc.



## Specifications

<b>Sound Bar:</b>	One 1.73" x 2.91" (44 x 74 mm) Full Range Driver + One 1.41" (36 mm) Tweeter for Each Channel (2 for left, 2 for right)	
<b>Built-in Subwoofer</b>	Two 2.79" x 3.58" (71 x 91 mm) Drivers	
<b>Connections:</b>	One 3.5mm Stereo Audio One Optical (Toslink) HDMI (ARC)	One 3.5mm AUX Voice Assistant Bluetooth One USB (Supports .WAV and .MP3 format only)
<b>Sound Pressure Level* (System):</b>	98 dB	
<b>Frequency Response (System):</b>	50 Hz - 20 KHz	
<b>Voltage:</b>	100-240Vac, 50/60Hz	
<b>Compliances:</b>	cULus / FCC Class B / ICES-003 /CEC	

\*Sound pressure level measured using pink noise at 1 meter, c-weighted.



Manufactured under license from Dolby Laboratories. Dolby, Dolby Audio, and the double-D symbol are trademarks of Dolby Laboratories.



The terms HDMI and HDMI High Definition Multimedia Interface, and the HDMI logo are trademarks or registered trademarks of HDMI Licensing LLC in the United States and other countries.



The Bluetooth® word mark and Logos are registered trademark owned by Bluetooth SIG, Inc. and any use of such marks by VIZIO, Inc. is under license. Other trademarks and trade names are those of their respective owners.



For DTS patents, see <http://patents.dts.com>. Manufactured under license from DTS, Inc. DTS, Digital Surround, Virtual:X, and the DTS logo are registered trademarks or trademarks of DTS, Inc. in the United States and other countries. © 2020 DTS, Inc. ALL RIGHTS RESERVED.







© 2020 VIZIO INC. ALL RIGHTS RESERVED.  
201203SL