



# FCC RADIO TEST REPORT

## FCC ID: ZVAMT-WN715N

**Product :** 150M Wireless USB adapter

**Trade Name :** N/A

**Model Name :** MT-WN715N

**Serial Model :** N/A

**Report No. :** NTEK- 2012NT0723458F

### Prepared for

TCL Technoly Electronics (Huizhou) Co., Ltd.  
Section 19, Zhongkai High-tech Development Zone, Huizhou  
City, Guangdong Province, China

### Prepared by

NTEK Testing Technology Co., Ltd.  
1/F, Building E, Fenda Science Park, Sanwei Community, Xixiang Street  
Bao'an District, Shenzhen P.R. China  
Tel.: +86-0755-61156588 Fax.: +86-0755-61156599  
Website: www.ntek.org.cn

## TEST RESULT CERTIFICATION

**Applicant's name** ..... : TCL Technoly Electronics (Huizhou) Co., Ltd.  
**Address** ..... : Section 19, Zhongkai High-tech Development Zone, Huizhou  
City, Guangdong Province, China  
**Manufacture's Name** ..... : TCL Technoly Electronics (Huizhou) Co., Ltd.  
**Address** ..... : Section 19, Zhongkai High-tech Development Zone, Huizhou  
City, Guangdong Province, China

### Product description

**Product name** ..... : 150M Wireless USB adapter  
**Model and/or type reference** : MT-WN715N  
**Serial Model** : N/A

**Standards** ..... : FCC Part15.247

**Test procedure** ..... ANSI C63.4-2003,

This device described above has been tested by NTEK, and the test results show that the equipment under test (EUT) is in compliance with the FCC&IC requirements. And it is applicable only to the tested sample identified in the report.

This report shall not be reproduced except in full, without the written approval of NTEK, this document may be altered or revised by NTEK, personal only, and shall be noted in the revision of the document.

**Date of Test** ..... :

**Date (s) of performance of tests** ..... : 01 Aug. 2012 ~08 Aug. 2012

**Date of Issue** ..... : 09 Aug. 2012

**Test Result** ..... : **Pass**

**Testing Engineer** : Apple Huang  
(Apple Huang)

**Technical Manager** : Tom Zhang  
(Tom Zhang)

**Authorized Signatory** : Bovey Yang  
(Bovey Yang)

**Table of Contents**

	<b>Page</b>
<b>1 . SUMMARY OF TEST RESULTS</b>	<b>5</b>
1.1 TEST FACILITY	6
1.2 MEASUREMENT UNCERTAINTY	6
<b>2 . GENERAL INFORMATION</b>	<b>7</b>
2.1 GENERAL DESCRIPTION OF EUT	7
2.2 DESCRIPTION OF TEST MODES	9
2.3 BLOCK DIGRAM SHOWING THE CONFIGURATION OF SYSTEM TESTED	10
2.4 DESCRIPTION OF SUPPORT UNITS(CONDUCTED MODE)	11
2.5 EQUIPMENTS LIST FOR ALL TEST ITEMS	12
<b>3 . EMC EMISSION TEST</b>	<b>13</b>
3.1 CONDUCTED EMISSION MEASUREMENT	13
3.1.1 POWER LINE CONDUCTED EMISSION LIMITS	13
3.1.2 TEST PROCEDURE	14
3.1.3 DEVIATION FROM TEST STANDARD	14
3.1.4 TEST SETUP	14
3.1.5 EUT OPERATING CONDITIONS	14
3.1.6 TEST RESULTS	15
3.2 RADIATED EMISSION MEASUREMENT	17
3.2.1 RADIATED EMISSION LIMITS	17
3.2.2 TEST PROCEDURE	18
3.2.3 DEVIATION FROM TEST STANDARD	18
3.2.4 TEST SETUP	19
3.2.5 EUT OPERATING CONDITIONS	20
3.2.6 TEST RESULTS (BETWEEN 9KHZ – 30 MHZ)	21
3.2.7 TEST RESULTS (BETWEEN 30MHZ – 1GHZ)	22
3.2.8 TEST RESULTS (ABOVE 1000 MHZ)	24
<b>4 . POWER SPECTRAL DENSITY TEST</b>	<b>64</b>
4.1 APPLIED PROCEDURES / LIMIT	64
4.1.1 TEST PROCEDURE	64
4.1.2 DEVIATION FROM STANDARD	64
4.1.3 TEST SETUP	64
4.1.4 EUT OPERATION CONDITIONS	64
4.1.5 TEST RESULTS	65
<b>5 . BANDWIDTH TEST</b>	<b>73</b>
5.1 APPLIED PROCEDURES / LIMIT	73
5.1.1 TEST PROCEDURE	73

**Table of Contents**

	<b>Page</b>
5.1.2 DEVIATION FROM STANDARD	73
5.1.3 TEST SETUP	73
5.1.4 EUT OPERATION CONDITIONS	73
5.1.5 TEST RESULTS	74
<b>6 . PEAK OUTPUT POWER TEST</b>	<b>82</b>
6.1 APPLIED PROCEDURES / LIMIT	82
6.1.1 TEST PROCEDURE	82
6.1.2 DEVIATION FROM STANDARD	82
6.1.3 TEST SETUP	82
6.1.4 EUT OPERATION CONDITIONS	82
6.1.5 TEST RESULTS	83
<b>7 . ANTENNA REQUIREMENT</b>	<b>84</b>
7.1 STANDARD REQUIREMENT	84
7.2 EUT ANTENNA	84
<b>8 . EUT TEST PHOTO</b>	<b>85</b>
<b>APPENDIX-PHOTOGRAPHS OF EUT CONSTRUCTIONAL DETAILS</b>	

### 1. SUMMARY OF TEST RESULTS

Test procedures according to the technical standards:

FCC Part15 (15.247) , Subpart C			
Standard Section	Test Item	Judgment	Remark
15.207	Conducted Emission	PASS	
15.247 (a)(2)	6dB Bandwidth	PASS	
15.247 (b)	Peak Output Power	PASS	
15.247 (c)	Radiated Spurious Emission	PASS	
15.247 (d)	Power Spectral Density	PASS	
15.205	Band Edge Emission	PASS	
15.203	Antenna Requirement	PASS	

**NOTE:**

(1) "N/A" denotes test is not applicable in this Test Report

**1.1 TEST FACILITY**

NTEK Testing Technology Co., Ltd

Add. : 1/F, Building E, Fenda Science Park, Sanwei Community, Xixiang Street, Bao'an District, Shenzhen P.R. China.

FCC Registration No.:238937; IC Registration No.:9270A-1

CNAS Registration No.:L5516

**1.2 MEASUREMENT UNCERTAINTY**

The reported uncertainty of measurement  $y \pm U$ , where expanded uncertainty  $U$  is based on a standard uncertainty multiplied by a coverage factor of  $k=2$ , providing a level of confidence of approximately 95 %.

No.	Item	Uncertainty
1	Conducted Emission Test	$\pm 1.38\text{dB}$
2	RF power,conducted	$\pm 0.16\text{dB}$
3	Spurious emissions,conducted	$\pm 0.21\text{dB}$
4	All emissions,radiated(<1G)	$\pm 4.68\text{dB}$
5	All emissions,radiated(>1G)	$\pm 4.89\text{dB}$
6	Temperature	$\pm 0.5^\circ\text{C}$
7	Humidity	$\pm 2\%$

## 2. GENERAL INFORMATION

### 2.1 GENERAL DESCRIPTION OF EUT

Equipment	150M wireless USB adapter	
Trade Name	N/A	
Model Name	MT-WN715N	
Serial Model	N/A	
Model Difference	N/A	
Product Description	The EUT is a 150M wireless USB adapter	
	Operation Frequency:	802.11b/g/n(20):2412~2462 MHz 802.11n(40):2422-2452MHz
	Modulation Type:	802.11b: DSSS (CCK, DQPSK, DBPSK) 802.11g/n: DSSS(CCK,DQPSK,DBPSK) +OFDM(QPSK, BPSK, 16-QAM, 64-QAM)
	Bit Rate of Transmitter	802.11b:11/5.5/2/1 Mbps 802.11g:54/48/36/24/18/12/9/6 Mbps 802.11n:150/144.44/130/117/115.56/104/86.67/78/52/6.5 Mbps
	Number Of Channel	11 CH, Please see Note 2.
	Antenna Designation:	Please see Note 3.
	Output Power(Conducted):	802.11b: 11.76 dBm (Max.) 802.11g: 9.62 dBm (Max.) 802.11n(20M) : 9.59 dBm (Max.) 802.11n(40M) : 9.87 dBm (Max.)
	Antenna Gain (dBi)	1.06dbi
	EIRP	802.11b: 12.82 dBm (Max.) 802.11g: 10.68 dBm (Max.) 802.11n(20M) : 10.65 dBm (Max.) 802.11n(40M) : 10.93 dBm (Max.)
		Based on the application, features, or specification exhibited in User's Manual, the EUT is considered as an ITE/Computing Device. More details of EUT technical specification, please refer to the User's Manual.
Channel List	Please refer to the Note 2.	
Power	0.00 W (Max.)	
Battery	N/A	
Connecting I/O Port(s)	Please refer to the User's Manual	

Note

:

1. For a more detailed features description, please refer to the manufacturer's specifications or the User's Manual.

2.

Channel List for 802.11b/g/n(20MHz)							
Channel	Frequency (MHz)	Channel	Frequency (MHz)	Channel	Frequency (MHz)	Channel	Frequency (MHz)
01	2412	04	2427	07	2442	10	2457
02	2417	05	2432	08	2447	11	2462
03	2422	06	2437	09	2452		

Channel List for 802.11n(40MHz)							
Channel	Frequency (MHz)	Channel	Frequency (MHz)	Channel	Frequency (MHz)	Channel	Frequency (MHz)
03	2422	06	2437	09	2452		
04	2427	07	2442				
05	2432	08	2447				

3.

Table for Filed Antenna

Ant	Brand	Model Name	Antenna Type	Connector	Gain (dBi)	NOTE
A	N/A	N/A	PCB antenna	N/A	1.06	N/A



## 2.2 DESCRIPTION OF TEST MODES

To investigate the maximum EMI emission characteristics generates from EUT, the test system was pre-scanning tested base on the consideration of following EUT operation mode or test configuration mode which possible have effect on EMI emission level. Each of these EUT operation mode(s) or test configuration mode(s) mentioned above was evaluated respectively.

Pretest Mode	Description
Mode 1	802.11b CH1/ CH6/ CH11
Mode 2	802.11g CH1/ CH6/ CH11
Mode 3	802.11n(20) CH1/ CH6/ CH11
Mode 4	802.11n(40) CH3/ CH6/ CH9
Mode 5	NORMAL LINK

For Conducted Emission	
Final Test Mode	Description
Mode 5	NORMAL LINK

For Radiated Emission	
Final Test Mode	Description
Mode 1	802.11b CH1/ CH6/ CH11
Mode 2	802.11g CH1/ CH6/ CH11
Mode 3	802.11n(20) CH1/ CH6/ CH11
Mode 4	802.11n(40) CH3/ CH6/ CH9

Note:

- (1) The measurements are performed at the highest, middle, lowest available channels.
- (2) The measurements are performed at all Bit Rate of Transmitter, the worst data was reported

### 2.3 BLOCK DIGRAM SHOWING THE CONFIGURATION OF SYSTEM TESTED

Conducted Emission Test

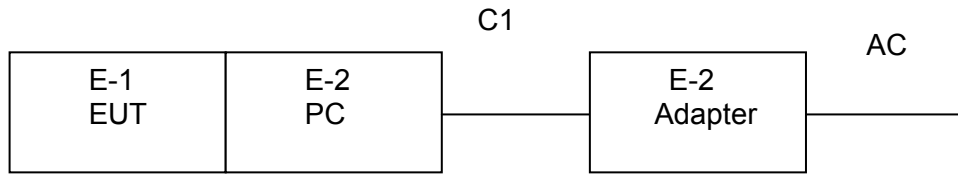

Radiated Spurious Emission Test

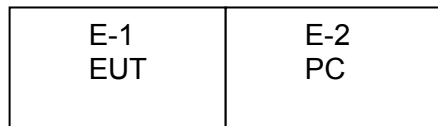

**2.4 DESCRIPTION OF SUPPORT UNITS(CONDUCTED MODE)**

The EUT has been tested as an independent unit together with other necessary accessories or support units. The following support units or accessories were used to form a representative test configuration during the tests.

Item	Equipment	Mfr/Brand	Model/Type No.	Series No.	Note
E-1	150M Wireless USB adapter	N/A	MT-WN715N	N/A	EUT
E-2	Notebook computer	IBM	2366	N/A	
E-3	Adapter	IBM	08K8202	N/A	

Item	Shielded Type	Ferrite Core	Length	Note
C1	NO	NO	0.8M	

**Note:**

- (1) The support equipment was authorized by Declaration of Confirmation.
- (2) For detachable type I/O cable should be specified the length in cm in 『Length』 column.
- (3) The adaptor for power supply of the Notebook is declared referable to US.

**2.5 EQUIPMENTS LIST FOR ALL TEST ITEMS**

**Radiation Test equipment**

Item	Kind of Equipment	Manufacturer	Type No.	Serial No.	Calibrated until
1	Spectrum Analyzer	Agilent	E4407B	160400005	Jul. 06. 2013
2	Test Receiver	R&S	ESPI	101318	Jul. 06. 2013
3	Bilog Antenna	TESEQ	CBL6111D	31216	Jul. 06. 2013
4	50Ω Coaxial Switch	Anritsu	MP59B	6200264416	Jul. 06. 2013
5	Spectrum Analyzer	ADVANTEST	R3132	150900201	Jul. 06. 2013
6	Horn Antenna	EM	EM-AH-10180	2011071402	Jul. 06. 2013
7	Horn Ant	Schwarzbeck	BBHA 9170	9170-181	Jul. 06. 2013
8	Amplifier	EM	EM-30180	060538	Jul. 06. 2013
9	Loop Antenna	ARA	PLA-1030/B	1029	Jul. 06. 2013
10	Power Meter	R&S	NRVS	100696	Jul. 06. 2013

**Conduction Test equipment**

Item	Kind of Equipment	Manufacturer	Type No.	Serial No.	Calibrated until
1	Test Receiver	R&S	ESCI	101160	Jul. 06. 2013
2	LISN	R&S	ENV216	101313	Jul. 06. 2013
3	LISN	EMCO	3816/2	00042990	Jul. 06. 2013
4	50Ω Coaxial Switch	Anritsu	MP59B	6200264417	Jul. 06. 2013
5	Passive Voltage Probe	R&S	ESH2-Z3	100196	Jul. 06. 2013
6	Absorbing clamp	R&S	MOS-21	100423	Jul. 06. 2013

### 3. EMC EMISSION TEST

#### 3.1 CONDUCTED EMISSION MEASUREMENT

##### 3.1.1 POWER LINE CONDUCTED EMISSION Limits (Frequency Range 150KHz-30MHz)

FREQUENCY (MHz)	Class A (dBuV)		Class B (dBuV)		Standard
	Quasi-peak	Average	Quasi-peak	Average	
0.15 -0.5	79.00	66.00	66 - 56 *	56 - 46 *	CISPR
0.50 -5.0	73.00	60.00	56.00	46.00	CISPR
5.0 -30.0	73.00	60.00	60.00	50.00	CISPR

0.15 -0.5	79.00	66.00	66 - 56 *	56 - 46 *	FCC
0.50 -5.0	73.00	60.00	56.00	46.00	FCC
5.0 -30.0	73.00	60.00	60.00	50.00	FCC

Note:

- (1) The tighter limit applies at the band edges.
- (2) The limit of " \* " marked band means the limitation decreases linearly with the logarithm of the frequency in the range.

The following table is the setting of the receiver

Receiver Parameters	Setting
Attenuation	10 dB
Start Frequency	0.15 MHz
Stop Frequency	30 MHz
IF Bandwidth	9 kHz

### 3.1.2 TEST PROCEDURE

- a. The EUT was placed 0.4 meters from the horizontal ground plane with EUT being connected to the power mains through a line impedance stabilization network (LISN). All other support equipments powered from additional LISN(s). The LISN provide 50 Ohm/ 50uH of coupling impedance for the measuring instrument.
- b. Interconnecting cables that hang closer than 40 cm to the ground plane shall be folded back and forth in the center forming a bundle 30 to 40 cm long.
- c. I/O cables that are not connected to a peripheral shall be bundled in the center. The end of the cable may be terminated, if required, using the correct terminating impedance. The overall length shall not exceed 1 m.
- d. LISN at least 80 cm from nearest part of EUT chassis.
- e. For the actual test configuration, please refer to the related Item –EUT Test Photos.

### 3.1.3 DEVIATION FROM TEST STANDARD

No deviation

### 3.1.4 TEST SETUP

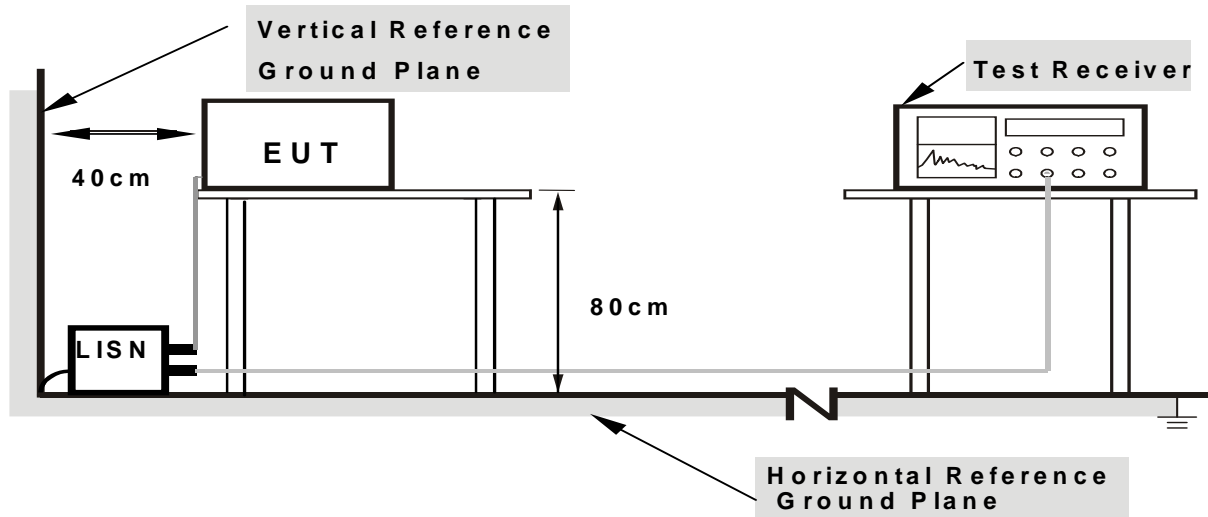

- Note:**
1. Support units were connected to second LISN.
  2. Both of LISNs (AMN) are 80 cm from EUT and at least 80 from other units and other metal planes

### 3.1.5 EUT OPERATING CONDITIONS

The EUT was configured for testing in a typical fashion (as a customer would normally use it). The EUT has been programmed to continuously transmit during test. This operating condition was tested and used to collect the included data.

### 3.1.6 TEST RESULTS

EUT :	150M Wireless USB adapter	Model Name. :	MT-WN715N
Temperature :	26 °C	Relative Humidity :	54%
Pressure :	1010hPa	Phase :	L
Test Voltage :	0.00V	Test Mode :	Mode 5

Frequency (MHz)	Meter Reading (dBμV)	Factor (dB)	Emission Level (dBμV)	Limits (dBμV)	Margin (dB)	Detector Type
0.202	46.05	10.44	56.49	63.52	-7.03	QP
0.202	36.72	10.44	47.16	53.52	-6.36	AVG
4.5899	32.22	10.64	42.86	56	-13.14	QP
4.6577	30.63	10.64	41.27	46	-4.73	AVG
16.1056	34.39	10.71	45.1	60	-14.9	QP
16.3059	26.66	10.71	37.37	50	-12.63	AVG

**Remark:**

1. All readings are Quasi-Peak and Average values.
2. Factor = Insertion Loss + Cable Loss.

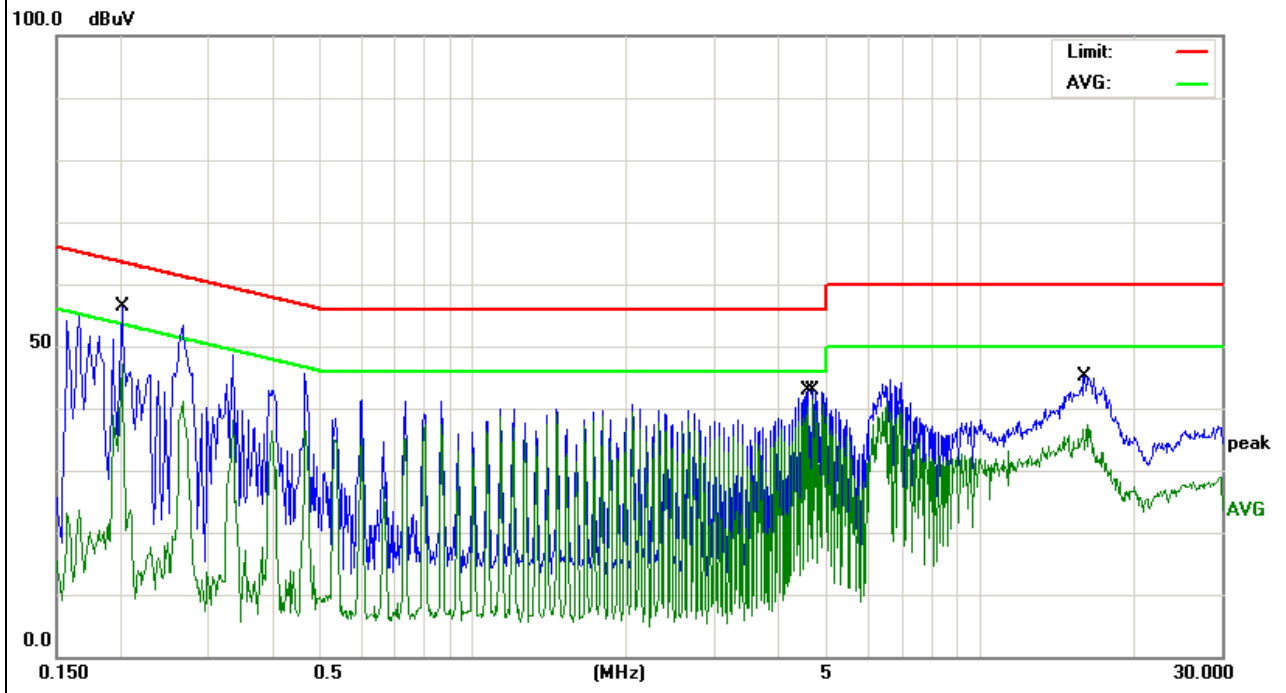

EUT :	150M Wireless USB adapter	Model Name. :	MT-WN715N
Temperature :	26 °C	Relative Humidity :	54%
Pressure :	1010hPa	Phase :	N
Test Voltage :	00A XAWUODAI { AJOA , @AFAFGXDEP:	Test Mode :	Mode 5

Frequency (MHz)	Meter Reading (dBμV)	Factor (dB)	Emission Level (dBμV)	Limits (dBμV)	Margin (dB)	Detector Type
0.2006	43.52	10.43	53.95	63.58	-9.63	QP
0.2028	37.51	10.43	47.94	53.49	-5.55	AVG
1.4697	33	10.45	43.45	46	-2.55	AVG
1.806	34.33	10.44	44.77	56	-11.23	QP
15.6379	35.87	10.73	46.6	50	-3.4	AVG
15.9739	43.24	10.73	53.97	60	-6.03	QP

Remark:

1. All readings are Quasi-Peak and Average values.
2. Factor = Insertion Loss + Cable Loss.

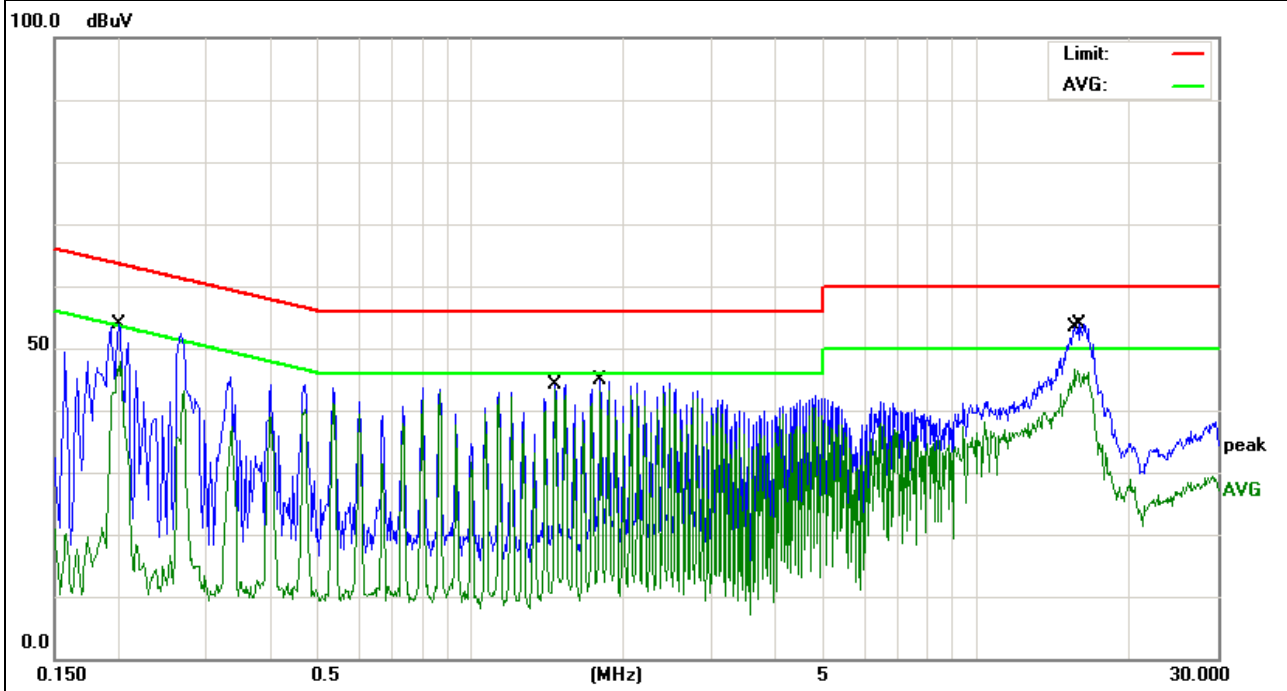



### 3.2 RADIATED EMISSION MEASUREMENT

#### 3.2.1 RADIATED EMISSION LIMITS (Frequency Range 9kHz-1000MHz)

20dBc in any 100 kHz bandwidth outside the operating frequency band. In case the emission fall within the restricted band specified on 15.205(a), then the 15.209(a) limit in the table below has to be followed.

Frequencies (MHz)	Field Strength (microrvolts/meter)	Measurement Distance (meters)
0.009~0.490	2400/F(KHz)	300
0.490~1.705	24000/F(KHz)	30
1.705~30.0	30	30
30~88	100	3
88~216	150	3
216~960	200	3
Above 960	500	3

#### LIMITS OF RADIATED EMISSION MEASUREMENT (Above 1000MHz)

FREQUENCY (MHz)	Class A (dBuV/m) (at 3M)		Class B (dBuV/m) (at 3M)	
	PEAK	AVERAGE	PEAK	AVERAGE
Above 1000	80	60	74	54

Notes:

- (1) The limit for radiated test was performed according to FCC PART 15C.
- (2) The tighter limit applies at the band edges.
- (3) Emission level (dBuV/m)=20log Emission level (uV/m).

Spectrum Parameter	Setting
Attenuation	Auto
Start Frequency	1000 MHz
Stop Frequency	10th carrier harmonic
RB / VB (emission in restricted band)	1 MHz / 1 MHz for Peak, 1 MHz / 10Hz for Average

Receiver Parameter	Setting
Attenuation	Auto
Start ~ Stop Frequency	9kHz~150kHz / RB 200Hz for QP
Start ~ Stop Frequency	150kHz~30MHz / RB 9kHz for QP
Start ~ Stop Frequency	30MHz~1000MHz / RB 120kHz for QP

### 3.2.2 TEST PROCEDURE

- a. The measuring distance of at 3 m shall be used for measurements at frequency up to 1GHz. For frequencies above 1GHz, any suitable measuring distance may be used.
- b. The EUT was placed on the top of a rotating table 0.8 meters above the ground at a 3 meter open area test site. The table was rotated 360 degrees to determine the position of the highest radiation.
- c. The height of the equipment or of the substitution antenna shall be 0.8 m; the height of the test antenna shall vary between 1 m to 4 m. Both horizontal and vertical polarizations of the antenna are set to make the measurement.
- d. The initial step in collecting conducted emission data is a spectrum analyzer peak detector mode pre-scanning the measurement frequency range. Significant peaks are then marked and then Quasi Peak detector mode re-measured.
- e. If the Peak Mode measured value compliance with and lower than Quasi Peak Mode Limit, the EUT shall be deemed to meet QP Limits and then no additional QP Mode measurement performed.
- f. For the actual test configuration, please refer to the related Item –EUT Test Photos.

Note:

Both horizontal and vertical antenna polarities were tested and performed pretest to three orthogonal axis. The worst case emissions were reported

### 3.2.3 DEVIATION FROM TEST STANDARD

No deviation

### 3.2.4 TEST SETUP

#### (A) Radiated Emission Test-Up Frequency Below 30MHz

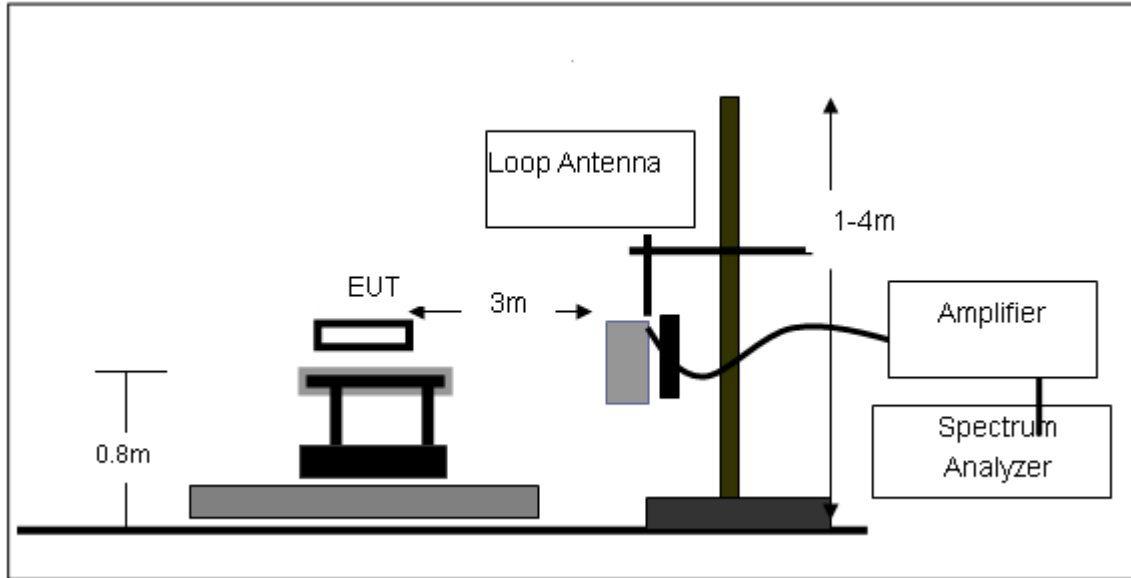

#### (B) Radiated Emission Test-Up Frequency 30MHz~1GHz

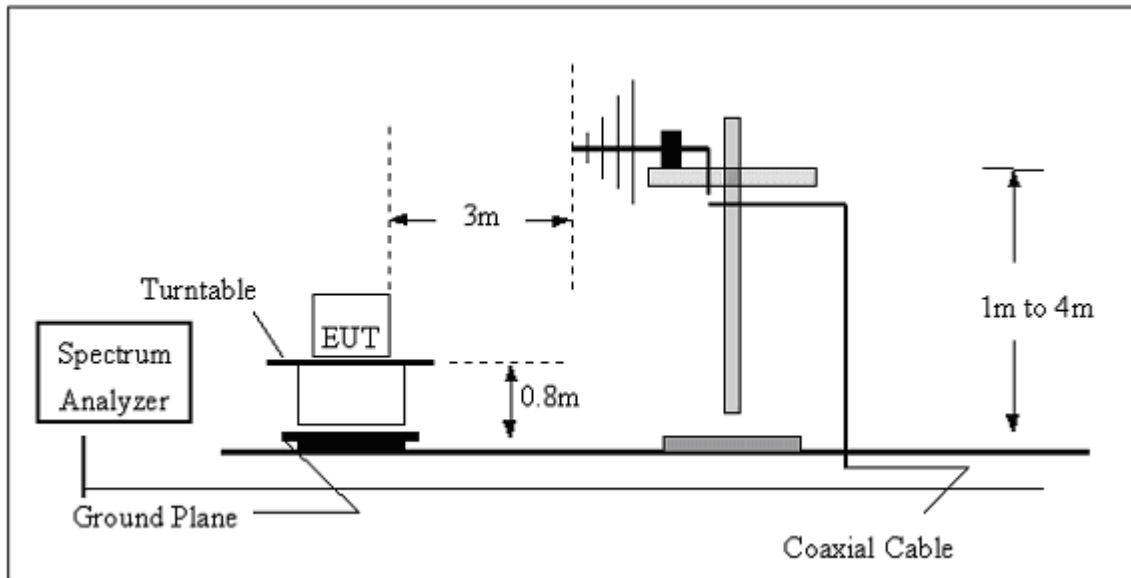

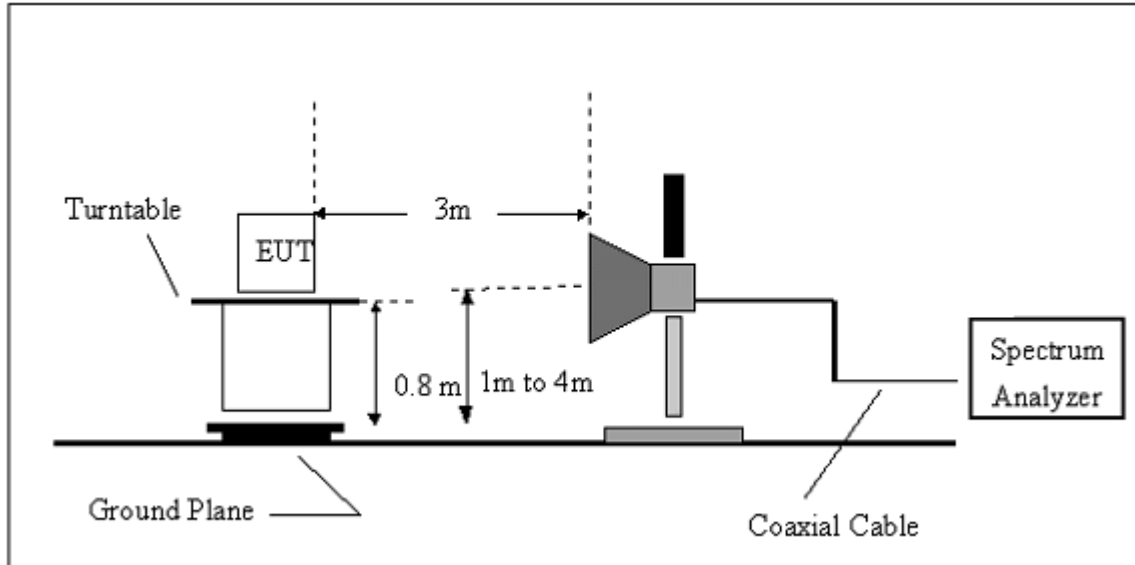
**(C) Radiated Emission Test-Up Frequency Above 1GHz****3.2.5 EUT OPERATING CONDITIONS**

The EUT tested system was configured as the statements of 2.4 Unless otherwise a special operating condition is specified in the follows during the testing.

**3.2.6 TEST RESULTS (BETWEEN 9KHZ – 30 MHZ)**

EUT:	150M Wireless USB adapter	Model Name. :	MT-WN715N
Temperature:	20 °C	Relative Humidity:	48%
Pressure:	1010 hPa	Test Voltage :	DC 5.0V
Test Mode :	TX	Polarization :	--

Freq. (MHz)	Reading (dBuV/m)	Limit (dBuV/m)	Margin (dB)	State P/F
--	--	--	--	PASS
--	--	--	--	PASS

**NOTE:**

The amplitude of spurious emissions which are attenuated by more than 20dB below the permissible value has no need to be reported.

Distance extrapolation factor =  $20 \log (\text{specific distance}/\text{test distance})(\text{dB})$ ;

Limit line = specific limits(dBuv) + distance extrapolation factor.

### 3.2.7 TEST RESULTS (BETWEEN 30MHZ – 1GHZ)

EUT :	150M Wireless USB adapter	Model Name :	MT-WN715N
Temperature :	20 °C	Relative Humidity :	48%
Pressure :	1010 hPa	Test Voltage :	DC 5.0V
Test Mode :	TX	Polarization :	Horizontal

Frequency (MHz)	Meter Reading (dBµV)	Factor (dB)	Emission Level (dBµV/m)	Limits (dBµV/m)	Margin (dB)	Detector Type
48.5016	24.51	8.89	33.4	40	-6.6	QP
200.688	25	8.74	33.74	43.5	-9.76	QP
721.7259	12.49	23.14	35.63	46	-10.37	QP

Remark:  
Factor = Antenna Factor + Cable Loss – Pre-amplifier.

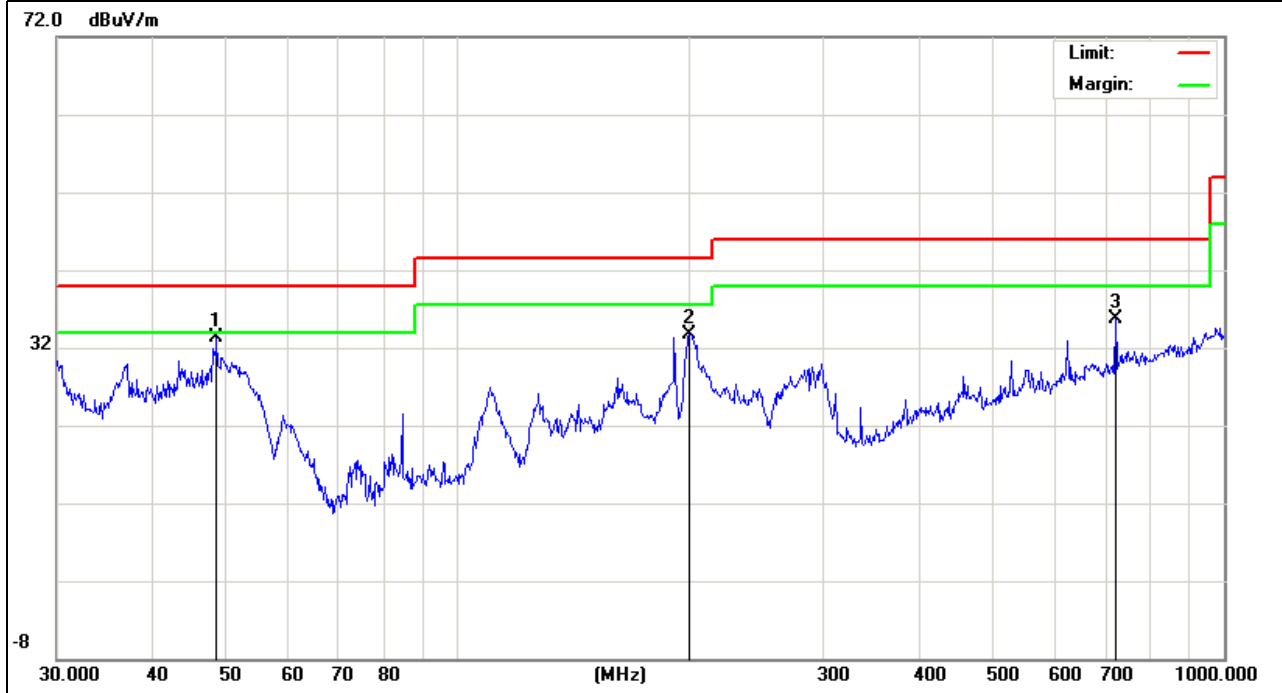

EUT :	150M Wireless USB adapter	Model Name :	MT-WN715N
Temperature :	20 °C	Relative Humidity :	48%
Pressure :	1010 hPa	Test Voltage :	DC 5.0V
Test Mode :	TX	Polarization :	Vertical

Frequency (MHz)	Meter Reading (dBμV)	Factor (dB)	Emission Level (dBμV/m)	Limits (dBμV/m)	Margin (dB)	Detector Type
200.688	26.27	8.74	35.01	43.5	-8.49	QP
383.9318	21.25	16.6	37.85	46	-8.15	QP
721.7259	14.31	23.14	37.45	46	-8.55	QP

**Remark:**

Factor = Antenna Factor + Cable Loss – Pre-amplifier.

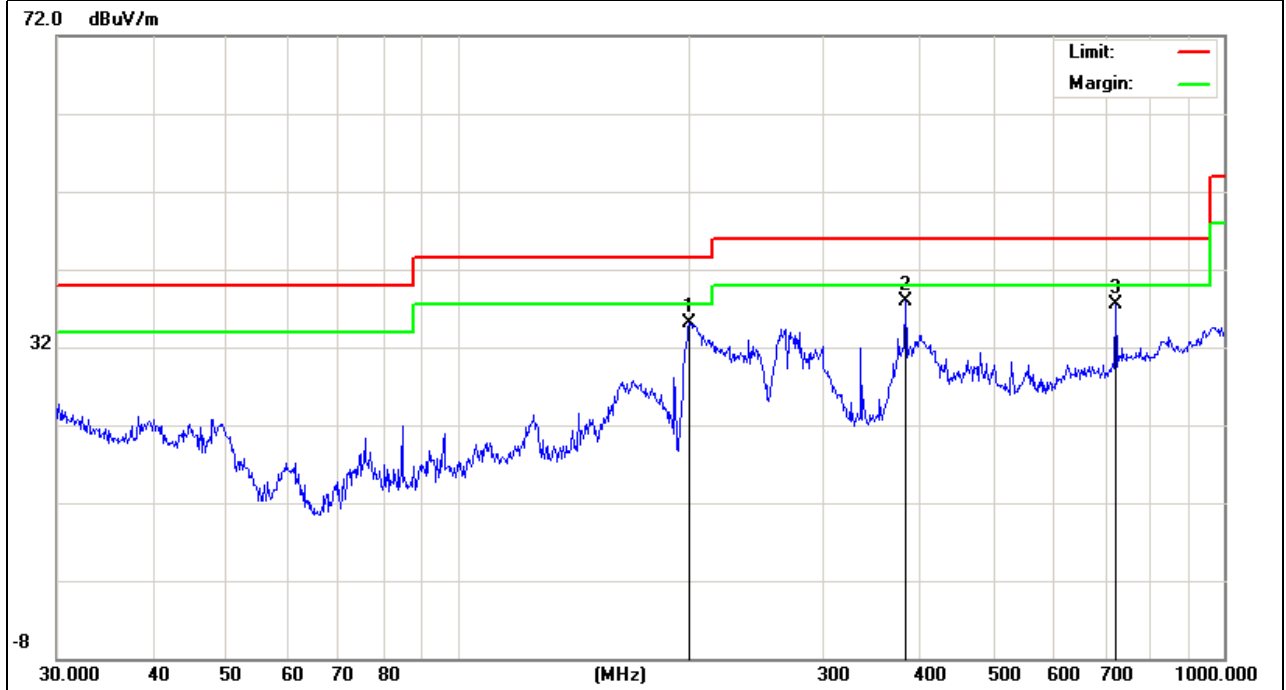

### 3.2.8 TEST RESULTS (ABOVE 1000 MHZ)

EUT :	150M Wireless USB adapter	Model Name :	MT-WN715N
Temperature :	20 °C	Relative Humidity :	48%
Pressure :	1010 hPa	Test Voltage :	DC 5.0V
Test Mode :	CH1 (802.11b Mode)	Polarization :	Horizontal

Frequency (MHz)	Meter Reading (dBμV)	Factor (dB)	Emission Level (dBμV/m)	Limits (dBμV/m)	Margin (dB)	Detector Type
4824	55.59	2.6	58.19	74	-15.81	peak
4824	38.48	2.6	41.08	54	-12.92	AVG
7236	49.44	4.59	54.03	74	-19.97	peak
7236	29.88	4.59	34.47	54	-19.53	AVG

Remark:  
Factor = Antenna Factor + Cable Loss – Pre-amplifier.

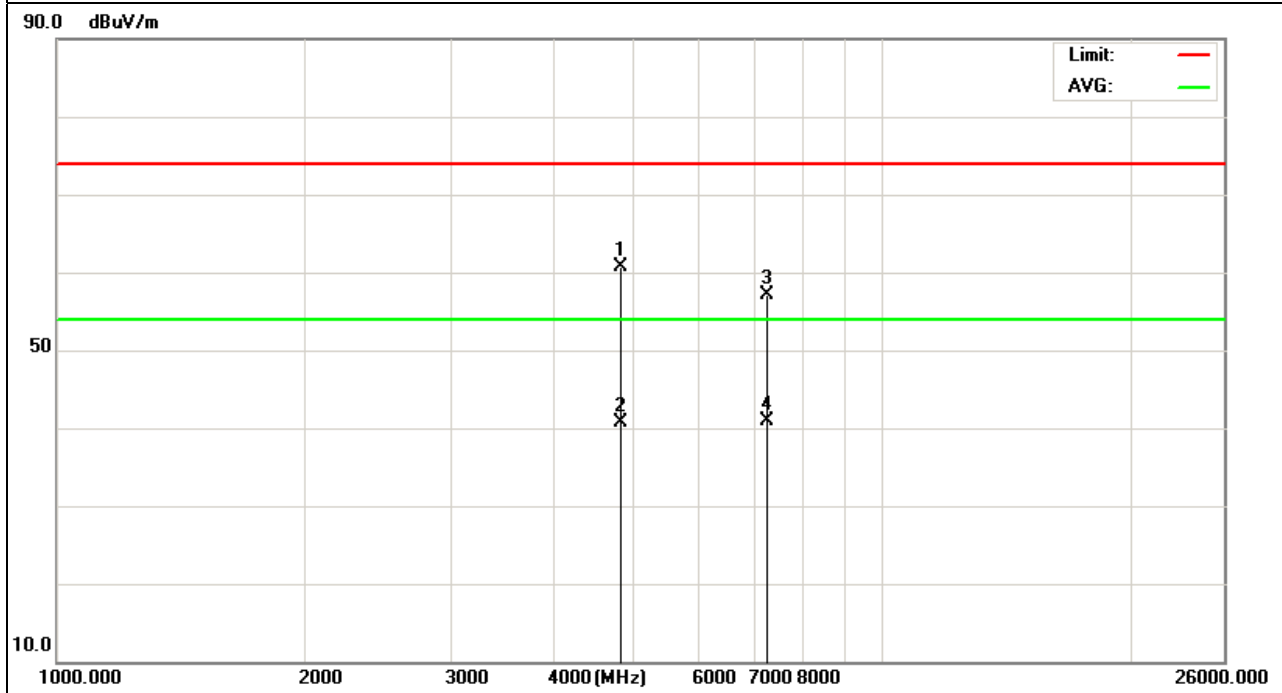



EUT :	150M Wireless USB adapter	Model Name :	MT-WN715N
Temperature :	20 °C	Relative Humidity :	48%
Pressure :	1010 hPa	Test Voltage :	DC 5.0V
Test Mode :	CH1 (802.11b Mode)	Polarization :	Vertical

Frequency (MHz)	Meter Reading (dBµV)	Factor (dB)	Emission Level (dBµV/m)	Limits (dBµV/m)	Margin (dB)	Detector Type
4824	55.59	2.6	58.19	74	-15.81	peak
4824	38.48	2.6	41.08	54	-12.92	AVG
7236	49.44	4.59	54.03	74	-19.97	peak
7236	29.88	4.59	34.47	54	-19.53	AVG

Remark:  
Factor = Antenna Factor + Cable Loss – Pre-amplifier.

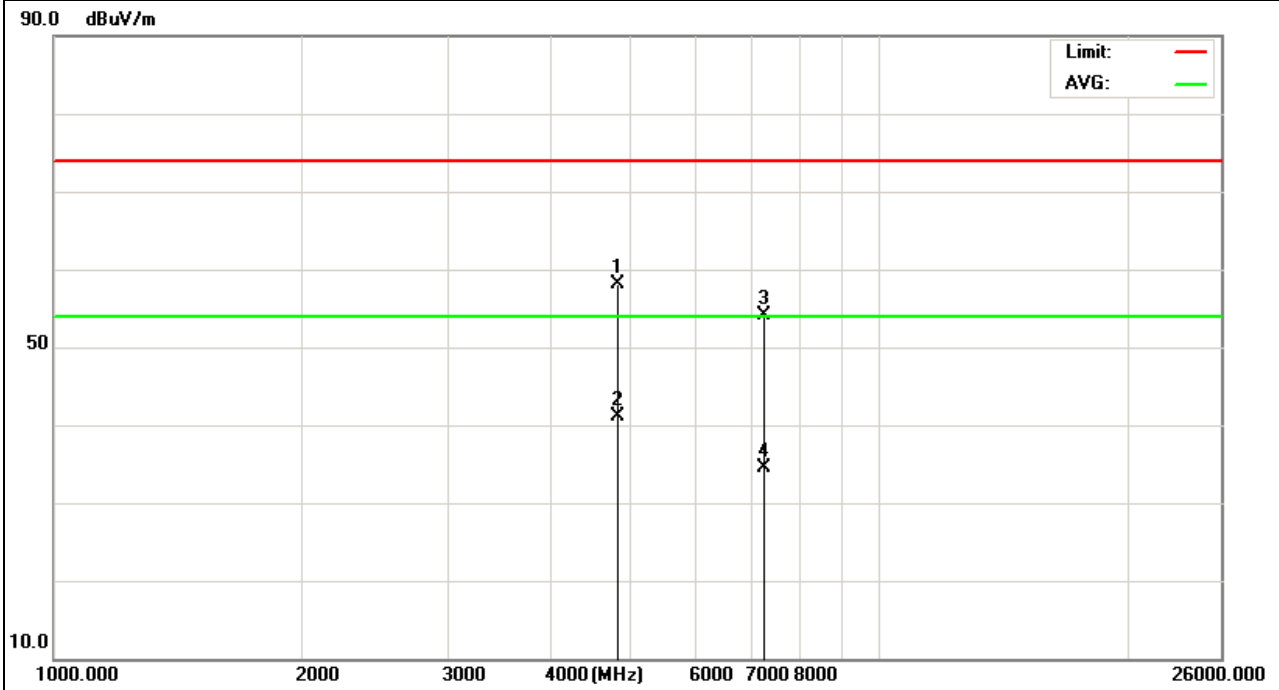

EUT :	150M Wireless USB adapter	Model Name :	MT-WN715N
Temperature :	20 °C	Relative Humidity :	48%
Pressure :	1010 hPa	Test Voltage :	DC 5.0V
Test Mode :	CH6 (802.11b Mode)	Polarization :	Horizontal

Frequency (MHz)	Meter Reading (dBμV)	Factor (dB)	Emission Level (dBμV/m)	Limits (dBμV/m)	Margin (dB)	Detector Type
4874	57.95	2.6	60.55	74	-13.45	peak
4874	40.08	2.6	42.68	54	-11.32	AVG
7311	50.45	4.93	55.38	74	-18.62	peak
7311	36.88	4.93	41.81	54	-12.19	AVG

Remark:  
Factor = Antenna Factor + Cable Loss – Pre-amplifier.

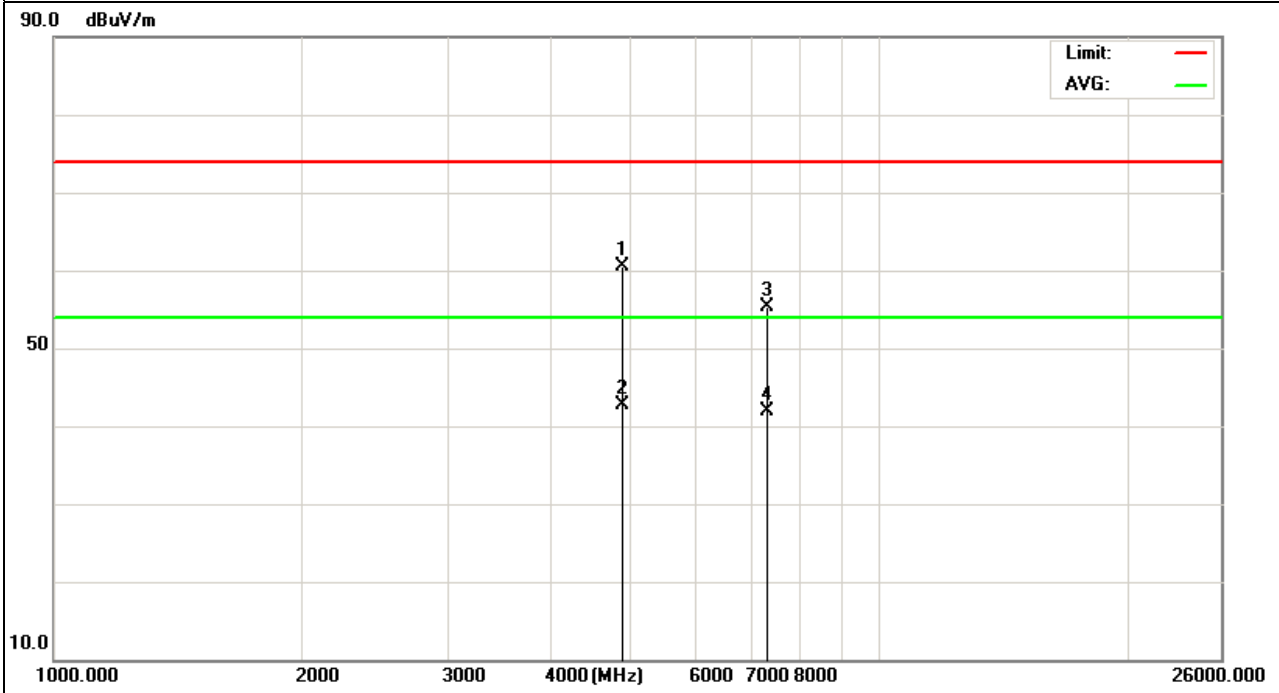

EUT :	150M wireless USB adapter	Model Name :	MT-WN715N
Temperature :	20 °C	Relative Humidity :	48%
Pressure :	1010 hPa	Test Voltage :	DC 5.0V
Test Mode :	CH6 (802.11b Mode)	Polarization :	Vertical

Frequency (MHz)	Meter Reading (dBμV)	Factor (dB)	Emission Level (dBμV/m)	Limits (dBμV/m)	Margin (dB)	Detector Type
4874	56.64	2.6	59.24	74	-14.76	peak
4874	40.19	2.6	42.79	54	-11.21	AVG
7311	50.44	4.93	55.37	74	-18.63	peak
7311	39	4.93	43.93	54	-10.07	AVG

Remark:

Factor = Antenna Factor + Cable Loss – Pre-amplifier.

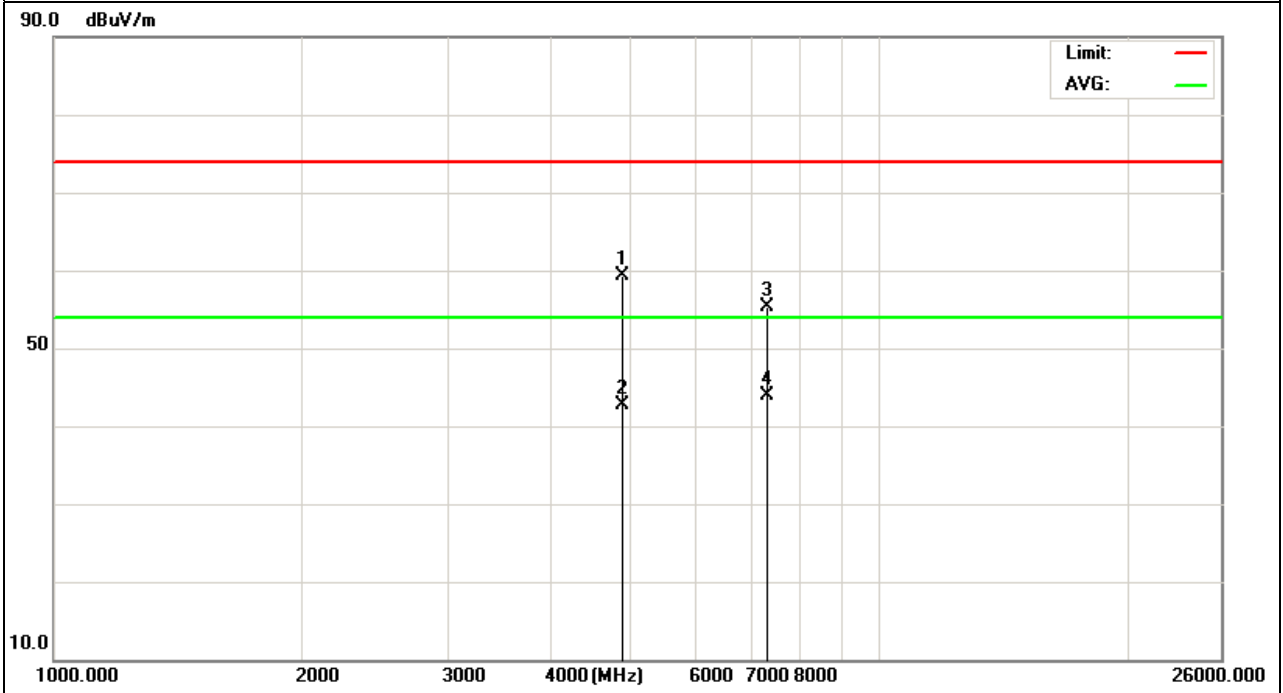

EUT :	150M Wireless USB adapter	Model Name :	MT-WN715N
Temperature :	20 °C	Relative Humidity :	48%
Pressure :	1010 hPa	Test Voltage :	DC 5.0V
Test Mode :	CH11 (802.11b Mode)	Polarization :	Horizontal

Frequency (MHz)	Meter Reading (dBμV)	Factor (dB)	Emission Level (dBμV/m)	Limits (dBμV/m)	Margin (dB)	Detector Type
4924	56.85	2.6	59.45	74	-14.55	peak
4924	39.06	2.6	41.66	54	-12.34	AVG
7386	48.45	4.93	53.38	74	-20.62	peak
7386	30.88	4.93	35.81	54	-18.19	AVG

Remark:

- Factor = Antenna Factor + Cable Loss – Pre-amplifier.
- No emission detected above 18GHz

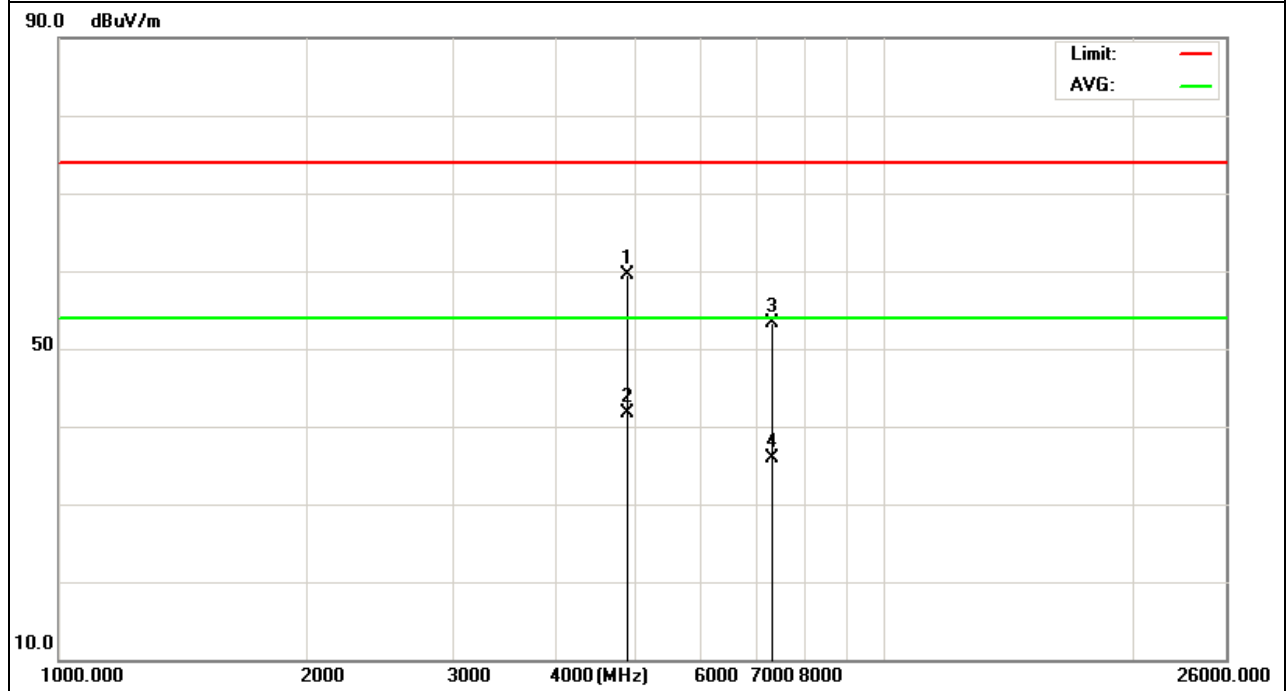

EUT :	150M Wireless USB adapter	Model Name :	MT-WN715N
Temperature :	20 °C	Relative Humidity :	48%
Pressure :	1010 hPa	Test Voltage :	DC 5.0V
Test Mode :	CH11 (802.11b Mode)	Polarization :	Vertical

Frequency (MHz)	Meter Reading (dBμV)	Factor (dB)	Emission Level (dBμV/m)	Limits (dBμV/m)	Margin (dB)	Detector Type
4924	57.79	2.6	60.39	74	-13.61	peak
4924	40.02	2.6	42.62	54	-11.38	AVG
7386	51.22	4.83	56.05	74	-17.95	peak
7386	31.76	4.83	36.59	54	-17.41	AVG

Remark:  
Factor = Antenna Factor + Cable Loss – Pre-amplifier.

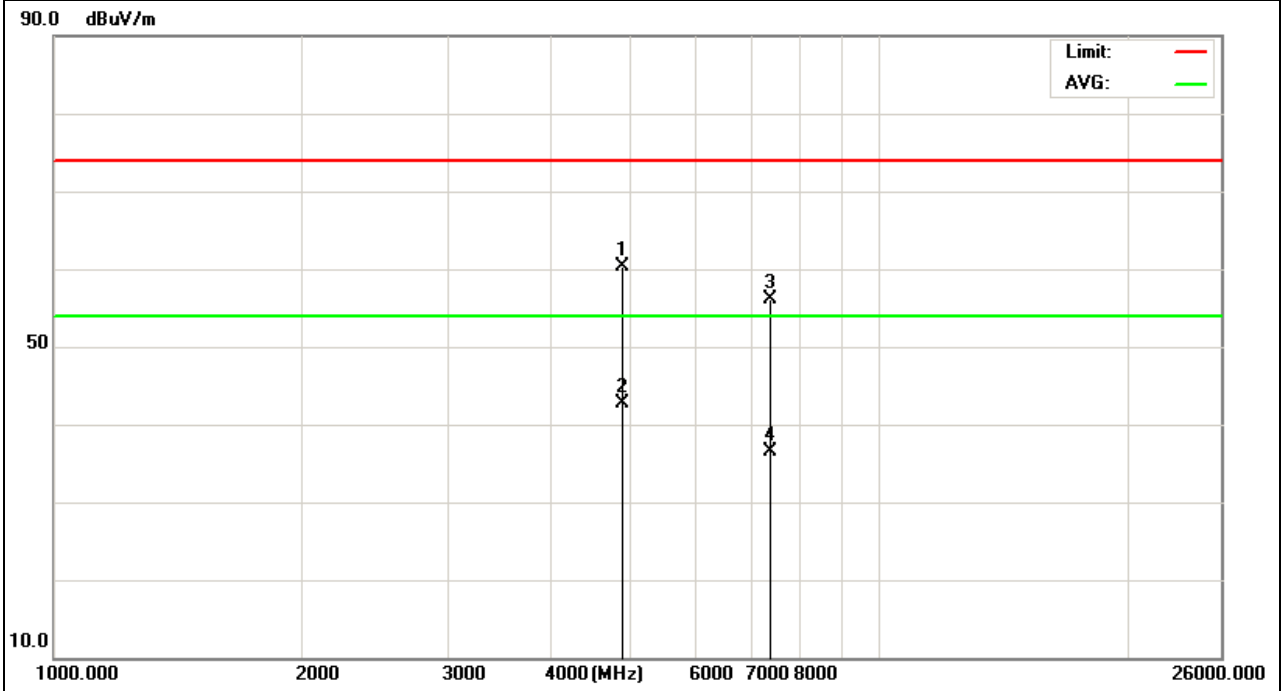

EUT :	150M Wireless USB adapter	Model Name :	MT-WN715N
Temperature :	20 °C	Relative Humidity :	48%
Pressure :	1010 hPa	Test Voltage :	DC 5.0V
Test Mode :	CH1 (802.11g Mode)	Polarization :	Horizontal

Frequency (MHz)	Meter Reading (dBμV)	Factor (dB)	Emission Level (dBμV/m)	Limits (dBμV/m)	Margin (dB)	Detector Type
4824	53.61	2.6	56.21	74	-17.79	peak
4824	35.6	2.6	38.2	54	-15.8	AVG
7236	47.36	4.59	51.95	74	-22.05	peak
7236	28.99	4.59	33.58	54	-20.42	AVG

Remark:  
Factor = Antenna Factor + Cable Loss – Pre-amplifier.

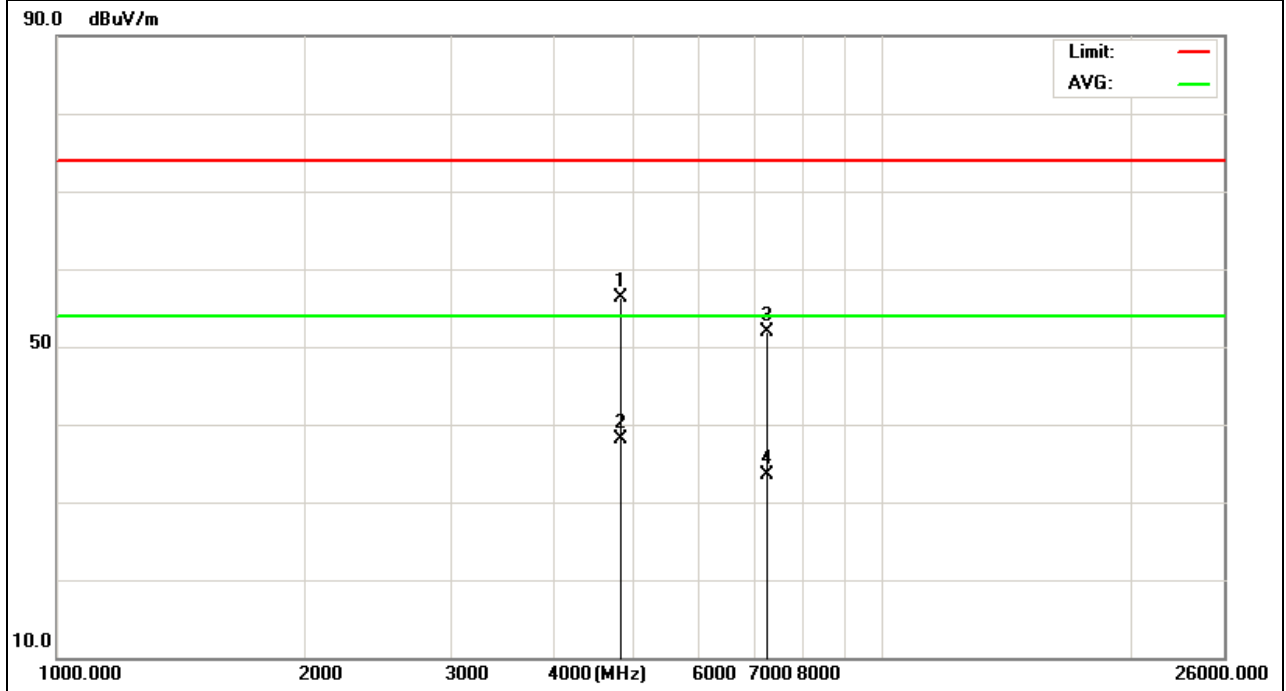

EUT :	150M Wireless USB adapter	Model Name :	MT-WN715N
Temperature :	20 °C	Relative Humidity :	48%
Pressure :	1010 hPa	Test Voltage :	DC 5.0V
Test Mode :	CH1 (802.11g Mode)	Polarization :	Vertical

Frequency (MHz)	Meter Reading (dBμV)	Factor (dB)	Emission Level (dBμV/m)	Limits (dBμV/m)	Margin (dB)	Detector Type
4824	53.7	2.6	56.3	74	-17.7	peak
4824	34.92	2.6	37.52	54	-16.48	AVG
7236	46.79	4.59	51.38	74	-22.62	peak
7236	29.02	4.59	33.61	54	-20.39	AVG

Remark:  
Factor = Antenna Factor + Cable Loss – Pre-amplifier.

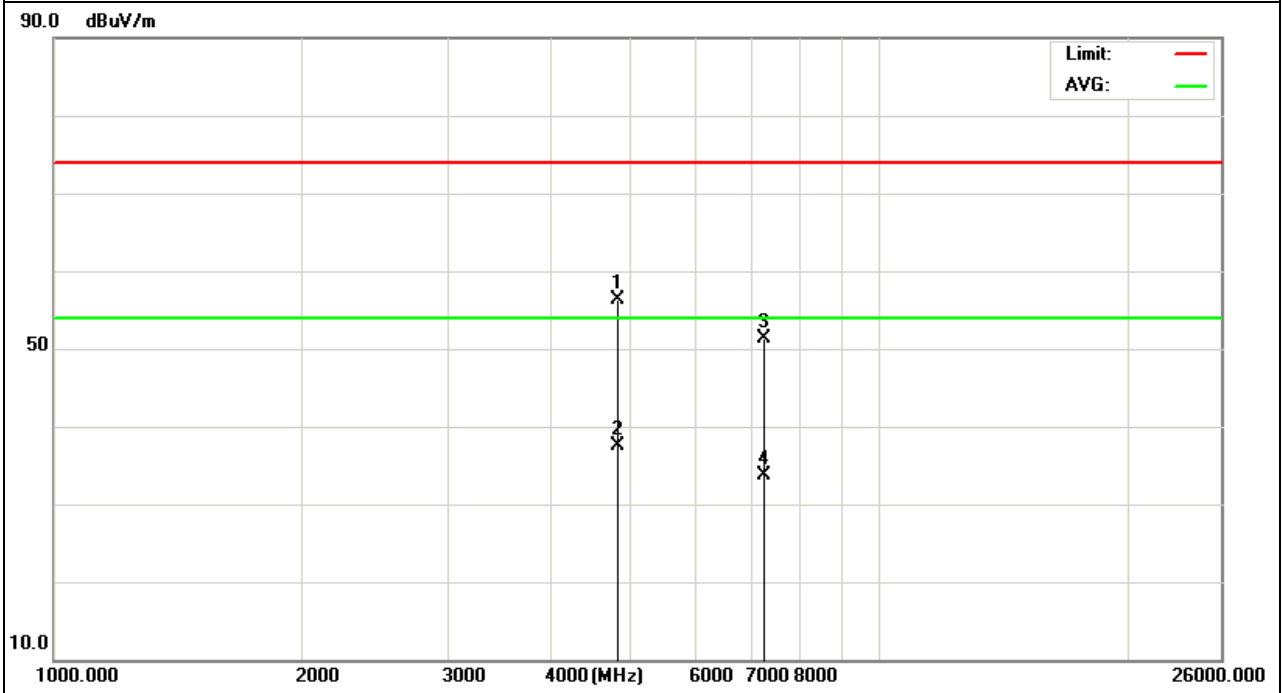

EUT :	150M Wireless USB adapter	Model Name :	MT-WN715N
Temperature :	20 °C	Relative Humidity :	48%
Pressure :	1010 hPa	Test Voltage :	DC 5.0V
Test Mode :	CH6 (802.11g Mode)	Polarization :	Horizontal

Frequency (MHz)	Meter Reading (dBμV)	Factor (dB)	Emission Level (dBμV/m)	Limits (dBμV/m)	Margin (dB)	Detector Type
4874	54.97	2.57	57.54	74	-16.46	peak
4874	37.99	2.57	40.56	54	-13.44	AVG
7311	51.1	4.93	56.03	74	-17.97	peak
7311	34.88	4.93	39.81	54	-14.19	AVG

Remark:  
Factor = Antenna Factor + Cable Loss – Pre-amplifier.

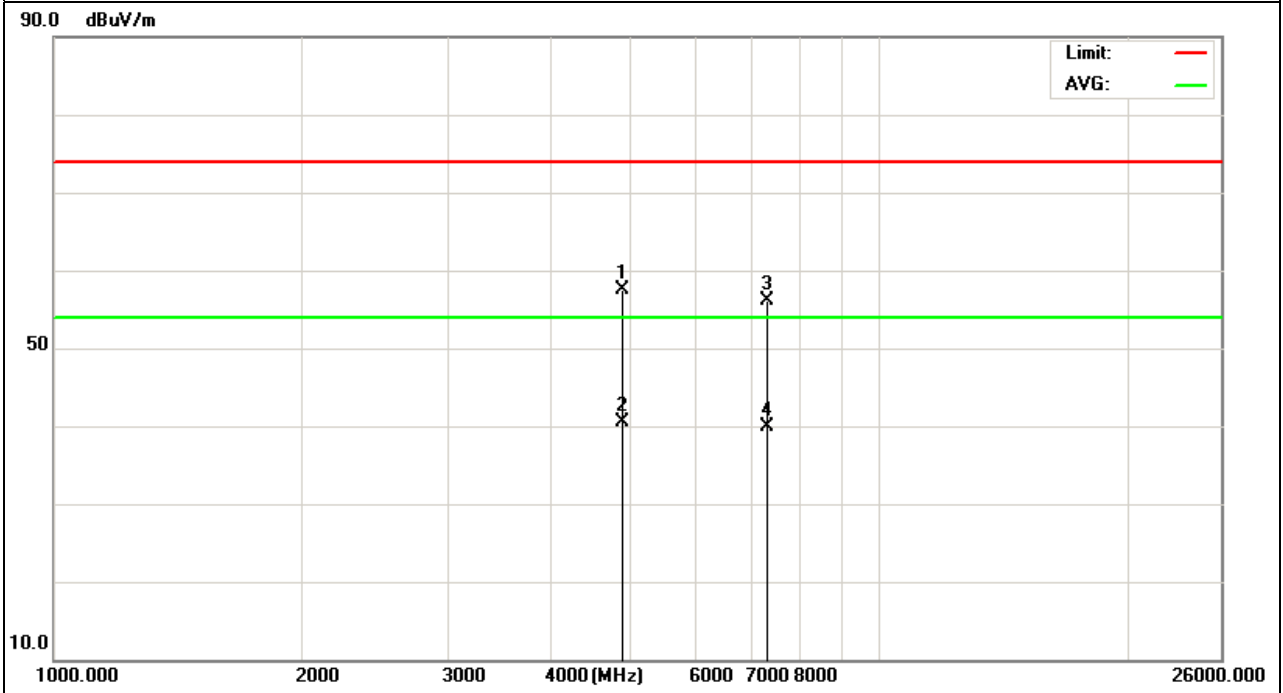



EUT :	150M Wireless USB adapter	Model Name :	MT-WN715N
Temperature :	20 °C	Relative Humidity :	48%
Pressure :	1010 hPa	Test Voltage :	DC 5.0V
Test Mode :	CH6 (802.11g Mode)	Polarization :	Vertical

Frequency (MHz)	Meter Reading (dBμV)	Factor (dB)	Emission Level (dBμV/m)	Limits (dBμV/m)	Margin (dB)	Detector Type
4874	56.01	2.6	58.61	74	-15.39	peak
4874	40.02	2.6	42.62	54	-11.38	AVG
7311	51.22	4.93	56.15	74	-17.85	peak
7311	31.32	4.93	36.25	54	-17.75	AVG

Remark:  
 Factor = Antenna Factor + Cable Loss – Pre-amplifier.

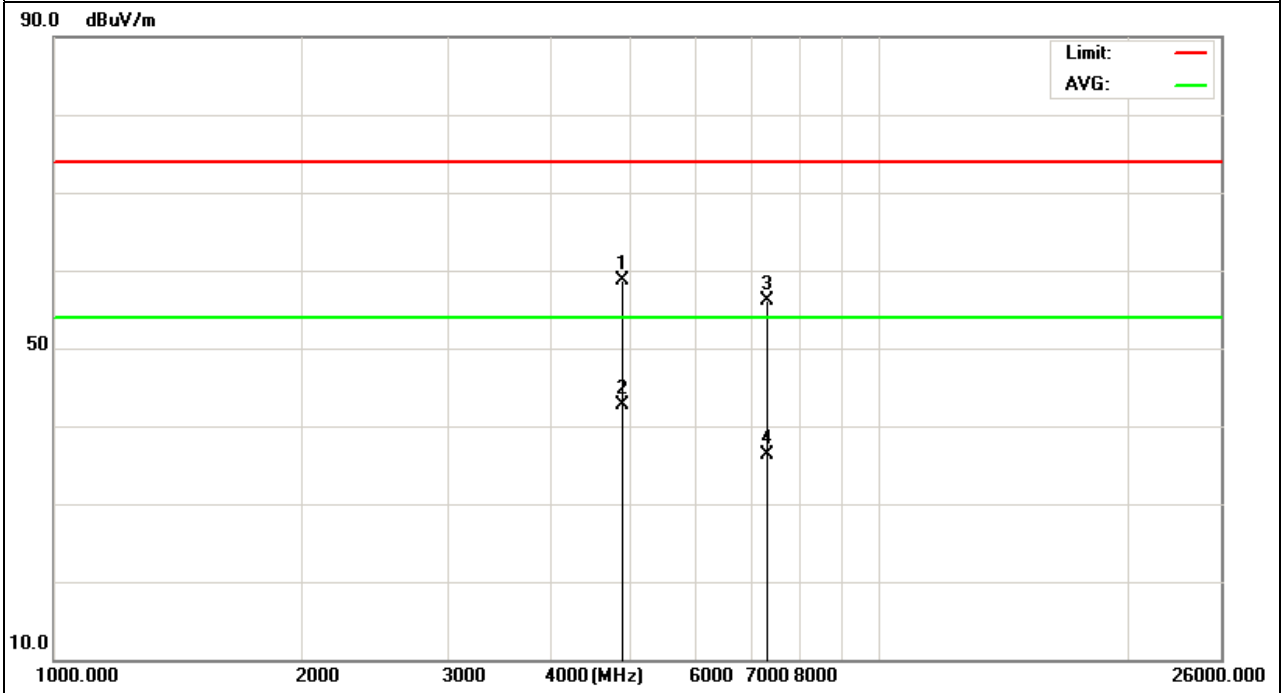

EUT :	150M Wireless USB adapter	Model Name :	MT-WN715N
Temperature :	20 °C	Relative Humidity :	48%
Pressure :	1010 hPa	Test Voltage :	DC 5.0V
Test Mode :	CH11 (802.11g Mode)	Polarization :	Horizontal

Frequency (MHz)	Meter Reading (dBµV)	Factor (dB)	Emission Level (dBµV/m)	Limits (dBµV/m)	Margin (dB)	Detector Type
4924	54.23	2.6	56.83	74	-17.17	peak
4924	36.22	2.6	38.82	54	-15.18	AVG
7386	49.33	4.93	54.26	74	-19.74	peak
7386	31.43	4.93	36.36	54	-17.64	AVG

Remark:  
Factor = Antenna Factor + Cable Loss – Pre-amplifier.

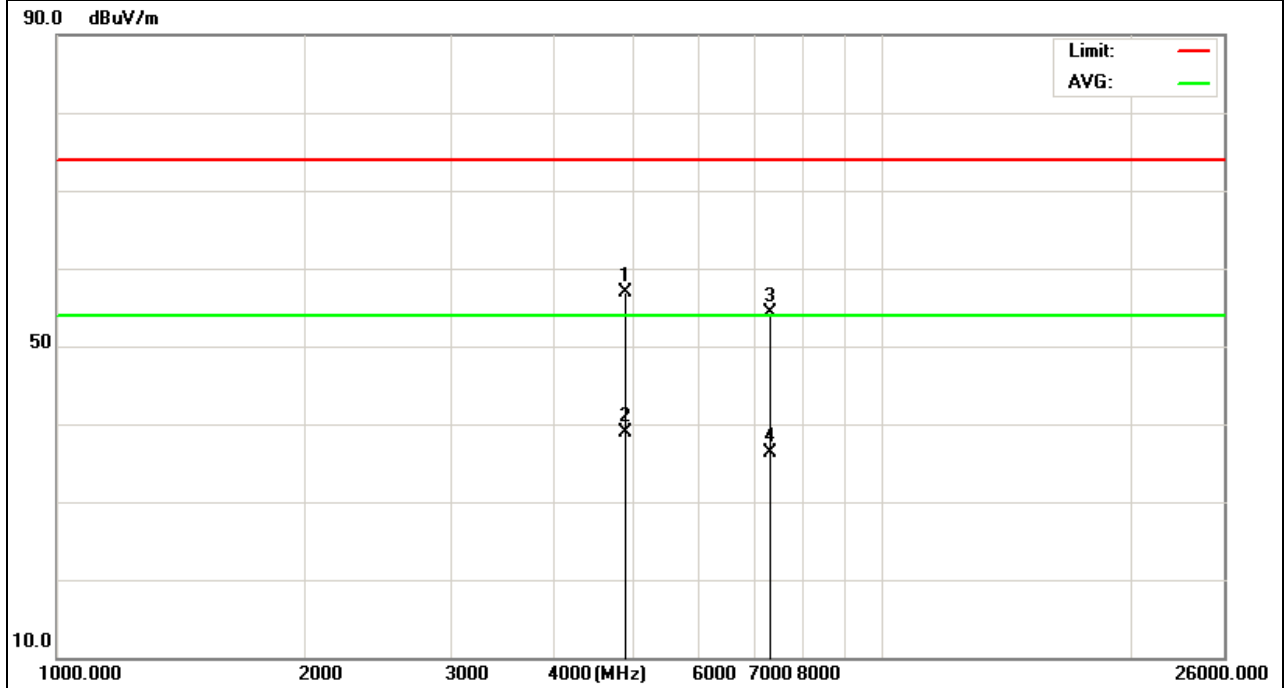

EUT :	150M Wireless USB adapter	Model Name :	MT-WN715N
Temperature :	20 °C	Relative Humidity :	48%
Pressure :	1010 hPa	Test Voltage :	DC 5.0V
Test Mode :	CH11(802.11g Mode)	Polarization :	Vertical

Frequency (MHz)	Meter Reading (dBμV)	Factor (dB)	Emission Level (dBμV/m)	Limits (dBμV/m)	Margin (dB)	Detector Type
4924	65.21	-8.22	56.99	74	-17.01	peak
4924	54.11	-8.22	45.89	54	-8.11	AVG
7386	61.89	-7.39	54.5	74	-19.5	peak
7386	50.09	-7.39	42.7	54	-11.3	AVG

Remark:  
Factor = Antenna Factor + Cable Loss – Pre-amplifier.

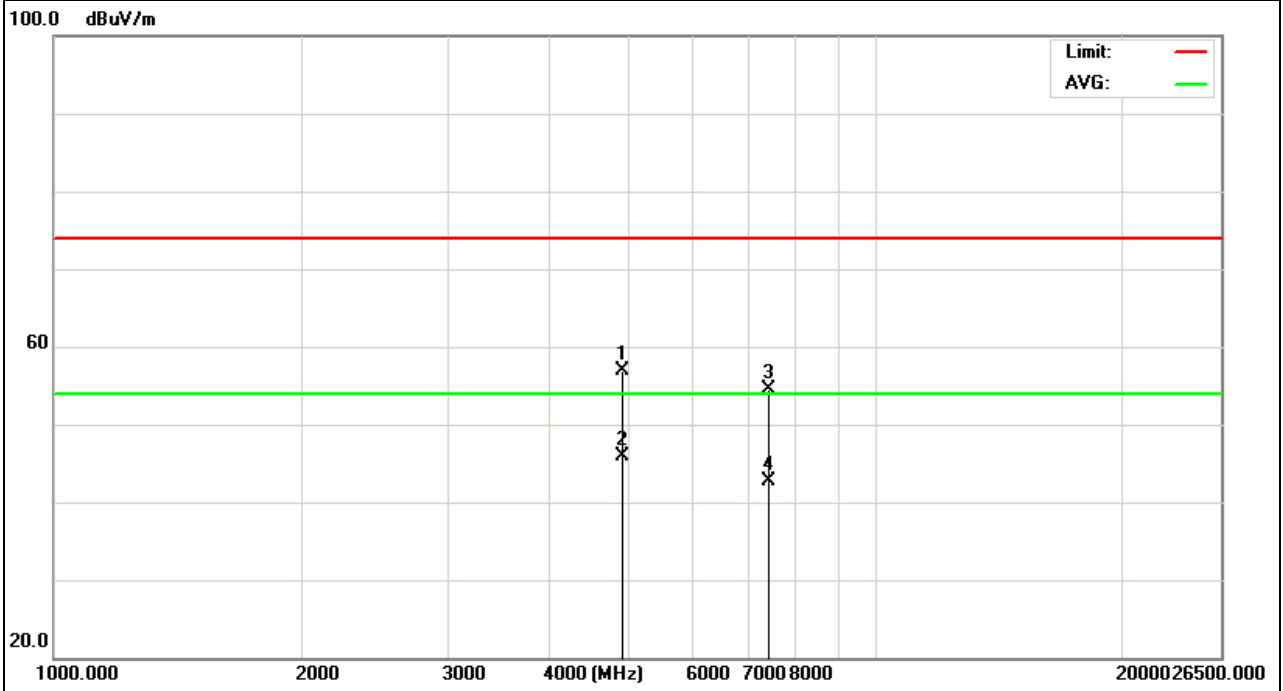

EUT :	150M Wireless USB adapter	Model Name :	MT-WN715N
Temperature :	20 °C	Relative Humidity :	48%
Pressure :	1010 hPa	Test Voltage :	DC 5.0V
Test Mode :	CH1 (802.11n/20M Mode)	Polarization :	Horizontal

Frequency (MHz)	Meter Reading (dBµV)	Factor (dB)	Emission Level (dBµV/m)	Limits (dBµV/m)	Margin (dB)	Detector Type
4824	58.18	2.6	60.78	74	-13.22	peak
4824	38.03	2.6	40.63	54	-13.37	AVG
7236	52.58	4.59	57.17	74	-16.83	peak
7236	36.33	4.59	40.92	54	-13.08	AVG

Remark:

Factor = Antenna Factor + Cable Loss – Pre-amplifier.

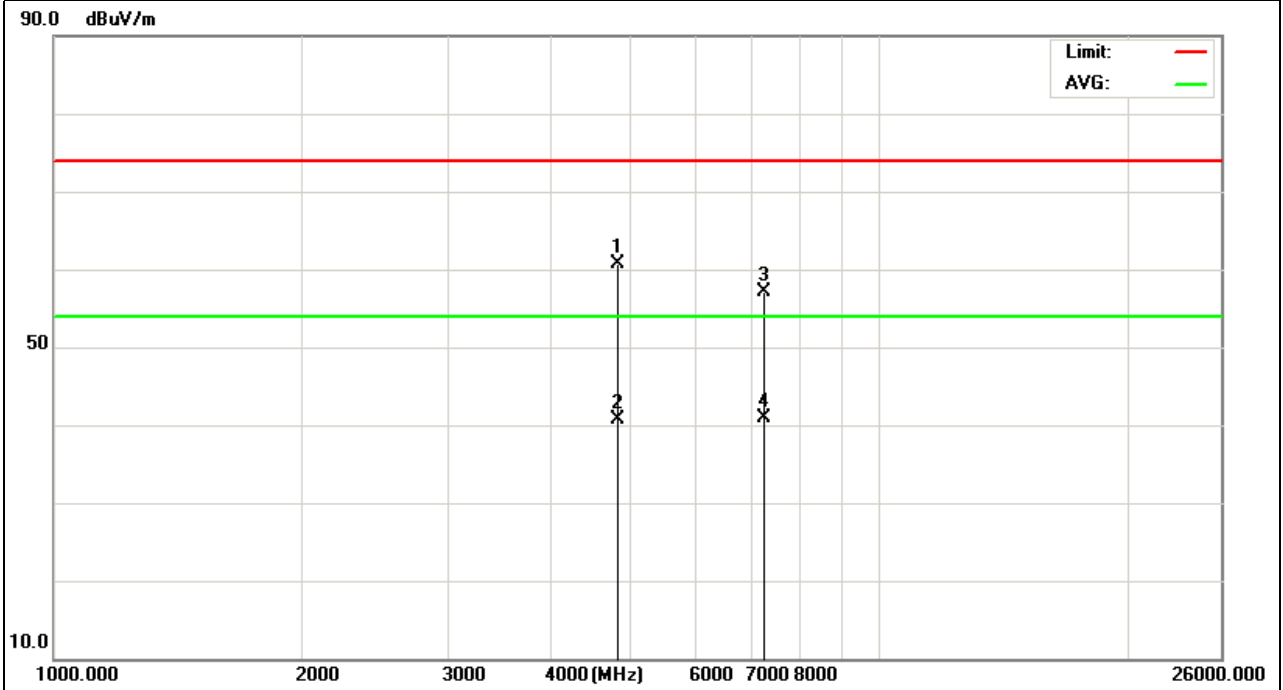

EUT :	150M Wireless USB adapter	Model Name :	MT-WN715N
Temperature :	20 °C	Relative Humidity :	48%
Pressure :	1010 hPa	Test Voltage :	DC 5.0V
Test Mode :	CH1 (802.11n/20M Mode)	Polarization :	Vertical

Frequency (MHz)	Meter Reading (dBµV)	Factor (dB)	Emission Level (dBµV/m)	Limits (dBµV/m)	Margin (dB)	Detector Type
4824	55.59	2.6	58.19	74	-15.81	peak
4824	38.48	2.6	41.08	54	-12.92	AVG
7236	49.44	4.59	54.03	74	-19.97	peak
7236	29.88	4.59	34.47	54	-19.53	AVG

Remark:  
Factor = Antenna Factor + Cable Loss – Pre-amplifier.

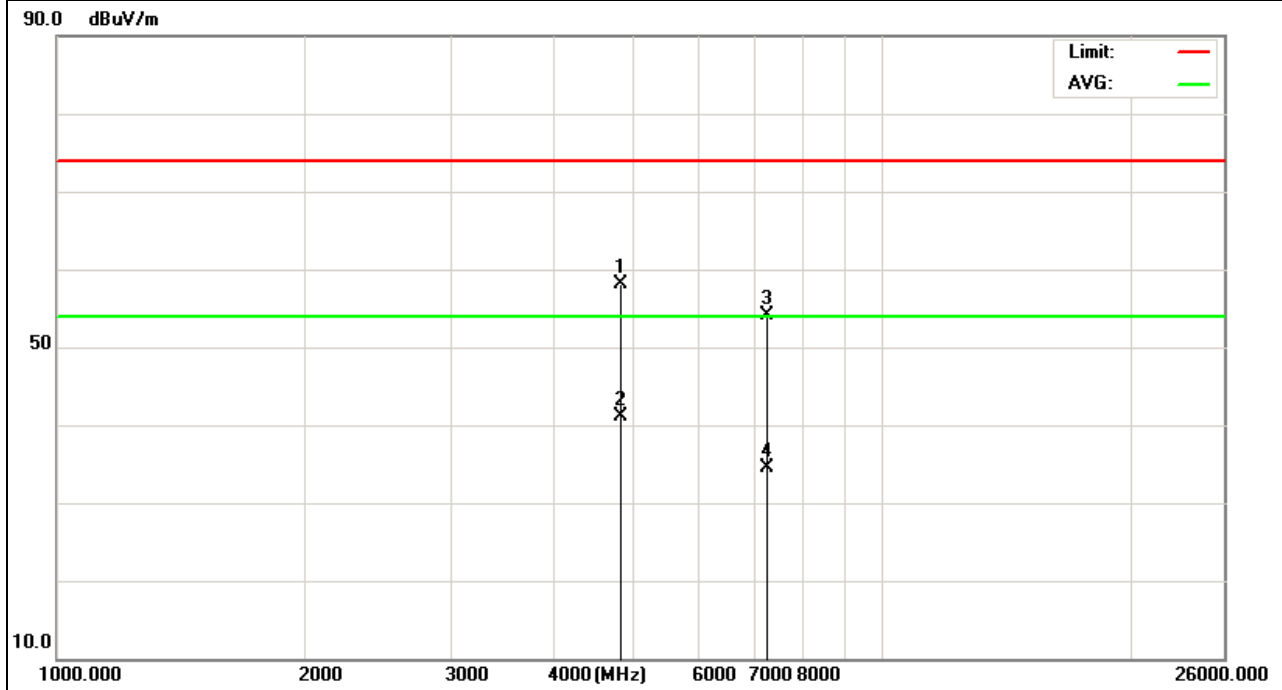

EUT :	150M Wireless USB adapter	Model Name :	MT-WN715N
Temperature :	20 °C	Relative Humidity :	48%
Pressure :	1010 hPa	Test Voltage :	DC 5.0V
Test Mode :	CH6 (802.11n/20M Mode)	Polarization :	Horizontal

Frequency (MHz)	Meter Reading (dBμV)	Factor (dB)	Emission Level (dBμV/m)	Limits (dBμV/m)	Margin (dB)	Detector Type
4874	57.95	2.6	60.55	74	-13.45	peak
4874	40.08	2.6	42.68	54	-11.32	AVG
7311	50.45	4.93	55.38	74	-18.62	peak
7311	36.88	4.93	41.81	54	-12.19	AVG

Remark:  
Factor = Antenna Factor + Cable Loss – Pre-amplifier.

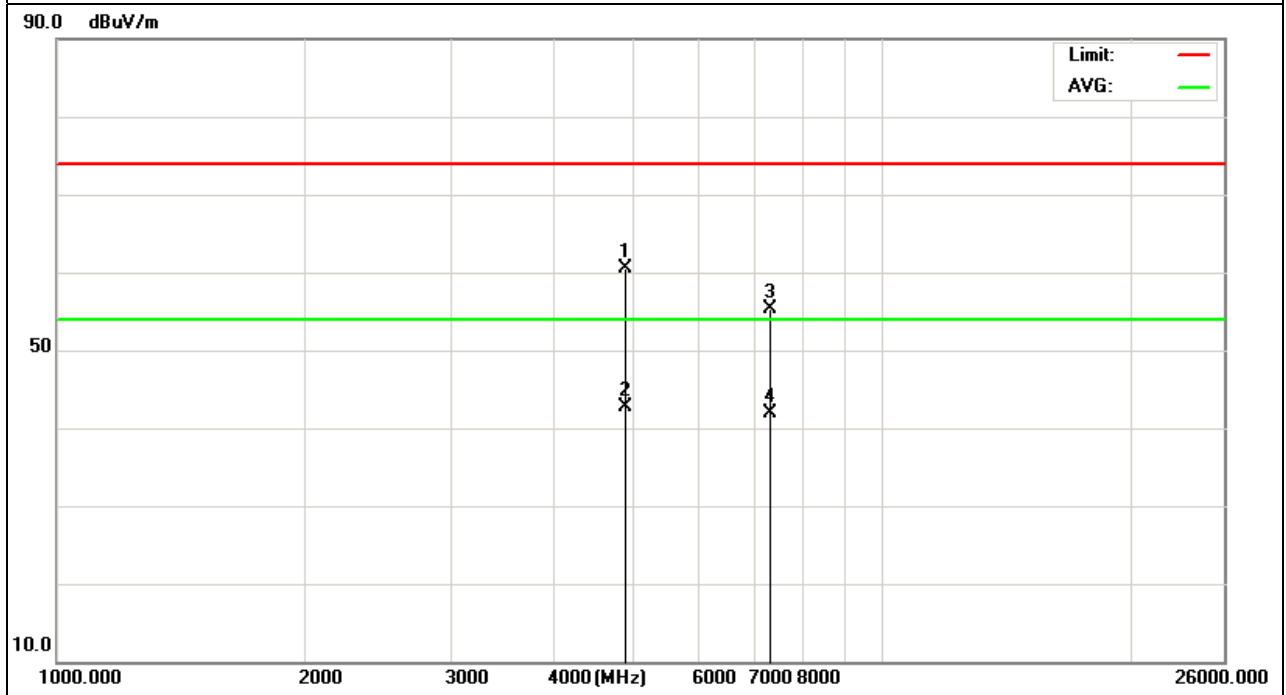

EUT :	150M wireless USB adapter	Model Name :	MT-WN715N
Temperature :	20 °C	Relative Humidity :	48%
Pressure :	1010 hPa	Test Voltage :	DC 5.0V
Test Mode :	CH6 (802.11n/20M Mode)	Polarization :	Vertical

Frequency (MHz)	Meter Reading (dBμV)	Factor (dB)	Emission Level (dBμV/m)	Limits (dBμV/m)	Margin (dB)	Detector Type
4874	56.64	2.6	59.24	74	-14.76	peak
4874	40.19	2.6	42.79	54	-11.21	AVG
7311	50.44	4.93	55.37	74	-18.63	peak
7311	39	4.93	43.93	54	-10.07	AVG

Remark:  
 Factor = Antenna Factor + Cable Loss – Pre-amplifier.

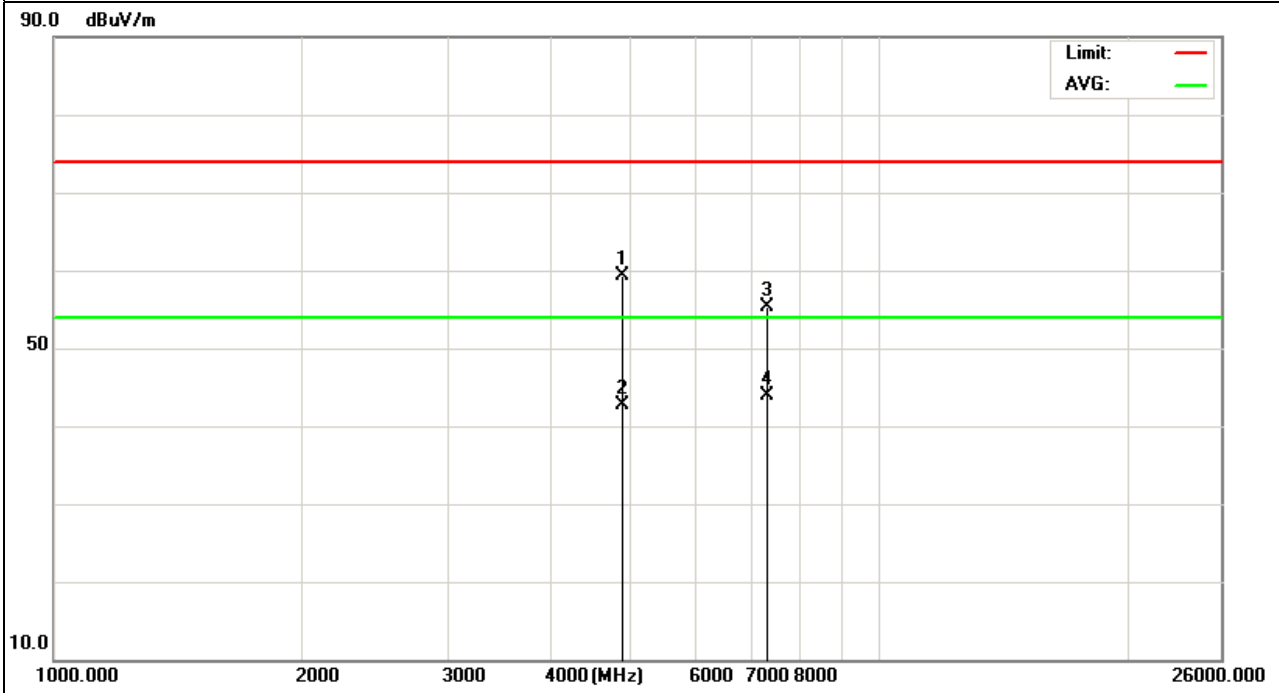

EUT :	150M Wireless USB adapter	Model Name :	MT-WN715N
Temperature :	20 °C	Relative Humidity :	48%
Pressure :	1010 hPa	Test Voltage :	DC 5.0V
Test Mode :	CH11 (802.11n/20M Mode)	Polarization :	Horizontal

Frequency (MHz)	Meter Reading (dBµV)	Factor (dB)	Emission Level (dBµV/m)	Limits (dBµV/m)	Margin (dB)	Detector Type
4924	56.85	2.6	59.45	74	-14.55	peak
4924	39.06	2.6	41.66	54	-12.34	AVG
7386	48.45	4.93	53.38	74	-20.62	peak
7386	30.88	4.93	35.81	54	-18.19	AVG

Remark:

- 3. Factor = Antenna Factor + Cable Loss – Pre-amplifier.
- 4. No emission detected above 18GHz

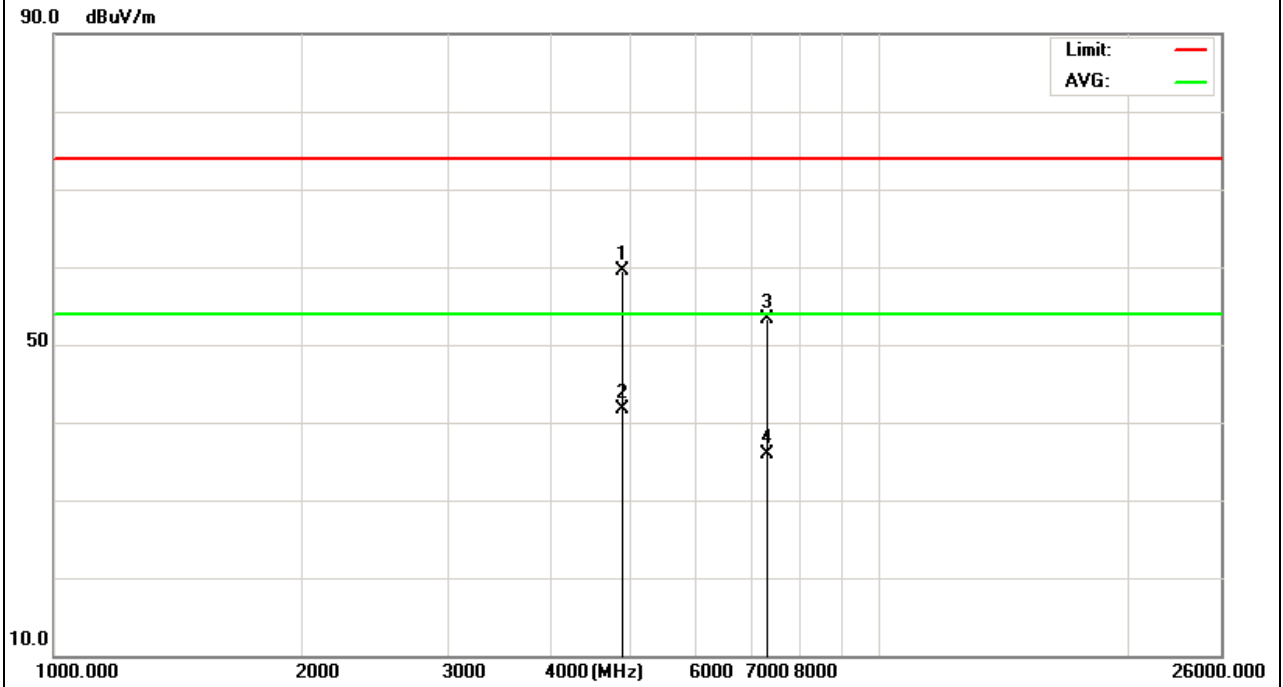



EUT :	150M Wireless USB adapter	Model Name :	MT-WN715N
Temperature :	20 °C	Relative Humidity :	48%
Pressure :	1010 hPa	Test Voltage :	DC 5.0V
Test Mode :	CH11 (802.11n/20M Mode)	Polarization :	Vertical

Frequency (MHz)	Meter Reading (dBμV)	Factor (dB)	Emission Level (dBμV/m)	Limits (dBμV/m)	Margin (dB)	Detector Type
4924	57.79	2.6	60.39	74	-13.61	peak
4924	40.02	2.6	42.62	54	-11.38	AVG
7386	51.22	4.83	56.05	74	-17.95	peak
7386	31.76	4.83	36.59	54	-17.41	AVG

Remark:  
Factor = Antenna Factor + Cable Loss – Pre-amplifier.

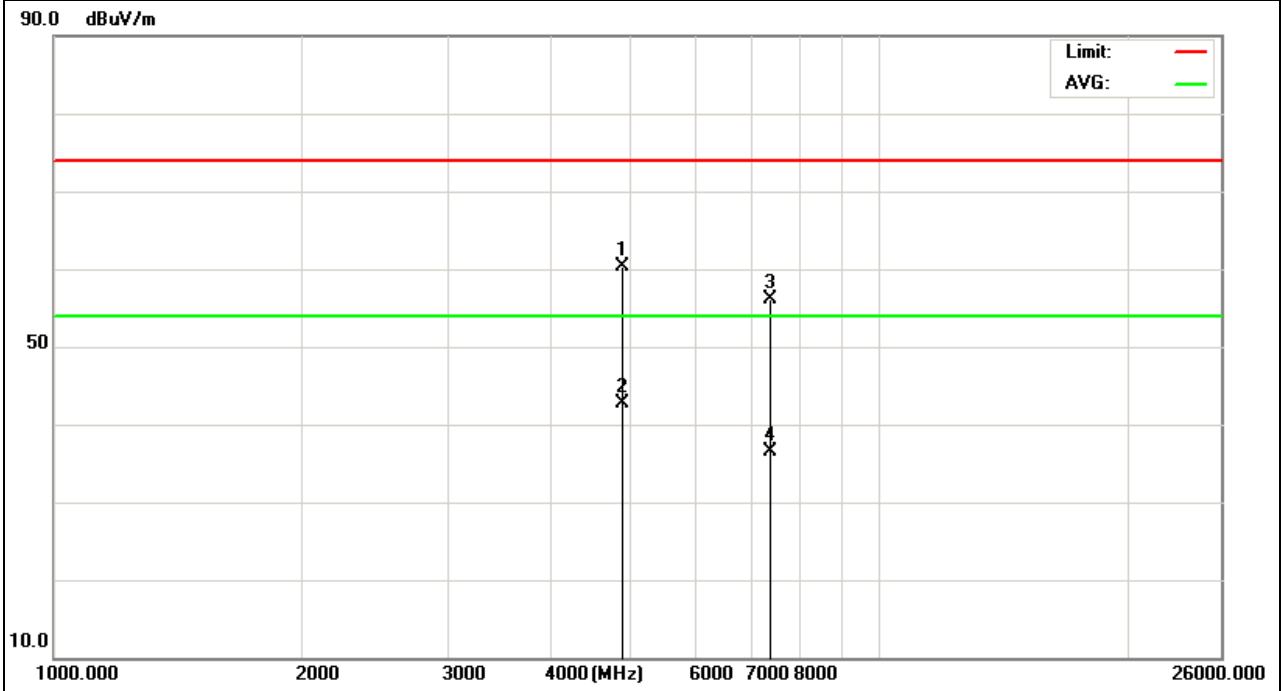

EUT :	150M Wireless USB adapter	Model Name :	MT-WN715N
Temperature :	20 °C	Relative Humidity :	48%
Pressure :	1010 hPa	Test Voltage :	DC 5.0V
Test Mode :	CH3 (802.11n/40M Mode)	Polarization :	Horizontal

Frequency (MHz)	Meter Reading (dBµV)	Factor (dB)	Emission Level (dBµV/m)	Limits (dBµV/m)	Margin (dB)	Detector Type
4844	54.86	2.68	57.54	74	-16.46	peak
4844	37.88	2.68	40.56	54	-13.44	AVG
7266	51.34	4.69	56.03	74	-17.97	peak
7266	35.12	4.69	39.81	54	-14.19	AVG

Remark:  
Factor = Antenna Factor + Cable Loss – Pre-amplifier.

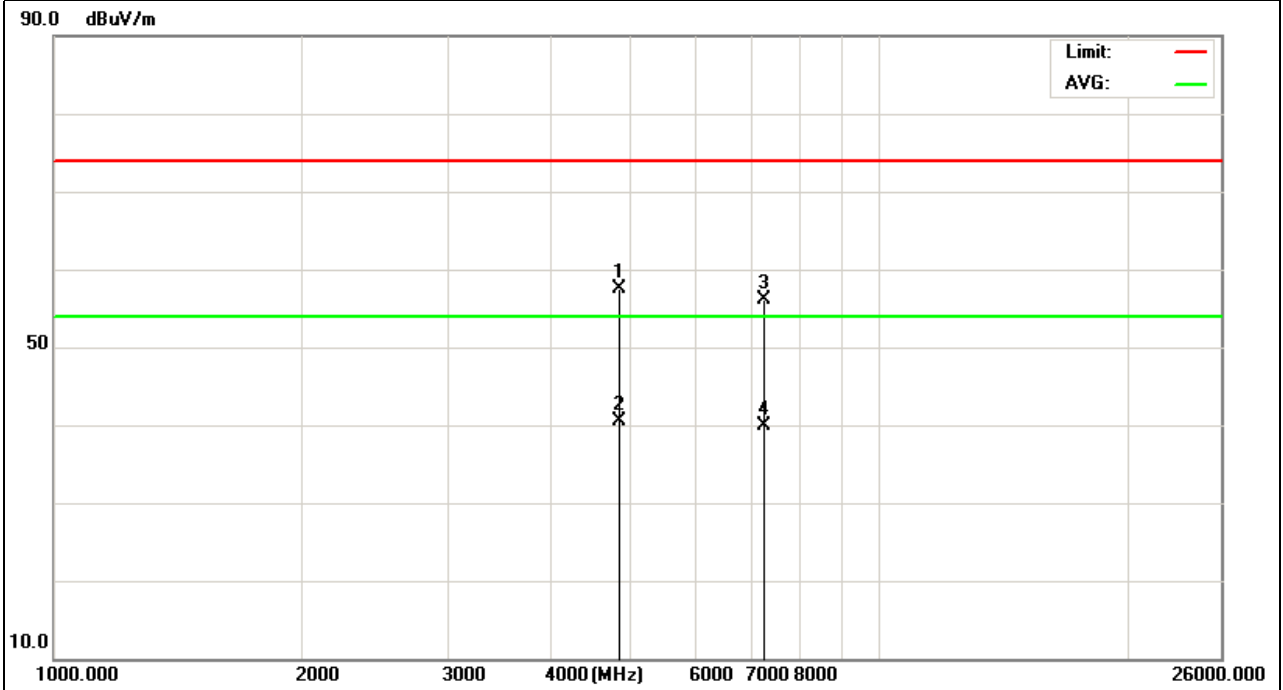

EUT :	150M Wireless USB adapter	Model Name :	MT-WN715N
Temperature :	20 °C	Relative Humidity :	48%
Pressure :	1010 hPa	Test Voltage :	DC 5.0V
Test Mode :	CH3 (802.11n/40M Mode)	Polarization :	Vertical

Frequency (MHz)	Meter Reading (dBμV)	Factor (dB)	Emission Level (dBμV/m)	Limits (dBμV/m)	Margin (dB)	Detector Type
4844	56.12	2.68	58.8	74	-15.2	peak
4844	36.56	2.68	39.24	54	-14.76	AVG
7266	52.56	4.69	57.25	74	-16.75	peak
7266	34.12	4.69	38.81	54	-15.19	AVG

Remark:  
Factor = Antenna Factor + Cable Loss – Pre-amplifier.

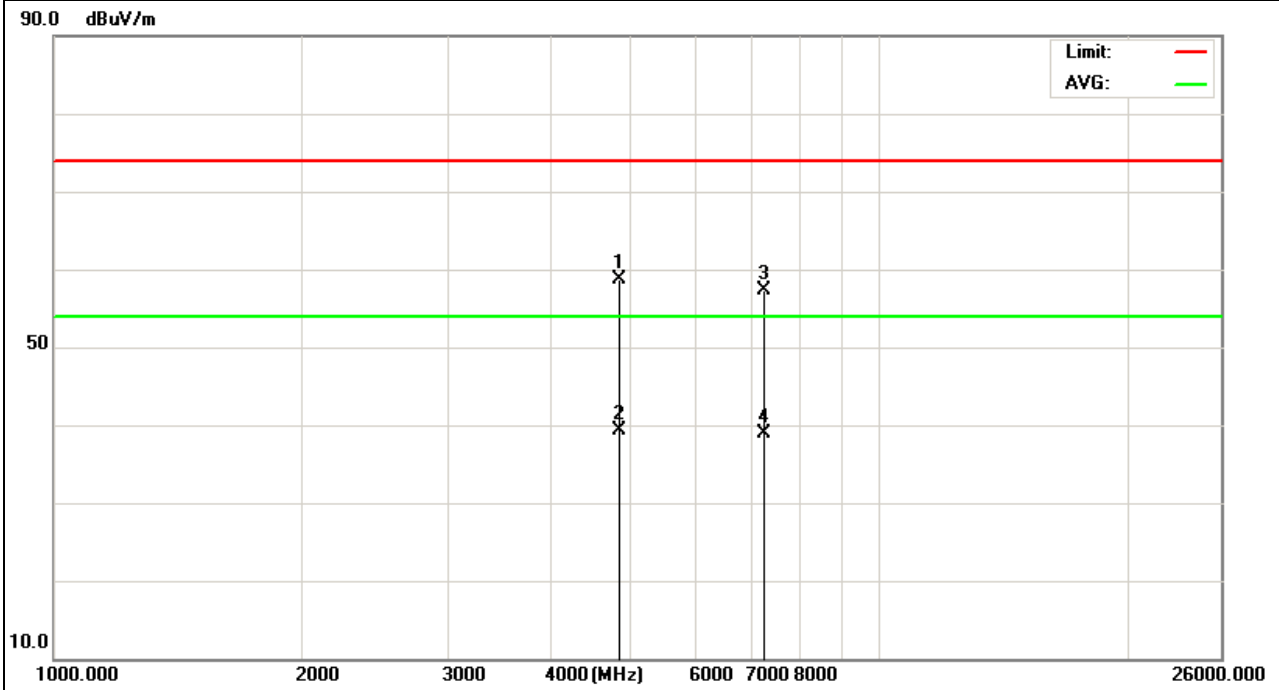

EUT :	150M Wireless USB adapter	Model Name :	MT-WN715N
Temperature :	20 °C	Relative Humidity :	48%
Pressure :	1010 hPa	Test Voltage :	DC 5.0V
Test Mode :	CH6 (802.11n/40M Mode)	Polarization :	Horizontal

Frequency (MHz)	Meter Reading (dBμV)	Factor (dB)	Emission Level (dBμV/m)	Limits (dBμV/m)	Margin (dB)	Detector Type
4874	57.95	2.6	60.55	74	-13.45	peak
4874	40.08	2.6	42.68	54	-11.32	AVG
7311	50.45	4.93	55.38	74	-18.62	peak
7311	36.88	4.93	41.81	54	-12.19	AVG

Remark:  
 Factor = Antenna Factor + Cable Loss – Pre-amplifier.

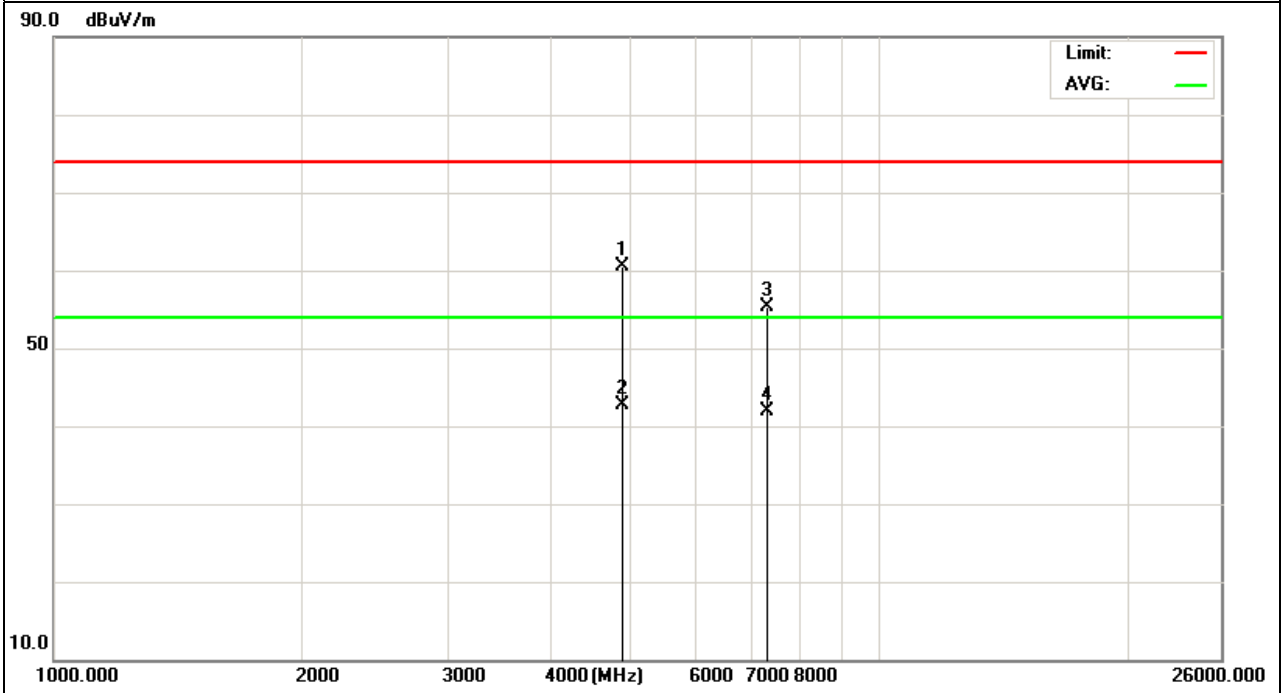

EUT :	150M wireless USB adapter	Model Name :	MT-WN715N
Temperature :	20 °C	Relative Humidity :	48%
Pressure :	1010 hPa	Test Voltage :	DC 5.0V
Test Mode :	CH6 (802.11n/40M Mode)	Polarization :	Vertical

Frequency (MHz)	Meter Reading (dBμV)	Factor (dB)	Emission Level (dBμV/m)	Limits (dBμV/m)	Margin (dB)	Detector Type
4874	56.64	2.6	59.24	74	-14.76	peak
4874	40.19	2.6	42.79	54	-11.21	AVG
7311	50.44	4.93	55.37	74	-18.63	peak
7311	39	4.93	43.93	54	-10.07	AVG

Remark:

Factor = Antenna Factor + Cable Loss – Pre-amplifier.

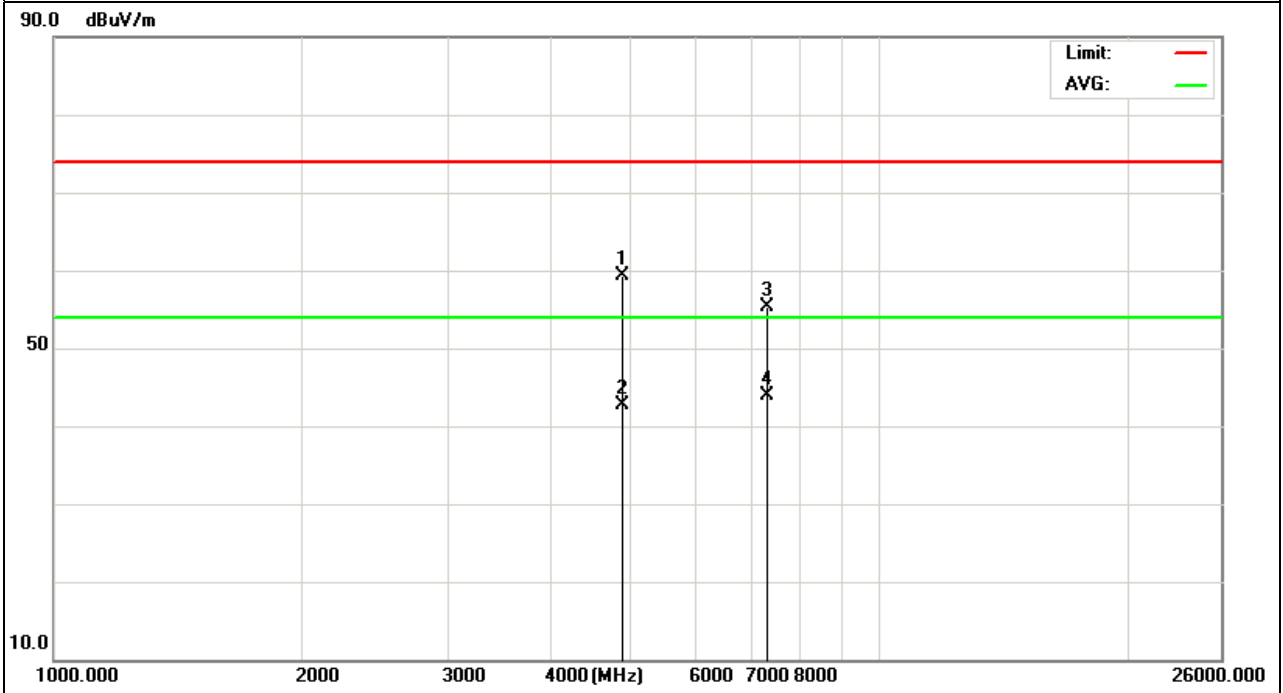

EUT :	150M Wireless USB adapter	Model Name :	MT-WN715N
Temperature :	20 °C	Relative Humidity :	48%
Pressure :	1010 hPa	Test Voltage :	DC 5.0V
Test Mode :	CH9 (802.11n/40M Mode)	Polarization :	Horizontal

Frequency (MHz)	Meter Reading (dBμV)	Factor (dB)	Emission Level (dBμV/m)	Limits (dBμV/m)	Margin (dB)	Detector Type
4904	56.28	2.52	58.8	74	-15.2	peak
4904	36.72	2.52	39.24	54	-14.76	AVG
7356	52.3	4.95	57.25	74	-16.75	peak
7356	33.86	4.95	38.81	54	-15.19	AVG

Remark:

- 5. Factor = Antenna Factor + Cable Loss – Pre-amplifier.
- 6. No emission detected above 18GHz

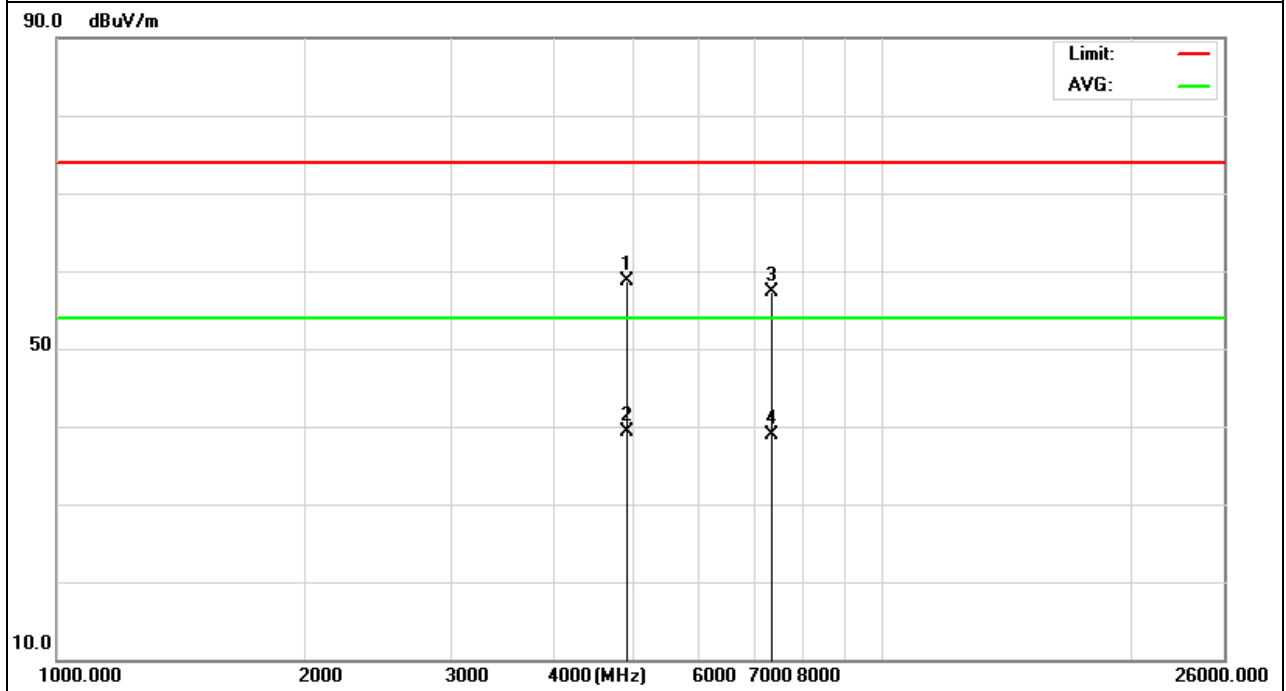

EUT :	150M Wireless USB adapter	Model Name :	MT-WN715N
Temperature :	20 °C	Relative Humidity :	48%
Pressure :	1010 hPa	Test Voltage :	DC 5.0V
Test Mode :	CH9 (802.11n/40M Mode)	Polarization :	Vertical

Frequency (MHz)	Meter Reading (dBμV)	Factor (dB)	Emission Level (dBμV/m)	Limits (dBμV/m)	Margin (dB)	Detector Type
4904	54.28	2.52	56.8	74	-17.2	peak
4904	35.44	2.52	37.96	54	-16.04	AVG
7356	51.99	4.95	56.94	74	-17.06	peak
7356	32.99	4.95	37.94	54	-16.06	AVG

Remark:  
Factor = Antenna Factor + Cable Loss – Pre-amplifier.

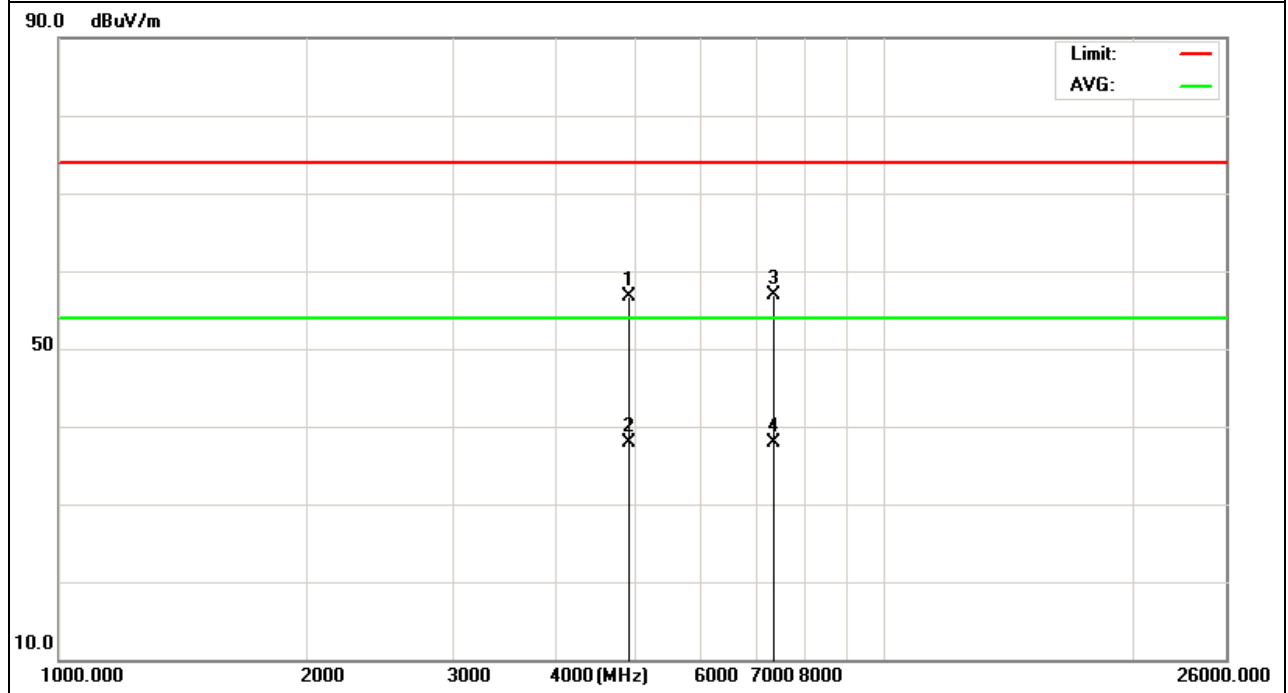

**Band Edge Emission:**

EUT :	150M Wireless USB adapter	Model Name :	MT-WN715N
Temperature :	20 °C	Relative Humidity :	48%
Pressure :	1010 hPa	Test Voltage :	DC 5.0V
Test Mode :	CH1(802.11b Mode)	Polarization :	Horizontal

Frequency (MHz)	Meter Reading (dBμV)	Factor (dB)	Emission Level (dBμV/m)	Limits (dBμV/m)	Margin (dB)	Detector Type
2397.925	101	-40.5	60.5	74	-13.5	peak
2397.925	85.96	-40.5	45.46	54	-8.54	AVG
2400	98.15	-40.5	57.65	74	-16.35	peak
2400	83.12	-40.5	42.62	54	-11.38	AVG

Remark:  
Factor = Antenna Factor + Cable Loss – Pre-amplifier.

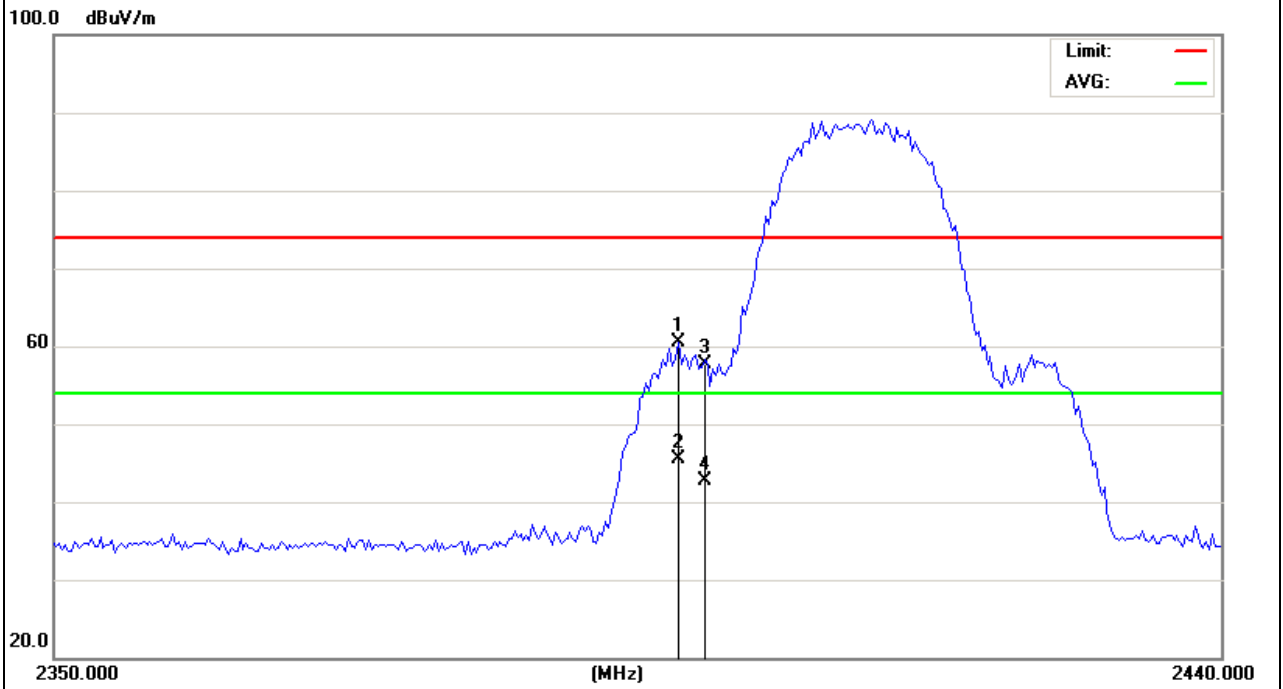



EUT :	150M Wireless USB adapter	Model Name :	MT-WN715N
Temperature :	20 °C	Relative Humidity :	48%
Pressure :	1010 hPa	Test Voltage :	DC 5.0V
Test Mode :	CH1(802.11b Mode)	Polarization :	Vertical

Frequency (MHz)	Meter Reading (dBμV)	Factor (dB)	Emission Level (dBμV/m)	Limits (dBμV/m)	Margin (dB)	Detector Type
2397.25	90.67	-40.51	50.16	74	-23.84	peak
2400.00	87.91	-40.5	47.41	74	-26.59	peak

Remark:  
 Factor = Antenna Factor + Cable Loss – Pre-amplifier.

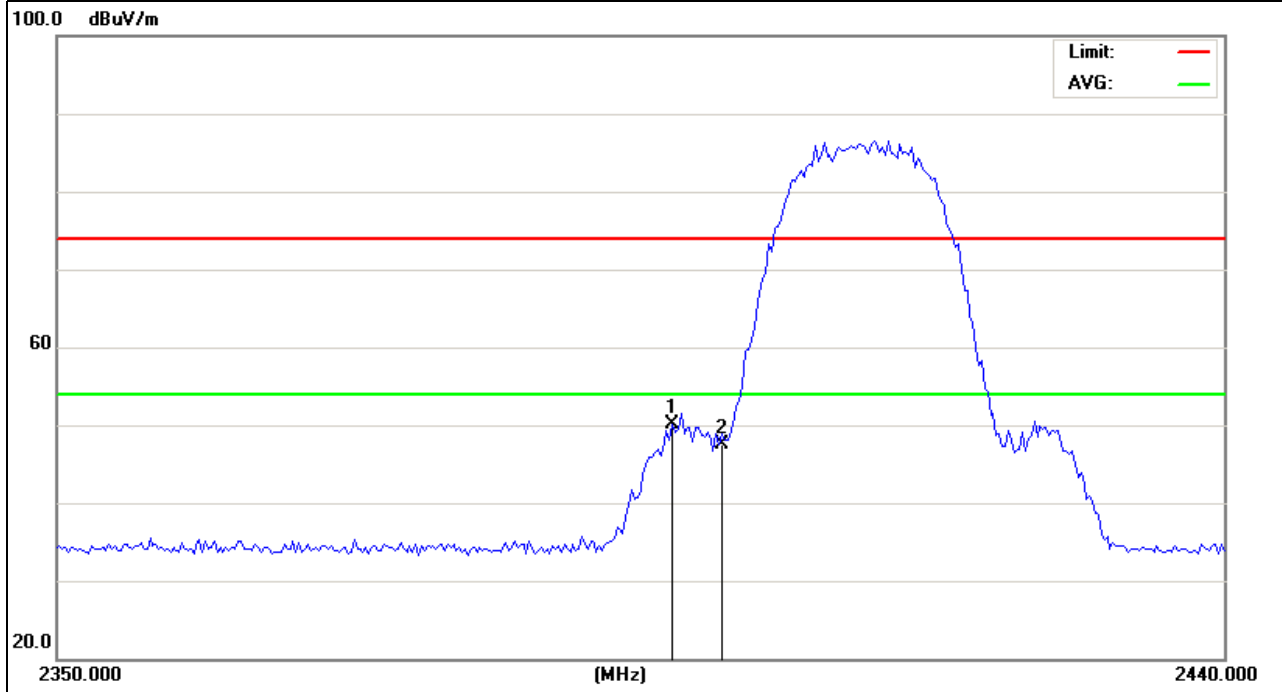

EUT :	150M Wireless USB adapter	Model Name :	MT-WN715N
Temperature :	20 °C	Relative Humidity :	48%
Pressure :	1010 hPa	Test Voltage :	DC 5.0V
Test Mode :	CH11(802.11b Mode)	Polarization :	Horizontal

Frequency (MHz)	Meter Reading (dBμV)	Factor (dB)	Emission Level (dBμV/m)	Limits (dBμV/m)	Margin (dB)	Detector Type
2483.5	74.1	-40.43	33.67	74	-40.33	peak

Remark:  
Factor = Antenna Factor + Cable Loss – Pre-amplifier.

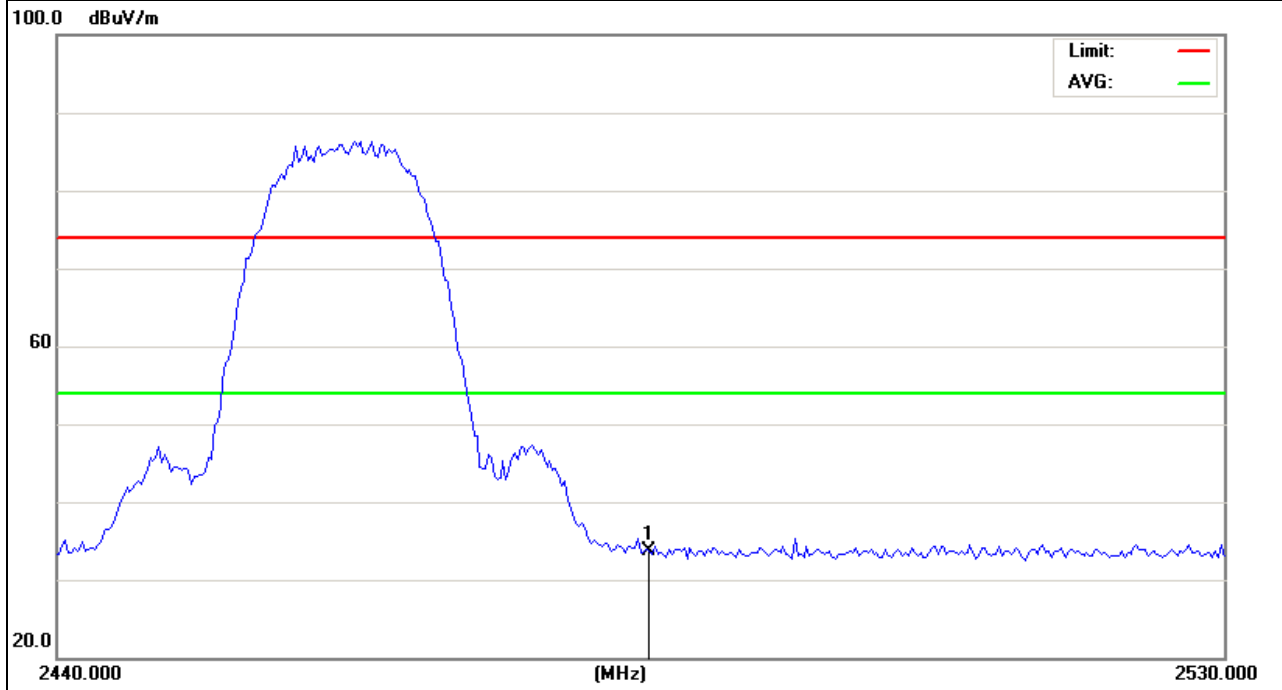

EUT :	150M Wireless USB adapter	Model Name :	MT-WN715N
Temperature :	20 °C	Relative Humidity :	48%
Pressure :	1010 hPa	Test Voltage :	DC 5.0V
Test Mode :	CH11(802.11b Mode)	Polarization :	Vertical

Frequency (MHz)	Meter Reading (dBμV)	Factor (dB)	Emission Level (dBμV/m)	Limits (dBμV/m)	Margin (dB)	Detector Type
2483.5	74.72	-40.43	34.29	74	-39.71	peak

Remark:  
Factor = Antenna Factor + Cable Loss – Pre-amplifier.

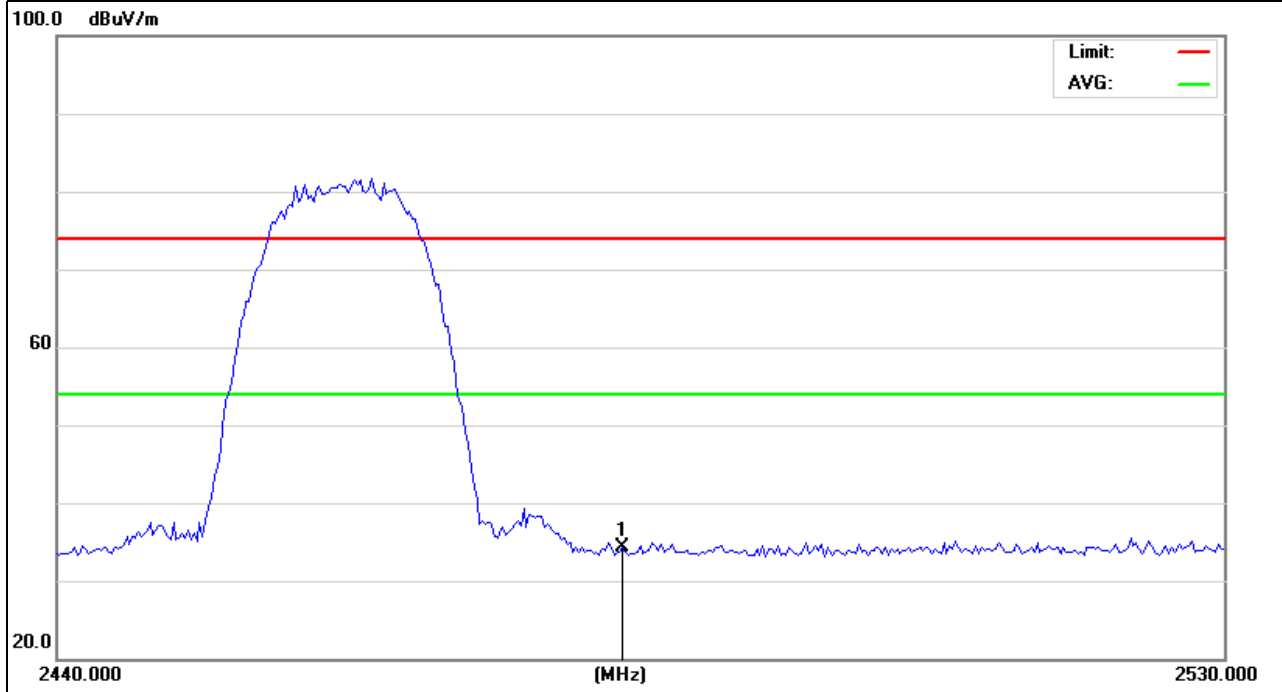

EUT :	150M Wireless USB adapter	Model Name :	MT-WN715N
Temperature :	20 °C	Relative Humidity :	48%
Pressure :	1010 hPa	Test Voltage :	DC 5.0V
Test Mode :	CH1(802.11g Mode)	Polarization :	Horizontal

Frequency (MHz)	Meter Reading (dBμV)	Factor (dB)	Emission Level (dBμV/m)	Limits (dBμV/m)	Margin (dB)	Detector Type
2400.00	101.76	-40.5	61.26	74	-12.74	peak
2400.00	84.46	-40.5	43.96	54	-10.04	AV

Remark:  
 Factor = Antenna Factor + Cable Loss – Pre-amplifier.

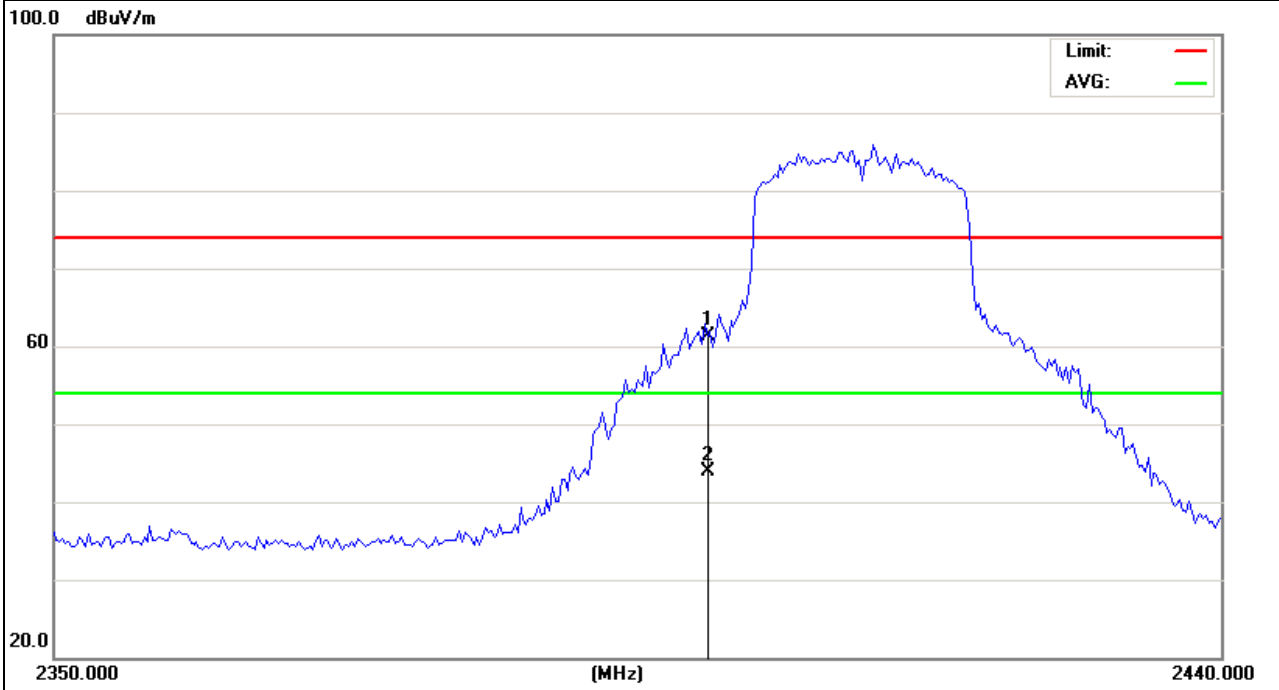

EUT :	150M Wireless USB adapter	Model Name :	MT-WN715N
Temperature :	20 °C	Relative Humidity :	48%
Pressure :	1010 hPa	Test Voltage :	DC 5.0V
Test Mode :	CH1(802.11gMode)	Polarization :	Vertical

Frequency (MHz)	Meter Reading (dBμV)	Factor (dB)	Emission Level (dBμV/m)	Limits (dBμV/m)	Margin (dB)	Detector Type
2400	93.65	-40.5	53.15	74	-20.85	peak
2400	78.08	-40.5	37.58	54	-16.42	AV

Remark:  
 Factor = Antenna Factor + Cable Loss – Pre-amplifier.

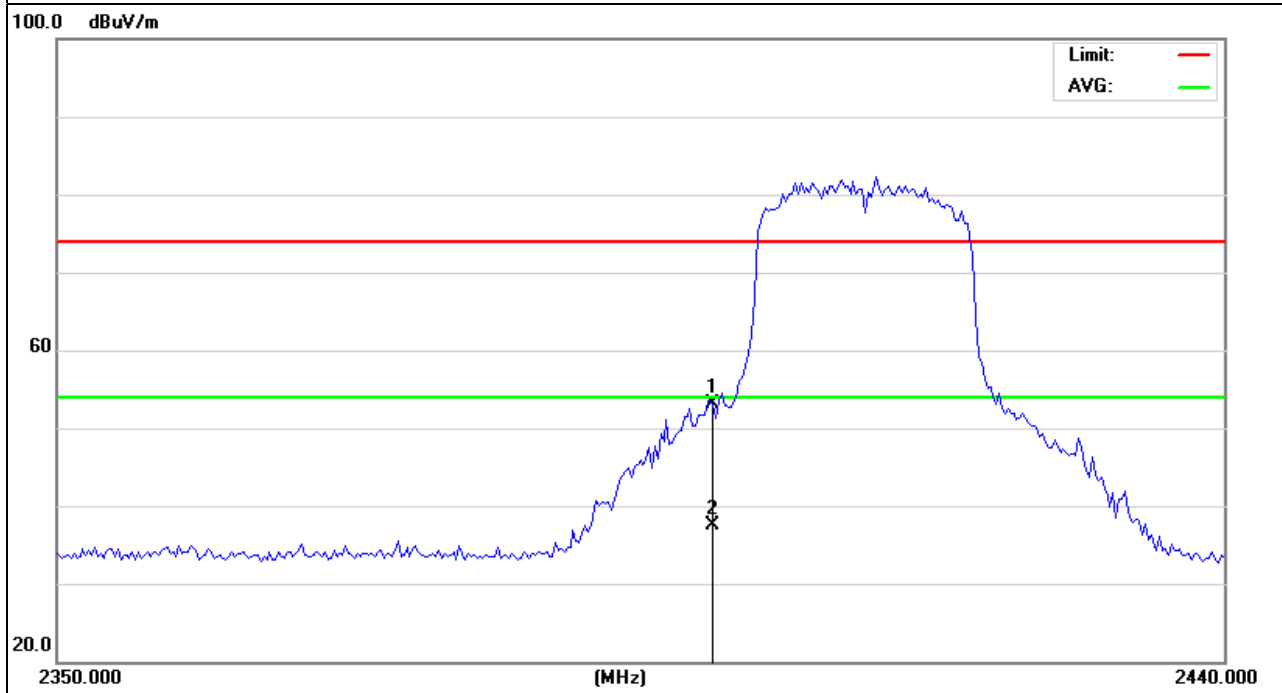

EUT :	150M Wireless USB adapter	Model Name :	MT-WN715N
Temperature :	20 °C	Relative Humidity :	48%
Pressure :	1010 hPa	Test Voltage :	DC 5.0V
Test Mode :	CH11(802.11g Mode)	Polarization :	Horizontal

Frequency (MHz)	Meter Reading (dBμV)	Factor (dB)	Emission Level (dBμV/m)	Limits (dBμV/m)	Margin (dB)	Detector Type
2483.5	80.2	-40.43	39.77	74	-34.23	peak

Remark:  
Factor = Antenna Factor + Cable Loss – Pre-amplifier.

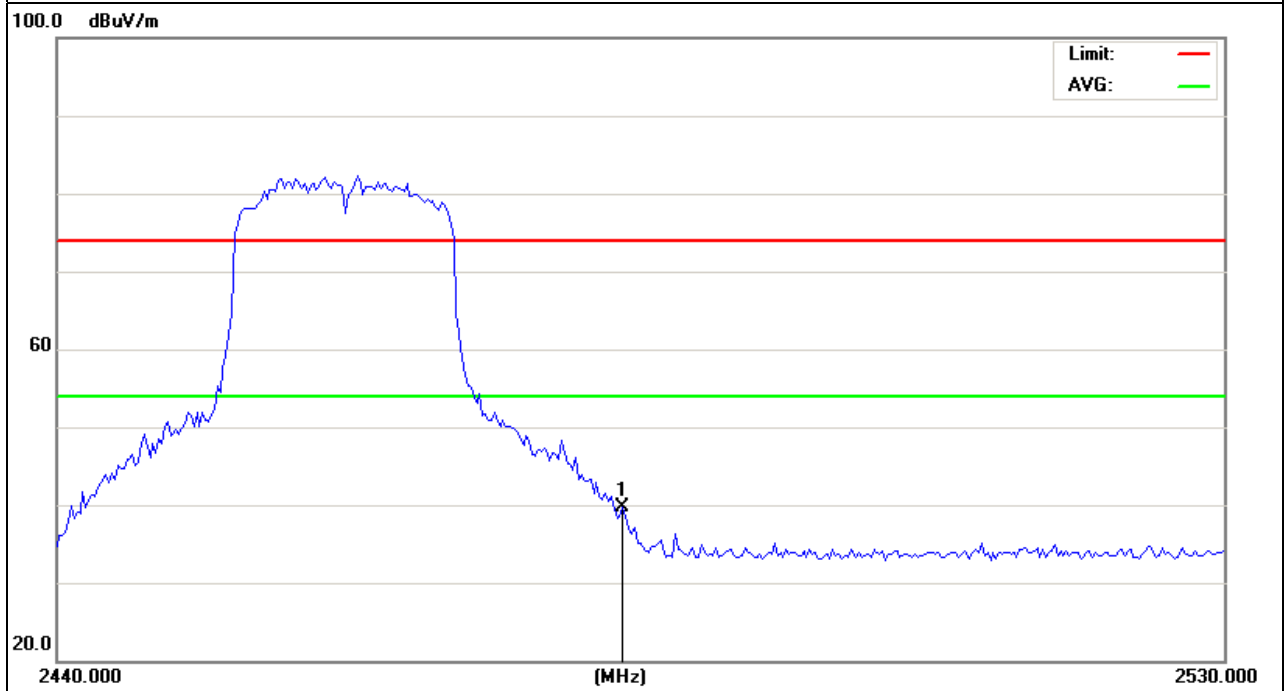

EUT :	150M Wireless USB adapter	Model Name :	MT-WN715N
Temperature :	20 °C	Relative Humidity :	48%
Pressure :	1010 hPa	Test Voltage :	DC 5.0V
Test Mode :	CH11(802.11g Mode)	Polarization :	Vertical

Frequency (MHz)	Meter Reading (dBμV)	Factor (dB)	Emission Level (dBμV/m)	Limits (dBμV/m)	Margin (dB)	Detector Type
2483.5	74.16	-40.43	33.73	74	-40.27	peak

Remark:  
Factor = Antenna Factor + Cable Loss – Pre-amplifier.

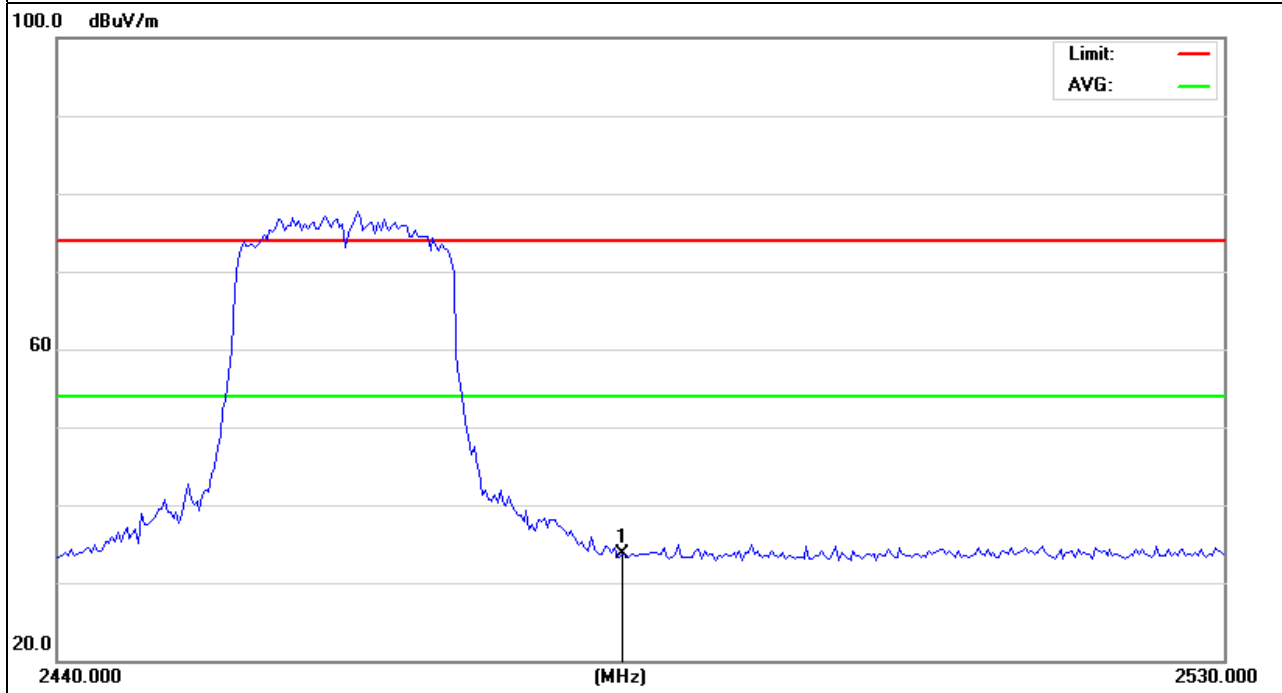

EUT :	150M Wireless USB adapter	Model Name :	MT-WN715N
Temperature :	20 °C	Relative Humidity :	48%
Pressure :	1010 hPa	Test Voltage :	DC 5.0V
Test Mode :	CH1(802.11n Mode/20MHz)	Polarization :	Horizontal

Frequency (MHz)	Meter Reading (dBµV)	Factor (dB)	Emission Level (dBµV/m)	Limits (dBµV/m)	Margin (dB)	Detector Type
2400.00	100.39	-40.5	59.89	74	-14.11	peak
2400.00	83.54	-40.5	43.04	54	-10.96	AVG

Remark:  
 Factor = Antenna Factor + Cable Loss – Pre-amplifier.

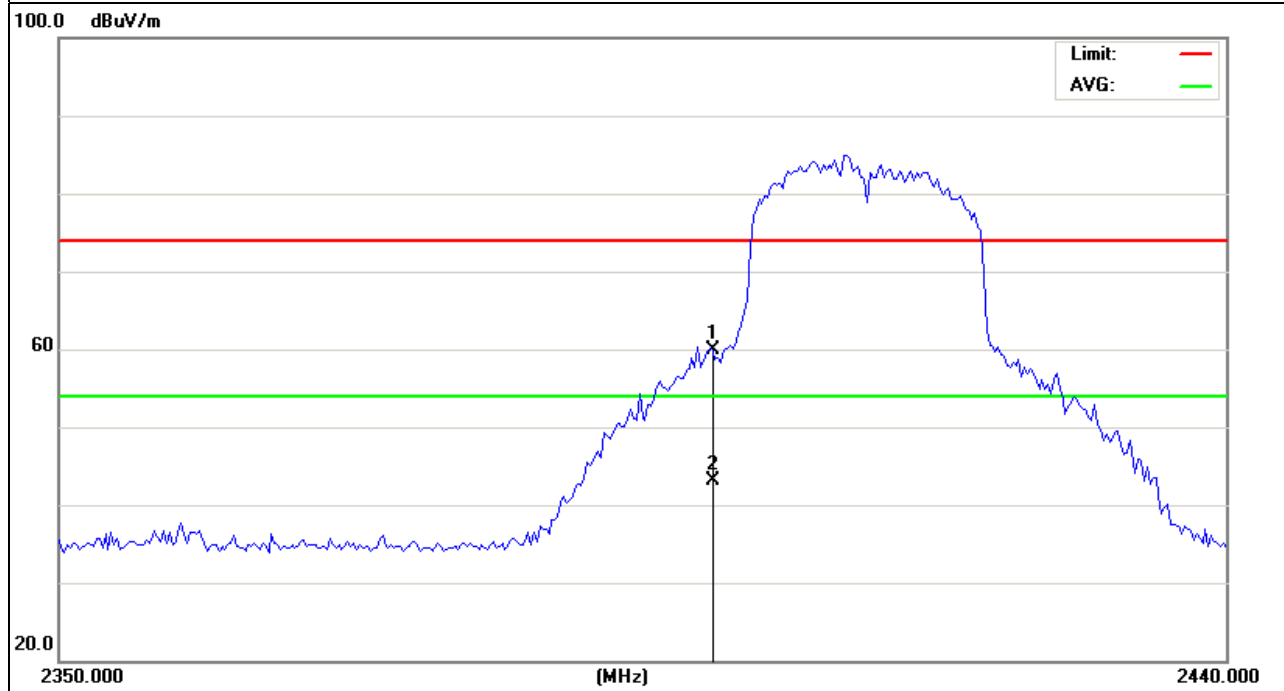



EUT :	150M Wireless USB adapter	Model Name :	MT-WN715N
Temperature :	20 °C	Relative Humidity :	48%
Pressure :	1010 hPa	Test Voltage :	DC 5.0V
Test Mode :	CH1(802.11n Mode/20MHz)	Polarization :	Vertical

Frequency (MHz)	Meter Reading (dBμV)	Factor (dB)	Emission Level (dBμV/m)	Limits (dBμV/m)	Margin (dB)	Detector Type
2400.00	92.68	-40.5	52.18	74	-21.82	peak
2400.00	77.75	-40.5	37.25	54	-16.75	AVG

Remark:  
 Factor = Antenna Factor + Cable Loss – Pre-amplifier.

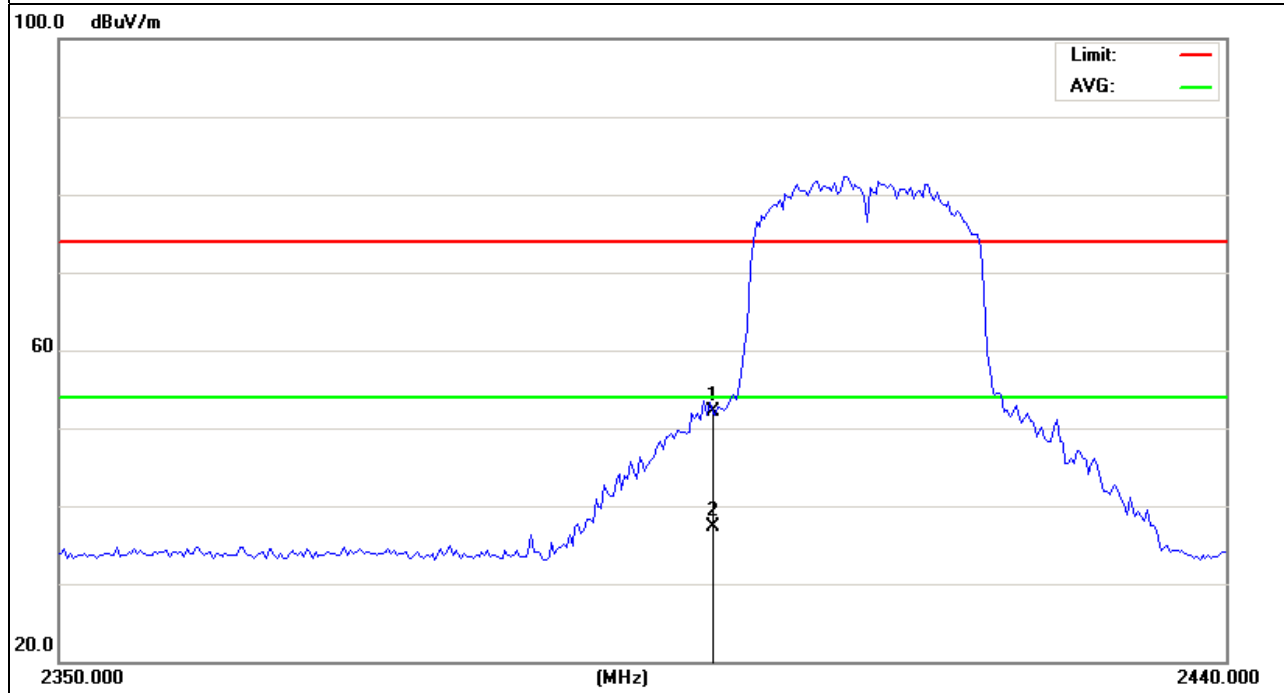

EUT :	150M Wireless USB adapter	Model Name :	MT-WN715N
Temperature :	20 °C	Relative Humidity :	48%
Pressure :	1010 hPa	Test Voltage :	DC 5.0V
Test Mode :	CH11(802.11n Mode/20MHz)	Polarization :	Horizontal

Frequency (MHz)	Meter Reading (dBμV)	Factor (dB)	Emission Level (dBμV/m)	Limits (dBμV/m)	Margin (dB)	Detector Type
2483.5	78.79	-40.43	38.36	74	-35.64	peak

Remark:  
Factor = Antenna Factor + Cable Loss – Pre-amplifier.

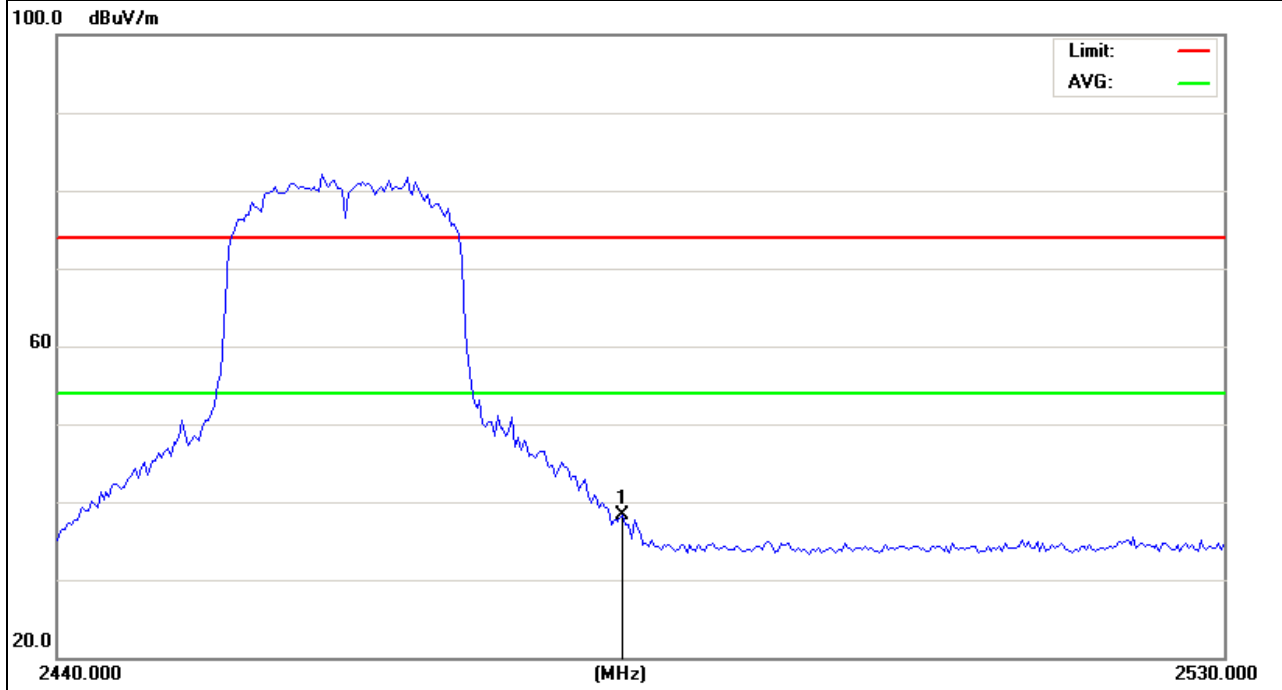

EUT :	150M Wireless USB adapter	Model Name :	MT-WN715N
Temperature :	20 °C	Relative Humidity :	48%
Pressure :	1010 hPa	Test Voltage :	DC 5.0V
Test Mode :	CH11(802.11n Mode/20MHz)	Polarization :	Vertical

Frequency (MHz)	Meter Reading (dBµV)	Factor (dB)	Emission Level (dBµV/m)	Limits (dBµV/m)	Margin (dB)	Detector Type
2483.5	75.22	-40.43	34.79	74	-39.21	peak

Remark:  
 Factor = Antenna Factor + Cable Loss – Pre-amplifier.

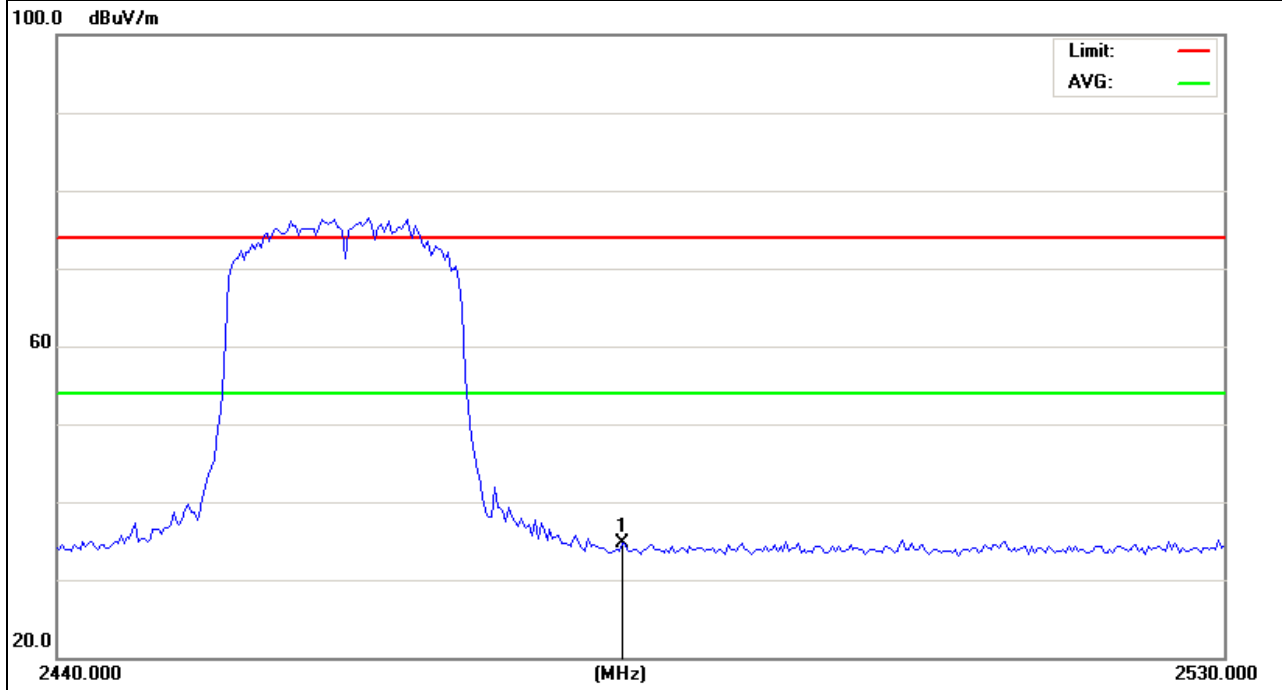

EUT :	150M Wireless USB adapter	Model Name :	MT-WN715N
Temperature :	20 °C	Relative Humidity :	48%
Pressure :	1010 hPa	Test Voltage :	DC 5.0V
Test Mode :	CH3(802.11n Mode/40MHz)	Polarization :	Horizontal

Frequency (MHz)	Meter Reading (dBμV)	Factor (dB)	Emission Level (dBμV/m)	Limits (dBμV/m)	Margin (dB)	Detector Type
2400	96.71	-40.5	56.21	74	-17.79	peak
2400	83.23	-40.5	42.73	54	-11.27	AVG

Remark:  
 Factor = Antenna Factor + Cable Loss – Pre-amplifier.

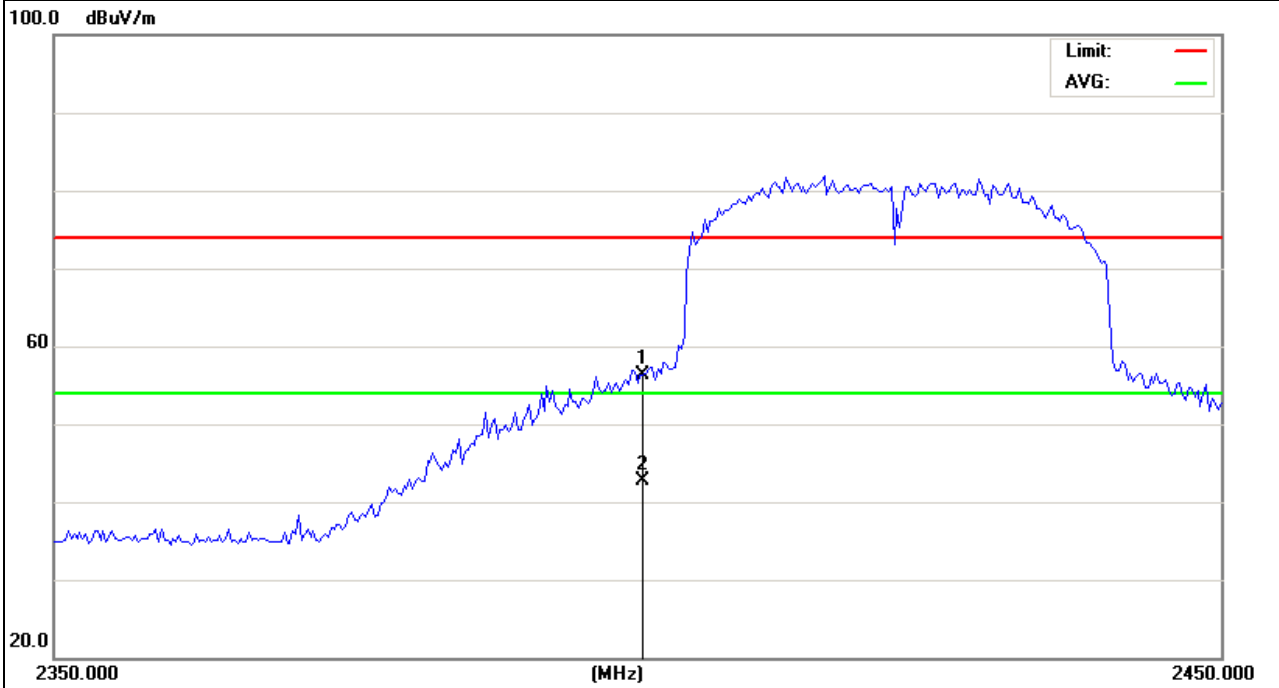

EUT :	150M Wireless USB adapter	Model Name :	MT-WN715N
Temperature :	20 °C	Relative Humidity :	48%
Pressure :	1010 hPa	Test Voltage :	DC 5.0V
Test Mode :	CH3(802.11n Mode/40MHz)	Polarization :	Vertical

Frequency (MHz)	Meter Reading (dBμV)	Factor (dB)	Emission Level (dBμV/m)	Limits (dBμV/m)	Margin (dB)	Detector Type
2400	87.19	-40.5	46.69	74	-27.31	peak

Remark:  
Factor = Antenna Factor + Cable Loss – Pre-amplifier.

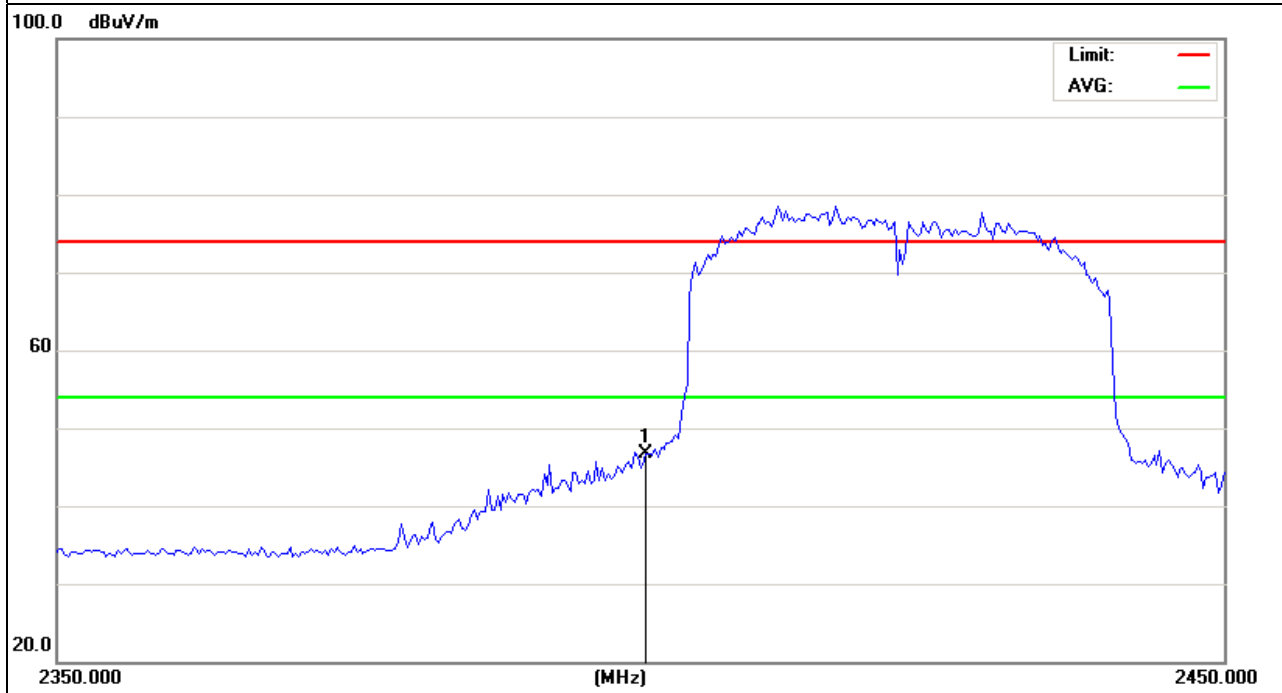

EUT :	150M Wireless USB adapter	Model Name :	MT-WN715N
Temperature :	20 °C	Relative Humidity :	48%
Pressure :	1010 hPa	Test Voltage :	DC 5.0V
Test Mode :	CH9(802.11n Mode/40MHz)	Polarization :	Horizontal

Frequency (MHz)	Meter Reading (dBµV)	Factor (dB)	Emission Level (dBµV/m)	Limits (dBµV/m)	Margin (dB)	Detector Type
2483.5	84.19	-40.43	43.76	74	-30.24	peak

Remark:  
Factor = Antenna Factor + Cable Loss – Pre-amplifier.



EUT :	150M Wireless USB adapter	Model Name :	MT-WN715N
Temperature :	20 °C	Relative Humidity :	48%
Pressure :	1010 hPa	Test Voltage :	DC 5.0V
Test Mode :	CH9(802.11n Mode/40MHz)	Polarization :	Vertical

Frequency (MHz)	Meter Reading (dBμV)	Factor (dB)	Emission Level (dBμV/m)	Limits (dBμV/m)	Margin (dB)	Detector Type
2483.5	75.63	-40.43	35.2	74	-38.8	peak

Remark:  
Factor = Antenna Factor + Cable Loss – Pre-amplifier.

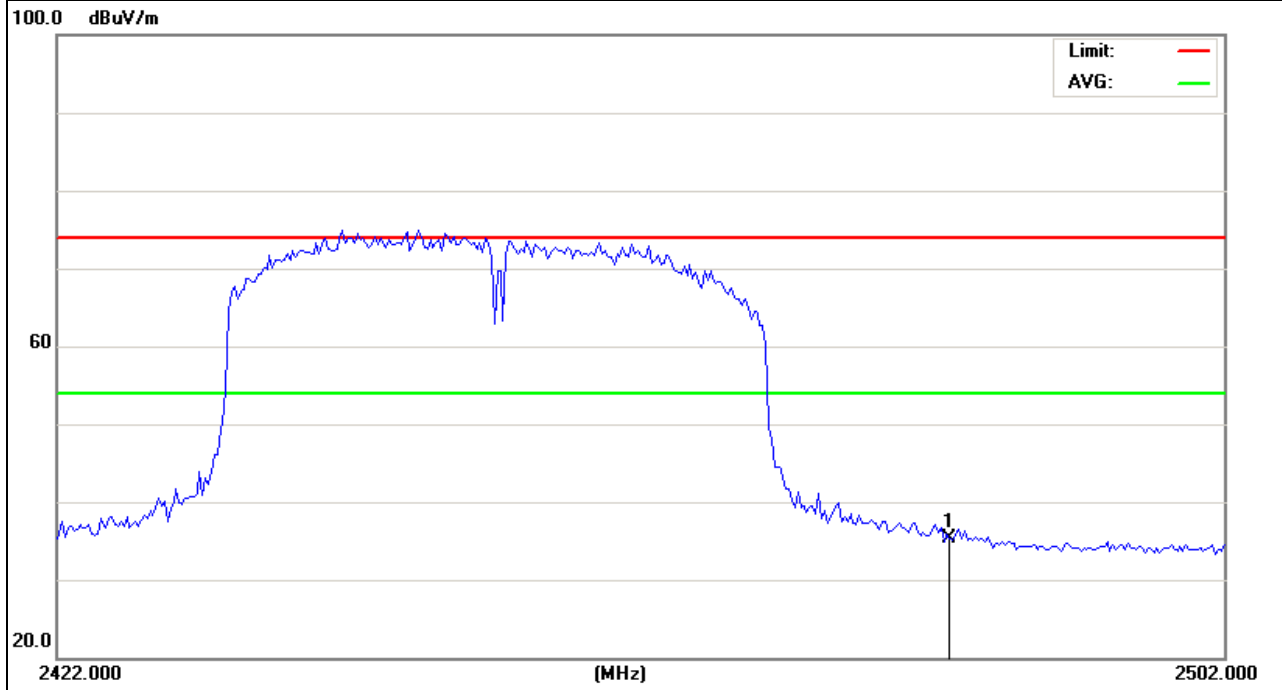

#### 4. POWER SPECTRAL DENSITY TEST

##### 4.1 APPLIED PROCEDURES / LIMIT

FCC Part15 (15.247) , Subpart C				
Section	Test Item	Limit	Frequency Range (MHz)	Result
15.247	Power Spectral Density	8 dBm (in any 3KHz)	2400-2483.5	PASS

##### 4.1.1 TEST PROCEDURE

1. The testing follows Measurement Procedure PKPSD of FCC KDB Publication No. 558074 D01 DTS Meas. Guidance v01.
2. The RF output of EUT was connected to the spectrum analyzer by a low loss cable. The path loss was compensated to the results for each measurement.
3. Record the measurement data derived from spectrum analyzer.
4. Make the measurement with the spectrum analyzer's resolution bandwidth (RBW) = 100 KHz. Video bandwidth (VBW) >= 300 KHz In order to make an accurate measurement, set the span to 5-30% greater than Emission Bandwidth (EBW)
5. Detector = peak, Sweep time = auto couple, Trace mode = max hold, Allow trace to fully stabilize. Use the peak marker function to determine the maximum power level in any 100 kHz band segment within the fundamental EBW.
6. Scale the observed power level to an equivalent value in 3 kHz by adjusting (reducing) the measured power by a bandwidth correction factor (BWCF) where  $BWCF = 10\log(3\text{ kHz}/100\text{ kHz}) = -15.2\text{ dB}$ .

##### 4.1.2 DEVIATION FROM STANDARD

No deviation.

##### 4.1.3 TEST SETUP



##### 4.1.4 EUT OPERATION CONDITIONS

The EUT tested system was configured as the statements of 2.1 Unless otherwise a special operating condition is specified in the follows during the testing.



### 4.1.5 TEST RESULTS

EUT :	150M Wireless USB adapter	Model Name :	MT-WN715N
Temperature :	25 °C	Relative Humidity :	60%
Pressure :	1015 hPa	Test Voltage :	DC 5.0V
Test Mode :	TX b Mode /CH01, CH06, CH11		

Frequency	Power Density (dBm)	PSD/ 3KHz (dBm)	Limit (dBm)	Result
2412 MHz	-0.35	-15.55	8	<b>PASS</b>
2437 MHz	-0.85	-16.05	8	<b>PASS</b>
2462 MHz	-1.48	-16.68	8	<b>PASS</b>

**Note:**

BWCF =  $10\log(3\text{ kHz}/100\text{ kHz}) = -15.2\text{ dB}$ .

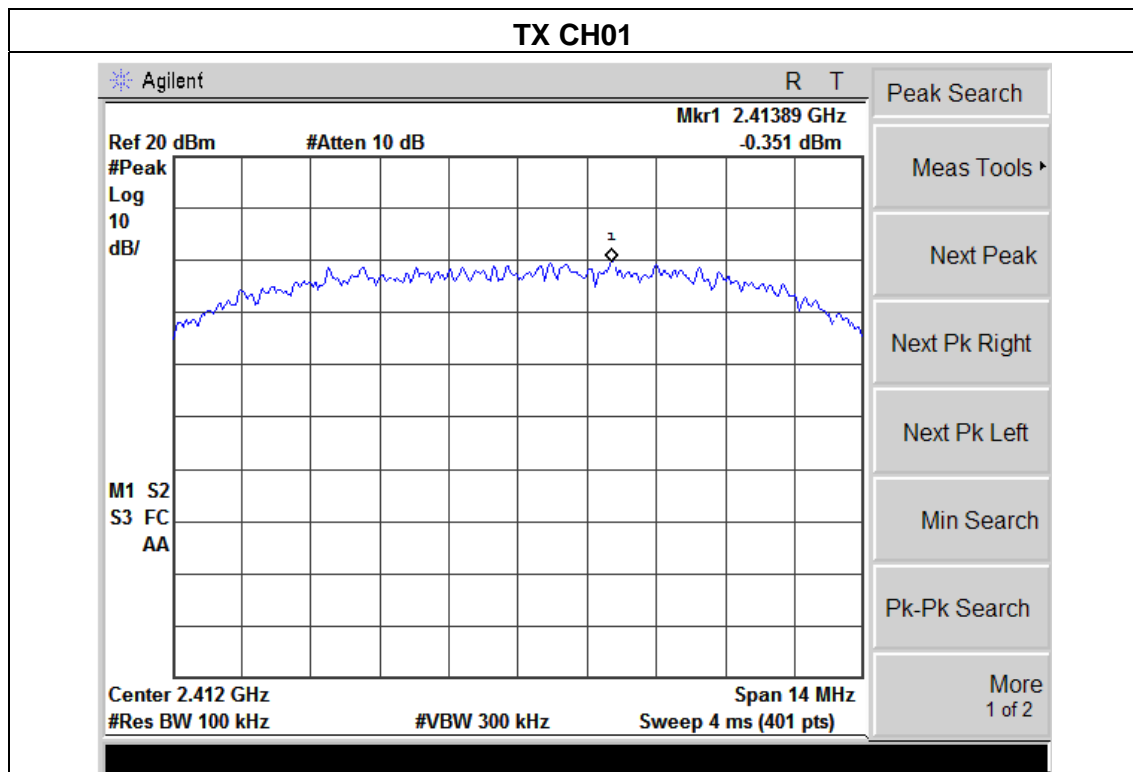

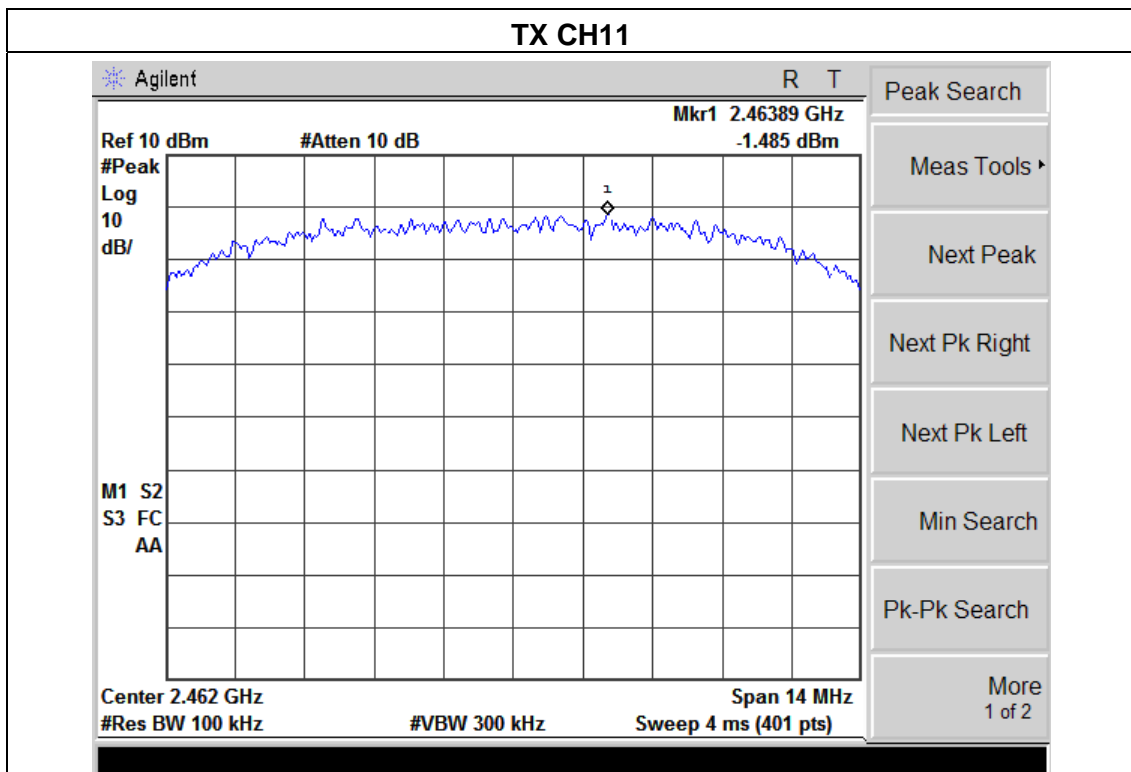
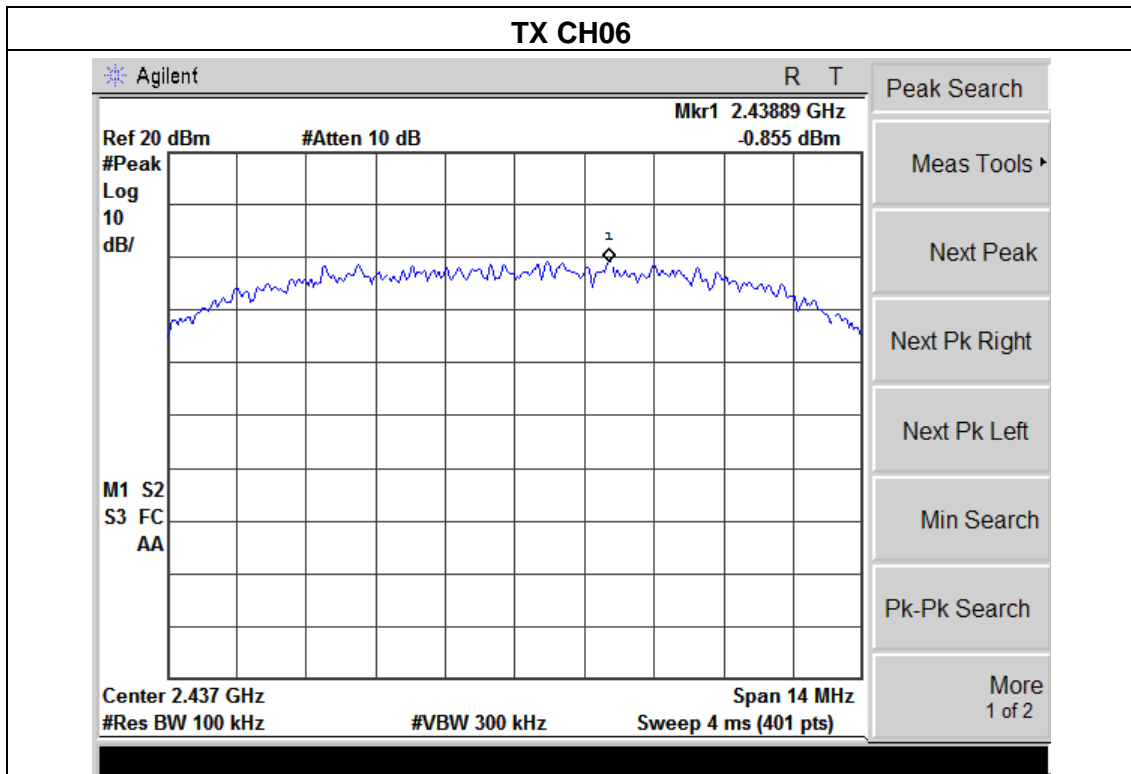

EUT :	150M Wireless USB adapter	Model Name :	MT-WN715N
Temperature :	25 °C	Relative Humidity :	60%
Pressure :	1015 hPa	Test Voltage :	DC 5.0V
Test Mode :	TX g Mode /CH01, CH06, CH11		

Frequency	Power Density (dBm)	PSD/ 3KHz (dBm)	Limit (dBm)	Result
2412 MHz	-5.58	-20.78	8	<b>PASS</b>
2437 MHz	-5.24	-20.44	8	<b>PASS</b>
2462 MHz	-6.36	-21.56	8	<b>PASS</b>

**Note:**

BWCF =  $10\log(3\text{ kHz}/100\text{ kHz}) = -15.2\text{ dB}$ .

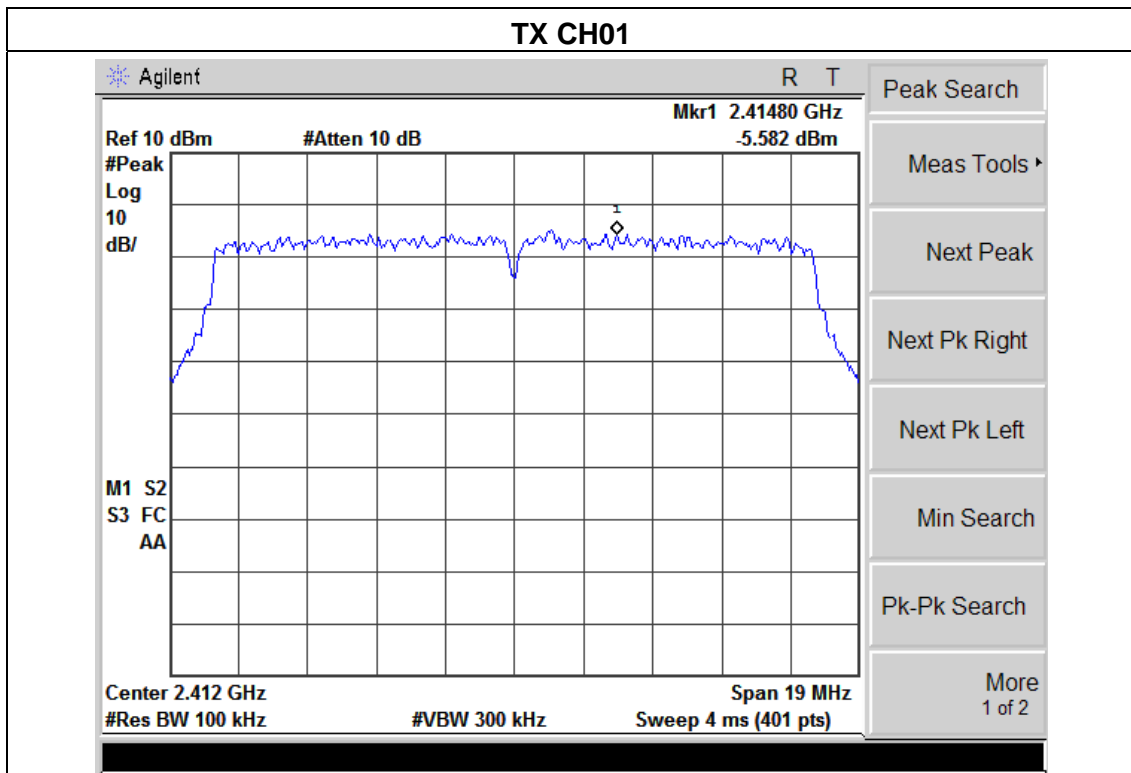

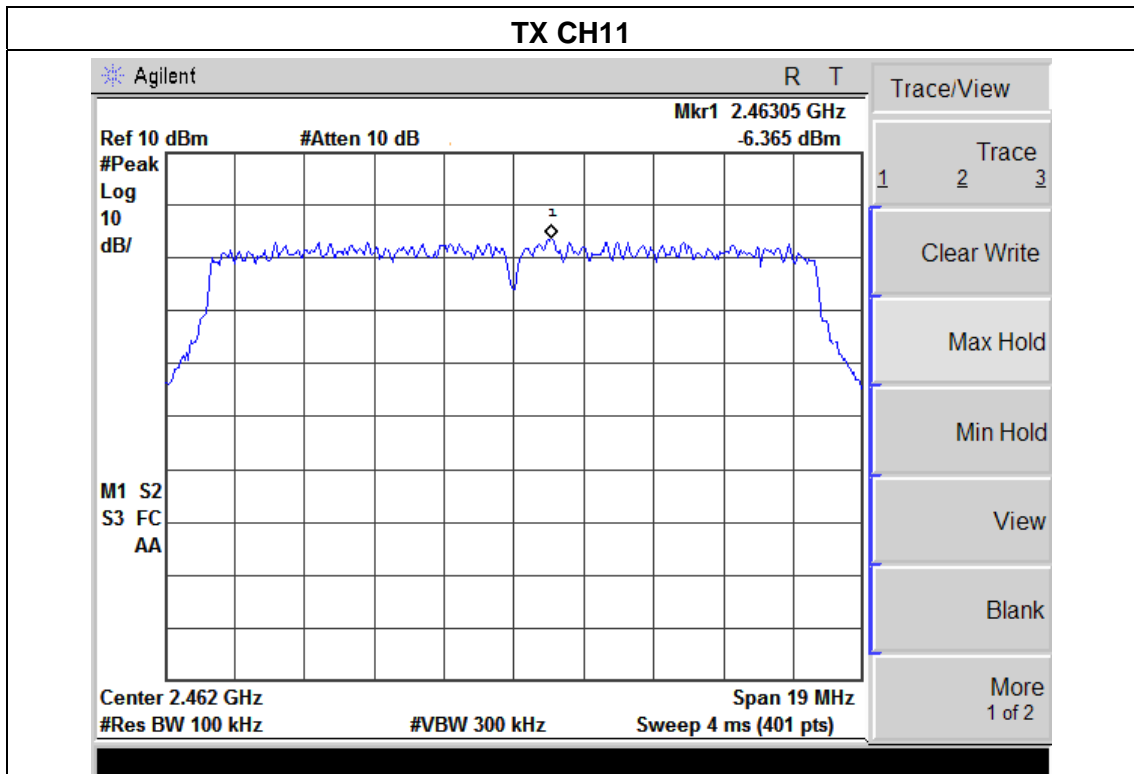
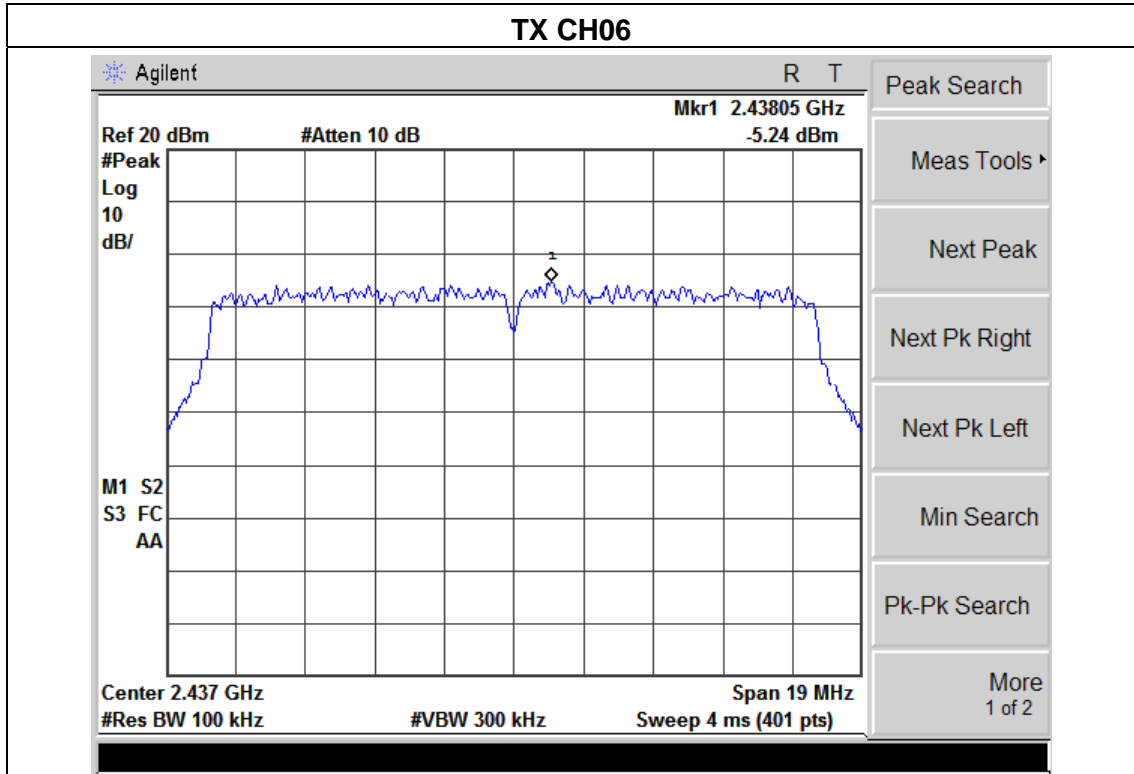

EUT :	150M Wireless USB adapter	Model Name :	MT-WN715N
Temperature :	25 °C	Relative Humidity :	60%
Pressure :	1015 hPa	Test Voltage :	DC 5.0V
Test Mode :	TX n Mode(20M) /CH01, CH06, CH11		

Frequency	Power Density (dBm)	PSD/ 3KHz (dBm)	Limit (dBm)	Result
2412 MHz	-6.93	-22.13	8	<b>PASS</b>
2437 MHz	-6.40	-21.60	8	<b>PASS</b>
2462 MHz	-7.54	-22.74	8	<b>PASS</b>

**Note:**

BWCF =  $10\log(3\text{ kHz}/100\text{ kHz}) = -15.2\text{ dB}$ .

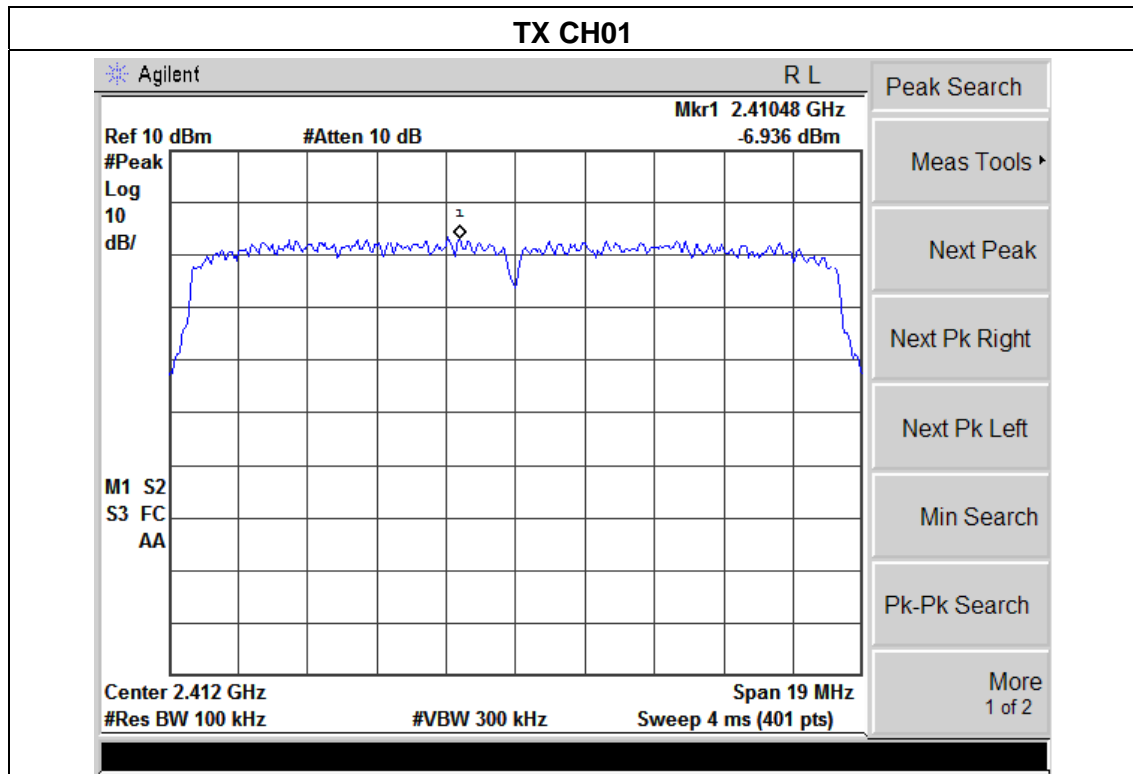

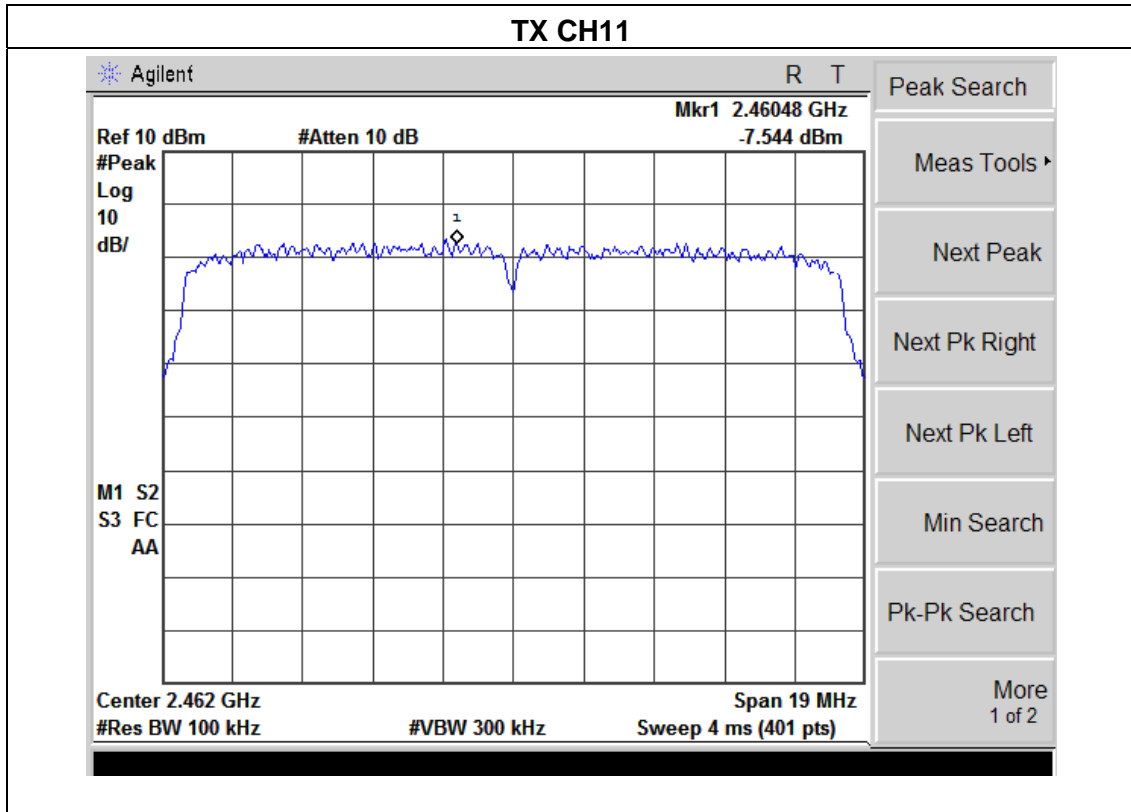
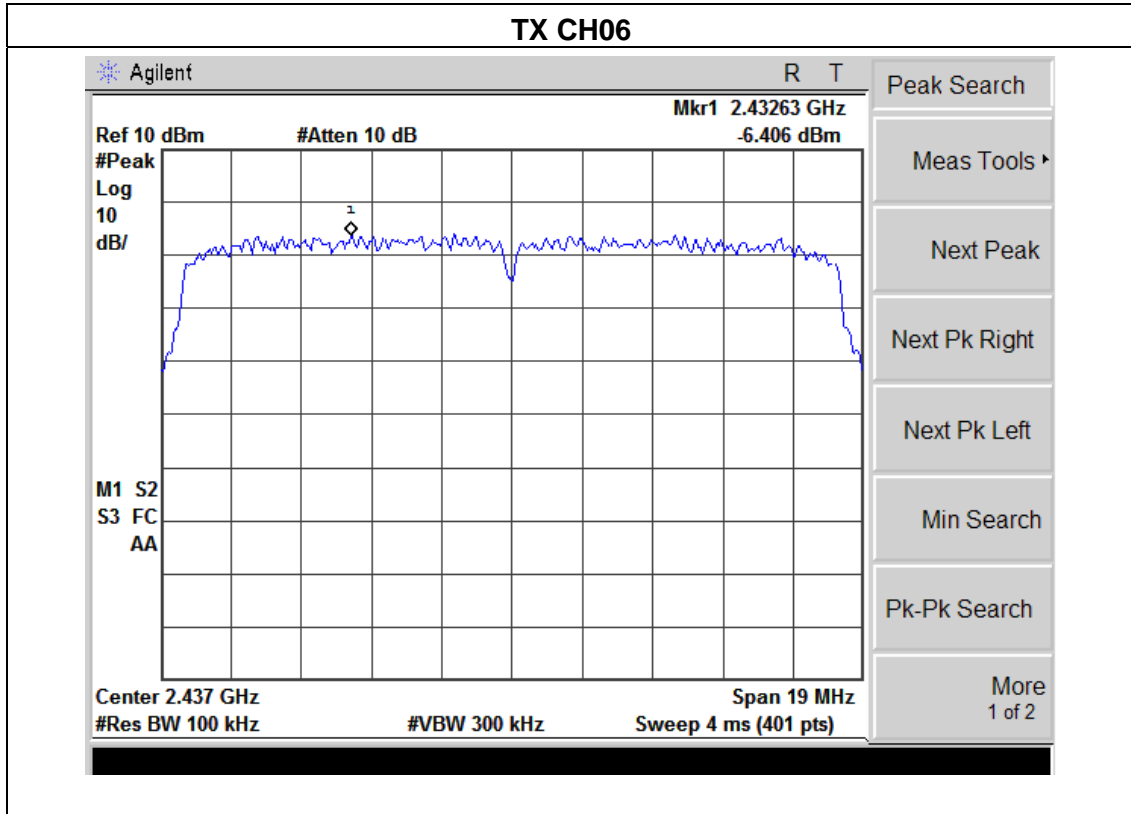

EUT :	150M Wireless USB adapter	Model Name :	MT-WN715N
Temperature :	25 °C	Relative Humidity :	60%
Pressure :	1015 hPa	Test Voltage :	DC 5.0V
Test Mode :	TX n Mode(40M) /CH03, CH06, CH09		

Frequency	Power Density (dBm)	PSD/ 3KHz (dBm)	Limit (dBm)	Result
2422 MHz	-4.73	-19.93	8	<b>PASS</b>
2437 MHz	-5.42	-20.62	8	<b>PASS</b>
2452 MHz	-5.18	-20.38	8	<b>PASS</b>

**Note:**

BWCF =  $10\log(3\text{ kHz}/100\text{ kHz}) = -15.2\text{ dB}$ .

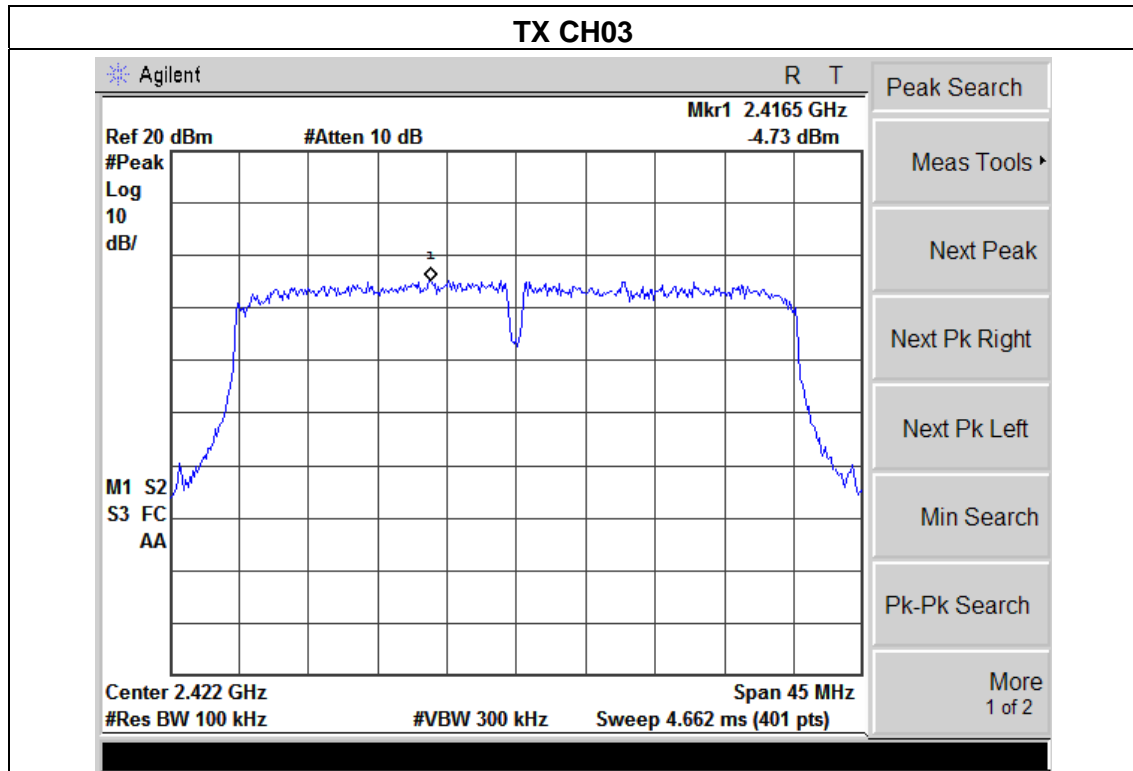

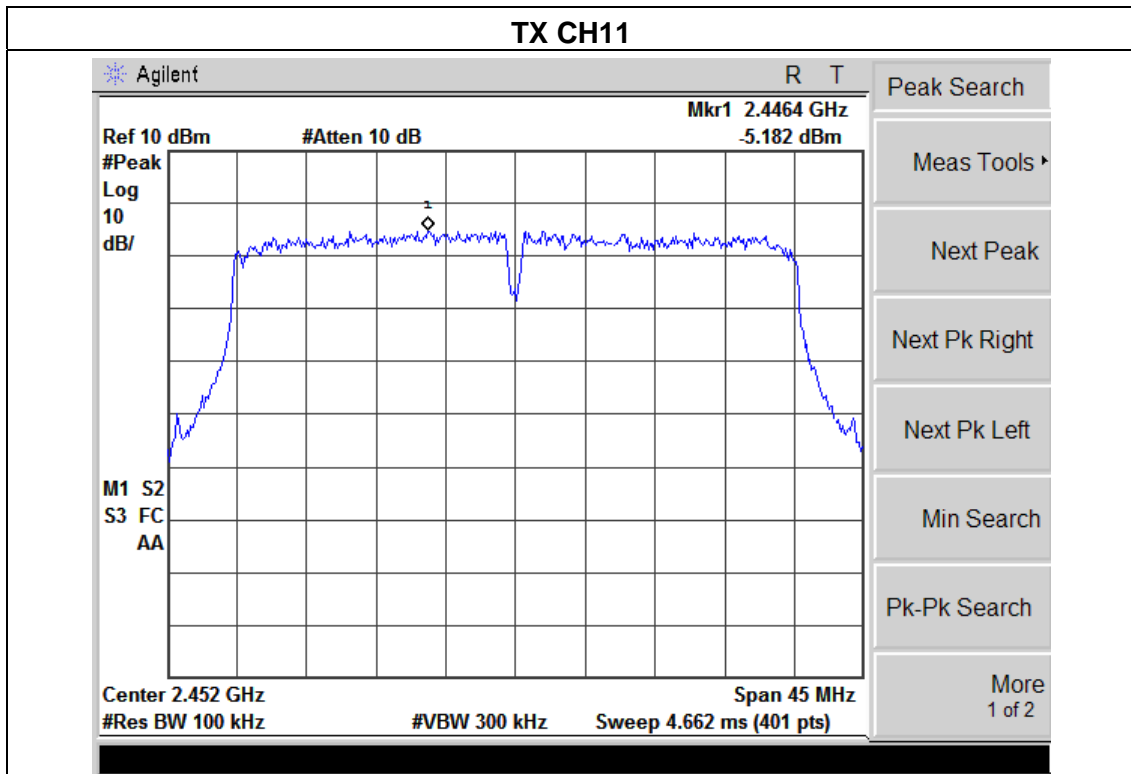
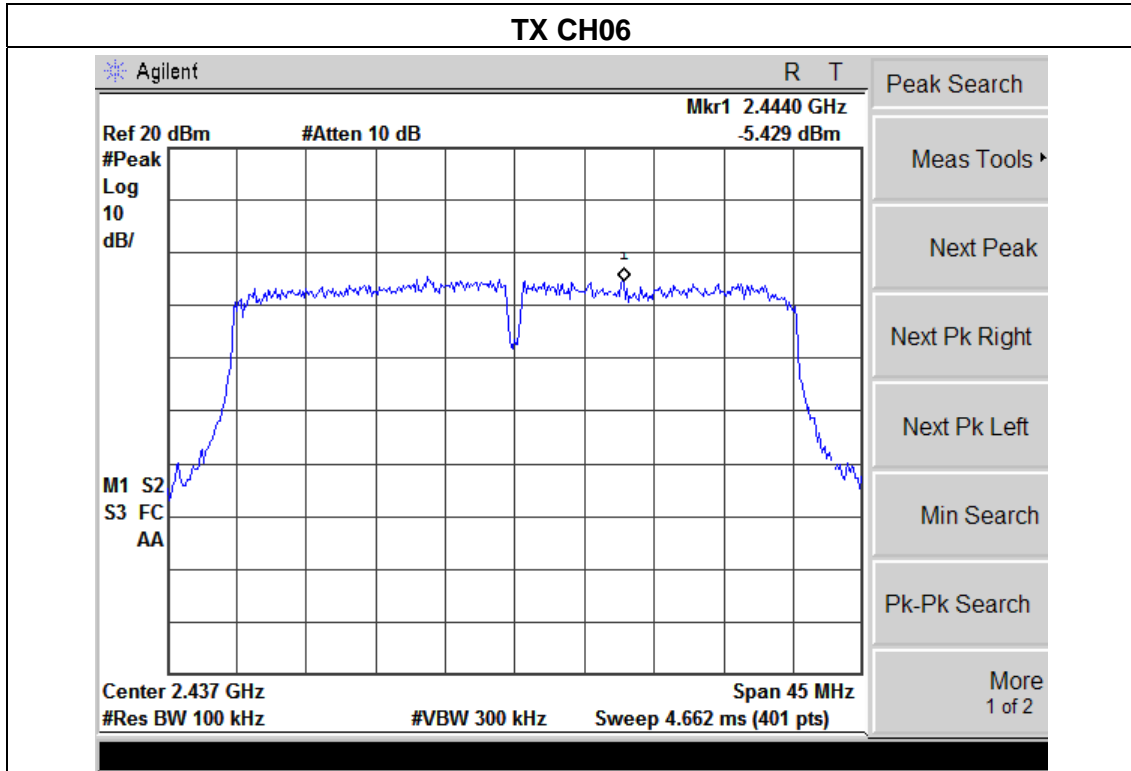



## 5. BANDWIDTH TEST

### 5.1 APPLIED PROCEDURES / LIMIT

FCC Part15 (15.247) , Subpart C				
Section	Test Item	Limit	Frequency Range (MHz)	Result
15.247(a)(2)	Bandwidth	$\geq 500\text{KHz}$ (6dB bandwidth)	2400-2483.5	PASS

Spectrum Parameter	Setting
Attenuation	Auto
Span Frequency	$>$ Measurement Bandwidth or Channel Separation
RB	30 kHz (20dB Bandwidth) / 100 kHz (Channel Separation)
VB	100 kHz (20dB Bandwidth) / 300 kHz (Channel Separation)
Detector	Peak
Trace	Max Hold
Sweep Time	Auto

#### 5.1.1 TEST PROCEDURE

- a.
- The testing follows FCC KDB Publication No. 558074 D01 DTS Meas. Guidance v01.
  - The RF output of EUT was connected to the spectrum analyzer by a low loss cable. The path loss was compensated to the results for each measurement.
  - Make the measurement with the spectrum analyzer's resolution bandwidth (RBW) = 1-5% of the emission bandwidth (EBW). Set the Video bandwidth (VBW)  $\geq 3 * \text{RBW}$ . In order to make an accurate measurement. The 6 dB bandwidth must be greater than 500 KHz.
  - The marker-delta reading at this point is the 6 dB bandwidth of the emission.

#### 5.1.2 DEVIATION FROM STANDARD

No deviation.

#### 5.1.3 TEST SETUP

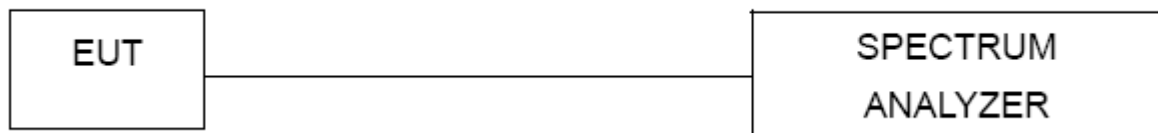

#### 5.1.4 EUT OPERATION CONDITIONS

The EUT tested system was configured as the statements of 2.4 Unless otherwise a special operating condition is specified in the follows during the testing.

### 5.1.5 TEST RESULTS

EUT :	150M Wireless USB adapter	Model Name :	MT-WN715N
Temperature :	25 °C	Relative Humidity :	60%
Pressure :	1012 hPa	Test Voltage :	DC 5.0V
Test Mode :	TX b Mode /CH01, CH06, CH11		

Frequency	6dB Bandwidth (MHz)	99% Occupied BW (MHz)	Channel Separation (MHz)	Result
2412 MHz	11.47	14.02	>=500KHz	<b>PASS</b>
2437 MHz	11.43	14.06	>=500KHz	<b>PASS</b>
2462 MHz	11.41	14.03	>=500KHz	<b>PASS</b>

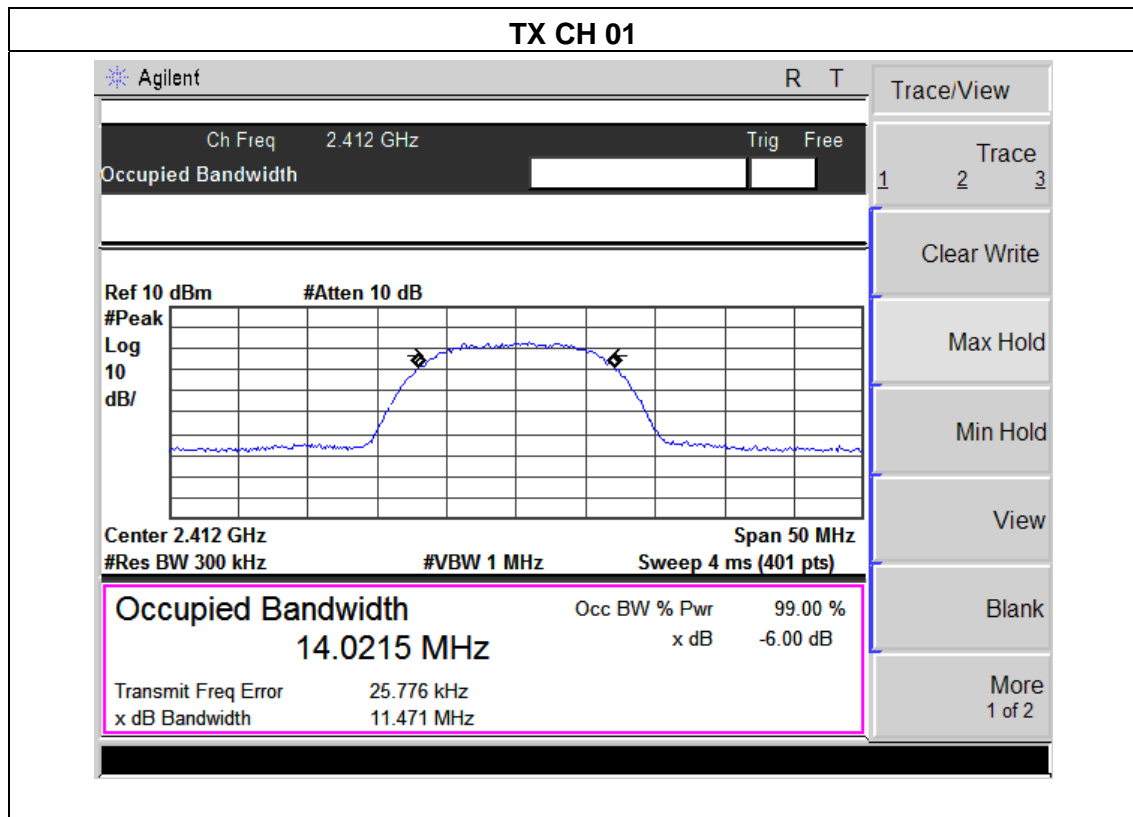

### TX CH 06

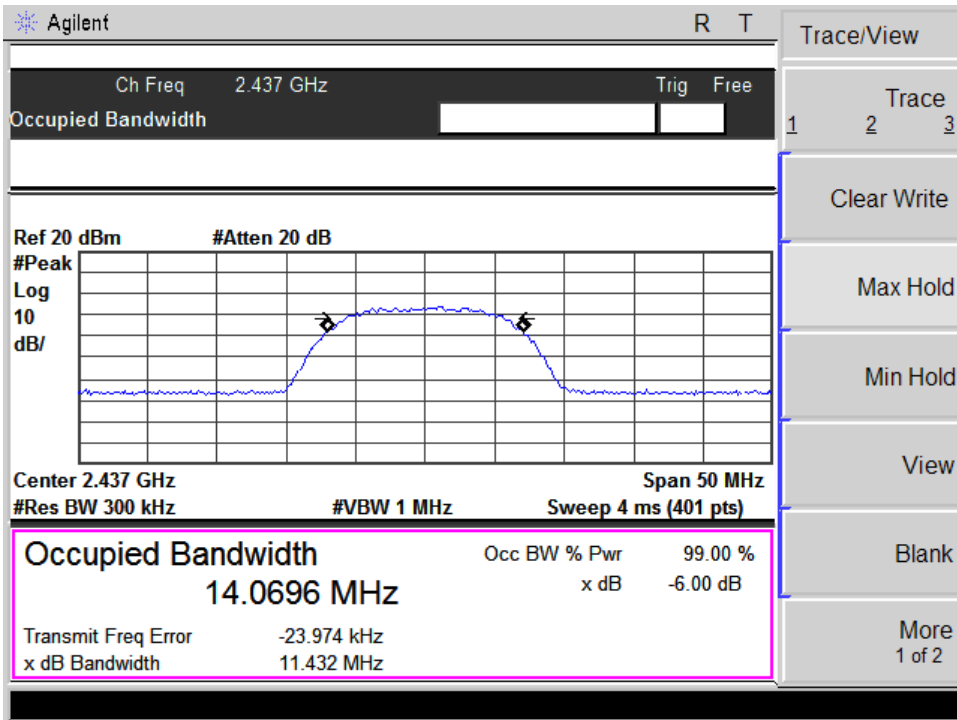

### TX CH 11

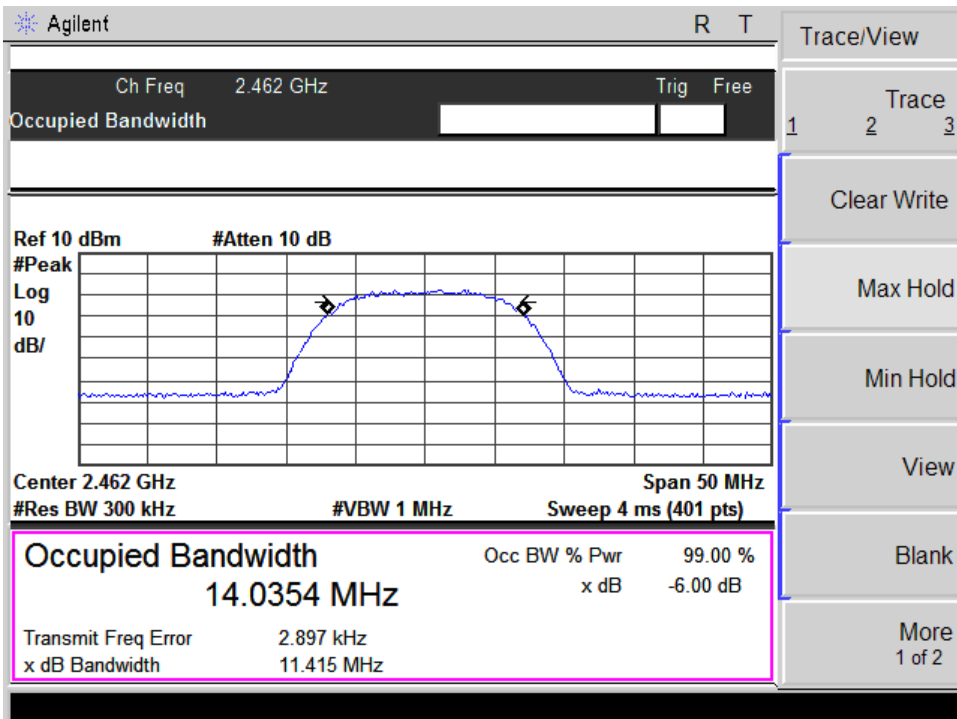

EUT :	150M Wireless USB adapter	Model Name :	MT-WN715N
Temperature :	25 °C	Relative Humidity :	60%
Pressure :	1012 hPa	Test Voltage :	DC 5.0V
Test Mode :	TX g Mode /CH01, CH06, CH11		

Frequency	6dB Bandwidth (MHz)	99% Occupied BW (MHz)	Channel Separation (MHz)	Result
2412 MHz	16.44	16.52	>=500KHz	<b>PASS</b>
2437 MHz	16.53	16.52	>=500KHz	<b>PASS</b>
2462 MHz	16.50	16.57	>=500KHz	<b>PASS</b>

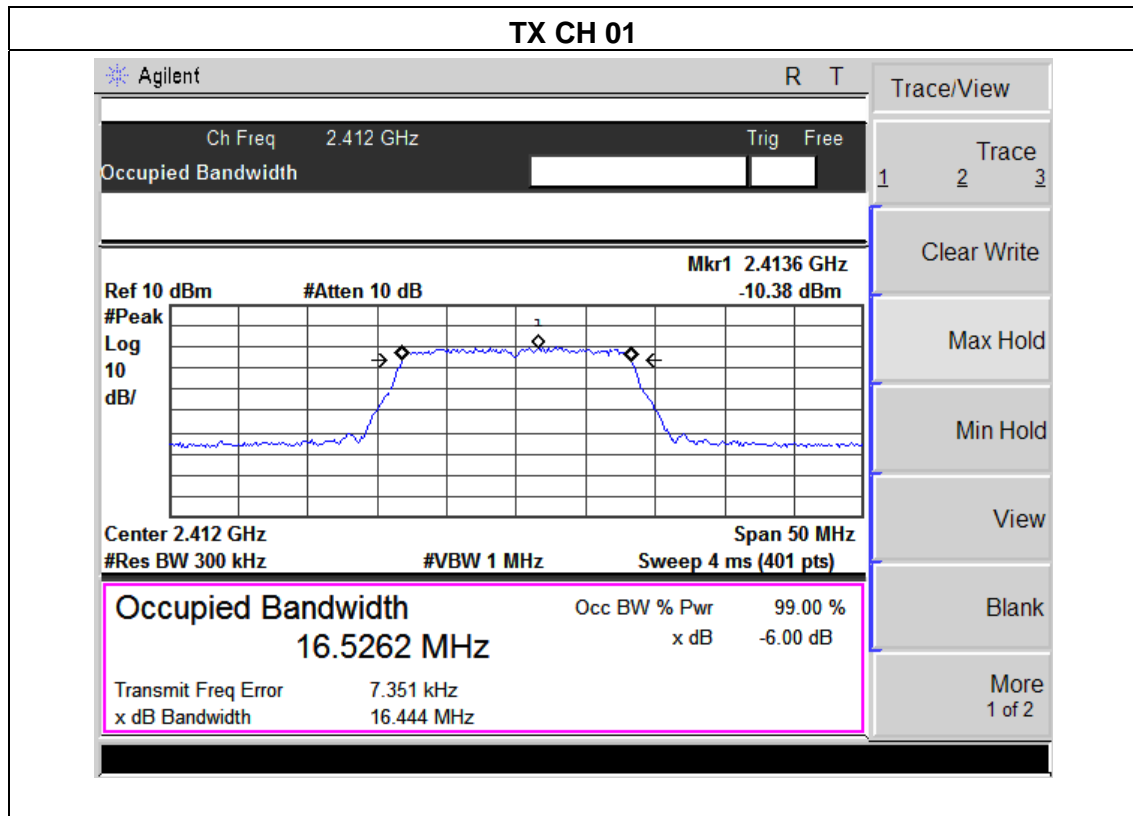

### TX CH 06

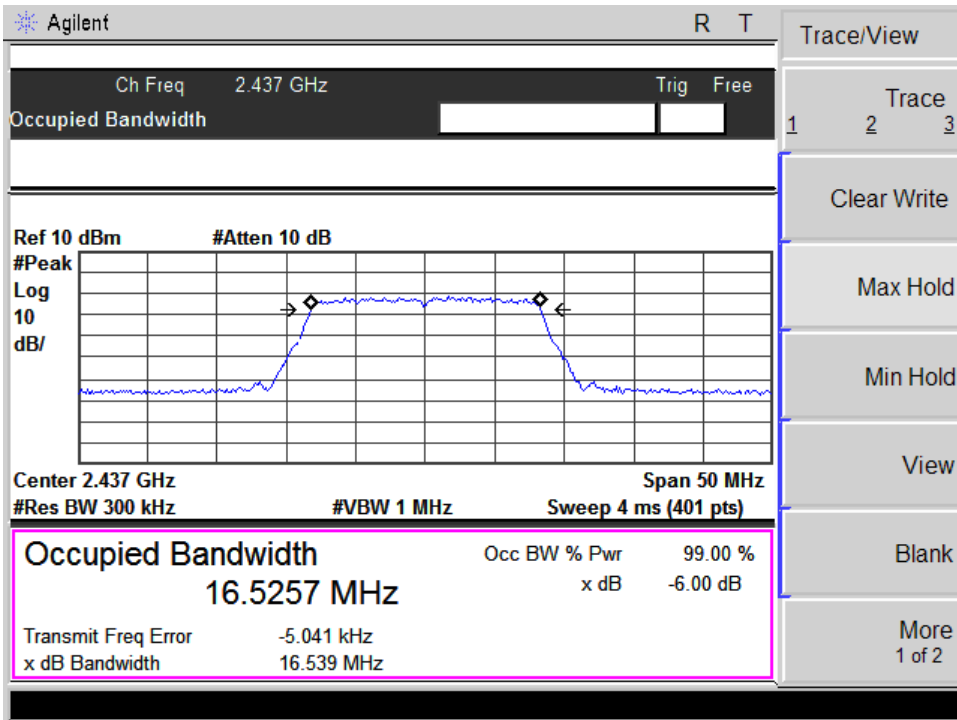

### TX CH 11

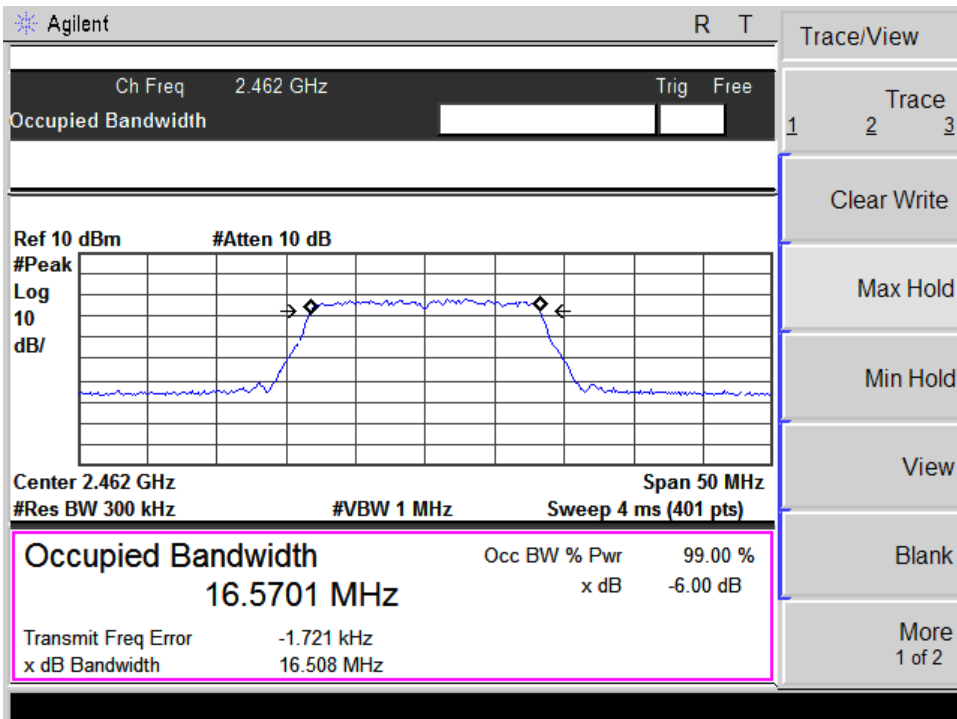

EUT :	150M Wireless USB adapter	Model Name :	MT-WN715N
Temperature :	25 °C	Relative Humidity :	60%
Pressure :	1012 hPa	Test Voltage :	DC 5.0V
Test Mode :	TX n Mode(20M) /CH01, CH06, CH11		

Frequency	6dB Bandwidth (MHz)	99% Occupied BW (MHz)	Channel Separation (MHz)	Result
2412 MHz	16.89	16.87	>=500KHz	<b>PASS</b>
2437 MHz	16.88	16.88	>=500KHz	<b>PASS</b>
2462 MHz	16.83	16.83	>=500KHz	<b>PASS</b>

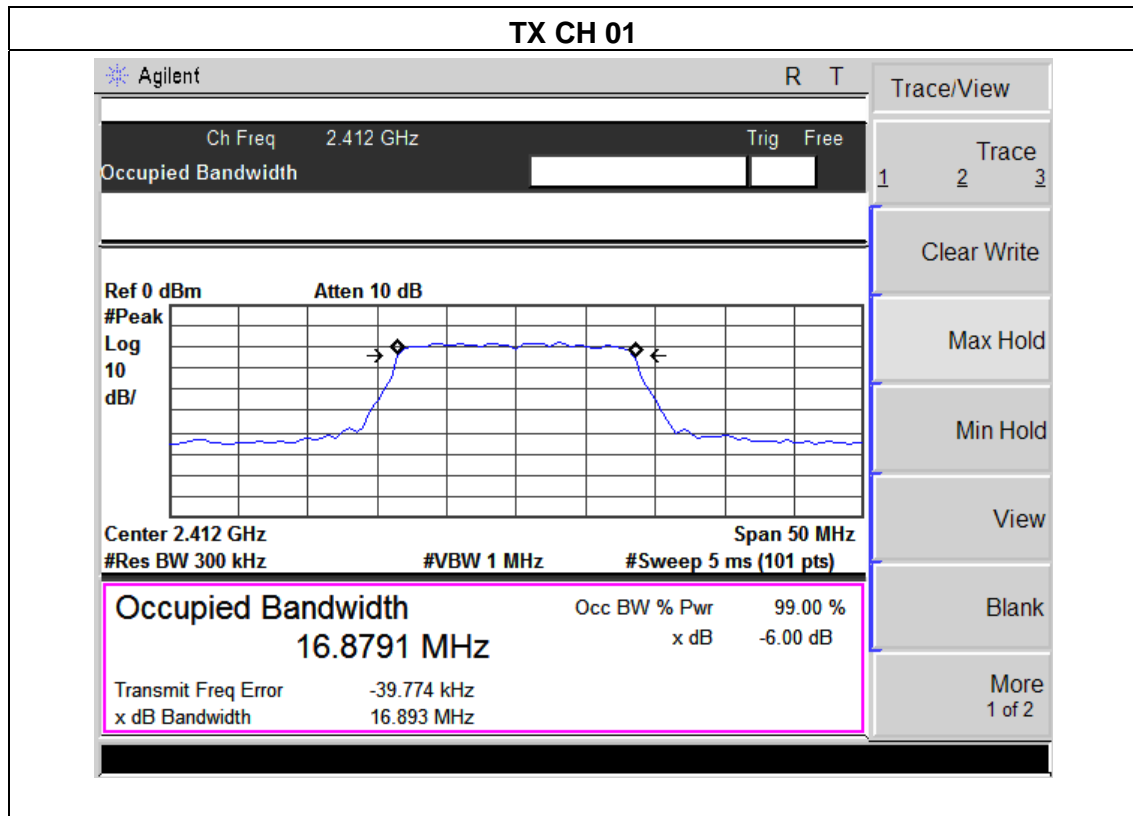

### TX CH 06

Agilent R T

---

Ch Freq 2.437 GHz Trig Free

Occupied Bandwidth [ ] [ ]

---

Ref 0 dBm Atten 10 dB

#Peak  
Log  
10  
dB/

Center 2.437 GHz Span 50 MHz  
#Res BW 300 kHz #VBW 1 MHz #Sweep 5 ms (101 pts)

**Occupied Bandwidth** Occ BW % Pwr 99.00 %

16.8866 MHz x dB -6.00 dB

Transmit Freq Error -20.166 kHz  
x dB Bandwidth 16.885 MHz

Freq/Channel

---

Center Freq  
2.43700000 GHz

---

Start Freq  
2.41200000 GHz

---

Stop Freq  
2.46200000 GHz

---

CF Step  
5.00000000 MHz  
Auto Man

---

Freq Offset  
0.00000000 Hz

---

Signal Track  
On Off

---

Scale Type  
Log Lin

### TX CH 11

Agilent R T

---

Ch Freq 2.462 GHz Trig Free

Occupied Bandwidth [ ] [ ]

---

Ref 0 dBm Atten 10 dB

#Peak  
Log  
10  
dB/

Center 2.462 GHz Span 50 MHz  
#Res BW 300 kHz #VBW 1 MHz #Sweep 5 ms (101 pts)

**Occupied Bandwidth** Occ BW % Pwr 99.00 %

16.8373 MHz x dB -6.00 dB

Transmit Freq Error 29.584 kHz  
x dB Bandwidth 16.834 MHz

Trace/View

---

Trace  
1 2 3

---

Clear Write

---

Max Hold

---

Min Hold

---

View

---

Blank

---

More  
1 of 2

EUT :	150M Wireless USB adapter	Model Name :	MT-WN715N
Temperature :	25 °C	Relative Humidity :	60%
Pressure :	1012 hPa	Test Voltage :	DC 5.0V
Test Mode :	TX n Mode(40M) /CH03, CH06, CH09		

Frequency	6dB Bandwidth (MHz)	99% Occupied BW (MHz)	Channel Separation (MHz)	Result
2422 MHz	35.60	35.97	>=500KHz	<b>PASS</b>
2437 MHz	35.66	36.03	>=500KHz	<b>PASS</b>
2452 MHz	35.64	35.98	>=500KHz	<b>PASS</b>

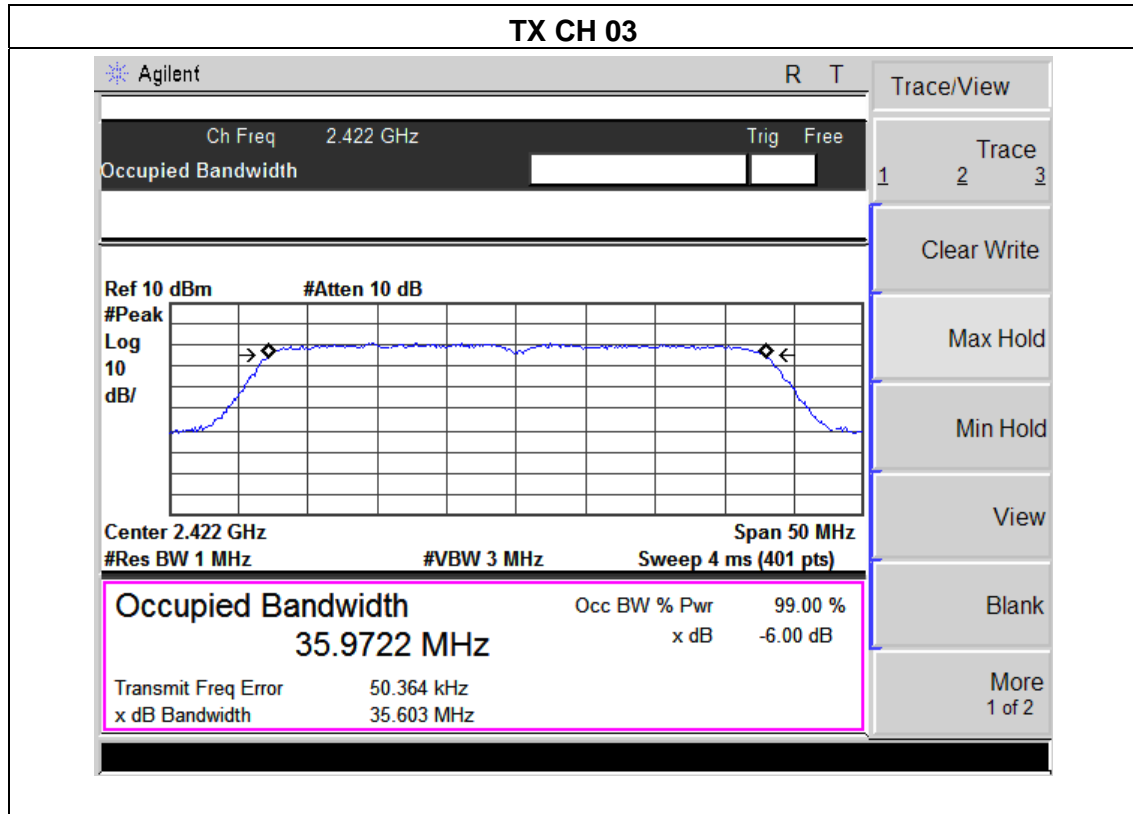



### TX CH 06

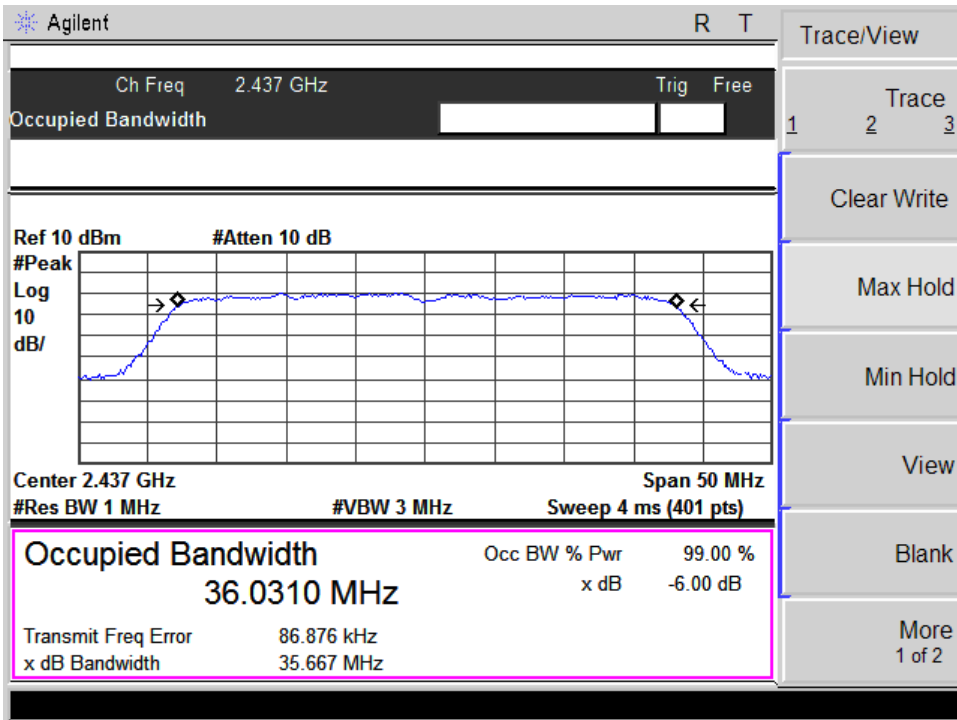

### TX CH 09

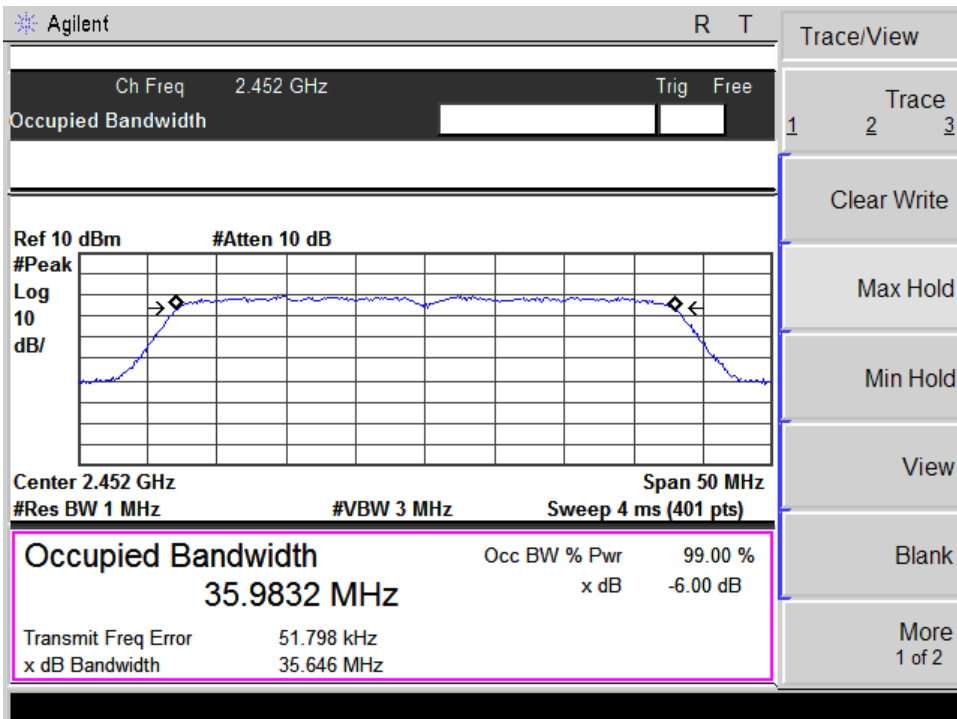

**6. PEAK OUTPUT POWER TEST**

**6.1 APPLIED PROCEDURES / LIMIT**

FCC Part15 (15.247) , Subpart C				
Section	Test Item	Limit	Frequency Range (MHz)	Result
15.247(b)(3)	Peak Output Power	1 watt or 30dBm	2400-2483.5	PASS

**6.1.1 TEST PROCEDURE**

- a. The EUT was directly connected to the Power meter

**6.1.2 DEVIATION FROM STANDARD**

No deviation.

**6.1.3 TEST SETUP**



**6.1.4 EUT OPERATION CONDITIONS**

The EUT tested system was configured as the statements of 2.4 Unless otherwise a special operating condition is specified in the follows during the testing.

**6.1.5 TEST RESULTS**

EUT :	150M wireless USB adapter	Model Name :	MT-WN715N
Temperature :	25 °C	Relative Humidity :	60%
Pressure :	1012 hPa	Test Voltage :	DC 5.0V
Test Mode :	TX b/g/n(20M,40M) Mode /CH01, CH06, CH11		

<b>TX802.11b Mode</b>					
Test Channel	Frequency	Peak output power. Antenna port	Antenna Gain	EIRP	LIMIT
	(MHz)	(dBm)	dBi	dBm	dBm
CH01	2412	11.76	1.06	12.82	30
CH06	2437	11.32	1.06	12.38	30
CH11	2462	10.98	1.06	12.04	30
<b>TX 802.11g Mode</b>					
CH01	2412	9.62	1.06	10.68	30
CH06	2437	9.52	1.06	10.58	30
CH11	2462	9.41	1.06	10.47	30
<b>TX 802.11n/20M Mode</b>					
CH01	2412	9.59	1.06	10.65	30
CH06	2437	9.50	1.06	10.56	30
CH11	2462	9.31	1.06	10.37	30
<b>TX 802.11n/40M Mode</b>					
CH03	2422	9.87	1.06	10.93	30
CH06	2437	9.77	1.06	10.83	30
CH11	2452	9.21	1.06	10.27	30

## **7. ANTENNA REQUIREMENT**

### **7.1 STANDARD REQUIREMENT**

15.203 requirement: For intentional device, according to 15.203: an intentional radiator shall be designed to ensure that no antenna other than that furnished by the responsible party shall be used with the device.

### **7.2 EUT ANTENNA**

The EUT antenna is PCB antenna. It comply with the standard requirement.

### 8. EUT TEST PHOTO

#### Radiated Measurement Photos

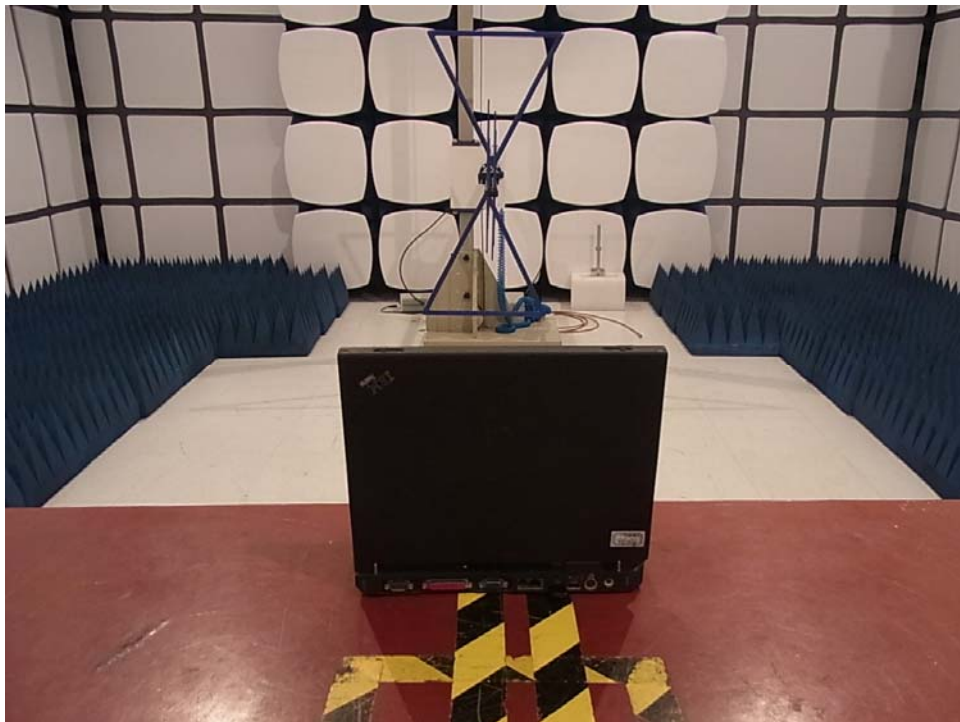
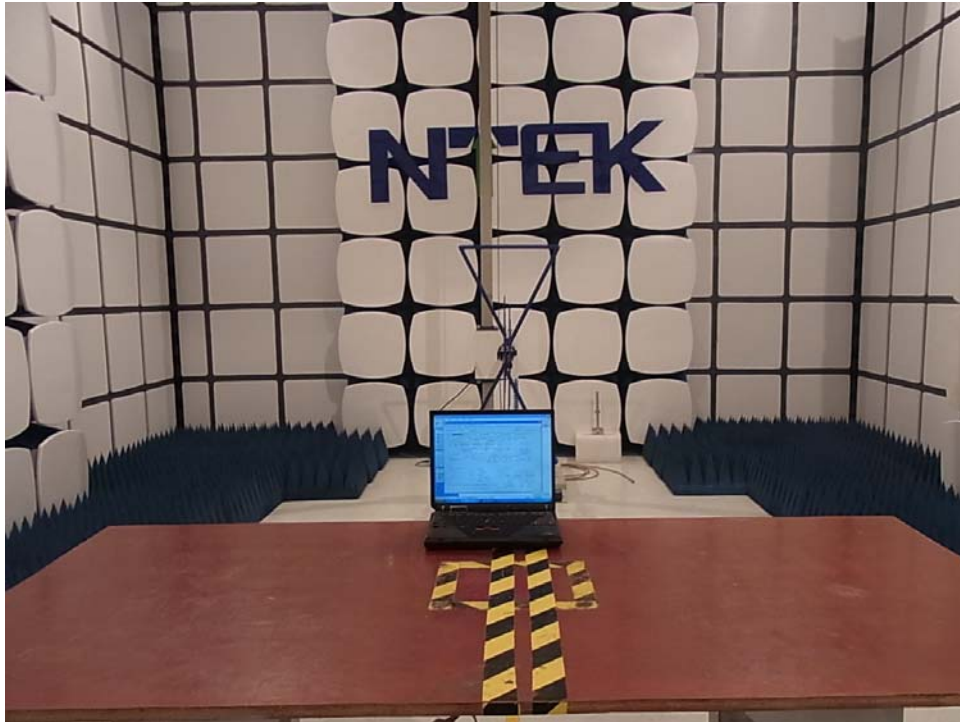

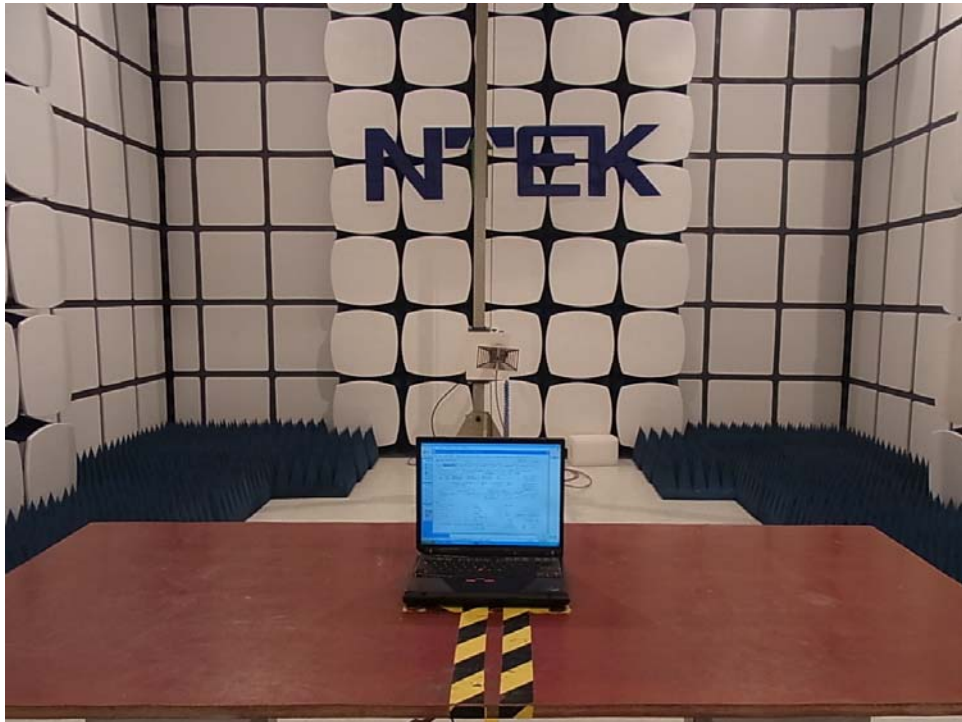
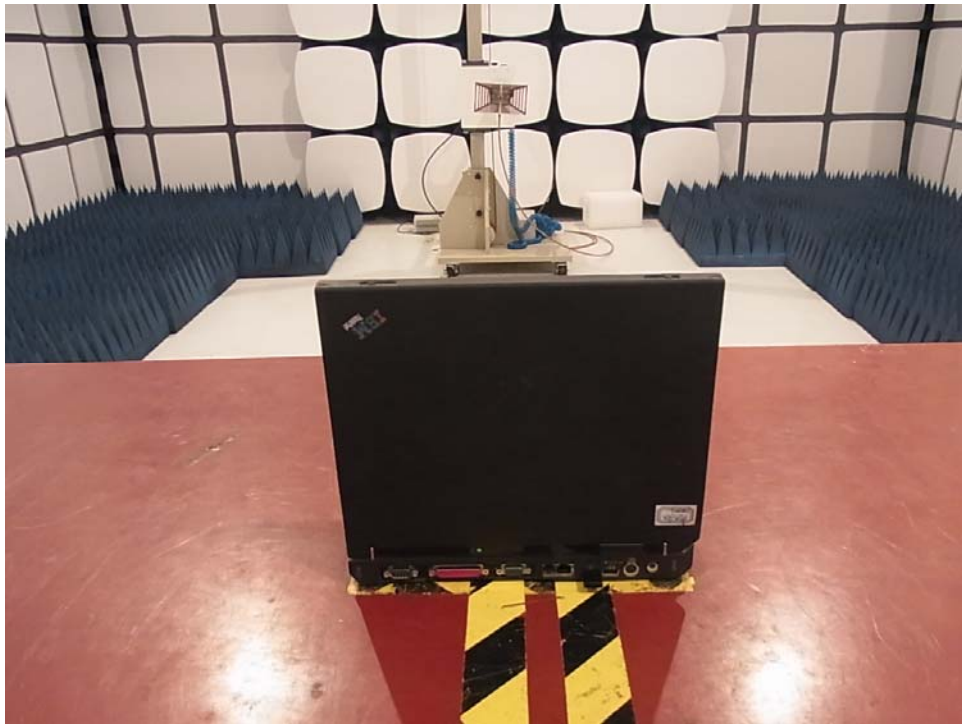

**Conducted Measurement Photos**

