



CFR 47 FCC PART 15 SUBPART C

TEST REPORT

For

Wireless Device

MODEL NUMBER: ASWK-002

REPORT NUMBER: 4790565307-RF-3

ISSUE DATE: October 26, 2022

FCC ID: ZVAASWK002

Prepared for

**Tonly Technology Co., Ltd
Section 37, Zhongkai High-tech development Zone Huizhou, Guangdong 516006
China**

Prepared by

UL Verification Services (Guangzhou) Co., Ltd, Song Shan Lake Branch

Building 10, Innovation Technology Park, No. 1, Li Bin Road, Song Shan Lake Hi-Tech Development Zone Dongguan, 523808, People's Republic of China

Tel: +86 769 22038881

Fax: +86 769 33244054

Website: www.ul.com

The results reported herein have been performed in accordance with the laboratory's terms of accreditation. This report shall not be reproduced except in full without the written approval of the Laboratory. The results in this report apply to the test sample(s) mentioned above at the time of the testing period only and are not to be used to indicate applicability to other similar products.



Revision History

Rev.	Issue Date	Revisions	Revised By
V0	October 26, 2022	Initial Issue	



Summary of Test Results			
Clause	Test Items	FCC Rules	Test Results
1	6dB Bandwidth and 99% Occupied Bandwidth	FCC Part 15.247 (a) (2)	Pass
2	Peak Conducted Output Power	FCC Part 15.247 (b) (3)	Pass
3	Power Spectral Density	FCC Part 15.247 (e)	Pass
4	Conducted Bandedge and Spurious Emission	FCC Part 15.247 (d)	Pass
5	Radiated Bandedge and Spurious Emission	FCC Part 15.247 (d) FCC Part 15.209 FCC Part 15.205	Pass
6	Conducted Emission Test for AC Power Port	FCC Part 15.207	Pass
7	Antenna Requirement	FCC Part 15.203	Pass
Note: 1.This test report is only published to and used by the applicant, and it is not for evidence purpose in China. 2. The measurement result for the sample received is <Pass> according to < CFR 47 FCC PART 15 SUBPART C > when <Accuracy Method> decision rule is applied.			

CONTENTS

1. ATTESTATION OF TEST RESULTS	6
2. TEST METHODOLOGY	7
3. FACILITIES AND ACCREDITATION	7
4. CALIBRATION AND UNCERTAINTY	8
4.1. <i>MEASURING INSTRUMENT CALIBRATION</i>	8
4.2. <i>MEASUREMENT UNCERTAINTY</i>	8
5. EQUIPMENT UNDER TEST	9
5.1. <i>DESCRIPTION OF EUT</i>	9
5.2. <i>CHANNEL LIST</i>	9
5.3. <i>MAXIMUM EIRP</i>	9
5.4. <i>TEST CHANNEL CONFIGURATION</i>	10
5.5. <i>THE WORSE CASE POWER SETTING PARAMETER</i>	10
5.6. <i>DESCRIPTION OF AVAILABLE ANTENNAS</i>	10
5.7. <i>DESCRIPTION OF TEST SETUP</i>	11
6. MEASURING EQUIPMENT AND SOFTWARE USED	12
7. ANTENNA PORT TEST RESULTS	14
7.1. <i>CONDUCTED OUTPUT POWER</i>	14
7.2. <i>6DB BANDWIDTH AND 99% OCCUPIED BANDWIDTH</i>	15
7.3. <i>POWER SPECTRAL DENSITY</i>	17
7.4. <i>CONDUCTED BAND EDGE AND SPURIOUS EMISSION</i>	18
7.5. <i>DUTY CYCLE</i>	20
8. RADIATED TEST RESULTS	21
8.1. <i>RESTRICTED BANDEDGE</i>	29
8.2. <i>SPURIOUS EMISSIONS (1 GHZ ~ 3 GHZ)</i>	37
8.3. <i>SPURIOUS EMISSIONS (3 GHZ ~ 18 GHZ)</i>	43
8.4. <i>SPURIOUS EMISSIONS (9 KHZ ~ 30 MHZ)</i>	55
8.5. <i>SPURIOUS EMISSIONS (18 GHZ ~ 26 GHZ)</i>	58
8.6. <i>SPURIOUS EMISSIONS (30 MHZ ~ 1 GHZ)</i>	60
9. ANTENNA REQUIREMENT	62
10. TEST DATA	63
10.1. <i>APPENDIX A: DTS BANDWIDTH</i>	63



10.1.1.	Test Result.....	63
10.1.2.	Test Graphs	64
10.2.	<i>APPENDIX B: OCCUPIED CHANNEL BANDWIDTH.....</i>	<i>66</i>
10.2.1.	Test Result.....	66
10.2.2.	Test Graphs	67
10.3.	<i>APPENDIX C: MAXIMUM PEAK CONDUCTED OUTPUT POWER</i>	<i>69</i>
10.3.1.	Test Result.....	69
10.4.	<i>APPENDIX D: MAXIMUM POWER SPECTRAL DENSITY.....</i>	<i>70</i>
10.4.1.	Test Result.....	70
10.4.2.	Test Graphs	71
10.5.	<i>APPENDIX E: BAND EDGE MEASUREMENTS.....</i>	<i>73</i>
10.5.1.	Test Result.....	73
10.5.2.	Test Graphs	74
10.6.	<i>APPENDIX F: CONDUCTED SPURIOUS EMISSION</i>	<i>76</i>
10.6.1.	Test Result.....	76
10.6.2.	Test Graphs	77
10.7.	<i>APPENDIX G: DUTY CYCLE.....</i>	<i>83</i>
10.7.1.	Test Result.....	83
10.7.2.	Test Graphs	84



1. ATTESTATION OF TEST RESULTS

Applicant Information

Company Name: Tonly Technology Co., Ltd.
Address: Section 37, Zhongkai High-tech development Zone Huizhou, Guangdong 516006 China

Manufacturer Information

Company Name: Amazon.com Services, LLC
Address: 410 Terry Ave North, Seattle, WA 98109 USA

EUT Information

EUT Name: Wireless Device
Model: ASWK-002
Sample Received Date: September 14, 2022
Sample Status: Normal
Sample ID: 5337663
Date of Tested: September 15, 2022 to October 26, 2022

APPLICABLE STANDARDS	
STANDARD	TEST RESULTS
CFR 47 FCC PART 15 SUBPART C	PASS

Prepared By:

Denny Huang
Senior Project Engineer

Checked By:

Kebo Zhang
Senior Project Engineer

Approved By:

Stephen Guo
Operations Manager



2. TEST METHODOLOGY

All tests were performed in accordance with the standard CFR 47 FCC PART 15 SUBPART C, KDB 558074 D01 15.247 Meas Guidance v05r02, KDB 414788 D01 Radiated Test Site v01r01, CFR 47 FCC Part 2, ANSI C63.10-2013.

3. FACILITIES AND ACCREDITATION

Accreditation Certificate	<p>A2LA (Certificate No.: 4102.01) UL Verification Services (Guangzhou) Co., Ltd. Song Shan Lake Branch. has been assessed and proved to be in compliance with A2LA.</p> <p>FCC (FCC Designation No.: CN1187) UL Verification Services (Guangzhou) Co., Ltd. Song Shan Lake Branch. Has been recognized to perform compliance testing on equipment subject to the Commission's Declaration of Conformity (DoC) and Certification rules</p> <p>ISED (Company No.: 21320) UL Verification Services (Guangzhou) Co., Ltd. Song Shan Lake Branch. has been registered and fully described in a report filed with ISED. The Company Number is 21320 and the test lab Conformity Assessment Body Identifier (CABID) is CN0046.</p> <p>VCCI (Registration No.: G-20019, R-20004, C-20012 and T-20011) UL Verification Services (Guangzhou) Co., Ltd. Song Shan Lake Branch. has been assessed and proved to be in compliance with VCCI, the Membership No. is 3793. Facility Name: Chamber D, the VCCI registration No. is G-20019 and R-20004 Shielding Room B , the VCCI registration No. is C-20012 and T-20011</p>
---------------------------	---

Note 1:

All tests measurement facilities use to collect the measurement data are located at Building 10, Innovation Technology Park, No. 1, Li Bin Road, Song Shan Lake Hi-Tech Development Zone Dongguan, 523808, People's Republic of China.

Note 2:

The test anechoic chamber in UL Verification Services (Guangzhou) Co., Ltd. Song Shan Lake Branch had been calibrated and compared to the open field sites and the test anechoic chamber is shown to be equivalent to or worst case from the open field site.

Note 3:

For below 30 MHz, lab had performed measurements at test anechoic chamber and comparing to measurements obtained on an open field site. And these measurements below 30 MHz had been correlated to measurements performed on an OFS.



4. CALIBRATION AND UNCERTAINTY

4.1. MEASURING INSTRUMENT CALIBRATION

The measuring equipment utilized to perform the tests documented in this report has been calibrated in accordance with the manufacturer's recommendations and is traceable to recognized national standards.

4.2. MEASUREMENT UNCERTAINTY

Where relevant, the following measurement uncertainty levels have been estimated for tests performed on the apparatus:

Test Item	Uncertainty
Conduction emission	3.62 dB
Radiated Emission (Included Fundamental Emission) (9 kHz ~ 30 MHz)	2.2 dB
Radiated Emission (Included Fundamental Emission) (30 MHz ~ 1 GHz)	4.00 dB
Radiated Emission (Included Fundamental Emission) (1 GHz to 26 GHz)	5.78 dB (1 GHz ~ 18 GHz)
	5.23 dB (18 GHz ~ 26 GHz)
Note: This uncertainty represents an expanded uncertainty expressed at approximately the 95% confidence level using a coverage factor of k=2.	



5. EQUIPMENT UNDER TEST

5.1. DESCRIPTION OF EUT

EUT Name	Wireless Device	
Model	ASWK-002	
Technology	Bluetooth - Low Energy	
Transmit Frequency Range	2402 MHz ~ 2480 MHz	
Modulation	GFSK	
Data Rate	LE 1M	1 Mbps
	LE 2M	2 Mbps
Ratings	DC 3 V	

5.2. CHANNEL LIST

Channel	Frequency (MHz)	Channel	Frequency (MHz)	Channel	Frequency (MHz)	Channel	Frequency (MHz)
0	2402	11	2424	22	2446	33	2468
1	2404	12	2426	23	2448	34	2470
2	2406	13	2428	24	2450	35	2472
3	2408	14	2430	25	2452	36	2474
4	2410	15	2432	26	2454	37	2476
5	2412	16	2434	27	2456	38	2478
6	2414	17	2436	28	2458	39	2480
7	2416	18	2438	29	2460	/	/
8	2418	19	2440	30	2462	/	/
9	2420	20	2442	31	2464	/	/
10	2422	21	2444	32	2468	/	/

5.3. MAXIMUM EIRP

Test Mode	Frequency (MHz)	Channel Number	Maximum Peak Output Power (dBm)	Maximum EIRP (dBm)
LE 1M	2402 ~ 2480	0-39[40]	0.49	4.61
LE 2M	2402 ~ 2480	0-39[40]	0.19	4.31

5.4. TEST CHANNEL CONFIGURATION

Test Mode	Test Channel	Frequency
LE 1M	CH 0(Low Channel), CH 19(MID Channel), CH 39(High Channel)	2402 MHz, 2440 MHz, 2480 MHz
LE 2M	CH 0(Low Channel), CH 19(MID Channel), CH 39(High Channel)	2402 MHz, 2440 MHz, 2480 MHz

5.5. THE WORSE CASE POWER SETTING PARAMETER

The Worse Case Power Setting Parameter under 2400 ~ 2483.5MHz Band				
Test Software Version		BLE TDM 1.2.9		
Modulation Type	Transmit Antenna Number	Test Software setting value		
		CH 0	CH 19	CH 39
GFSK(1Mbps)	1	0	0	0
GFSK(2Mbps)	1	0	0	0

5.6. DESCRIPTION OF AVAILABLE ANTENNAS

Antenna	Frequency (MHz)	Antenna Type	Maximum Antenna Gain (dBi)
1	2402-2480	PCB	4.12

Test Mode	Transmit and Receive Mode	Description
LE 1M	1TX, 1RX	Chain 1 can be used as transmitting/receiving antenna.
LE 2M	1TX, 1RX	Chain 1 can be used as transmitting/receiving antenna.

Note: The value of the antenna gain was declared by customer.

5.7. DESCRIPTION OF TEST SETUP

SUPPORT EQUIPMENT

Item	Equipment	Brand Name	Model Name	Remarks
1	Laptop	Lenovo	E42	/
2	AC Adapter	Lenovo	ADLX65YLC3D	Input: AC 100-240 V, 50-60 Hz Output: DC 20 V, 3.25 A
3	USB Cable	/	/	/
4	USB to UART Board	/	/	/

I/O CABLES

Cable No	Port	Connector Type	Cable Type	Cable Length(m)	Remarks
1	/	/	/	/	/

ACCESSORIES

Item	Accessory	Brand Name	Model Name	Description
1	/	/	/	/

TEST SETUP

The EUT can work in engineering mode with a software through a Laptop.
New batteries were used during test.

SETUP DIAGRAM FOR TESTS

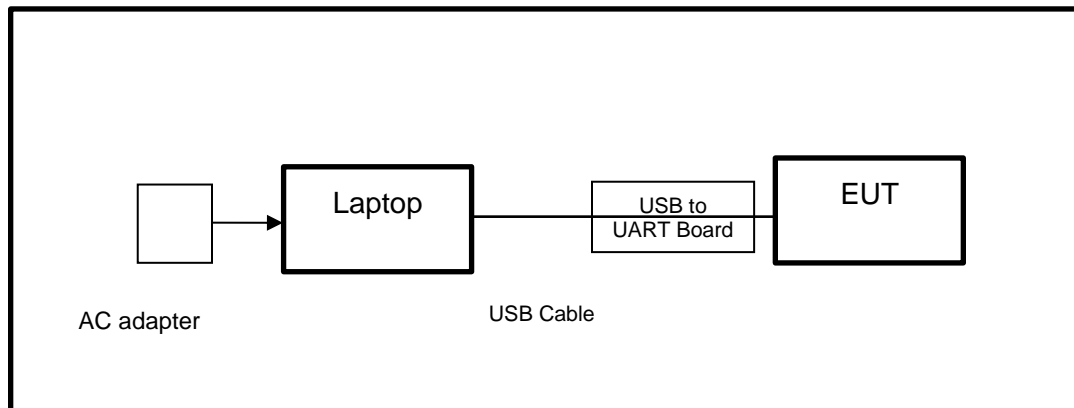



6. MEASURING EQUIPMENT AND SOFTWARE USED

Tonsend RF Test System					
Equipment	Manufacturer	Model No.	Serial No.	Last Cal.	Due. Date
Wideband Radio Communication Tester	R&S	CMW500	155523	Oct.30, 2021	Oct.29, 2022
PXA Signal Analyzer	Keysight	N9030A	MY55410512	Oct.30, 2021	Oct.29, 2022
MXG Vector Signal Generator	Keysight	N5182B	MY56200284	Oct.30, 2021	Oct.29, 2022
MXG Vector Signal Generator	Keysight	N5172B	MY56200301	Oct.30, 2021	Oct.29, 2022
DC power supply	Keysight	E3642A	MY55159130	Oct.30, 2021	Oct.29, 2022
Temperature & Humidity Chamber	SANMOOD	SG-80-CC-2	2088	Nov.20,2020	Nov.19,2022
Software					
Description	Manufacturer	Name		Version	
Tonsend SRD Test System	Tonsend	JS1120-3 RF Test System		2.6.77.0518	



Radiated Emissions					
Equipment	Manufacturer	Model No.	Serial No.	Last Cal.	Due Date
MXE EMI Receiver	KESIGHT	N9038A	MY56400036	Oct.30, 2021	Oct.29, 2022
Hybrid Log Periodic Antenna	TDK	HLP-3003C	130959	Aug.02, 2021	Aug.01, 2024
Preamplifier	HP	8447D	2944A09099	Oct.30, 2021	Oct.29, 2022
EMI Measurement Receiver	R&S	ESR26	101377	Oct.30, 2021	Oct.29, 2022
Horn Antenna	TDK	HRN-0118	130940	July 20, 2021	July 19, 2024
Preamplifier	TDK	PA-02-0118	TRS-305-00067	Oct.30, 2021	Oct.29, 2022
Horn Antenna	Schwarzbeck	BBHA9170	697	July 20, 2021	July 19, 2024
Preamplifier	TDK	PA-02-2	TRS-307-00003	Oct.31, 2021	Oct.30, 2022
Loop antenna	Schwarzbeck	1519B	00008	Dec.14, 2021	Dec.13, 2024
Preamplifier	TDK	PA-02-001-3000	TRS-302-00050	Oct.31, 2021	Oct.30, 2022
High Pass Filter	Wi	WHKX10-2700-3000-18000-40SS	23	Oct.31, 2021	Oct.30, 2022
Band Reject Filter	Wainwright	WRCJV8-2350-2400-2483.5-2533.5-40SS	4	Oct.31, 2021	Oct.30, 2022
Software					
Description		Manufacturer	Name	Version	
Test Software for Radiated Emissions		Farad	EZ-EMC	Ver. UL-3A1	

Other Instruments					
Equipment	Manufacturer	Model No.	Serial No.	Last Cal.	Next Cal.
Dual Channel Power Meter	Keysight	N1912A	MY55416024	Oct.30, 2021	Oct.29, 2022
Power Sensor	Keysight	USB Wideband Power Sensor	MY5100022	Oct.30, 2021	Oct.29, 2022
Attenuator	Agilent	8495B	2814a12853	Oct.31, 2021	Oct.30, 2022

7. ANTENNA PORT TEST RESULTS

7.1. CONDUCTED OUTPUT POWER

LIMITS

CFR 47 FCC Part15 (15.247) Subpart C			
Section	Test Item	Limit	Frequency Range (MHz)
CFR 47 FCC 15.247(b)(3)	Peak Conduct Output Power	1 watt or 30 dBm	2400-2483.5

TEST PROCEDURE

Connect the EUT to a low loss RF cable from the antenna port to the power sensor (video bandwidth is greater than the occupied bandwidth).

Measure peak emission level, the indicated level is the peak output power, after any corrections for external attenuators and cables.

TEST SETUP

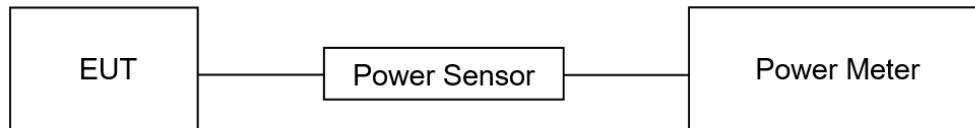

TEST ENVIRONMENT

Temperature	25 °C	Relative Humidity	67 %
Atmosphere Pressure	101 kPa	Test Voltage	DC 3.0 V

TEST RESULTS

Please refer to section "Test Data" - Appendix C

7.2. 6DB BANDWIDTH AND 99% OCCUPIED BANDWIDTH

LIMITS

CFR 47 FCC Part15 (15.247) Subpart C			
Section	Test Item	Limit	Frequency Range (MHz)
CFR 47 FCC 15.247(a)(2)	6 dB Bandwidth	≥ 500 kHz	2400-2483.5

TEST PROCEDURE

Refer to ANSI C63.10-2013 clause 11.8 for DTS bandwidth and clause 6.9 for Occupied Bandwidth.

Connect the EUT to the spectrum analyzer and use the following settings:

Center Frequency	The center frequency of the channel under test
Frequency Span	For 6 dB Bandwidth: Enough to capture all products of the modulation carrier emission For 99 % Occupied Bandwidth: Between 1.5 times and 5.0 times the OBW
Detector	Peak
RBW	For 6 dB Bandwidth: 100 kHz For 99 % Occupied Bandwidth: 1 % to 5 % of the occupied bandwidth
VBW	For 6 dB Bandwidth: ≥3 × RBW For 99 % Occupied Bandwidth: ≥3 × RBW
Trace	Max hold
Sweep	Auto couple

a) Use the 99 % power bandwidth function of the instrument, allow the trace to stabilize and report the measured bandwidth.

b) Allow the trace to stabilize and measure the maximum width of the emission that is constrained by the frequencies associated with the two outermost amplitude points (upper and lower frequencies) that are attenuated by 6 dB relative to the maximum level measured in the fundamental emission.

TEST SETUP

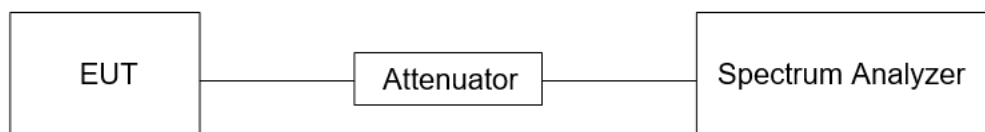



TEST ENVIRONMENT

Temperature	25 °C	Relative Humidity	67 %
Atmosphere Pressure	101 kPa	Test Voltage	DC 3.0 V

TEST RESULTS

Please refer to section "Test Data" - Appendix A&B

7.3. POWER SPECTRAL DENSITY

LIMITS

CFR 47 FCC Part15 (15.247) Subpart C			
Section	Test Item	Limit	Frequency Range (MHz)
CFR 47 FCC §15.247 (e)	Power Spectral Density	8 dBm in any 3 kHz band	2400-2483.5

TEST PROCEDURE

Refer to ANSI C63.10-2013 clause 11.10.

Connect the EUT to the spectrum analyzer and use the following settings:

Center Frequency	The center frequency of the channel under test
Detector	PEAK
RBW	$3 \text{ kHz} \leq \text{RBW} \leq 100 \text{ kHz}$
VBW	$\geq 3 \times \text{RBW}$
Span	1.5 x DTS bandwidth
Trace	Max hold
Sweep time	Auto couple

Allow trace to fully stabilize and use the peak marker function to determine the maximum amplitude level within the RBW.

If measured value exceeds limit, reduce RBW (no less than 3 kHz) and repeat.

TEST SETUP

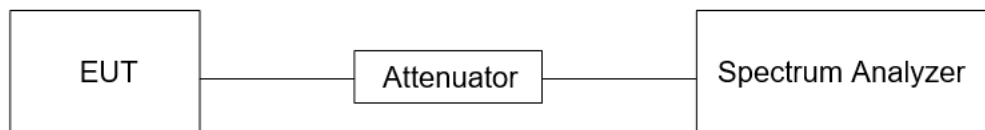

TEST ENVIRONMENT

Temperature	25 °C	Relative Humidity	67 %
Atmosphere Pressure	101 kPa	Test Voltage	DC 3.0 V

TEST RESULTS

Please refer to section "Test Data" - Appendix D

7.4. CONDUCTED BAND EDGE AND SPURIOUS EMISSION

LIMITS

CFR 47 FCC Part15 (15.247) Subpart C		
Section	Test Item	Limit
CFR 47 FCC §15.247 (d)	Conducted Bandedge and Spurious Emissions	at least 20 dB below that in the 100 kHz bandwidth within the band that contains the highest level of the desired power

TEST PROCEDURE

Refer to ANSI C63.10-2013 clause 11.11 and 11.13.

Connect the EUT to the spectrum analyzer and use the following settings for reference level measurement:

Center Frequency	The center frequency of the channel under test
Detector	Peak
RBW	100 kHz
VBW	$\geq 3 \times \text{RBW}$
Span	1.5 x DTS bandwidth
Trace	Max hold
Sweep time	Auto couple.

Allow trace to fully stabilize and use the peak marker function to determine the maximum PSD level.

Change the settings for emission level measurement:

Span	Set the center frequency and span to encompass frequency range to be measured
Detector	Peak
RBW	100 kHz
VBW	$\geq 3 \times \text{RBW}$
measurement points	$\geq \text{span}/\text{RBW}$
Trace	Max hold
Sweep time	Auto couple.

Allow trace to fully stabilize and use the peak marker function to determine the maximum PSD level. Ensure that the amplitude of all unwanted emissions outside of the authorized frequency band (excluding restricted frequency bands) is attenuated by at least the minimum requirements specified in 11.11.



TEST SETUP

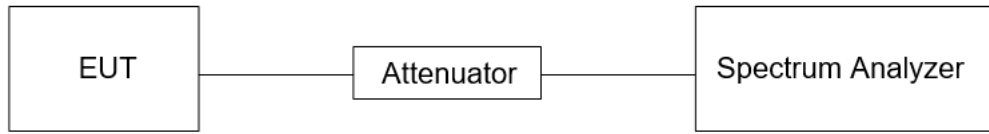

TEST ENVIRONMENT

Temperature	25 °C	Relative Humidity	67 %
Atmosphere Pressure	101 kPa	Test Voltage	DC 3.0 V

TEST RESULTS

Please refer to section "Test Data" - Appendix E&F

7.5. DUTY CYCLE

LIMITS

None; for reporting purposes only.

TEST PROCEDURE

Refer to ANSI C63.10-2013 clause 11.6 Zero – Span Spectrum Analyzer method.

TEST SETUP

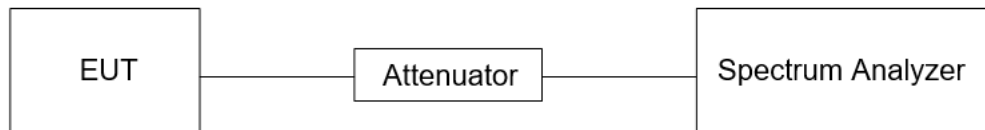

TEST ENVIRONMENT

Temperature	25 °C	Relative Humidity	67 %
Atmosphere Pressure	101 kPa	Test Voltage	DC 3.0 V

TEST RESULTS

Please refer to section "Test Data" - Appendix G

8. RADIATED TEST RESULTS

LIMITS

Please refer to CFR 47 FCC §15.205 and §15.209.

Radiation Disturbance Test Limit for FCC (Class B) (9 kHz ~ 1 GHz)

Emissions radiated outside of the specified frequency bands above 30 MHz			
Frequency Range (MHz)	Field Strength Limit (uV/m) at 3 m	Field Strength Limit (dBuV/m) at 3 m	
		Quasi-Peak	
30 - 88	100	40	
88 - 216	150	43.5	
216 - 960	200	46	
Above 960	500	54	
Above 1000	500	Peak	Average
		74	54

FCC Emissions radiated outside of the specified frequency bands below 30 MHz		
Frequency (MHz)	Field strength (microvolts/meter)	Measurement distance (meters)
0.009-0.490	2400/F(kHz)	300
0.490-1.705	24000/F(kHz)	30
1.705-30.0	30	30

FCC Restricted bands of operation refer to FCC §15.205 (a):

MHz	MHz	MHz	GHz
0.090-0.110	16.42-16.423	399.9-410	4.5-5.15
¹ 0.495-0.505	16.69475-16.69525	608-614	5.35-5.46
2.1735-2.1905	16.80425-16.80475	960-1240	7.25-7.75
4.125-4.128	25.5-25.67	1300-1427	8.025-8.5
4.17725-4.17775	37.5-38.25	1435-1626.5	9.0-9.2
4.20725-4.20775	73-74.6	1645.5-1646.5	9.3-9.5
6.215-6.218	74.8-75.2	1660-1710	10.6-12.7
6.26775-6.26825	108-121.94	1718.8-1722.2	13.25-13.4
6.31175-6.31225	123-138	2200-2300	14.47-14.5
8.291-8.294	149.9-150.05	2310-2390	15.35-16.2
8.362-8.366	156.52475-156.52525	2483.5-2500	17.7-21.4
8.37625-8.38675	156.7-156.9	2690-2900	22.01-23.12
8.41425-8.41475	162.0125-167.17	3260-3267	23.6-24.0
12.29-12.293	167.72-173.2	3332-3339	31.2-31.8
12.51975-12.52025	240-285	3345.8-3358	36.43-36.5
12.57675-12.57725	322-335.4	3600-4400	(²)
13.36-13.41			

Note: ¹Until February 1, 1999, this restricted band shall be 0.490-0.510 MHz.

²Above 38.6c

TEST PROCEDURE

Below 30 MHz

The setting of the spectrum analyzer

RBW	200 Hz (From 9 kHz to 0.15 MHz)/ 9 kHz (From 0.15 MHz to 30 MHz)
VBW	200 Hz (From 9 kHz to 0.15 MHz)/ 9 kHz (From 0.15 MHz to 30 MHz)
Sweep	Auto

1. The testing follows the guidelines in ANSI C63.10-2013 clause 6.4.
2. The EUT was arranged to its worst case and then turntable (from 0 degree to 360 degrees) to find the maximum reading. A pre-amp and a high pass filter are used for the test in order to get better signal level. Both Horizontal, Face-on and Face-off polarizations of the antenna are set to make the measurement.
3. The EUT was placed on a turntable with 80 cm above ground.
4. The EUT was set 3 meters from the interference receiving antenna, which was mounted on the top of a 1 m height antenna tower.
5. The radiated emission limits are based on measurements employing a CISPR quasi-peak detector except for the frequency bands 9-90 kHz, 110-490 kHz and above 1000 MHz Radiated emission limits in these three bands are based on measurements employing an average detector.
6. For measurement below 1 GHz, the initial step in collecting conducted emission data is a spectrum analyzer peak detector mode pre-scanning the measurement frequency range. Significant peaks are then marked and then Quasi Peak and average detector mode re-measured. If the emission level of the EUT measured by the peak detector is 3 dB lower than the applicable limit, the peak emission level will be reported. Otherwise, the emission measurement will be repeated using the quasi-peak and average detector and reported.
7. Although these tests were performed other than open field site, adequate comparison measurements were confirmed against 30m open field site. Therefore sufficient tests were made to demonstrate that the alternative site produces results that correlate with the ones of tests made in an open field site based on KDB 414788.
8. The limits in CFR 47, Part 15, Subpart C, paragraph 15.209 (a), are identical to those in RSS-GEN Section 8.9, Table 6, since the measurements are performed in terms of magnetic field strength and converted to electric field strength levels (as reported in the table) using the free space impedance of 377Ω . For example, the measurement frequency X KHz resulted in a level of Y dBuV/m, which is equivalent to $Y-51.5 = Z$ dBuA/m, which has the same margin, W dB, to the corresponding RSS-GEN Table 6 limit as it has to be 15.209(a) limit.



Below 1 GHz and above 30 MHz

The setting of the spectrum analyzer

RBW	120 kHz
VBW	300 kHz
Sweep	Auto
Detector	Peak/QP
Trace	Max hold

1. The testing follows the guidelines in ANSI C63.10-2013 clause 6.5.
2. The EUT was arranged to its worst case and then tune the antenna tower (from 1 m to 4 m) and turntable (from 0 degree to 360 degrees) to find the maximum reading. A pre-amp and a high pass filter are used for the test in order to get better signal level. Both horizontal and vertical polarizations of the antenna are set to make the measurement.
3. The EUT was placed on a turntable with 80 cm above ground.
4. The EUT was set 3 meters from the interference receiving antenna, which was mounted on the top of a variable height antenna tower.
5. For measurement below 1 GHz, the initial step in collecting conducted emission data is a spectrum analyzer peak detector mode pre-scanning the measurement frequency range. Significant peaks are then marked and then Quasi Peak detector mode re-measured. If the emission level of the EUT measured by the peak detector is 3 dB lower than the applicable limit, the peak emission level will be reported. Otherwise, the emission measurement will be repeated using the quasi-peak detector and reported.



Above 1 GHz

The setting of the spectrum analyzer

RBW	1 MHz
VBW	PEAK: 3 MHz AVG: see note 6
Sweep	Auto
Detector	Peak
Trace	Max hold

1. The testing follows the guidelines in ANSI C63.10-2013 clause 6.6.
2. The EUT was arranged to its worst case and then tune the antenna tower (from 1 m to 4 m) and turntable (from 0 degree to 360 degrees) to find the maximum reading. A pre-amp and a high pass filter are used for the test in order to get better signal level. Both horizontal and vertical polarizations of the antenna are set to make the measurement.
3. The EUT was placed on a turntable with 1.5 m above ground.
4. The EUT was set 3 meters from the interference receiving antenna, which was mounted on the top of a variable height antenna tower.
5. For measurement above 1 GHz, the emission measurement will be measured by the peak detector. This peak level, once corrected, must comply with the limit specified in Section 15.209.
6. For measurements above 1 GHz the resolution bandwidth is set to 1 MHz, then the video bandwidth is set to 3 MHz for peak measurements and 1 MHz resolution bandwidth with 1/T video bandwidth with peak detector for average measurements. For the Duty Cycle please refer to clause 7.5.ON TIME AND DUTY CYCLE.

X axis, Y axis, Z axis positions:

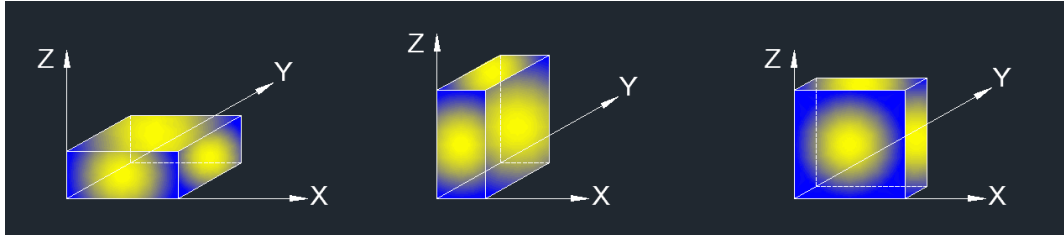

Note 1: For all radiated test, EUT in each of three orthogonal axis emissions had been tested, but only the worst case (Z axis) data recorded in the report.

For Restricted Bandedge:

Note:

1. Measurement = Reading Level + Correct Factor.
2. If Peak Result complies with AV limit, AV Result is deemed to comply with AV limit.
3. Peak: Peak detector.
4. AVG: $VBW=1/Ton$, where: Ton is the transmitting duration.
5. For the transmitting duration, please refer to clause 7.5.
6. Only the worst data was recorded, if it complies with the limit, the other emissions deemed to comply with the limit.
7. Both horizontal and vertical have been tested, only the worst data was recorded in the report.
8. All modes, channels and antennas have been tested, only the worst data was recorded in the report.

For Radiate Spurious emission (9 kHz ~ 30 MHz):

Note:

1. Measurement = Reading Level + Correct Factor.
2. If Peak Result complies with AV and QP limit, AV and QP Result are deemed to comply with AV limit.
3. All 3 polarizations (Horizontal, Face-on and Face-off) of the loop antenna had been tested, but only the worst data recorded in the report.
4. All modes, channels and antennas have been tested, only the worst data was recorded in the report.

For Radiate Spurious Emission (30 MHz ~ 1 GHz):

Note:

1. Result Level = Read Level + Correct Factor.
2. If Peak Result complies with QP limit, QP Result is deemed to comply with QP limit.
3. All modes, channels and antennas have been tested, only the worst data was recorded in the report.

For Radiate Spurious Emission (1 GHz ~ 3 GHz):

1. Measurement = Reading Level + Correct Factor.
2. If Peak Result complies with AV limit, AV Result is deemed to comply with AV limit.
3. Peak: Peak detector.
4. AVG: $VBW=1/Ton$, where: Ton is the transmitting duration.
5. For the transmitting duration, please refer to clause 7.5.
6. Filter losses were only considered in the spurious frequency bands and the authorized band was not corrected for Band reject filter losses.
7. Proper operation of the transmitter prior to adding the filter to the measurement chain.
8. All modes, channels and antennas have been tested, only the worst data was recorded in the report.



For Radiate Spurious Emission (3 GHz ~ 18 GHz):

Note:

1. Peak Result = Reading Level + Correct Factor.
2. If Peak Result complies with AV limit, AV Result is deemed to comply with AV limit.
3. Peak: Peak detector.
4. AVG: $VBW=1/Ton$, where: Ton is the transmitting duration.
5. For the transmitting duration, please refer to clause 7.5.
6. Filter losses were only considered in the spurious frequency bands and the authorized band was not corrected for High Pass Filter losses.
7. Proper operation of the transmitter prior to adding the filter to the measurement chain.
8. All modes, channels and antennas have been tested, only the worst data was recorded in the report.

For Radiate Spurious emission (18 GHz ~ 26 GHz):

Note:

1. Measurement = Reading Level + Correct Factor.
2. If Peak Result complies with AV limit, AV Result is deemed to comply with AV limit.
3. Peak: Peak detector.
4. All modes, channels and antennas have been tested, only the worst data was recorded in the report.

TEST SETUP

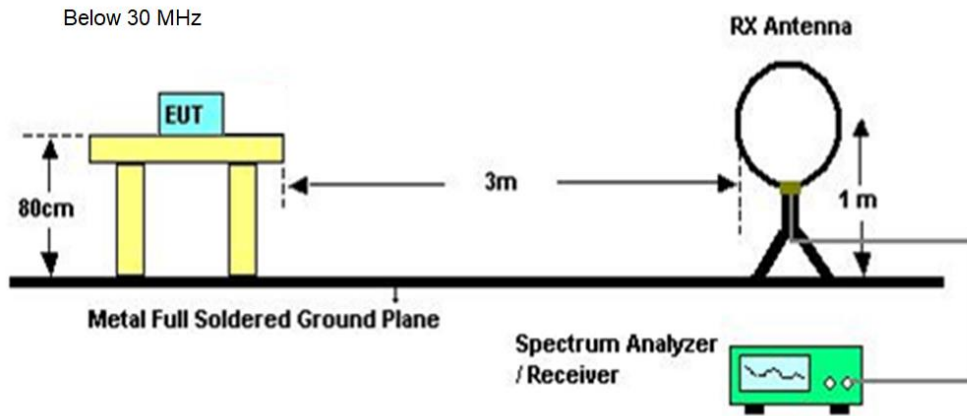

Below 1 GHz and above 30 MHz

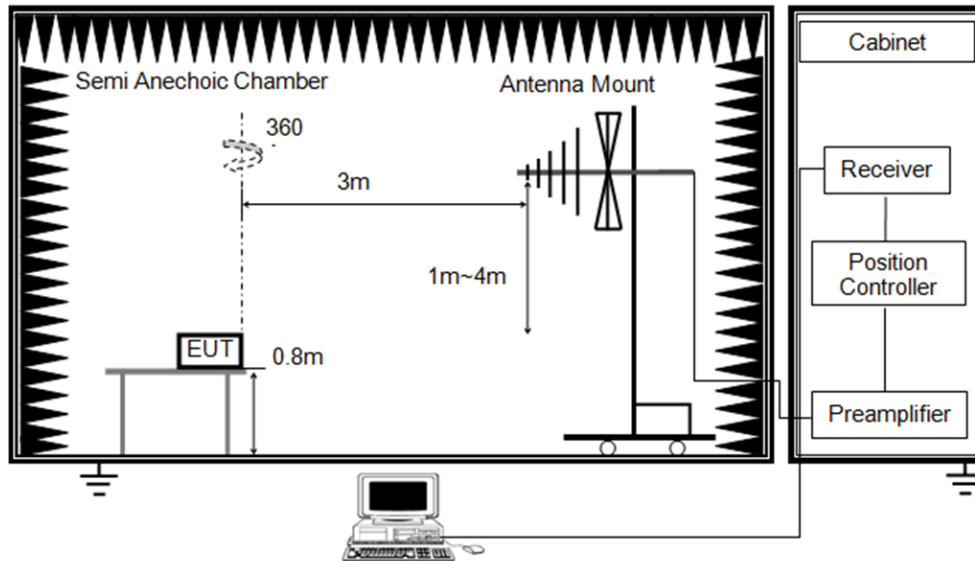

Above 1 GHz

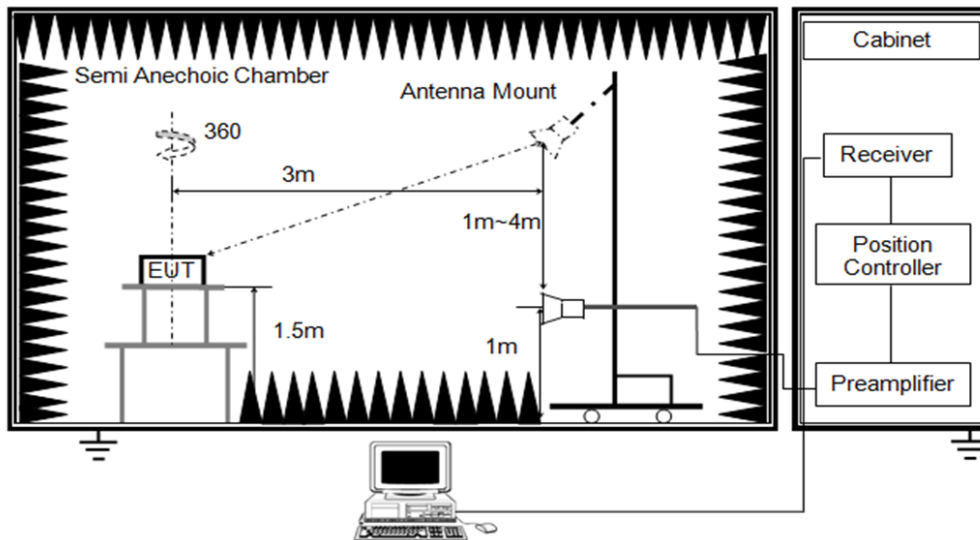



TEST ENVIRONMENT

Temperature	25.3 °C	Relative Humidity	59%
Atmosphere Pressure	101 kPa	Test Voltage	DC 3.0 V

TEST RESULTS



8.1. RESTRICTED BANDEDGE

Test Mode:	LE 1M Peak	Channel:	2402 MHz
Polarity:	Horizontal	Test Voltage:	DC 3.0 V

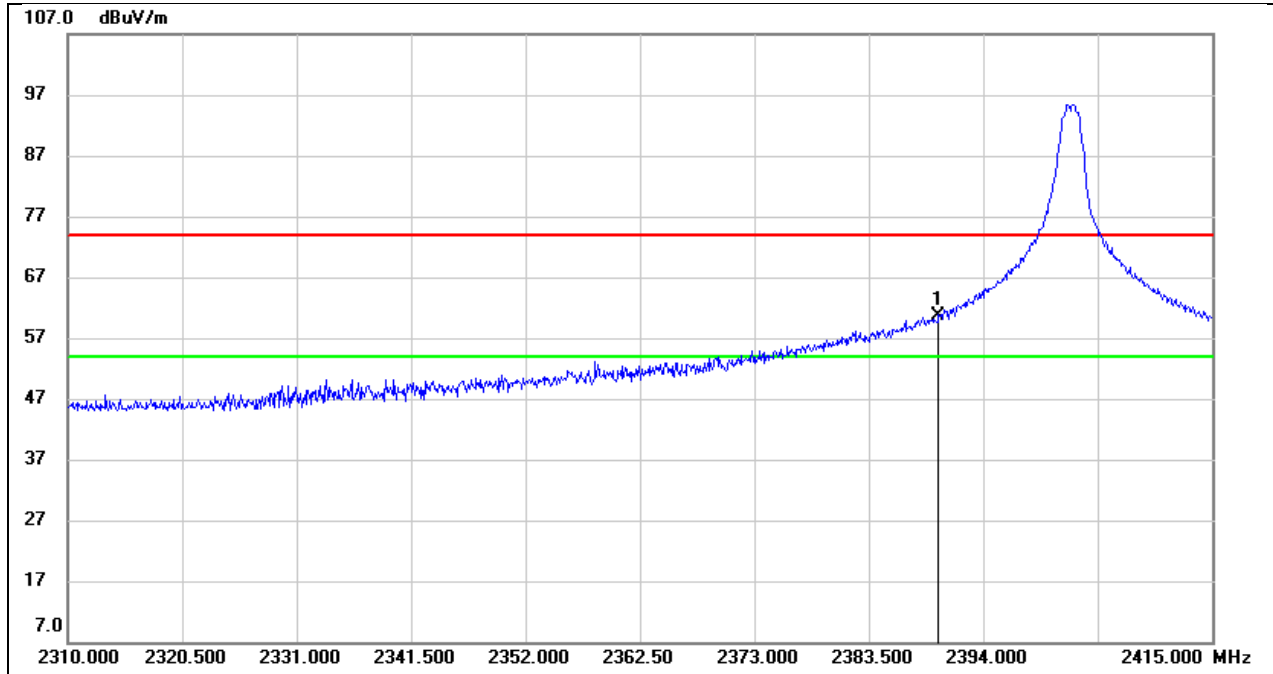

No.	Frequency (MHz)	Reading (dBuV)	Correct (dB/m)	Result (dBuV/m)	Limit (dBuV/m)	Margin (dB)	Remark
1	2390.000	28.48	32.16	60.64	74.00	-13.36	peak



Test Mode:	LE 1M Average	Channel:	2402 MHz
Polarity:	Horizontal	Test Voltage:	DC 3.0 V

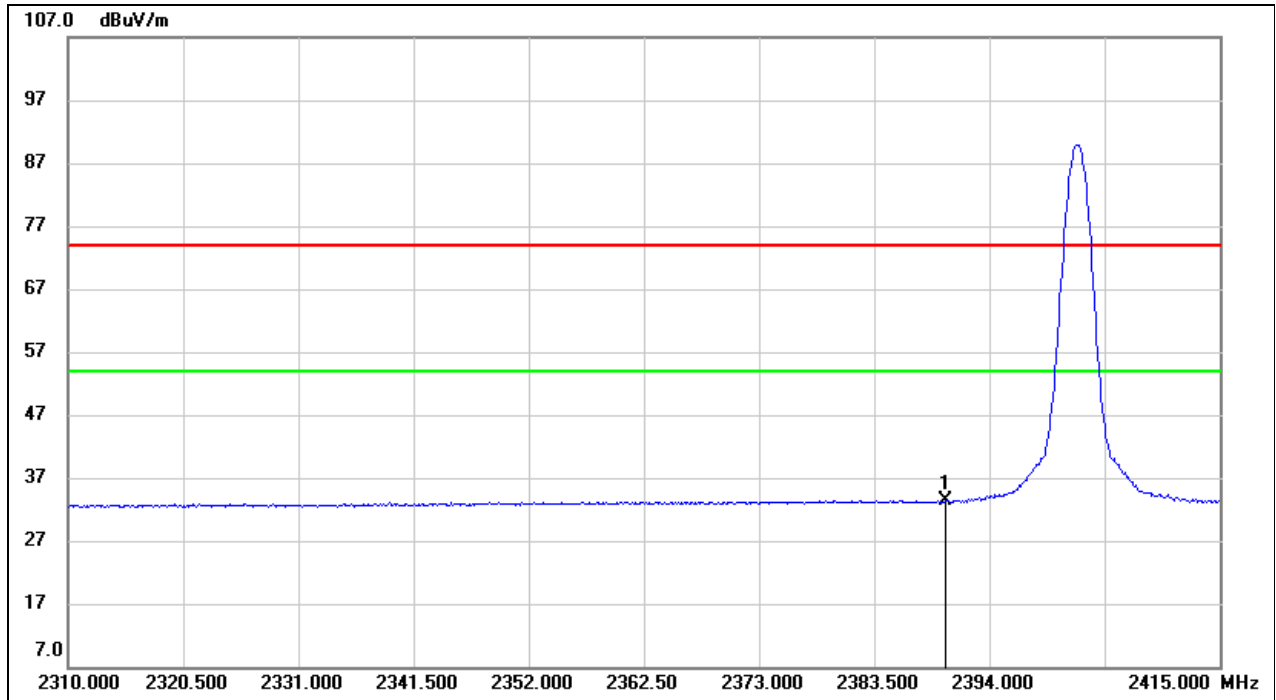

No.	Frequency (MHz)	Reading (dBuV)	Correct (dB/m)	Result (dBuV/m)	Limit (dBuV/m)	Margin (dB)	Remark
1	2390.000	1.11	32.16	33.27	54.00	-20.73	AVG



Test Mode:	LE 1M Peak	Channel:	2480 MHz
Polarity:	Horizontal	Test Voltage:	DC 3.0 V

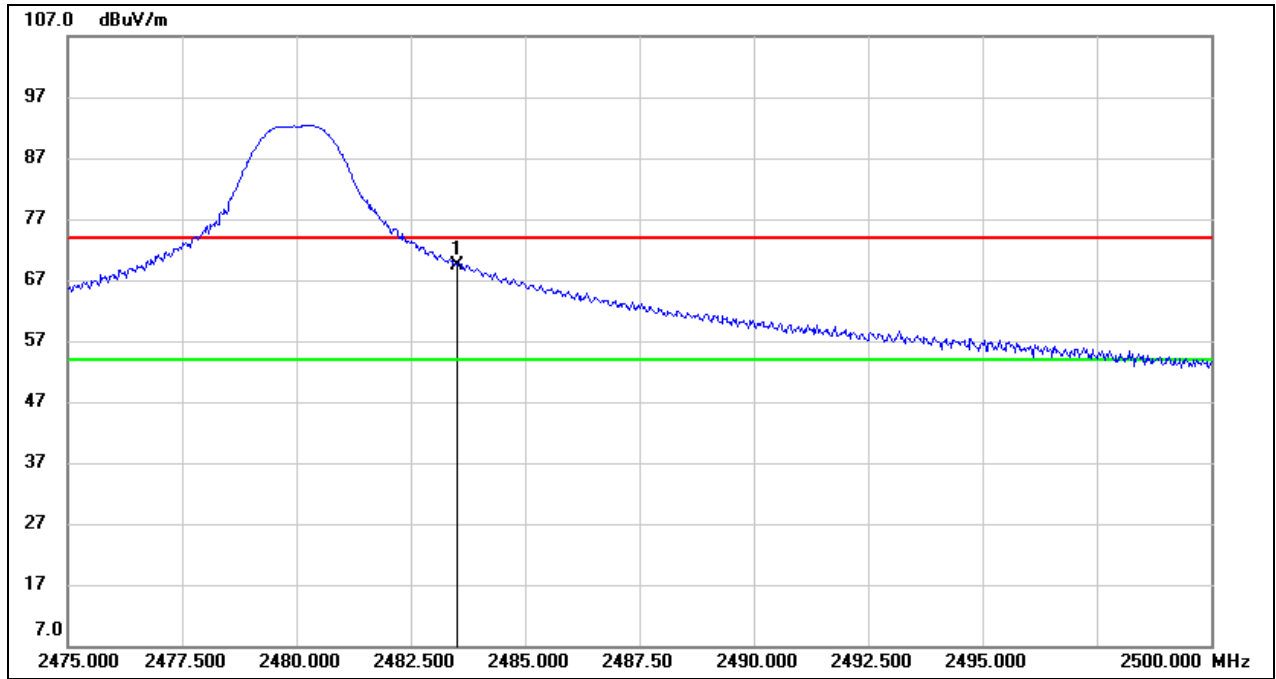

No.	Frequency (MHz)	Reading (dBuV)	Correct (dB/m)	Result (dBuV/m)	Limit (dBuV/m)	Margin (dB)	Remark
1	2483.500	36.99	32.44	69.43	74.00	-4.57	peak



Test Mode:	LE 1M Average	Channel:	2480 MHz
Polarity:	Horizontal	Test Voltage:	DC 3.0 V

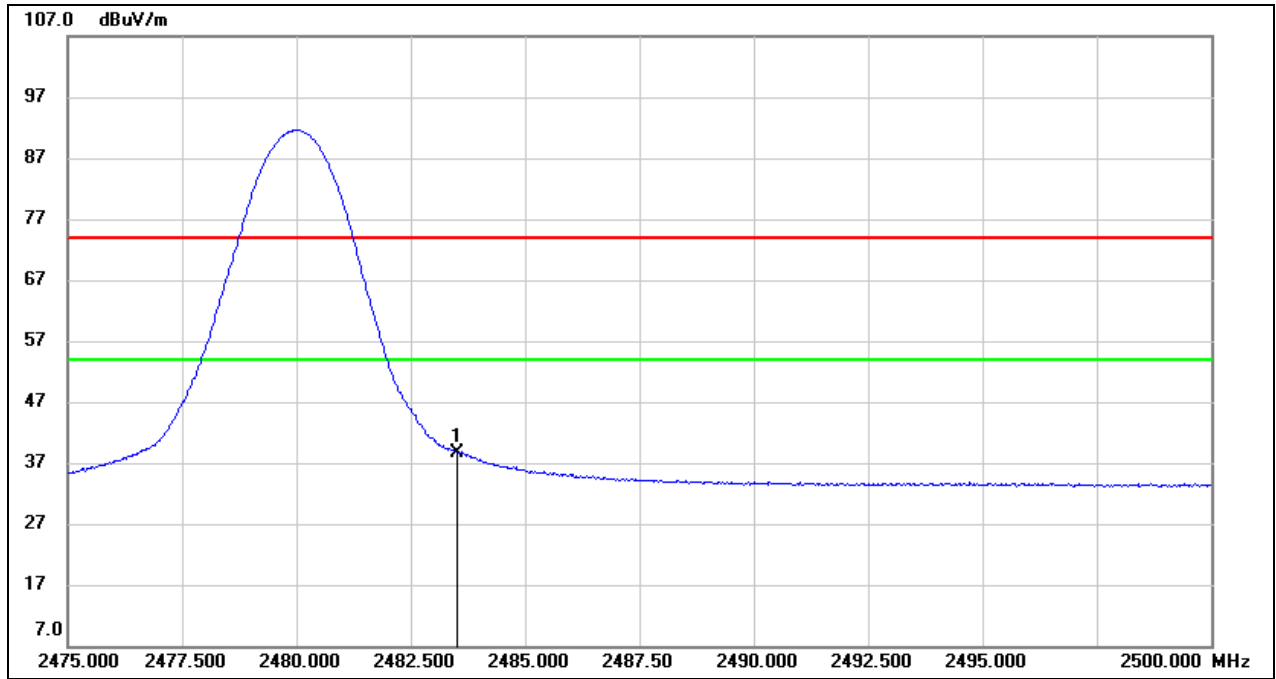

No.	Frequency (MHz)	Reading (dBuV)	Correct (dB/m)	Result (dBuV/m)	Limit (dBuV/m)	Margin (dB)	Remark
1	2483.500	6.29	32.44	38.73	54.00	-15.27	AVG



Test Mode:	LE 2M Peak	Channel:	2402 MHz
Polarity:	Horizontal	Test Voltage:	DC 3.0 V

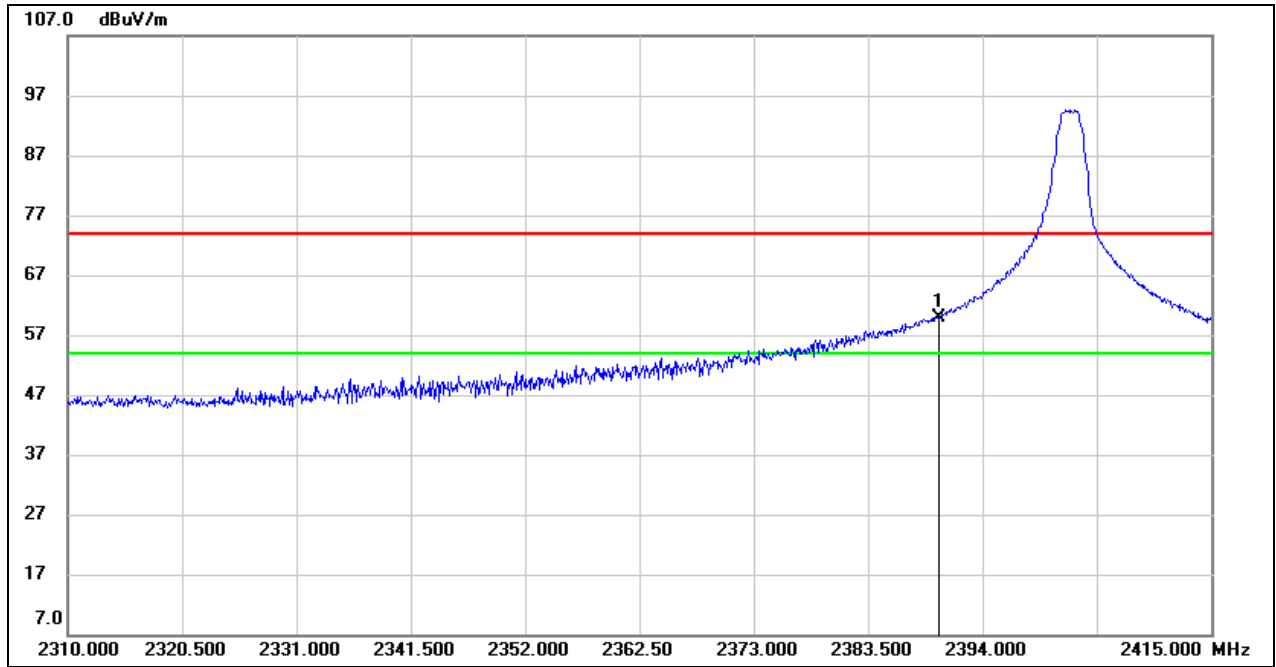

No.	Frequency (MHz)	Reading (dBuV)	Correct (dB/m)	Result (dBuV/m)	Limit (dBuV/m)	Margin (dB)	Remark
1	2390.000	27.81	32.16	59.97	74.00	-14.03	peak



Test Mode:	LE 2M Average	Channel:	2402 MHz
Polarity:	Horizontal	Test Voltage:	DC 3.0 V

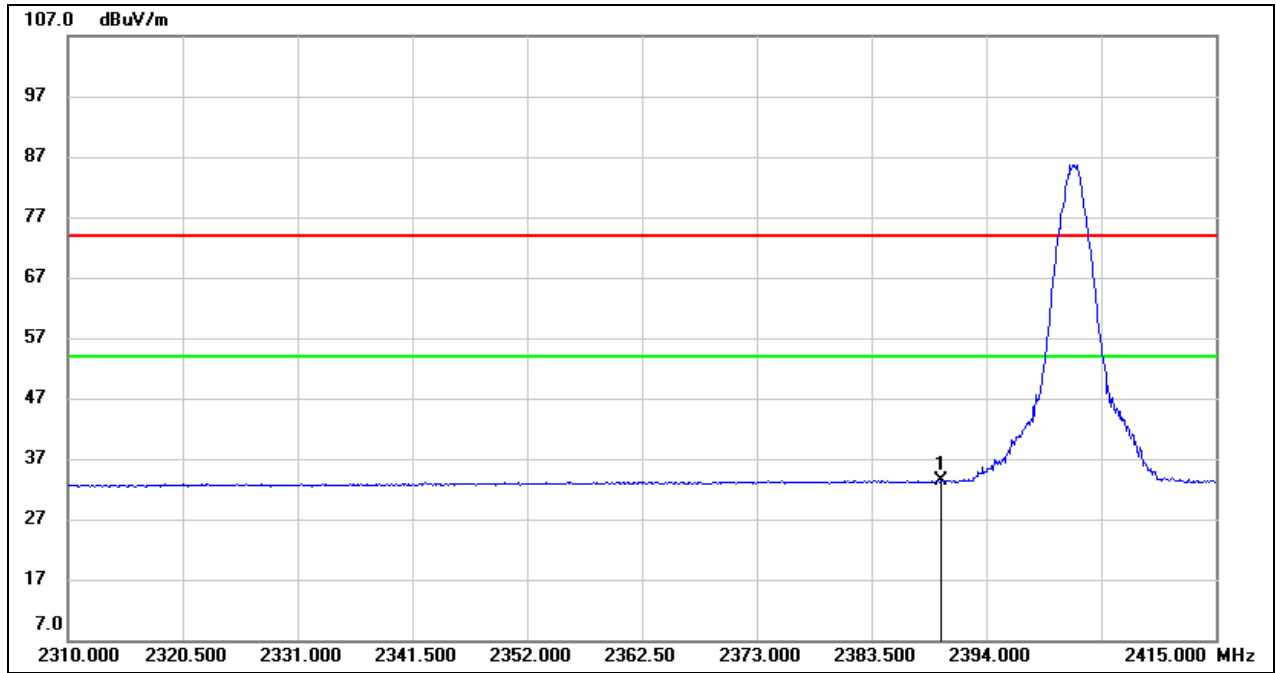

No.	Frequency (MHz)	Reading (dBuV)	Correct (dB/m)	Result (dBuV/m)	Limit (dBuV/m)	Margin (dB)	Remark
1	2390.000	1.13	32.16	33.29	54.00	-20.71	AVG



Test Mode:	LE 2M Peak	Channel:	2480 MHz
Polarity:	Horizontal	Test Voltage:	DC 3.0 V

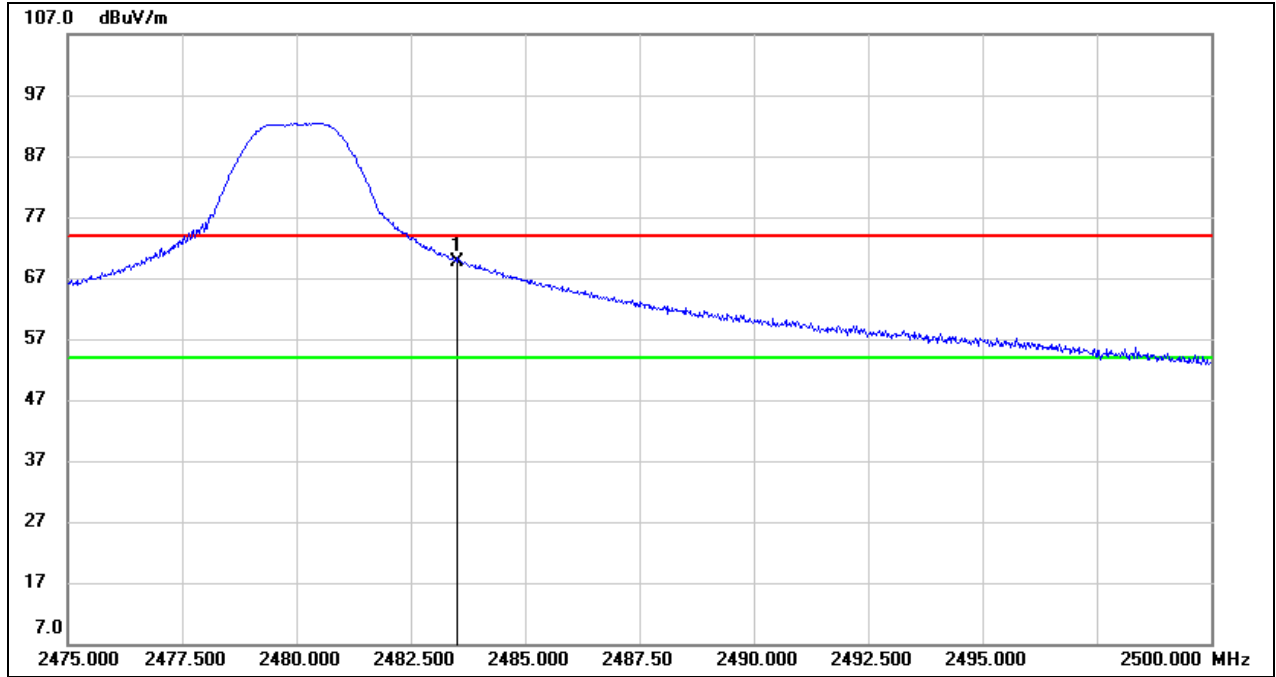

No.	Frequency (MHz)	Reading (dBuV)	Correct (dB/m)	Result (dBuV/m)	Limit (dBuV/m)	Margin (dB)	Remark
1	2483.500	37.27	32.44	69.71	74.00	-4.29	peak



Test Mode:	LE 2M Average	Channel:	2480 MHz
Polarity:	Horizontal	Test Voltage:	DC 3.0 V

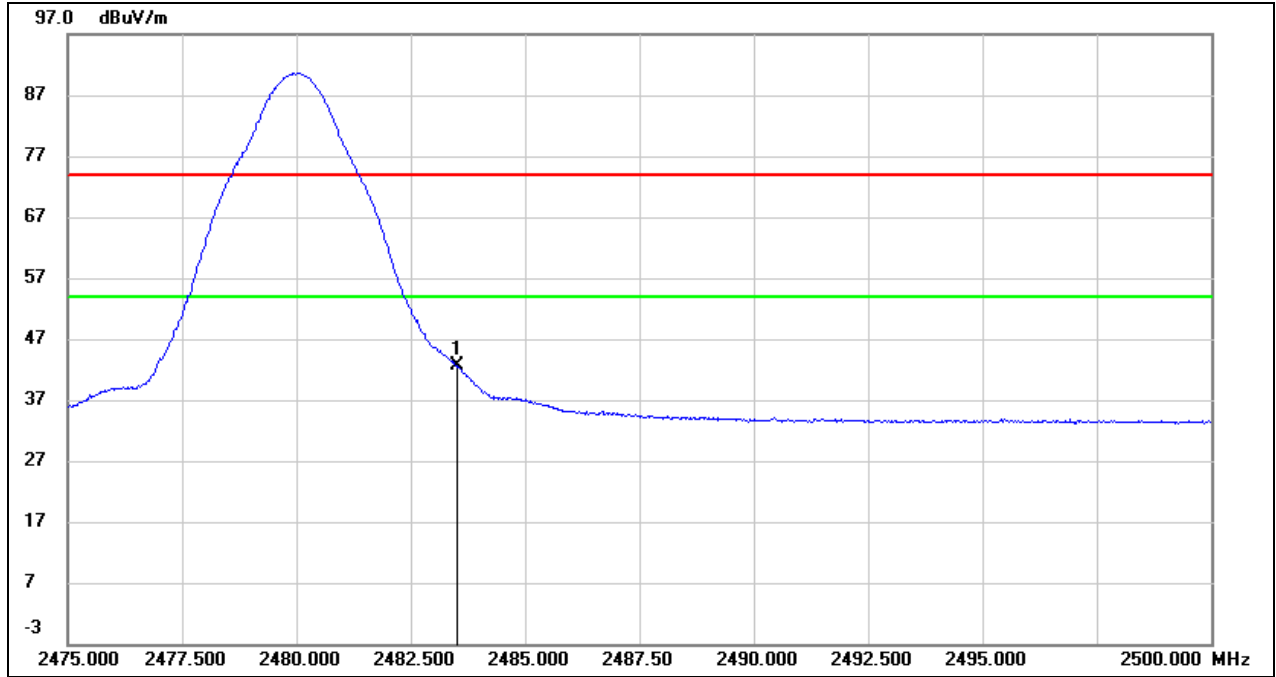

No.	Frequency (MHz)	Reading (dBuV)	Correct (dB/m)	Result (dBuV/m)	Limit (dBuV/m)	Margin (dB)	Remark
1	2483.500	10.17	32.44	42.61	54.00	-11.39	AVG

**8.2. SPURIOUS EMISSIONS (1 GHZ ~ 3 GHZ)**

Test Mode:	LE 1M	Channel:	2402 MHz
Polarity:	Horizontal	Test Voltage:	DC 3.0 V

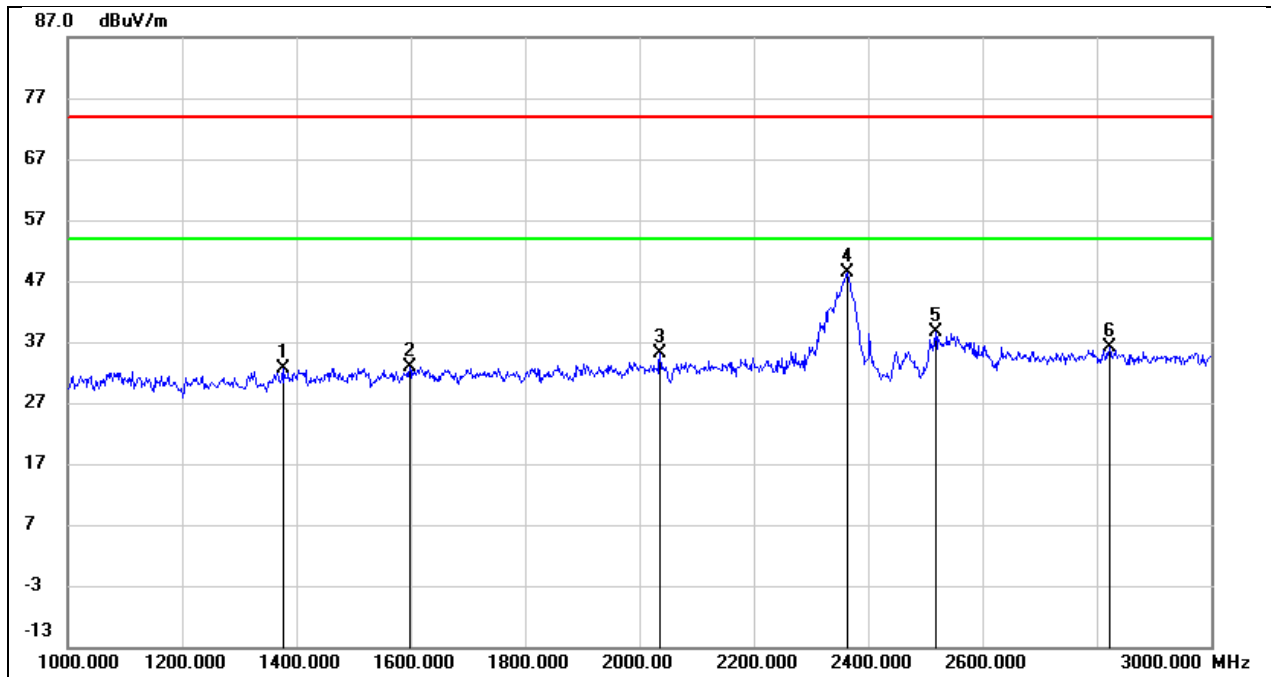

No.	Frequency (MHz)	Reading (dBuV)	Correct (dB/m)	Result (dBuV/m)	Limit (dBuV/m)	Margin (dB)	Remark
1	1376.000	45.83	-13.28	32.55	74.00	-41.45	peak
2	1598.000	45.20	-12.38	32.82	74.00	-41.18	peak
3	2036.000	46.03	-10.87	35.16	74.00	-38.84	peak
4	2364.000	57.56	-9.19	48.37	74.00	-25.63	peak
5	2518.000	47.15	-8.44	38.71	74.00	-35.29	peak
6	2822.000	43.59	-7.51	36.08	74.00	-37.92	peak



Test Mode:	LE 1M	Channel:	2402 MHz
Polarity:	Vertical	Test Voltage:	DC 3.0 V

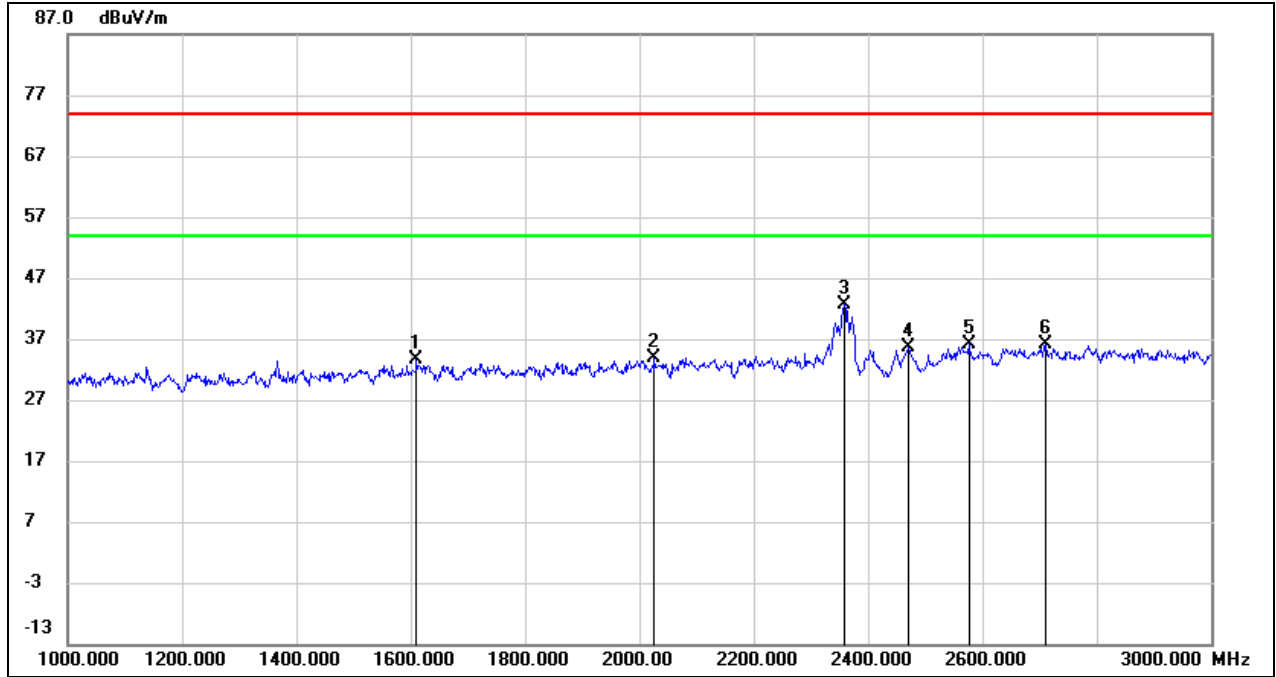

No.	Frequency (MHz)	Reading (dBuV)	Correct (dB/m)	Result (dBuV/m)	Limit (dBuV/m)	Margin (dB)	Remark
1	1610.000	45.90	-12.35	33.55	74.00	-40.45	peak
2	2026.000	44.71	-10.92	33.79	74.00	-40.21	peak
3	2358.000	51.89	-9.22	42.67	74.00	-31.33	peak
4	2470.000	44.40	-8.65	35.75	74.00	-38.25	peak
5	2576.000	44.35	-8.26	36.09	74.00	-37.91	peak
6	2710.000	43.90	-7.85	36.05	74.00	-37.95	peak



Test Mode:	LE 1M	Channel:	2440 MHz
Polarity:	Horizontal	Test Voltage:	DC 3.0 V

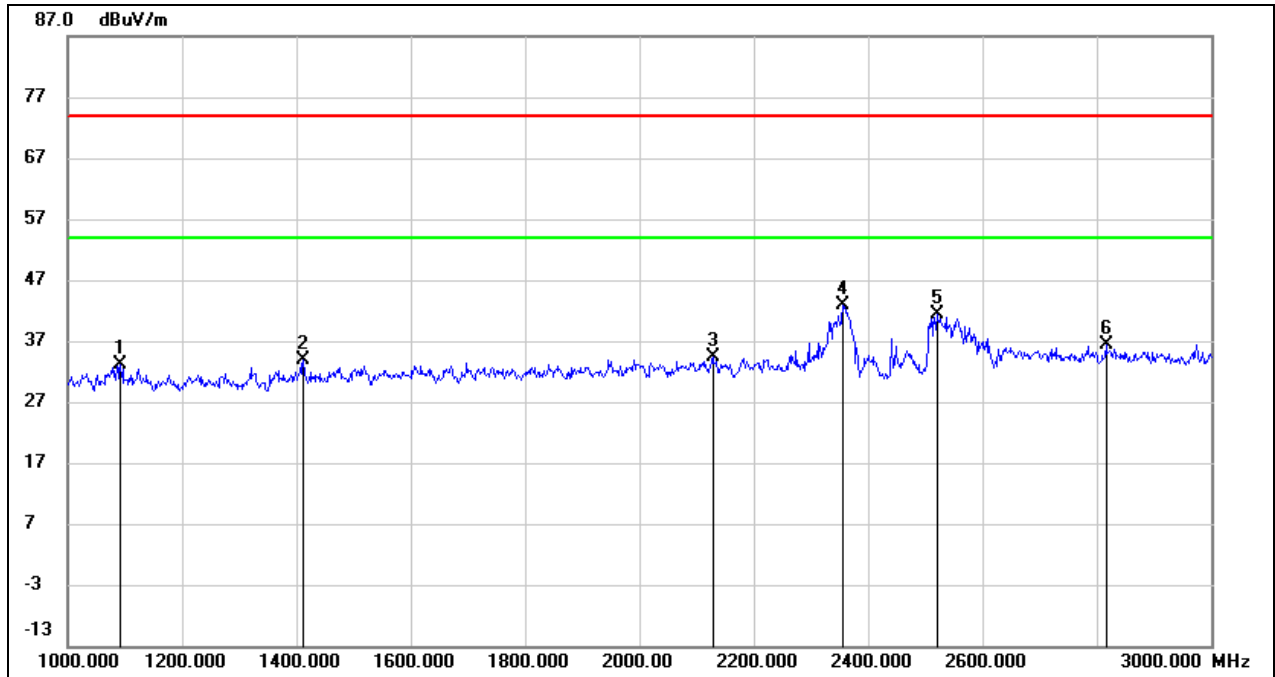

No.	Frequency (MHz)	Reading (dBuV)	Correct (dB/m)	Result (dBuV/m)	Limit (dBuV/m)	Margin (dB)	Remark
1	1092.000	47.83	-14.61	33.22	74.00	-40.78	peak
2	1412.000	47.11	-13.12	33.99	74.00	-40.01	peak
3	2128.000	44.73	-10.40	34.33	74.00	-39.67	peak
4	2356.000	52.01	-9.22	42.79	74.00	-31.21	peak
5	2520.000	49.78	-8.43	41.35	74.00	-32.65	peak
6	2816.000	43.84	-7.54	36.30	74.00	-37.70	peak



Test Mode:	LE 1M	Channel:	2440 MHz
Polarity:	Vertical	Test Voltage:	DC 3.0 V

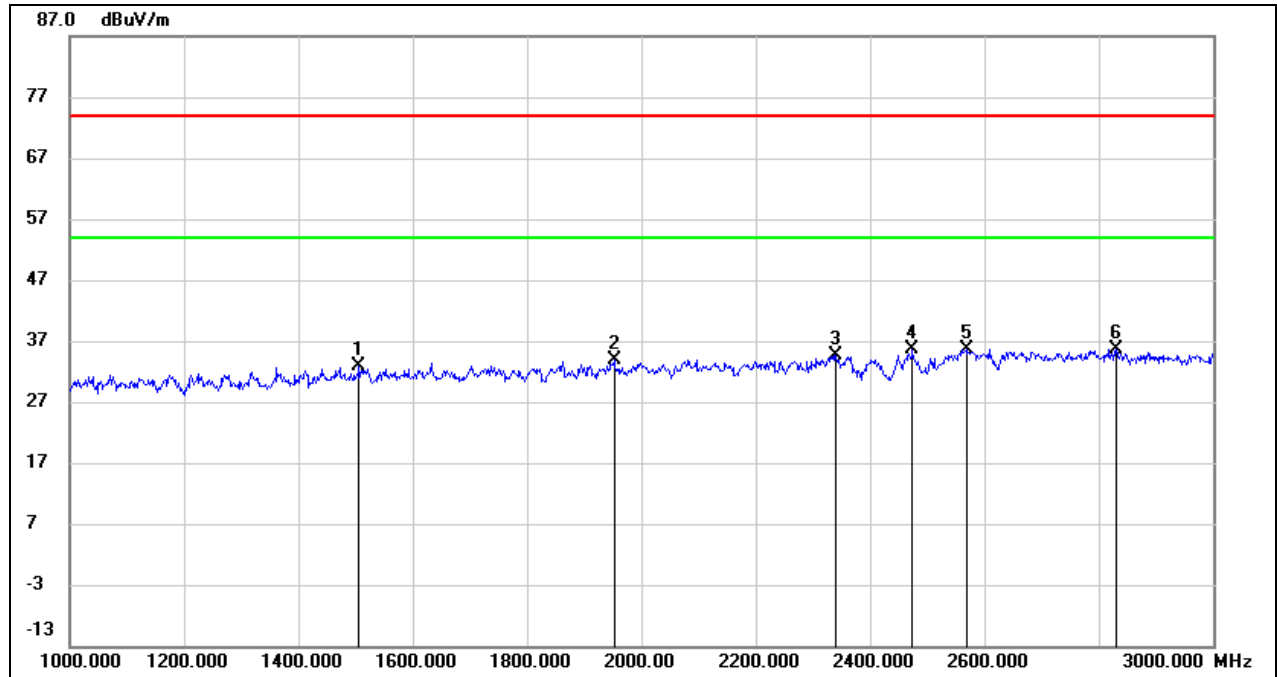

No.	Frequency (MHz)	Reading (dBuV)	Correct (dB/m)	Result (dBuV/m)	Limit (dBuV/m)	Margin (dB)	Remark
1	1506.000	45.59	-12.69	32.90	74.00	-41.10	peak
2	1952.000	45.06	-11.22	33.84	74.00	-40.16	peak
3	2340.000	43.94	-9.31	34.63	74.00	-39.37	peak
4	2474.000	44.24	-8.63	35.61	74.00	-38.39	peak
5	2568.000	44.03	-8.28	35.75	74.00	-38.25	peak
6	2830.000	43.06	-7.50	35.56	74.00	-38.44	peak



Test Mode:	LE 1M	Channel:	2480 MHz
Polarity:	Horizontal	Test Voltage:	DC 3.0 V

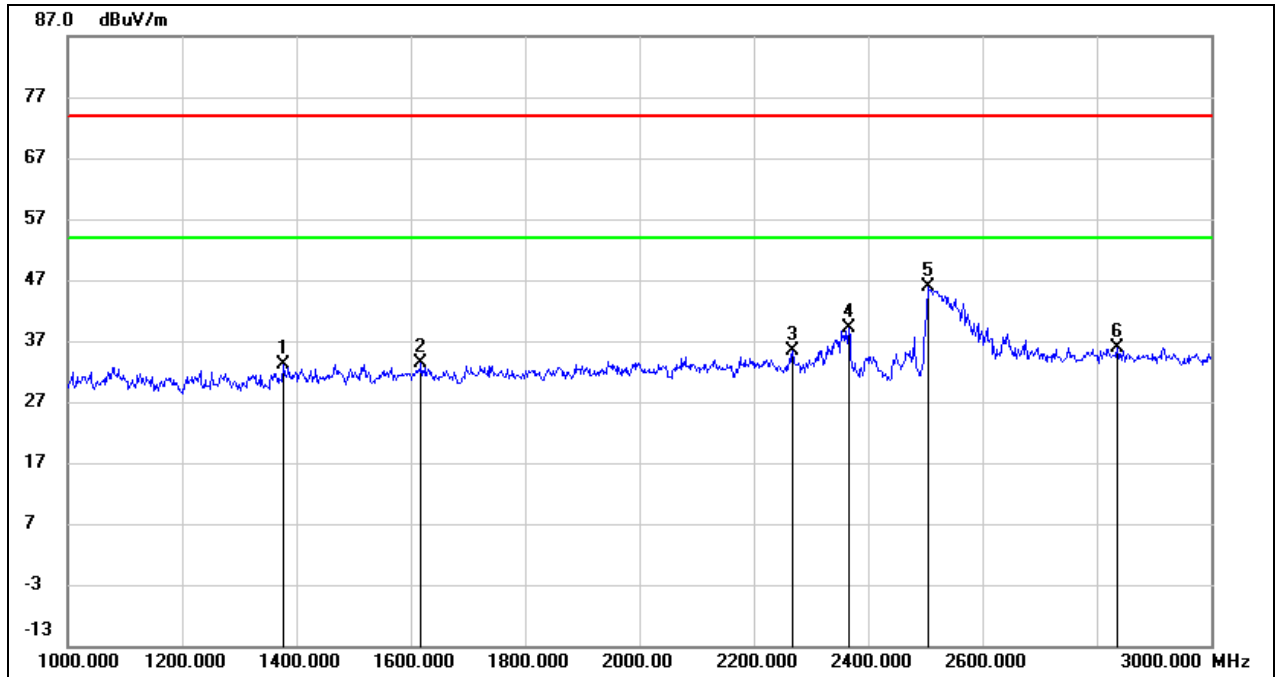

No.	Frequency (MHz)	Reading (dBuV)	Correct (dB/m)	Result (dBuV/m)	Limit (dBuV/m)	Margin (dB)	Remark
1	1378.000	46.45	-13.27	33.18	74.00	-40.82	peak
2	1618.000	45.58	-12.32	33.26	74.00	-40.74	peak
3	2268.000	45.06	-9.68	35.38	74.00	-38.62	peak
4	2366.000	48.23	-9.18	39.05	74.00	-34.95	peak
5	2504.000	54.31	-8.48	45.83	74.00	-28.17	peak
6	2836.000	43.42	-7.48	35.94	74.00	-38.06	peak



Test Mode:	LE 1M	Channel:	2480 MHz
Polarity:	Vertical	Test Voltage:	DC 3.0 V

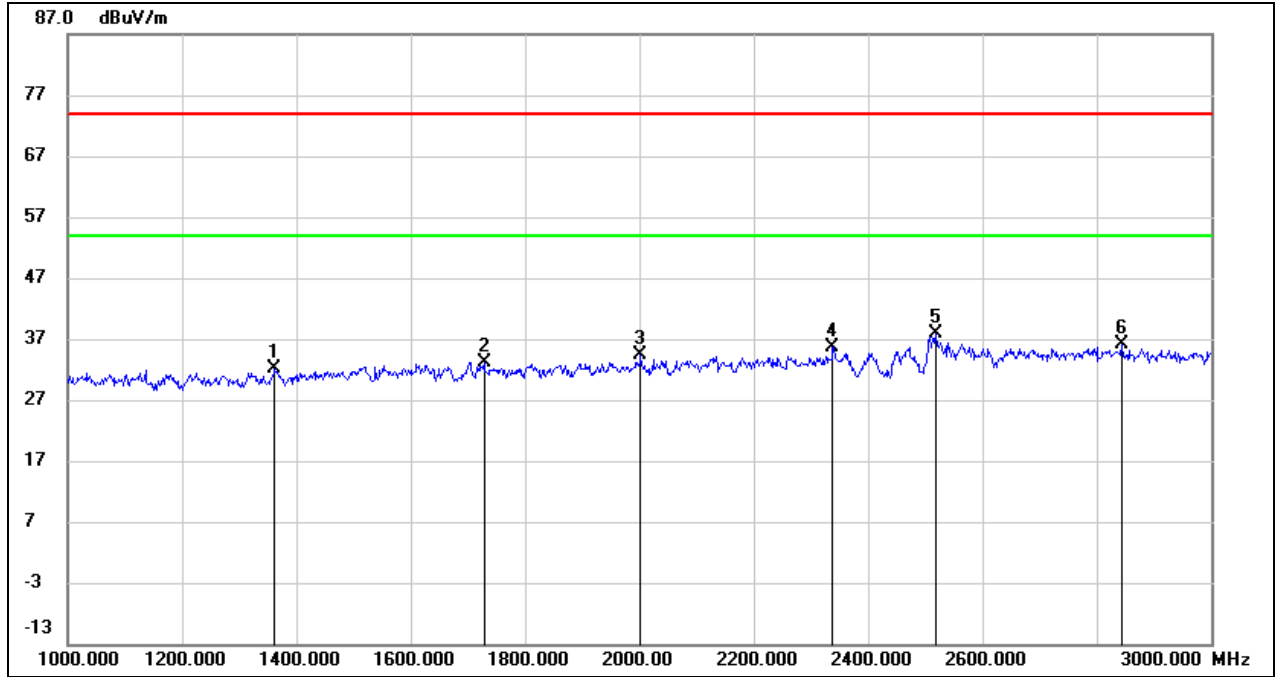

No.	Frequency (MHz)	Reading (dBuV)	Correct (dB/m)	Result (dBuV/m)	Limit (dBuV/m)	Margin (dB)	Remark
1	1362.000	45.60	-13.35	32.25	74.00	-41.75	peak
2	1728.000	45.13	-11.95	33.18	74.00	-40.82	peak
3	2002.000	45.43	-11.05	34.38	74.00	-39.62	peak
4	2338.000	44.95	-9.32	35.63	74.00	-38.37	peak
5	2518.000	46.37	-8.44	37.93	74.00	-36.07	peak
6	2844.000	43.56	-7.45	36.11	74.00	-37.89	peak



8.3. SPURIOUS EMISSIONS (3 GHZ ~ 18 GHZ)

Test Mode:	LE 1M	Channel:	2402 MHz
Polarity:	Horizontal	Test Voltage:	DC 3.0 V

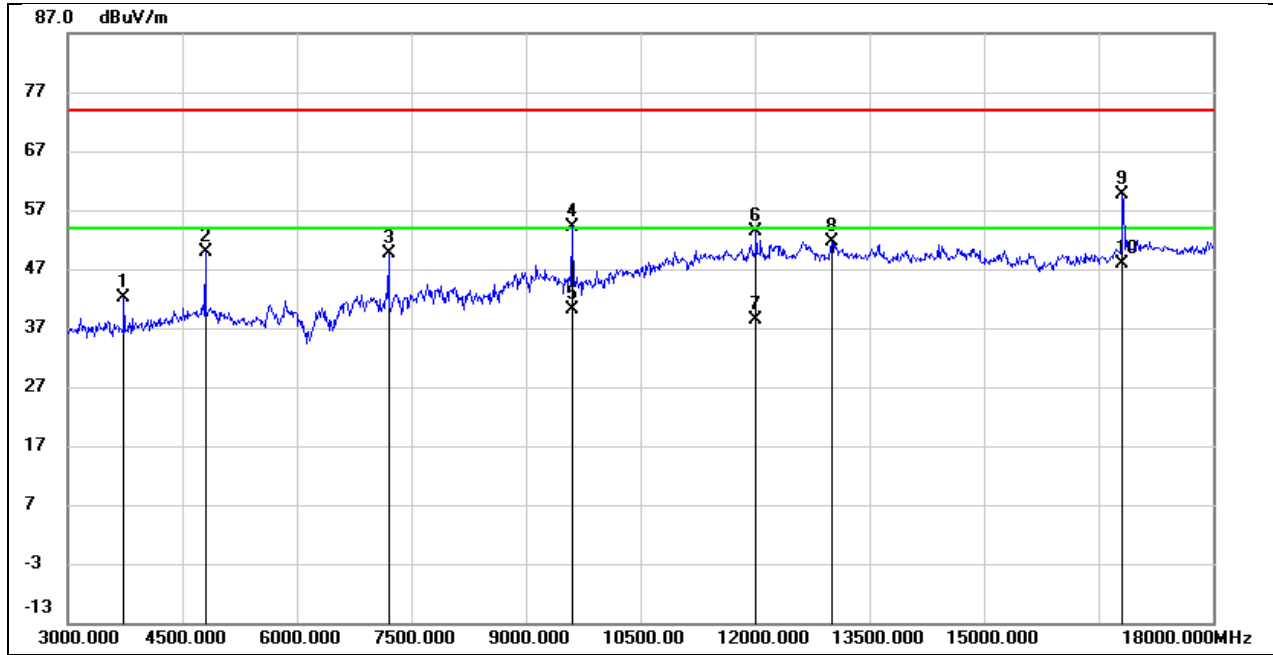

No.	Frequency (MHz)	Reading (dBuV)	Correct (dB/m)	Result (dBuV/m)	Limit (dBuV/m)	Margin (dB)	Remark
1	3735.000	46.53	-4.41	42.12	74.00	-31.88	peak
2	4800.000	50.30	-0.31	49.99	74.00	-24.01	peak
3	7200.000	43.06	6.55	49.61	74.00	-24.39	peak
4	9600.000	43.11	10.95	54.06	74.00	-19.94	peak
5	9600.000	29.25	10.95	40.20	54.00	-13.80	AVG
6	12015.000	35.32	17.95	53.27	74.00	-20.73	peak
7	12015.000	20.45	17.95	38.40	54.00	-15.60	AVG
8	13005.000	32.80	18.74	51.54	74.00	-22.46	peak
9	16815.000	39.51	20.07	59.58	74.00	-14.42	peak
10	16815.000	27.73	20.07	47.80	54.00	-6.20	AVG



Test Mode:	LE 1M	Channel:	2402 MHz
Polarity:	Vertical	Test Voltage:	DC 3.0 V

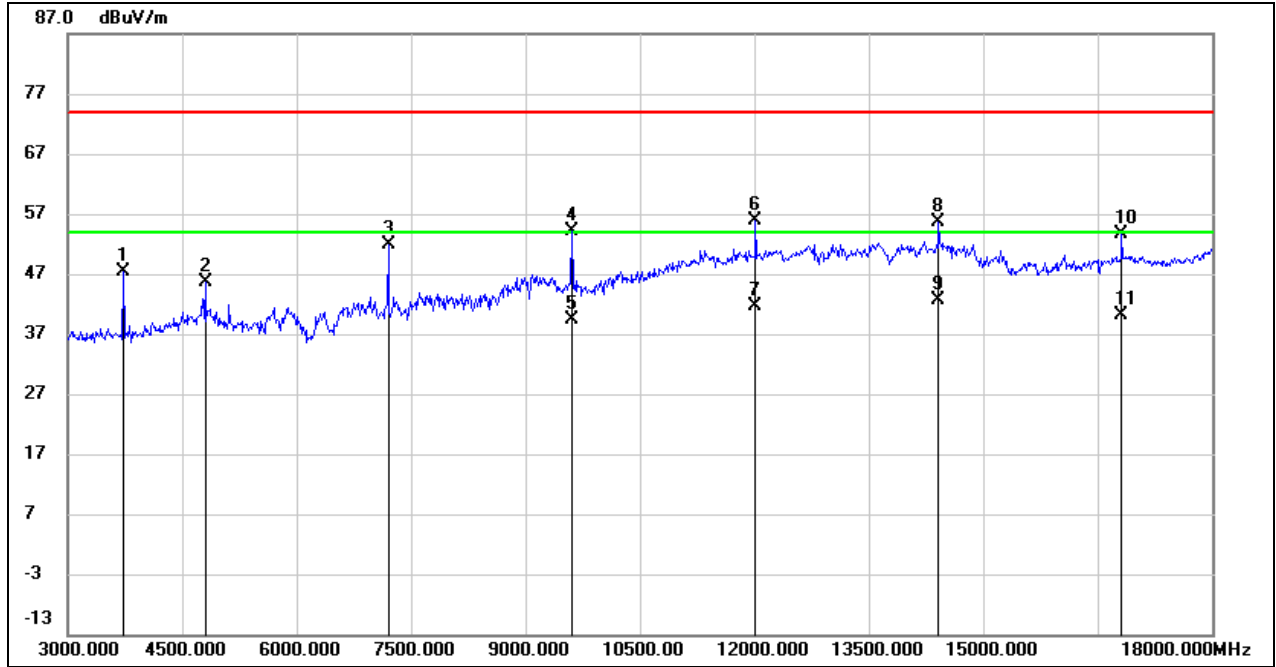

No.	Frequency (MHz)	Reading (dBuV)	Correct (dB/m)	Result (dBuV/m)	Limit (dBuV/m)	Margin (dB)	Remark
1	3735.000	51.68	-4.41	47.27	74.00	-26.73	peak
2	4800.000	45.99	-0.31	45.68	74.00	-28.32	peak
3	7200.000	45.27	6.55	51.82	74.00	-22.18	peak
4	9600.000	43.26	10.95	54.21	74.00	-19.79	peak
5	9600.000	28.55	10.95	39.50	54.00	-14.50	AVG
6	12015.000	37.85	17.95	55.80	74.00	-18.20	peak
7	12015.000	23.75	17.95	41.70	54.00	-12.30	AVG
8	14415.000	35.42	20.26	55.68	74.00	-18.32	peak
9	14415.000	22.34	20.26	42.60	54.00	-11.40	AVG
10	16815.000	33.59	20.07	53.66	74.00	-20.34	peak
11	16815.000	20.03	20.07	40.10	54.00	-13.90	AVG



Test Mode:	LE 1M	Channel:	2440 MHz
Polarity:	Horizontal	Test Voltage:	DC 3.0 V

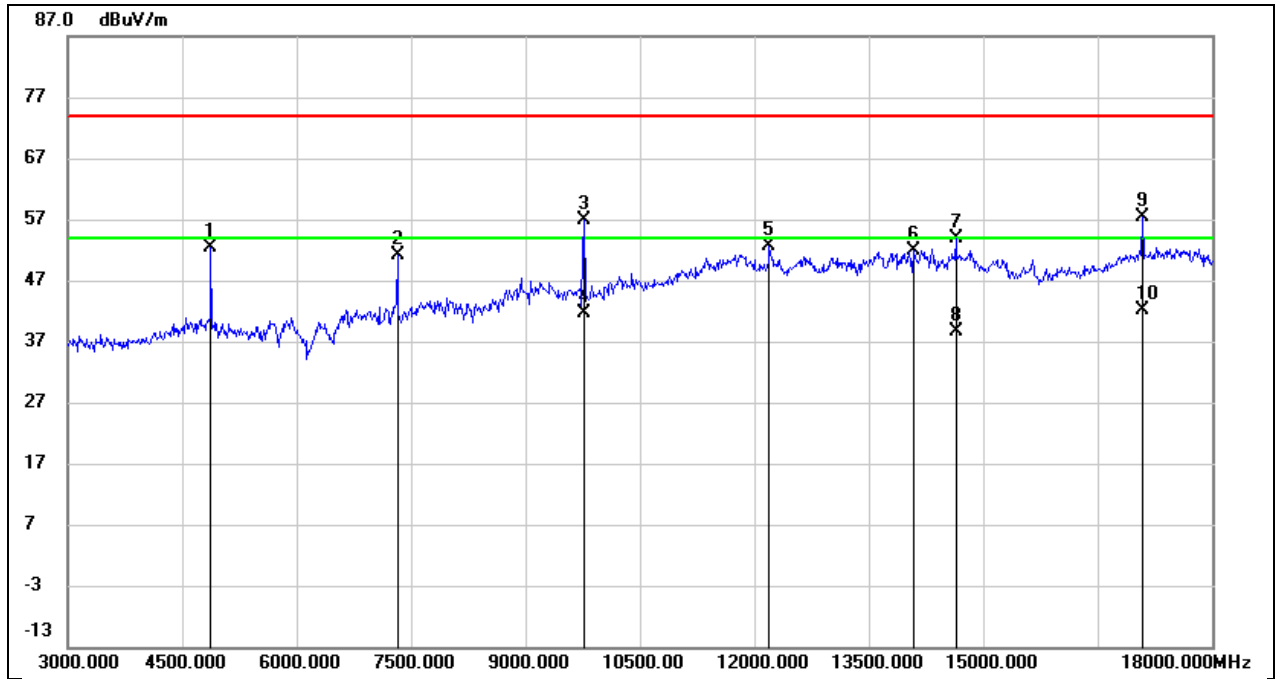

No.	Frequency (MHz)	Reading (dBuV)	Correct (dB/m)	Result (dBuV/m)	Limit (dBuV/m)	Margin (dB)	Remark
1	4875.000	52.34	-0.03	52.31	74.00	-21.69	peak
2	7320.000	44.79	6.46	51.25	74.00	-22.75	peak
3	9765.000	45.36	11.40	56.76	74.00	-17.24	peak
4	9765.000	30.20	11.40	41.60	54.00	-12.40	AVG
5	12195.000	34.88	17.82	52.70	74.00	-21.30	peak
6	14085.000	30.19	21.61	51.80	74.00	-22.20	peak
7	14640.000	34.65	19.34	53.99	74.00	-20.01	peak
8	14640.000	19.36	19.34	38.70	54.00	-15.30	AVG
9	17085.000	36.30	21.20	57.50	74.00	-16.50	peak
10	17085.000	20.90	21.20	42.10	54.00	-11.90	AVG



Test Mode:	LE 1M	Channel:	2440 MHz
Polarity:	Vertical	Test Voltage:	DC 3.0 V

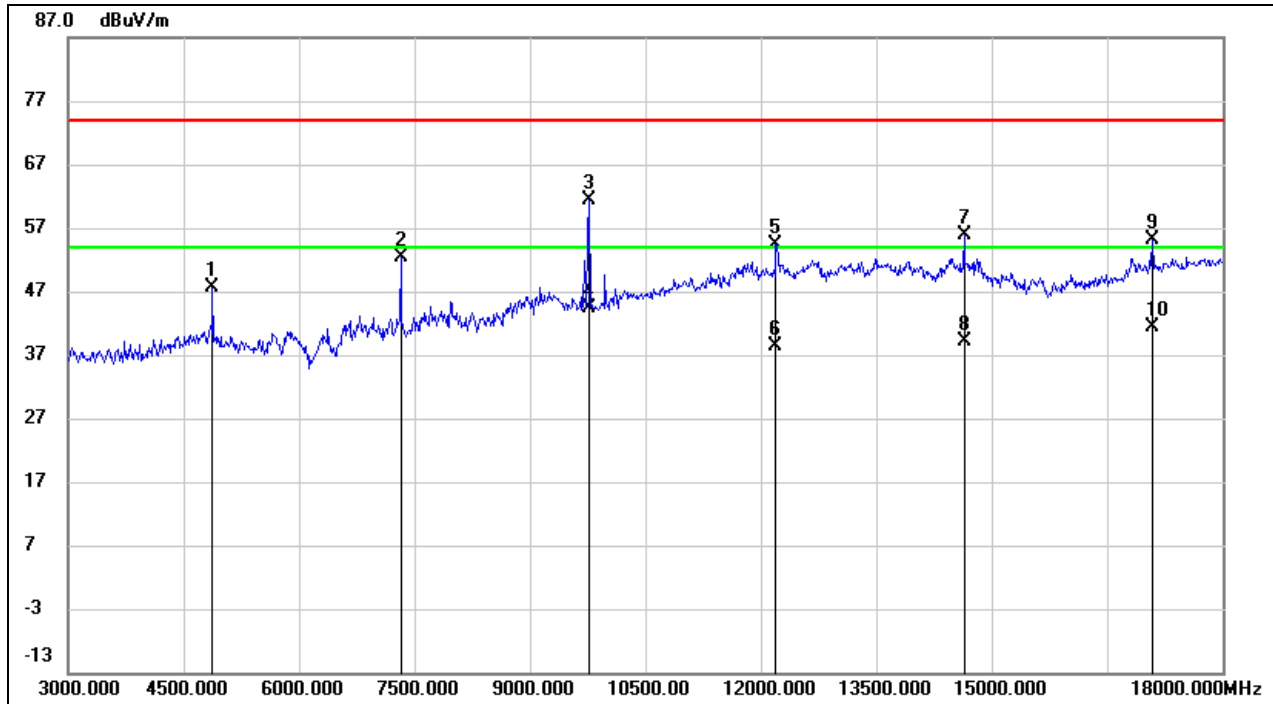

No.	Frequency (MHz)	Reading (dBuV)	Correct (dB/m)	Result (dBuV/m)	Limit (dBuV/m)	Margin (dB)	Remark
1	4875.000	47.59	-0.03	47.56	74.00	-26.44	peak
2	7320.000	45.81	6.46	52.27	74.00	-21.73	peak
3	9765.000	49.91	11.40	61.31	74.00	-12.69	peak
4	9765.000	33.10	11.40	44.50	54.00	-9.50	AVG
5	12195.000	36.54	17.82	54.36	74.00	-19.64	peak
6	12195.000	20.68	17.82	38.50	54.00	-15.50	AVG
7	14640.000	36.48	19.34	55.82	74.00	-18.18	peak
8	14640.000	19.86	19.34	39.20	54.00	-14.80	AVG
9	17085.000	34.05	21.20	55.25	74.00	-18.75	peak
10	17085.000	20.10	21.20	41.30	54.00	-12.70	AVG



Test Mode:	LE 1M	Channel:	2480 MHz
Polarity:	Horizontal	Test Voltage:	DC 3.0 V

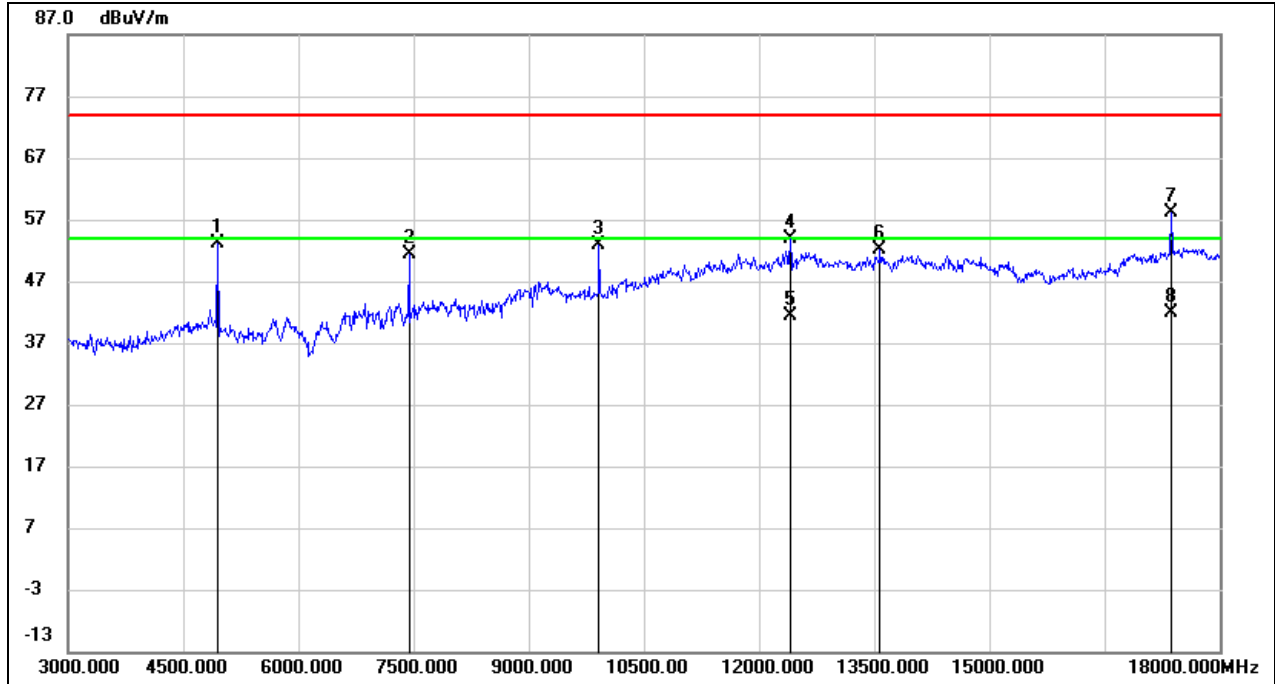

No.	Frequency (MHz)	Reading (dBuV)	Correct (dB/m)	Result (dBuV/m)	Limit (dBuV/m)	Margin (dB)	Remark
1	4950.000	52.78	0.26	53.04	74.00	-20.96	peak
2	7440.000	44.96	6.38	51.34	74.00	-22.66	peak
3	9915.000	41.07	11.80	52.87	74.00	-21.13	peak
4	12405.000	36.19	17.67	53.86	74.00	-20.14	peak
5	12405.000	23.83	17.67	41.50	54.00	-12.50	AVG
6	13575.000	31.00	21.06	52.06	74.00	-21.94	peak
7	17370.000	35.83	22.25	58.08	74.00	-15.92	peak
8	17370.000	19.75	22.25	42.00	54.00	-12.00	AVG



Test Mode:	LE 1M	Channel:	2480 MHz
Polarity:	Vertical	Test Voltage:	DC 3.0 V

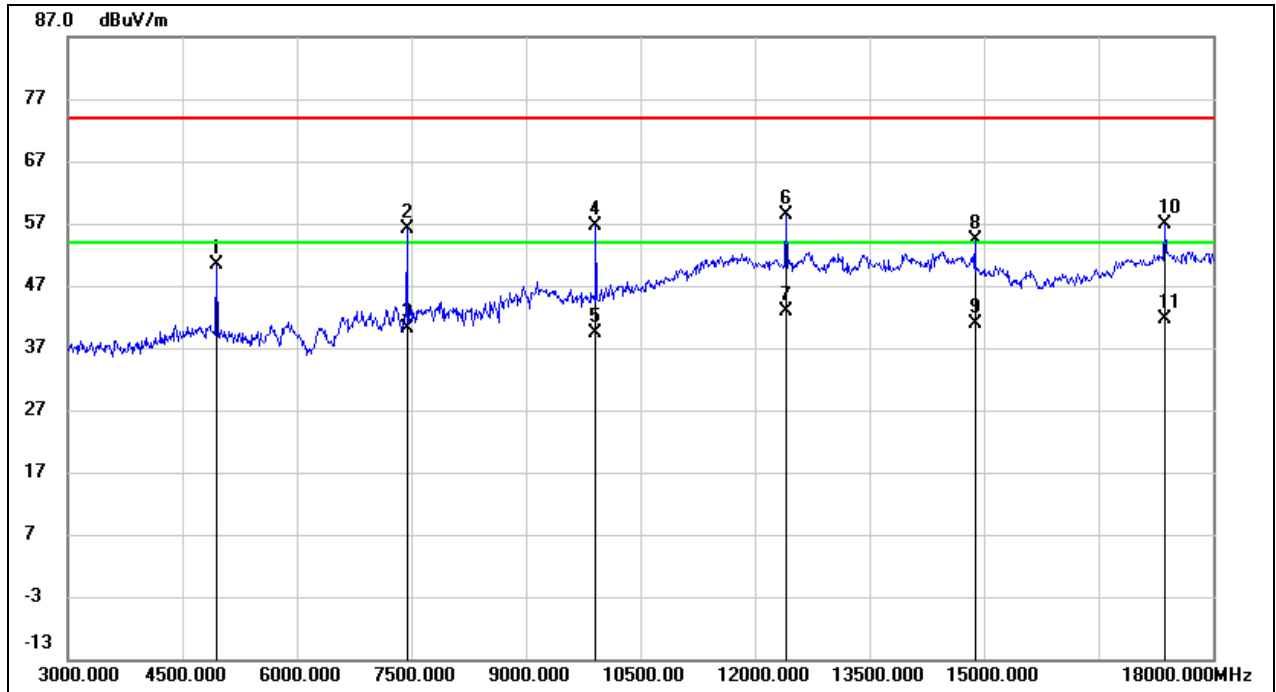

No.	Frequency (MHz)	Reading (dBuV)	Correct (dB/m)	Result (dBuV/m)	Limit (dBuV/m)	Margin (dB)	Remark
1	4950.000	50.16	0.26	50.42	74.00	-23.58	peak
2	7440.000	49.81	6.38	56.19	74.00	-17.81	peak
3	7440.000	33.72	6.38	40.10	54.00	-13.90	AVG
4	9915.000	44.81	11.80	56.61	74.00	-17.39	peak
5	9915.000	27.70	11.80	39.50	54.00	-14.50	AVG
6	12405.000	40.74	17.67	58.41	74.00	-15.59	peak
7	12405.000	25.13	17.67	42.80	54.00	-11.20	AVG
8	14880.000	35.97	18.37	54.34	74.00	-19.66	peak
9	14880.000	22.43	18.37	40.80	54.00	-13.20	AVG
10	17370.000	34.67	22.25	56.92	74.00	-17.08	peak
11	17370.000	19.45	22.25	41.70	54.00	-12.30	AVG



Test Mode:	LE 2M	Channel:	2402 MHz
Polarity:	Horizontal	Test Voltage:	DC 3.0 V

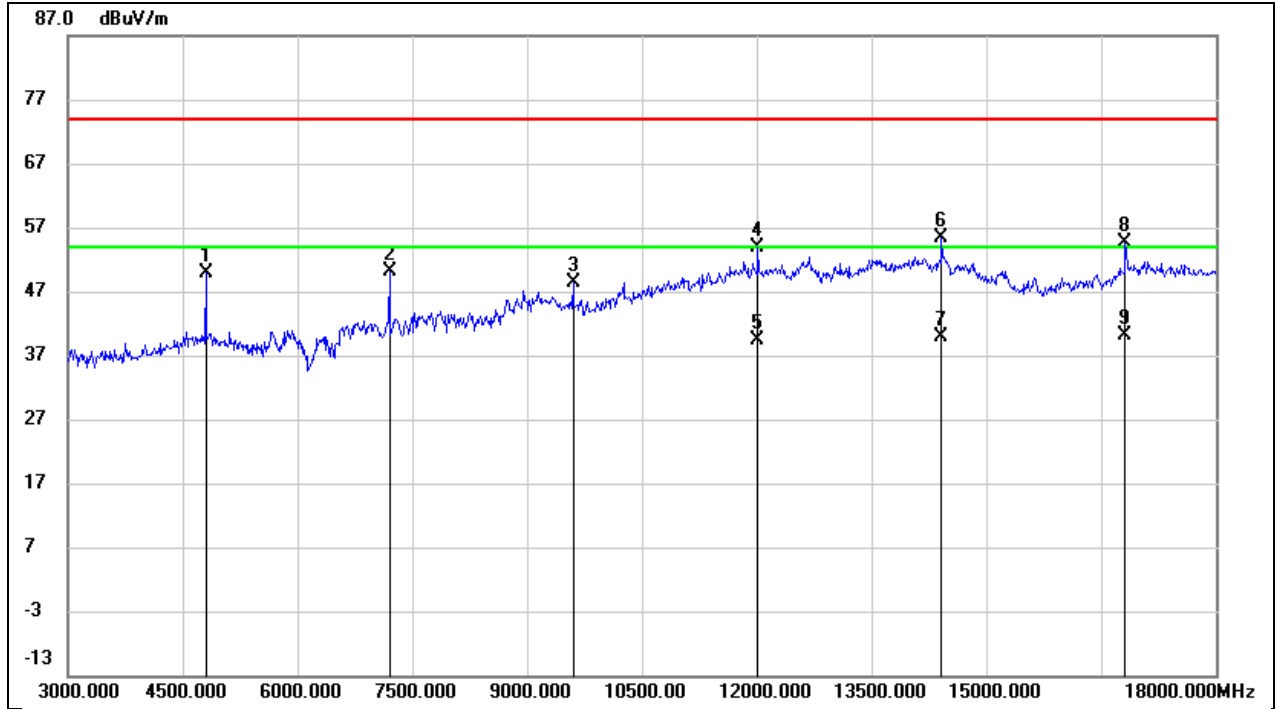

No.	Frequency (MHz)	Reading (dBuV)	Correct (dB/m)	Result (dBuV/m)	Limit (dBuV/m)	Margin (dB)	Remark
1	4800.000	50.08	-0.31	49.77	74.00	-24.23	peak
2	7200.000	43.64	6.55	50.19	74.00	-23.81	peak
3	9600.000	37.41	10.95	48.36	74.00	-25.64	peak
4	12015.000	35.90	17.95	53.85	74.00	-20.15	peak
5	12015.000	21.45	17.95	39.40	54.00	-14.60	AVG
6	14415.000	35.15	20.26	55.41	74.00	-18.59	peak
7	14415.000	19.54	20.26	39.80	54.00	-14.20	AVG
8	16815.000	34.55	20.07	54.62	74.00	-19.38	peak
9	16815.000	20.03	20.07	40.10	54.00	-13.90	AVG



Test Mode:	LE 2M	Channel:	2402 MHz
Polarity:	Vertical	Test Voltage:	DC 3.0 V

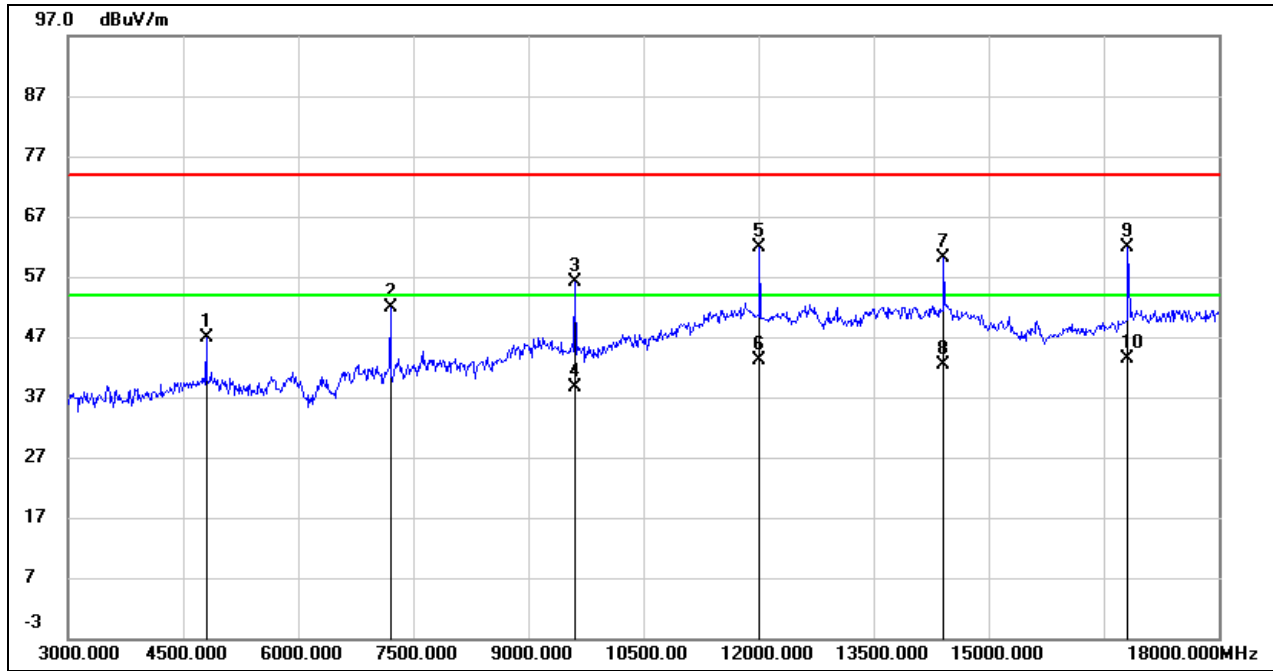

No.	Frequency (MHz)	Reading (dBuV)	Correct (dB/m)	Result (dBuV/m)	Limit (dBuV/m)	Margin (dB)	Remark
1	4800.000	47.24	-0.31	46.93	74.00	-27.07	peak
2	7200.000	45.27	6.55	51.82	74.00	-22.18	peak
3	9600.000	45.16	10.95	56.11	74.00	-17.89	peak
4	9600.000	27.65	10.95	38.60	54.00	-15.40	AVG
5	12015.000	43.82	17.95	61.77	74.00	-12.23	peak
6	12015.000	25.15	17.95	43.10	54.00	-10.90	AVG
7	14415.000	39.92	20.26	60.18	74.00	-13.82	peak
8	14415.000	22.14	20.26	42.40	54.00	-11.60	AVG
9	16815.000	41.81	20.07	61.88	74.00	-12.12	peak
10	16815.000	23.23	20.07	43.30	54.00	-10.70	AVG



Test Mode:	LE 2M	Channel:	2440 MHz
Polarity:	Horizontal	Test Voltage:	DC 3.0 V

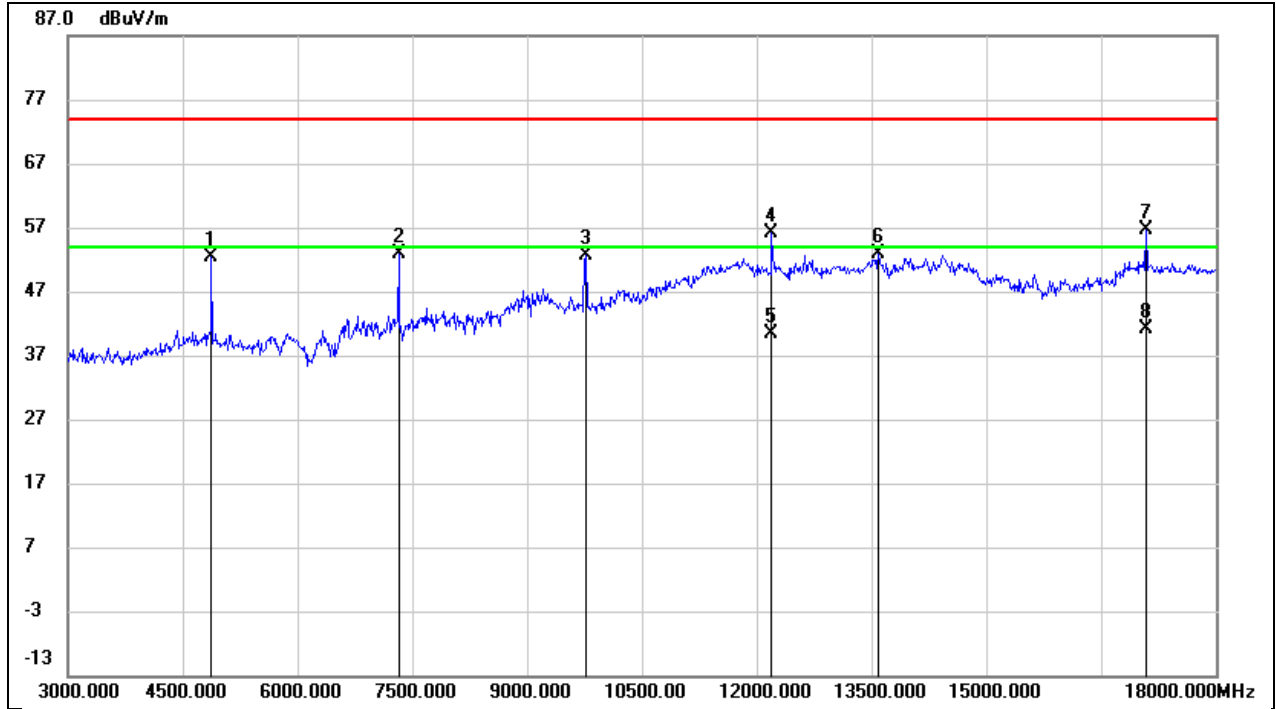

No.	Frequency (MHz)	Reading (dBuV)	Correct (dB/m)	Result (dBuV/m)	Limit (dBuV/m)	Margin (dB)	Remark
1	4875.000	52.33	-0.03	52.30	74.00	-21.70	peak
2	7320.000	46.33	6.46	52.79	74.00	-21.21	peak
3	9765.000	41.25	11.40	52.65	74.00	-21.35	peak
4	12195.000	38.20	17.82	56.02	74.00	-17.98	peak
5	12195.000	22.48	17.82	40.30	54.00	-13.70	AVG
6	13590.000	31.68	21.09	52.77	74.00	-21.23	peak
7	17085.000	35.50	21.20	56.70	74.00	-17.30	peak
8	17085.000	20.00	21.20	41.20	54.00	-12.80	AVG



Test Mode:	LE 2M	Channel:	2440 MHz
Polarity:	Vertical	Test Voltage:	DC 3.0 V

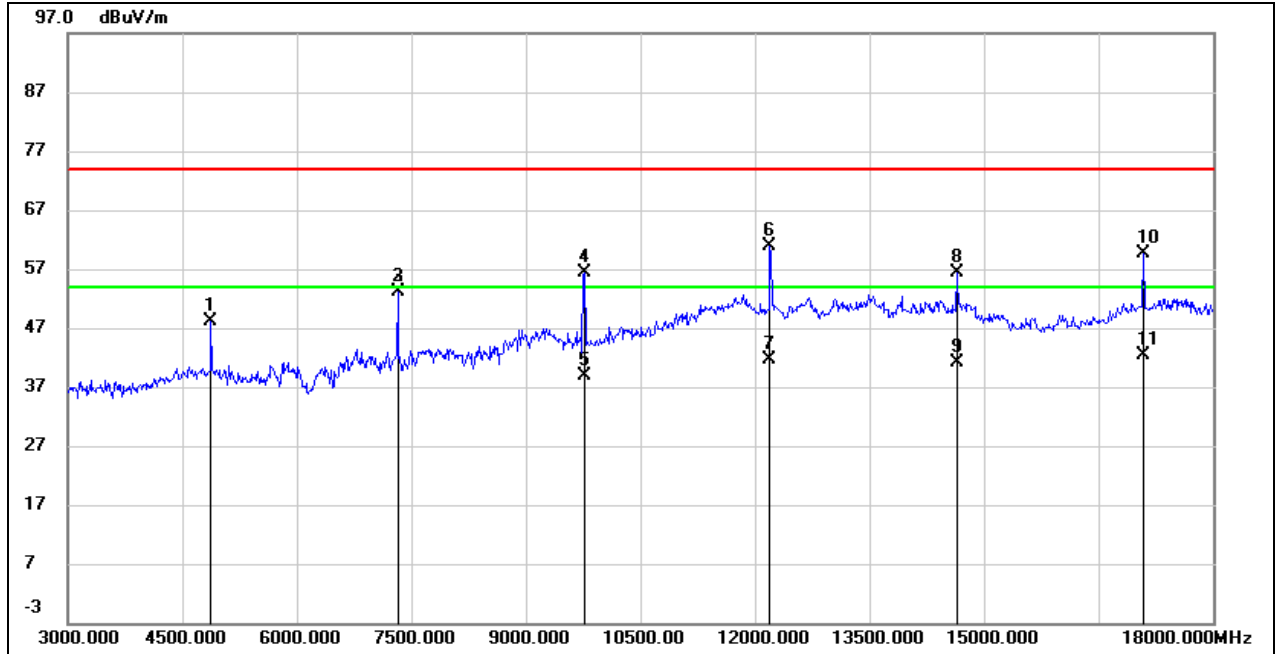

No.	Frequency (MHz)	Reading (dBuV)	Correct (dB/m)	Result (dBuV/m)	Limit (dBuV/m)	Margin (dB)	Remark
1	4875.000	48.23	-0.03	48.20	74.00	-25.80	peak
2	7320.000	46.75	6.46	53.21	74.00	-20.79	peak
3	7320.000	46.75	6.46	53.21	74.00	-20.79	peak
4	7320.000	46.75	6.46	53.21	74.00	-20.79	peak
5	9765.000	45.01	11.40	56.41	74.00	-17.59	peak
6	9765.000	27.50	11.40	38.90	54.00	-15.10	AVG
7	12195.000	43.16	17.82	60.98	74.00	-13.02	peak
8	12195.000	23.78	17.82	41.60	54.00	-12.40	AVG
9	14640.000	37.15	19.34	56.49	74.00	-17.51	peak
10	14640.000	21.76	19.34	41.10	54.00	-12.90	AVG
11	17085.000	38.41	21.20	59.61	74.00	-14.39	peak
	17085.000	21.30	21.20	42.50	54.00	-11.50	AVG



Test Mode:	LE 2M	Channel:	2480 MHz
Polarity:	Horizontal	Test Voltage:	DC 3.0 V

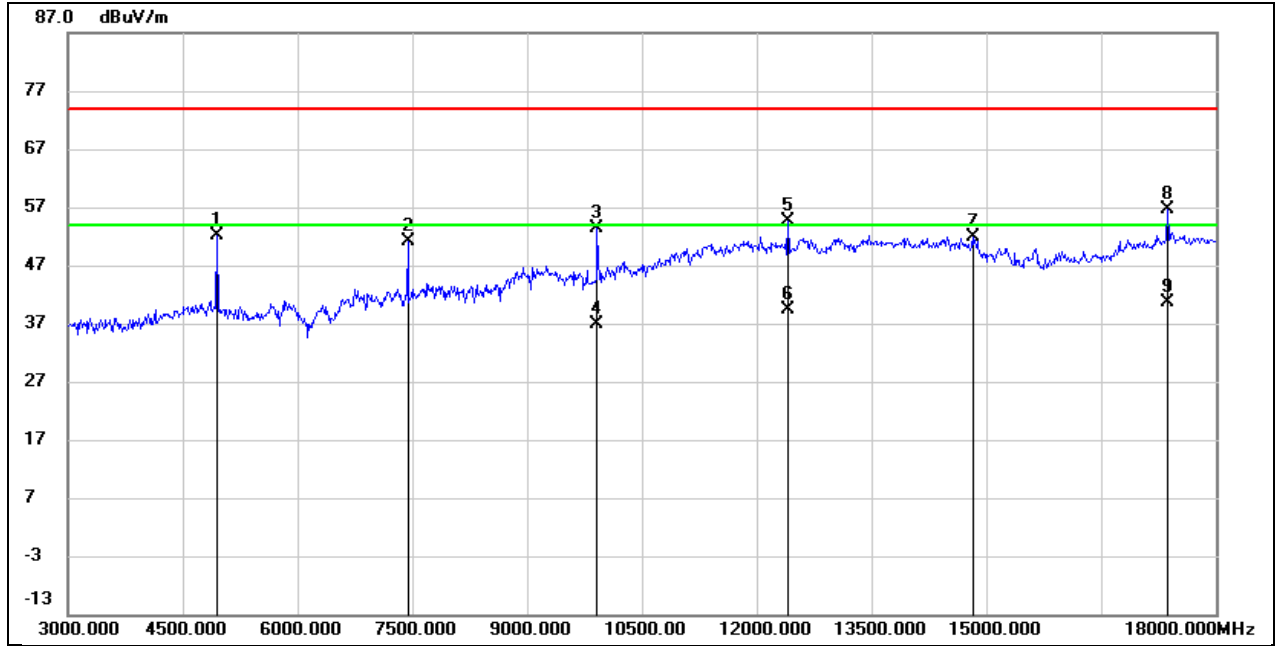

No.	Frequency (MHz)	Reading (dBuV)	Correct (dB/m)	Result (dBuV/m)	Limit (dBuV/m)	Margin (dB)	Remark
1	4950.000	51.78	0.26	52.04	74.00	-21.96	peak
2	7440.000	44.86	6.38	51.24	74.00	-22.76	peak
3	9915.000	41.48	11.80	53.28	74.00	-20.72	peak
4	9915.000	25.00	11.80	36.80	54.00	-17.20	AVG
5	12405.000	36.90	17.67	54.57	74.00	-19.43	peak
6	12405.000	21.83	17.67	39.50	54.00	-14.50	AVG
7	14820.000	33.29	18.62	51.91	74.00	-22.09	peak
8	17370.000	34.45	22.25	56.70	74.00	-17.30	peak
9	17370.000	18.45	22.25	40.70	54.00	-13.30	AVG



Test Mode:	LE 2M	Channel:	2480 MHz
Polarity:	Vertical	Test Voltage:	DC 3.0 V

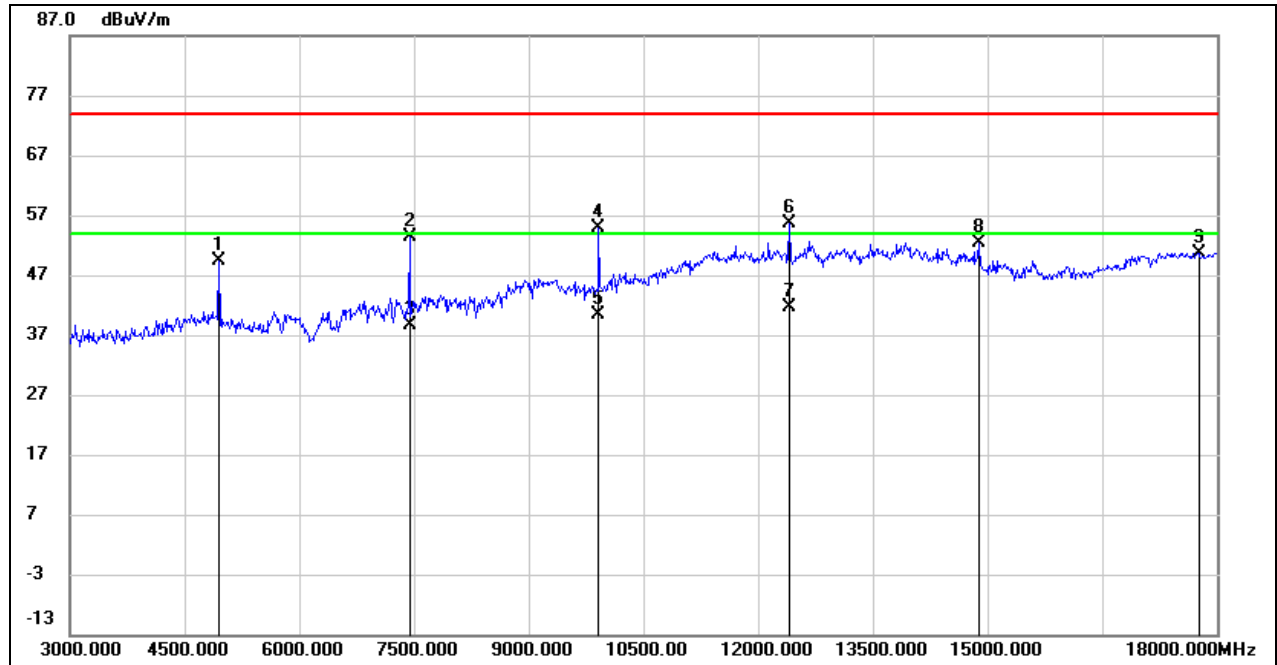

No.	Frequency (MHz)	Reading (dBuV)	Correct (dB/m)	Result (dBuV/m)	Limit (dBuV/m)	Margin (dB)	Remark
1	4950.000	49.19	0.26	49.45	74.00	-24.55	peak
2	7440.000	46.90	6.38	53.28	74.00	-20.72	peak
3	7440.000	32.22	6.38	38.60	54.00	-15.40	AVG
4	9915.000	43.12	11.80	54.92	74.00	-19.08	peak
5	9915.000	28.70	11.80	40.50	54.00	-13.50	AVG
6	12405.000	38.06	17.67	55.73	74.00	-18.27	peak
7	12405.000	23.93	17.67	41.60	54.00	-12.40	AVG
8	14880.000	34.04	18.37	52.41	74.00	-21.59	peak
9	17760.000	26.48	24.27	50.75	74.00	-23.25	peak



8.4. SPURIOUS EMISSIONS (9 KHZ ~ 30 MHZ)

Test Mode:	LE 1M	Channel:	2441 MHz
Polarity:	Loop Antenna Face On To The EUT	Test Voltage	DC 3.0 V

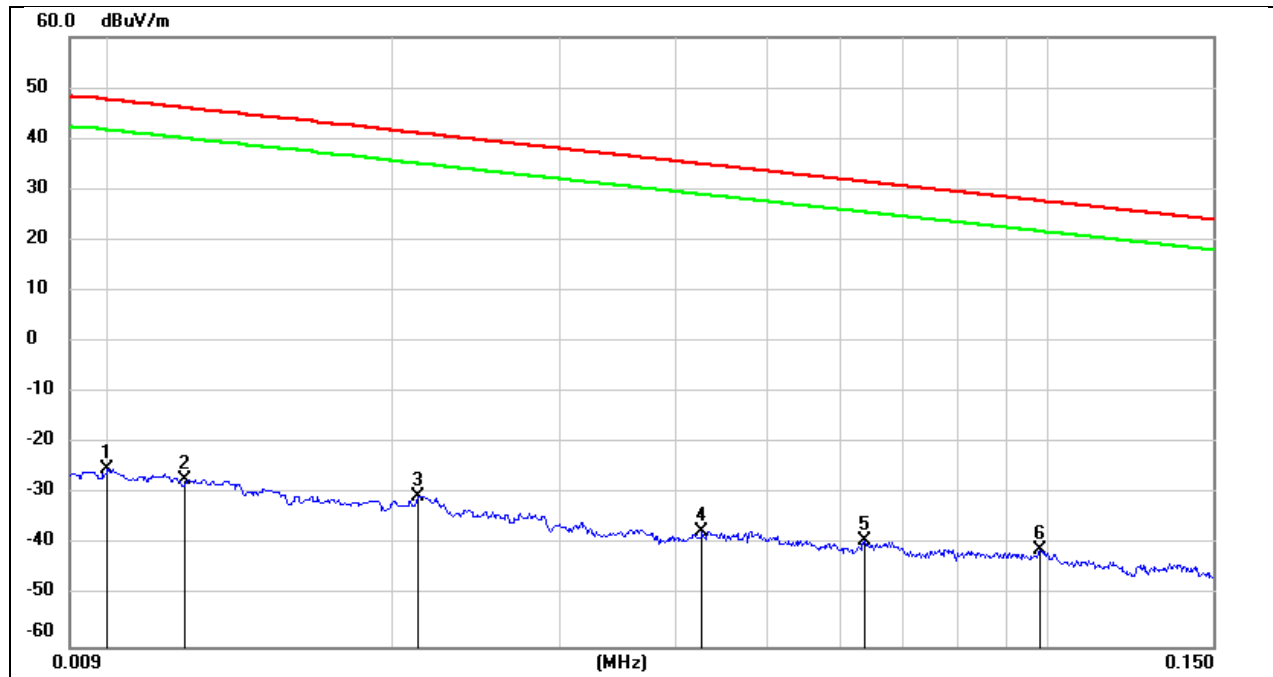

No.	Frequency (MHz)	Reading (dBuV)	Correct (dB/m)	Result (dBuV/m)	Limit (dBuV/m)	Margin (dB)	Remark
1	0.0100	76.22	-101.40	-25.18	47.60	-72.78	peak
2	0.0120	74.36	-101.39	-27.03	46.02	-73.05	peak
3	0.0212	71.04	-101.35	-30.31	41.07	-71.38	peak
4	0.0427	64.14	-101.45	-37.31	34.99	-72.30	peak
5	0.0636	62.31	-101.54	-39.23	31.53	-70.76	peak
6	0.0981	60.77	-101.78	-41.01	27.77	-68.78	peak



Test Mode:	LE 1M	Channel:	2441 MHz
Polarity:	Loop Antenna Face On To The EUT	Test Voltage	DC 3.0 V

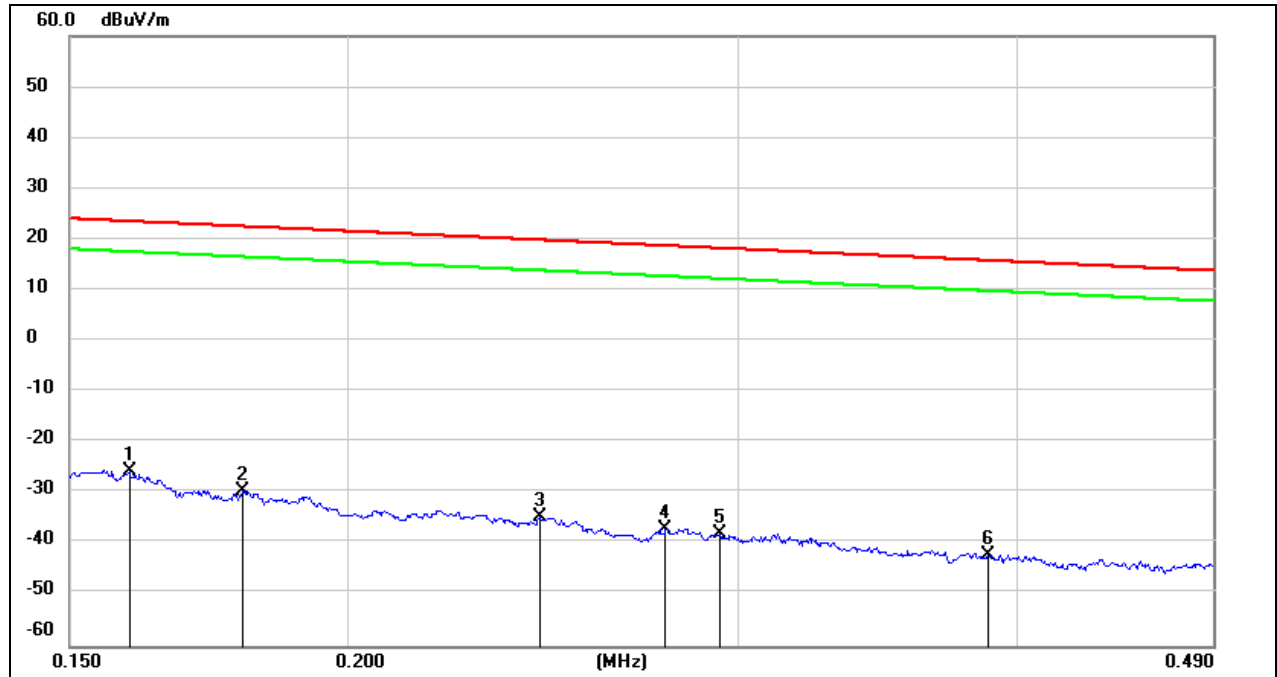

No.	Frequency (MHz)	Reading (dBuV)	Correct (dB/m)	Result (dBuV/m)	Limit (dBuV/m)	Margin (dB)	Remark
1	0.1595	75.86	-101.65	-25.79	23.55	-49.34	peak
2	0.1794	72.27	-101.68	-29.41	22.53	-51.94	peak
3	0.2442	67.03	-101.79	-34.76	19.85	-54.61	peak
4	0.2782	64.79	-101.83	-37.04	18.71	-55.75	peak
5	0.2942	63.82	-101.85	-38.03	18.23	-56.26	peak
6	0.3881	59.90	-101.95	-42.05	15.82	-57.87	peak



Test Mode:	LE 1M	Channel:	2441 MHz
Polarity:	Loop Antenna Face On To The EUT	Test Voltage	DC 3.0 V

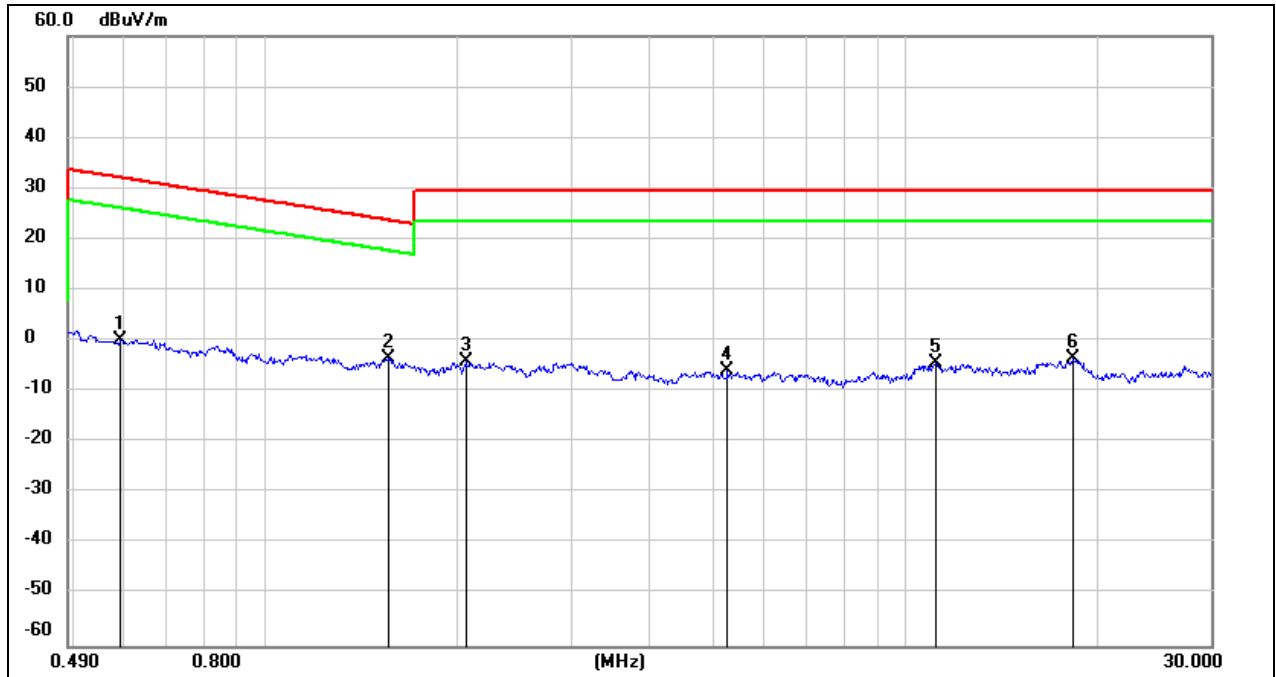

No.	Frequency (MHz)	Reading (dBuV)	Correct (dB/m)	Result (dBuV/m)	Limit (dBuV/m)	Margin (dB)	Remark
1	0.5917	62.24	-62.08	0.16	32.16	-32.00	peak
2	1.5564	58.68	-62.02	-3.34	23.76	-27.10	peak
3	2.0539	57.70	-61.81	-4.11	29.54	-33.65	peak
4	5.2705	55.54	-61.45	-5.91	29.54	-35.45	peak
5	11.1431	56.49	-60.85	-4.36	29.54	-33.90	peak
6	18.2545	57.43	-60.90	-3.47	29.54	-33.01	peak

**8.5. SPURIOUS EMISSIONS (18 GHZ ~ 26 GHZ)**

Test Mode:	LE 1M	Channel:	2441 MHz
Polarity:	Horizontal	Test Voltage	DC 3.0 V

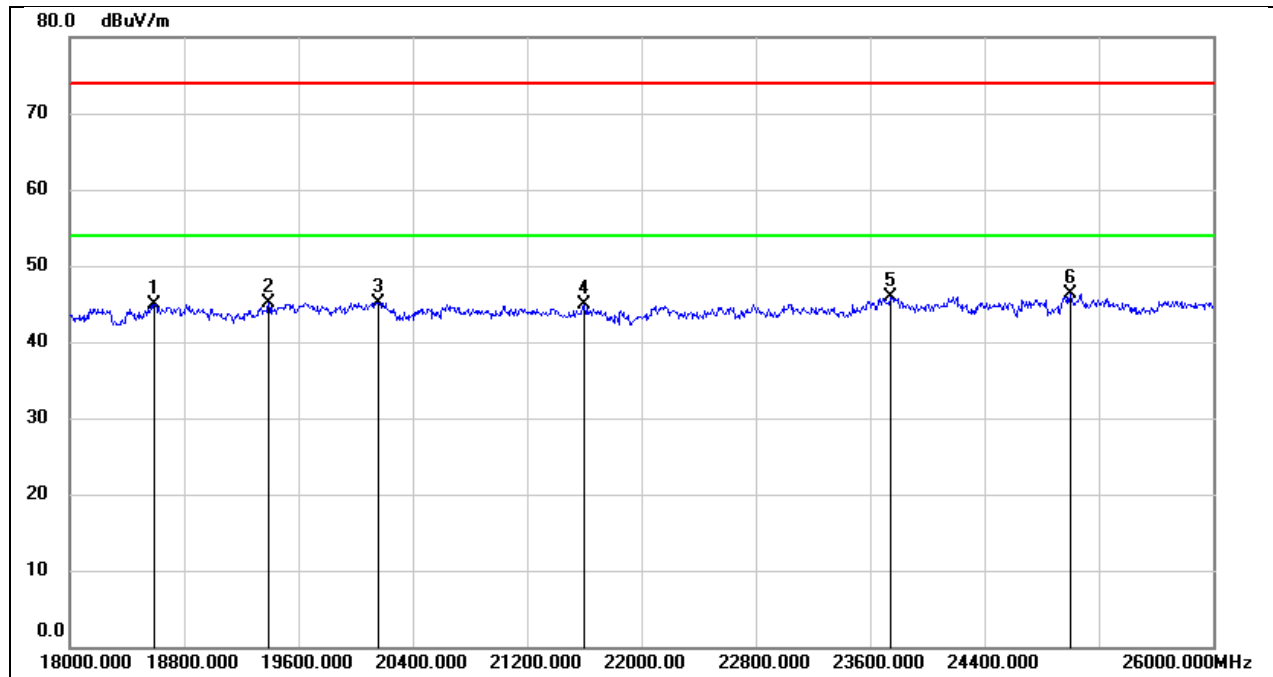

No.	Frequency (MHz)	Reading (dBuV)	Correct (dB/m)	Result (dBuV/m)	Limit (dBuV/m)	Margin (dB)	Remark
1	18592.000	50.25	-5.31	44.94	74.00	-29.06	peak
2	19392.000	50.62	-5.57	45.05	74.00	-28.95	peak
3	20160.000	50.73	-5.56	45.17	74.00	-28.83	peak
4	21600.000	49.52	-4.54	44.98	74.00	-29.02	peak
5	23744.000	49.15	-3.20	45.95	74.00	-28.05	peak
6	25000.000	48.36	-2.10	46.26	74.00	-27.74	peak



Test Mode:	LE 1M	Channel:	2441 MHz
Polarity:	Vertical	Test Voltage	DC 3.0 V

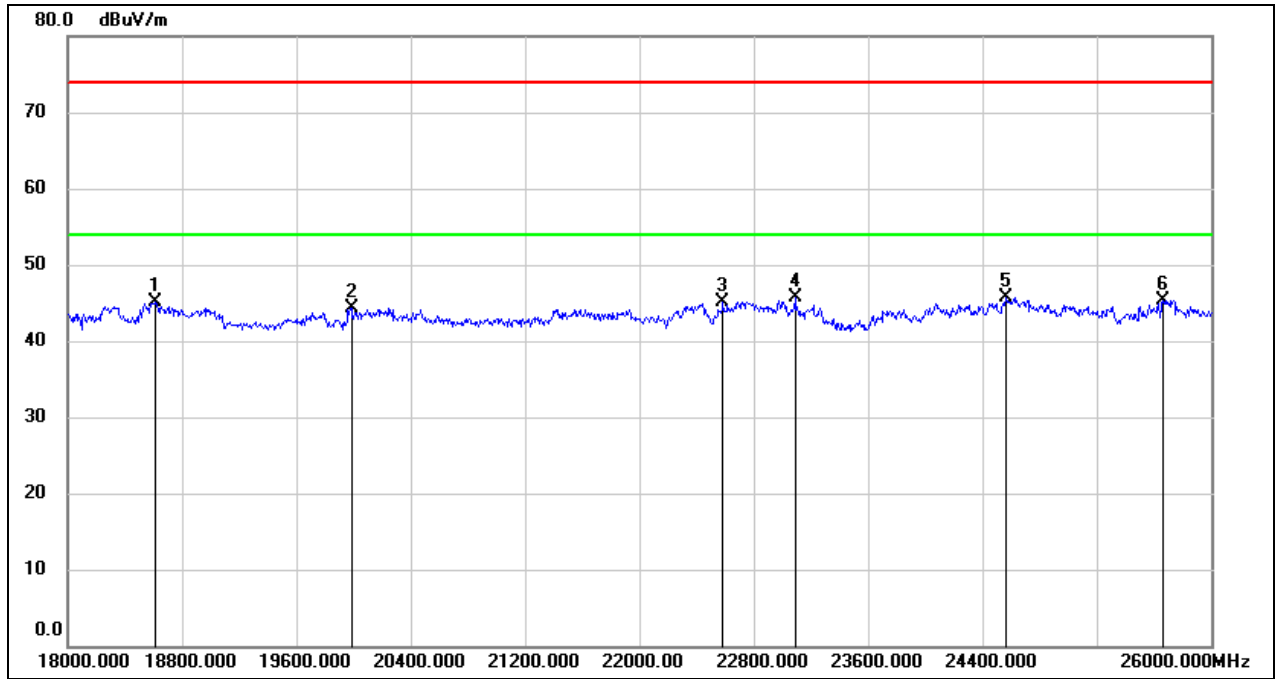

No.	Frequency (MHz)	Reading (dBuV)	Correct (dB/m)	Result (dBuV/m)	Limit (dBuV/m)	Margin (dB)	Remark
1	18616.000	50.39	-5.34	45.05	74.00	-28.95	peak
2	19984.000	49.71	-5.44	44.27	74.00	-29.73	peak
3	22584.000	48.85	-3.81	45.04	74.00	-28.96	peak
4	23088.000	49.02	-3.41	45.61	74.00	-28.39	peak
5	24568.000	48.10	-2.33	45.77	74.00	-28.23	peak
6	25664.000	46.39	-1.01	45.38	74.00	-28.62	peak

**8.6. SPURIOUS EMISSIONS (30 MHZ ~ 1 GHZ)**

Test Mode:	LE 1M	Channel:	2441 MHz
Polarity:	Horizontal	Test Voltage	DC 3.0 V

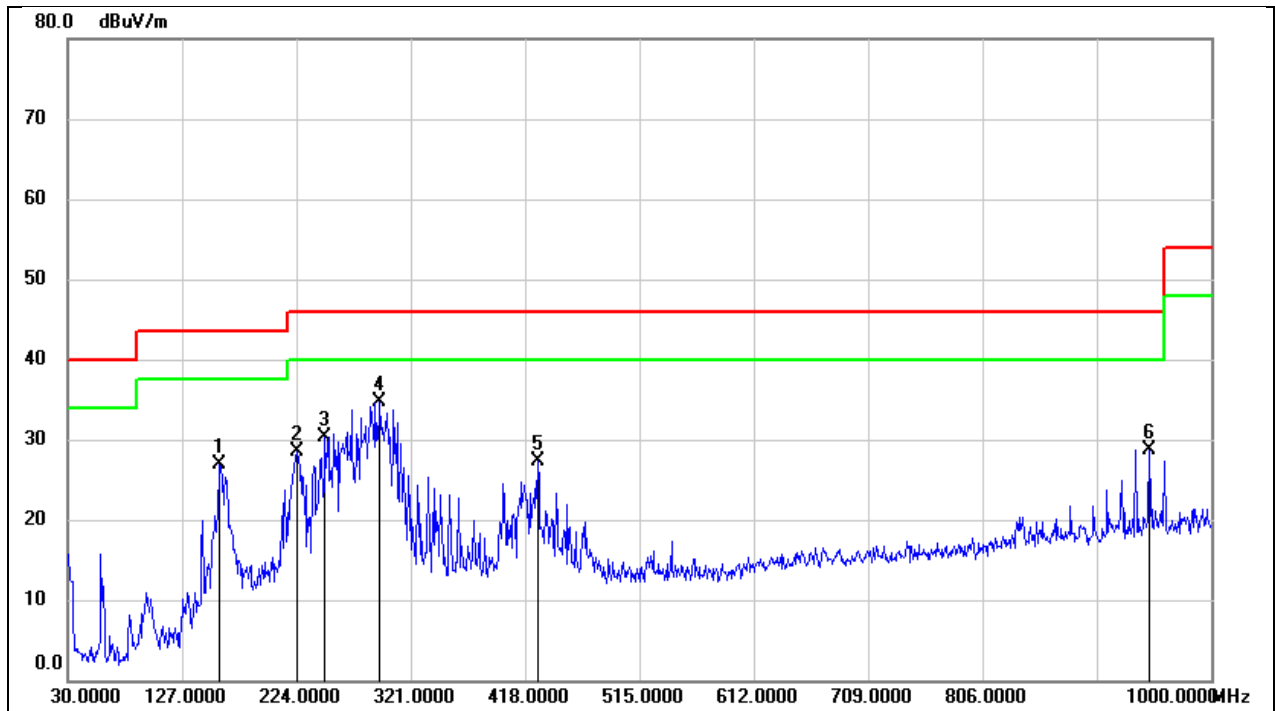

No.	Frequency (MHz)	Reading (dBuV)	Correct (dB/m)	Result (dBuV/m)	Limit (dBuV/m)	Margin (dB)	Remark
1	159.0100	44.61	-17.80	26.81	43.50	-16.69	QP
2	224.0000	46.91	-18.37	28.54	46.00	-17.46	QP
3	248.2500	49.25	-18.96	30.29	46.00	-15.71	QP
4	294.8100	50.27	-15.61	34.66	46.00	-11.34	QP
5	428.6700	39.96	-12.75	27.21	46.00	-18.79	QP
6	947.6200	33.19	-4.43	28.76	46.00	-17.24	QP



Test Mode:	LE 1M	Channel:	2441 MHz
Polarity:	Vertical	Test Voltage	DC 3.0 V

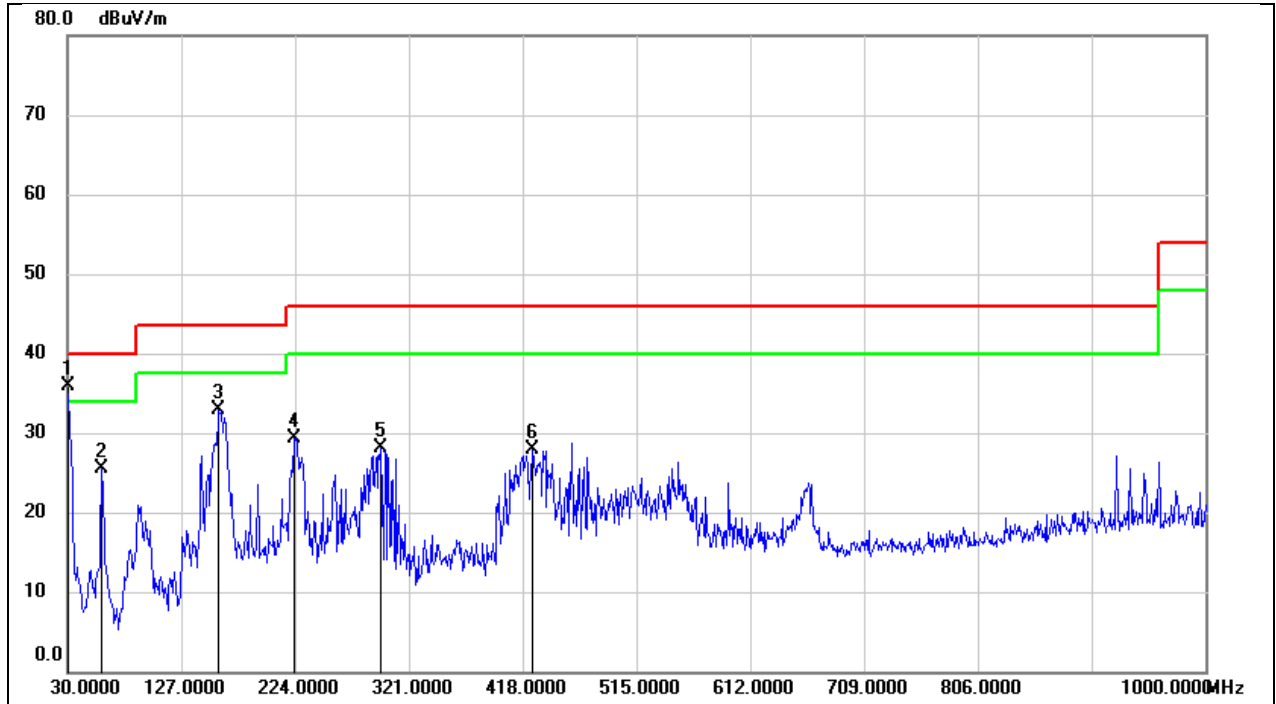

No.	Frequency (MHz)	Reading (dBuV)	Correct (dB/m)	Result (dBuV/m)	Limit (dBuV/m)	Margin (dB)	Remark
1	30.0000	54.75	-18.94	35.81	40.00	-4.19	QP
2	59.1000	46.08	-20.52	25.56	40.00	-14.44	QP
3	159.0100	50.74	-17.80	32.94	43.50	-10.56	QP
4	223.0300	47.61	-18.32	29.29	46.00	-16.71	QP
5	296.7500	43.69	-15.50	28.19	46.00	-17.81	QP
6	426.7300	40.73	-12.81	27.92	46.00	-18.08	QP



9. ANTENNA REQUIREMENT

APPLICABLE REQUIREMENTS

Please refer to FCC §15.203

An intentional radiator shall be designed to ensure that no antenna other than that furnished by the responsible party shall be used with the device. The use of a permanently attached antenna or of an antenna that uses a unique coupling to the intentional radiator shall be considered sufficient to comply with the provisions of this section. The manufacturer may design the unit so that a broken antenna can be replaced by the user, but the use of a standard antenna jack or electrical connector is prohibited.

Please refer to FCC §15.247(b)(4)

The conducted output power limit specified in paragraph (b) of this section is based on the use of antennas with directional gains that do not exceed 6 dBi. Except as shown in paragraph (c) of this section, if transmitting antennas of directional gain greater than 6 dBi are used, the conducted output power from the intentional radiator shall be reduced below the stated values in paragraphs (b)(1), (b)(2), and (b)(3) of this section, as appropriate, by the amount in dB that the directional gain of the antenna exceeds 6 dBi.

RESULTS

Complies



10. TEST DATA

10.1. APPENDIX A: DTS BANDWIDTH

10.1.1. Test Result

Test Mode	Antenna	Channel	DTS BW [MHz]	FL[MHz]	FH[MHz]	Limit[MHz]	Verdict
LE 1M	Ant1	2402	0.705	2401.655	2402.360	≥ 0.5	PASS
		2440	0.681	2439.661	2440.342	≥ 0.5	PASS
		2480	0.714	2479.637	2480.351	≥ 0.5	PASS
LE 2M	Ant1	2402	1.036	2401.480	2402.516	≥ 0.5	PASS
		2440	1.032	2439.484	2440.516	≥ 0.5	PASS
		2480	1.024	2479.488	2480.512	≥ 0.5	PASS



10.1.2. Test Graphs



LE 1M_Ant1_2402

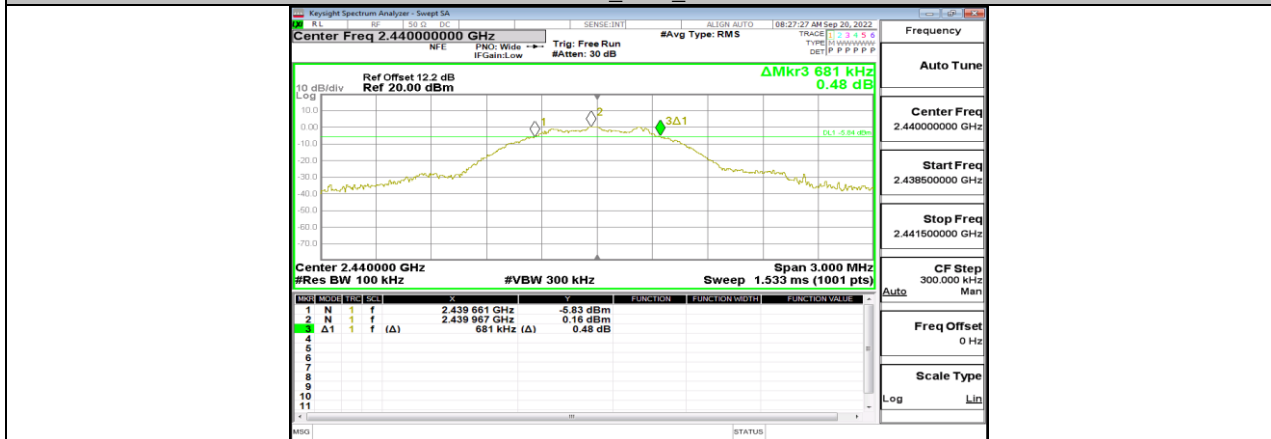

LE 1M_Ant1_2440

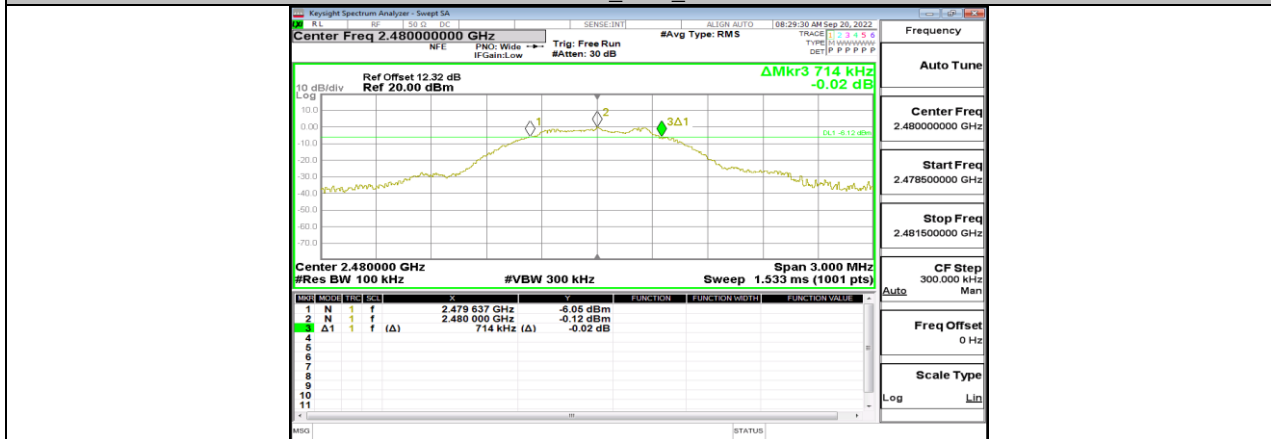

LE 1M_Ant1_2480

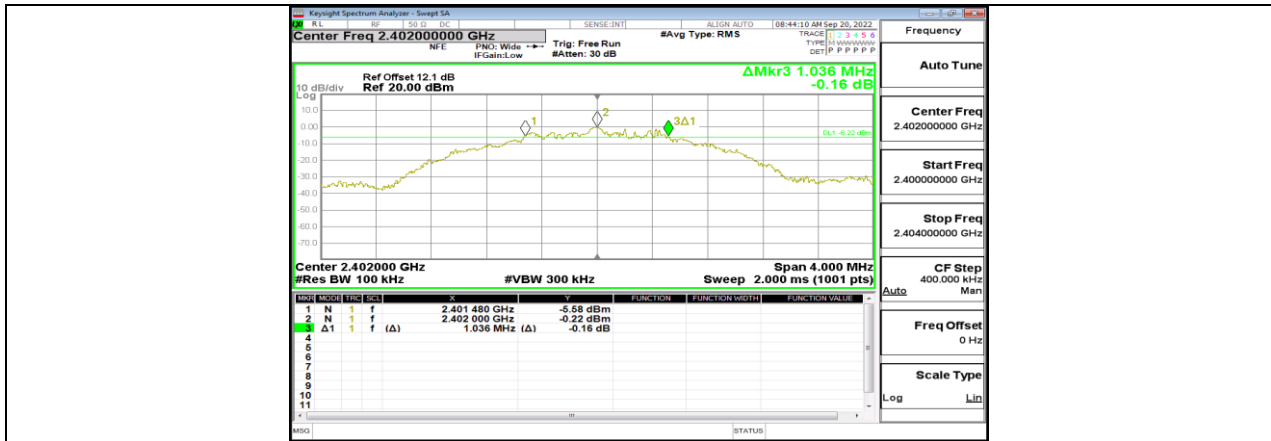

LE 2M_Ant1_2402



LE 2M_Ant1_2440

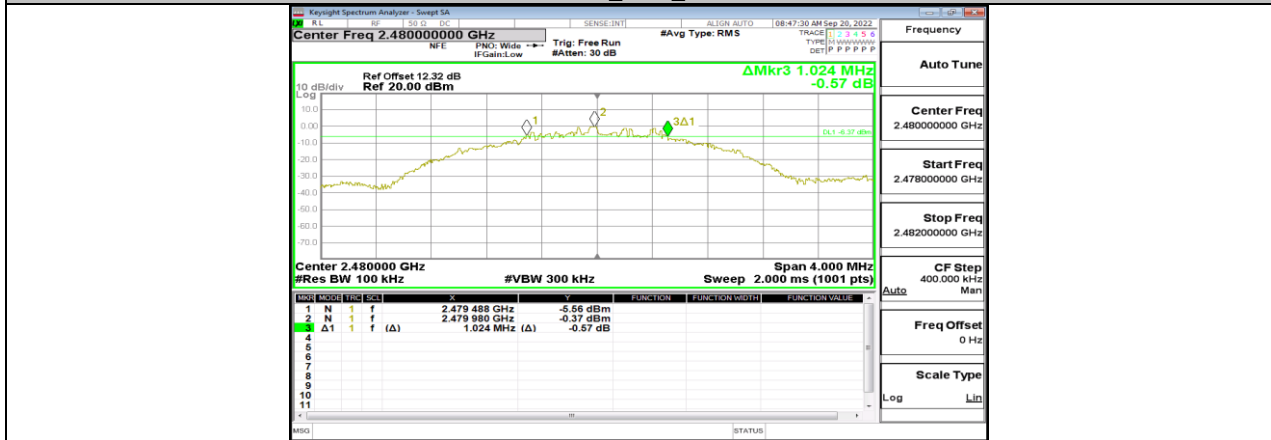

LE 2M_Ant1_2480



10.2. APPENDIX B: OCCUPIED CHANNEL BANDWIDTH

10.2.1. Test Result

Test Mode	Antenna	Channel	OCB [MHz]	FL[MHz]	FH[MHz]	Verdict
LE 1M	Ant1	2402	1.0875	2401.458	2402.546	PASS
		2440	1.0804	2439.460	2440.540	PASS
		2480	1.1069	2479.448	2480.554	PASS
LE 2M	Ant1	2402	2.0946	2400.958	2403.053	PASS
		2440	2.0833	2438.959	2441.043	PASS
		2480	2.0867	2478.958	2481.045	PASS



10.2.2. Test Graphs



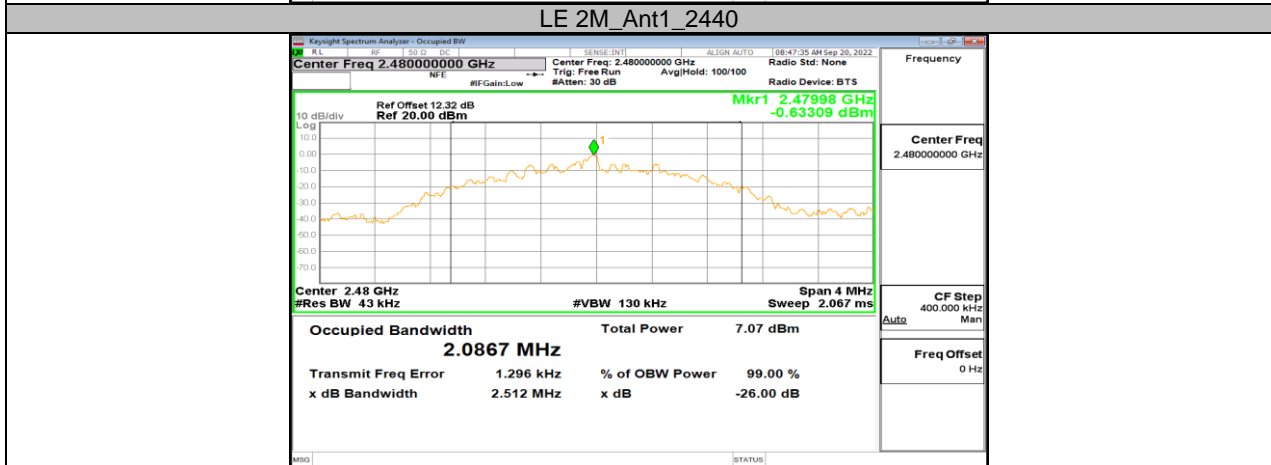
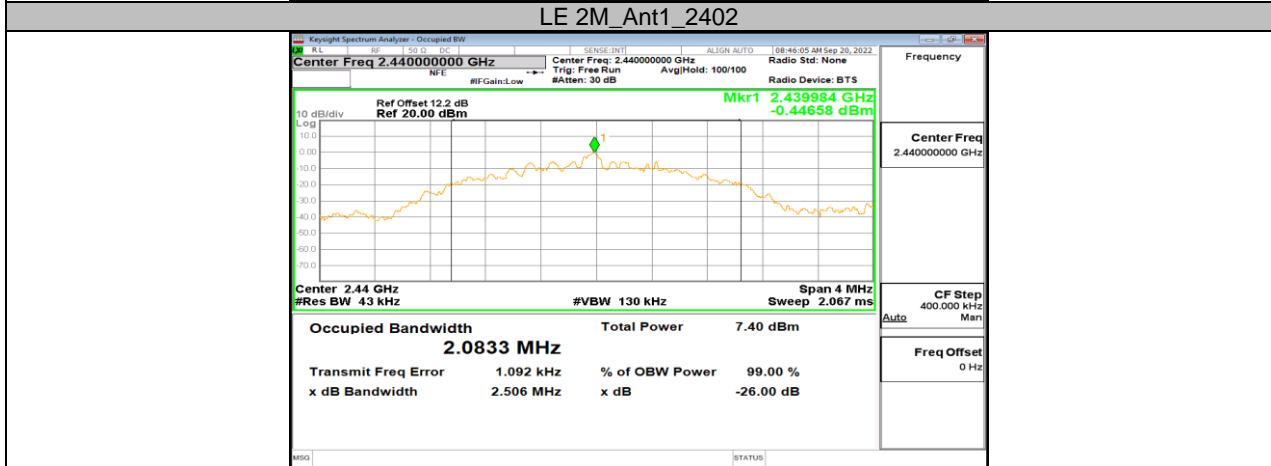
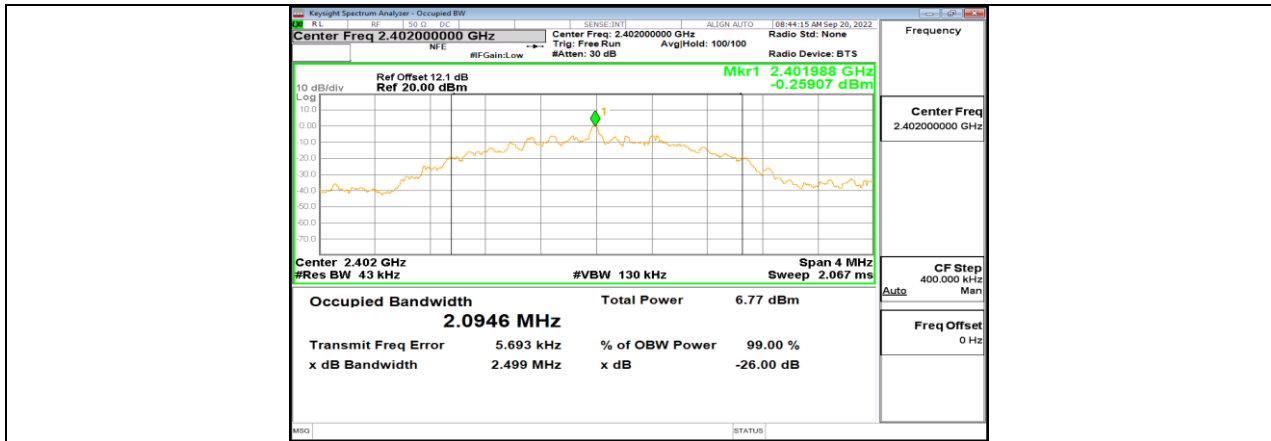



10.3. APPENDIX C: MAXIMUM PEAK CONDUCTED OUTPUT POWER

10.3.1. Test Result

Test Mode	Antenna	Channel	Result[dBm]	Limit[dBm]	Verdict
LE 1M	Ant1	2402	0.25	≤30	PASS
		2440	0.49	≤30	PASS
		2480	0.38	≤30	PASS
LE 2M	Ant1	2402	0.12	≤30	PASS
		2440	0.19	≤30	PASS
		2480	-0.06	≤30	PASS

Note: 1. Conducted Power=Meas. Level+ Correction Factor

2. The Duty Cycle Factor (refer to section 7.5) had already compensated to the test data.



10.4. APPENDIX D: MAXIMUM POWER SPECTRAL DENSITY

10.4.1. Test Result

Test Mode	Antenna	Channel	Result[dBm/3kHz]	Limit[dBm/3kHz]	Verdict
LE 1M	Ant1	2402	-12.73	≤8.00	PASS
		2440	-12.25	≤8.00	PASS
		2480	-12.78	≤8.00	PASS
LE 2M	Ant1	2402	-12.00	≤8.00	PASS
		2440	-14.13	≤8.00	PASS
		2480	-14.87	≤8.00	PASS



10.4.2. Test Graphs

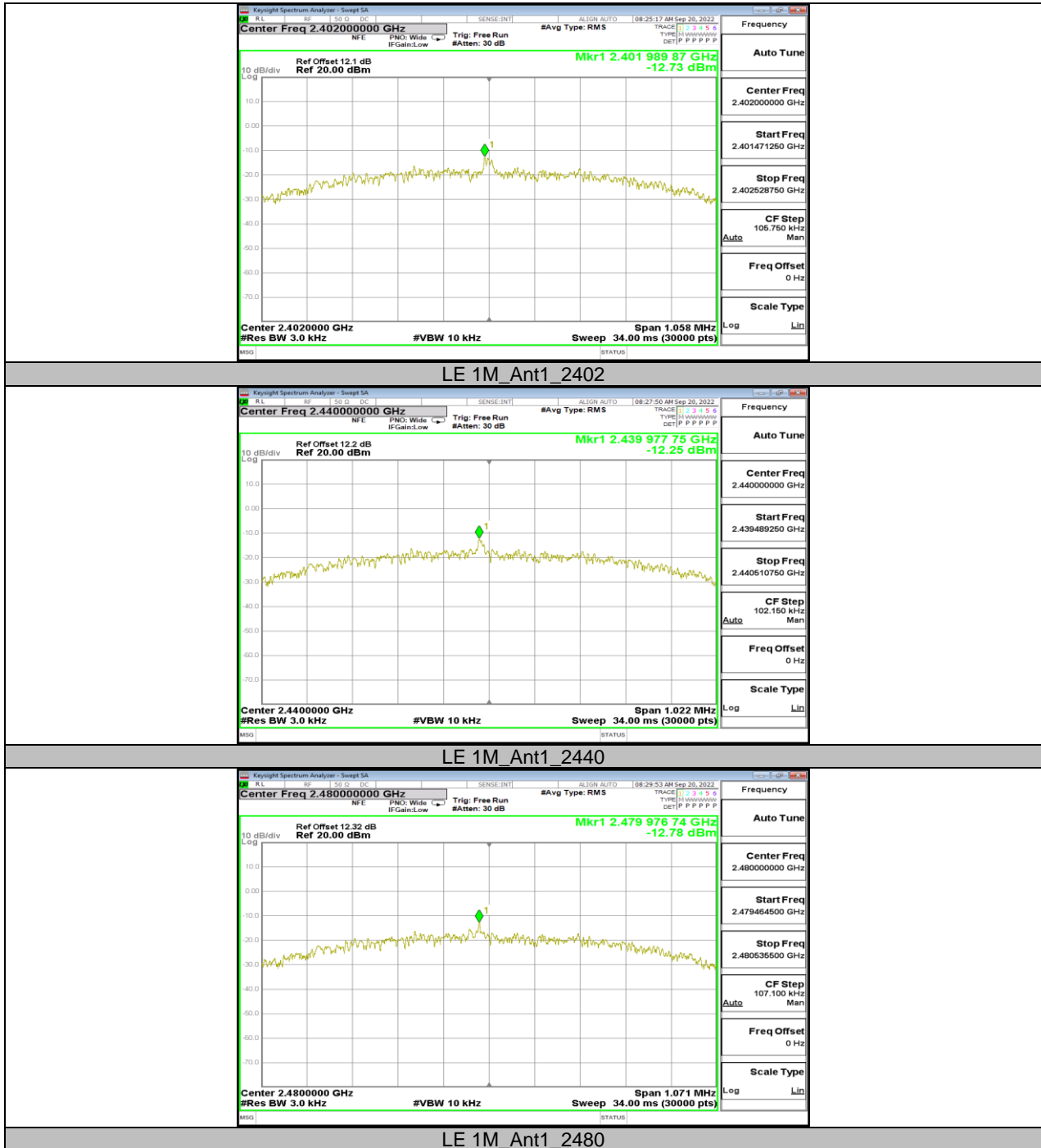

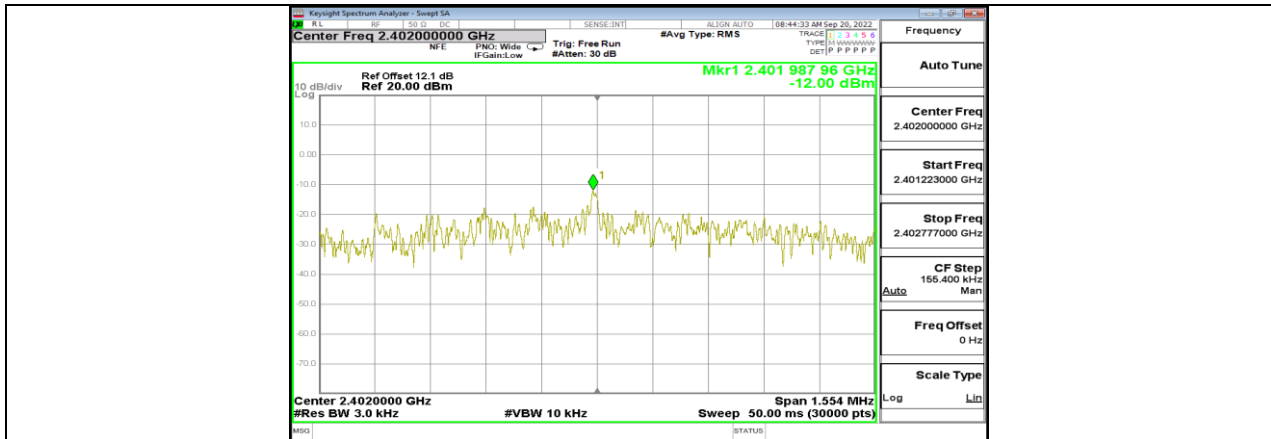

LE 2M_Ant1_2402

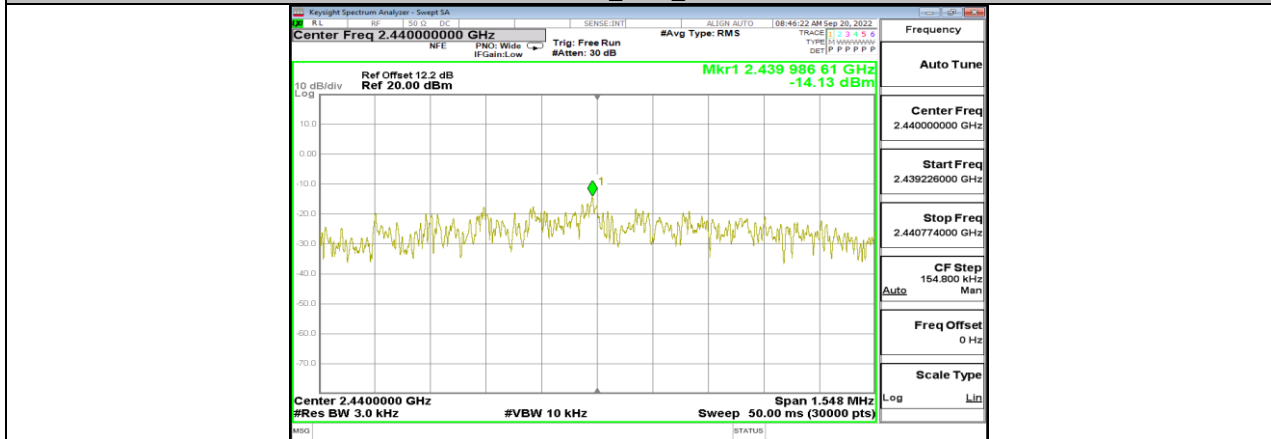

LE 2M_Ant1_2440

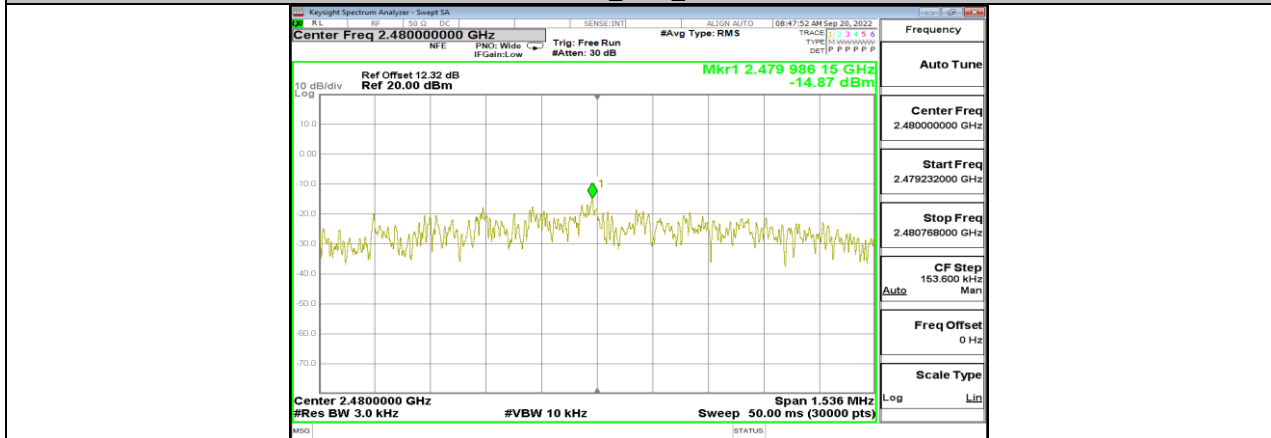

LE 2M_Ant1_2480



10.5. APPENDIX E: BAND EDGE MEASUREMENTS

10.5.1. Test Result

Test Mode	Antenna	ChName	Channel	RefLevel[dBm]	Result[dBm]	Limit[dBm]	Verdict
LE 1M	Ant1	Low	2402	0.01	-38.07	≤ -19.99	PASS
		High	2480	0.10	-41.81	≤ -19.9	PASS
LE 2M	Ant1	Low	2402	-0.21	-34.53	≤ -20.21	PASS
		High	2480	-0.37	-41.82	≤ -20.37	PASS



10.5.2. Test Graphs

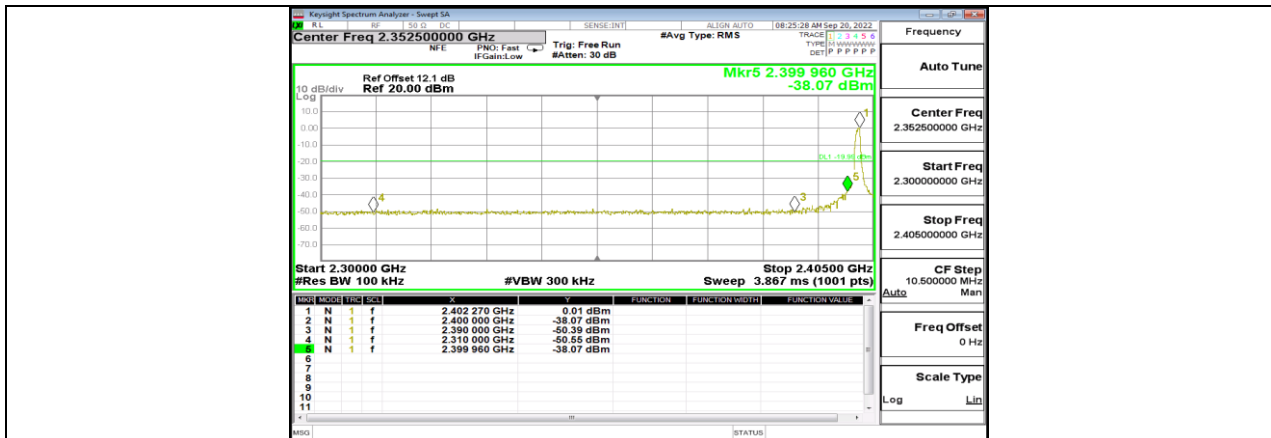

LE 1M_Ant1_Low_2402

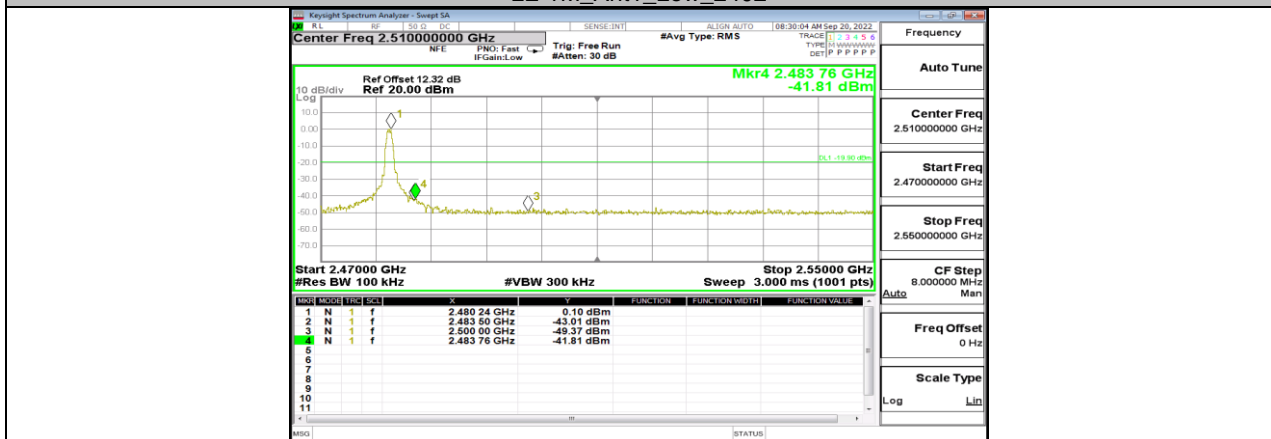

LE 1M_Ant1_High_2480

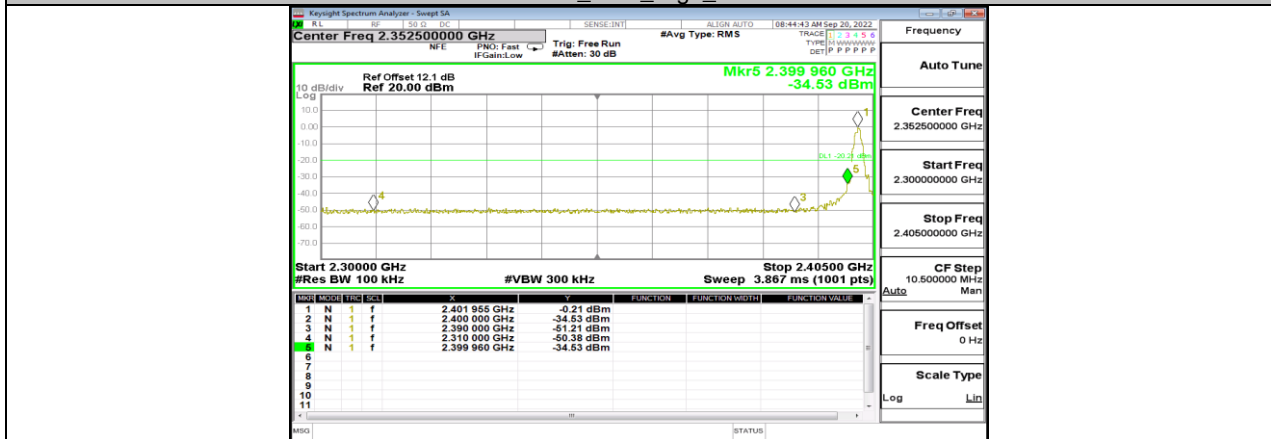

LE 2M_Ant1_Low_2402

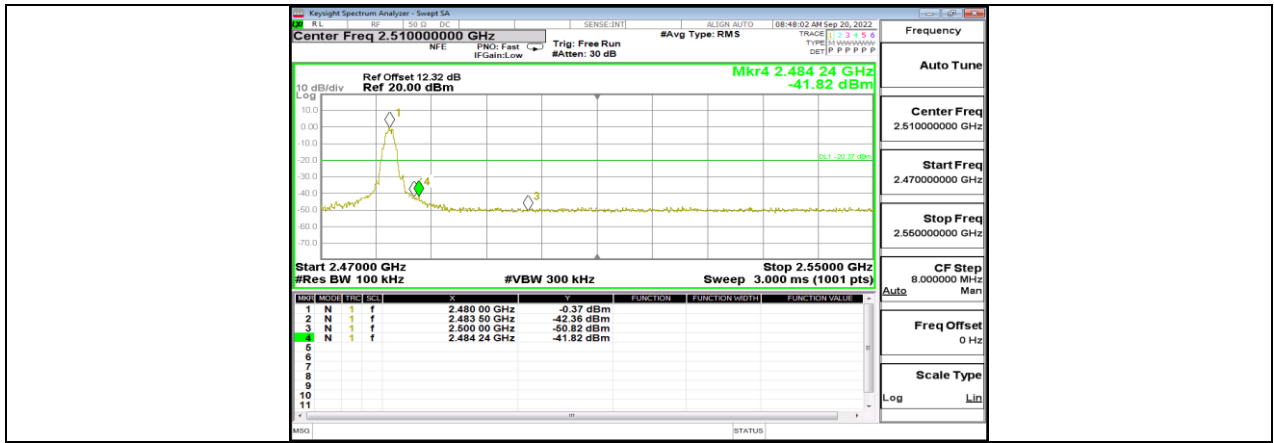

LE 2M_Ant1_High_2480

**10.6. APPENDIX F: CONDUCTED SPURIOUS EMISSION****10.6.1. Test Result**

Test Mode	Antenna	Channel	FreqRange [MHz]	Result[dBm]	Limit[dBm]	Verdict
LE 1M	Ant1	2402	Reference	-0.01	---	PASS
			30~1000	-51.84	≤-20.01	PASS
			1000~26500	-51.62	≤-20.01	PASS
		2440	Reference	0.18	---	PASS
			30~1000	-51.3	≤-19.82	PASS
			1000~26500	-51.96	≤-19.82	PASS
		2480	Reference	-0.11	---	PASS
			30~1000	-50.94	≤-20.11	PASS
			1000~26500	-51.6	≤-20.11	PASS
LE 2M	Ant1	2402	Reference	-0.33	---	PASS
			30~1000	-50.93	≤-20.33	PASS
			1000~26500	-51.87	≤-20.33	PASS
		2440	Reference	-0.12	---	PASS
			30~1000	-51.28	≤-20.12	PASS
			1000~26500	-50.93	≤-20.12	PASS
		2480	Reference	-0.38	---	PASS
			30~1000	-50.82	≤-20.38	PASS
			1000~26500	-51.59	≤-20.38	PASS



10.6.2. Test Graphs

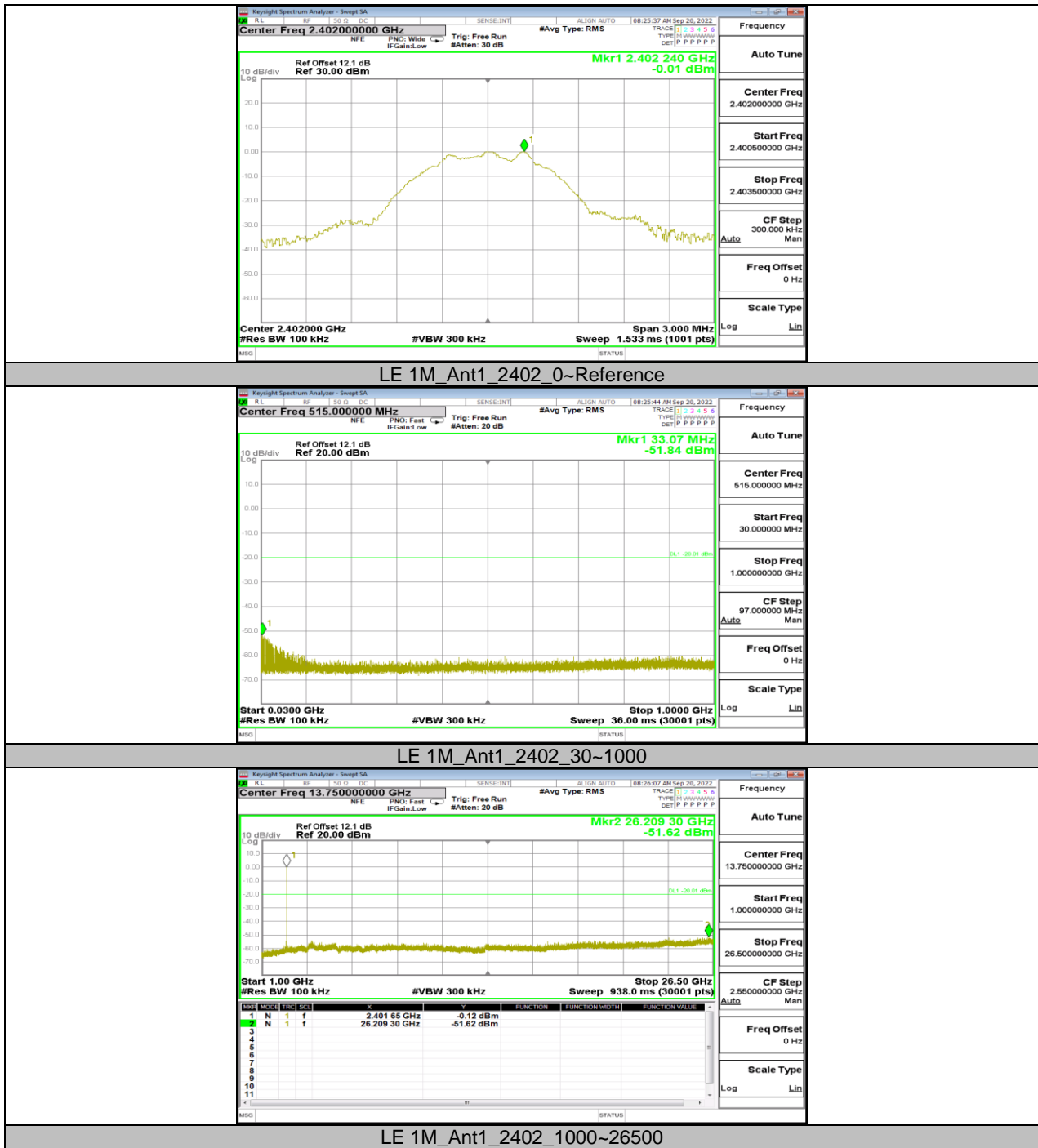

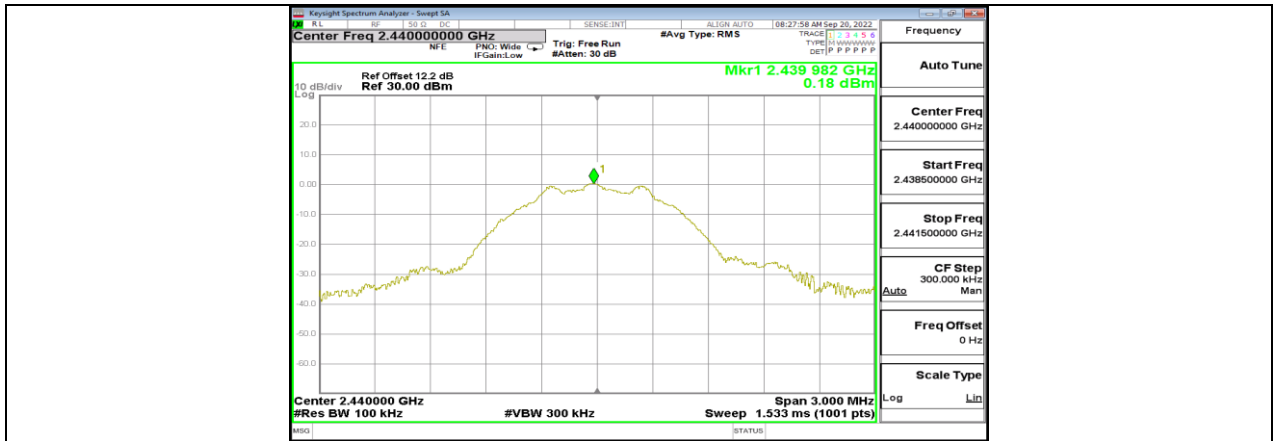

LE 1M_Ant1_2440_0~Reference

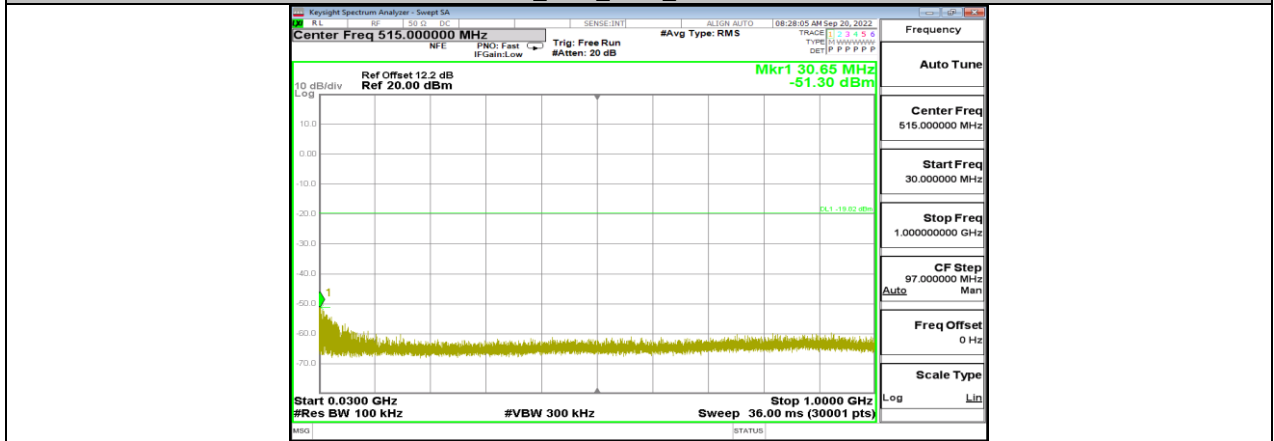

LE 1M_Ant1_2440_30~1000

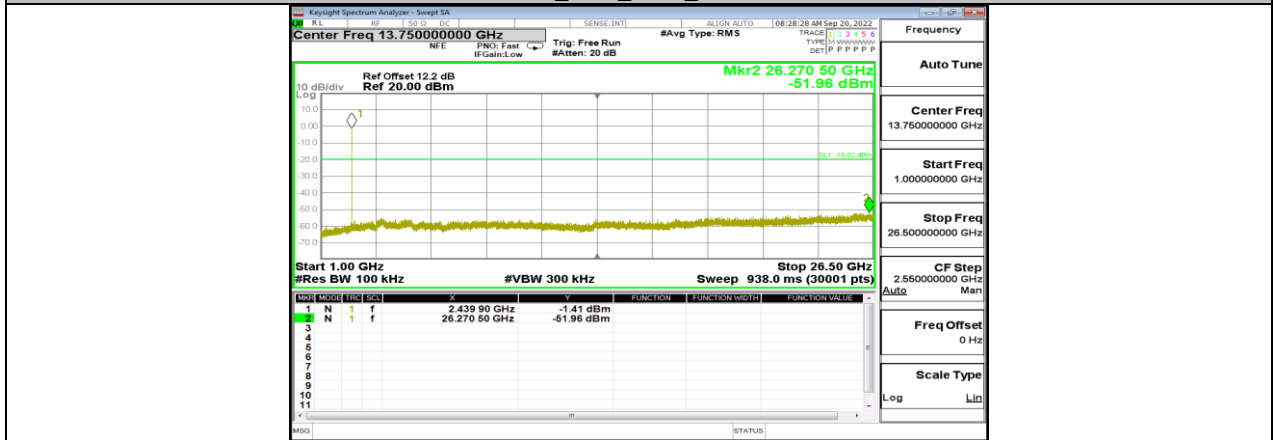

LE 1M_Ant1_2440_1000~26500

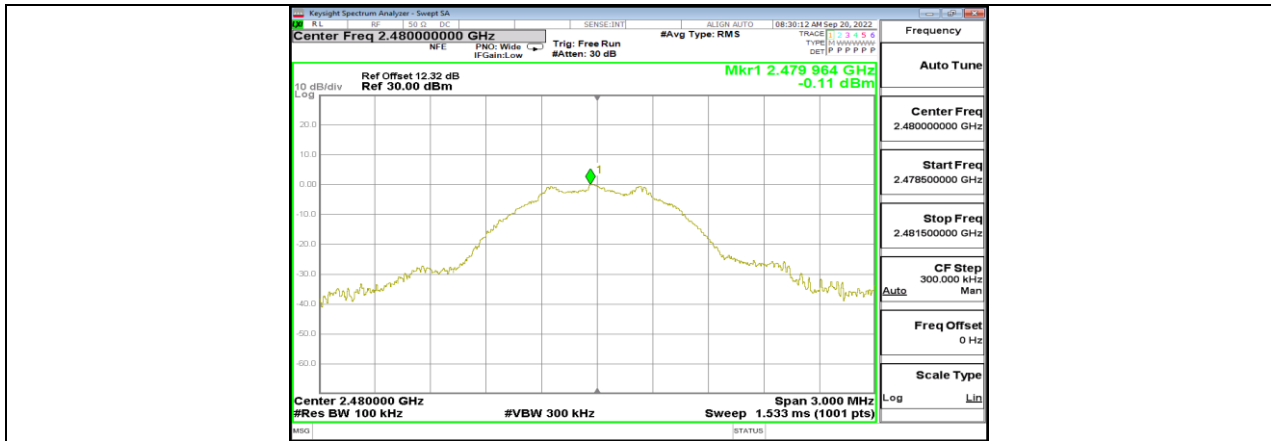

LE 1M_Ant1_2480_0~Reference

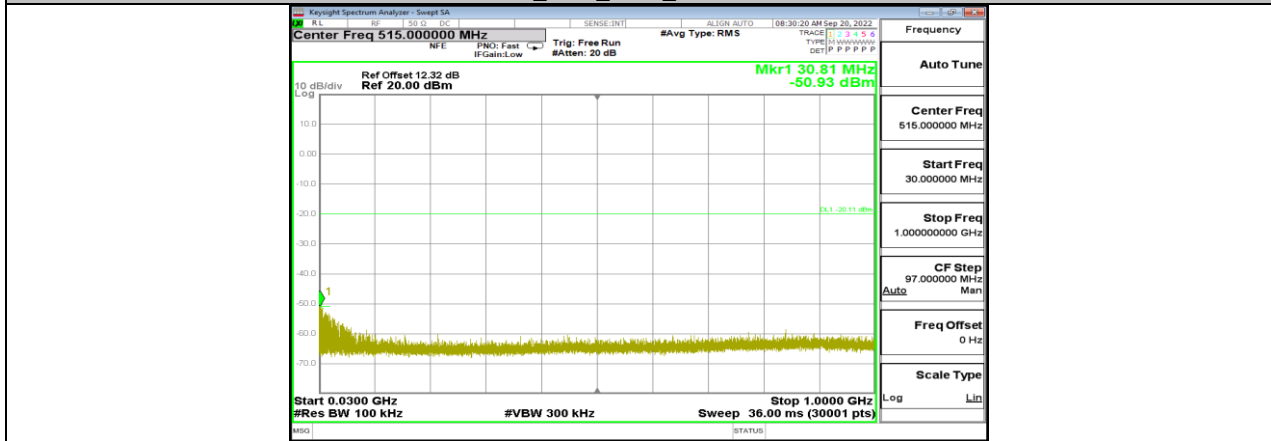

LE 1M_Ant1_2480_30~1000

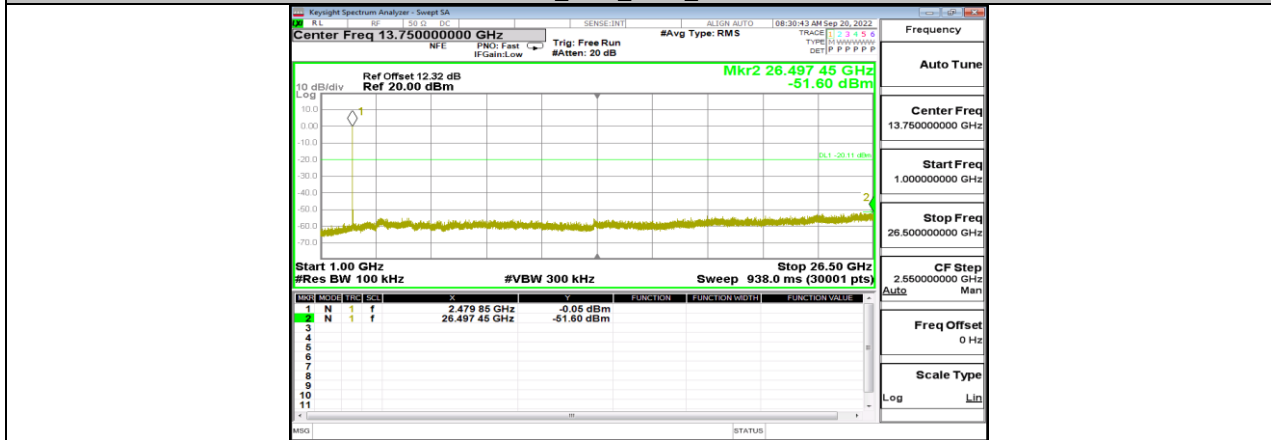

LE 1M_Ant1_2480_1000~26500

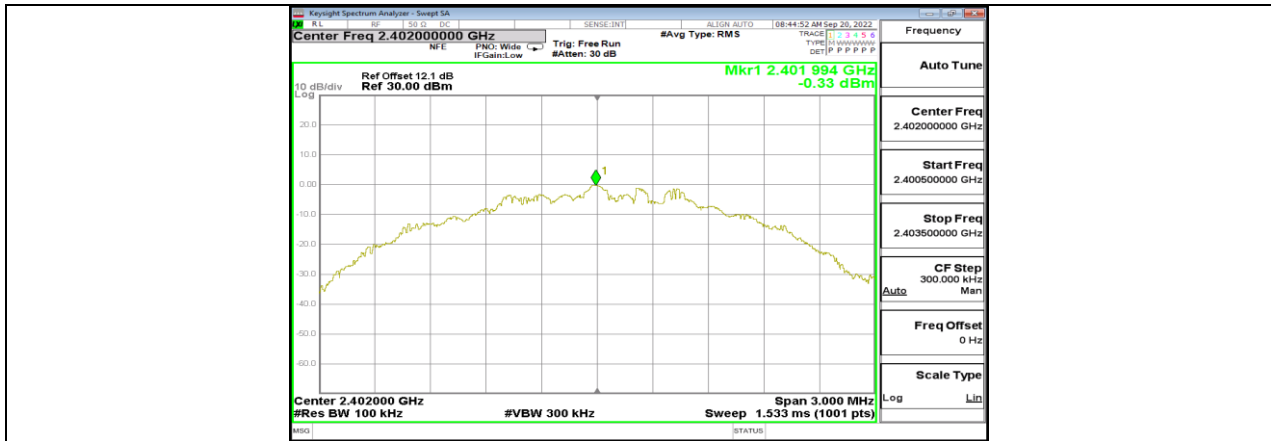

LE 2M_Ant1_2402_0~Reference

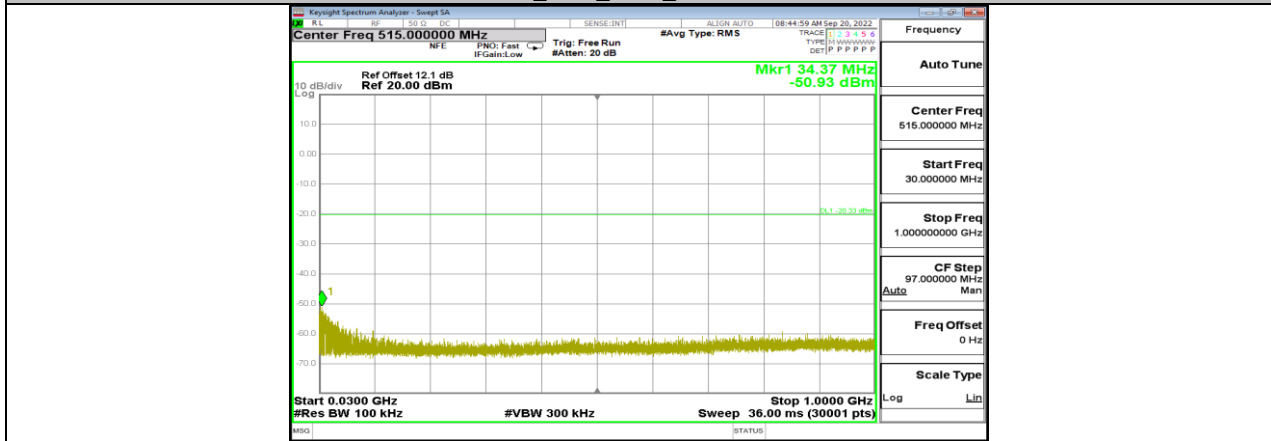

LE 2M_Ant1_2402_30~1000

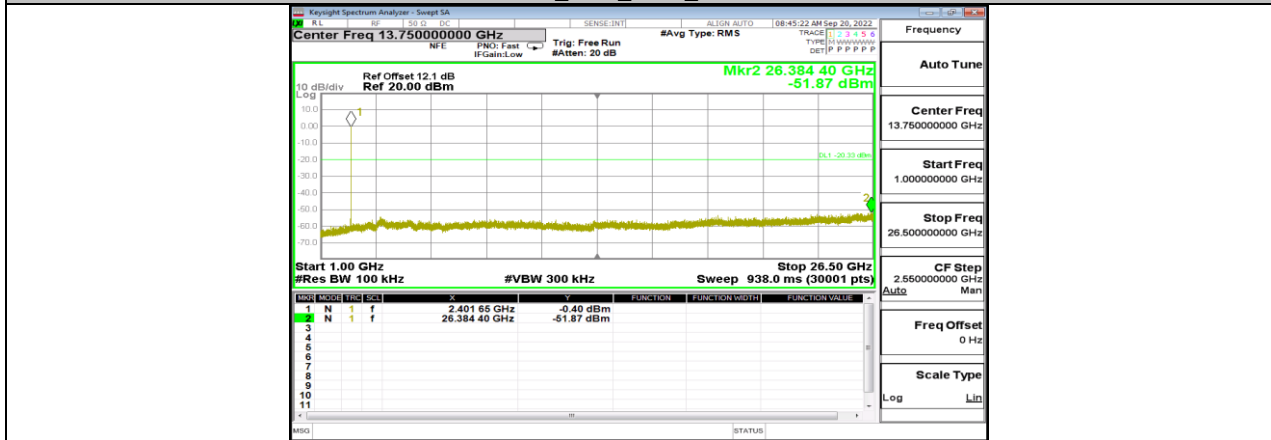

LE 2M_Ant1_2402_1000~26500

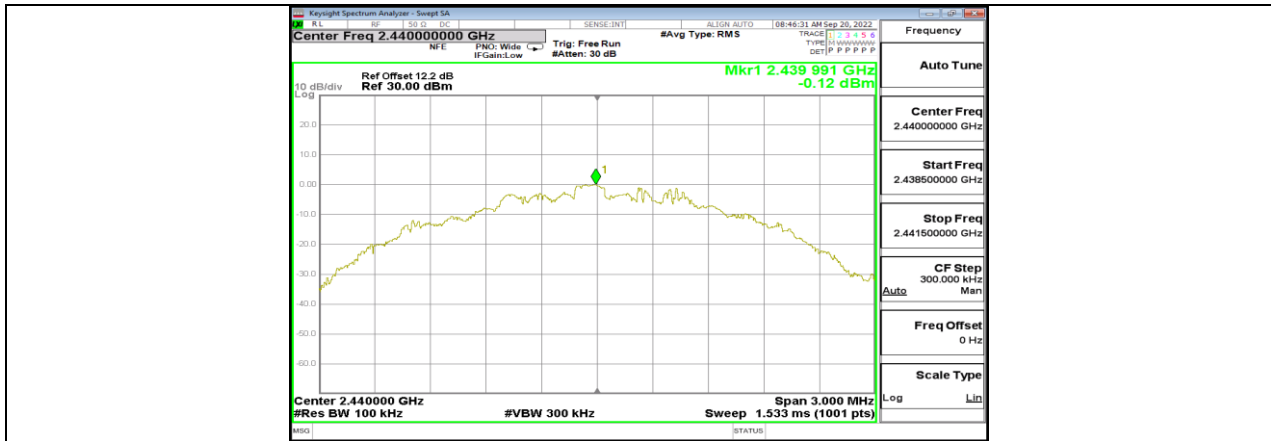

LE 2M_Ant1_2440_0~Reference

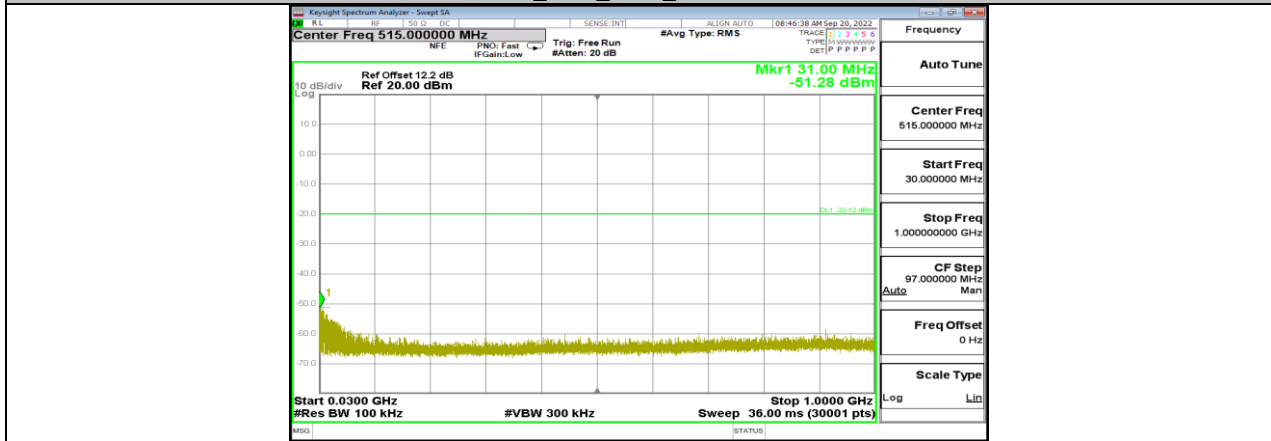

LE 2M_Ant1_2440_30~1000

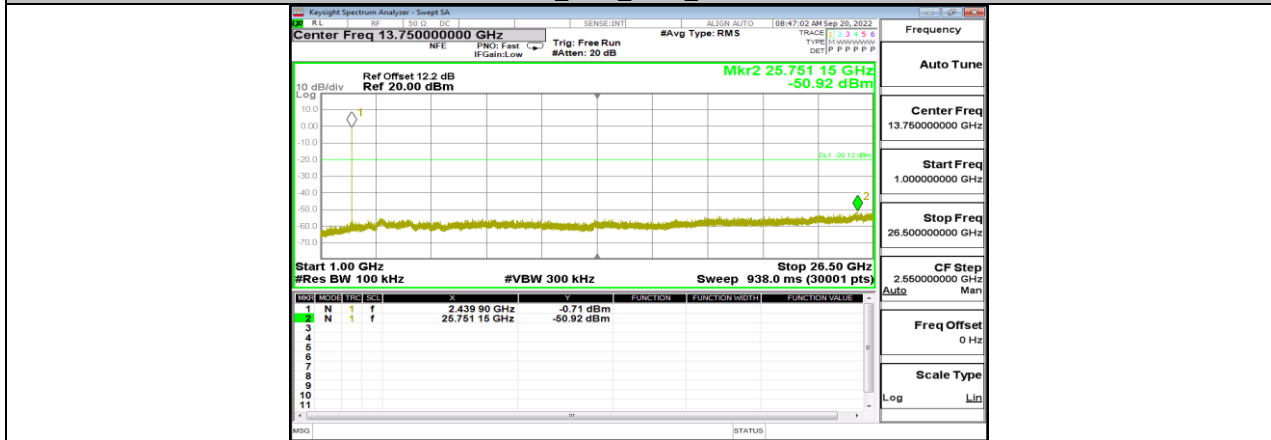

LE 2M_Ant1_2440_1000~26500

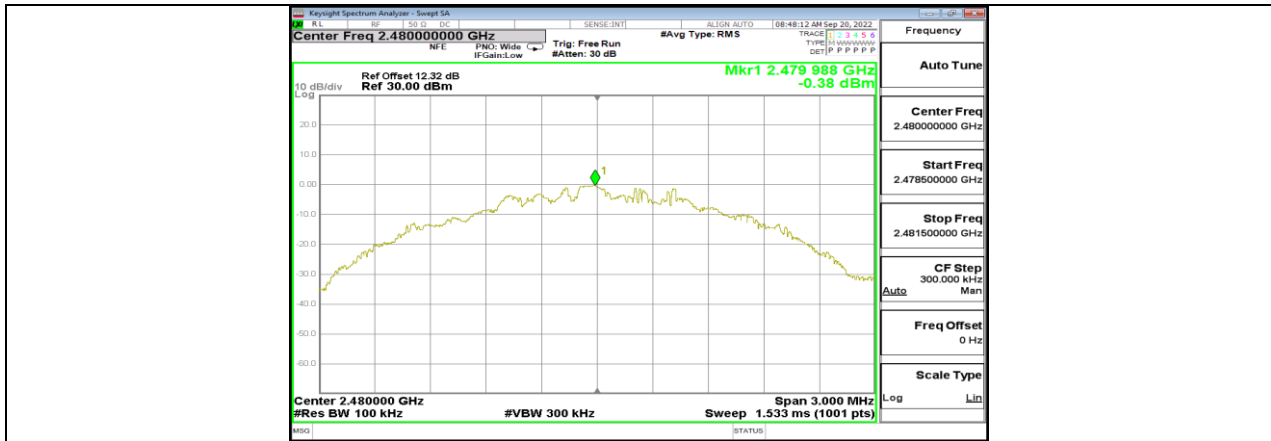

LE 2M_Ant1_2480_0~Reference

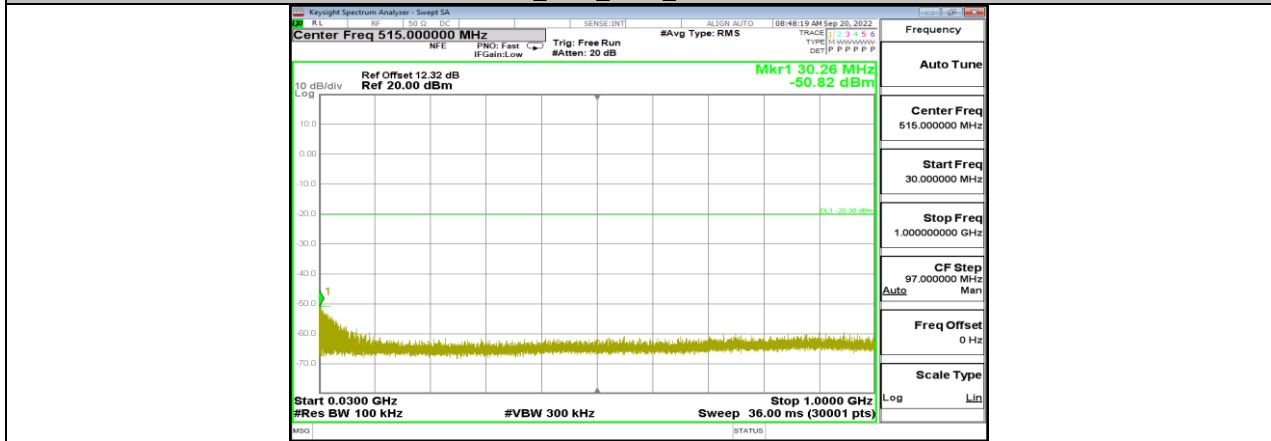

LE 2M_Ant1_2480_30~1000

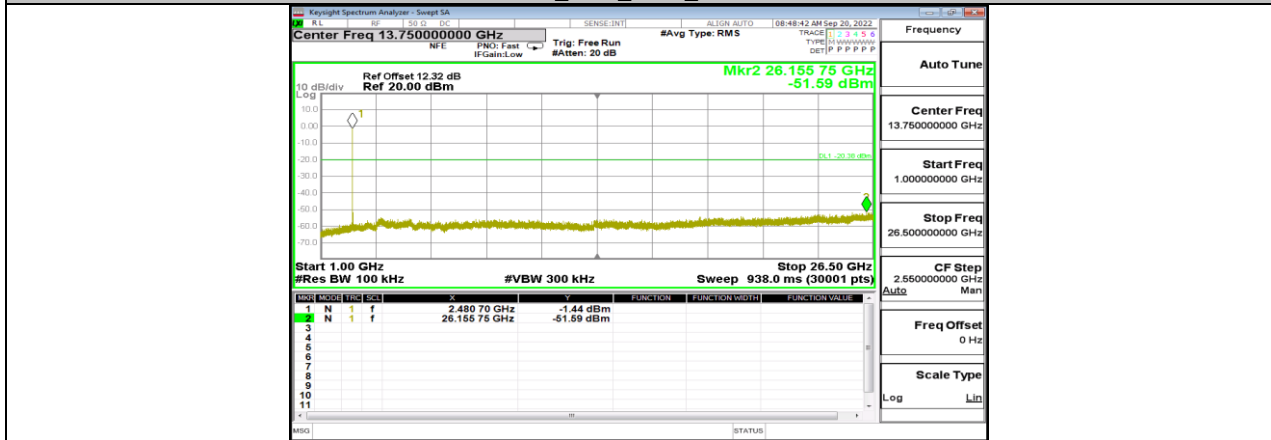

LE 2M_Ant1_2480_1000~26500



10.7. APPENDIX G: DUTY CYCLE

10.7.1. Test Result

Test Mode	On Time (msec)	Period (msec)	Duty Cycle x (Linear)	Duty Cycle (%)	Duty Cycle Correction Factor (dB)	1/T Minimum VBW (kHz)	Final setting For VBW (kHz)
LE 1M	2.17	2.5	0.8680	86.80	0.61	0.46	0.5
LE 2M	1.12	1.87	0.5989	59.89	2.23	0.89	1

Note:

Duty Cycle Correction Factor=10log (1/x).

Where: x is Duty Cycle (Linear)

Where: T is On Time

If that calculated VBW is not available on the analyzer then the next higher value should be used.

10.7.2. Test Graphs



END OF REPORT