

Tune Up

Specific Operating Power Range:

GSM850 Band:

Power Class 1;

Power Control Level 5	+33dBm	+2.0dB/-2.0dB
Power Control Level 6	+31dBm	+2.0dB/-2.0dB
Power Control Level 7	+29dBm	+2.0dB/-2.0dB
Power Control Level 8	+27dBm	+2.0dB/-2.0dB
Power Control Level 9	+25dBm	+2.0dB/-2.0dB
Power Control Level 10	+23dBm	+2.0dB/-2.0dB
Power Control Level 11	+21dBm	+2.0dB/-2.0dB
Power Control Level 12	+19dBm	+2.0dB/-2.0dB
Power Control Level 13	+17dBm	+2.0dB/-2.0dB
Power Control Level 14	+15dBm	+2.0dB/-2.0dB
Power Control Level 15	+13dBm	+2.0dB/-2.0dB
Power Control Level 16	+11dBm	+2.0dB/-2.0dB
Power Control Level 17	+9dBm	+2.0dB/-2.0dB
Power Control Level 18	+7dBm	+2.0dB/-2.0dB
Power Control Level 19	+5dBm	+2.0dB/-2.0dB

GSM1900 Band:

Power Class 1;

Power Control Level 0	+30dBm	+2.0dB/-2.0dB
Power Control Level 1	+28dBm	+3.0dB/-3.0dB
Power Control Level 2	+26dBm	+3.0dB/-3.0dB
Power Control Level 3	+24dBm	+3.0dB/-3.0dB
Power Control Level 4	+22dBm	+3.0dB/-3.0dB
Power Control Level 5	+20dBm	+3.0dB/-3.0dB
Power Control Level 6	+18dBm	+3.0dB/-3.0dB
Power Control Level 7	+16dBm	+3.0dB/-3.0dB
Power Control Level 8	+14dBm	+3.0dB/-3.0dB
Power Control Level 9	+12dBm	+4.0dB/-4.0dB
Power Control Level 10	+10dBm	+4.0dB/-4.0dB
Power Control Level 11	+8dBm	+4.0dB/-4.0dB
Power Control Level 12	+6dBm	+4.0dB/-4.0dB
Power Control Level 13	+4dBm	+4.0dB/-4.0dB
Power Control Level 14	+2dBm	+5.0dB/-5.0dB
Power Control Level 15	+0dBm	+5.0dB/-5.0dB

Note; Effective radiation efficiency is -3.7dB

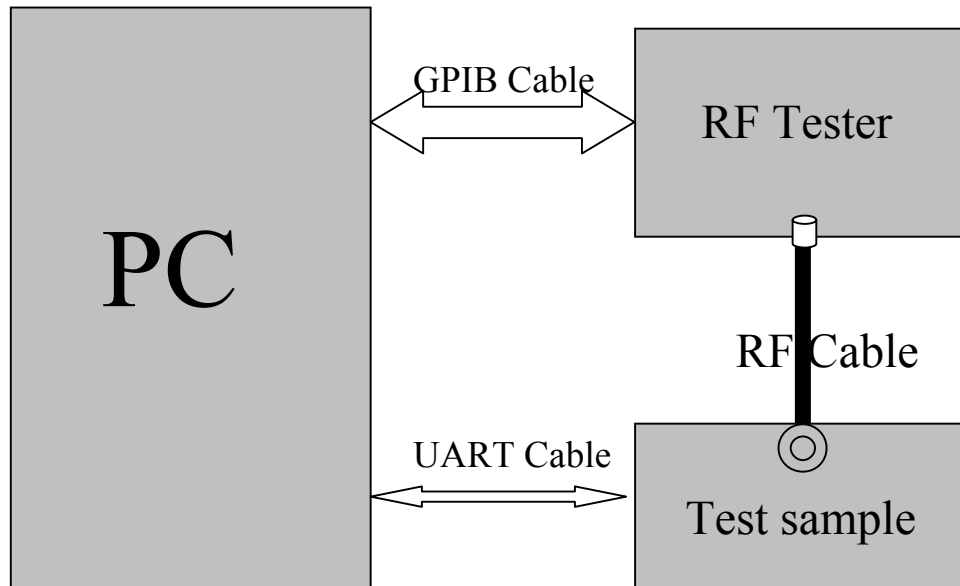

Figure 1

1 Adjustment of RF Output Power:

(1) The equipment setup as shown in Figure 1.

(2) Operation of PC adjusts equipment.

(3) Use RF Engineering Tools at PC side.

Select GSM850 Band:

- 1) Set GSM850 Band.
- 2) Set ARFCN: 190
- 3) TX ON.
- 4) Adjust the power to 32.4dBm (+1.0dB/-1.0dB, Power control level: PCL=5) by PA DAC value.
- 5) Repeat 4) for 15 times, and adjust the power level to 30.5, 28.8, 27, 25, 23, 21, 19, 17, 15, 13, 11, 9, 7, 5.
- 6) Make 16 Ramp-Up/Ramp-Down data from the adjustment value of (5) and (6).

7) Data of 5) and 6) is written to flash memory.

Select PCS1900 Band:

- 1) Set PCS Band.
- 2) Set ARFCN: 661.
- 3) TX ON.
- 4) Adjust the power to 29.0 dBm (+2.0dB/-2.0dB, Power control level: PCL=0) by PA DAC value.
- 5) Repeat 4) for 15 times, and adjust the power level to 27.5, 26, 24, 22, 20, 18, 16, 14, 12, 10, 8, 6, 4, 2, 0.
- 6) Make 16 Ramp-Up/Ramp-Down data from the adjustment value of (5) and (6).
- 7) Data of 5) and 6) is written to flash memory.

2 Adjustment of oscillation frequency of VCXO:

(1) The equipment setup as shown in Figure 1.

(2) Use Crystal AFC Control Tools to Set CapID and AFC DAC value.

(3) Set Band=GSM850, Set ARFCN=190, Set PCL=12.

- 1) Set AFC DAC=4096, fixed. (Check that $V_{afc}=1.4V$).
- 2) Set CapID=0, and verify that frequency error $\gg 10KHz$.
- 3) Set CapID=63, and verify that frequency error $\ll -10KHz$.
- 4) If the above 3 items are verified, then change CapID value to make frequency error be closed to 0 Hz as possible, record this CapID value.
- 5) Set CapID value got from step 4), then change AFC DAC value to make frequency error be closed to 0 Hz as possible, record this AFC DAC value.
- 6) Download the CapID value and AFC DAC value to flash memory.

3 Adjustment of RX Sensitivity:

(1) Select GSM850 Band:

- 1) Set BCCH level: -85dBm; ARFCN: 128.
- 2) Test sample make a call to connect RF Tester..
- 3) Set TCH level: -106dBm.
- 4) Measure BER II error at TCH ARFCN: 128, 190, 251.
- 5) Tune up the RX matching circuit to make sure $BER II < 2\%$ at each ARFCN.

(2) Select PCS Band:

1) Set BCCH level:-85dBm;ARFCN:512.

2) Test sample make a call to connect RF Tester..

3) Set TCH level:-106dBm.

4) Measure BER II error at TCH ARFCN:512, 661, 810.

5) Tuen up the RX matching cricuit to make sure BER II <2% at each ARFCN.

2.2 Product Information-BT

Product	GSM mobile phone
Trade Name	Plum
Model Number	C100
Series Number:	N/A
Description of Differences:	N/A
Power Supply	DC 5V by AC/DC adapter 100-240V~50/60Hz DC 3.7V by battery
Frequency Range	2402MHz -2480MHz
Modulation Type	FHSS
Antenna Type:	Internal Fixed
Channel Spacing:	1MHz
Channel Number	79(CH Low: 2402MHz, CH Mid: 2441MHz, CH High: 2480MHz)
Temperature Range	-20°C ~ 50°C