



# FCC TEST REPORT

According to

## FCC Rules and Regulations Part 15 Subpart C

Applicant	: Amped Wireless
Address	: 13089 Peyton Dr. #C307, Chino Hills CA 91709
Equipment	: High Power Wireless-N Dual Band Directional USB Adapter
Model No.	: UA2000
Trade Name	: Amped Wireless
FCC ID	: ZTT-UA2000

- The test result refers exclusively to the test presented test model / sample.,
- Without written approval of **CerpPASS Technology Corp.**, the test report shall not be reproduced except in full.
- The EUT is also considered as a kind of computer peripheral, because the connection to computer is necessary for typical use. It has been verified to comply with the requirements of FCC Part 15, Subpart B, Class B (DoC). The test report has been issued separately.



## Contents

<b>1. Report of Measurements and Examinations</b>	<b>6</b>
1.1 List of Measurements and Examinations	6
<b>2. Test Configuration of Equipment under Test</b>	<b>7</b>
2.1 Feature of Equipment under Test	7
2.2 Carrier Frequency of Channels	7
2.3 Test Mode and Test Software	8
2.4 Description of Test System	8
2.5 General Information of Test	9
2.6 Measurement Uncertainty	9
<b>3. Antenna Requirements</b>	<b>10</b>
3.1 Standard Applicable	10
3.2 Antenna Construction and Directional Gain	10
<b>4. Test of Conducted Emission</b>	<b>11</b>
4.1 Test Limit	11
4.2 Test Procedures	11
4.3 Typical Test Setup	12
4.4 Measurement Equipment	12
4.5 Test Result and Data	13
4.6 Test Photographs	25
<b>5. Test of Radiated Emission</b>	<b>26</b>
5.1 Test Limit	26
5.2 Test Procedures	26
5.3 Typical Test Setup	27
5.4 Measurement Equipment	27
5.5 Test Result and Data (9kHz ~ 30MHz)	28
5.6 Test Result and Data	28
5.7 Test Photographs (30MHz~1000MHz)	92
5.8 Test Photographs (1000MHz~40000MHz)	93
<b>6. 6dB Bandwidth Measurement Data</b>	<b>94</b>
6.1 Test Limit	94
6.2 Test Procedures	94
6.3 Test Setup Layout	94
6.4 Measurement Equipment	94
6.5 Test Result and Data	95
<b>7. Maximum Peak and Average Output Power</b>	<b>116</b>
7.1 Test Limit	116
7.2 Test Procedures	116
7.3 Test Setup Layout	116
7.4 Measurement Equipment	116
7.5 Test Result and Data	117
<b>8. Power Spectral Density</b>	<b>159</b>
8.1 Test Limit	159
8.2 Test Procedures	159



8.3 Test Setup Layout ..... 159

8.4 Measurement Equipment..... 159

8.5 Test Result and Data..... 160

**9. Band Edges Measurement ..... 181**

9.1 Test Limit ..... 181

9.2 Test Procedure ..... 181

9.3 Test Setup Layout ..... 181

9.4 Measurement Equipment..... 181

9.5 Test Result and Data..... 182

9.6 Restrict Band Emission Measurement Data ..... 212

**10. Restricted Bands of Operation ..... 214**

10.1 Labeling Requirement..... 214

**Appendix A. Photographs of EUT..... A1 ~ A5**



**History of this test report**

ORIGINAL.

Additional attachment as following record:

Attachment No.	Issue Date	Description
TEF1205119	Jun. 20, 2012	Original.



# CERTIFICATE OF COMPLIANCE

According to

## FCC Rules and Regulations

### Part 15 Subpart C

Applicant : Amped Wireless  
Address : 13089 Peyton Dr. #C307, Chino Hills CA 91709  
Equipment : High Power Wireless-N  
Dual Band Directional USB Adapter  
Model No. : UA2000  
FCC ID : ZTT-UA2000

**I HEREBY CERTIFY THAT :**

The measurements shown in this test report were made in accordance with the procedures given in **ANSI C63.4 2009, KDB558074 & KDB662911**. The equipment was **passed** the test performed according to **FCC Rules and Regulations Part 15 Subpart C (2010)**.

The test was carried out on Jun. 14, 2012 at CerpPASS Technology Corp.

Approved by:

Tested by:

Hill Chen  
EMC/RF B.U. Assistant Manager

Ben Lu  
Engineer



# 1. Report of Measurements and Examinations

## 1.1 List of Measurements and Examinations

FCC Rule	Description of Test	Result
15.203	. Antenna Requirement	Pass
15.207	. Conducted Emission	Pass
15.209 15.247(d)	. Radiated Emission	Pass
15.247(a)(2)	. 6dB Bandwidth	Pass
15.247(b)	. Maximum Peak Output Power	Pass
15.247(d)	. 100kHz Bandwidth of Frequency Band Edges	Pass
15.247(e)	. Power Spectral Density	Pass
1.1307 1.1310 2.1091 2.1093	. RF Exposure Compliance	Pass



## 2. Test Configuration of Equipment under Test

### 2.1 Feature of Equipment under Test

- Wireless Standard: 802.11a/b/g/n
- Frequency Band: 2.4GHz, 5.0GHz
- Security: WEP, WPA, WPA2, WPA Mixed, WPS
- Data Rate: 802.11b: 11Mbps, 802.11g: 54Mbps, 802.11a: 54Mbps  
802.11n HT20: 130Mbps, 802.11n HT40: 270Mbps
- Wireless Sensitivity: -95dBm(Max)
- Wireless Output Power: 26dBm(Max)
- Amplifier: Dual Low Noise Amplifier  
Dual 2.4GHz Power Amplifiers  
Dual 5.0GHz Power Amplifiers
- Antenna: 1x High Gain Dual Band, Dual Polarity Directional Antenna
- Interface: USB2.0

### 2.2 Carrier Frequency of Channels

802.11b, 802.11g, 802.11n HT 20(2412MHz~2462MHz)

Channel	Frequency(MHz)	Channel	Frequency(MHz)
01	2412	07	2442
02	2417	08	2447
03	2422	09	2452
04	2427	10	2457
05	2432	11	2462
06	2437	---	---

802.11n, HT 40(2422MHz~2452MHz)

Channel	Frequency(MHz)	Channel	Frequency(MHz)
03	2422	07	2442
04	2427	08	2447
05	2432	09	2452
06	2437	---	---

802.11a, 802.11an HT 20(5725MHz~5850MHz)

Channel	Frequency(MHz)	Channel	Frequency(MHz)
149	5745	161	5805
153	5765	165	5825
157	5785	---	---

802.11an HT 40(5755MHz~5795MHz)

Channel	Frequency(MHz)	Channel	Frequency(MHz)
151	5755	159	5795



### 2.3 Test Mode and Test Software

- a. During testing, the interface cables and equipment positions were varied according to ANSI C63.4.
- b. The complete test system included Notebook and EUT for RF test.
- c. An executive program "QA.Test" under XP was executed to keep transmitting and receiving data via Wireless.
- d. The following test modes were performed for test:
  - 802.11b/g/n HT20: CH01: 2412MHz, CH06: 2437MHz, CH11: 2462MHz
  - 802.11n HT40: CH03: 2422MHz, CH06: 2437MHz, CH09: 2452MHz
  - 802.11a/ an HT20: CH149: 5745MHz, CH157: 5785MHz, CH165: 5825MHz
  - 802.11an HT40: CH151: 5755MHz, CH159: 5795MHz

### 2.4 Description of Test System

Device	Manufacturer	Model No.	Description
Notebook	DELL	INSPIRON 510m	Power Cable, Unshielding 1.8m





## 2.5 General Information of Test

Test Site :	CerpPASS Technology Corp. 2F-11, No. 3, Yuan Qu St., (Nankang Software Park), Taipei, Taiwan 115, R.O.C.
Test Site Location (OATS2-SD) :	No.68-1, Shihbachongsi, Shihding Township, Taipei City 223, Taiwan, R.O.C.
FCC Registration Number :	TW1049, TW1061, 488071, 390316
IC Registration Number :	4934B-1, 4934D-1
VCCI Registration Number :	T-1173 for Telecommunication Test C-4139 for Conducted emission test R-3428 for Radiated emission test G-97 for radiated disturbance above 1GHz
Frequency Range Investigated:	Conducted: from 150kHz to 30MHz Radiation: from 30MHz to 40,000MHz
Test Distance:	The test distance of radiated emission from antenna to EUT is 3 M.



## 2.6 Measurement Uncertainty

Measurement Item	Uncertainty
Radiated emission	$\pm 4.11$ dB
Peak Output Power(conducted)	$\pm 1.38$ dB
Peak Output Power(Radiated)	$\pm 1.70$ dB
Power Spectral Density	$\pm 1.39$ dB
Radiated emission(3m)	$\pm 4.11$ dB
Radiated emission(10m)	$\pm 3.89$ dB



### 3. Antenna Requirements

#### 3.1 Standard Applicable

For intentional device, according to FCC 47 CFR Section 15.203, an intentional radiator shall be designed to ensure that no antenna other than that furnished by the responsible party shall be used with the device.

And according to FCC 47 CFR Section 15.247 (b), if transmitting antennas of directional gain greater than 6dBi are used, the power shall be reduced by the amount in dB that the directional gain of the antenna exceeds 6dBi.

#### 3.2 Antenna Construction and Directional Gain

##### 802.11b/g/n:

ANT R, ANT L

Antenna Type: PCB Antenna

Antenna Gain: 4 dBi

Note: Directional gain =  $G_{ANT} + 10 \log(N)$  dBi =  $4 + 10 \log(2) = 7.01$  (dBi)

##### 802.11a, an:

ANT R, ANT L

Antenna Type: PCB Antenna

Antenna Gain: 6 dBi

Note: Directional gain =  $G_{ANT} + 10 \log(N)$  dBi =  $6 + 10 \log(2) = 9.01$  (dBi)



## 4. Test of Conducted Emission

### 4.1 Test Limit

Conducted Emissions were measured from 150 kHz to 30 MHz with a bandwidth of 9 KHz on the 120 VAC power and return leads of the EUT according to the methods defined in ANSI C63.4-2009 Section 3.1. The EUT was placed on a nonmetallic stand in a shielded room 0.8 meters above the ground plane as shown in section 2.2. The interface cables and equipment positioning were varied within limits of reasonable applications to determine the position produced maximum conducted emissions.

Frequency (MHz)	Quasi Peak (dB $\mu$ V)	Average (dB $\mu$ V)
0.15 – 0.5	66-56*	56-46*
0.5 – 5.0	56	46
5.0 – 30.0	60	50

\*Decreases with the logarithm of the frequency.

### 4.2 Test Procedures

- a. The EUT was placed 0.4 meter from the conducting wall of the shielding room was kept at least 80 centimeters from any other grounded conducting surface.
- b. Connect EUT to the power mains through a line impedance stabilization network (LISN).
- c. All the support units are connecting to the other LISN.
- d. The LISN provides 50 ohm coupling impedance for the measuring instrument.
- e. The FCC states that a 50 ohm, 50 micro-Henry LISN should be used.
- f. Both sides of AC line were checked for maximum conducted interference.
- g. The frequency range from 150 kHz to 30 MHz was searched.
- h. Set the test-receiver system to Peak Detect Function and Specified Bandwidth with Maximum Hold Mode.



### 4.3 Typical Test Setup

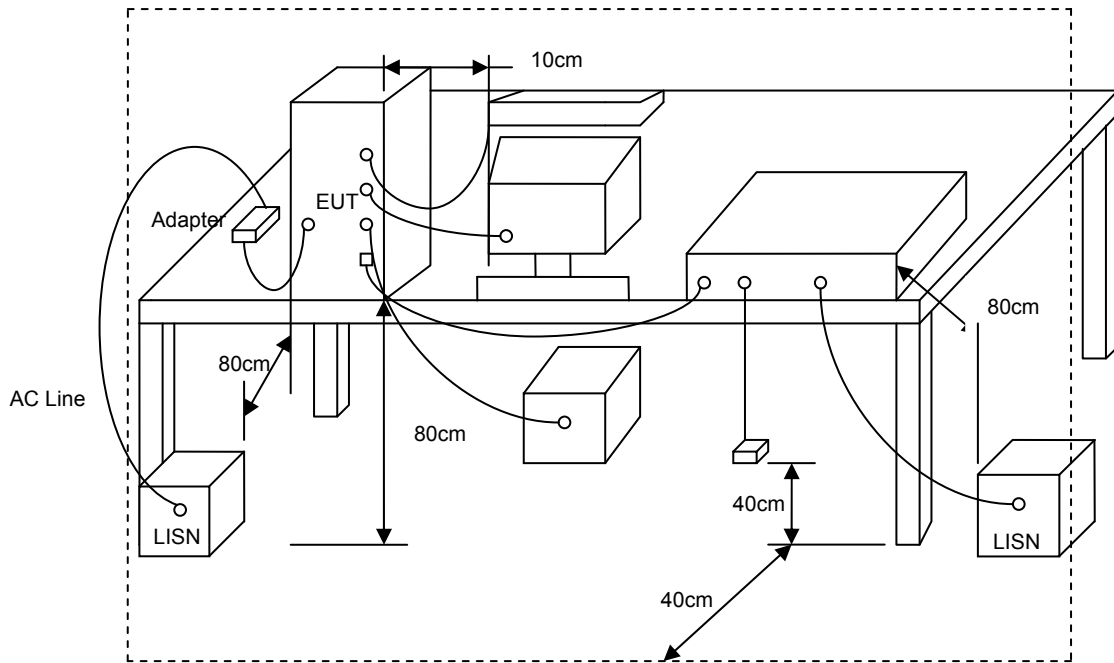

### 4.4 Measurement Equipment

Instrument/ Ancillary	Model No.	Manufacturer	Serial No.	Calibration Date	Valid Date
EMI Receiver	R&S	ESCI	100443	2012/01/12	2013/01/11
LISN	Schwarzbeck	NSLK 8127	8127-516	2012/03/08	2013/03/07
LISN	Schwarzbeck	NSLK 8127	8127-568	2011/08/24	2012/08/23



### 4.5 Test Result and Data

Power	: From System	Pol/Phase	: LINE
Test Mode 1	: 802.11g, CH1	Temperature	: 25 °C
Memo	:	Humidity	: 65 %

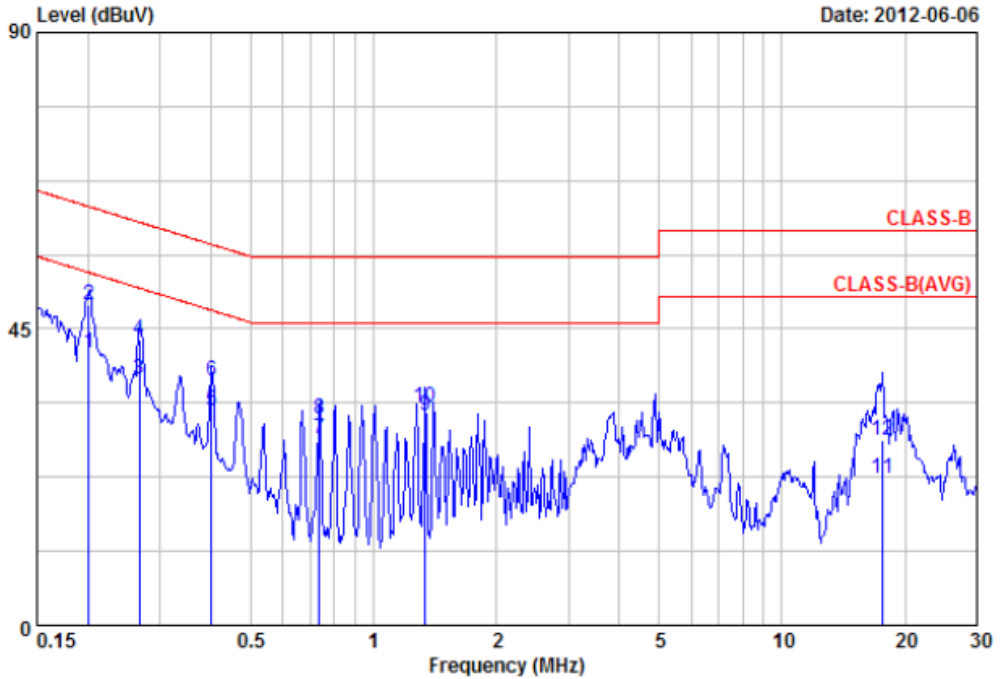

Item	Freq	Read Value	Factor	Result	Limit	Margin	Remark
	MHz	dBuV	dB/m	dBuV/m	dBuV/m	dB	
1	0.20	41.12	0.12	41.24	53.58	-12.34	Average
2	0.20	48.61	0.12	48.73	63.58	-14.85	QP
3	0.27	37.15	0.12	37.27	51.20	-13.93	Average
4	0.27	43.30	0.12	43.42	61.20	-17.78	QP
5	0.40	32.56	0.13	32.69	47.81	-15.12	Average
6	0.40	37.07	0.13	37.20	57.81	-20.61	QP
7	0.74	28.11	0.17	28.28	46.00	-17.72	Average
8	0.74	31.21	0.17	31.38	56.00	-24.62	QP
9	1.34	31.74	0.22	31.96	46.00	-14.04	Average
10	1.34	32.87	0.22	33.09	56.00	-22.91	QP
11	17.66	21.51	0.90	22.41	50.00	-27.59	Average
12	17.66	27.15	0.90	28.05	60.00	-31.95	QP

Notes:

1. Result = Read Value + Factor
2. Factor = LISN Factor + Cable Loss
3. All emission below 1GHz at 802.11b/g/n mode are all the same, so the 802.11g/n mode chosen as representative in final test.
4. According to technical experiences, all spurious emission of 802.11g/n mode at channel 1,6,11 or 3,6,9(for HT40) are almost the same below 1GHz, so that the channel 1 or 3(for HT40) was chosen as representative in final test.
5. The data is worse case.



Power	: From System	Pol/Phase	: NEUTRAL
Test Mode 1	: 802.11g, CH1	Temperature	: 25 °C
Memo	:	Humidity	: 65 %

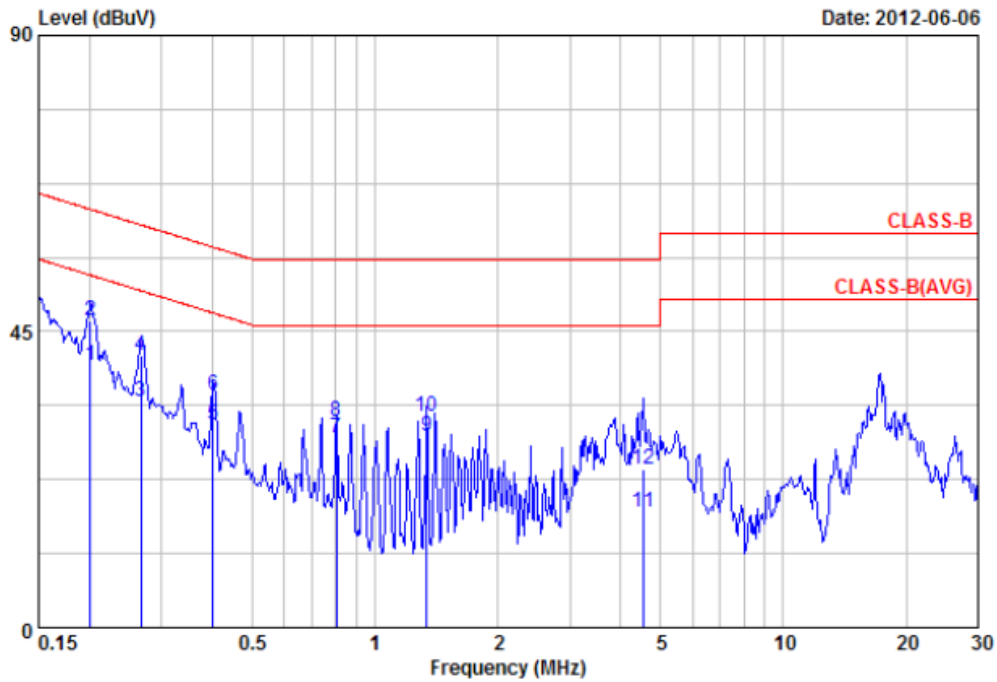

Item	Freq	Read Value	Factor	Result	Limit	Margin	Remark
	MHz	dBuV	dB/m	dBuV/m	dBuV/m	dB	
1	0.20	39.74	0.10	39.84	53.58	-13.74	Average
2	0.20	46.48	0.10	46.58	63.58	-17.00	QP
3	0.27	34.20	0.10	34.30	51.20	-16.90	Average
4	0.27	41.36	0.10	41.46	61.20	-19.74	QP
5	0.40	30.70	0.12	30.82	47.81	-16.99	Average
6	0.40	35.29	0.12	35.41	57.81	-22.40	QP
7	0.80	28.68	0.16	28.84	46.00	-17.16	Average
8	0.80	31.14	0.16	31.30	56.00	-24.70	QP
9	1.34	28.91	0.20	29.11	46.00	-16.89	Average
10	1.34	31.86	0.20	32.06	56.00	-23.94	QP
11	4.53	17.32	0.34	17.66	46.00	-28.34	Average
12	4.53	23.74	0.34	24.08	56.00	-31.92	QP

Notes:

1. Result = Read Value + Factor
2. Factor = LISN Factor + Cable Loss
3. All emission below 1GHz at 802.11b/g/n mode are all the same, so the 802.11g/n mode chosen as representative in final test.
4. According to technical experiences, all spurious emission of 802.11g/n mode at channel 1,6,11 or 3,6,9(for HT40) are almost the same below 1GHz, so that the channel 1 or 3(for HT40) was chosen as representative in final test.
5. The data is worse case.



Power	: From System	Pol/Phase	: LINE
Test Mode 2	: 802.11n HT20, CH1	Temperature	: 25 °C
Memo	:	Humidity	: 65 %

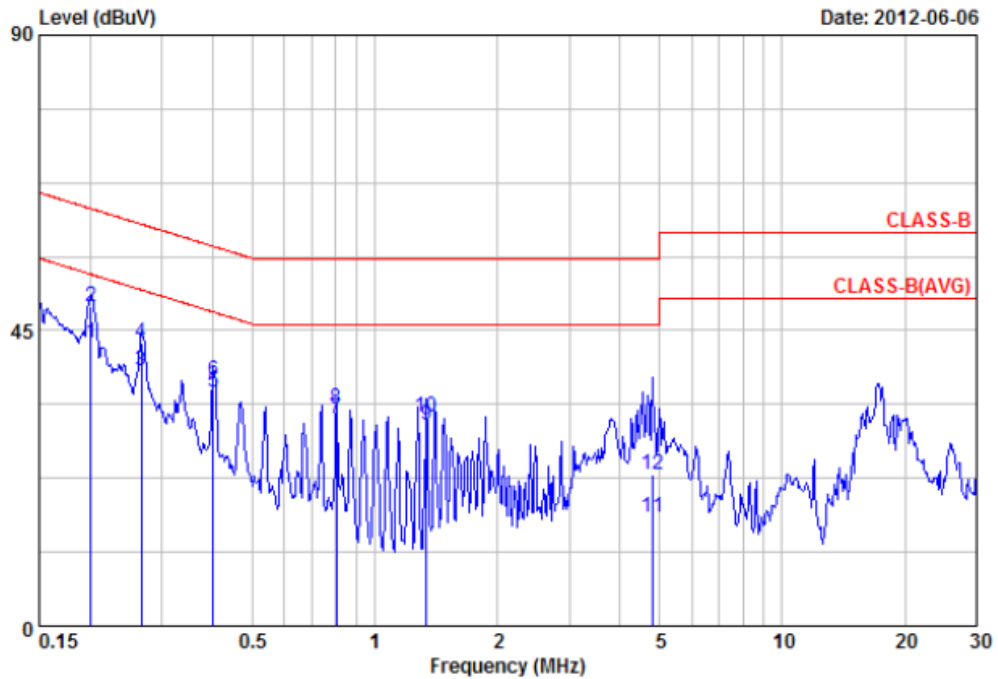

Item	Freq	Read Value	Factor	Result	Limit	Margin	Remark
	MHz	dBuV	dB/m	dBuV/m	dBuV/m	dB	
1	0.20	42.97	0.12	43.09	53.58	-10.49	Average
2	0.20	48.43	0.12	48.55	63.58	-15.03	QP
3	0.27	38.86	0.12	38.98	51.20	-12.22	Average
4	0.27	43.12	0.12	43.24	61.20	-17.96	QP
5	0.40	35.58	0.13	35.71	47.81	-12.10	Average
6	0.40	37.25	0.13	37.38	57.81	-20.43	QP
7	0.80	31.42	0.18	31.60	46.00	-14.40	Average
8	0.80	32.96	0.18	33.14	56.00	-22.86	QP
9	1.34	30.46	0.22	30.68	46.00	-15.32	Average
10	1.34	31.72	0.22	31.94	56.00	-24.06	QP
11	4.80	16.26	0.38	16.64	46.00	-29.36	Average
12	4.80	22.59	0.38	22.97	56.00	-33.03	QP

Notes:

1. Result = Read Value + Factor
2. Factor = LISN Factor + Cable Loss
3. All emission below 1GHz at 802.11b/g/n mode are all the same,so the 802.11g/n mode chosen as representative in final test.
4. According to technical experiences,all spurious emission of 802.11g/n mode at channel 1,6,11 or 3,6,9(for HT40) are almost the same below 1GHz,so that the channel 1 or 3(for HT40)was chosen as representative in final test.
5. The data is worse case.



Power	: From System	Pol/Phase	: NEUTRAL
Test Mode 2	: 802.11n HT20, CH1	Temperature	: 25 °C
Memo	:	Humidity	: 65 %

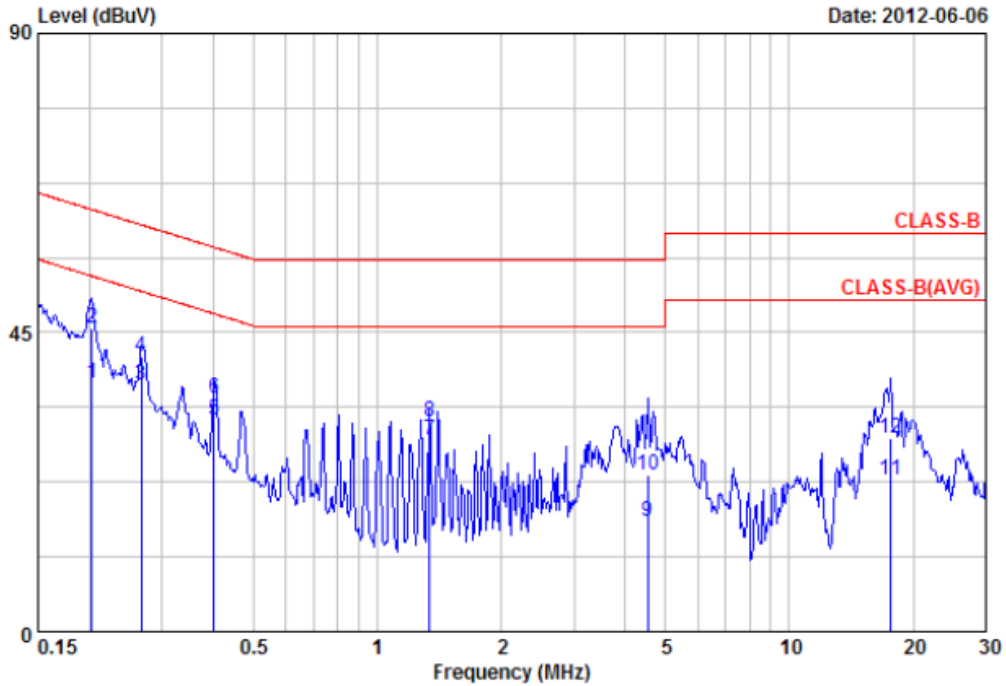

Item	Freq	Read Value	Factor	Result	Limit	Margin	Remark
	MHz	dBuV	dB/m	dBuV/m	dBuV/m	dB	
1	0.20	37.13	0.10	37.23	53.49	-16.26	Average
2	0.20	45.58	0.10	45.68	63.49	-17.81	QP
3	0.27	37.11	0.10	37.21	51.20	-13.99	Average
4	0.27	41.33	0.10	41.43	61.20	-19.77	QP
5	0.40	31.82	0.12	31.94	47.81	-15.87	Average
6	0.40	34.96	0.12	35.08	57.81	-22.73	QP
7	1.34	28.62	0.20	28.82	46.00	-17.18	Average
8	1.34	31.50	0.20	31.70	56.00	-24.30	QP
9	4.53	16.20	0.34	16.54	46.00	-29.46	Average
10	4.53	23.25	0.34	23.59	56.00	-32.41	QP
11	17.59	22.24	0.69	22.93	50.00	-27.07	Average
12	17.59	28.45	0.69	29.14	60.00	-30.86	QP

Notes:

1. Result = Read Value + Factor
2. Factor = LISN Factor + Cable Loss
3. All emission below 1GHz at 802.11b/g/n mode are all the same,so the 802.11g/n mode chosen as representative in final test.
4. According to technical experiences,all spurious emission of 802.11g/n mode at channel 1,6,11 or 3,6,9(for HT40) are almost the same below 1GHz,so that the channel 1 or 3(for HT40)was chosen as representative in final test.
5. The data is worse case.





Power	: From System	Pol/Phase	: LINE
Test Mode 3	: 802.11n HT40, CH3	Temperature	: 25 °C
Memo	:	Humidity	: 65 %

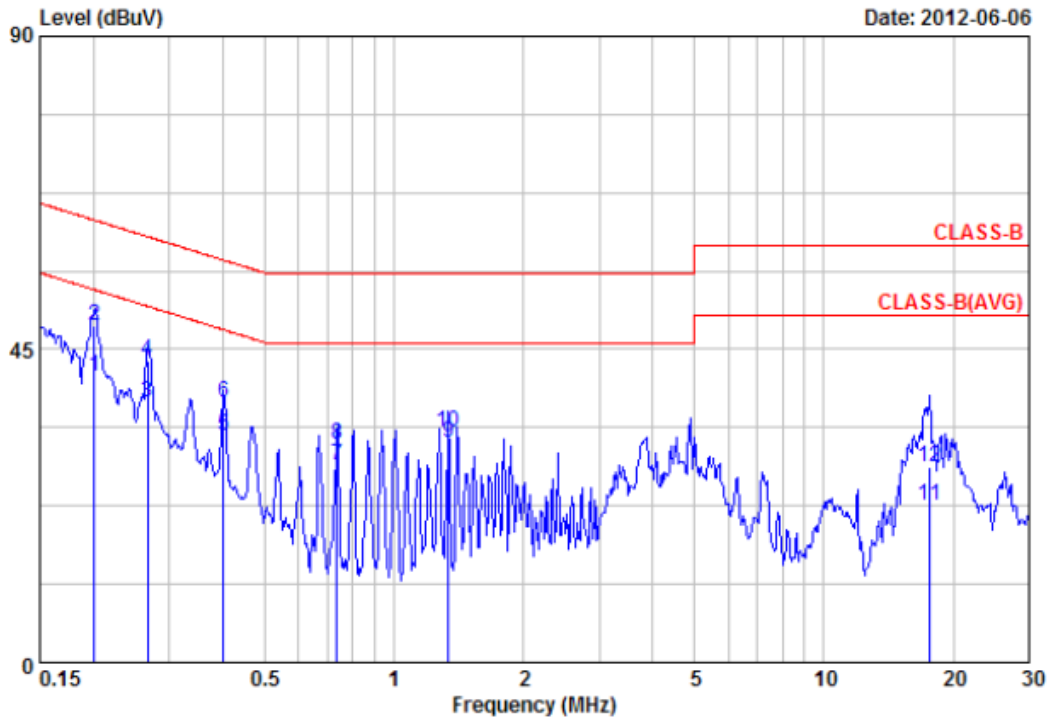

Item	Freq	Read Value	Factor	Result	Limit	Margin	Remark
	MHz	dBuV	dB/m	dBuV/m	dBuV/m	dB	
1	0.20	41.07	0.12	41.19	53.58	-12.39	Average
2	0.20	48.34	0.12	48.46	63.58	-15.12	QP
3	0.27	37.13	0.12	37.25	51.20	-13.95	Average
4	0.27	43.16	0.12	43.28	61.20	-17.92	QP
5	0.40	32.57	0.13	32.70	47.81	-15.11	Average
6	0.40	37.13	0.13	37.26	57.81	-20.55	QP
7	0.74	28.05	0.17	28.22	46.00	-17.78	Average
8	0.74	31.18	0.17	31.35	56.00	-24.65	QP
9	1.34	31.42	0.22	31.64	46.00	-14.36	Average
10	1.34	32.88	0.22	33.10	56.00	-22.90	QP
11	17.66	21.54	0.90	22.44	50.00	-27.56	Average
12	17.66	27.15	0.90	28.05	60.00	-31.95	QP

Notes:

1. Result = Read Value + Factor
2. Factor = LISN Factor + Cable Loss
3. All emission below 1GHz at 802.11b/g/n mode are all the same, so the 802.11g/n mode chosen as representative in final test.
4. According to technical experiences, all spurious emission of 802.11g/n mode at channel 1,6,11 or 3,6,9(for HT40) are almost the same below 1GHz, so that the channel 1 or 3(for HT40) was chosen as representative in final test.
5. The data is worse case.



Power	: From System	Pol/Phase	: NEUTRAL
Test Mode 3	: 802.11n HT40, CH3	Temperature	: 25 °C
Memo	:	Humidity	: 65 %

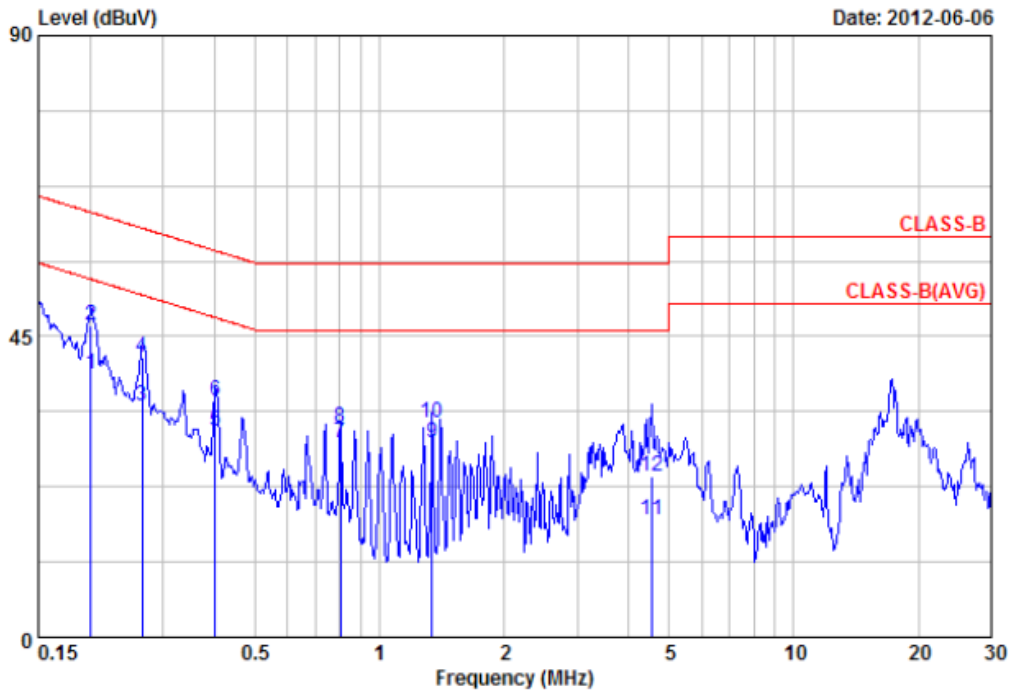

Item	Freq	Read Value	Factor	Result	Limit	Margin	Remark
	MHz	dBuV	dB/m	dBuV/m	dBuV/m	dB	
1	0.20	39.32	0.10	39.42	53.58	-14.16	Average
2	0.20	46.54	0.10	46.64	63.58	-16.94	QP
3	0.27	34.57	0.10	34.67	51.20	-16.53	Average
4	0.27	41.84	0.10	41.94	61.20	-19.26	QP
5	0.40	30.69	0.12	30.81	47.81	-17.00	Average
6	0.40	35.33	0.12	35.45	57.81	-22.36	QP
7	0.80	28.92	0.16	29.08	46.00	-16.92	Average
8	0.80	31.19	0.16	31.35	56.00	-24.65	QP
9	1.34	28.88	0.20	29.08	46.00	-16.92	Average
10	1.34	31.83	0.20	32.03	56.00	-23.97	QP
11	4.53	17.19	0.34	17.53	46.00	-28.47	Average
12	4.53	23.72	0.34	24.06	56.00	-31.94	QP

Notes:

1. Result = Read Value + Factor
2. Factor = LISN Factor + Cable Loss
3. All emission below 1GHz at 802.11b/g/n mode are all the same,so the 802.11g/n mode chosen as representative in final test.
4. According to technical experiences,all spurious emission of 802.11g/n mode at channel 1,6,11 or 3,6,9(for HT40) are almost the same below 1GHz,so that the channel 1 or 3(for HT40)was chosen as representative in final test.
5. The data is worse case.



Power	: From System	Pol/Phase	: LINE
Test Mode 4	: 802.11a, CH149	Temperature	: 25 °C
Memo	:	Humidity	: 65 %

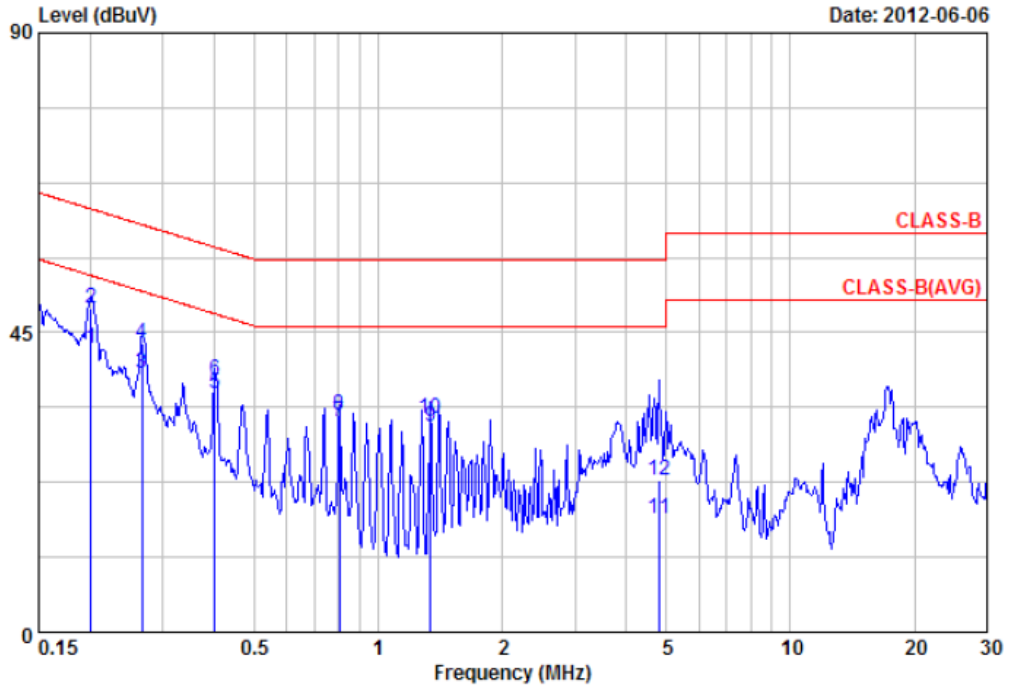

Item	Freq	Read Value	Factor	Result	Limit	Margin	Remark
	MHz	dBuV	dB/m	dBuV/m	dBuV/m	dB	
1	0.20	42.47	0.12	42.59	53.58	-10.99	Average
2	0.20	48.60	0.12	48.72	63.58	-14.86	QP
3	0.27	38.70	0.12	38.82	51.20	-12.38	Average
4	0.27	43.19	0.12	43.31	61.20	-17.89	QP
5	0.40	35.61	0.13	35.74	47.81	-12.07	Average
6	0.40	37.69	0.13	37.82	57.81	-19.99	QP
7	0.80	31.46	0.18	31.64	46.00	-14.36	Average
8	0.80	32.53	0.18	32.71	56.00	-23.29	QP
9	1.34	30.61	0.22	30.83	46.00	-15.17	Average
10	1.34	31.79	0.22	32.01	56.00	-23.99	QP
11	4.80	16.74	0.38	17.12	46.00	-28.88	Average
12	4.80	22.40	0.38	22.78	56.00	-33.22	QP

Notes:

1. Result = Read Value + Factor
2. Factor = LISN Factor + Cable Loss
3. According to technical experiences, all spurious emission of 802.11a/an mode at Band1~4 channel are almost the same below 1GHz, so that the channel 36 or 38 (for HT40), channel 149 or 151 (for HT40) was chosen as representative in final test.
4. The data is worse case.



Power	: From System	Pol/Phase	: NEUTRAL
Test Mode 4	: 802.11a, CH149	Temperature	: 25 °C
Memo	:	Humidity	: 65 %

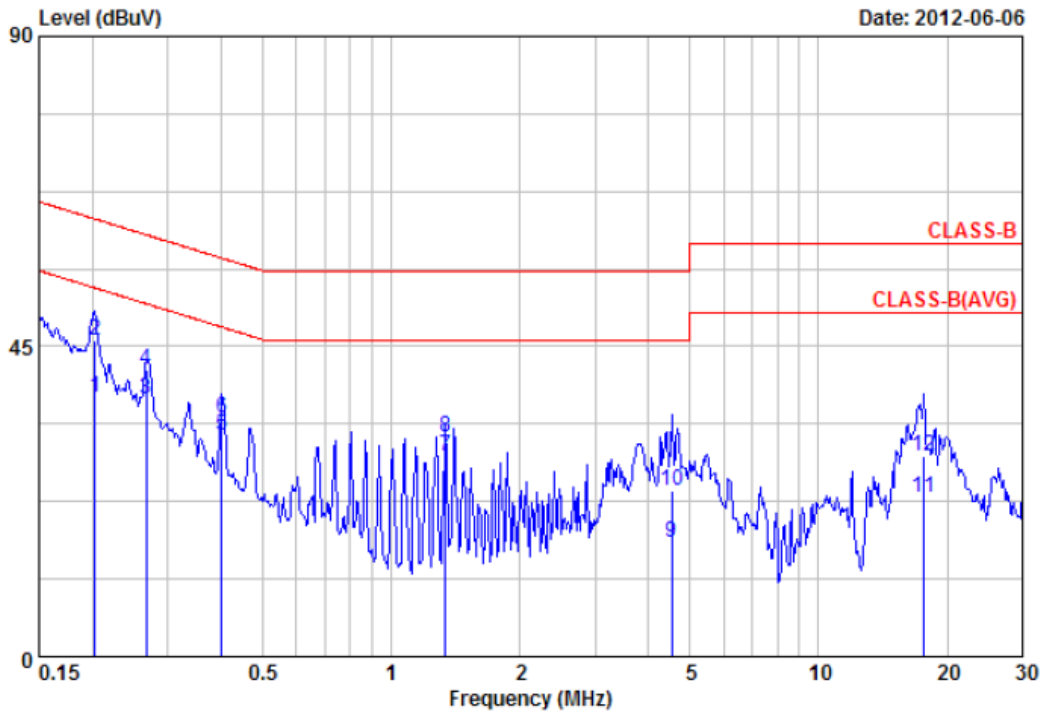

Item	Freq	Read Value	Factor	Result	Limit	Margin	Remark
	MHz	dBuV	dB/m	dBuV/m	dBuV/m	dB	
1	0.20	37.47	0.10	37.57	53.49	-15.92	Average
2	0.20	45.68	0.10	45.78	63.49	-17.71	QP
3	0.27	37.17	0.10	37.27	51.20	-13.93	Average
4	0.27	41.57	0.10	41.67	61.20	-19.53	QP
5	0.40	31.88	0.12	32.00	47.81	-15.81	Average
6	0.40	34.46	0.12	34.58	57.81	-23.23	QP
7	1.34	28.79	0.20	28.99	46.00	-17.01	Average
8	1.34	31.53	0.20	31.73	56.00	-24.27	QP
9	4.53	16.14	0.34	16.48	46.00	-29.52	Average
10	4.53	23.63	0.34	23.97	56.00	-32.03	QP
11	17.59	22.44	0.69	23.13	50.00	-26.87	Average
12	17.59	28.41	0.69	29.10	60.00	-30.90	QP

Notes:

1. Result = Read Value + Factor
2. Factor = LISN Factor + Cable Loss
3. According to technical experiences, all spurious emission of 802.11a/an mode at Band1~4 channel are almost the same below 1GHz, so that the channel 36 or 38(for HT40), channel 149 or 151(for HT40) was chosen as representative in final test.
4. The data is worse case.



Power	: From System	Pol/Phase	: LINE
Test Mode 5	: 802.11an HT20, CH149	Temperature	: 25 °C
Memo	:	Humidity	: 65 %

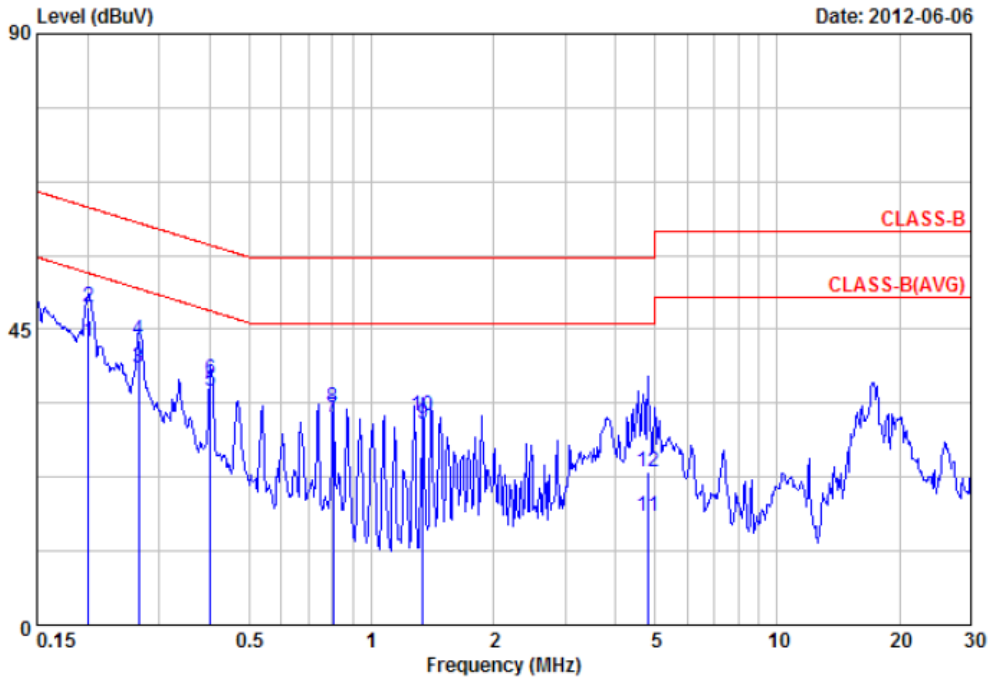

Item	Freq	Read Value	Factor	Result	Limit	Margin	Remark
	MHz	dBuV	dB/m	dBuV/m	dBuV/m	dB	
1	0.20	42.92	0.12	43.04	53.58	-10.54	Average
2	0.20	48.22	0.12	48.34	63.58	-15.24	QP
3	0.27	38.90	0.12	39.02	51.20	-12.18	Average
4	0.27	43.19	0.12	43.31	61.20	-17.89	QP
5	0.40	35.35	0.13	35.48	47.81	-12.33	Average
6	0.40	37.27	0.13	37.40	57.81	-20.41	QP
7	0.80	31.42	0.18	31.60	46.00	-14.40	Average
8	0.80	32.93	0.18	33.11	56.00	-22.89	QP
9	1.34	30.46	0.22	30.68	46.00	-15.32	Average
10	1.34	31.59	0.22	31.81	56.00	-24.19	QP
11	4.80	16.26	0.38	16.64	46.00	-29.36	Average
12	4.80	22.90	0.38	23.28	56.00	-32.72	QP

Notes:

1. Result = Read Value + Factor
2. Factor = LISN Factor + Cable Loss
3. According to technical experiences, all spurious emission of 802.11a/an mode at Band1~4 channel are almost the same below 1GHz, so that the channel 36 or 38(for HT40), channel 149 or 151(for HT40) was chosen as representative in final test.
4. The data is worse case.



Power	: From System	Pol/Phase	: NEUTRAL
Test Mode 5	: 802.11an HT20, CH149	Temperature	: 25 °C
Memo	:	Humidity	: 65 %

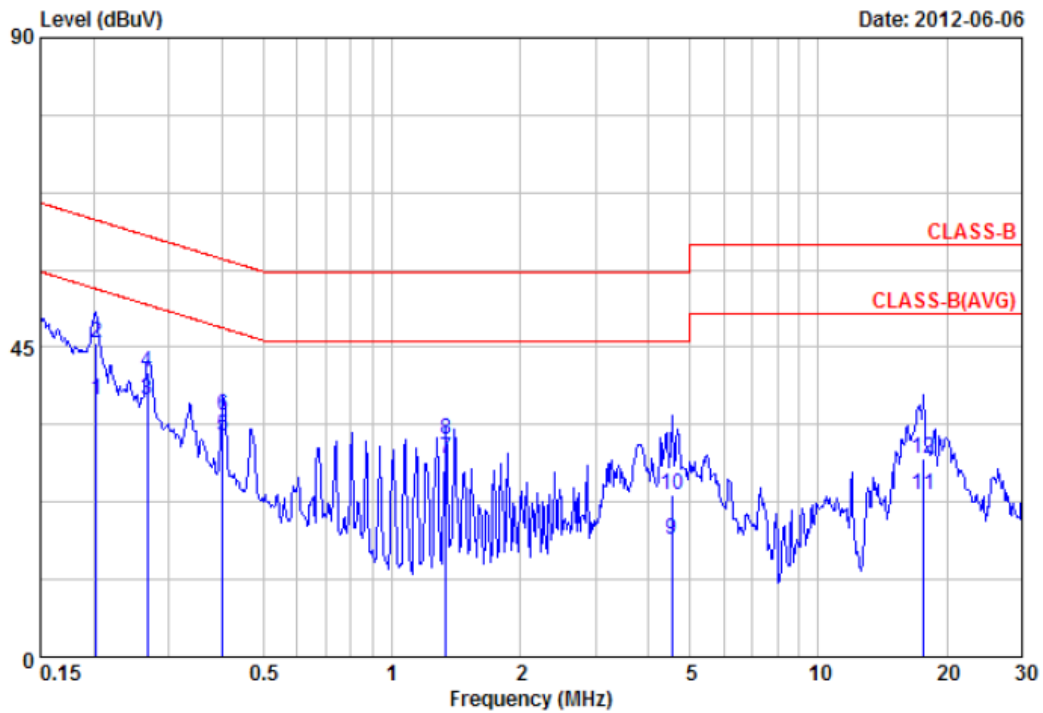

Item	Freq	Read Value	Factor	Result	Limit	Margin	Remark
	MHz	dBuV	dB/m	dBuV/m	dBuV/m	dB	
1	0.20	37.36	0.10	37.46	53.49	-16.03	Average
2	0.20	45.57	0.10	45.67	63.49	-17.82	QP
3	0.27	37.37	0.10	37.47	51.20	-13.73	Average
4	0.27	41.33	0.10	41.43	61.20	-19.77	QP
5	0.40	31.88	0.12	32.00	47.81	-15.81	Average
6	0.40	34.96	0.12	35.08	57.81	-22.73	QP
7	1.34	28.52	0.20	28.72	46.00	-17.28	Average
8	1.34	31.50	0.20	31.70	56.00	-24.30	QP
9	4.53	16.69	0.34	17.03	46.00	-28.97	Average
10	4.53	23.25	0.34	23.59	56.00	-32.41	QP
11	17.59	22.82	0.69	23.51	50.00	-26.49	Average
12	17.59	28.15	0.69	28.84	60.00	-31.16	QP

Notes:

1. Result = Read Value + Factor
2. Factor = LISN Factor + Cable Loss
3. According to technical experiences, all spurious emission of 802.11a/an mode at Band1~4 channel are almost the same below 1GHz, so that the channel 36 or 38 (for HT40), channel 149 or 151 (for HT40) was chosen as representative in final test.
4. The data is worse case.



Power	: From System	Pol/Phase	: LINE
Test Mode 6	: 802.11an HT40, CH151	Temperature	: 25 °C
Memo	:	Humidity	: 65 %

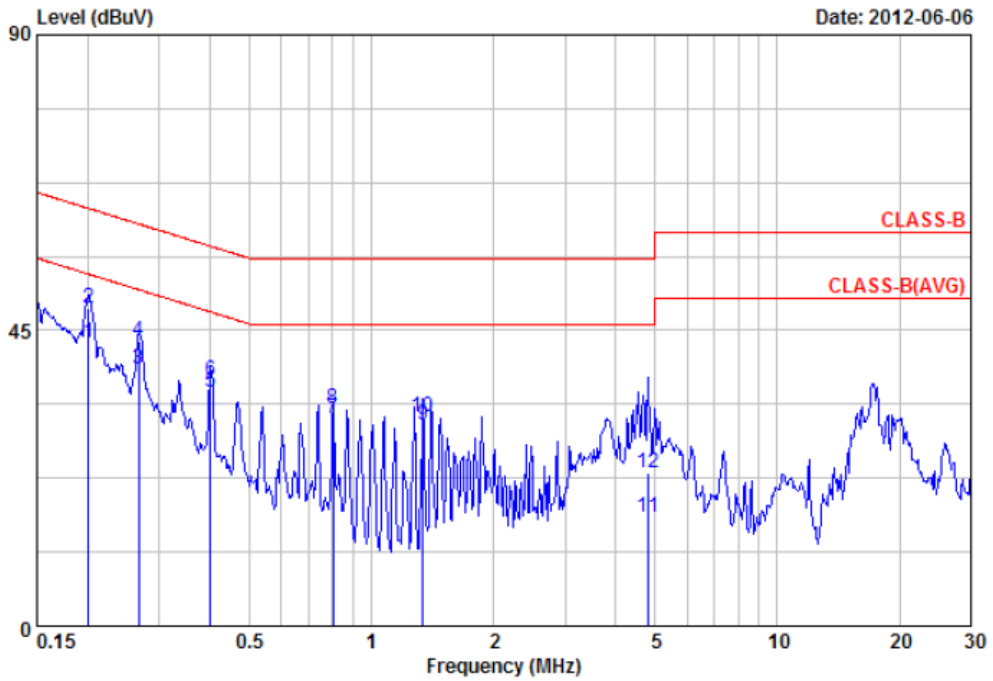

Item	Freq	Read Value	Factor	Result	Limit	Margin	Remark
	MHz	dBuV	dB/m	dBuV/m	dBuV/m	dB	
1	0.20	42.92	0.12	43.04	53.58	-10.54	Average
2	0.20	48.22	0.12	48.34	63.58	-15.24	QP
3	0.27	38.90	0.12	39.02	51.20	-12.18	Average
4	0.27	43.19	0.12	43.31	61.20	-17.89	QP
5	0.40	35.35	0.13	35.48	47.81	-12.33	Average
6	0.40	37.27	0.13	37.40	57.81	-20.41	QP
7	0.80	31.42	0.18	31.60	46.00	-14.40	Average
8	0.80	32.93	0.18	33.11	56.00	-22.89	QP
9	1.34	30.46	0.22	30.68	46.00	-15.32	Average
10	1.34	31.59	0.22	31.81	56.00	-24.19	QP
11	4.80	16.26	0.38	16.64	46.00	-29.36	Average
12	4.80	22.90	0.38	23.28	56.00	-32.72	QP

Notes:

1. Result = Read Value + Factor
2. Factor = LISN Factor + Cable Loss
3. According to technical experiences, all spurious emission of 802.11a/an mode at Band1~4 channel are almost the same below 1GHz, so that the channel 36 or 38 (for HT40), channel 149 or 151 (for HT40) was chosen as representative in final test.
4. The data is worse case.



Power	: From System	Pol/Phase	: NEUTRAL
Test Mode 6	: 802.11an HT40, CH151	Temperature	: 25 °C
Memo	:	Humidity	: 65 %

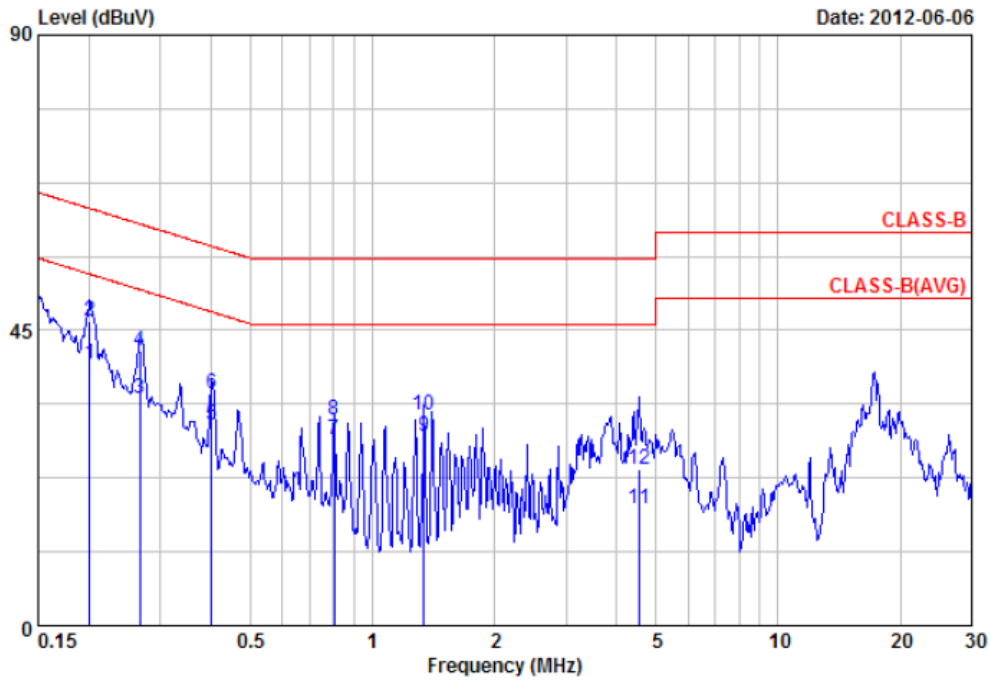

Item	Freq	Read Value	Factor	Result	Limit	Margin	Remark
	MHz	dBuV	dB/m	dBuV/m	dBuV/m	dB	
1	0.20	39.85	0.10	39.95	53.58	-13.63	Average
2	0.20	46.30	0.10	46.40	63.58	-17.18	QP
3	0.27	34.57	0.10	34.67	51.20	-16.53	Average
4	0.27	41.84	0.10	41.94	61.20	-19.26	QP
5	0.40	30.44	0.12	30.56	47.81	-17.25	Average
6	0.40	35.33	0.12	35.45	57.81	-22.36	QP
7	0.80	28.26	0.16	28.42	46.00	-17.58	Average
8	0.80	31.19	0.16	31.35	56.00	-24.65	QP
9	1.34	28.52	0.20	28.72	46.00	-17.28	Average
10	1.34	31.83	0.20	32.03	56.00	-23.97	QP
11	4.53	17.38	0.34	17.72	46.00	-28.28	Average
12	4.53	23.52	0.34	23.86	56.00	-32.14	QP

Notes:

1. Result = Read Value + Factor
2. Factor = LISN Factor + Cable Loss
3. According to technical experiences, all spurious emission of 802.11a/an mode at Band1~4 channel are almost the same below 1GHz, so that the channel 36 or 38 (for HT40), channel 149 or 151 (for HT40) was chosen as representative in final test.
4. The data is worse case.





### 4.6 Test Photographs

Front View



Rear View

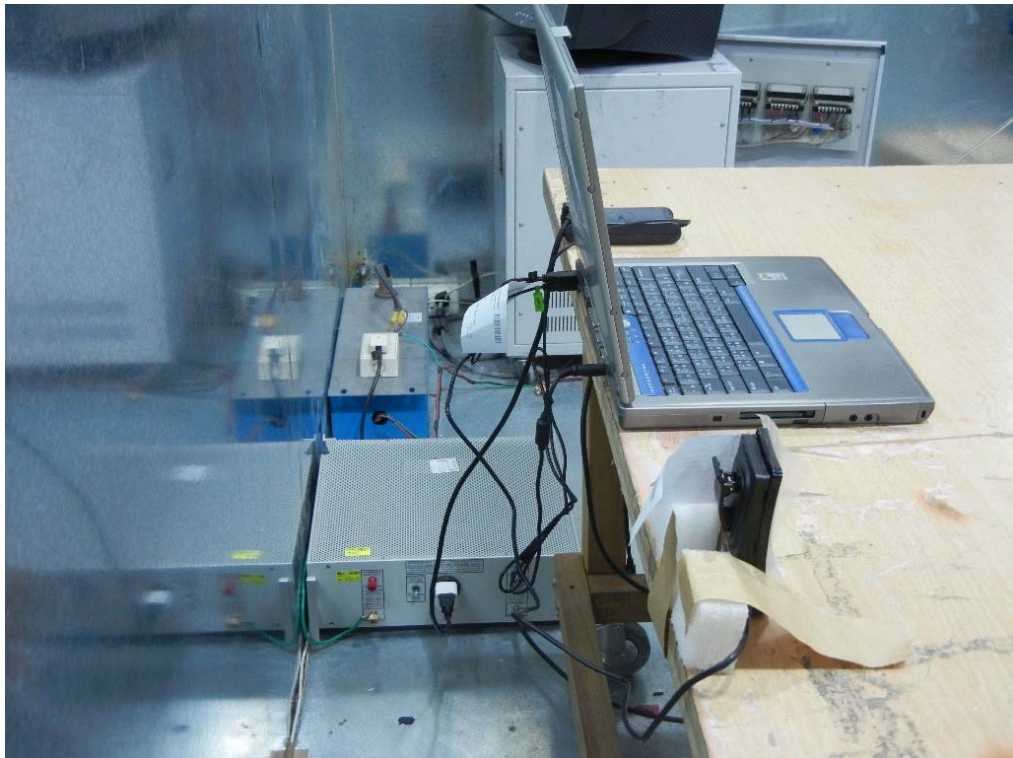



## 5. Test of Radiated Emission

### 5.1 Test Limit

In any 100kHz bandwidth outside the frequency band in which the spread spectrum or digitally modulated intentional radiator is operating, the radio frequency power that is produced by the intentional radiator shall be at least 20dB below that in the 100kHz bandwidth within the band that contains the highest level of the desired power, based on either an RF conducted or a radiated measurement. If the transmitter measurement is based on the maximum conducted output power, the attenuation required under this paragraph shall be 30dB instead of 20dB. In addition, radiated emissions which fall in section 15.205(a) the restricted bands must also comply with the radiated emission limit specified in section 15.209(a).

Frequency (MHz)	Field Strength (microvolt/meter)	Measurement Distance (meters)
0.009 ~ 0.490	2400/F(kHz)	300
0.490 ~ 1.705	24000/F(kHz)	30
1.705 ~ 30.0	30	30
30 ~ 88	100	3
88 ~ 216	150	3
216 ~ 960	200	3
Above 960	500	3

### 5.2 Test Procedures

- a. The EUT was placed on a rotatable table top 0.8 meter above ground.
- b. The EUT was set 3 meters from the interference receiving antenna which was mounted on the top of a variable height antenna tower.
- c. The table was rotated 360 degrees to determine the position of the highest radiation.
- d. The antenna is a broadband antenna and its height is varied between one meter and four meters above ground to find the maximum value of the field strength both horizontal polarization and vertical polarization of the antenna are set to make the measurement.
- e. For each suspected emission the EUT was arranged to its worst case and then tune the antenna tower (from 1 M to 4 M) and turn table (from 0 degree to 360 degrees) to find the maximum reading.
- f. Set the test-receiver system to Peak or CISPR quasi-peak Detect Function and specified bandwidth with Maximum Hold Mode.
- g. If the emission level of the EUT in peak mode was 3 dB lower than the limit specified, then testing will be stopped and peak values of EUT will be reported, otherwise, the emissions which do not have 3 dB margin will be repeated one by one using the quasi-peak method and reported.
- h. For testing above 1GHz, the emission level of the EUT in peak mode was 20dB lower than average limit (that means the emission level in peak mode also complies with the limit in average mode), then testing will be stopped and peak values of EUT will be reported, otherwise, the emissions will be measured in average mode again and reported.
- i. "Cone of radiation" has been considered to be 3dB bandwidth of the measurement antenna.



### 5.3 Typical Test Setup

For radiated emissions below 30MHz

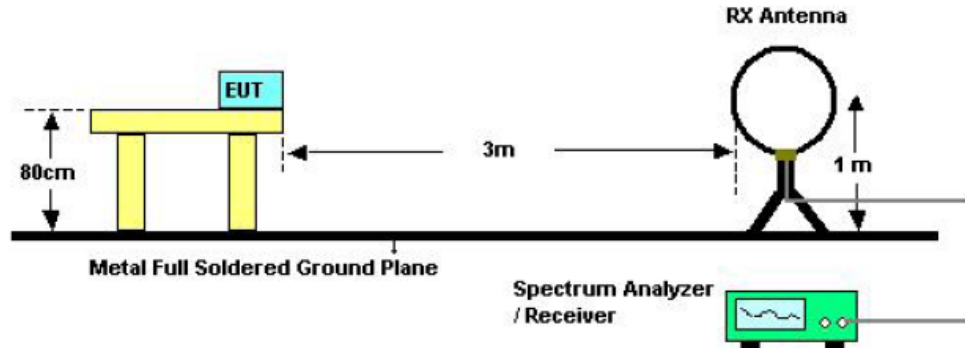

For radiated emissions above 30MHz

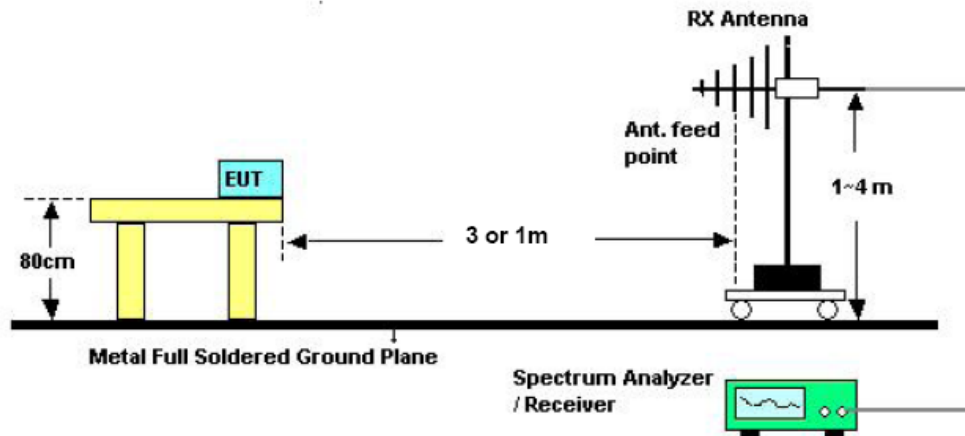

Above 10 GHz shall be extrapolated to the specified distance using an extrapolation factor of 20 dB/decade from 3m to 1m.  
 Distance extrapolation factor =  $20 \log(\text{specific distance [3m]} / \text{test distance [1m]})$  (dB);  
 Limit line = specific limits (dBuV) + distance extrapolation factor [9.54 dB].

### 5.4 Measurement Equipment

Instrument/Ancillary	Manufacturer	Model No.	Serial No.	Calibration Date	Valid Date
EMI Receiver	R&S	ESCI	100821	2012/01/31	2013/01/30
Amplifier	QuieTek	AP/0100A	CHM0906075	2012/01/13	2013/01/12
Signal Generator	HP	8648B	3629U00612	2012/01/11	2013/01/10
Bilog Antenna	Schwarzbeck	VULB 9168	275	2012/03/23	2013/03/22
Spectrum Analyzer	R&S	FSP40	100047	2012/03/01	2013/02/28
Horn Antenna	EMCO	3115	31589	2012/03/01	2013/02/28
Preamplifier	Agilent	8449B	3008A01954	2012/02/29	2013/02/28
Loop Antenna	EMCO	6507	40855	2012/02/29	2013/02/28



### 5.5 Test Result and Data (9kHz ~ 30MHz)

The 9kHz - 30MHz spurious emission is under limit 20dB more.

### 5.6 Test Result and Data

Power	: From System	Pol/Phase	: VERTICAL
Test Mode 1	: 802.11g, CH1	Temperature	: 25 °C
Memo	:	Humidity	: 65 %

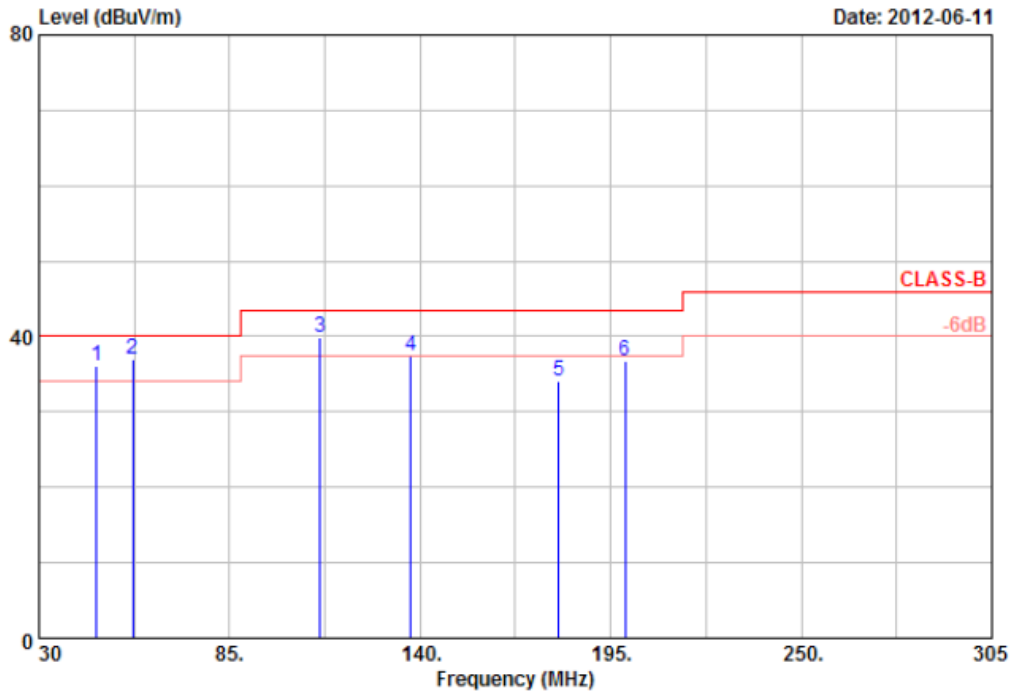

Item	Freq	Read Value	Factor	Result	Limit	Margin	Remark	Ant Pos	Tab Pos
	MHz	dBuV	dB/m	dBuV/m	dBuV/m	dB		cm	Deg
1	46.50	38.90	-2.83	36.07	40.00	-3.93	QP	100	0
2	56.95	48.73	-11.85	36.88	40.00	-3.12	QP	100	0
3	111.13	46.88	-7.07	39.81	43.50	-3.69	QP	100	0
4	137.25	44.20	-6.77	37.43	43.50	-6.07	Peak	100	0
5	179.88	39.22	-5.06	34.16	43.50	-9.34	Peak	100	0
6	199.13	48.25	-11.47	36.78	43.50	-6.72	Peak	100	0

Notes:

1. Result = Read Value + Factor
2. Factor = Antenna Factor + Cable Loss - Amplifier
3. The resolution bandwidth of test receiver/spectrum analyzer is 120KHz and video bandwidth is 300kHz for Peak detection and Quasi-peak detection at frequency below 1GHz.
4. All emission below 1GHz at 802.11b/g/n mode are all the same, so the 802.11g/n mode chosen as representative in final test.
5. According to technical experiences, all spurious emission of 802.11g/n mode at channel 1,6,11 or 3,6,9(for HT40) are almost the same below 1GHz, so that the channel 1 or 3(for HT40) was chosen as representative in final test.
6. The data is worse case.



Power	: From System	Pol/Phase	: VERTICAL
Test Mode 1	: 802.11g, CH1	Temperature	: 25 °C
Memo	:	Humidity	: 65 %

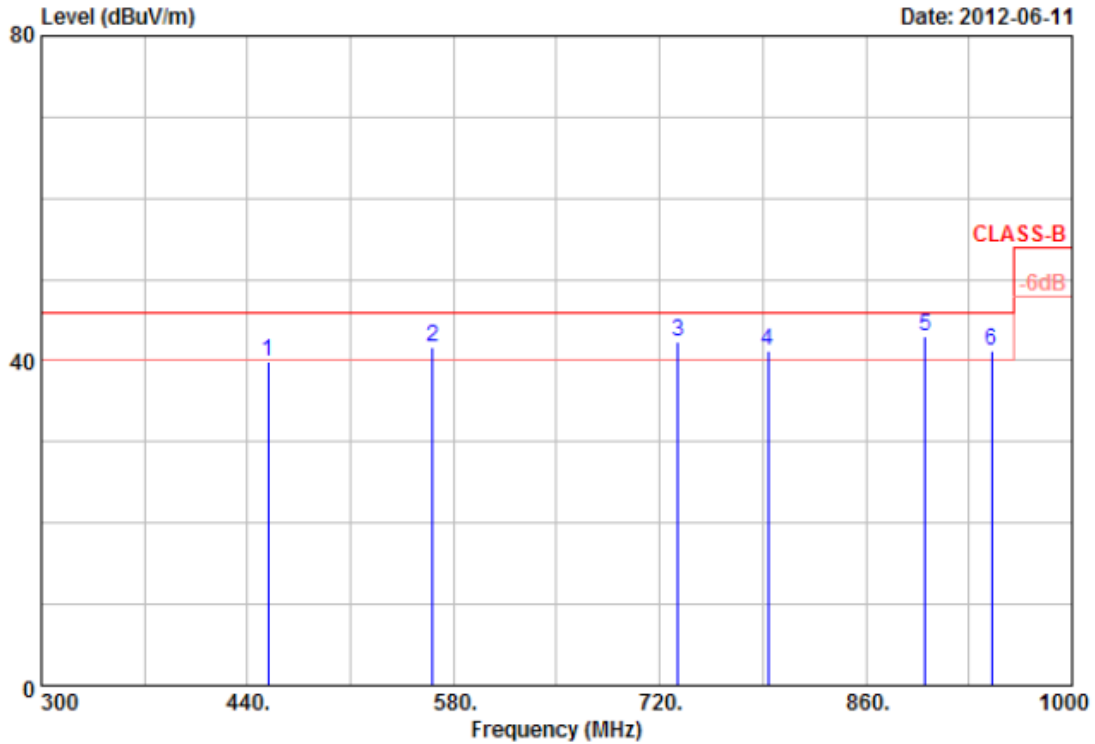

Item	Freq	Read Value	Factor	Result	Limit	Margin	Remark	Ant Pos	Tab Pos
	MHz	dBuV	dB/m	dBuV/m	dBuV/m	dB		cm	Deg
1	454.00	47.92	-8.08	39.84	46.00	-6.16	Peak	100	0
2	566.00	34.99	6.78	41.77	46.00	-4.23	QP	100	0
3	732.60	35.36	7.02	42.38	46.00	-3.62	QP	100	0
4	793.50	35.34	5.82	41.16	46.00	-4.84	QP	100	0
5	900.60	33.74	9.19	42.93	46.00	-3.07	QP	100	0
6	945.40	29.88	11.40	41.28	46.00	-4.72	QP	100	0

Notes:

1. Result = Read Value + Factor
2. Factor = Antenna Factor + Cable Loss - Amplifier
3. The resolution bandwidth of test receiver/spectrum analyzer is 120KHz and video bandwidth is 300kHz for Peak detection and Quasi-peak detection at frequency below 1GHz.
4. All emission below 1GHz at 802.11b/g/n mode are all the same, so the 802.11g/n mode chosen as representative in final test.
5. According to technical experiences, all spurious emission of 802.11g/n mode at channel 1,6,11 or 3,6,9(for HT40) are almost the same below 1GHz, so that the channel 1 or 3(for HT40) was chosen as representative in final test.
6. The data is worse case.



Power	: FROM SYSTEM	Pol/Phase	: HORIZONTAL
Test Mode 1	: 802.11g, CH1	Temperature	: 25 °C
Memo	:	Humidity	: 65 %

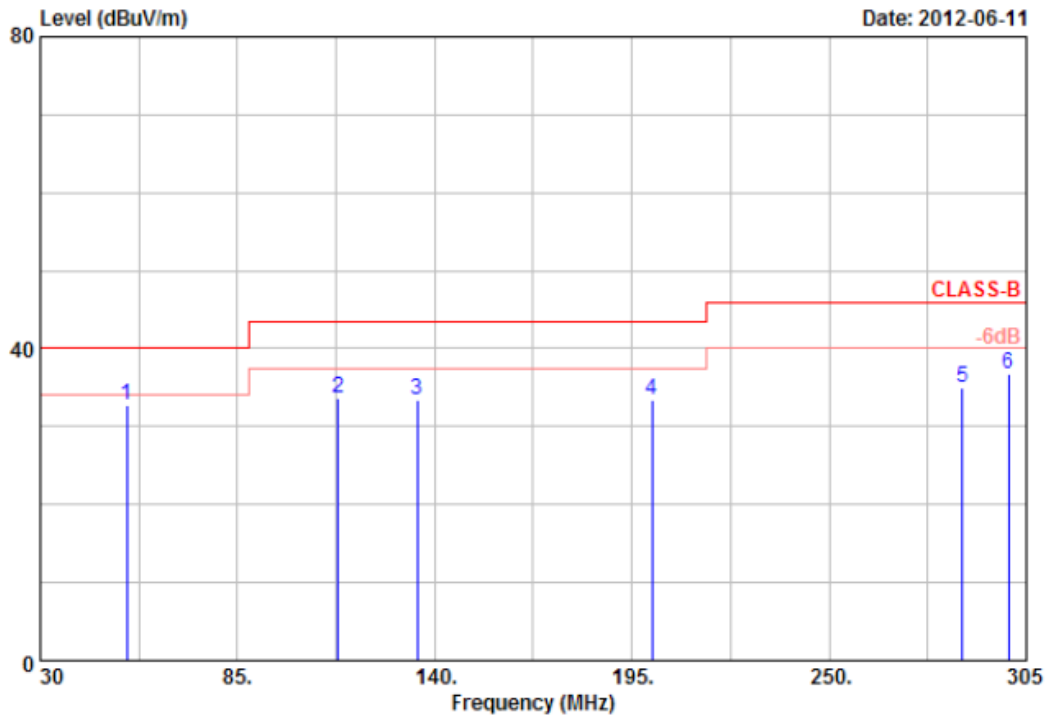

Item	Freq	Read Value	Factor	Result	Limit	Margin	Remark	Ant Pos	Tab Pos
	MHz	dBuV	dB/m	dBuV/m	dBuV/m	dB		cm	Deg
1	54.20	44.05	-11.30	32.75	40.00	-7.25	Peak	100	0
2	113.05	52.57	-18.99	33.58	43.50	-9.92	Peak	100	0
3	135.05	48.15	-14.68	33.47	43.50	-10.03	Peak	100	0
4	200.50	52.22	-18.72	33.50	43.50	-10.00	Peak	100	0
5	287.13	48.46	-13.39	35.07	46.00	-10.93	Peak	100	0
6	300.05	48.93	-12.08	36.85	46.00	-9.15	Peak	100	0

Notes:

1. Result = Read Value + Factor
2. Factor = Antenna Factor + Cable Loss - Amplifier
3. The resolution bandwidth of test receiver/spectrum analyzer is 120KHz and video bandwidth is 300kHz for Peak detection and Quasi-peak detection at frequency below 1GHz.
4. All emission below 1GHz at 802.11b/g/n mode are all the same, so the 802.11g/n mode chosen as representative in final test.
5. According to technical experiences, all spurious emission of 802.11g/n mode at channel 1,6,11 or 3,6,9(for HT40) are almost the same below 1GHz, so that the channel 1 or 3(for HT40) was chosen as representative in final test.
6. The data is worse case.



Power	: FROM SYSTEM	Pol/Phase	: HORIZONTAL
Test Mode 1	: 802.11g, CH1	Temperature	: 25 °C
Memo	:	Humidity	: 65 %

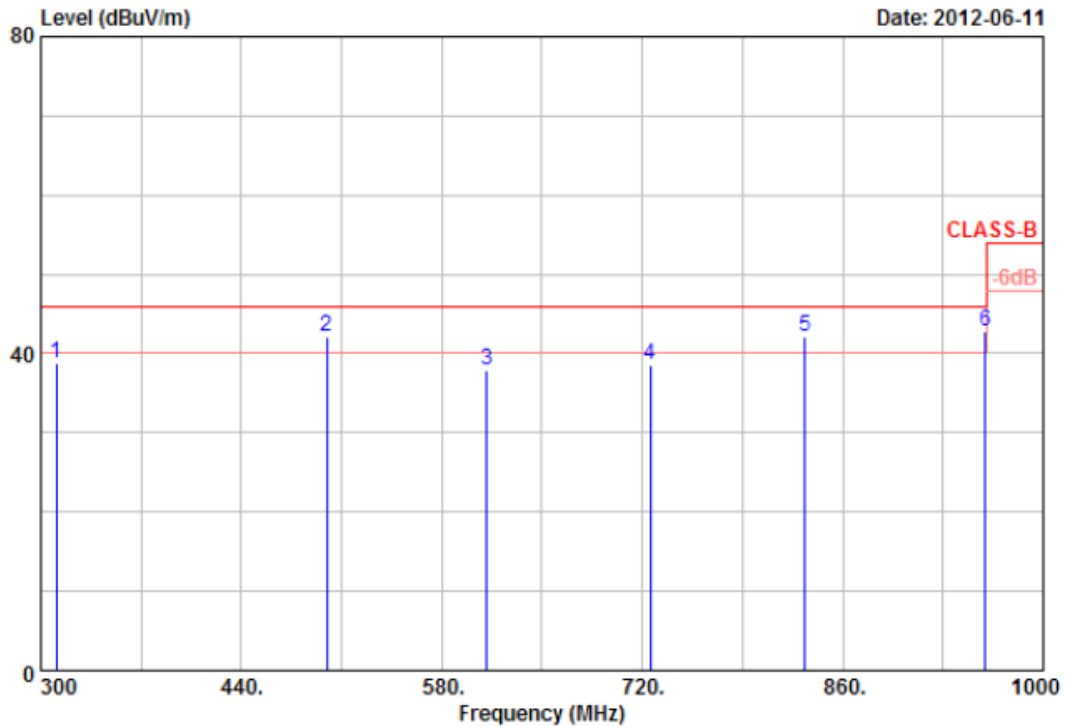

Item	Freq	Read Value	Factor	Result	Limit	Margin	Remark	Ant Pos	Tab Pos
	MHz	dBuV	dB/m	dBuV/m	dBuV/m	dB		cm	Deg
1	310.50	51.22	-12.50	38.72	46.00	-7.28	Peak	100	0
2	499.50	42.43	-0.22	42.21	46.00	-3.79	QP	100	0
3	611.50	34.64	3.24	37.88	46.00	-8.12	Peak	100	0
4	725.60	35.03	3.60	38.63	46.00	-7.37	Peak	100	0
5	833.40	33.31	8.80	42.11	46.00	-3.89	QP	100	0
6	959.40	34.83	7.97	42.80	46.00	-3.20	QP	100	0

Notes:

1. Result = Read Value + Factor
2. Factor = Antenna Factor + Cable Loss - Amplifier
3. The resolution bandwidth of test receiver/spectrum analyzer is 120KHz and video bandwidth is 300kHz for Peak detection and Quasi-peak detection at frequency below 1GHz.
4. All emission below 1GHz at 802.11b/g/n mode are all the same,so the 802.11g/n mode chosen as representative in final test.
5. According to technical experiences,all spurious emission of 802.11g/n mode at channel 1,6,11 or 3,6,9(for HT40) are almost the same below 1GHz,so that the channel 1 or 3(for HT40)was chosen as representative in final test.
6. The data is worse case.



Power	: FROM SYSTEM	Pol/Phase	: VERTICAL
Test Mode 1	: 802.11b, CH1	Temperature	: 22 °C
Memo	:	Humidity	: 65 %

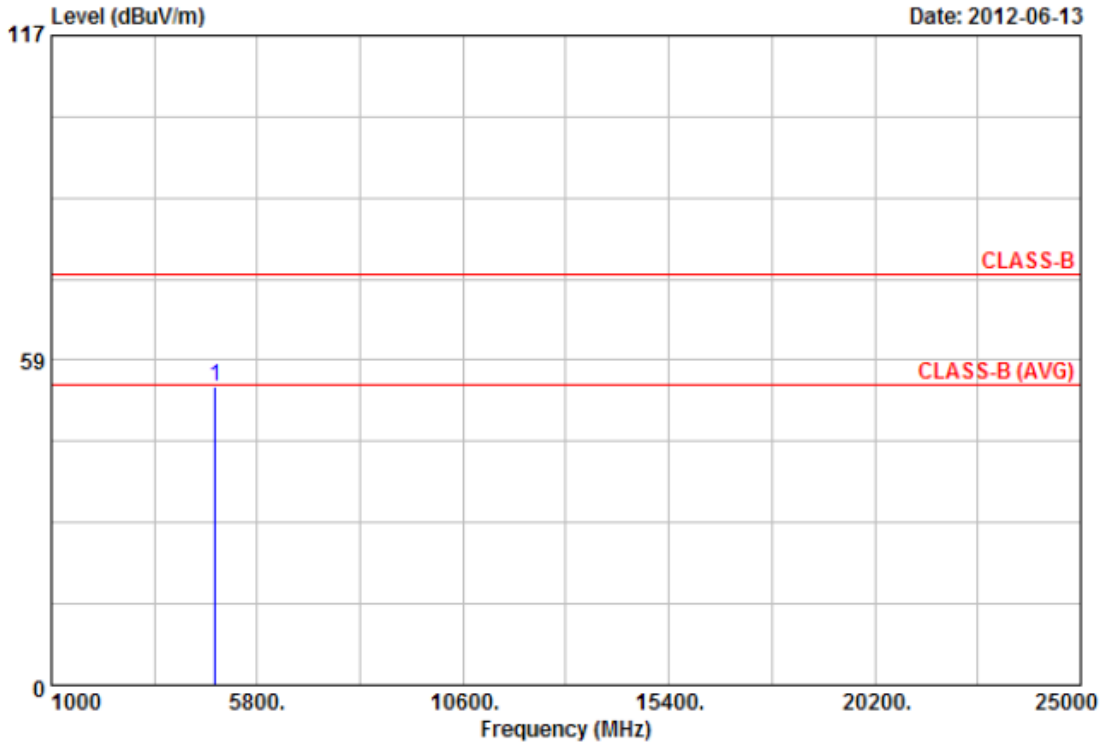

Item	Freq	Read Value	Factor	Result	Limit	Margin	Remark	Ant Pos	Tab Pos
	MHz	dBuV	dB/m	dBuV/m	dBuV/m	dB		cm	Deg
1	4825.38	48.04	5.64	53.68	74.00	-20.32	Peak	100	195

Notes:

1. Result = Read Value + Factor
2. Factor = Antenna Factor + Cable Loss - Amplifier
3. The resolution bandwidth of test receiver/spectrum analyzer is 120KHz and video bandwidth is 300kHz for Peak detection and Quasi-peak detection at frequency below 1GHz.
4. The resolution bandwidth of test receiver/spectrum analyzer is 1MHz and video bandwidth is 3MHz for Peak detection at frequency above 1GHz.
5. The resolution bandwidth of test receiver/spectrum analyzer is 1MHz and video bandwidth is 3MHz (detector sample mode) for Average detection at frequency above 1GHz.
6. The other emissions is too low to be measured.
7. The data is worse case.





Power	: FROM SYSTEM	Pol/Phase	: HORIZONTAL
Test Mode 1	: 802.11b, CH1	Temperature	: 22 °C
Memo	:	Humidity	: 65 %

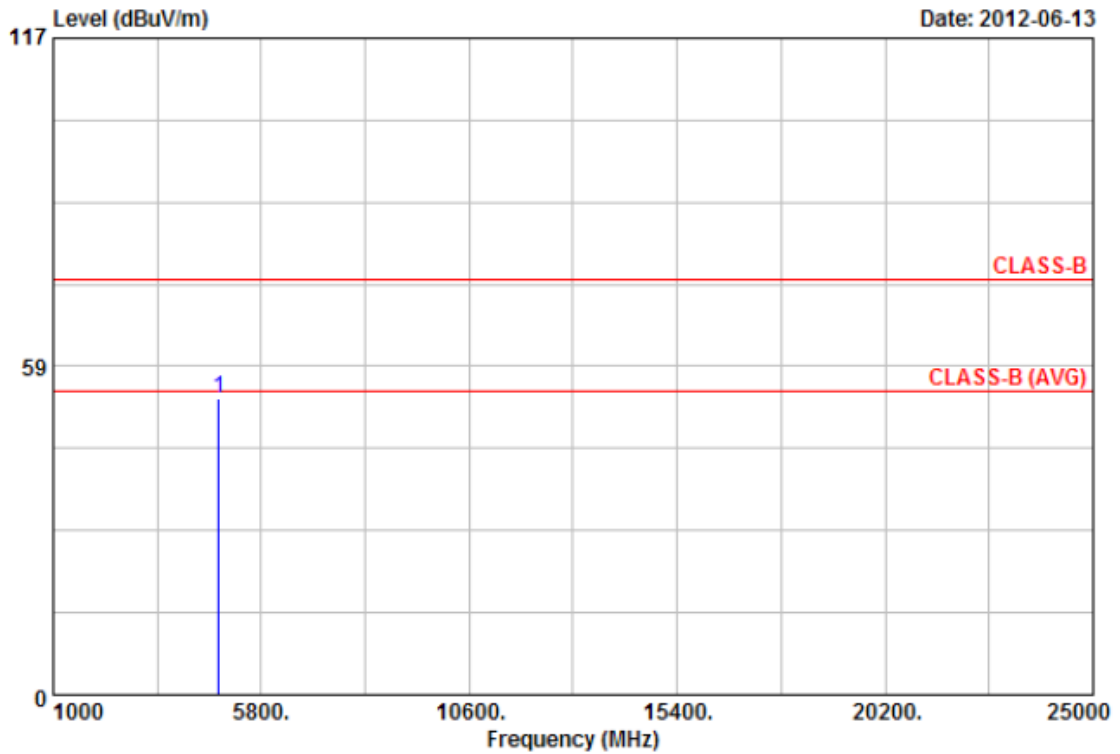

Item	Freq	Read Value	Factor	Result	Limit	Margin	Remark	Ant Pos	Tab Pos
	MHz	dBuV	dB/m	dBuV/m	dBuV/m	dB		cm	Deg
1	4823.75	48.93	3.94	52.87	74.00	-21.13	Peak	100	195

Notes:

1. Result = Read Value + Factor
2. Factor = Antenna Factor + Cable Loss - Amplifier
3. The resolution bandwidth of test receiver/spectrum analyzer is 120KHz and video bandwidth is 300kHz for Peak detection and Quasi-peak detection at frequency below 1GHz.
4. The resolution bandwidth of test receiver/spectrum analyzer is 1MHz and video bandwidth is 3MHz for Peak detection at frequency above 1GHz.
5. The resolution bandwidth of test receiver/spectrum analyzer is 1MHz and video bandwidth is 3MHz (detector sample mode) for Average detection at frequency above 1GHz.
6. The other emissions is too low to be measured.
7. The data is worse case.



Power	: FROM SYSTEM	Pol/Phase	: VERTICAL
Test Mode 1	: 802.11b, CH6	Temperature	: 22 °C
Memo	:	Humidity	: 65 %

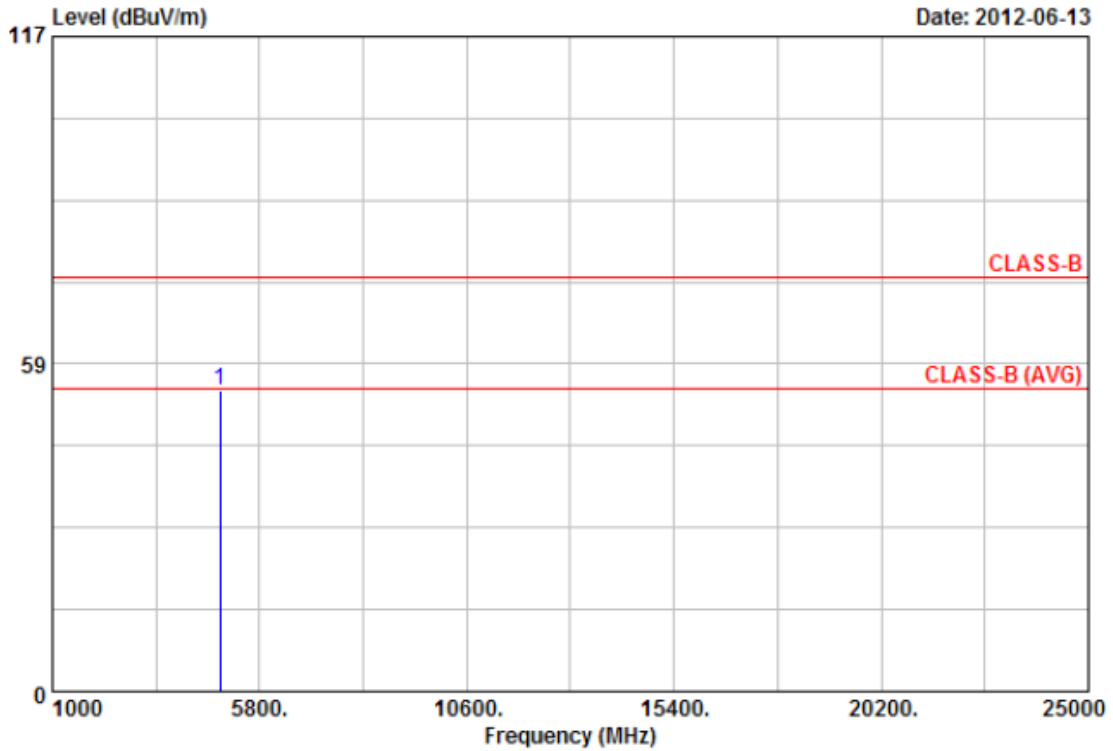

Item	Freq	Read Value	Factor	Result	Limit	Margin	Remark	Ant Pos	Tab Pos
	MHz	dBuV	dB/m	dBuV/m	dBuV/m	dB		cm	Deg
1	4873.95	47.15	6.59	53.74	74.00	-20.26	Peak	100	196

Notes:

1. Result = Read Value + Factor
2. Factor = Antenna Factor + Cable Loss - Amplifier
3. The resolution bandwidth of test receiver/spectrum analyzer is 120KHz and video bandwidth is 300kHz for Peak detection and Quasi-peak detection at frequency below 1GHz.
4. The resolution bandwidth of test receiver/spectrum analyzer is 1MHz and video bandwidth is 3MHz for Peak detection at frequency above 1GHz.
5. The resolution bandwidth of test receiver/spectrum analyzer is 1MHz and video bandwidth is 3MHz (detector sample mode) for Average detection at frequency above 1GHz.
6. The other emissions is too low to be measured.
7. The data is worse case.



Power	: FROM SYSTEM	Pol/Phase	: HORIZONTAL
Test Mode 1	: 802.11b, CH6	Temperature	: 22 °C
Memo	:	Humidity	: 65 %

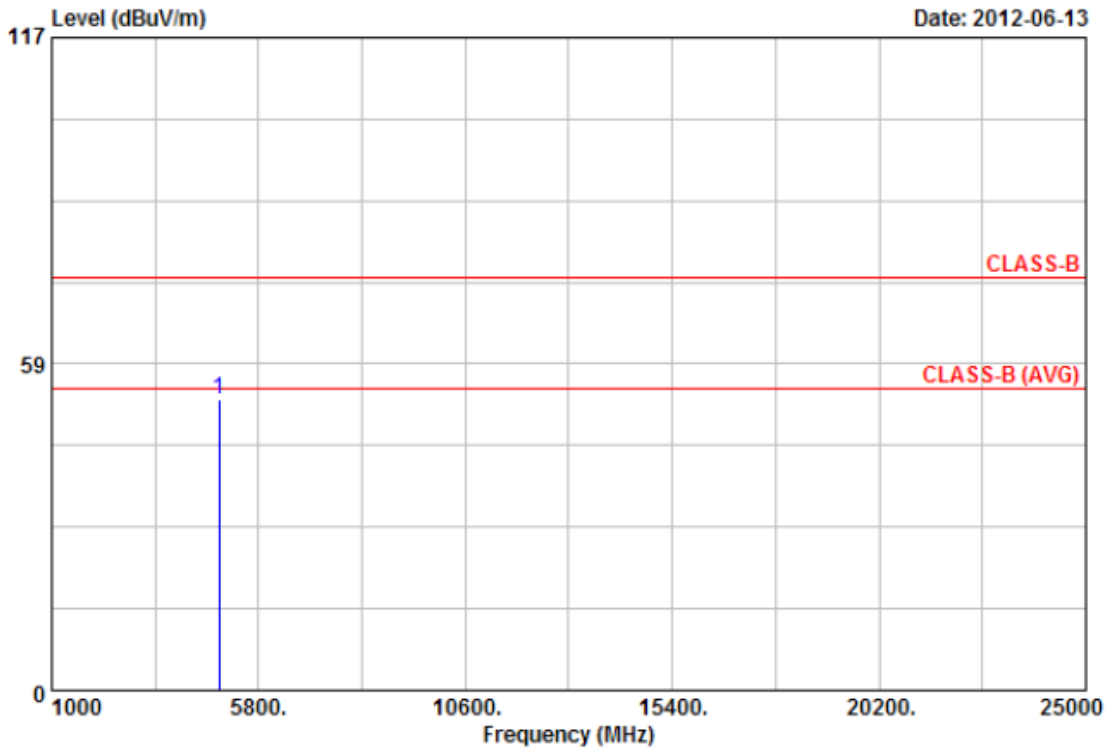

Item	Freq	Read Value	Factor	Result	Limit	Margin	Remark	Ant Pos	Tab Pos
	MHz	dBuV	dB/m	dBuV/m	dBuV/m	dB		cm	Deg
1	4873.95	47.29	4.73	52.02	74.00	-21.98	Peak	100	196

Notes:

1. Result = Read Value + Factor
2. Factor = Antenna Factor + Cable Loss - Amplifier
3. The resolution bandwidth of test receiver/spectrum analyzer is 120KHz and video bandwidth is 300kHz for Peak detection and Quasi-peak detection at frequency below 1GHz.
4. The resolution bandwidth of test receiver/spectrum analyzer is 1MHz and video bandwidth is 3MHz for Peak detection at frequency above 1GHz.
5. The resolution bandwidth of test receiver/spectrum analyzer is 1MHz and video bandwidth is 3MHz (detector sample mode) for Average detection at frequency above 1GHz.
6. The other emissions is too low to be measured.
7. The data is worse case.



Power	: FROM SYSTEM	Pol/Phase	: VERTICAL
Test Mode 1	: 802.11b, CH11	Temperature	: 22 °C
Memo	:	Humidity	: 65 %

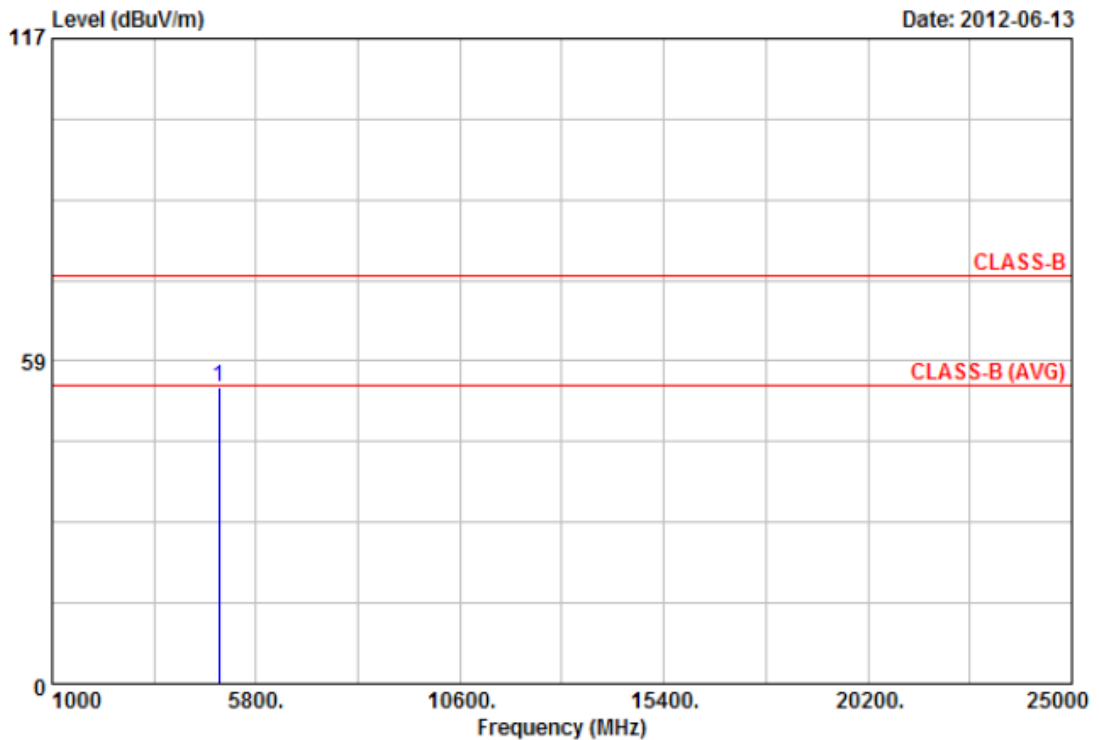

Item	Freq	Read Value	Factor	Result	Limit	Margin	Remark	Ant Pos	Tab Pos
	MHz	dBuV	dB/m	dBuV/m	dBuV/m	dB		cm	Deg
1	4924.10	46.68	7.16	53.84	74.00	-20.16	Peak	100	196

Notes:

1. Result = Read Value + Factor
2. Factor = Antenna Factor + Cable Loss - Amplifier
3. The resolution bandwidth of test receiver/spectrum analyzer is 120KHz and video bandwidth is 300kHz for Peak detection and Quasi-peak detection at frequency below 1GHz.
4. The resolution bandwidth of test receiver/spectrum analyzer is 1MHz and video bandwidth is 3MHz for Peak detection at frequency above 1GHz.
5. The resolution bandwidth of test receiver/spectrum analyzer is 1MHz and video bandwidth is 3MHz (detector sample mode) for Average detection at frequency above 1GHz.
6. The other emissions is too low to be measured.
7. The data is worse case.



Power	: FROM SYSTEM	Pol/Phase	: HORIZONTAL
Test Mode 1	: 802.11b, CH11	Temperature	: 22 °C
Memo	:	Humidity	: 65 %

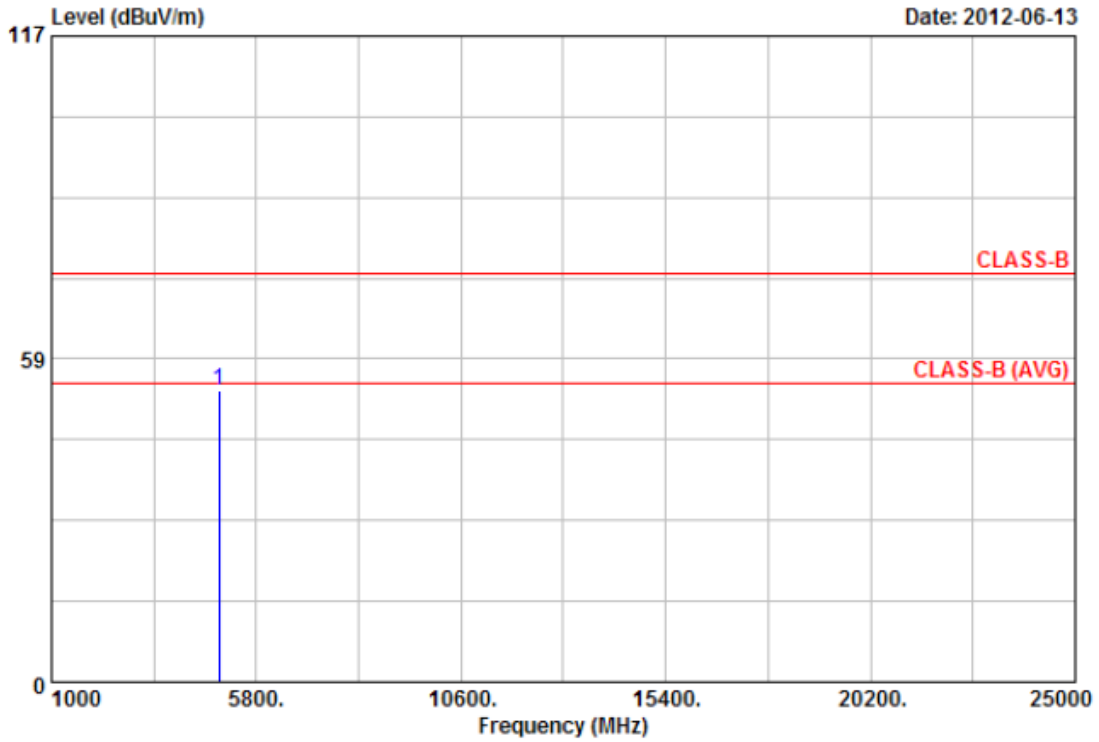

Item	Freq	Read Value	Factor	Result	Limit	Margin	Remark	Ant Pos	Tab Pos
	MHz	dBuV	dB/m	dBuV/m	dBuV/m	dB		cm	Deg
1	4927.18	47.79	5.15	52.94	74.00	-21.06	Peak	100	196

Notes:

1. Result = Read Value + Factor
2. Factor = Antenna Factor + Cable Loss - Amplifier
3. The resolution bandwidth of test receiver/spectrum analyzer is 120KHz and video bandwidth is 300kHz for Peak detection and Quasi-peak detection at frequency below 1GHz.
4. The resolution bandwidth of test receiver/spectrum analyzer is 1MHz and video bandwidth is 3MHz for Peak detection at frequency above 1GHz.
5. The resolution bandwidth of test receiver/spectrum analyzer is 1MHz and video bandwidth is 3MHz (detector sample mode) for Average detection at frequency above 1GHz.
6. The other emissions is too low to be measured.
7. The data is worse case.



Power	: FROM SYSTEM	Pol/Phase	: VERTICAL
Test Mode 1	: 802.11g, CH1	Temperature	: 22 °C
Memo	:	Humidity	: 65 %

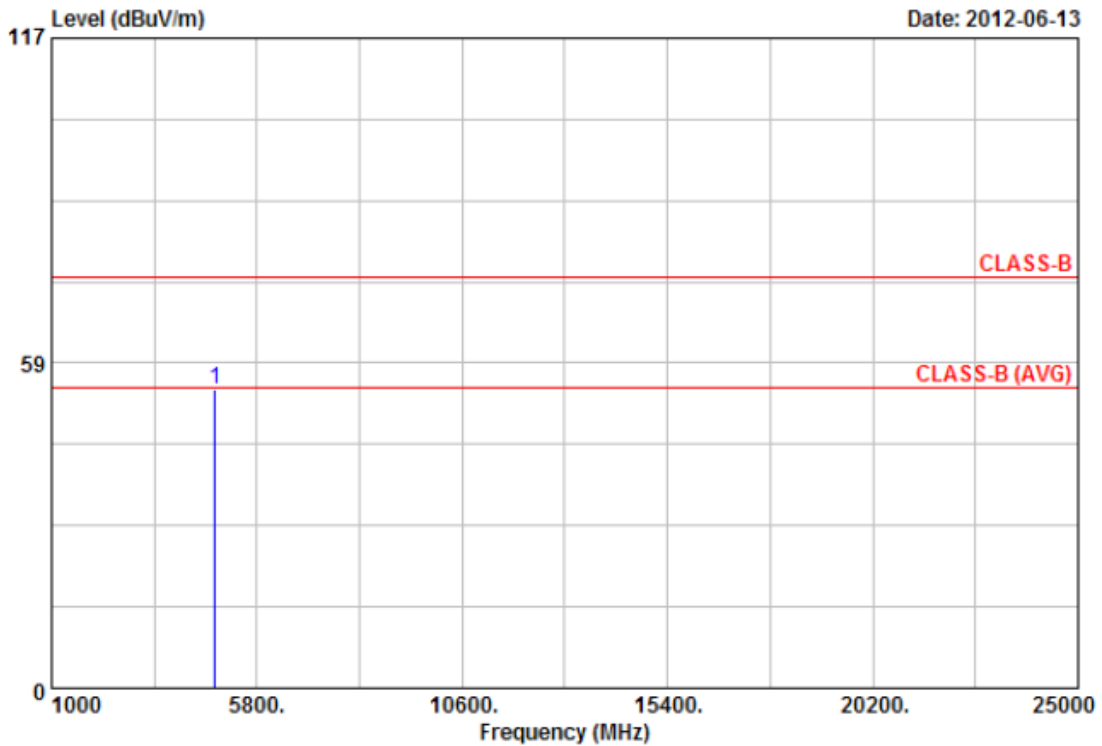

Item	Freq	Read Value	Factor	Result	Limit	Margin	Remark	Ant Pos	Tab Pos
	MHz	dBuV	dB/m	dBuV/m	dBuV/m	dB		cm	Deg
1	4824.40	48.27	5.62	53.89	74.00	-20.11	Peak	100	196

Notes:

1. Result = Read Value + Factor
2. Factor = Antenna Factor + Cable Loss - Amplifier
3. The resolution bandwidth of test receiver/spectrum analyzer is 120KHz and video bandwidth is 300kHz for Peak detection and Quasi-peak detection at frequency below 1GHz.
4. The resolution bandwidth of test receiver/spectrum analyzer is 1MHz and video bandwidth is 3MHz for Peak detection at frequency above 1GHz.
5. The resolution bandwidth of test receiver/spectrum analyzer is 1MHz and video bandwidth is 3MHz (detector sample mode) for Average detection at frequency above 1GHz.
6. The other emissions is too low to be measured.
7. The data is worse case.



Power	: FROM SYSTEM	Pol/Phase	: HORIZONTAL
Test Mode 1	: 802.11g, CH1	Temperature	: 22 °C
Memo	:	Humidity	: 65 %

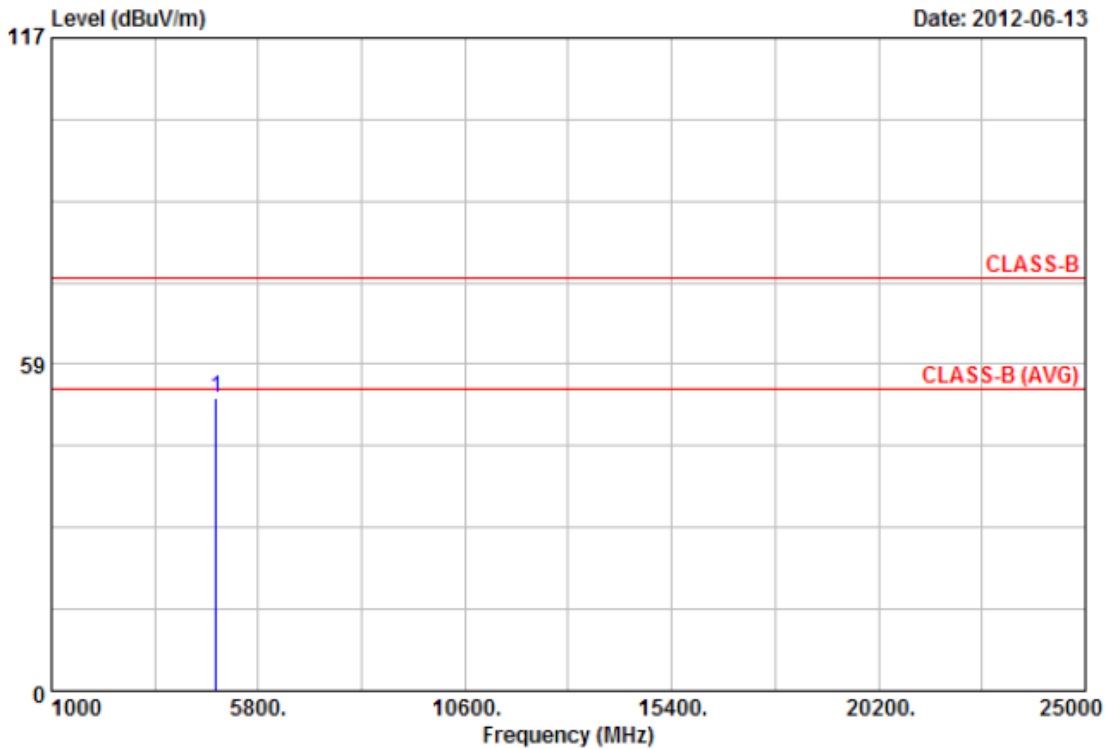

Item	Freq	Read Value	Factor	Result	Limit	Margin	Remark	Ant Pos	Tab Pos
	MHz	dBuV	dB/m	dBuV/m	dBuV/m	dB		cm	Deg
1	4823.05	48.54	3.93	52.47	74.00	-21.53	Peak	100	196

Notes:

1. Result = Read Value + Factor
2. Factor = Antenna Factor + Cable Loss - Amplifier
3. The resolution bandwidth of test receiver/spectrum analyzer is 120KHz and video bandwidth is 300kHz for Peak detection and Quasi-peak detection at frequency below 1GHz.
4. The resolution bandwidth of test receiver/spectrum analyzer is 1MHz and video bandwidth is 3MHz for Peak detection at frequency above 1GHz.
5. The resolution bandwidth of test receiver/spectrum analyzer is 1MHz and video bandwidth is 3MHz (detector sample mode) for Average detection at frequency above 1GHz.
6. The other emissions is too low to be measured.
7. The data is worse case.



Power	: FROM SYSTEM	Pol/Phase	: VERTICAL
Test Mode 1	: 802.11g, CH6	Temperature	: 22 °C
Memo	:	Humidity	: 65 %

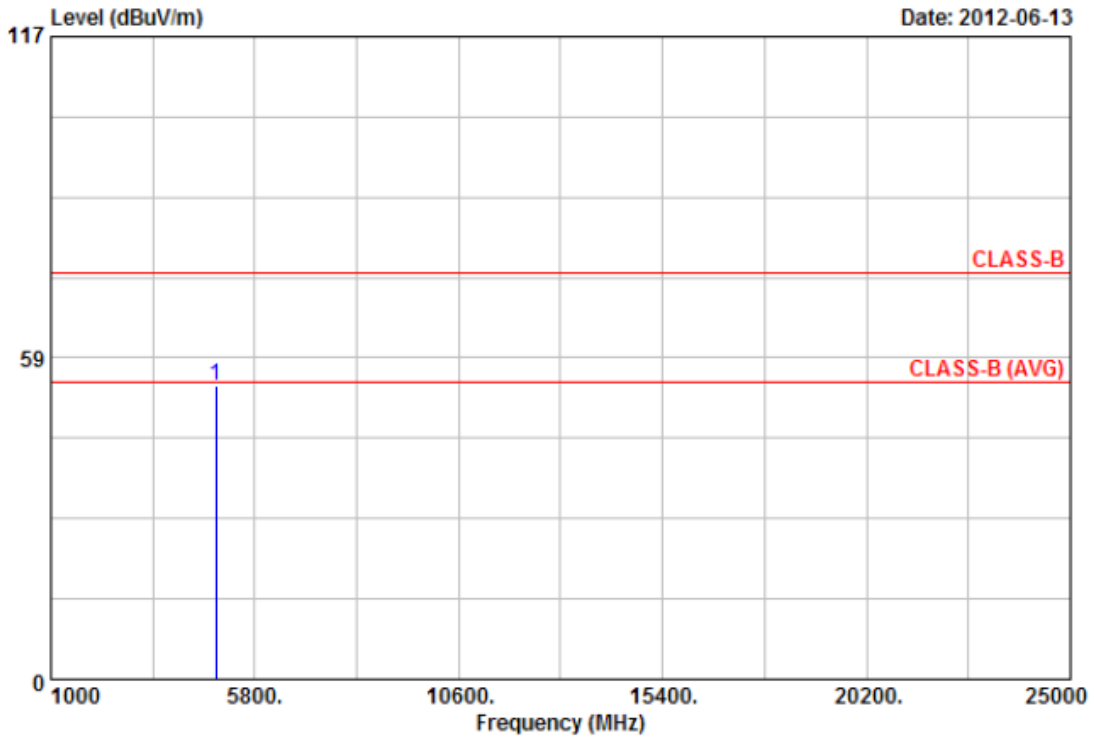

Item	Freq	Read Value	Factor	Result	Limit	Margin	Remark	Ant Pos	Tab Pos
	MHz	dBuV	dB/m	dBuV/m	dBuV/m	dB		cm	Deg
1	4873.40	47.03	6.58	53.61	74.00	-20.39	Peak	100	196

Notes:

1. Result = Read Value + Factor
2. Factor = Antenna Factor + Cable Loss - Amplifier
3. The resolution bandwidth of test receiver/spectrum analyzer is 120KHz and video bandwidth is 300kHz for Peak detection and Quasi-peak detection at frequency below 1GHz.
4. The resolution bandwidth of test receiver/spectrum analyzer is 1MHz and video bandwidth is 3MHz for Peak detection at frequency above 1GHz.
5. The resolution bandwidth of test receiver/spectrum analyzer is 1MHz and video bandwidth is 3MHz (detector sample mode) for Average detection at frequency above 1GHz.
6. The other emissions is too low to be measured.
7. The data is worse case.





Power	: FROM SYSTEM	Pol/Phase	: HORIZONTAL
Test Mode 1	: 802.11g, CH6	Temperature	: 22 °C
Memo	:	Humidity	: 65 %

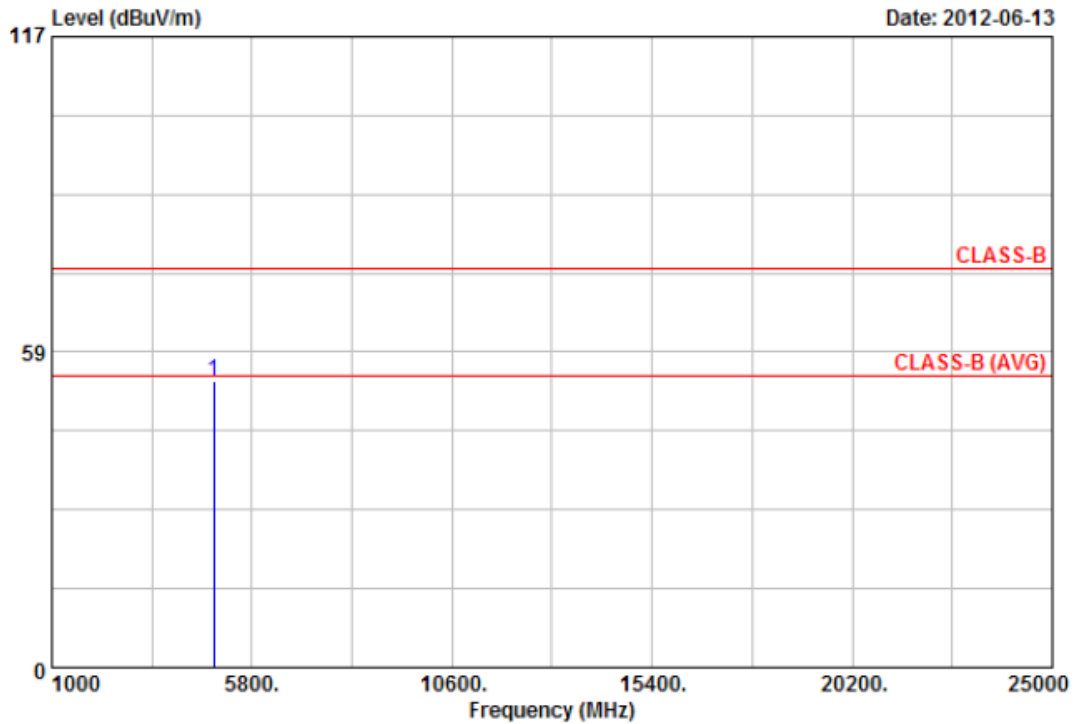

Item	Freq	Read Value	Factor	Result	Limit	Margin	Remark	Ant Pos	Tab Pos
	MHz	dBuV	dB/m	dBuV/m	dBuV/m	dB		cm	Deg
1	4873.28	48.27	4.72	52.99	74.00	-21.01	Peak	100	196

Notes:

1. Result = Read Value + Factor
2. Factor = Antenna Factor + Cable Loss - Amplifier
3. The resolution bandwidth of test receiver/spectrum analyzer is 120KHz and video bandwidth is 300kHz for Peak detection and Quasi-peak detection at frequency below 1GHz.
4. The resolution bandwidth of test receiver/spectrum analyzer is 1MHz and video bandwidth is 3MHz for Peak detection at frequency above 1GHz.
5. The resolution bandwidth of test receiver/spectrum analyzer is 1MHz and video bandwidth is 3MHz (detector sample mode) for Average detection at frequency above 1GHz.
6. The other emissions is too low to be measured.
7. The data is worse case.



Power	: FROM SYSTEM	Pol/Phase	: VERTICAL
Test Mode 1	: 802.11g, CH11	Temperature	: 22 °C
Memo	:	Humidity	: 65 %

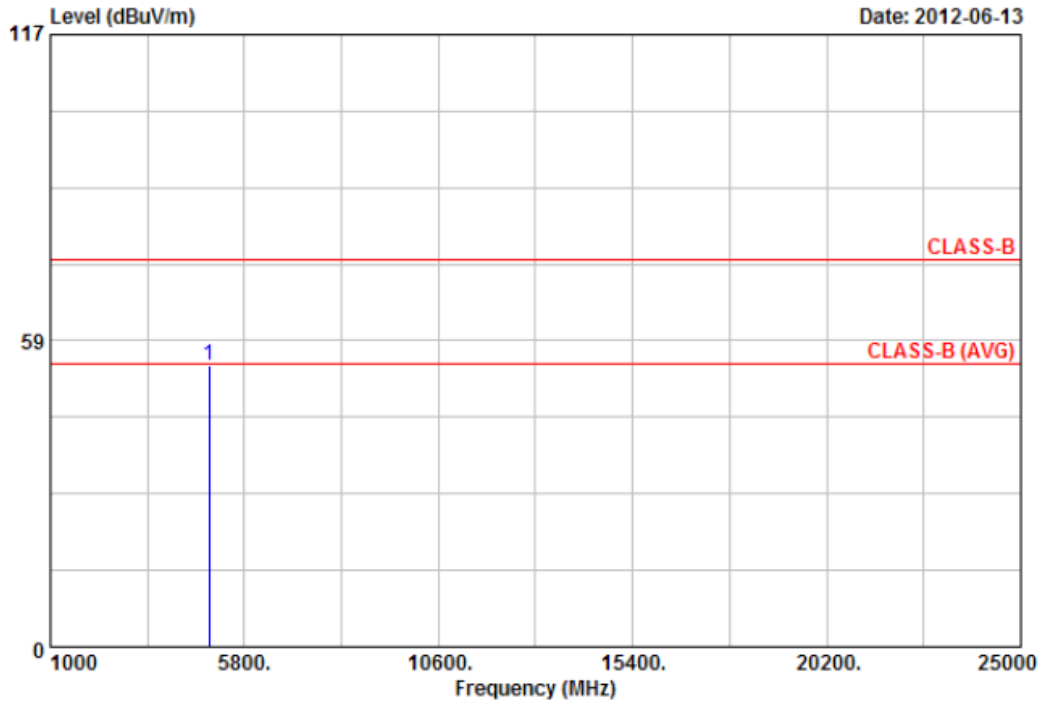

Item	Freq	Read Value	Factor	Result	Limit	Margin	Remark	Ant Pos	Tab Pos
	MHz	dBuV	dB/m	dBuV/m	dBuV/m	dB		cm	Deg
1	4922.10	46.69	7.15	53.84	74.00	-20.16	Peak	100	196

Notes:

1. Result = Read Value + Factor
2. Factor = Antenna Factor + Cable Loss - Amplifier
3. The resolution bandwidth of test receiver/spectrum analyzer is 120KHz and video bandwidth is 300kHz for Peak detection and Quasi-peak detection at frequency below 1GHz.
4. The resolution bandwidth of test receiver/spectrum analyzer is 1MHz and video bandwidth is 3MHz for Peak detection at frequency above 1GHz.
5. The resolution bandwidth of test receiver/spectrum analyzer is 1MHz and video bandwidth is 3MHz (detector sample mode) for Average detection at frequency above 1GHz.
6. The other emissions is too low to be measured.
7. The data is worse case.



Power	: FROM SYSTEM	Pol/Phase	: HORIZONTAL
Test Mode 1	: 802.11g, CH11	Temperature	: 22 °C
Memo	:	Humidity	: 65 %

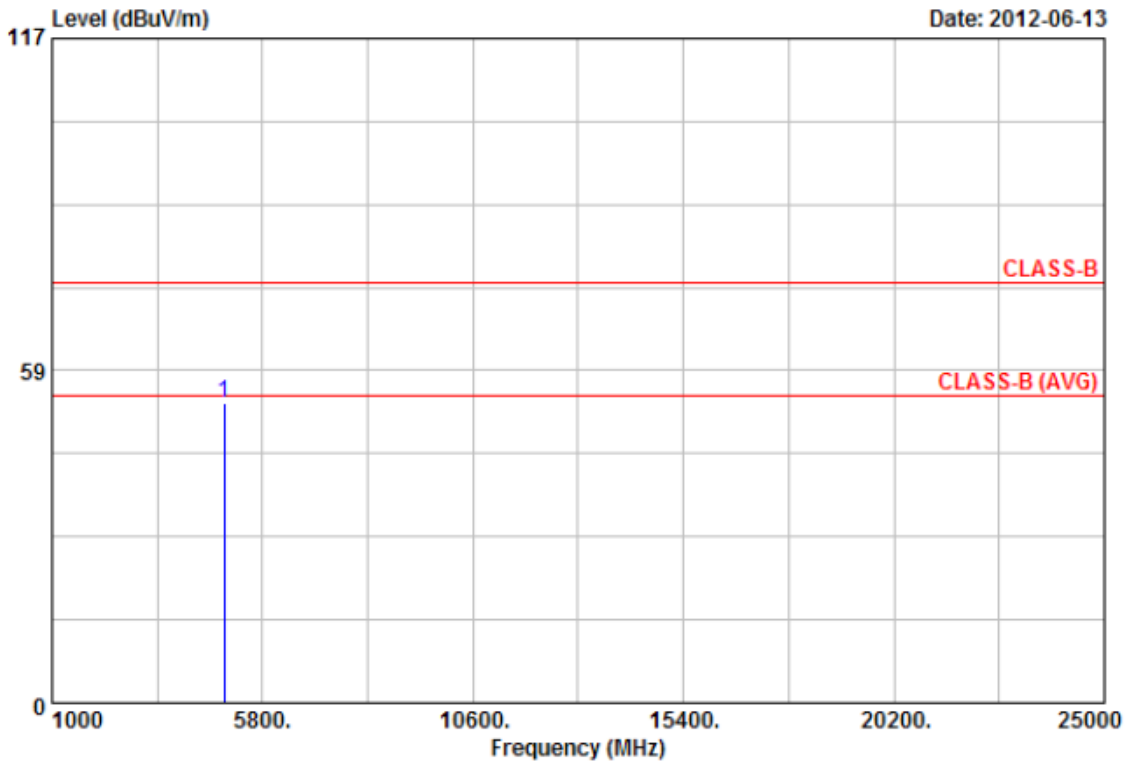

Item	Freq	Read Value	Factor	Result	Limit	Margin	Remark	Ant Pos	Tab Pos
	MHz	dBuV	dB/m	dBuV/m	dBuV/m	dB		cm	Deg
1	4922.75	47.57	5.15	52.72	74.00	-21.28	Peak	100	196

Notes:

1. Result = Read Value + Factor
2. Factor = Antenna Factor + Cable Loss - Amplifier
3. The resolution bandwidth of test receiver/spectrum analyzer is 120KHz and video bandwidth is 300kHz for Peak detection and Quasi-peak detection at frequency below 1GHz.
4. The resolution bandwidth of test receiver/spectrum analyzer is 1MHz and video bandwidth is 3MHz for Peak detection at frequency above 1GHz.
5. The resolution bandwidth of test receiver/spectrum analyzer is 1MHz and video bandwidth is 3MHz (detector sample mode) for Average detection at frequency above 1GHz.
6. The other emissions is too low to be measured.
7. The data is worse case.



Power	: FROM SYSTEM	Pol/Phase	: VERTICAL
Test Mode 2	: 802.11n HT20, CH1	Temperature	: 25 °C
Memo	:	Humidity	: 65 %

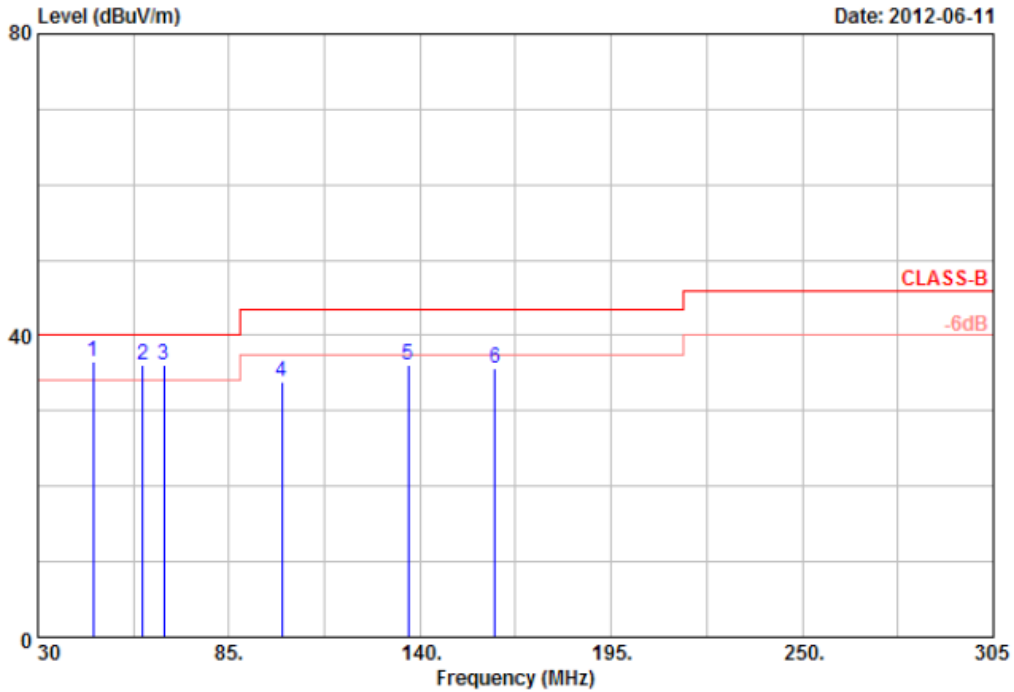

Item	Freq	Read Value	Factor	Result	Limit	Margin	Remark	Ant Pos	Tab Pos
	MHz	dBuV	dB/m	dBuV/m	dBuV/m	dB		cm	Deg
1	45.95	38.74	-2.20	36.54	40.00	-3.46	QP	100	0
2	60.25	46.92	-10.86	36.06	40.00	-3.94	QP	100	0
3	66.30	47.78	-11.61	36.17	40.00	-3.83	QP	100	0
4	100.13	42.59	-8.69	33.90	43.50	-9.60	Peak	100	0
5	136.70	42.71	-6.62	36.09	43.50	-7.41	Peak	100	0
6	161.45	46.07	-10.40	35.67	43.50	-7.83	Peak	100	0

Notes:

1. Result = Read Value + Factor
2. Factor = Antenna Factor + Cable Loss - Amplifier
3. The resolution bandwidth of test receiver/spectrum analyzer is 120KHz and video bandwidth is 300kHz for Peak detection and Quasi-peak detection at frequency below 1GHz.
4. All emission below 1GHz at 802.11b/g/n mode are all the same,so the 802.11g/n mode chosen as representative in final test.
5. According to technical experiences,all spurious emission of 802.11g/n mode at channel 1,6,11 or 3,6,9(for HT40) are almost the same below 1GHz,so that the channel 1 or 3(for HT40)was chosen as representative in final test.
6. The data is worse case.



Power	: FROM SYSTEM	Pol/Phase	: VERTICAL
Test Mode 2	: 802.11n HT20, CH1	Temperature	: 25 °C
Memo	:	Humidity	: 65 %

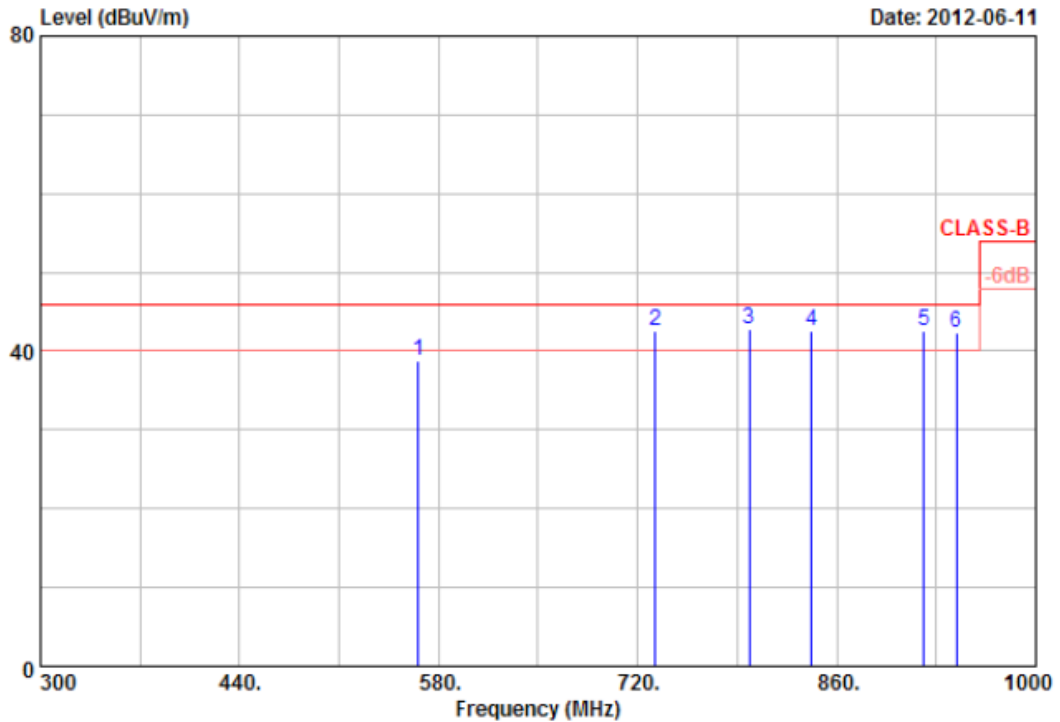

Item	Freq	Read Value	Factor	Result	Limit	Margin	Remark	Ant Pos	Tab Pos
	MHz	dBuV	dB/m	dBuV/m	dBuV/m	dB		cm	Deg
1	566.00	31.98	6.78	38.76	46.00	-7.24	Peak	100	0
2	732.60	35.48	7.02	42.50	46.00	-3.50	QP	100	0
3	798.40	36.90	5.82	42.72	46.00	-3.28	QP	100	0
4	842.50	33.26	9.33	42.59	46.00	-3.41	QP	100	0
5	921.60	33.02	9.54	42.56	46.00	-3.44	QP	100	0
6	944.00	30.80	11.47	42.27	46.00	-3.73	QP	100	0

Notes:

1. Result = Read Value + Factor
2. Factor = Antenna Factor + Cable Loss - Amplifier
3. The resolution bandwidth of test receiver/spectrum analyzer is 120KHz and video bandwidth is 300kHz for Peak detection and Quasi-peak detection at frequency below 1GHz.
4. All emission below 1GHz at 802.11b/g/n mode are all the same,so the 802.11g/n mode chosen as representative in final test.
5. According to technical experiences,all spurious emission of 802.11g/n mode at channel 1,6,11 or 3,6,9(for HT40) are almost the same below 1GHz,so that the channel 1 or 3(for HT40)was chosen as representative in final test.
6. The data is worse case.



Power	: FROM SYSTEM	Pol/Phase	: HORIZONTAL
Test Mode 2	: 802.11n HT20, CH1	Temperature	: 25 °C
Memo	:	Humidity	: 65 %

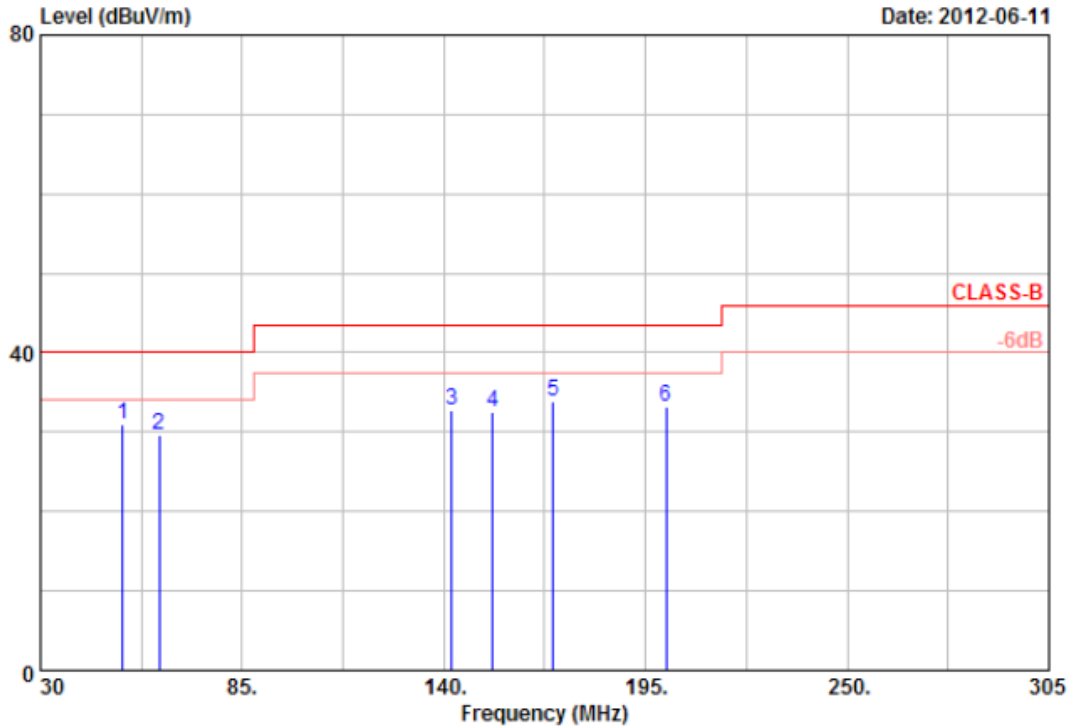

Item	Freq	Read Value	Factor	Result	Limit	Margin	Remark	Ant Pos	Tab Pos
	MHz	dBuV	dB/m	dBuV/m	dBuV/m	dB		cm	Deg
1	52.55	41.30	-10.41	30.89	40.00	-9.11	Peak	100	0
2	62.45	47.99	-18.28	29.71	40.00	-10.29	Peak	100	0
3	142.20	47.38	-14.65	32.73	43.50	-10.77	Peak	100	0
4	153.20	47.88	-15.27	32.61	43.50	-10.89	Peak	100	0
5	169.70	45.19	-11.27	33.92	43.50	-9.58	Peak	100	0
6	200.50	51.98	-18.72	33.26	43.50	-10.24	Peak	100	0

Notes:

1. Result = Read Value + Factor
2. Factor = Antenna Factor + Cable Loss - Amplifier
3. The resolution bandwidth of test receiver/spectrum analyzer is 120KHz and video bandwidth is 300kHz for Peak detection and Quasi-peak detection at frequency below 1GHz.
4. All emission below 1GHz at 802.11b/g/n mode are all the same, so the 802.11g/n mode chosen as representative in final test.
5. According to technical experiences, all spurious emission of 802.11g/n mode at channel 1,6,11 or 3,6,9(for HT40) are almost the same below 1GHz, so that the channel 1 or 3(for HT40) was chosen as representative in final test.
6. The data is worse case.



Power	: FROM SYSTEM	Pol/Phase	: HORIZONTAL
Test Mode 2	: 802.11n HT20, CH1	Temperature	: 25 °C
Memo	:	Humidity	: 65 %

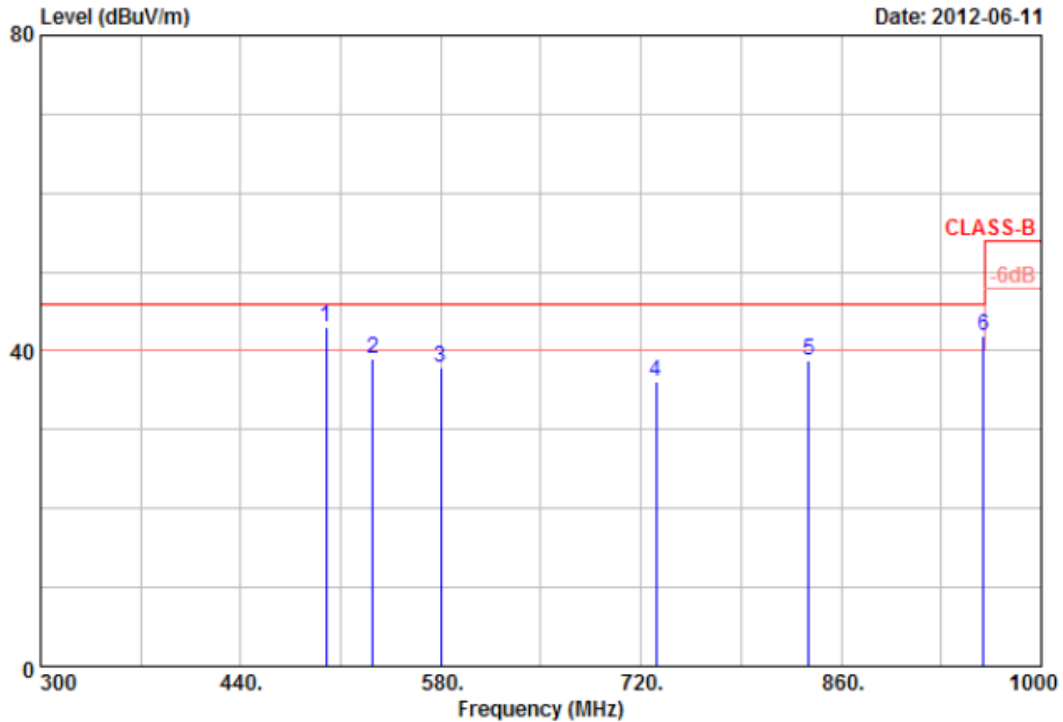

Item	Freq	Read Value	Factor	Result	Limit	Margin	Remark	Ant Pos	Tab Pos
	MHz	dBuV	dB/m	dBuV/m	dBuV/m	dB		cm	Deg
1	499.50	43.12	-0.22	42.90	46.00	-3.10	QP	100	0
2	532.40	37.07	2.00	39.07	46.00	-6.93	Peak	100	0
3	580.00	35.08	2.86	37.94	46.00	-8.06	Peak	100	0
4	730.50	31.98	4.09	36.07	46.00	-9.93	Peak	100	0
5	837.60	30.00	8.75	38.75	46.00	-7.25	Peak	100	0
6	959.40	33.96	7.97	41.93	46.00	-4.07	QP	100	0

Notes:

1. Result = Read Value + Factor
2. Factor = Antenna Factor + Cable Loss - Amplifier
3. The resolution bandwidth of test receiver/spectrum analyzer is 120KHz and video bandwidth is 300kHz for Peak detection and Quasi-peak detection at frequency below 1GHz.
4. All emission below 1GHz at 802.11b/g/n mode are all the same,so the 802.11g/n mode chosen as representative in final test.
5. According to technical experiences,all spurious emission of 802.11g/n mode at channel 1,6,11 or 3,6,9(for HT40) are almost the same below 1GHz,so that the channel 1 or 3(for HT40)was chosen as representative in final test.
6. The data is worse case.



Power	: FROM SYSTEM	Pol/Phase	: VERTICAL
Test Mode 2	: 802.11n HT20, CH1	Temperature	: 22 °C
Memo	:	Humidity	: 65 %

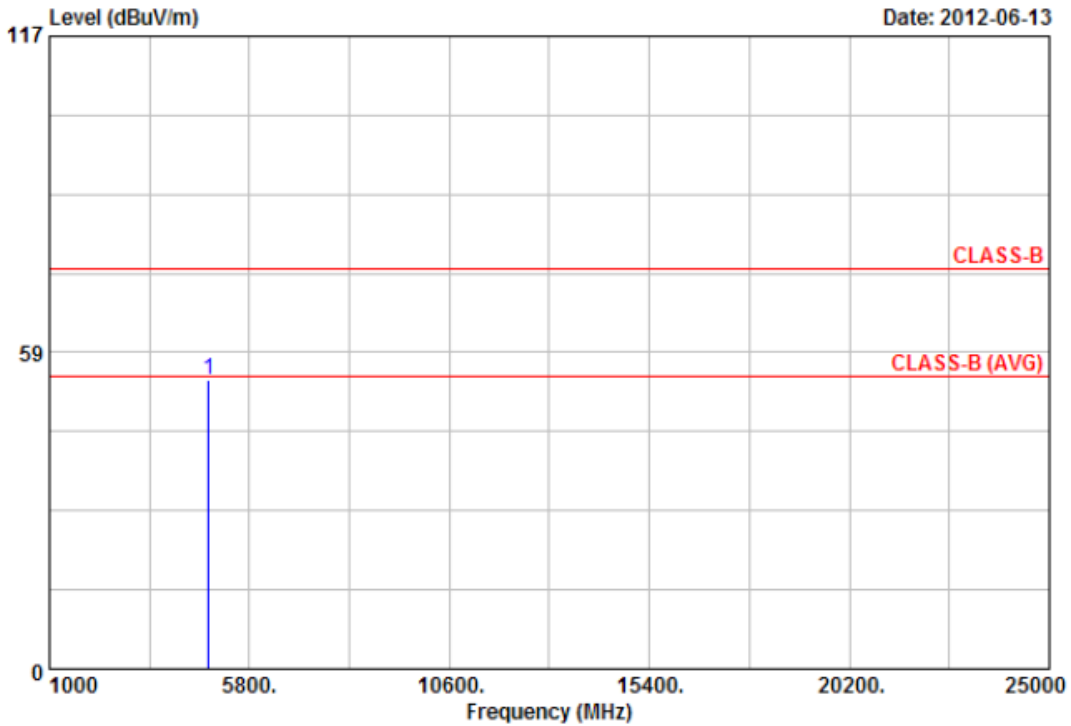

Item	Freq	Read Value	Factor	Result	Limit	Margin	Remark	Ant Pos	Tab Pos
	MHz	dBuV	dB/m	dBuV/m	dBuV/m	dB		cm	Deg
1	4824.10	47.79	5.61	53.40	74.00	-20.60	Peak	100	196

Notes:

1. Result = Read Value + Factor
2. Factor = Antenna Factor + Cable Loss - Amplifier
3. The resolution bandwidth of test receiver/spectrum analyzer is 120KHz and video bandwidth is 300kHz for Peak detection and Quasi-peak detection at frequency below 1GHz.
4. The resolution bandwidth of test receiver/spectrum analyzer is 1MHz and video bandwidth is 3MHz for Peak detection at frequency above 1GHz.
5. The resolution bandwidth of test receiver/spectrum analyzer is 1MHz and video bandwidth is 3MHz (detector sample mode) for Average detection at frequency above 1GHz.
6. The other emissions is too low to be measured.
7. The data is worse case.





Power	: FROM SYSTEM	Pol/Phase	: HORIZONTAL
Test Mode 2	: 802.11n HT20, CH1	Temperature	: 22 °C
Memo	:	Humidity	: 65 %

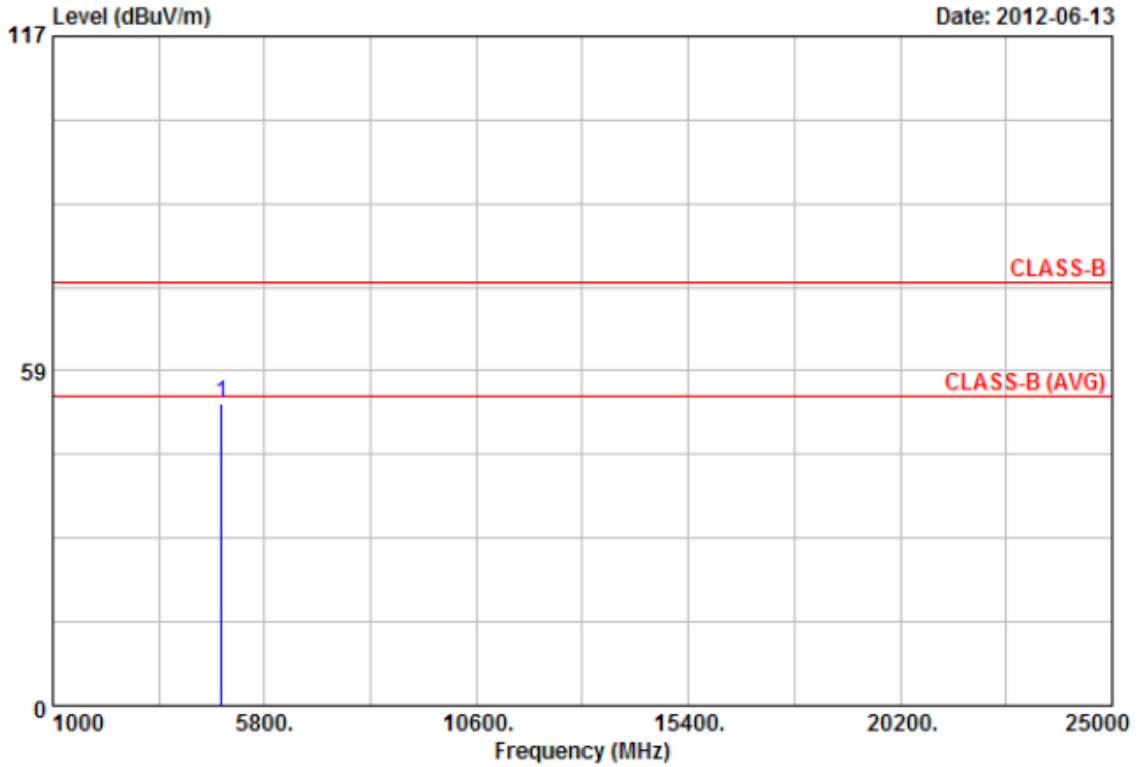

Item	Freq	Read Value	Factor	Result	Limit	Margin	Remark	Ant Pos	Tab Pos
	MHz	dBuV	dB/m	dBuV/m	dBuV/m	dB		cm	Deg
1	4822.80	48.79	3.93	52.72	74.00	-21.28	Peak	100	196

Notes:

1. Result = Read Value + Factor
2. Factor = Antenna Factor + Cable Loss - Amplifier
3. The resolution bandwidth of test receiver/spectrum analyzer is 120KHz and video bandwidth is 300kHz for Peak detection and Quasi-peak detection at frequency below 1GHz.
4. The resolution bandwidth of test receiver/spectrum analyzer is 1MHz and video bandwidth is 3MHz for Peak detection at frequency above 1GHz.
5. The resolution bandwidth of test receiver/spectrum analyzer is 1MHz and video bandwidth is 3MHz (detector sample mode) for Average detection at frequency above 1GHz.
6. The other emissions is too low to be measured.
7. The data is worse case.



Power	: FROM SYSTEM	Pol/Phase	: VERTICAL
Test Mode 2	: 802.11n HT20, CH6	Temperature	: 22 °C
Memo	:	Humidity	: 65 %

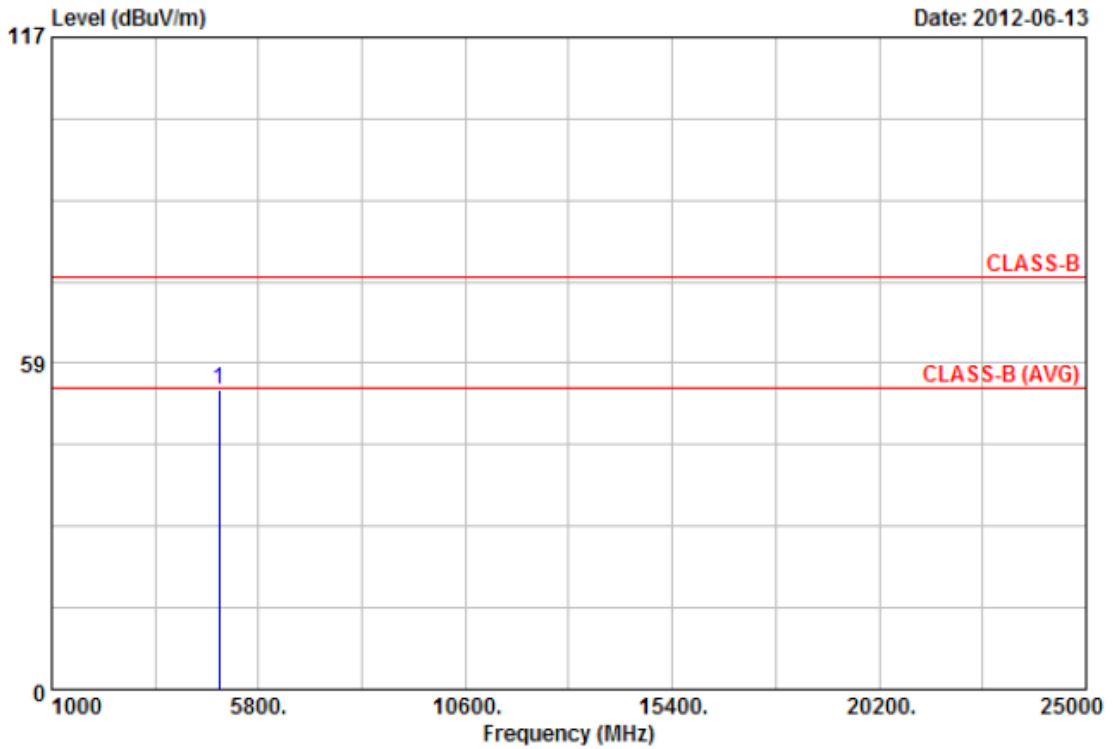

Item	Freq	Read Value	Factor	Result	Limit	Margin	Remark	Ant Pos	Tab Pos
	MHz	dBuV	dB/m	dBuV/m	dBuV/m	dB		cm	Deg
1	4874.70	47.17	6.60	53.77	74.00	-20.23	Peak	100	196

Notes:

1. Result = Read Value + Factor
2. Factor = Antenna Factor + Cable Loss - Amplifier
3. The resolution bandwidth of test receiver/spectrum analyzer is 120KHz and video bandwidth is 300kHz for Peak detection and Quasi-peak detection at frequency below 1GHz.
4. The resolution bandwidth of test receiver/spectrum analyzer is 1MHz and video bandwidth is 3MHz for Peak detection at frequency above 1GHz.
5. The resolution bandwidth of test receiver/spectrum analyzer is 1MHz and video bandwidth is 3MHz (detector sample mode) for Average detection at frequency above 1GHz.
6. The other emissions is too low to be measured.
7. The data is worse case.



Power	: FROM SYSTEM	Pol/Phase	: HORIZONTAL
Test Mode 2	: 802.11n HT20, CH6	Temperature	: 22 °C
Memo	:	Humidity	: 65 %

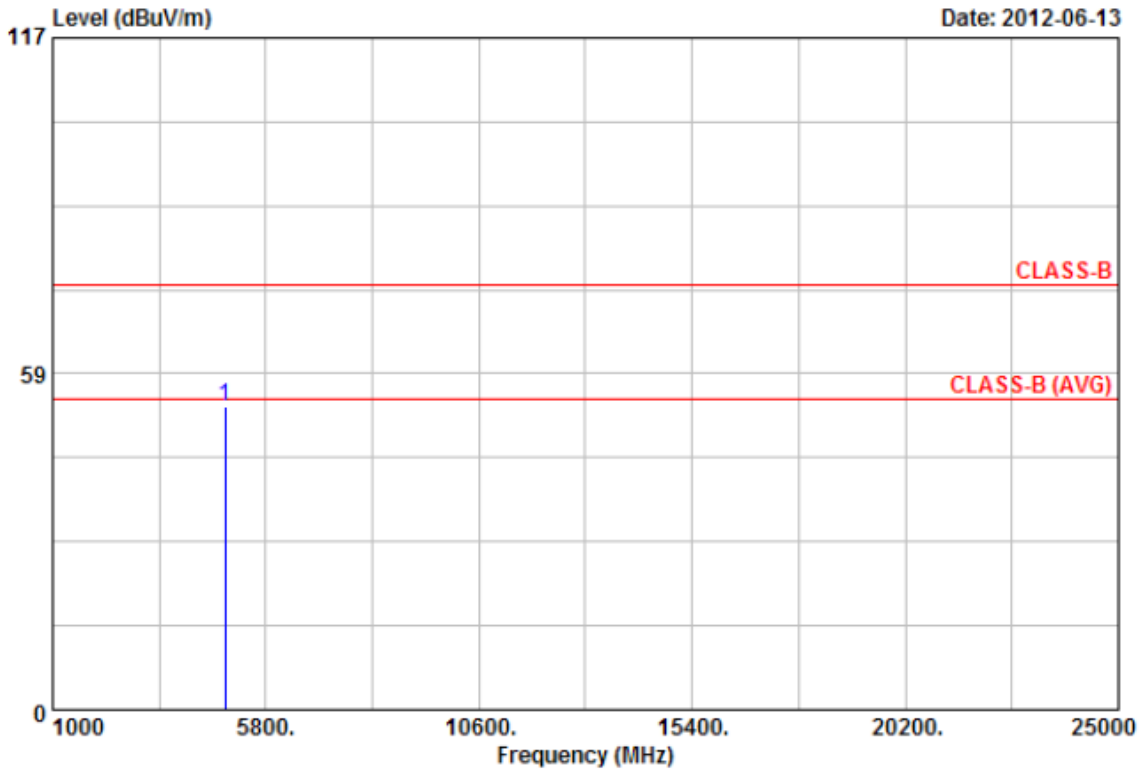

Item	Freq	Read Value	Factor	Result	Limit	Margin	Remark	Ant Pos	Tab Pos
	MHz	dBuV	dB/m	dBuV/m	dBuV/m	dB		cm	Deg
1	4875.45	48.11	4.76	52.87	74.00	-21.13	Peak	100	196

Notes:

1. Result = Read Value + Factor
2. Factor = Antenna Factor + Cable Loss - Amplifier
3. The resolution bandwidth of test receiver/spectrum analyzer is 120KHz and video bandwidth is 300kHz for Peak detection and Quasi-peak detection at frequency below 1GHz.
4. The resolution bandwidth of test receiver/spectrum analyzer is 1MHz and video bandwidth is 3MHz for Peak detection at frequency above 1GHz.
5. The resolution bandwidth of test receiver/spectrum analyzer is 1MHz and video bandwidth is 3MHz (detector sample mode) for Average detection at frequency above 1GHz.
6. The other emissions is too low to be measured.
7. The data is worse case.



Power	: FROM SYSTEM	Pol/Phase	: VERTICAL
Test Mode 2	: 802.11n HT20, CH11	Temperature	: 22 °C
Memo	:	Humidity	: 65 %

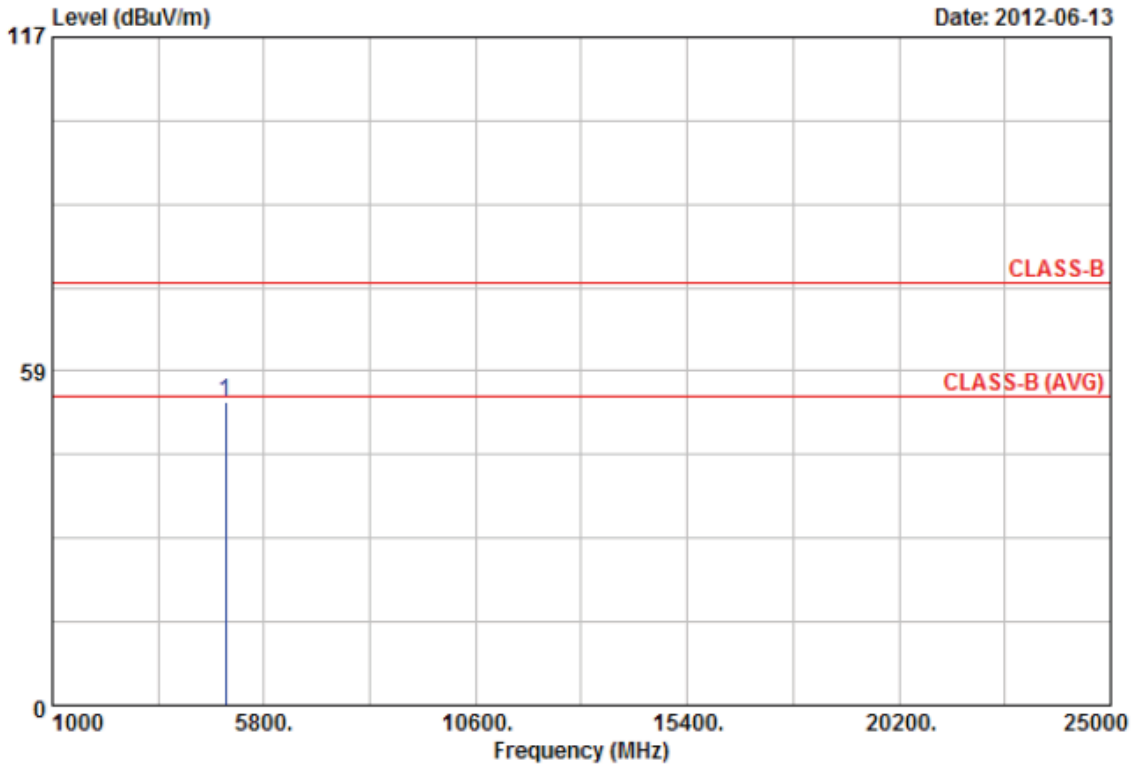

Item	Freq	Read Value	Factor	Result	Limit	Margin	Remark	Ant Pos	Tab Pos
	MHz	dBuV	dB/m	dBuV/m	dBuV/m	dB		cm	Deg
1	4924.80	46.03	7.16	53.19	74.00	-20.81	Peak	100	196

Notes:

1. Result = Read Value + Factor
2. Factor = Antenna Factor + Cable Loss - Amplifier
3. The resolution bandwidth of test receiver/spectrum analyzer is 120KHz and video bandwidth is 300kHz for Peak detection and Quasi-peak detection at frequency below 1GHz.
4. The resolution bandwidth of test receiver/spectrum analyzer is 1MHz and video bandwidth is 3MHz for Peak detection at frequency above 1GHz.
5. The resolution bandwidth of test receiver/spectrum analyzer is 1MHz and video bandwidth is 3MHz (detector sample mode) for Average detection at frequency above 1GHz.
6. The other emissions is too low to be measured.
7. The data is worse case.



Power	: FROM SYSTEM	Pol/Phase	: HORIZONTAL
Test Mode 2	: 802.11n HT20, CH11	Temperature	: 22 °C
Memo	:	Humidity	: 65 %

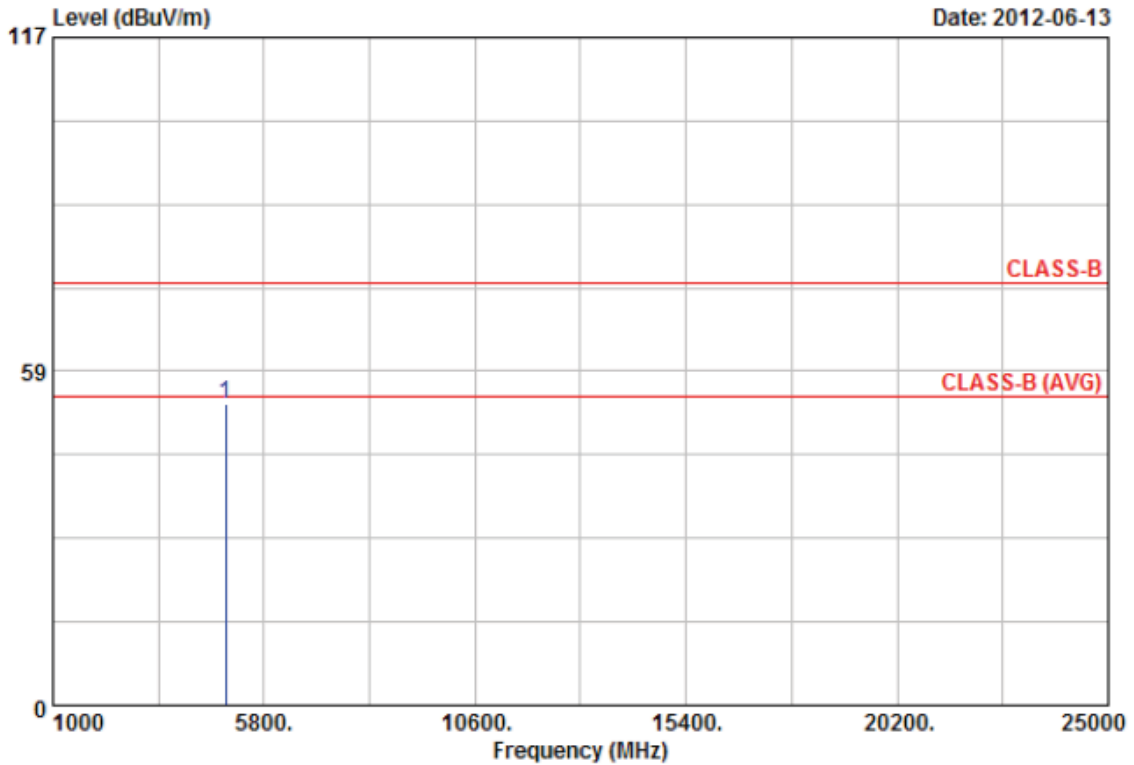

Item	Freq	Read Value	Factor	Result	Limit	Margin	Remark	Ant Pos	Tab Pos
	MHz	dBuV	dB/m	dBuV/m	dBuV/m	dB		cm	Deg
1	4923.38	47.49	5.15	52.64	74.00	-21.36	Peak	100	196

Notes:

1. Result = Read Value + Factor
2. Factor = Antenna Factor + Cable Loss - Amplifier
3. The resolution bandwidth of test receiver/spectrum analyzer is 120KHz and video bandwidth is 300kHz for Peak detection and Quasi-peak detection at frequency below 1GHz.
4. The resolution bandwidth of test receiver/spectrum analyzer is 1MHz and video bandwidth is 3MHz for Peak detection at frequency above 1GHz.
5. The resolution bandwidth of test receiver/spectrum analyzer is 1MHz and video bandwidth is 3MHz (detector sample mode) for Average detection at frequency above 1GHz.
6. The other emissions is too low to be measured.
7. The data is worse case.



Power	: FROM SYSTEM	Pol/Phase	: VERTICAL
Test Mode 3	: 802.11n HT40, CH3	Temperature	: 25 °C
Memo	:	Humidity	: 65 %

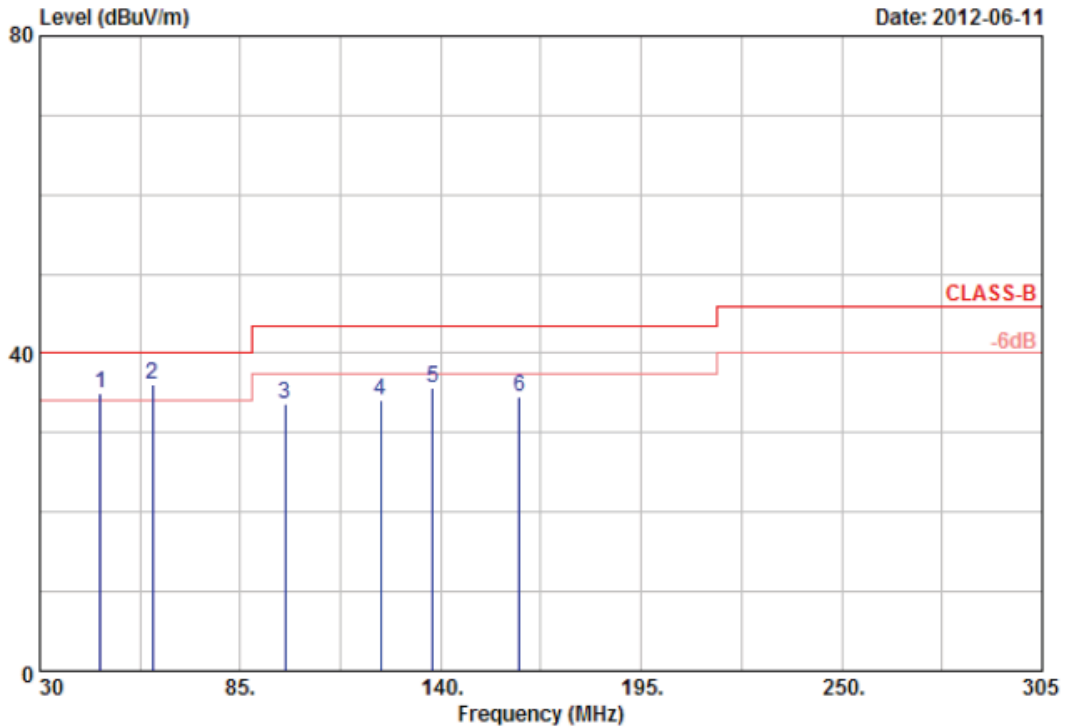

Item	Freq	Read Value	Factor	Result	Limit	Margin	Remark	Ant Pos	Tab Pos
	MHz	dBuV	dB/m	dBuV/m	dBuV/m	dB		cm	Deg
1	46.50	37.72	-2.83	34.89	40.00	-5.11	QP	100	0
2	60.80	47.01	-10.98	36.03	40.00	-3.97	QP	100	0
3	97.38	42.76	-9.12	33.64	43.50	-9.86	Peak	100	0
4	123.50	38.84	-4.84	34.00	43.50	-9.50	Peak	100	0
5	137.80	42.61	-6.93	35.68	43.50	-7.82	Peak	100	0
6	161.45	45.04	-10.40	34.64	43.50	-8.86	Peak	100	0

Notes:

1. Result = Read Value + Factor
2. Factor = Antenna Factor + Cable Loss - Amplifier
3. The resolution bandwidth of test receiver/spectrum analyzer is 120KHz and video bandwidth is 300kHz for Peak detection and Quasi-peak detection at frequency below 1GHz.
4. All emission below 1GHz at 802.11b/g/n mode are all the same, so the 802.11g/n mode chosen as representative in final test.
5. According to technical experiences, all spurious emission of 802.11g/n mode at channel 1,6,11 or 3,6,9(for HT40) are almost the same below 1GHz, so that the channel 1 or 3(for HT40) was chosen as representative in final test.
6. The data is worse case.



Power	: FROM SYSTEM	Pol/Phase	: VERTICAL
Test Mode 3	: 802.11n HT40, CH3	Temperature	: 25 °C
Memo	:	Humidity	: 65 %

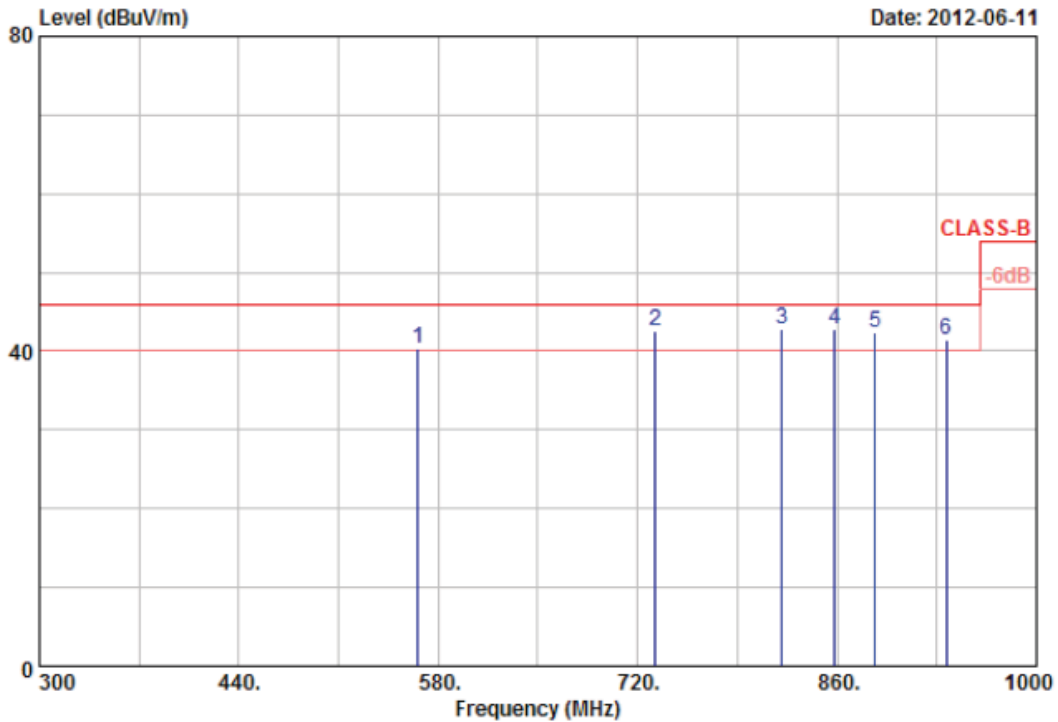

Item	Freq	Read Value	Factor	Result	Limit	Margin	Remark	Ant Pos	Tab Pos
	MHz	dBuV	dB/m	dBuV/m	dBuV/m	dB		cm	Deg
1	566.00	33.48	6.78	40.26	46.00	-5.74	QP	100	0
2	732.60	35.54	7.02	42.56	46.00	-3.44	QP	100	0
3	821.50	36.64	6.07	42.71	46.00	-3.29	QP	100	0
4	858.60	33.82	9.06	42.88	46.00	-3.12	QP	100	0
5	886.60	33.23	9.18	42.41	46.00	-3.59	QP	100	0
6	937.00	31.20	10.24	41.44	46.00	-4.56	QP	100	0

Notes:

1. Result = Read Value + Factor
2. Factor = Antenna Factor + Cable Loss - Amplifier
3. The resolution bandwidth of test receiver/spectrum analyzer is 120KHz and video bandwidth is 300kHz for Peak detection and Quasi-peak detection at frequency below 1GHz.
4. All emission below 1GHz at 802.11b/g/n mode are all the same,so the 802.11g/n mode chosen as representative in final test.
5. According to technical experiences,all spurious emission of 802.11g/n mode at channel 1,6,11 or 3,6,9(for HT40) are almost the same below 1GHz,so that the channel 1 or 3(for HT40)was chosen as representative in final test.
6. The data is worse case.