



SPORTON International Inc.

No. 52, Hwa Ya 1st Rd., Hwa Ya Technology Park, Kwei-Shan Hsiang, Tao Yuan Hsien, Taiwan, R.O.C.
Ph: 886-3-327-3456 / FAX: 886-3-327-0973 / www.sporton.com.tw

FCC RADIO TEST REPORT

Applicant's company	Amped Wireless
Applicant Address	13089 Peyton Dr. #C307 Chino Hills, California 91709 United State
FCC ID	ZTT-TAPEX3
Manufacturer's company	Amped Wireless
Manufacturer Address	13089 Peyton Dr. #C307 Chino Hills, California 91709 United State

Product Name	High Power Touch Screen AC1750 Wi-Fi Range Extender
Brand Name	amped wireless
Model No.	TAP-EX3
Test Rule Part(s)	47 CFR FCC Part 15 Subpart E § 15.407
Test Freq. Range	5150 ~ 5250 MHz / 5725 ~ 5850 MHz
Received Date	Sep. 02, 2015
Final Test Date	Oct. 13, 2015
Submission Type	Original Equipment

Statement

Test result included is for the IEEE 802.11n and IEEE 802.11 a/ac of the product.

The test result in this report refers exclusively to the presented test model / sample.

Without written approval of SPORTON International Inc., the test report shall not be reproduced except in full.

The measurements and test results shown in this test report were made in accordance with the procedures and found in compliance with the limit given in **ANSI C63.10-2013, 47 CFR FCC Part 15 Subpart E, KDB789033 D02 v01, KDB662911 D01 v02r01, KDB644545 D03 v01.**

The test equipment used to perform the test is calibrated and traceable to NML/ROC.



Table of Contents

1. VERIFICATION OF COMPLIANCE	1
2. SUMMARY OF THE TEST RESULT	2
3. GENERAL INFORMATION	3
3.1. Product Details.....	3
3.2. Accessories.....	4
3.3. Table for Filed Antenna.....	5
3.4. Table for Carrier Frequencies	6
3.5. Table for Test Modes	7
3.6. Table for Testing Locations.....	9
3.7. Table for Supporting Units	9
3.8. Table for Parameters of Test Software Setting	10
3.9. EUT Operation during Test	10
3.10. Duty Cycle.....	10
3.11. Test Configurations	11
4. TEST RESULT	14
4.1. AC Power Line Conducted Emissions Measurement.....	14
4.2. 26dB Bandwidth and 99% Occupied Bandwidth Measurement.....	18
4.3. 6dB Spectrum Bandwidth Measurement	29
4.4. Maximum Conducted Output Power Measurement.....	34
4.5. Power Spectral Density Measurement	37
4.6. Radiated Emissions Measurement	45
4.7. Band Edge Emissions Measurement	70
4.8. Frequency Stability Measurement	79
4.9. Antenna Requirements	86
5. LIST OF MEASURING EQUIPMENTS	87
6. MEASUREMENT UNCERTAINTY.....	88
APPENDIX A. TEST PHOTOS	A1 ~ A5
APPENDIX B. RADIATED EMISSION CO-LOCATION REPORT.....	B1 ~ B3



History of This Test Report

REPORT NO.	VERSION	DESCRIPTION	ISSUED DATE
FR572158-02AB	Rev. 01	Initial issue of report	Oct. 23, 2015

1. VERIFICATION OF COMPLIANCE

Product Name : High Power Touch Screen AC1750 Wi-Fi Range Extender
Brand Name : amped wireless
Model No. : TAP-EX3
Applicant : Amped Wireless
Test Rule Part(s) : 47 CFR FCC Part 15 Subpart E § 15.407

Sporton International as requested by the applicant to evaluate the EMC performance of the product sample received on Sep. 02, 2015 would like to declare that the tested sample has been evaluated and found to be in compliance with the tested rule parts. The data recorded as well as the test configuration specified is true and accurate for showing the sample's EMC nature.



Sam Chen
SPORTON INTERNATIONAL INC.

2. SUMMARY OF THE TEST RESULT

Applied Standard: 47 CFR FCC Part 15 Subpart E				
Part	Rule Section	Description of Test	Result	Under Limit
4.1	15.207	AC Power Line Conducted Emissions	Complies	12.69 dB
4.2	15.407(a)	26dB Spectrum Bandwidth and 99% Occupied Bandwidth	Complies	-
4.3	15.407(e)	6dB Spectrum Bandwidth	Complies	-
4.4	15.407(a)	Maximum Conducted Output Power	Complies	2.33 dB
4.5	15.407(a)	Power Spectral Density	Complies	0.66 dB
4.6	15.407(b)	Radiated Emissions	Complies	0.04 dB
4.7	15.407(b)	Band Edge Emissions	Complies	0.14 dB
4.8	15.407(g)	Frequency Stability	Complies	-
4.9	15.203	Antenna Requirements	Complies	-

3. GENERAL INFORMATION

3.1. Product Details

Items	Description
Product Type	WLAN (3TX, 3RX)
Radio Type	Intentional Transceiver
Power Type	From power adapter
Modulation	IEEE 802.11a: OFDM IEEE 802.11n/ac: see the below table
Data Modulation	IEEE 802.11a/n: OFDM (BPSK / QPSK / 16QAM / 64QAM) IEEE 802.11ac: OFDM (BPSK / QPSK / 16QAM / 64QAM / 256QAM)
Data Rate (Mbps)	IEEE 802.11a: OFDM (6/9/12/18/24/36/48/54) IEEE 802.11n/ac: see the below table
Frequency Range	5150 ~ 5250 MHz / 5725 ~ 5850 MHz
Channel Number	9 for 20MHz bandwidth ; 4 for 40MHz bandwidth 2 for 80MHz bandwidth
Channel Band Width (99%)	Band 1: IEEE 802.11a: 18.96 MHz IEEE 802.11ac MCS0/Nss1 (VHT20): 18.96 MHz IEEE 802.11ac MCS0/Nss1 (VHT40): 37.60 MHz IEEE 802.11ac MCS0/Nss1 (VHT80): 77.20 MHz Band 4: IEEE 802.11a: 17.28 MHz IEEE 802.11ac MCS0/Nss1 (VHT20): 18.72 MHz IEEE 802.11ac MCS0/Nss1 (VHT40): 38.40 MHz IEEE 802.11ac MCS0/Nss1 (VHT80): 76.80 MHz
Maximum Conducted Output Power	Band 1: IEEE 802.11a: 26.76 dBm IEEE 802.11ac MCS0/Nss1 (VHT20): 27.67 dBm IEEE 802.11ac MCS0/Nss1 (VHT40): 26.33 dBm IEEE 802.11ac MCS0/Nss1 (VHT80): 18.50 dBm Band 4: IEEE 802.11a: 21.05 dBm IEEE 802.11ac MCS0/Nss1 (VHT20): 20.87 dBm IEEE 802.11ac MCS0/Nss1 (VHT40): 23.25 dBm IEEE 802.11ac MCS0/Nss1 (VHT80): 18.75 dBm
Carrier Frequencies	Please refer to section 3.4
Antenna	Please refer to section 3.3

Items	Description	
Communication Mode	<input checked="" type="checkbox"/> IP Based (Load Based)	<input type="checkbox"/> Frame Based
Beamforming Function	<input type="checkbox"/> With beamforming	<input checked="" type="checkbox"/> Without beamforming
Operating Mode	<input type="checkbox"/> Outdoor access point	
	<input checked="" type="checkbox"/> Indoor access point	
	<input type="checkbox"/> Fixed point-to-point access points	
	<input type="checkbox"/> Mobile and portable client devices	

Antenna and Band width

Antenna	Three (TX)		
Band width Mode	20 MHz	40 MHz	80 MHz
IEEE 802.11a	V	X	X
IEEE 802.11n	V	V	X
IEEE 802.11ac	V	V	V

IEEE 11n/ac Spec.

Protocol	Number of Transmit Chains (NTX)	Data Rate / MCS
802.11n (HT20)	3	MCS 0-23
802.11n (HT40)	3	MCS 0-23
802.11ac (VHT20)	3	MCS 0-9/Nss1-3
802.11ac (VHT40)	3	MCS 0-9/Nss1-3
802.11ac (VHT80)	3	MCS 0-9/Nss1-3

Note 1: IEEE Std. 802.11n modulation consists of HT20 and HT40 (HT: High Throughput).

Then EUT supports HT20 and HT40.

Note 2: IEEE Std. 802.11ac modulation consists of VHT20, VHT40, VHT80 and VHT160 (VHT: Very High Throughput). Then EUT supports VHT20, VHT40 and VHT80.

Note 3: Modulation modes consist of below configuration:

HT20/HT40: IEEE 802.11n, VHT20/VHT40/VHT80: IEEE 802.11ac

3.2. Accessories

Power	Brand	Model	Rating
Adapter	ATW	ATW-1220AUS	Input: 100-240VAC~50/60 Hz MAX 0.5A Output: 12V, 2A
Other			
Foot Holder*1			

3.3. Table for Filed Antenna

Ant.	Brand Holder	Model Name	Antenna Type	Connector	Antenna Gain	
					2.4GHz	5GHz
1	Master Wave Technology Co., Ltd.	98619PRX009	Dipole Antenna	RP SMA Plug	3.48	3.49
2	INPAQ Technology Co., LTD	ACM3-5036-A1-CC-S	Chip Antenna	N/A	3	3.3
3	INPAQ Technology Co., LTD	ACM3-5036-A1-CC-S	Chip Antenna	N/A	3	3.3

Note: The EUT has three antennas.

<For IEEE 802.11b/g/nmode (3TX/3RX)>:

Ant. 1, Ant. 2 and Ant. 3 can be used as transmitting/receiving antenna.

Ant. 1, Ant. 2 and Ant. 3 could transmit/receive simultaneously.

For IEEE 802.11a/n/ac mode (3TX/3RX):

Ant. 1, Ant. 2 and Ant. 3 can be used as transmitting/receiving antenna.

Ant. 1, Ant. 2 and Ant. 3 could transmit/receive simultaneously.

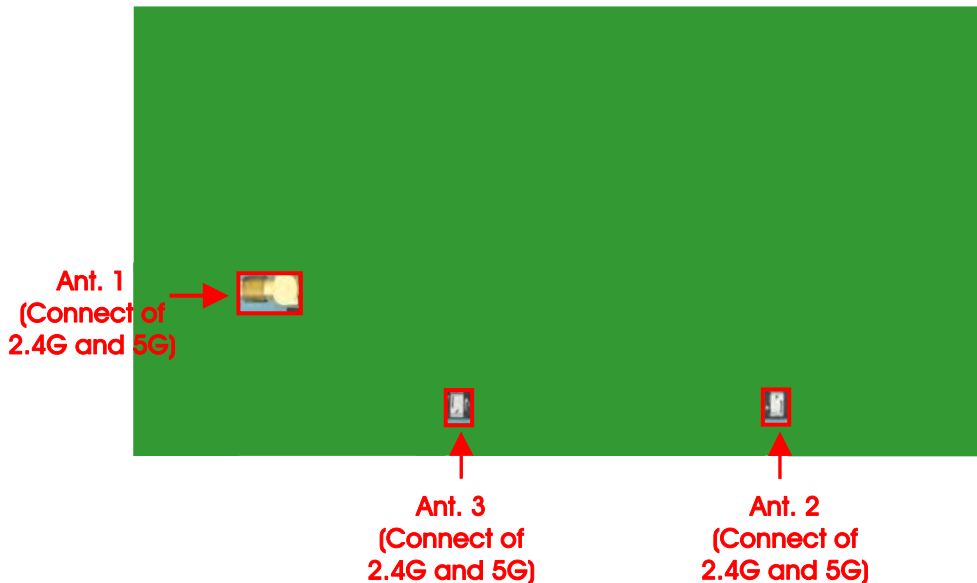

3.4. Table for Carrier Frequencies

There are three bandwidth systems.

For 20MHz bandwidth systems, use Channel 36, 40, 44, 48, 149, 153, 157, 161, 165.

For 40MHz bandwidth systems, use Channel 38, 46, 151, 159.

For 80MHz bandwidth systems, use Channel 42, 155.

Frequency Band	Channel No.	Frequency	Channel No.	Frequency
5150~5250 MHz Band 1	36	5180 MHz	44	5220 MHz
	38	5190 MHz	46	5230 MHz
	40	5200 MHz	48	5240 MHz
	42	5210 MHz	-	-
5725~5850 MHz Band 4	149	5745 MHz	157	5785 MHz
	151	5755 MHz	159	5795 MHz
	153	5765 MHz	161	5805 MHz
	155	5775 MHz	165	5825 MHz

3.5. Table for Test Modes

Preliminary tests were performed in different data rate to find the worst radiated emission. The data rate shown in the table below is the worst-case rate with respect to the specific test item. Investigation has been done on all the possible configurations for searching the worst cases. The following table is a list of the test modes shown in this test report.

Test Items	Mode		Data Rate	Channel	Ant.
AC Power Conducted Emission	Normal Link		-	-	-
Max. Conducted Output Power	11a/BPSK	Band 1&4	6Mbps	36/40/48/149/1 57/165	1+2+3
	11ac VHT20	Band 1&4	MCS0/Nss1	36/40/48/149/1 57/165	1+2+3
	11ac VHT40	Band 1&4	MCS0/Nss1	38/46/151/159	1+2+3
	11ac VHT80	Band 1&4	MCS0/Nss1	42/155	1+2+3
Power Spectral Density	11a/BPSK	Band 1&4	6Mbps	36/40/48/149/1 57/165	1+2+3
	11ac VHT20	Band 1&4	MCS0/Nss1	36/40/48/149/1 57/165	1+2+3
	11ac VHT40	Band 1&4	MCS0/Nss1	38/46/151/159	1+2+3
	11ac VHT80	Band 1&4	MCS0/Nss1	42/155	1+2+3
26dB Spectrum Bandwidth & 99% Occupied Bandwidth Measurement	11a/BPSK	Band 1&4	6Mbps	36/40/48/149/1 57/165	1+2+3
	11ac VHT20	Band 1&4	MCS0/Nss1	36/40/48/149/1 57/165	1+2+3
	11ac VHT40	Band 1&4	MCS0/Nss1	38/46/151/159	1+2+3
	11ac VHT80	Band 1&4	MCS0/Nss1	42/155	1+2+3
6dB Spectrum Bandwidth Measurement	11a/BPSK	Band 4	6Mbps	149/157/165	1+2+3
	11ac VHT20	Band 4	MCS0/Nss1	149/157/165	1+2+3
	11ac VHT40	Band 4	MCS0/Nss1	151/159	1+2+3
	11ac VHT80	Band 4	MCS0/Nss1	155	1+2+3
Radiated Emission Below 1GHz	Normal Link		-	-	-
Radiated Emission Above 1GHz	11a/BPSK	Band 1&4	6Mbps	36/40/48/149/1 57/165	1+2+3
	11ac VHT20	Band 1&4	MCS0/Nss1	36/40/48/149/1 57/165	1+2+3
	11ac VHT40	Band 1&4	MCS0/Nss1	38/46/151/159	1+2+3
	11ac VHT80	Band 1&4	MCS0/Nss1	42/155	1+2+3

Band Edge Emission	11a/BPSK	Band 1&4	6Mbps	36/40/48/149/1 57/165	1+2+3
	11ac VHT20	Band 1&4	MCS0/Nss1	36/40/48/149/1 57/165	1+2+3
	11ac VHT40	Band 1&4	MCS0/Nss1	38/46/151/159	1+2+3
	11ac VHT80	Band 1&4	MCS0/Nss1	42/155	1+2+3
Frequency Stability	20 MHz	Band 1&4	-	40/157	1
	40 MHz	Band 1&4	-	38/151	1
	80 MHz	Band 1&4	-	42/155	1

Note:

1. The product can only for standing use.
2. VHT20/VHT40 covers HT20/HT40, due to same modulation. The power setting for 802.11n HT20 and HT40 are the same or lower than 802.11ac VHT20 and VHT40.

The following test modes were performed for all tests:

For Conducted Emission test:

Mode 1. Normal Link - Repeater mode

For Radiated Emission test <Below 1GHz>:

Mode 1. Normal Link - Repeater mode

For Radiated Emission test <Above 1GHz>:

Mode 1. Place EUT in Y axis

For Co-location MPE and Radiated Emission Co-location Test:

The EUT could be applied with 2.4GHz WLAN function and 5GHz WLAN function; therefore Co-location Maximum Permissible Exposure (Please refer to FA572158-02) and Radiated Emission Co-location (please refer to Appendix B) tests are added for simultaneously transmit between 2.4GHz WLAN function and 5GHz WLAN function.

3.6. Table for Testing Locations

Test Site Location					
Address:	No.8, Lane 724, Bo-ai St., Jhubei City, Hsinchu County 302, Taiwan, R.O.C.				
TEL:	886-3-656-9065				
FAX:	886-3-656-9085				
Test Site No.	Site Category	Location	FCC Reg. No.	IC File No.	VCCI Reg. No
03CH01-CB	SAC	Hsin Chu	262045	IC 4086D	-
CO01-CB	Conduction	Hsin Chu	262045	IC 4086D	-
TH01-CB	OVEN Room	Hsin Chu	-	-	-

Open Area Test Site (OATS); Semi Anechoic Chamber (SAC).

3.7. Table for Supporting Units

For Test Site No: CO01-CB

Support Unit	Brand	Model	FCC ID
NB*4	DELL	E6430	DoC
AP Router	Planex	GW-AP54SGX	KA220030603014-1
Flash disk3.0	Transcend	JetFlash-700	DoC

For Test Site No: 03CH01-CB <Below 1GHz>

Support Unit	Brand	Model	FCC ID
NB*4	DELL	E4300	DoC
Wireless ac AP	Netgear	R7500	PY314300288
Flash disk	Silicon Power	I-Series	DoC

For Test Site No: 03CH01-CB <Above 1GHz>

Support Unit	Brand	Model	FCC ID
NB	DELL	E4300	DoC

For Test Site No: TH01-CB

Support Unit	Brand	Model	FCC ID
NB	DELL	E4300	DoC

3.8. Table for Parameters of Test Software Setting

During testing, Channel and Power Controlling Software provided by the customer was used to control the operating channel as well as the output power level. The RF output power selection is for the setting of RF output power expected by the customer and is going to be fixed on the firmware of the final end product.

Test Software Version	ART2					
Mode	Test Frequency (MHz)					
	NCB: 20MHz					
	5180 MHz	5200 MHz	5240 MHz	5745 MHz	5785 MHz	5825 MHz
802.11a	23	24	23	15	14	14
802.11ac MCS0/Nss1 VHT20	23.5	24	24	15	14	14
Mode	NCB: 40MHz					
802.11ac MCS0/Nss1 VHT40	5190 MHz		5230 MHz		5755 MHz	
	18		24		14.5	
17						
Mode	NCB: 80MHz					
802.11ac MCS0/Nss1 VHT80	5210 MHz			5775 MHz		
	16.5			13		

3.9. EUT Operation during Test

The EUT was programmed to be in continuously transmitting mode.

3.10. Duty Cycle

Mode	On Time (ms)	On+Off Time (ms)	Duty Cycle (%)	Duty Factor (dB)	1/T Minimum VBW (kHz)
802.11a	2.010	2.225	90.34%	0.44	0.50
802.11ac MCS0/Nss1 VHT20	2.011	2.099	95.81%	0.19	0.50
802.11ac MCS0/Nss1 VHT40	0.932	1.010	92.28%	0.35	1.07
802.11ac MCS0/Nss1 VHT80	0.439	0.522	84.10%	0.75	2.28

3.11. Test Configurations

3.11.1. AC Power Line Conduction Emissions Test Configuration

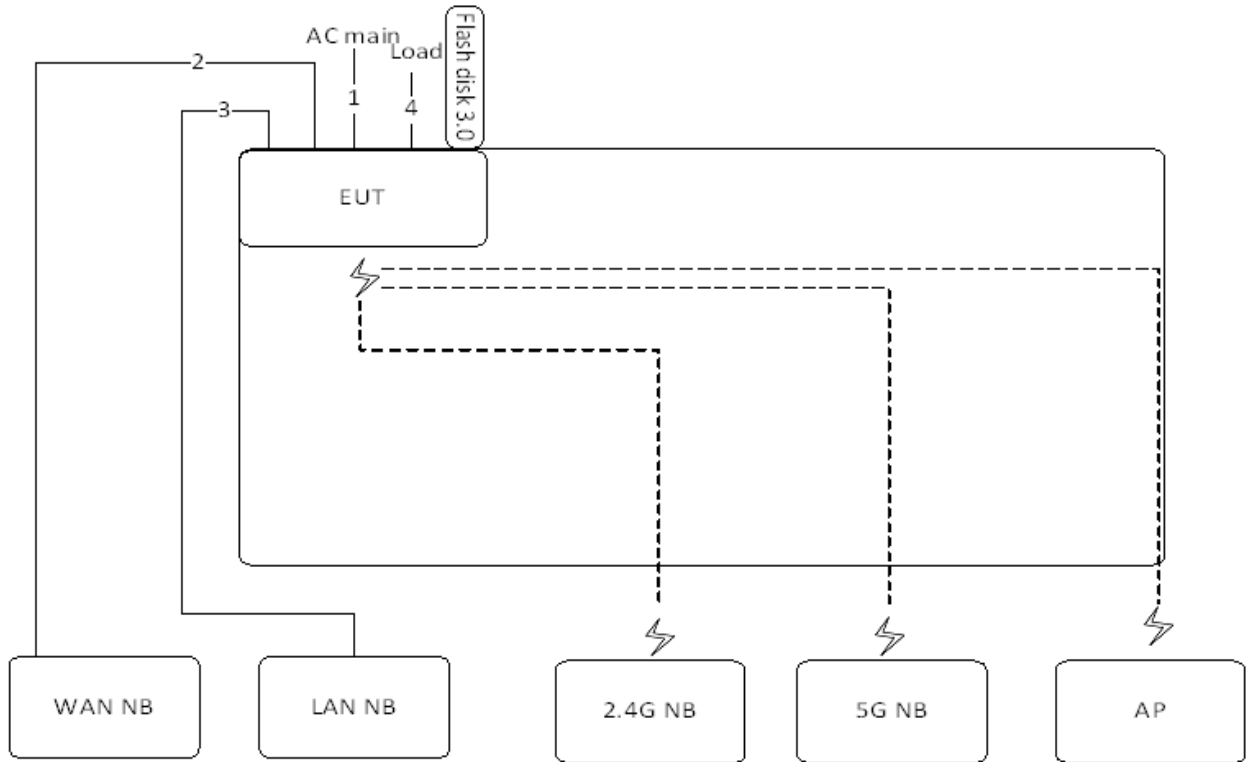

Item	Connection	Shielded	Length
1	Power cable	No	1.5m
2	RJ-45 cable	No	10m
3	RJ-45 cable	No	10m
4	RJ-45 cable*3	No	1.5m

3.11.2. Radiation Emissions Test Configuration

Test Configuration: 30MHz~1GHz

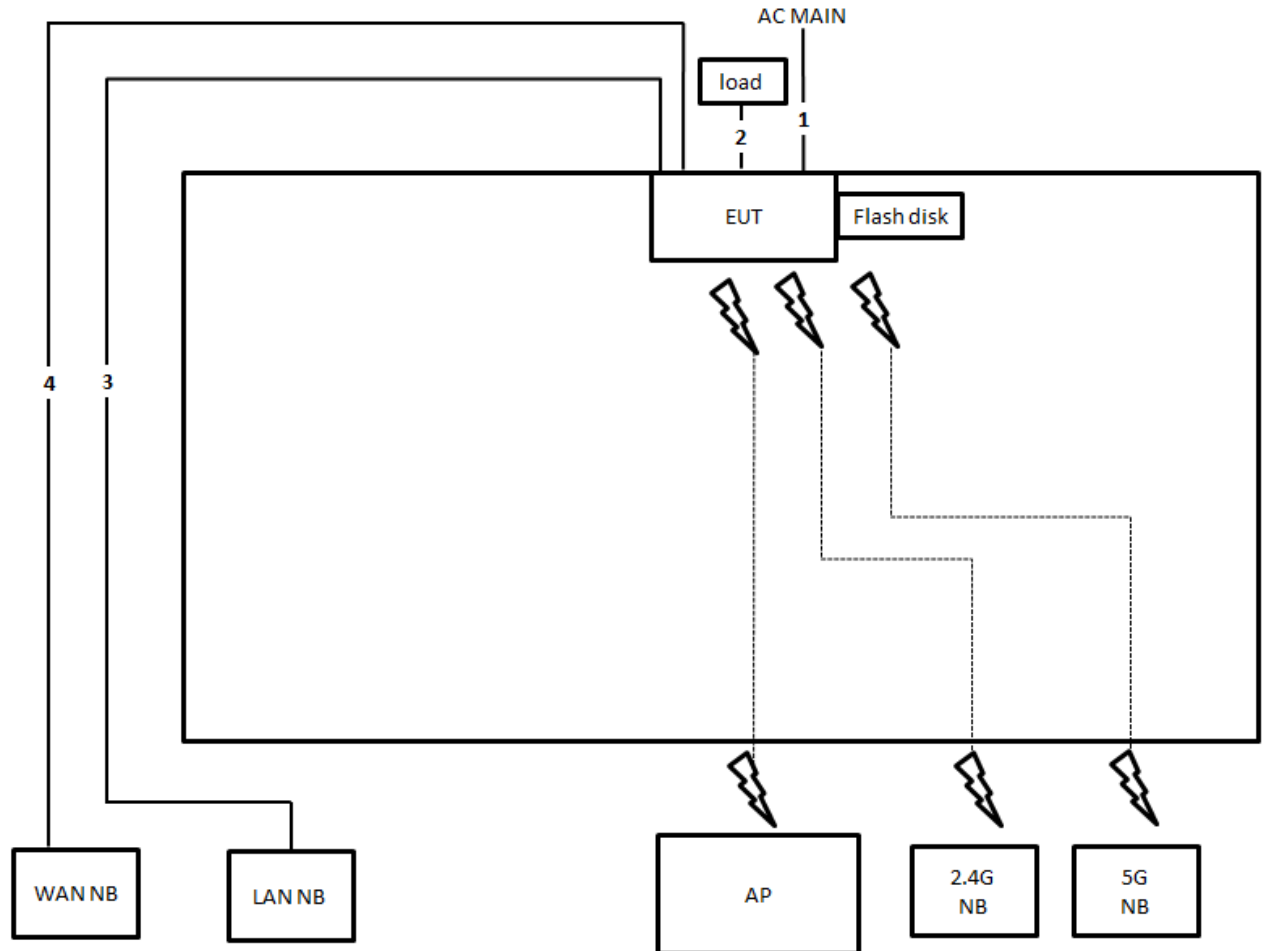

Item	Connection	Shielded	Length
1	Power cable	No	1.5m
2	RJ-45 cable *3	No	1.5m
3	RJ-45 cable	No	10m
4	RJ-45 cable	No	10m

Test Configuration: above 1GHz

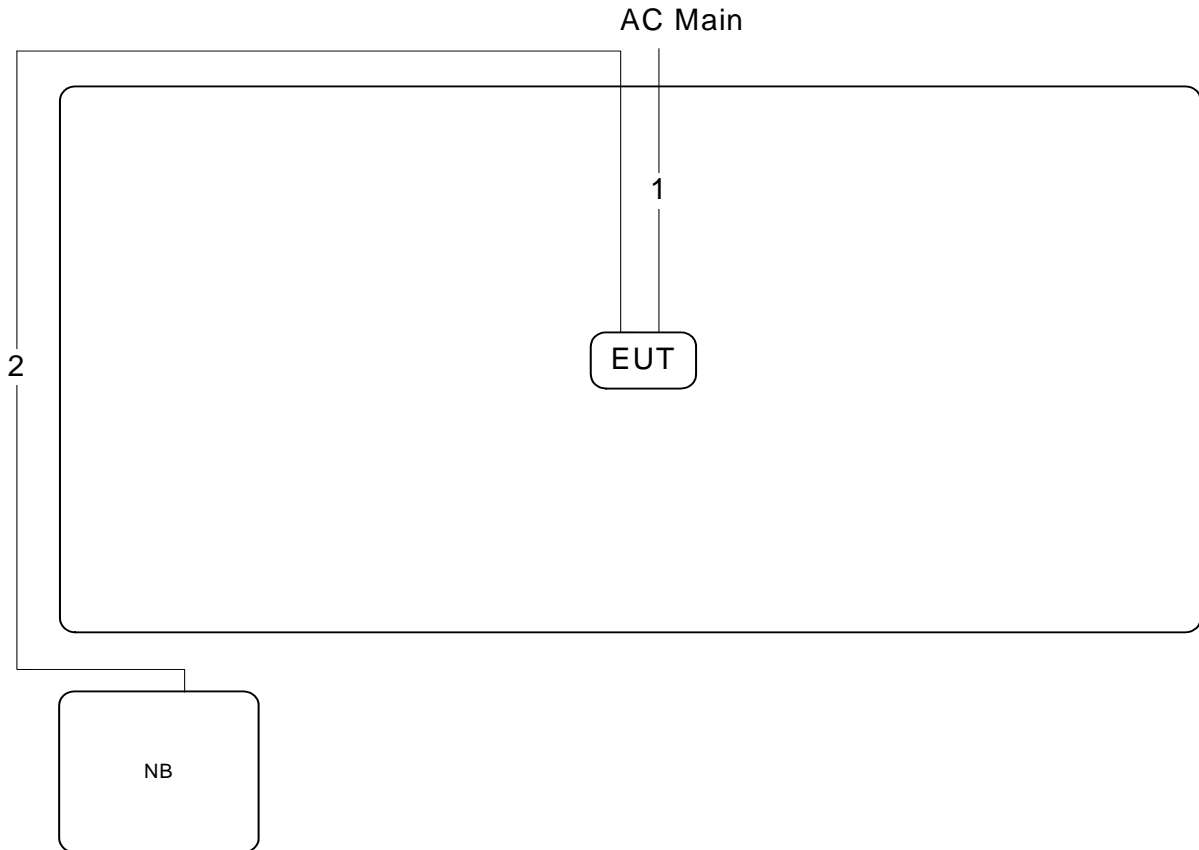

Item	Connection	Shielded	Length(m)
1	Power cable	No	1.5m
2	RJ-45 cable	No	10m

4. TEST RESULT

4.1. AC Power Line Conducted Emissions Measurement

4.1.1. Limit

For this product that is designed to connect to the AC power line, the radio frequency voltage that is conducted back onto the AC power line on any frequency or frequencies within the band 150 kHz to 30 MHz shall not exceed below limits table.

Frequency (MHz)	QP Limit (dBuV)	AV Limit (dBuV)
0.15~0.5	66~56	56~46
0.5~5	56	46
5~30	60	50

4.1.2. Measuring Instruments and Setting

Please refer to section 5 of equipments list in this report. The following table is the setting of the receiver.

Receiver Parameters	Setting
Attenuation	10 dB
Start Frequency	0.15 MHz
Stop Frequency	30 MHz
IF Bandwidth	9 kHz

4.1.3. Test Procedures

1. Configure the EUT according to ANSI C63.10. The EUT or host of EUT has to be placed 0.4 meter far from the conducting wall of the shielding room and at least 80 centimeters from any other grounded conducting surface.
2. Connect EUT or host of EUT to the power mains through a line impedance stabilization network (LISN).
3. All the support units are connected to the other LISNs. The LISN should provide 50uH/50ohms coupling impedance.
4. The frequency range from 150 kHz to 30 MHz was searched.
5. Set the test-receiver system to Peak Detect Function and Specified Bandwidth with Maximum Hold Mode.
6. The measurement has to be done between each power line and ground at the power terminal.

4.1.4. Test Setup Layout

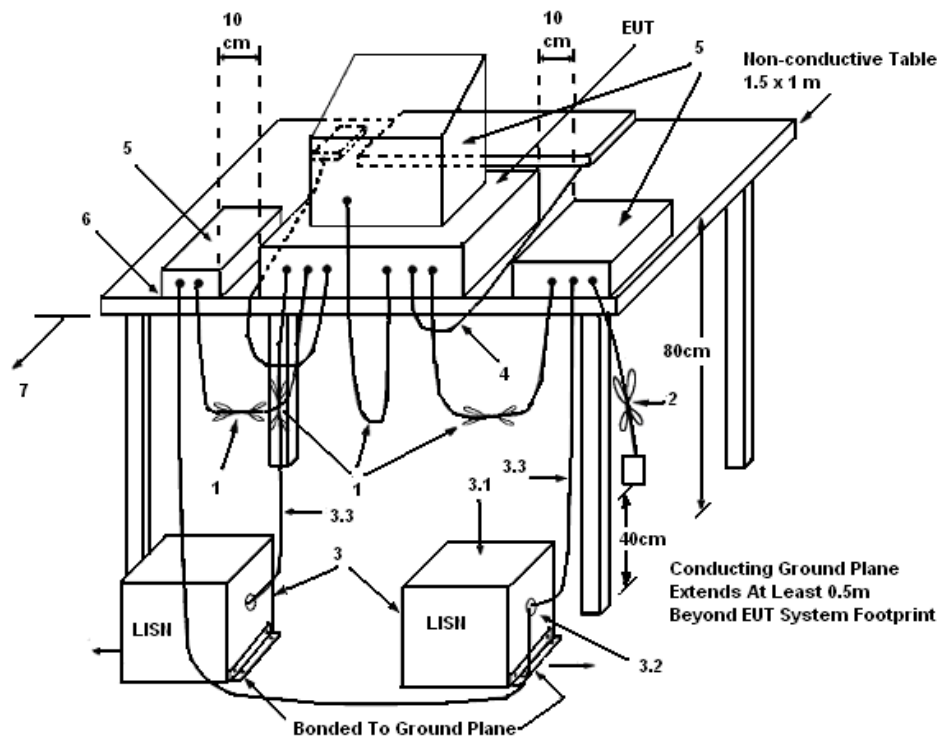

LEGEND:

- (1) Interconnecting cables that hang closer than 40 cm to the ground plane shall be folded back and forth in the center forming a bundle 30 to 40 cm long.
- (2) I/O cables that are not connected to a peripheral shall be bundled in the center. The end of the cable may be terminated, if required, using the correct terminating impedance. The overall length shall not exceed 1 m.
- (3) EUT connected to one LISN. Unused LISN measuring port connectors shall be terminated in 50 Ω . LISN can be placed on top of, or immediately beneath, reference ground plane.
 - (3.1) All other equipment powered from additional LISN(s).
 - (3.2) Multiple outlet strip can be used for multiple power cords of non-EUT equipment.
 - (3.3) LISN at least 80 cm from nearest part of EUT chassis.
- (4) Cables of hand-operated devices, such as keyboards, mice, etc., shall be placed as for normal use.
- (5) Non-EUT components of EUT system being tested.
- (6) Rear of EUT, including peripherals, shall all be aligned and flush with rear of tabletop.
- (7) Rear of tabletop shall be 40 cm removed from a vertical conducting plane that is bonded to the ground plane.

4.1.5. Test Deviation

There is no deviation with the original standard.

4.1.6. EUT Operation during Test

The EUT was placed on the test table and programmed in normal function.

4.1.7. Results of AC Power Line Conducted Emissions Measurement

Temperature	25°C	Humidity	60%
Test Engineer	Kane Liu	Phase	Line
Configuration	Normal Link		

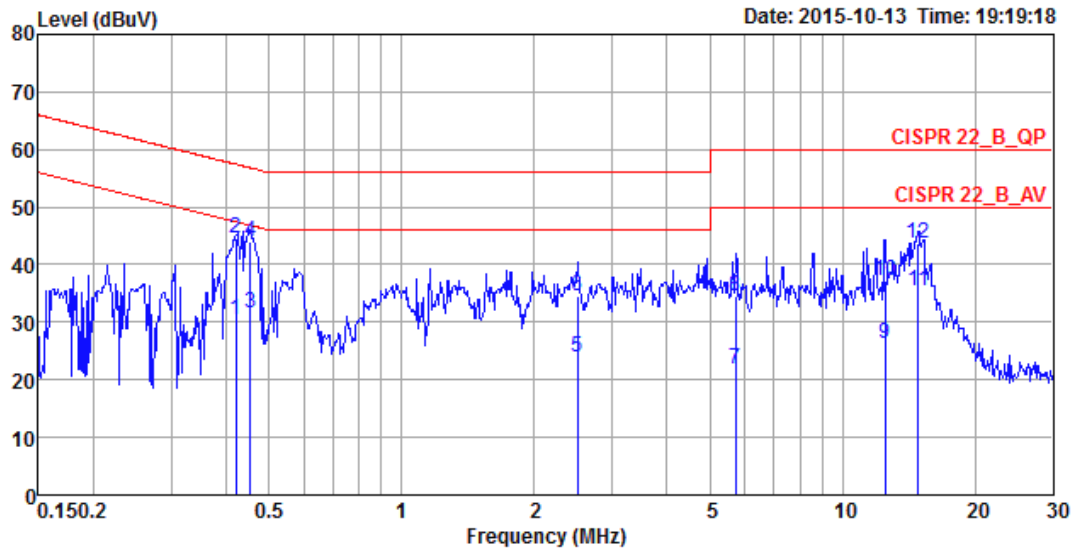

	Freq	Level	Over Limit	Limit Line	Read Level	LISN Factor	Cable Loss	Pol/Phase	Remark
	MHz	dBuV	dB	dBuV	dBuV	dB	dB		
1	0.4215	30.27	-17.15	47.42	20.30	9.93	0.04	LINE	Average
2	0.4215	44.45	-12.97	57.42	34.48	9.93	0.04	LINE	QP
3	0.4539	31.57	-15.23	46.80	21.60	9.93	0.04	LINE	Average
4	0.4539	44.11	-12.69	56.80	34.14	9.93	0.04	LINE	QP
5	2.5000	24.00	-22.00	46.00	13.95	10.00	0.05	LINE	Average
6	2.5000	34.67	-21.33	56.00	24.62	10.00	0.05	LINE	QP
7	5.7135	21.98	-28.02	50.00	11.78	10.08	0.12	LINE	Average
8	5.7135	34.46	-25.54	60.00	24.26	10.08	0.12	LINE	QP
9	12.5156	26.19	-23.81	50.00	15.68	10.26	0.25	LINE	Average
10	12.5156	37.11	-22.89	60.00	26.60	10.26	0.25	LINE	QP
11	14.8281	35.36	-14.64	50.00	24.77	10.33	0.26	LINE	Average
12	14.8281	43.54	-16.46	60.00	32.95	10.33	0.26	LINE	QP

Temperature	25°C	Humidity	60%
Test Engineer	Kane Liu	Phase	Neutral
Configuration	Normal Link		

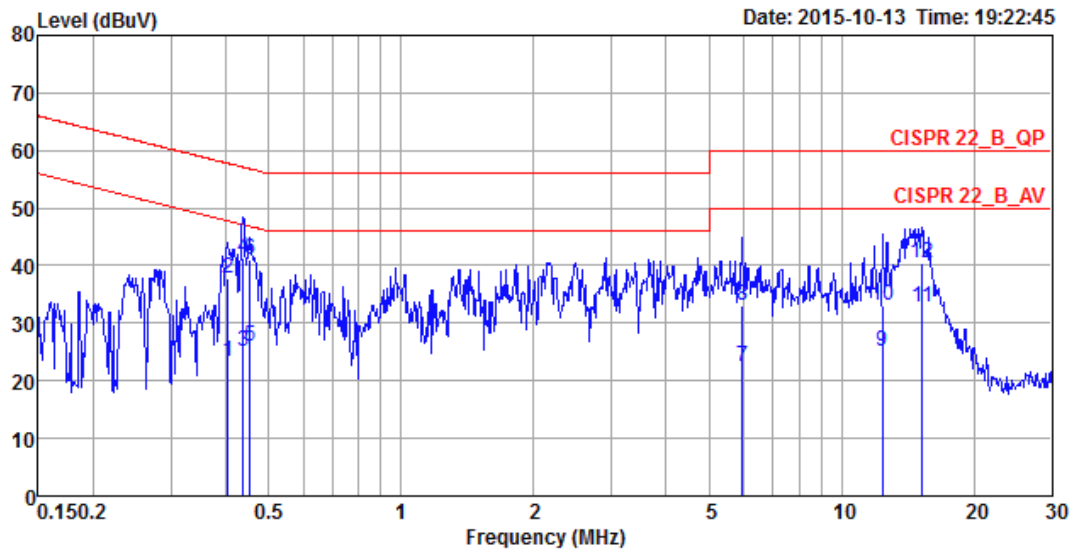

	Freq	Level	Over Limit	Limit Line	Read Level	LISN Factor	Cable Loss	Pol/Phase	Remark
	MHz	dBuV	dB	dBuV	dBuV	dB	dB		
1	0.4040	23.20	-24.57	47.77	13.37	9.79	0.04	NEUTRAL	Average
2	0.4040	37.71	-20.06	57.77	27.88	9.79	0.04	NEUTRAL	QP
3	0.4374	25.14	-21.97	47.11	15.31	9.79	0.04	NEUTRAL	Average
4	0.4374	41.39	-15.72	57.11	31.56	9.79	0.04	NEUTRAL	QP
5	0.4539	25.92	-20.88	46.80	16.09	9.79	0.04	NEUTRAL	Average
6	0.4539	41.17	-15.63	56.80	31.34	9.79	0.04	NEUTRAL	QP
7	5.9608	22.47	-27.53	50.00	12.41	9.93	0.13	NEUTRAL	Average
8	5.9608	33.16	-26.84	60.00	23.10	9.93	0.13	NEUTRAL	QP
9	12.3837	25.22	-24.78	50.00	14.91	10.06	0.25	NEUTRAL	Average
10	12.3837	33.15	-26.85	60.00	22.84	10.06	0.25	NEUTRAL	QP
11	15.2261	32.87	-17.13	50.00	22.50	10.11	0.26	NEUTRAL	Average
12	15.2261	40.39	-19.61	60.00	30.02	10.11	0.26	NEUTRAL	QP

Note:

Level = Read Level + LISN Factor + Cable Loss.

4.2. 26dB Bandwidth and 99% Occupied Bandwidth Measurement

4.2.1. Limit

No restriction limits.

4.2.2. Measuring Instruments and Setting

Please refer to section 5 of equipments list in this report. The following table is the setting of the spectrum analyzer.

26dB Bandwidth	
Spectrum Parameters	Setting
Attenuation	Auto
Span Frequency	> 26dB Bandwidth
RBW	Approximately 1% of the emission bandwidth
VBW	VBW > RBW
Detector	Peak
Trace	Max Hold
Sweep Time	Auto
99% Occupied Bandwidth	
Spectrum Parameters	Setting
Span	1.5 times to 5.0 times the OBW
RBW	1 % to 5 % of the OBW
VBW	$\geq 3 \times \text{RBW}$
Detector	Peak
Trace	Max Hold

4.2.3. Test Procedures

For Radiated 26dB Bandwidth and 99% Occupied Bandwidth Measurement:

1. The transmitter was radiated to the spectrum analyzer in peak hold mode.
2. Measure the maximum width of the emission that is 26 dB down from the peak of the emission. Compare this with the RBW setting of the analyzer. Readjust RBW and repeat measurement as needed until the RBW/EBW ratio is approximately 1%.

4.2.4. Test Setup Layout

For Radiated 26dB Bandwidth and 99% Occupied Bandwidth Measurement:

This test setup layout is the same as that shown in section 4.6.4.

4.2.5. Test Deviation

There is no deviation with the original standard.

4.2.6. EUT Operation during Test

The EUT was programmed to be in continuously transmitting mode.

4.2.7. Test Result of 26dB Bandwidth and 99% Occupied Bandwidth

Temperature	25°C	Humidity	53%
Test Engineer	Nick Peng / Clemens Fang		

Mode	Frequency	26dB Bandwidth (MHz)	99% Occupied Bandwidth (MHz)
802.11a	5180 MHz	24.36	17.40
	5200 MHz	33.36	18.00
	5240 MHz	24.60	18.96
	5745 MHz	22.08	17.28
	5785 MHz	22.56	17.28
	5825 MHz	22.80	17.28
802.11ac MCS0/Nss1 VHT20	5180 MHz	26.04	18.60
	5200 MHz	27.84	18.96
	5240 MHz	31.92	18.72
	5745 MHz	24.12	18.60
	5785 MHz	24.00	18.72
	5825 MHz	23.64	18.60
802.11ac MCS0/Nss1 VHT40	5190 MHz	44.60	37.40
	5230 MHz	48.80	37.60
	5755 MHz	46.20	38.00
	5795 MHz	48.20	38.40
802.11ac MCS0/Nss1 VHT80	5210 MHz	86.80	77.20
	5775 MHz	85.60	76.80

26dB Bandwidth and 99% Occupied Bandwidth Plot on Configuration IEEE 802.11a / Ant. 1 + Ant. 2 + Ant. 3 / 5180 MHz

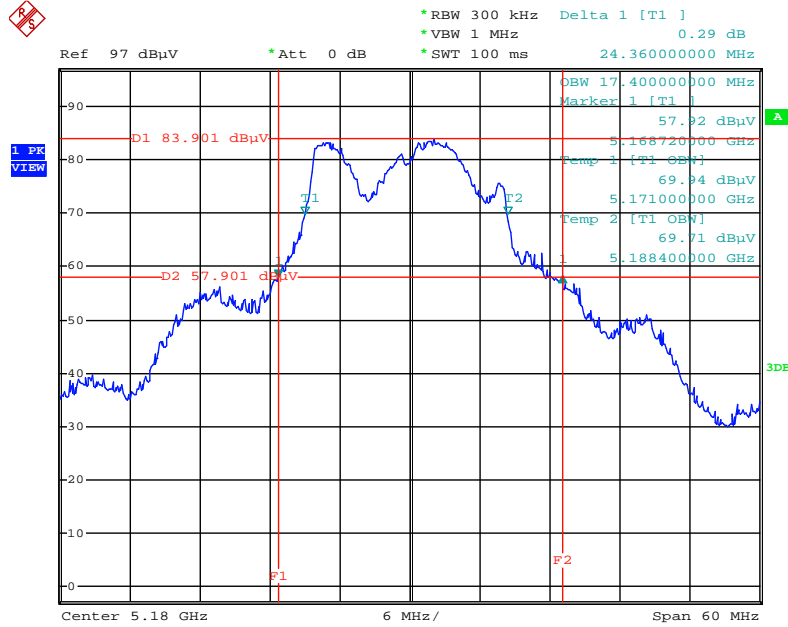

Date: 10.SEP.2015 18:30:18

26dB Bandwidth and 99% Occupied Bandwidth Plot on Configuration IEEE 802.11a / Ant. 1 + Ant. 2 + Ant. 3 / 5200 MHz

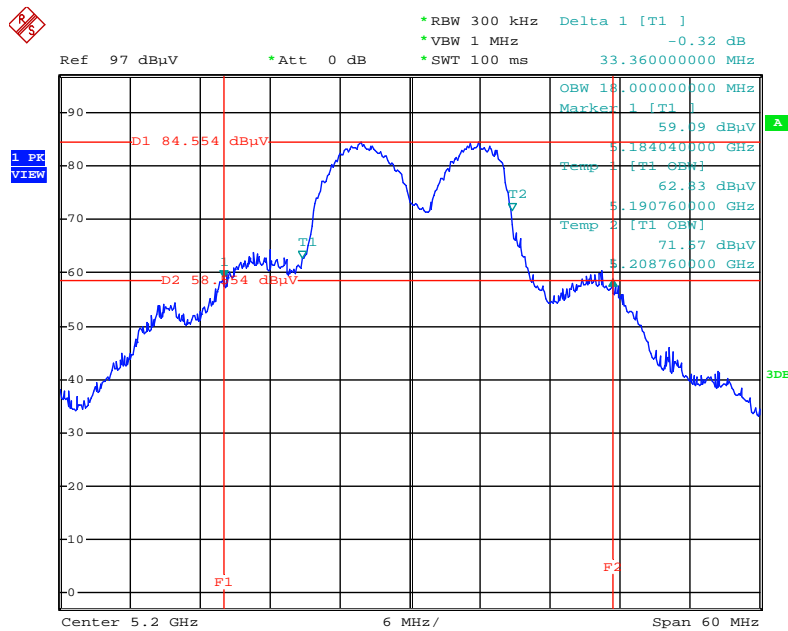

Date: 10.SEP.2015 18:31:50

26dB Bandwidth and 99% Occupied Bandwidth Plot on Configuration IEEE 802.11a / Ant. 1 + Ant. 2 + Ant. 3 / 5240 MHz

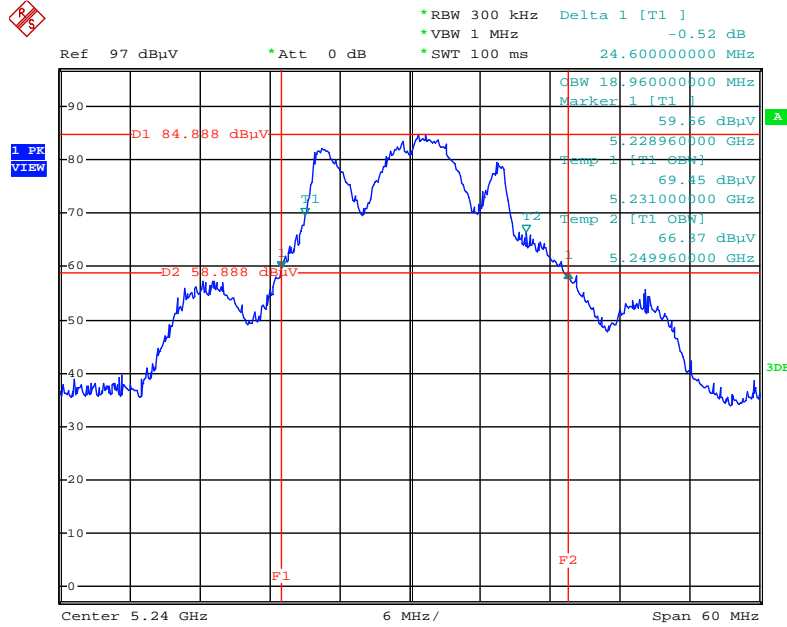

Date: 10.SEP.2015 18:32:25

26dB Bandwidth and 99% Occupied Bandwidth Plot on Configuration IEEE 802.11a / Ant. 1 + Ant. 2 + Ant. 3 / 5745 MHz

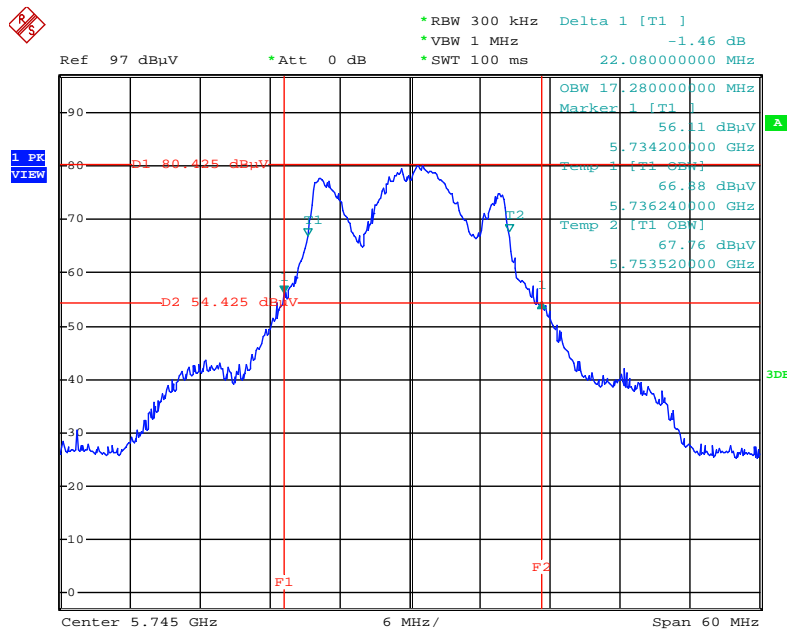

Date: 10.SEP.2015 18:33:31

26dB Bandwidth and 99% Occupied Bandwidth Plot on Configuration IEEE 802.11a / Ant. 1 + Ant. 2 + Ant. 3 / 5785 MHz

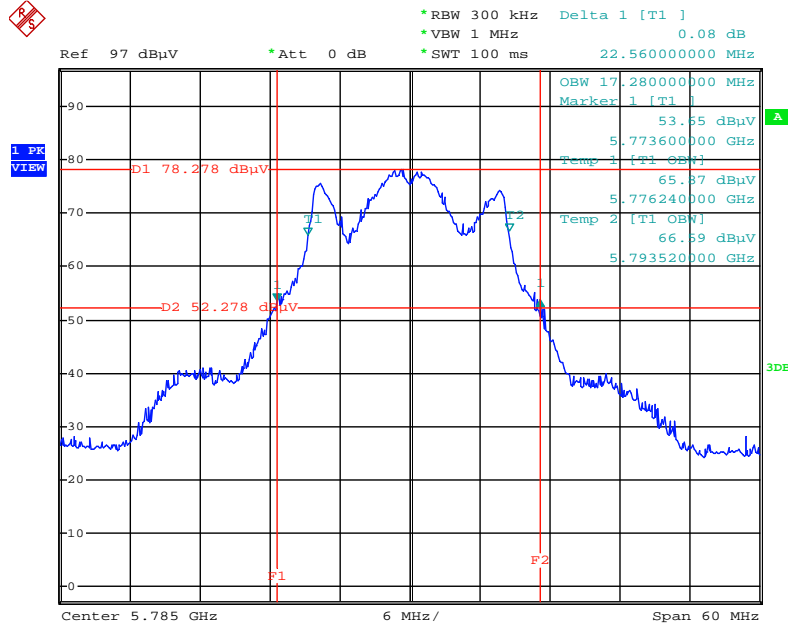

Date: 10.SEP.2015 18:34:13

26dB Bandwidth and 99% Occupied Bandwidth Plot on Configuration IEEE 802.11a / Ant. 1 + Ant. 2 + Ant. 3 / 5825 MHz

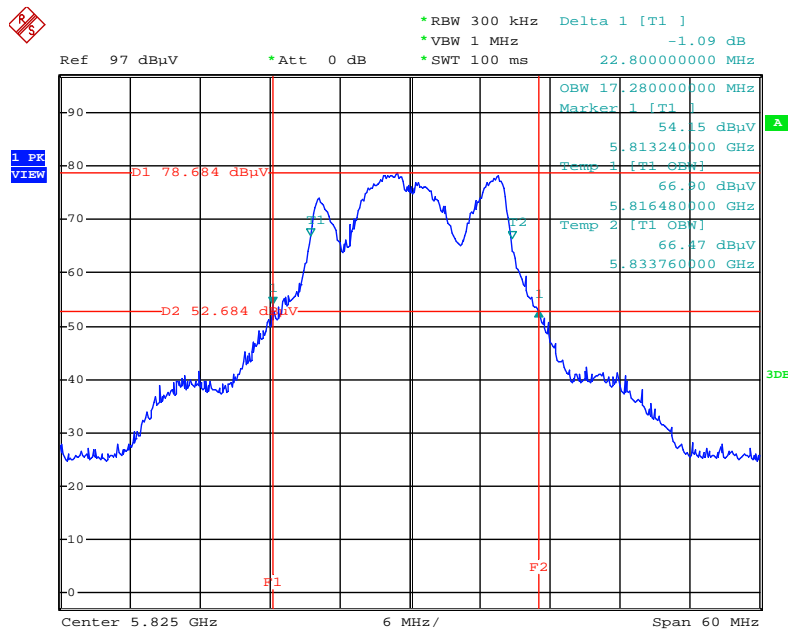

Date: 10.SEP.2015 18:34:57

26dB Bandwidth and 99% Occupied Bandwidth Plot on Configuration IEEE 802.11ac MCS0/Nss1 VHT20 / Ant. 1 + Ant. 2 + Ant. 3 / 5180 MHz

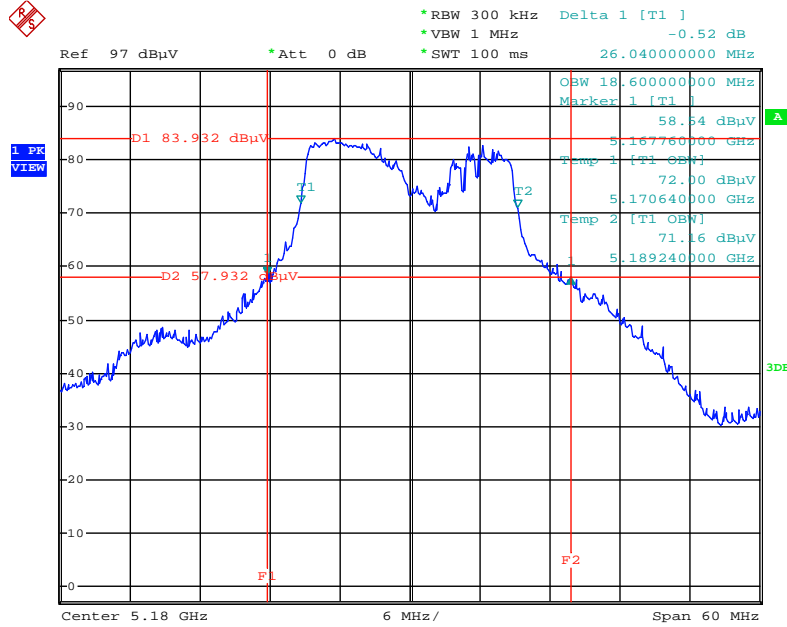

Date: 10.SEP.2015 18:37:16

26dB Bandwidth and 99% Occupied Bandwidth Plot on Configuration IEEE 802.11ac MCS0/Nss1 VHT20 / Ant. 1 + Ant. 2 + Ant. 3 / 5200 MHz

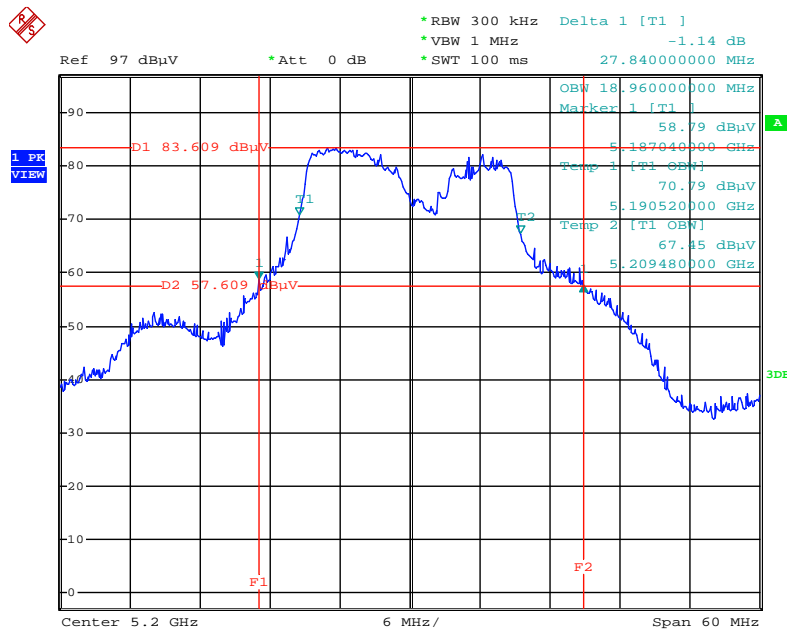

Date: 10.SEP.2015 18:37:52

26dB Bandwidth and 99% Occupied Bandwidth Plot on Configuration IEEE 802.11ac MCS0/Nss1 VHT20 / Ant. 1 + Ant. 2 + Ant. 3 / 5240 MHz

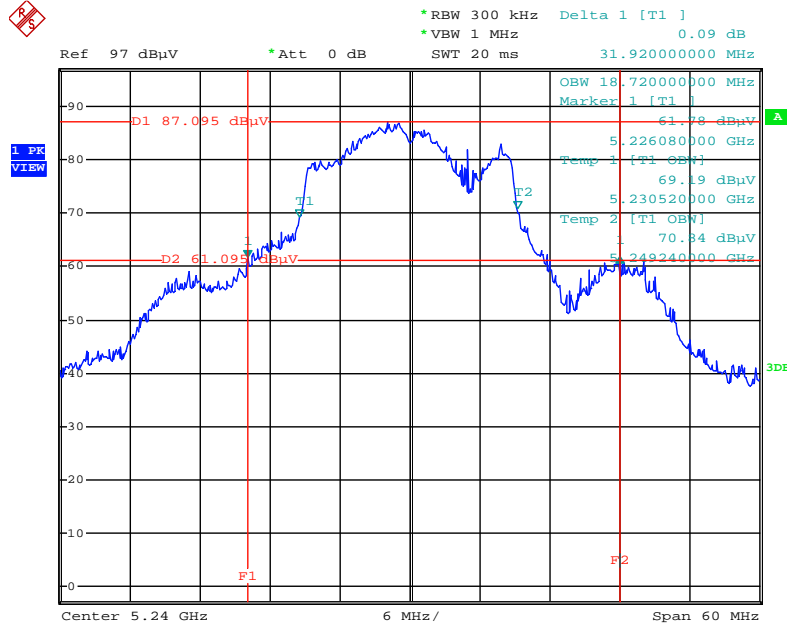

Date: 11.SEP.2015 01:41:11

26dB Bandwidth and 99% Occupied Bandwidth Plot on Configuration IEEE 802.11ac MCS0/Nss1 VHT20 / Ant. 1 + Ant. 2 + Ant. 3 / 5745 MHz

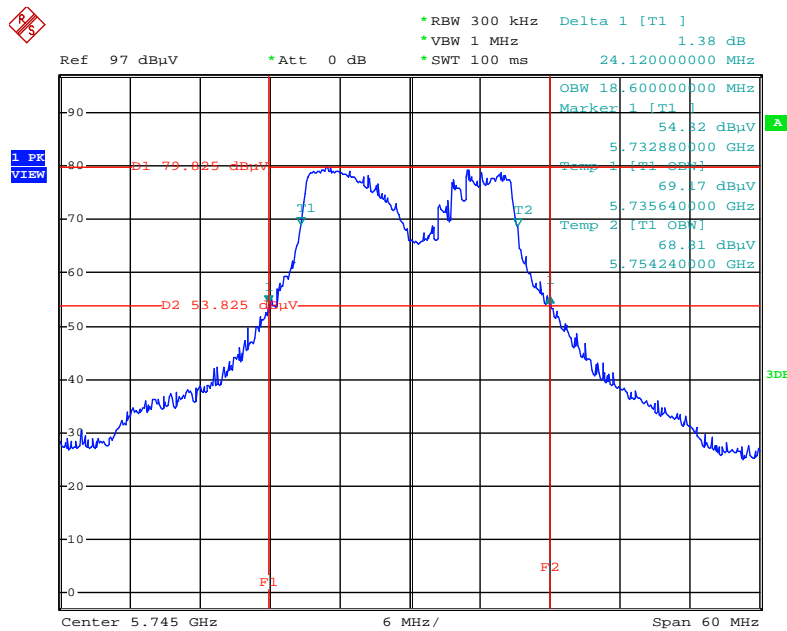

Date: 10.SEP.2015 19:31:03

26dB Bandwidth and 99% Occupied Bandwidth Plot on Configuration IEEE 802.11ac MCS0/Nss1 VHT20 / Ant. 1 + Ant. 2 + Ant. 3 / 5785 MHz

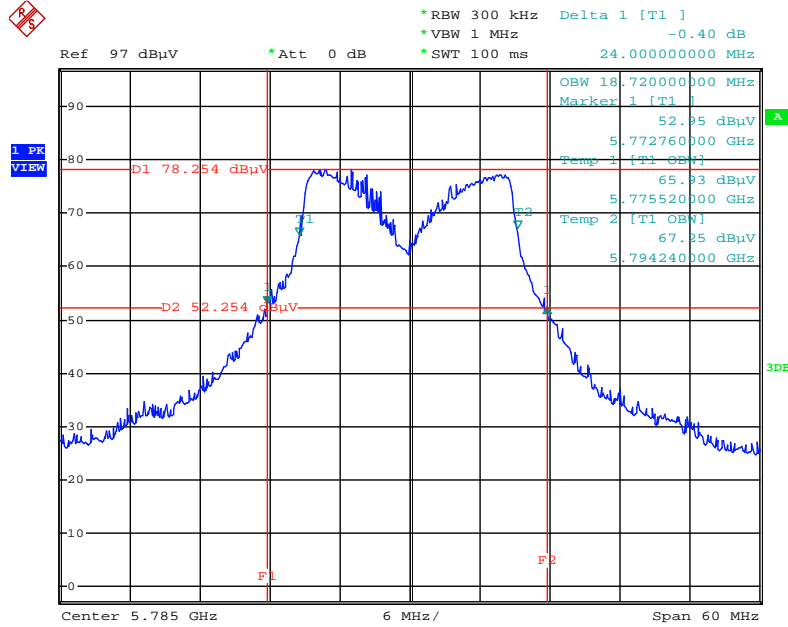

Date: 10.SEP.2015 19:31:55

26dB Bandwidth and 99% Occupied Bandwidth Plot on Configuration IEEE 802.11ac MCS0/Nss1 VHT20 / Ant. 1 + Ant. 2 + Ant. 3 / 5825 MHz

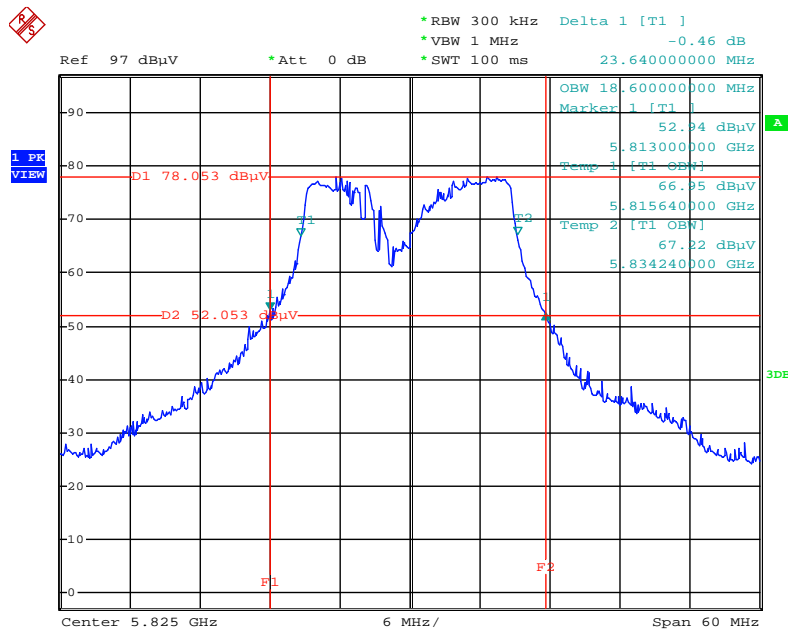

Date: 10.SEP.2015 19:34:11

26dB Bandwidth and 99% Occupied Bandwidth Plot on Configuration IEEE 802.11ac MCS0/Nss1 VHT40 / Ant. 1 + Ant. 2 + Ant. 3 / 5190 MHz

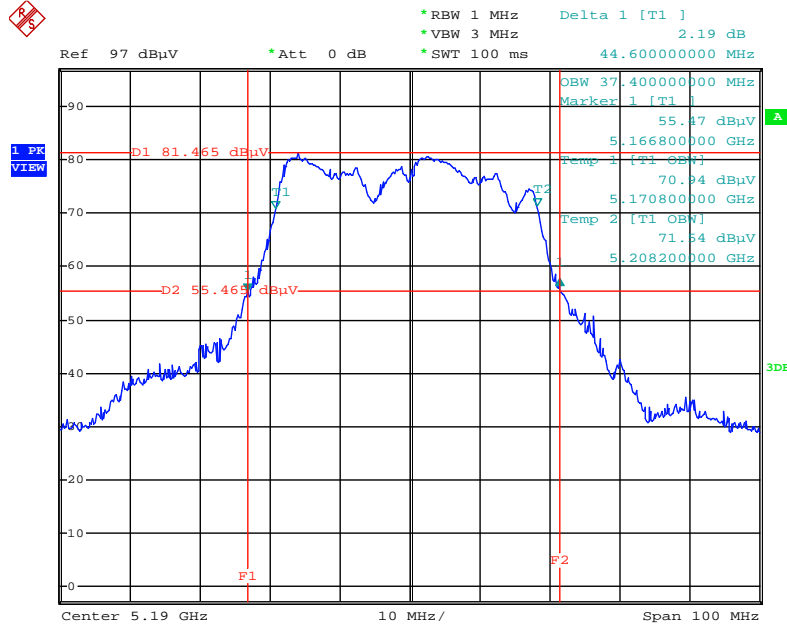

Date: 10.SEP.2015 19:37:16

26dB Bandwidth and 99% Occupied Bandwidth Plot on Configuration IEEE 802.11ac MCS0/Nss1 VHT40 / Ant. 1 + Ant. 2 + Ant. 3 / 5230 MHz

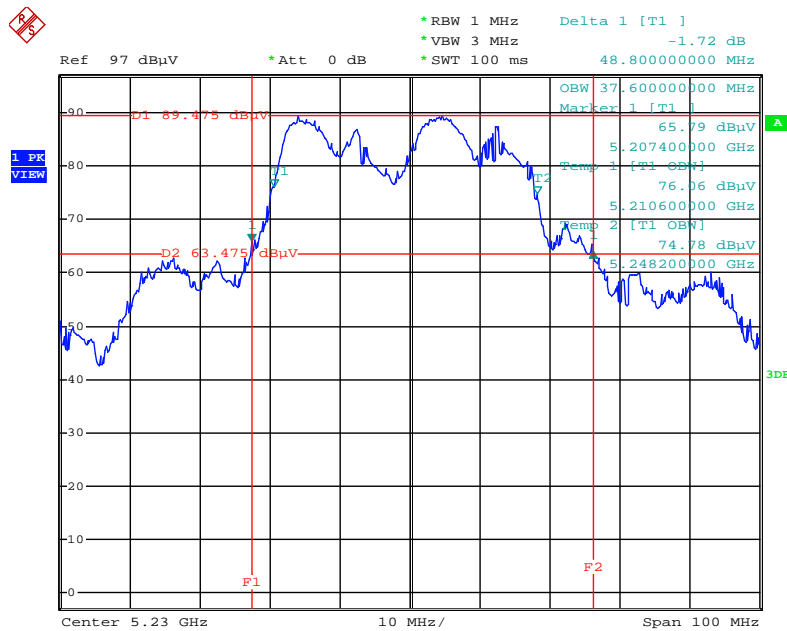

Date: 11.SEP.2015 01:42:20

26dB Bandwidth and 99% Occupied Bandwidth Plot on Configuration IEEE 802.11ac MCS0/Nss1 VHT40 / Ant. 1 + Ant. 2 + Ant. 3 / 5755 MHz

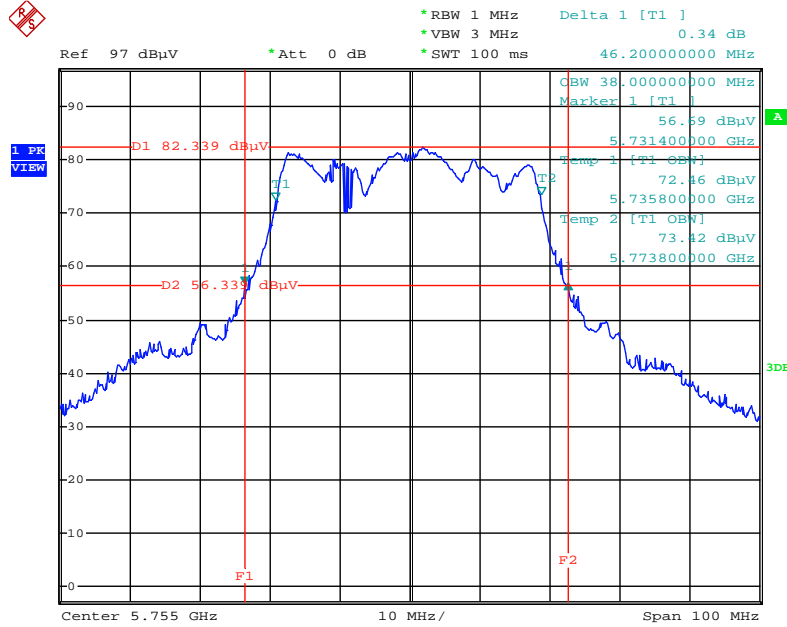

Date: 10.SEP.2015 19:39:46

26dB Bandwidth and 99% Occupied Bandwidth Plot on Configuration IEEE 802.11ac MCS0/Nss1 VHT40 / Ant. 1 + Ant. 2 + Ant. 3 / 5795 MHz

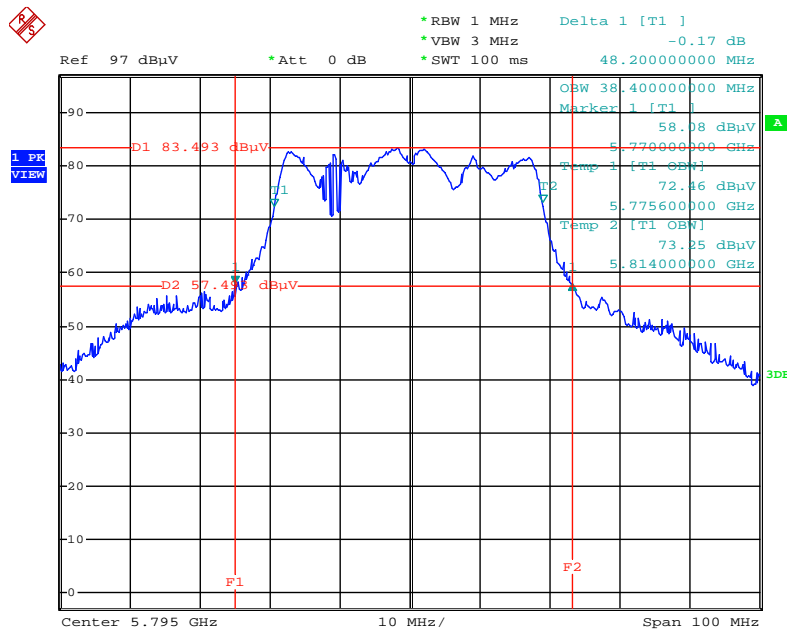

Date: 10.SEP.2015 19:40:23

26dB Bandwidth and 99% Occupied Bandwidth Plot on Configuration IEEE 802.11ac MCS0/Nss1 VHT80 / Ant. 1 + Ant. 2 + Ant. 3 / 5210 MHz

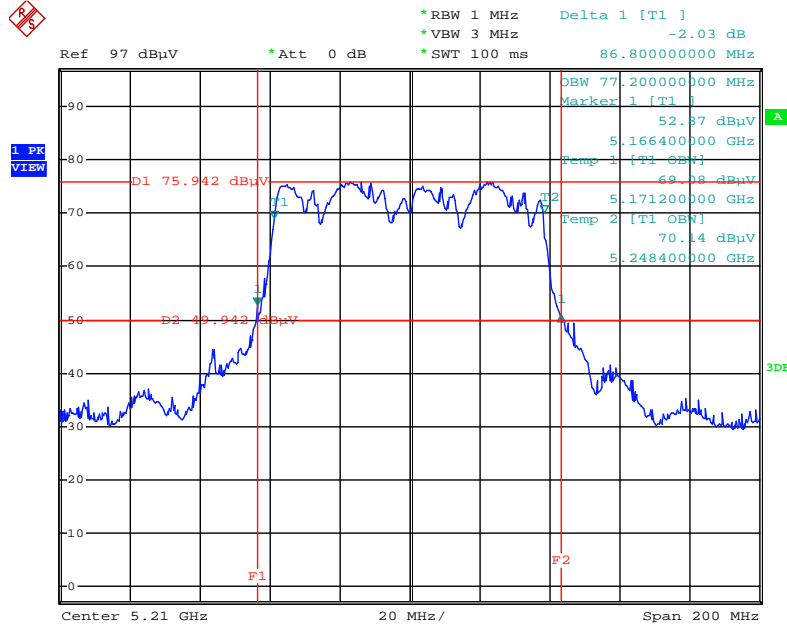

Date: 10.SEP.2015 19:44:11

26dB Bandwidth and 99% Occupied Bandwidth Plot on Configuration IEEE 802.11ac MCS0/Nss1 VHT80 / Ant. 1 + Ant. 2 + Ant. 3 / 5775 MHz

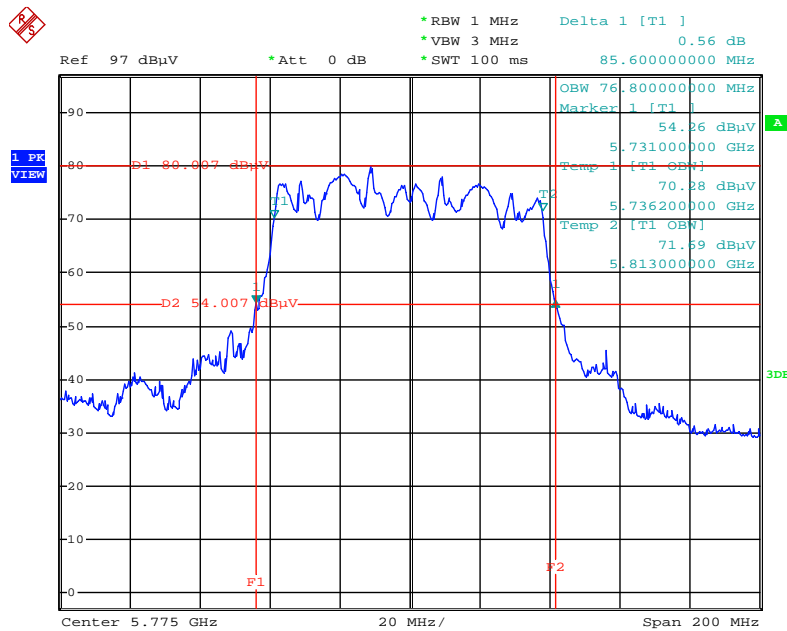

Date: 10.SEP.2015 19:50:25

4.3. 6dB Spectrum Bandwidth Measurement

4.3.1. Limit

For digital modulation systems, the minimum 6dB bandwidth shall be at least 500 kHz.

4.3.2. Measuring Instruments and Setting

Please refer to section 5 of equipments list in this report. The following table is the setting of spectrum analyzer.

6dB Spectrum Bandwidth	
Spectrum Parameters	Setting
Attenuation	Auto
Span Frequency	> 6dB Bandwidth
RBW	100kHz
VBW	$\geq 3 \times \text{RBW}$
Detector	Peak
Trace	Max Hold
Sweep Time	Auto

4.3.3. Test Procedures

For Radiated 6dB Bandwidth Measurement:

1. The transmitter was radiated to the spectrum analyzer in peak hold mode.
2. Test was performed in accordance with KDB789033 D02 v01 for Compliance Testing of Unlicensed National Information Infrastructure (U-NII) Devices - section (C) Emission Bandwidth.
3. Multiple antenna system was performed in accordance with KDB662911 D01 v02r01 Emissions Testing of Transmitters with Multiple Outputs in the Same Band.
4. Measured the spectrum width with power higher than 6dB below carrier.

4.3.4. Test Setup Layout

For Radiated 6dB Bandwidth Measurement:

This test setup layout is the same as that shown in section 4.6.4.

4.3.5. Test Deviation

There is no deviation with the original standard.

4.3.6. EUT Operation during Test

The EUT was programmed to be in continuously transmitting mode.

4.3.7. Test Result of 6dB Spectrum Bandwidth

Temperature	25°C	Humidity	53%
Test Engineer	Nick Peng / Clemens Fang		

Mode	Frequency	6dB Bandwidth (MHz)	Min. Limit (kHz)	Test Result
802.11a	5745 MHz	15.68	500	Complies
	5785 MHz	16.32	500	Complies
	5825 MHz	16.32	500	Complies
802.11ac MCS0/Nss1 VHT20	5745 MHz	17.52	500	Complies
	5785 MHz	17.52	500	Complies
	5825 MHz	17.52	500	Complies
802.11ac MCS0/Nss1 VHT40	5755 MHz	36.16	500	Complies
	5795 MHz	36.32	500	Complies
802.11ac MCS0/Nss1 VHT80	5775 MHz	75.20	500	Complies

Note: All the test values were listed in the report.

For plots, only the channel with worse result was shown.

6 dB Bandwidth Plot on Configuration IEEE 802.11a / Ant. 1 + Ant. 2 + Ant. 3 / 5745 MHz

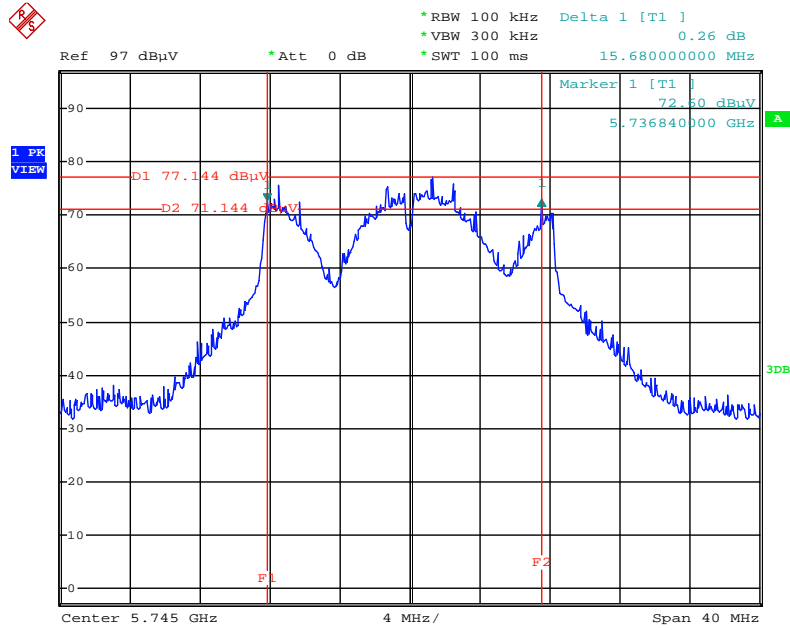

Date: 10.SEP.2015 20:11:55

6 dB Bandwidth Plot on Configuration IEEE 802.11ac MCS0/Nss1 VHT20 / Ant. 1 + Ant. 2 + Ant. 3 / 5745 MHz

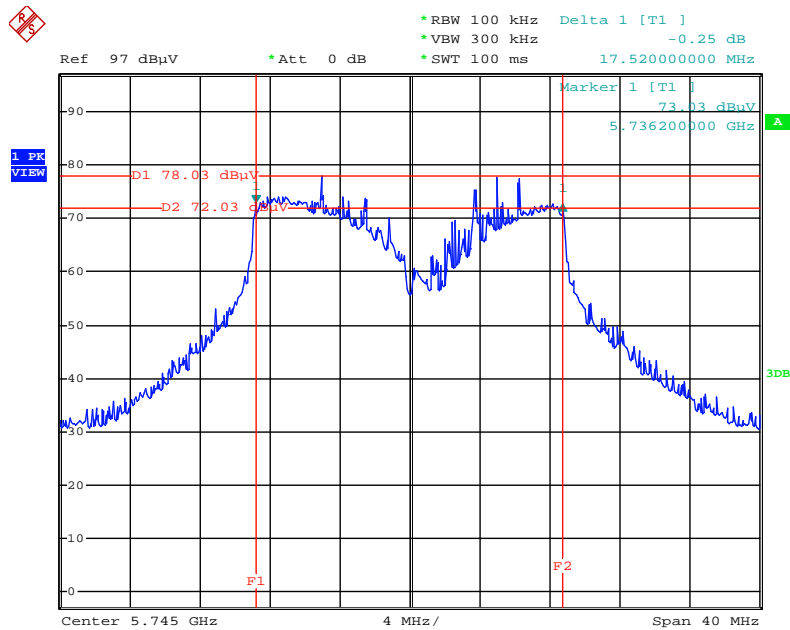

Date: 10.SEP.2015 20:03:44

6 dB Bandwidth Plot on Configuration IEEE 802.11ac MCS0/Nss1 VHT40 / Ant. 1 + Ant. 2 + Ant. 3 / 5755MHz

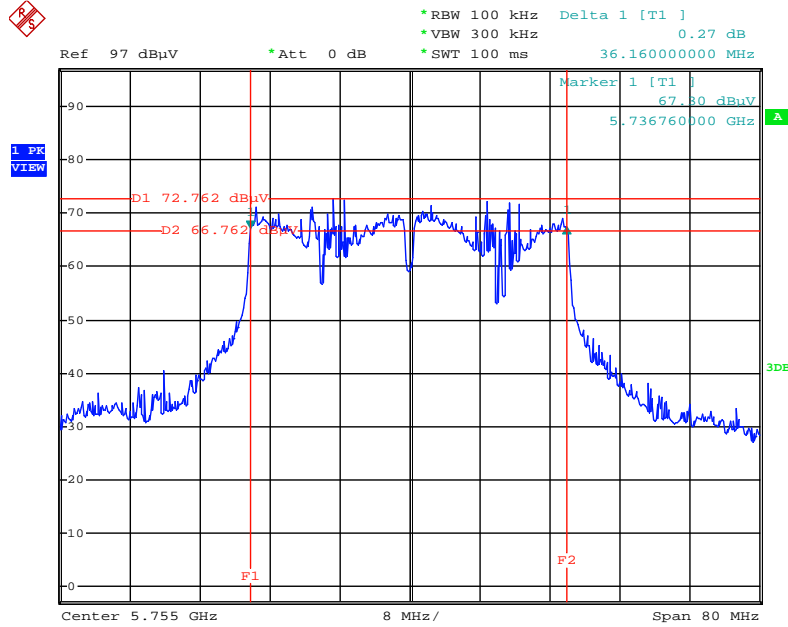

Date: 10.SEP.2015 20:00:17

6 dB Bandwidth Plot on Configuration IEEE 802.11ac MCS0/Nss1 VHT80 / Ant. 1 + Ant. 2 + Ant. 3 / 5775 MHz

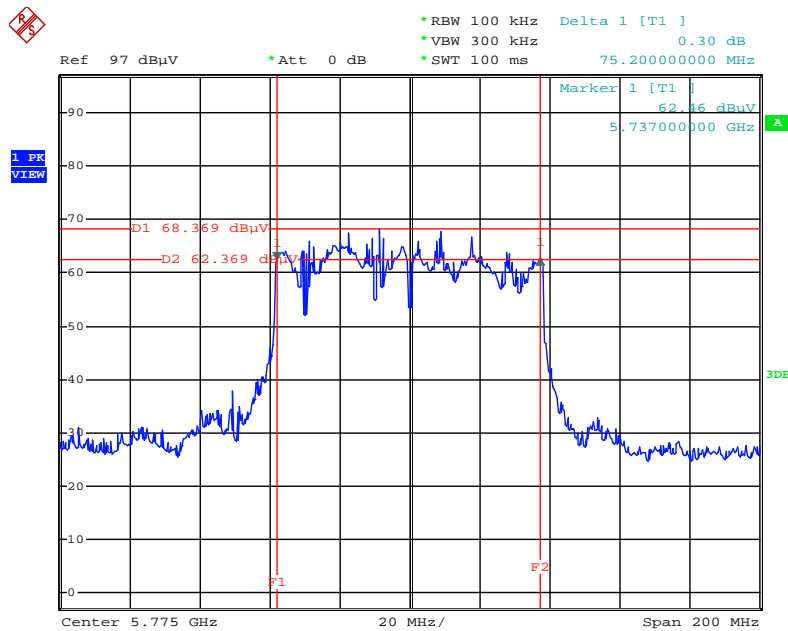

Date: 10.SEP.2015 19:58:51

4.4. Maximum Conducted Output Power Measurement

4.4.1. Limit

Frequency Band	Limit
<input checked="" type="checkbox"/> 5.15~5.25 GHz	
Operating Mode	
<input type="checkbox"/> Outdoor access point	<p>The maximum conducted output power over the frequency band of operation shall not exceed 1 W (30dBm) provided the maximum antenna gain does not exceed 6 dBi. If transmitting antennas of directional gain greater than 6 dBi are used, both the maximum conducted output power and the maximum power spectral density shall be reduced by the amount in dB that the directional gain of the antenna exceeds 6 dBi. The maximum e.i.r.p. at any elevation angle above 30 degrees as measured from the horizon must not exceed 125 mW (21 dBm).</p>
<input checked="" type="checkbox"/> Indoor access point	<p>The maximum conducted output power over the frequency band of operation shall not exceed 1 W (30dBm) provided the maximum antenna gain does not exceed 6 dBi. If transmitting antennas of directional gain greater than 6 dBi are used, both the maximum conducted output power and the maximum power spectral density shall be reduced by the amount in dB that the directional gain of the antenna exceeds 6 dBi.</p>
<input type="checkbox"/> Fixed point-to-point access points	<p>The maximum conducted output power over the frequency band of operation shall not exceed 1 W (30dBm). Fixed point-to-point U-NII devices may employ antennas with directional gain up to 23 dBi without any corresponding reduction in the maximum conducted output power or maximum power spectral density. For fixed point-to-point transmitters that employ a directional antenna gain greater than 23 dBi, a 1 dB reduction in maximum conducted output power and maximum power spectral density is required for each 1 dB of antenna gain in excess of 23 dBi.</p>
<input type="checkbox"/> Mobile and portable client devices	<p>The maximum conducted output power over the frequency band of operation shall not exceed 250 mW (24dBm) provided the maximum antenna gain does not exceed 6 dBi. If transmitting antennas of directional gain greater than 6 dBi are used, both the maximum conducted output power and the maximum power spectral density shall be reduced by the amount in dB that the directional gain of the antenna exceeds 6 dBi.</p>

☒	5.725~5.85 GHz	The maximum conducted output power over the frequency band of operation shall not exceed 1 W (30dBm). If transmitting antennas of directional gain greater than 6 dBi are used, both the maximum conducted output power and the maximum power spectral density shall be reduced by the amount in dB that the directional gain of the antenna exceeds 6 dBi. However, fixed point-to-point U-NII devices operating in this band may employ transmitting antennas with directional gain greater than 6 dBi without any corresponding reduction in transmitter conducted power.
---	----------------	--

4.4.2. Measuring Instruments and Setting

Please refer to section 5 of equipments list in this report. The following table is the setting of the power meter.

Power Meter Parameter	Setting
Detector	AVERAGE

4.4.3. Test Procedures

1. The transmitter output (antenna port) was connected to the power meter.
2. Test was performed in accordance with KDB789033 D02 v01 for Compliance Testing of Unlicensed National Information Infrastructure (U-NII) Devices - section (E) Maximum conducted output power =>3. Measurement using a Power Meter (PM) =>b) Method PM-G (Measurement using a gated RF average power meter).
3. Multiple antenna systems was performed in accordance with KDB662911 D01 v02r01 Emissions Testing of Transmitters with Multiple Outputs in the Same Band.
4. When measuring maximum conducted output power with multiple antenna systems, add every result of the values by mathematic formula.

4.4.4. Test Setup Layout

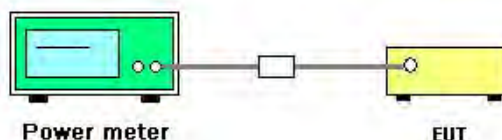

4.4.5. Test Deviation

There is no deviation with the original standard.

4.4.6. EUT Operation during Test

The EUT was programmed to be in continuously transmitting mode.

4.4.7. Test Result of Maximum Conducted Output Power

Temperature	25°C	Humidity	53%
Test Engineer	Nick Peng / Clemens Fang	Test Date	Sep. 10, 2015

Mode	Frequency	Conducted Power (dBm)				Max. Limit (dBm)	Result
		Ant. 1	Ant. 2	Ant. 3	Total		
802.11a	5180 MHz	21.32	18.62	18.94	24.57	30.00	Complies
	5200 MHz	22.22	20.19	21.06	26.01	30.00	Complies
	5240 MHz	22.42	21.08	22.34	26.76	30.00	Complies
	5745 MHz	14.95	18.14	14.32	20.92	30.00	Complies
	5785 MHz	13.91	17.32	15.42	20.55	30.00	Complies
	5825 MHz	13.63	17.28	17.07	21.05	30.00	Complies
802.11ac MCS0/Nss1 VHT20	5180 MHz	21.66	19.05	19.17	24.91	30.00	Complies
	5200 MHz	23.11	21.64	23.69	27.67	30.00	Complies
	5240 MHz	22.50	21.40	23.15	27.18	30.00	Complies
	5745 MHz	15.33	17.60	14.41	20.77	30.00	Complies
	5785 MHz	14.65	16.75	14.94	20.32	30.00	Complies
	5825 MHz	14.43	16.12	17.29	20.87	30.00	Complies
802.11ac MCS0/Nss1 VHT40	5190 MHz	15.81	13.95	13.37	19.28	30.00	Complies
	5230 MHz	21.90	21.04	21.68	26.33	30.00	Complies
	5755 MHz	14.27	17.06	13.76	20.06	30.00	Complies
	5795 MHz	16.86	19.14	19.07	23.25	30.00	Complies
802.11ac MCS0/Nss1 VHT80	5210 MHz	14.40	13.51	13.17	18.50	30.00	Complies
	5775 MHz	12.97	15.34	13.23	18.75	30.00	Complies

4.5. Power Spectral Density Measurement

4.5.1. Limit

The following table is power spectral density limits and decrease power density limit rule refer to section 4.4.1.

Frequency Band		Limit
<input checked="" type="checkbox"/>	5.15~5.25 GHz	
	Operating Mode	
<input type="checkbox"/>	Outdoor access point	17 dBm/MHz
<input checked="" type="checkbox"/>	Indoor access point	17 dBm/MHz
<input type="checkbox"/>	Fixed point-to-point access points	17 dBm/MHz
<input type="checkbox"/>	Mobile and portable client devices	11 dBm/MHz
<input checked="" type="checkbox"/>	5.725~5.85 GHz	30 dBm/500kHz

4.5.2. Measuring Instruments and Setting

Please refer to section 5 of equipments list in this report. The following table is the setting of the spectrum analyzer.

Spectrum Parameter	Setting
Attenuation	Auto
Span Frequency	Encompass the entire emissions bandwidth (EBW) of the signal
RBW	1000 kHz
VBW	3000 kHz
Detector	RMS
Trace	AVERAGE
Sweep Time	Auto
Trace Average	100 times
Note: If measurement bandwidth of Maximum PSD is specified in 500 kHz, add $10\log(500\text{kHz}/\text{RBW})$ to the measured result, whereas RBW (< 500 kHz) is the reduced resolution bandwidth of the spectrum analyzer set during measurement.	

4.5.3. Test Procedures

1. The transmitter output (antenna port) was connected RF switch to the spectrum analyzer.
2. Test was performed in accordance with KDB789033 D02 v01 for Compliance Testing of Unlicensed National Information Infrastructure (U-NII) Devices - section (F) Maximum Power Spectral Density (PSD).
3. Multiple antenna systems was performed in accordance KDB662911 D01 v02r01 in-Band Power Spectral Density (PSD) Measurements (a) Measure and sum the spectra across the outputs.
4. When measuring first spectral bin of output 1 is summed with that in the first spectral bin of output 2 and that from the first spectral bin of output 3 and so on up to the Nth output to obtain the value for the first frequency bin of the summed spectrum. The summed spectrum value for each of the other frequency bins is computed in the same way.
5. For 5.725~5.85 GHz, the measured result of PSD level must add $10\log(500\text{kHz}/\text{RBW})$ and the final result should ≤ 30 dBm.

4.5.4. Test Setup Layout

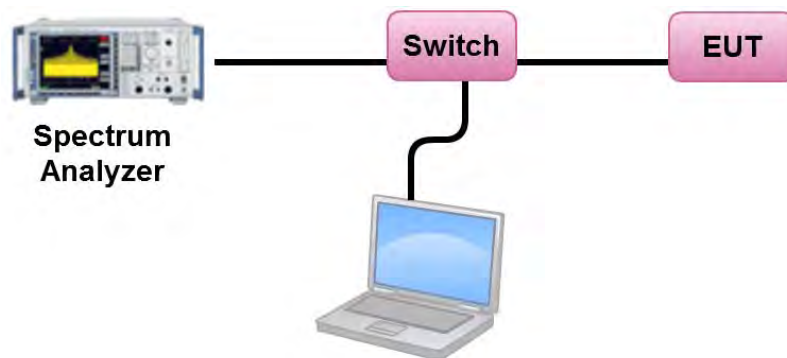

4.5.5. Test Deviation

There is no deviation with the original standard.

4.5.6. EUT Operation during Test

The EUT was programmed to be in continuously transmitting mode.

4.5.7. Test Result of Power Spectral Density

Temperature	25°C	Humidity	53%
Test Engineer	Nick Peng / Clemens Fang	Test Date	Sep. 10, 2015

Configuration IEEE 802.11a / Ant. 1 + Ant. 2 + Ant. 3

Channel	Frequency	Power Density (dBm/MHz)	Max. Limit (dBm/MHz)	Result
36	5180 MHz	11.15	14.86	Complies
40	5200 MHz	12.50	14.86	Complies
48	5240 MHz	13.27	14.86	Complies

Note: $Directional\ Gain = 10 \cdot \log \left[\frac{\sum_{j=1}^{N_{ANT}} \left(\sum_{k=1}^{N_{ANT}} G_{j,k} \right)^2}{N_{ANT}} \right] = 8.14\text{dBi}$, so limit = $17 - (8.14 - 6) = 14.86\text{ dBm/MHz}$

Channel	Frequency	Power Density (dBm/MHz)	10log(500kHz/RBW) Factor (dB)	Power Density (dBm/500kHz)	Power Density Limit (dBm/500kHz)	Result
149	5745 MHz	7.77	-3.01	4.76	27.86	Complies
157	5785 MHz	7.32	-3.01	4.31	27.86	Complies
165	5825 MHz	7.82	-3.01	4.81	27.86	Complies

Note: $Directional\ Gain = 10 \cdot \log \left[\frac{\sum_{j=1}^{N_{ANT}} \left(\sum_{k=1}^{N_{ANT}} G_{j,k} \right)^2}{N_{ANT}} \right] = 8.14\text{dBi}$, so limit = $30 - (8.14 - 6) = 27.86\text{ dBm/500kHz}$

Configuration IEEE 802.11ac MCS0/Nss1 VHT20 / Ant. 1 + Ant. 2 + Ant. 3

Channel	Frequency	Power Density (dBm/MHz)	Max. Limit (dBm/MHz)	Result
36	5180 MHz	11.48	14.86	Complies
40	5200 MHz	14.20	14.86	Complies
48	5240 MHz	13.62	14.86	Complies

Note: $Directional\ Gain = 10 \cdot \log \left[\frac{\sum_{j=1}^{N_{ANT}} \left(\sum_{k=1}^{N_{ANT}} G_{j,k} \right)^2}{N_{ANT}} \right] = 8.14\text{dBi}$, so limit = $17 - (8.14 - 6) = 14.86\text{ dBm/MHz}$

Channel	Frequency	Power Density (dBm/MHz)	10log(500kHz/RBW) Factor (dB)	Power Density (dBm/500kHz)	Power Density Limit (dBm/500kHz)	Result
149	5745 MHz	7.37	-3.01	4.36	27.86	Complies
157	5785 MHz	7.10	-3.01	4.09	27.86	Complies
165	5825 MHz	7.46	-3.01	4.45	27.86	Complies

Note: $Directional\ Gain = 10 \cdot \log \left[\frac{\sum_{j=1}^{N_{ANT}} \left(\sum_{k=1}^{N_{ANT}} G_{j,k} \right)^2}{N_{ANT}} \right] = 8.14\text{dBi}$, so limit = $30 - (8.14 - 6) = 27.86\text{ dBm/500kHz}$

Configuration IEEE 802.11ac MCS0/Nss1 VHT40 / Ant. 1 + Ant. 2 + Ant. 3

Channel	Frequency	Power Density (dBm/MHz)	Max. Limit (dBm/MHz)	Result
38	5190 MHz	3.03	14.86	Complies
46	5230 MHz	10.27	14.86	Complies

Note: $Directional\ Gain = 10 \cdot \log \left[\frac{\sum_{j=1}^{N_{ANT}} \left\{ \sum_{k=1}^{N_{ANT}} g_{j,k} \right\}^2}{N_{ANT}} \right] = 8.14\text{dBi}$, so limit = $17 - (8.14 - 6) = 14.86$ dBm/MHz

Channel	Frequency	Power Density (dBm/MHz)	10log(500kHz/RBW) Factor (dB)	Power Density (dBm/500kHz)	Power Density Limit (dBm/500kHz)	Result
151	5755 MHz	3.48	-3.01	0.47	27.86	Complies
159	5795 MHz	6.79	-3.01	3.78	27.86	Complies

Note: $Directional\ Gain = 10 \cdot \log \left[\frac{\sum_{j=1}^{N_{ANT}} \left\{ \sum_{k=1}^{N_{ANT}} g_{j,k} \right\}^2}{N_{ANT}} \right] = 8.14\text{dBi}$, so limit = $30 - (8.14 - 6) = 27.86$ dBm/500kHz

Configuration IEEE 802.11ac MCS0/Nss1 VHT80 / Ant. 1 + Ant. 2 + Ant. 3

Channel	Frequency	Power Density (dBm/MHz)	Max. Limit (dBm/MHz)	Result
42	5210 MHz	-0.74	14.86	Complies

Note: $Directional\ Gain = 10 \cdot \log \left[\frac{\sum_{j=1}^{N_{ANT}} \left\{ \sum_{k=1}^{N_{ANT}} g_{j,k} \right\}^2}{N_{ANT}} \right] = 8.14\text{dBi}$, so limit = $17 - (8.14 - 6) = 14.86$ dBm/MHz

Channel	Frequency	Power Density (dBm/MHz)	10log(500kHz/RBW) Factor (dB)	Power Density (dBm/500kHz)	Power Density Limit (dBm/500kHz)	Result
155	5775 MHz	-0.66	-3.01	-3.67	27.86	Complies

Note: $Directional\ Gain = 10 \cdot \log \left[\frac{\sum_{j=1}^{N_{ANT}} \left\{ \sum_{k=1}^{N_{ANT}} g_{j,k} \right\}^2}{N_{ANT}} \right] = 8.14\text{dBi}$, so limit = $30 - (8.14 - 6) = 27.86$ dBm/500kHz

Note: All the test values were listed in the report.

For plots, only the channel with worse result was shown.

Power Density Plot on Configuration IEEE 802.11a / Ant. 1 + Ant. 2 + Ant. 3 / 5240MHz

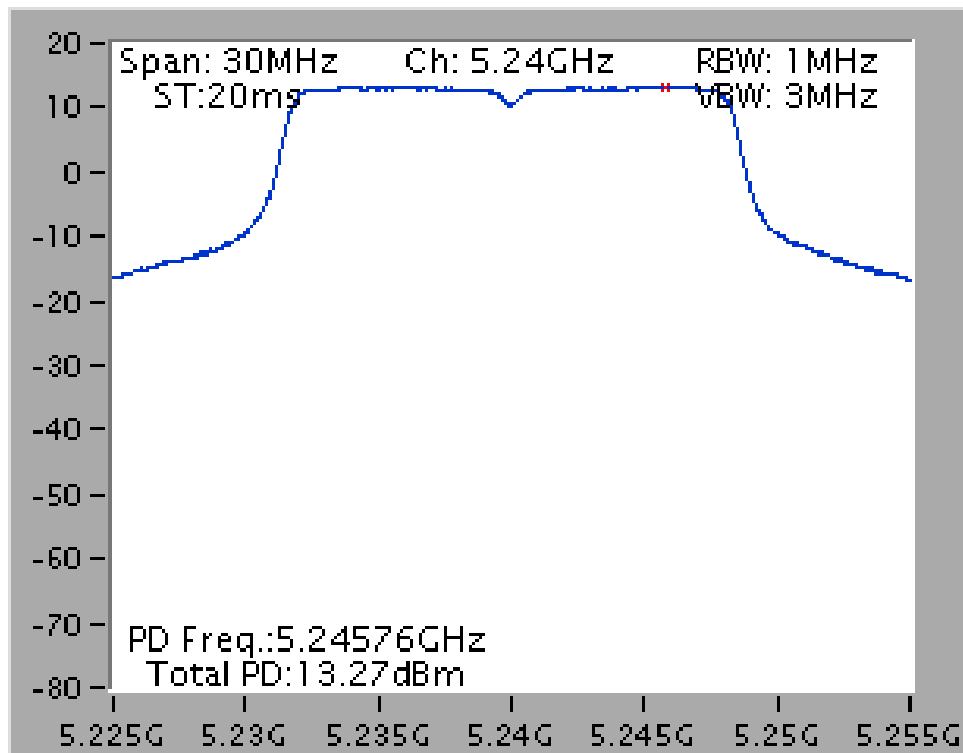

Power Density Plot on Configuration IEEE 802.11a / Ant. 1 + Ant. 2 + Ant. 3 / 5825 MHz

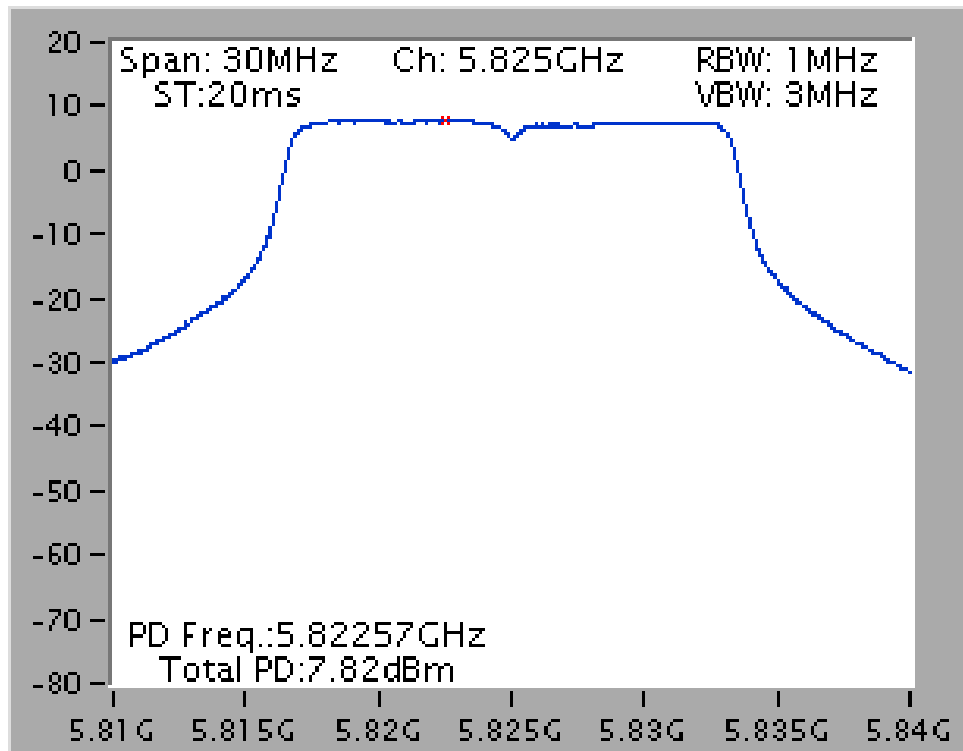

Power Density Plot on Configuration IEEE 802.11ac MCS0/Nss1 VHT20 / Ant. 1 + Ant. 2 + Ant. 3 / 5200 MHz

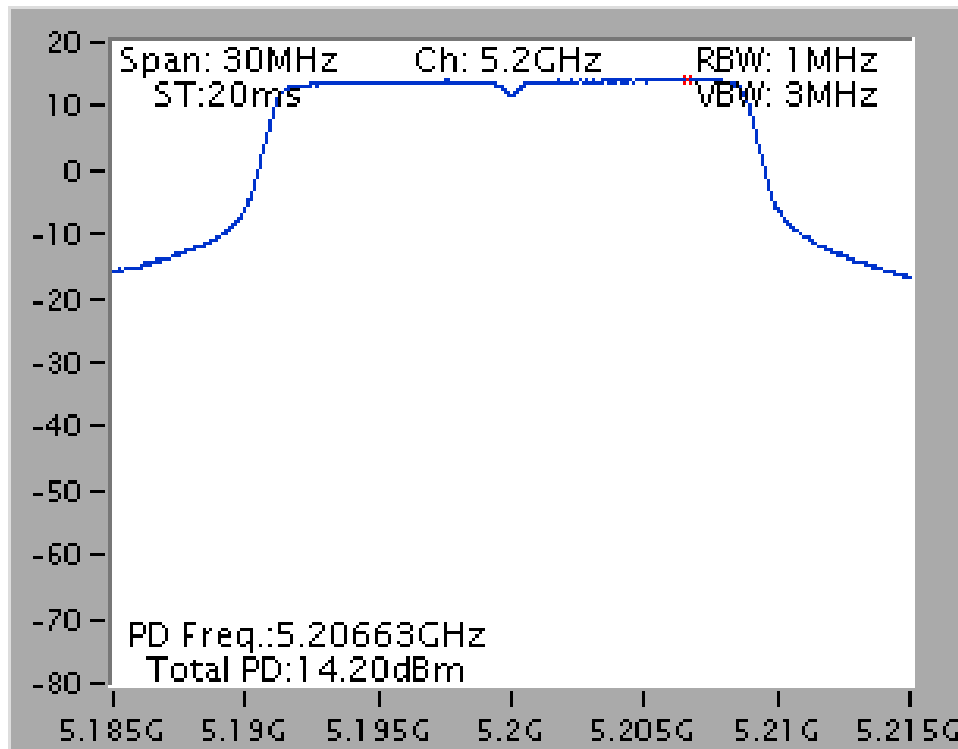

Power Density Plot on Configuration IEEE 802.11ac MCS0/Nss1 VHT20 / Ant. 1 + Ant. 2 + Ant. 3 / 5825 MHz

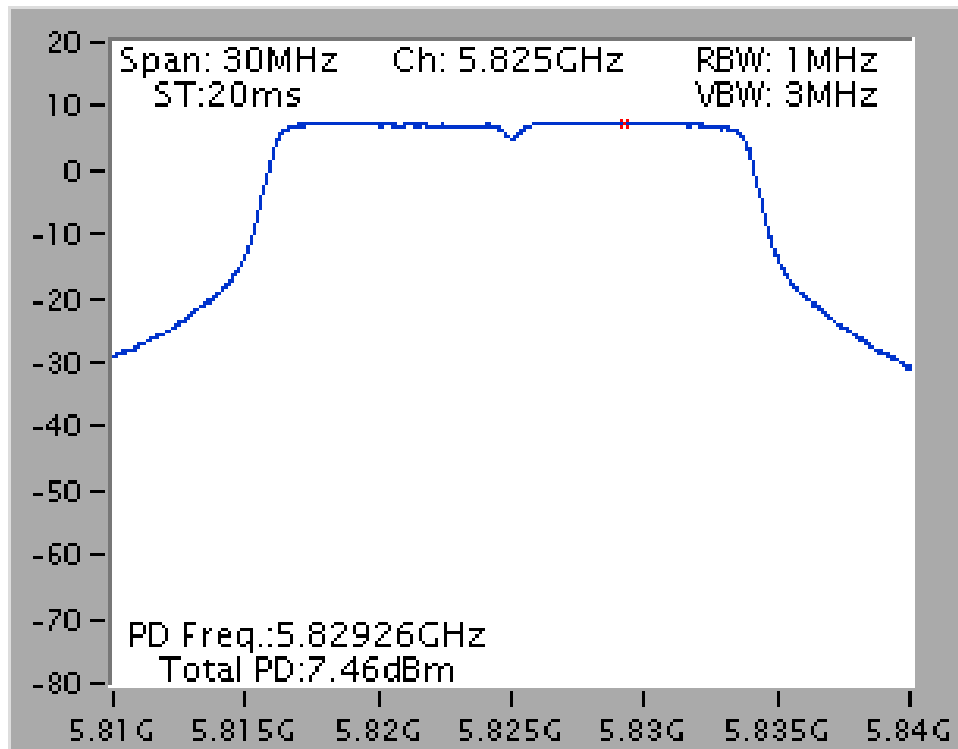

Power Density Plot on Configuration IEEE 802.11ac MCS0/Nss1 VHT40 / Ant. 1 + Ant. 2 + Ant. 3 / 5230 MHz

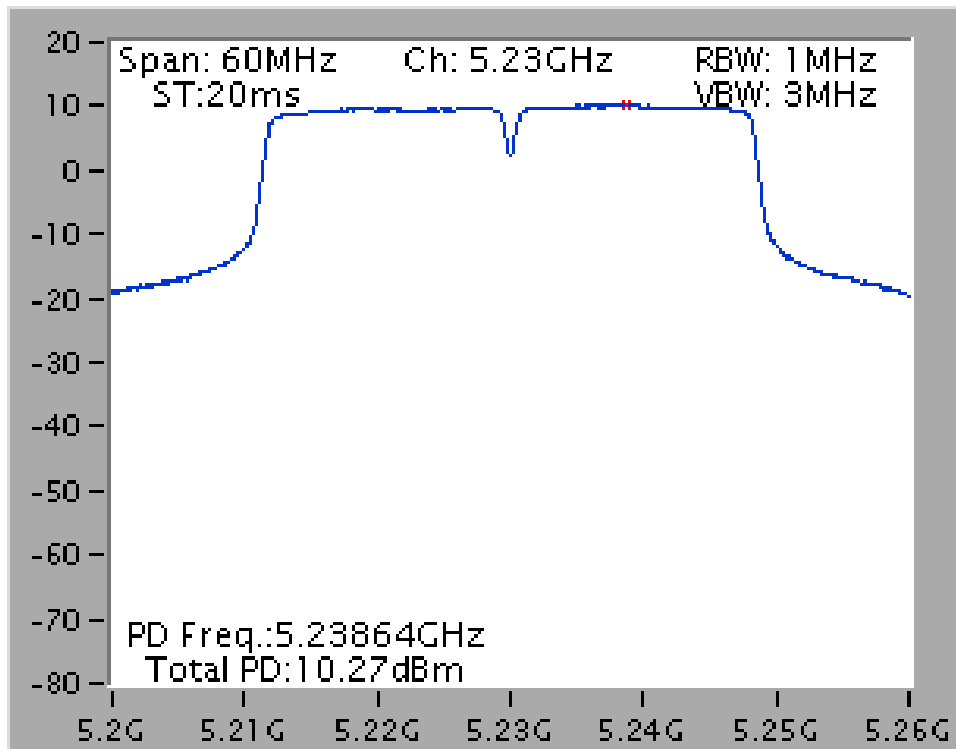

Power Density Plot on Configuration IEEE 802.11ac MCS0/Nss1 VHT40 / Ant. 1 + Ant. 2 + Ant. 3 / 5795 MHz

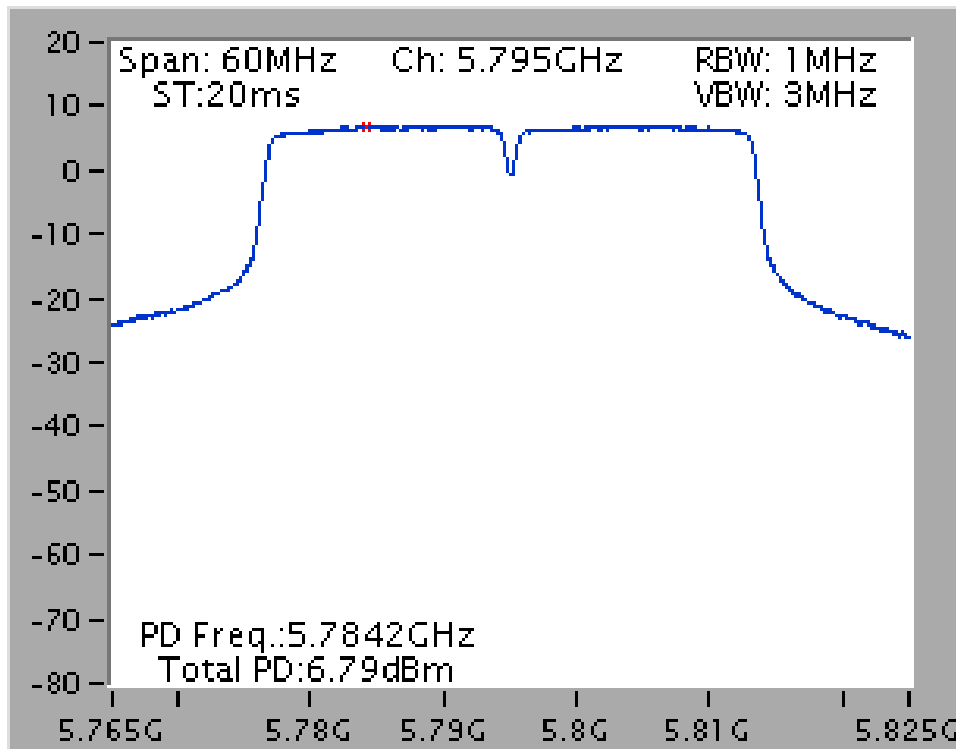

Power Density Plot on Configuration IEEE 802.11ac MCS0/Nss1 VHT80 / Ant. 1 + Ant. 2 + Ant. 3 / 5210 MHz

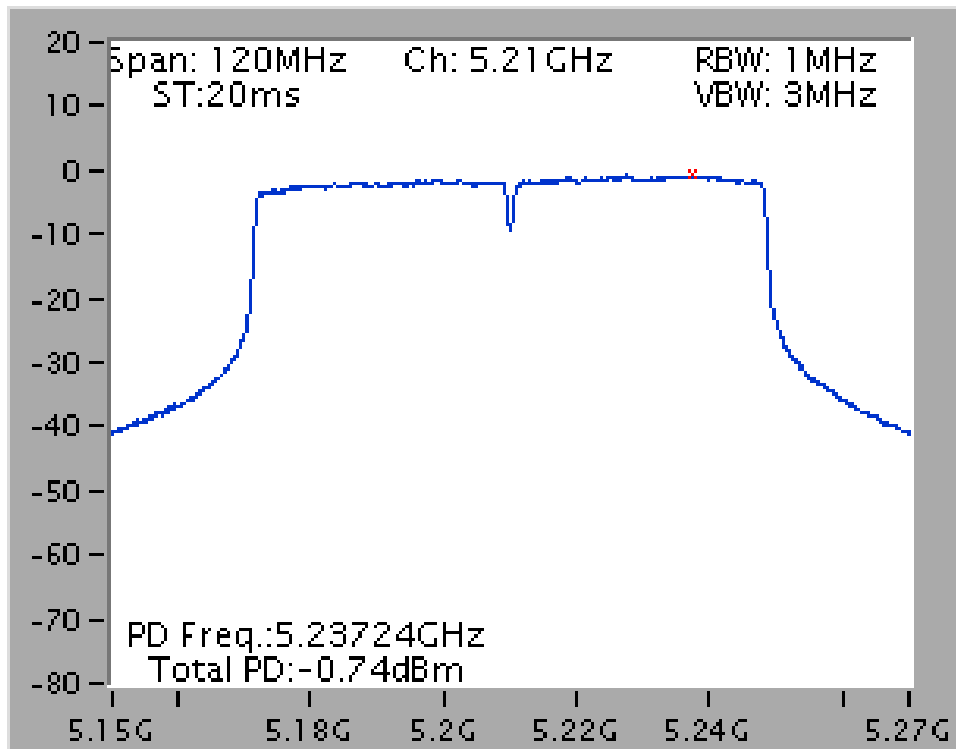

Power Density Plot on Configuration IEEE 802.11ac MCS0/Nss1 VHT80 / Ant. 1 + Ant. 2 + Ant. 3 / 5775 MHz

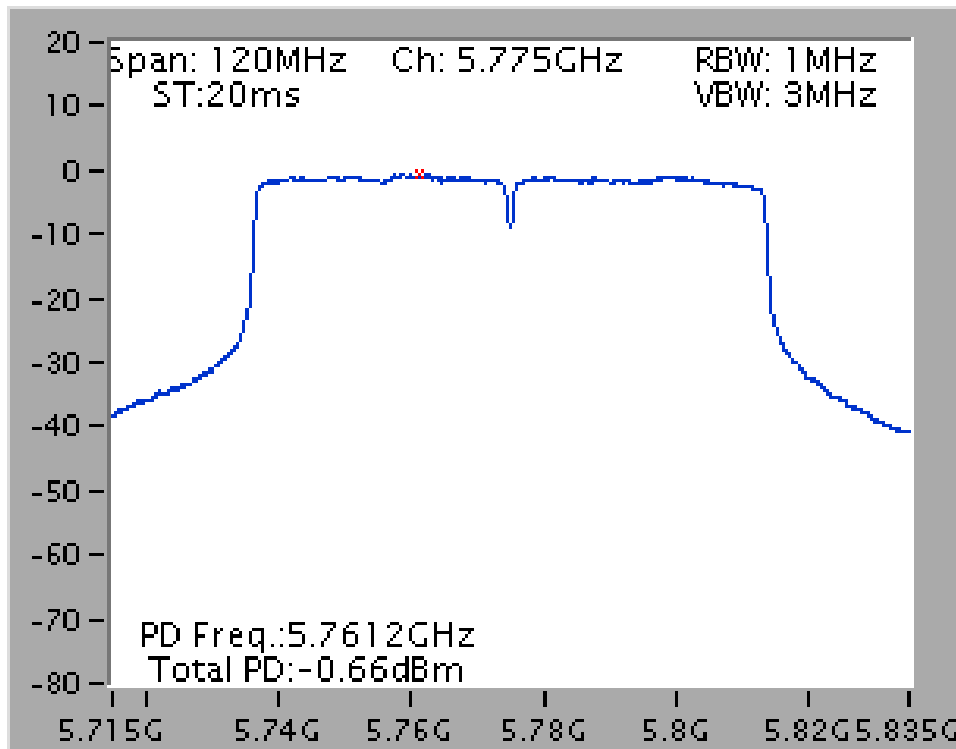

4.6. Radiated Emissions Measurement

4.6.1. Limit

For transmitters operating in the 5.15-5.25 GHz band: all emissions outside of the 5.15-5.35 GHz band shall not exceed an e.i.r.p. of -27 dBm/MHz.

For transmitters operating in the 5.725-5.85 GHz band: all emissions within the frequency range from the band edge to 10 MHz above or below the band edge shall not exceed an e.i.r.p. of -17 dBm/MHz; for frequencies 10 MHz or greater above or below the band edge, emissions shall not exceed an e.i.r.p. of -27 dBm/MHz.

In addition, In case the emission fall within the restricted band specified on 15.205(a), then the 15.209(a) limit in the table below has to be followed.

Frequencies (MHz)	Field Strength (microvolts/meter)	Measurement Distance (meters)
0.009~0.490	2400/F(kHz)	300
0.490~1.705	24000/F(kHz)	30
1.705~30.0	30	30
30~88	100	3
88~216	150	3
216~960	200	3
Above 960	500	3

4.6.2. Measuring Instruments and Setting

Please refer to section 5 of equipments list in this report. The following table is the setting of spectrum analyzer and receiver.

Spectrum Parameter	Setting
Attenuation	Auto
Start Frequency	1000 MHz
Stop Frequency	40 GHz
RBW / VBW (Emission in restricted band)	1 MHz / 3MHz for Peak, 1 MHz / 1/T for Average
RBW / VBW (Emission in non-restricted band)	1 MHz / 3MHz for peak

Receiver Parameter	Setting
Attenuation	Auto
Start ~ Stop Frequency	9kHz~150kHz / RBW 200Hz for QP
Start ~ Stop Frequency	150kHz~30MHz / RBW 9kHz for QP
Start ~ Stop Frequency	30MHz~1000MHz / RBW 120kHz for QP

4.6.3. Test Procedures

1. Configure the EUT according to ANSI C63.10. The EUT was placed on the top of the turntable 1.5 meter above ground. The phase center of the receiving antenna mounted on the top of a height-variable antenna tower was placed 1m & 3m far away from the turntable.
2. Power on the EUT and all the supporting units. The turntable was rotated by 360 degrees to determine the position of the highest radiation.
3. The height of the broadband receiving antenna was varied between one meter and four meters above ground to find the maximum emissions field strength of both horizontal and vertical polarization.
4. For each suspected emissions, the antenna tower was scan (from 1 M to 4 M) and then the turntable was rotated (from 0 degree to 360 degrees) to find the maximum reading.
5. Set the test-receiver system to Peak or CISPR quasi-peak Detect Function with specified bandwidth under Maximum Hold Mode.
6. For emissions above 1GHz, use 1MHz VBW and 3MHz RBW for peak reading. Then 1MHz RBW and 1/T VBW for average reading in spectrum analyzer.
7. If the emissions level of the EUT in peak mode was 3 dB lower than the average limit specified, then testing will be stopped and peak values of EUT will be reported, otherwise, the emissions which do not have 3 dB margin will be repeated one by one using the quasi-peak method for below 1GHz.
8. For testing above 1GHz, the emissions level of the EUT in peak mode was lower than average limit (that means the emissions level in peak mode also complies with the limit in average mode), then testing will be stopped and peak values of EUT will be reported, otherwise, the emissions will be measured in average mode again and reported.
9. In case the emission is lower than 30MHz, loop antenna has to be used for measurement and the recorded data should be QP measured by receiver. High – Low scan is not required in this case.

4.6.4. Test Setup Layout

For Radiated Emissions: 9kHz ~30MHz

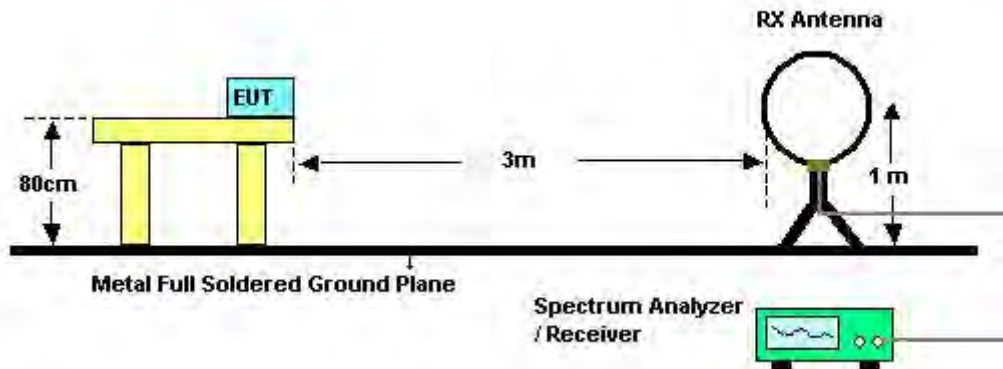

For Radiated Emissions: 30MHz~1GHz

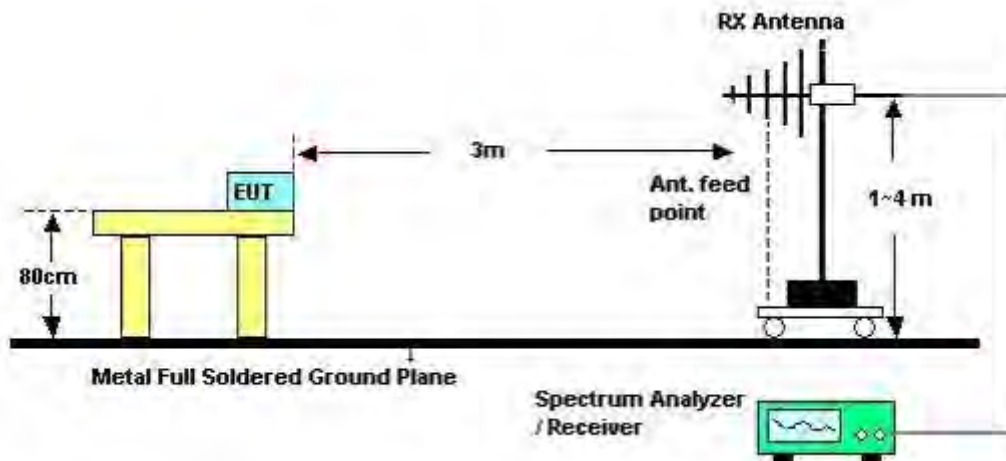

For Radiated Emissions: Above 1GHz

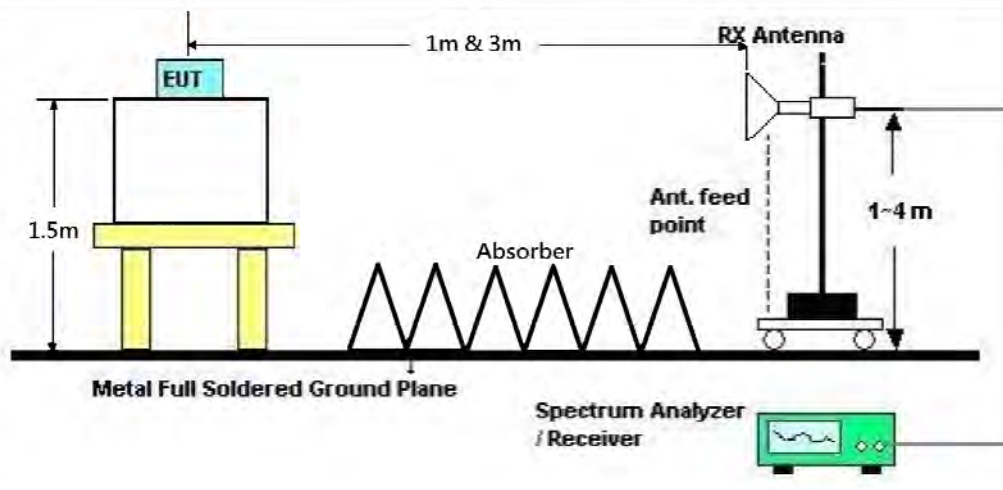

4.6.5. Test Deviation

There is no deviation with the original standard.

4.6.6. EUT Operation during Test

The EUT was programmed to be in continuously transmitting mode.

4.6.7. Results of Radiated Emissions (9kHz~30MHz)

Temperature	25°C	Humidity	66%
Test Engineer	Stim Sung	Configurations	Normal Link
Test Date	Oct. 12, 2015		

Freq. (MHz)	Level (dBuV)	Over Limit (dB)	Limit Line (dBuV)	Remark
-	-	-	-	See Note

Note:

The amplitude of spurious emissions which are attenuated by more than 20 dB below the permissible value has no need to be reported.

Distance extrapolation factor = $40 \log(\text{specific distance} / \text{test distance})$ (dB);

Limit line = specific limits (dBuV) + distance extrapolation factor.

4.6.8. Results of Radiated Emissions (30MHz~1GHz)

Temperature	25°C	Humidity	66%
Test Engineer	Stim Sung	Configurations	Normal Link

Horizontal

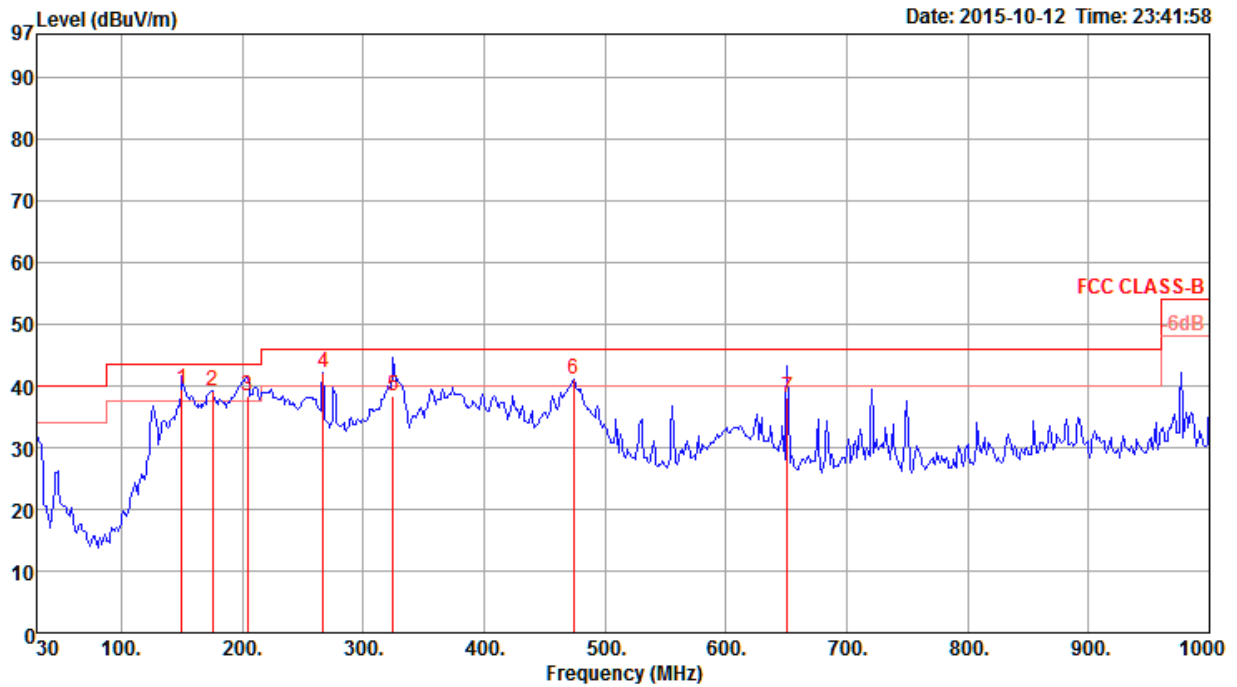

	Freq	Level	Limit	Over	Read	CableAntenna	Preamp	T/Pos	A/Pos	Remark	Pol/Phase
	MHz	dBuV/m	dBuV/m	dB	dBuV	dB	dB/m	deg	cm		
1	150.28	39.34	43.50	-4.16	56.16	1.03	11.20	29.05	123	100 QP	HORIZONTAL
2	175.50	39.26	43.50	-4.24	57.09	1.08	10.03	28.94	360	100 Peak	HORIZONTAL
3	204.60	38.35	43.50	-5.15	55.43	1.18	10.55	28.81	69	100 QP	HORIZONTAL
4	266.68	42.03	46.00	-3.97	55.69	1.35	13.49	28.50	360	100 Peak	HORIZONTAL
5	324.88	38.47	46.00	-7.53	50.92	1.46	14.60	28.51	331	100 QP	HORIZONTAL
6	474.26	41.05	46.00	-4.95	51.09	1.78	17.48	29.30	360	100 Peak	HORIZONTAL
7	650.80	38.23	46.00	-7.77	45.22	2.06	19.99	29.04	256	100 QP	HORIZONTAL

Vertical

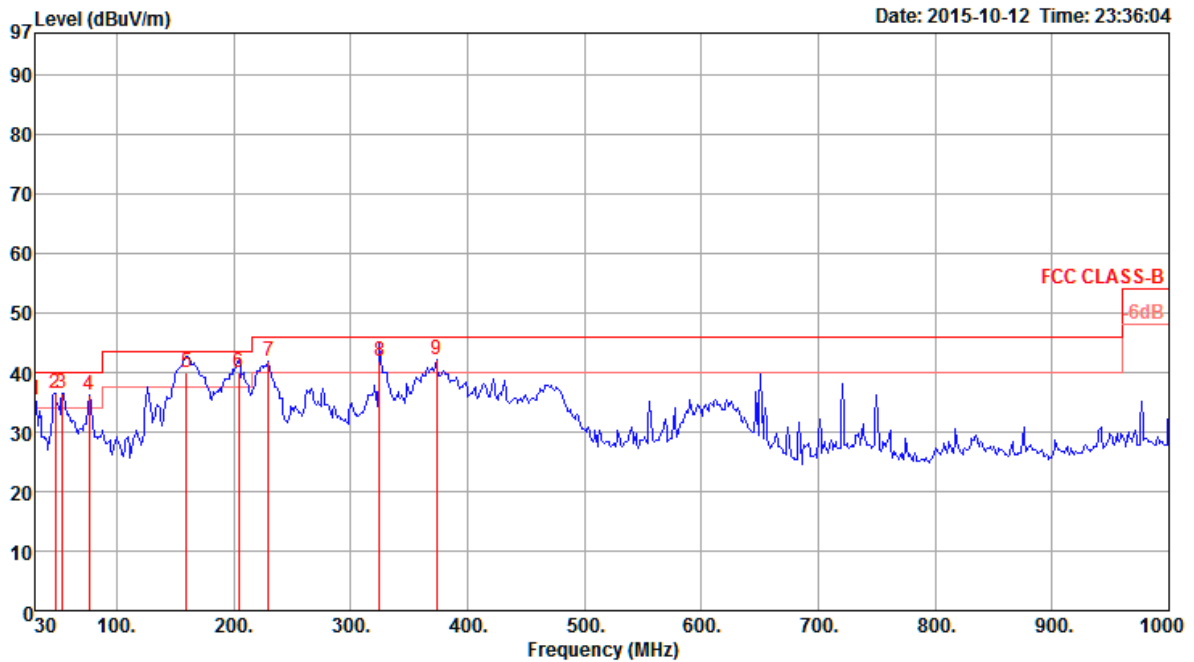

	Freq	Level	Limit	Over	Read	Cable	Antenna	Preamp	T/Pos	A/Pos	Remark	Pol/Phase
	MHz	dBUV/m	dBUV/m	dB	dBuV	dB	dB/m	dB	deg	cm		
1	30.00	35.30	40.00	-4.70	44.40	0.61	19.80	29.51	0	150	Peak	VERTICAL
2	47.46	36.59	40.00	-3.41	55.59	0.62	9.85	29.47	0	150	Peak	VERTICAL
3	53.28	36.53	40.00	-3.47	57.06	0.66	8.26	29.45	0	150	Peak	VERTICAL
4	76.56	36.21	40.00	-3.79	57.63	0.76	7.18	29.36	0	150	Peak	VERTICAL
5	159.98	40.02	43.50	-3.48	57.26	1.07	10.70	29.01	225	100	QP	VERTICAL
6	204.60	40.09	43.50	-3.41	57.17	1.18	10.55	28.81	226	100	QP	VERTICAL
7	229.82	41.89	46.00	-4.11	58.01	1.26	11.30	28.68	0	150	Peak	VERTICAL
8	324.88	41.79	46.00	-4.21	54.24	1.46	14.60	28.51	185	100	QP	VERTICAL
9	373.38	42.14	46.00	-3.86	53.51	1.58	15.91	28.86	0	150	Peak	VERTICAL

Note:

The amplitude of spurious emissions which are attenuated by more than 20 dB below the permissible value has no need to be reported.

Emission level (dBUV/m) = 20 log Emission level (uV/m).

Corrected Reading: Antenna Factor + Cable Loss + Read Level - Preamp Factor = Level.

4.6.9. Results for Radiated Emissions (1GHz~40GHz)

Temperature	25°C	Humidity	53%
Test Engineer	Alvin Li	Configurations	IEEE 802.11a CH 36 / Ant. 1 + Ant. 2 + Ant. 3
Test Date	Sep. 10, 2015		

Horizontal

	Freq	Level	Limit Line	Over Limit	Read Level	Cable Loss	Antenna Factor	Preamp Factor	A/Pos	T/Pos	Remark	Pol/Phase
	MHz	dBuV/m	dBuV/m	dB	dBuV	dB	dB/m	dB	cm	deg		
1	15542.47	67.45	74.00	-6.55	50.43	12.58	38.14	33.70	155	132	Peak	HORIZONTAL
2	15542.66	51.93	54.00	-2.07	34.91	12.58	38.14	33.70	155	132	Average	HORIZONTAL

Vertical

	Freq	Level	Limit Line	Over Limit	Read Level	Cable Loss	Antenna Factor	Preamp Factor	A/Pos	T/Pos	Remark	Pol/Phase
	MHz	dBuV/m	dBuV/m	dB	dBuV	dB	dB/m	dB	cm	deg		
1	15542.66	62.12	74.00	-11.88	45.10	12.58	38.14	33.70	157	184	Peak	VERTICAL
2	15542.95	47.61	54.00	-6.39	30.59	12.58	38.14	33.70	157	184	Average	VERTICAL



Temperature	25°C	Humidity	53%
Test Engineer	Alvin Li	Configurations	IEEE 802.11a CH 40 / Ant. 1 + Ant. 2 + Ant. 3
Test Date	Sep. 10, 2015		

Horizontal

	Freq	Level	Limit Line	Over Limit	Read Level	Cable Loss	Antenna Factor	Preamp Factor	A/Pos	T/Pos	Remark	Pol/Phase
	MHz	dBuV/m	dBuV/m	dB	dBuV	dB	dB/m	dB	cm	deg		
1	15593.17	68.30	74.00	-5.70	51.41	12.58	38.06	33.75	199	127	Peak	HORIZONTAL
2	15593.78	53.86	54.00	-0.14	36.97	12.58	38.06	33.75	199	127	Average	HORIZONTAL

Vertical

	Freq	Level	Limit Line	Over Limit	Read Level	Cable Loss	Antenna Factor	Preamp Factor	A/Pos	T/Pos	Remark	Pol/Phase
	MHz	dBuV/m	dBuV/m	dB	dBuV	dB	dB/m	dB	cm	deg		
1	15592.02	63.13	74.00	-10.87	46.24	12.58	38.06	33.75	200	191	Peak	VERTICAL
2	15593.46	48.88	54.00	-5.12	31.99	12.58	38.06	33.75	200	191	Average	VERTICAL



Temperature	25°C	Humidity	53%
Test Engineer	Alvin Li	Configurations	IEEE 802.11a CH 48 / Ant. 1 + Ant. 2 + Ant. 3
Test Date	Sep. 10, 2015		

Horizontal

	Freq	Level	Limit Line	Over Limit	Read Level	Cable Loss	Antenna Factor	Preamp Factor	A/Pos	T/Pos	Remark	Pol/Phase
	MHz	dBuV/m	dBuV/m	dB	dBuV	dB	dB/m	dB	cm	deg		
1	15722.08	69.39	74.00	-4.61	52.86	12.57	37.84	33.88	199	145	Peak	HORIZONTAL
2	15723.43	53.87	54.00	-0.13	37.34	12.57	37.84	33.88	199	145	Average	HORIZONTAL

Vertical

	Freq	Level	Limit Line	Over Limit	Read Level	Cable Loss	Antenna Factor	Preamp Factor	A/Pos	T/Pos	Remark	Pol/Phase
	MHz	dBuV/m	dBuV/m	dB	dBuV	dB	dB/m	dB	cm	deg		
1	15720.93	50.69	54.00	-3.31	34.16	12.57	37.84	33.88	199	238	Average	VERTICAL
2	15723.53	58.61	74.00	-15.39	42.08	12.57	37.84	33.88	199	238	Peak	VERTICAL

Temperature	25°C	Humidity	53%
Test Engineer	Alvin Li	Configurations	IEEE 802.11a CH 149 / Ant. 1 + Ant. 2 + Ant. 3
Test Date	Sep. 09, 2015		

Horizontal

	Freq	Level	Limit Line	Over Limit	Read Level	CableAntenna Loss	Antenna Factor	Preamp Factor	A/Pos	T/Pos	Pol/Phase	Remark
	MHz	dBuV/m	dBuV/m	dB	dBuV	dB	dB/m	dB	cm	deg		
1	11489.71	66.88	74.00	-7.12	53.28	8.73	39.20	34.33	159	201	HORIZONTAL	Peak
2	11489.93	52.62	54.00	-1.38	39.02	8.73	39.20	34.33	159	201	HORIZONTAL	Average

Vertical

	Freq	Level	Limit Line	Over Limit	Read Level	CableAntenna Loss	Antenna Factor	Preamp Factor	A/Pos	T/Pos	Pol/Phase	Remark
	MHz	dBuV/m	dBuV/m	dB	dBuV	dB	dB/m	dB	cm	deg		
1	11491.01	51.92	54.00	-2.08	38.32	8.73	39.20	34.33	221	319	VERTICAL	Average
2	11492.03	67.48	74.00	-6.52	53.88	8.73	39.20	34.33	221	319	VERTICAL	Peak



Temperature	25°C	Humidity	53%
Test Engineer	Alvin Li	Configurations	IEEE 802.11a CH 157 / Ant. 1 + Ant. 2 + Ant. 3
Test Date	Sep. 09, 2015		

Horizontal

	Freq	Level	Limit	Over	Read	Cable	Antenna	Preamp	A/Pos	T/Pos	Pol/Phase	Remark
	MHz	dBuV/m	dBuV/m	dB	dBuV	Loss	Factor	Factor	cm	deg		
1	11569.42	53.36	54.00	-0.64	39.78	8.78	39.17	34.37	158	202	HORIZONTAL	Average
2	11570.07	68.63	74.00	-5.37	55.05	8.78	39.17	34.37	158	202	HORIZONTAL	Peak

Vertical

	Freq	Level	Limit	Over	Read	Cable	Antenna	Preamp	A/Pos	T/Pos	Pol/Phase	Remark
	MHz	dBuV/m	dBuV/m	dB	dBuV	Loss	Factor	Factor	cm	deg		
1	11570.29	52.96	54.00	-1.04	39.38	8.78	39.17	34.37	223	316	VERTICAL	Average
2	11570.36	68.65	74.00	-5.35	55.07	8.78	39.17	34.37	223	316	VERTICAL	Peak

Temperature	25°C	Humidity	53%
Test Engineer	Alvin Li	Configurations	IEEE 802.11a CH 165 / Ant. 1 + Ant. 2 + Ant. 3
Test Date	Sep. 09, 2015		

Horizontal

	Freq	Level	Limit Line	Over Limit	Read Level	CableAntenna Loss	Antenna Factor	Preamp Factor	A/Pos	T/Pos	Pol/Phase	Remark
	MHz	dBuV/m	dBuV/m	dB	dBuV	dB	dB/m	dB	cm	deg		
1	11648.92	66.97	74.00	-7.03	53.41	8.82	39.15	34.41	164	203	HORIZONTAL	Peak
2	11649.35	52.56	54.00	-1.44	39.00	8.82	39.15	34.41	164	203	HORIZONTAL	Average

Vertical

	Freq	Level	Limit Line	Over Limit	Read Level	CableAntenna Loss	Antenna Factor	Preamp Factor	A/Pos	T/Pos	Pol/Phase	Remark
	MHz	dBuV/m	dBuV/m	dB	dBuV	dB	dB/m	dB	cm	deg		
1	11649.64	52.93	54.00	-1.07	39.37	8.82	39.15	34.41	224	313	VERTICAL	Average
2	11650.22	69.41	74.00	-4.59	55.85	8.82	39.15	34.41	224	313	VERTICAL	Peak



Temperature	25°C	Humidity	53%
Test Engineer	Alvin Li	Configurations	IEEE 802.11ac MCS0/Nss1 VHT20 CH 36 / Ant. 1 + Ant. 2 + Ant. 3
Test Date	Sep. 10, 2015		

Horizontal

	Freq	Level	Limit Line	Over Limit	Read Level	Cable Loss	Antenna Factor	Preamp Factor	A/Pos	T/Pos	Remark	Pol/Phase
	MHz	dBuV/m	dBuV/m	dB	dBuV	dB	dB/m	dB	cm	deg		
1	15533.30	65.32	74.00	-8.68	48.30	12.58	38.14	33.70	199	123	Peak	HORIZONTAL
2	15535.51	52.20	54.00	-1.80	35.18	12.58	38.14	33.70	199	123	Average	HORIZONTAL

Vertical

	Freq	Level	Limit Line	Over Limit	Read Level	Cable Loss	Antenna Factor	Preamp Factor	A/Pos	T/Pos	Remark	Pol/Phase
	MHz	dBuV/m	dBuV/m	dB	dBuV	dB	dB/m	dB	cm	deg		
1	15543.11	47.93	54.00	-6.07	30.91	12.58	38.14	33.70	155	295	Average	VERTICAL
2	15543.43	58.84	74.00	-15.16	41.82	12.58	38.14	33.70	155	295	Peak	VERTICAL



Temperature	25°C	Humidity	53%
Test Engineer	Alvin Li	Configurations	IEEE 802.11ac MCS0/Nss1 VHT20 CH 40 / Ant. 1 + Ant. 2 + Ant. 3
Test Date	Sep. 10, 2015		

Horizontal

	Freq	Level	Limit Line	Over Limit	Read Level	Cable Loss	Antenna Factor	Preamp Factor	A/Pos	T/Pos	Remark	Pol/Phase
	MHz	dBuV/m	dBuV/m	dB	dBuV	dB	dB/m	dB	cm	deg		
1	15593.53	68.76	74.00	-5.24	51.87	12.58	38.06	33.75	192	136	Peak	HORIZONTAL
2	15594.65	53.84	54.00	-0.16	36.98	12.58	38.03	33.75	192	136	Average	HORIZONTAL

Vertical

	Freq	Level	Limit Line	Over Limit	Read Level	Cable Loss	Antenna Factor	Preamp Factor	A/Pos	T/Pos	Remark	Pol/Phase
	MHz	dBuV/m	dBuV/m	dB	dBuV	dB	dB/m	dB	cm	deg		
1	15598.24	47.91	54.00	-6.09	31.05	12.58	38.03	33.75	197	216	Average	VERTICAL
2	15598.59	61.05	74.00	-12.95	44.19	12.58	38.03	33.75	197	216	Peak	VERTICAL



Temperature	25°C	Humidity	53%
Test Engineer	Alvin Li	Configurations	IEEE 802.11ac MCS0/Nss1 VHT20 CH 48 / Ant. 1 + Ant. 2 + Ant. 3
Test Date	Sep. 10, 2015		

Horizontal

	Freq	Level	Limit Line	Over Limit	Read Level	CableAntenna Loss	Antenna Factor	Preamp Factor	A/Pos	T/Pos	Remark	Pol/Phase
	MHz	dBuV/m	dBuV/m	dB	dBuV	dB	dB/m	dB	cm	deg		
1	15711.86	53.87	54.00	-0.13	37.31	12.57	37.87	33.88	201	124	Average	HORIZONTAL
2	15712.47	68.55	74.00	-5.45	51.99	12.57	37.87	33.88	201	124	Peak	HORIZONTAL

Vertical

	Freq	Level	Limit Line	Over Limit	Read Level	CableAntenna Loss	Antenna Factor	Preamp Factor	A/Pos	T/Pos	Remark	Pol/Phase
	MHz	dBuV/m	dBuV/m	dB	dBuV	dB	dB/m	dB	cm	deg		
1	15724.62	53.19	54.00	-0.81	36.66	12.57	37.84	33.88	180	187	Average	VERTICAL
2	15725.51	67.45	74.00	-6.55	50.92	12.57	37.84	33.88	180	187	Peak	VERTICAL



Temperature	25°C	Humidity	53%
Test Engineer	Alvin Li	Configurations	IEEE 802.11ac MCS0/Nss1 VHT20 CH 149 / Ant. 1 + Ant. 2 + Ant. 3
Test Date	Sep. 09, 2015		

Horizontal

	Freq	Level	Limit Line	Over Limit	Read Level	Cable Loss	Antenna Factor	Preamp Factor	A/Pos	T/Pos	Remark	Pol/Phase
	MHz	dBuV/m	dBuV/m	dB	dBuV	dB	dB/m	dB	cm	deg		
1	11492.63	53.96	54.00	-0.04	37.74	10.71	38.88	33.37	218	153	Average	HORIZONTAL
2	11494.13	68.81	74.00	-5.19	52.58	10.72	38.88	33.37	218	153	Peak	HORIZONTAL

Vertical

	Freq	Level	Limit Line	Over Limit	Read Level	Cable Loss	Antenna Factor	Preamp Factor	A/Pos	T/Pos	Remark	Pol/Phase
	MHz	dBuV/m	dBuV/m	dB	dBuV	dB	dB/m	dB	cm	deg		
1	11481.12	63.40	74.00	-10.60	47.18	10.71	38.88	33.37	219	178	Peak	VERTICAL
2	11481.51	50.42	54.00	-3.58	34.20	10.71	38.88	33.37	219	178	Average	VERTICAL

Temperature	25°C	Humidity	53%
Test Engineer	Alvin Li	Configurations	IEEE 802.11ac MCS0/Nss1 VHT20 CH 157 / Ant. 1 + Ant. 2 + Ant. 3
Test Date	Sep. 09, 2015		

Horizontal

	Freq	Level	Limit Line	Over Limit	Read Level	Cable Loss	Antenna Factor	Preamp Factor	A/Pos	T/Pos	Remark	Pol/Phase
	MHz	dBuV/m	dBuV/m	dB	dBuV	dB	dB/m	dB	cm	deg		
1	11570.93	68.51	74.00	-5.49	52.20	10.76	38.94	33.39	215	153	Peak	HORIZONTAL
2	11571.15	53.41	54.00	-0.59	37.10	10.76	38.94	33.39	215	153	Average	HORIZONTAL

Vertical

	Freq	Level	Limit Line	Over Limit	Read Level	Cable Loss	Antenna Factor	Preamp Factor	A/Pos	T/Pos	Remark	Pol/Phase
	MHz	dBuV/m	dBuV/m	dB	dBuV	dB	dB/m	dB	cm	deg		
1	11575.80	63.50	74.00	-10.50	47.19	10.76	38.94	33.39	209	210	Peak	VERTICAL
2	11575.90	50.09	54.00	-3.91	33.78	10.76	38.94	33.39	209	210	Average	VERTICAL



Temperature	25°C	Humidity	53%
Test Engineer	Alvin Li	Configurations	IEEE 802.11ac MCS0/Nss1 VHT20 CH 165 / Ant. 1 + Ant. 2 + Ant. 3
Test Date	Sep. 09, 2015		

Horizontal

	Freq	Level	Limit Line	Over Limit	Read Level	Cable Loss	Antenna Factor	Preamp Factor	A/Pos	T/Pos	Remark	Pol/Phase
	MHz	dBuV/m	dBuV/m	dB	dBuV	dB	dB/m	dB	cm	deg		
1	11647.76	68.80	74.00	-5.20	52.42	10.81	38.98	33.41	219	152	Peak	HORIZONTAL
2	11650.67	53.93	54.00	-0.07	37.54	10.81	38.99	33.41	219	152	Average	HORIZONTAL

Vertical

	Freq	Level	Limit Line	Over Limit	Read Level	Cable Loss	Antenna Factor	Preamp Factor	A/Pos	T/Pos	Remark	Pol/Phase
	MHz	dBuV/m	dBuV/m	dB	dBuV	dB	dB/m	dB	cm	deg		
1	11656.70	64.35	74.00	-9.65	47.96	10.81	38.99	33.41	223	180	Peak	VERTICAL
2	11657.18	50.97	54.00	-3.03	34.58	10.81	38.99	33.41	223	180	Average	VERTICAL



Temperature	25°C	Humidity	53%
Test Engineer	Alvin Li	Configurations	IEEE 802.11ac MCS0/Nss1 VHT40 CH 38 / Ant. 1 + Ant. 2 + Ant. 3
Test Date	Sep. 09, 2015		

Horizontal

	Freq	Level	Limit Line	Over Limit	Read Level	Cable Loss	Antenna Factor	Preamp Factor	A/Pos	T/Pos	Remark	Pol/Phase
	MHz	dBuV/m	dBuV/m	dB	dBuV	dB	dB/m	dB	cm	deg		
1	15563.72	45.30	54.00	-8.70	28.36	12.58	38.09	33.73	188	266	Average	HORIZONTAL
2	15572.88	58.27	74.00	-15.73	41.33	12.58	38.09	33.73	188	266	Peak	HORIZONTAL

Vertical

	Freq	Level	Limit Line	Over Limit	Read Level	Cable Loss	Antenna Factor	Preamp Factor	A/Pos	T/Pos	Remark	Pol/Phase
	MHz	dBuV/m	dBuV/m	dB	dBuV	dB	dB/m	dB	cm	deg		
1	15567.63	45.24	54.00	-8.76	28.30	12.58	38.09	33.73	185	296	Average	VERTICAL
2	15574.71	58.22	74.00	-15.78	41.30	12.58	38.09	33.75	185	296	Peak	VERTICAL



Temperature	25°C	Humidity	53%
Test Engineer	Alvin Li	Configurations	IEEE 802.11ac MCS0/Nss1 VHT40 CH 46 / Ant. 1 + Ant. 2 + Ant. 3
Test Date	Sep. 09, 2015		

Horizontal

	Freq	Level	Limit Line	Over Limit	Read Level	Cable Loss	Antenna Factor	Preamp Factor	A/Pos	T/Pos	Remark	Pol/Phase
	MHz	dBuV/m	dBuV/m	dB	dBuV	dB	dB/m	dB	cm	deg		
1	15697.76	58.45	74.00	-15.55	41.85	12.58	37.87	33.85	192	207	Peak	HORIZONTAL
2	15698.53	45.60	54.00	-8.40	29.00	12.58	37.87	33.85	192	207	Average	HORIZONTAL

Vertical

	Freq	Level	Limit Line	Over Limit	Read Level	Cable Loss	Antenna Factor	Preamp Factor	A/Pos	T/Pos	Remark	Pol/Phase
	MHz	dBuV/m	dBuV/m	dB	dBuV	dB	dB/m	dB	cm	deg		
1	15694.81	58.11	74.00	-15.89	41.48	12.58	37.90	33.85	169	235	Peak	VERTICAL
2	15699.10	45.45	54.00	-8.55	28.85	12.58	37.87	33.85	169	235	Average	VERTICAL



Temperature	25°C	Humidity	53%
Test Engineer	Alvin Li	Configurations	IEEE 802.11ac MCS0/Nss1 VHT40 CH 151 / Ant. 1 + Ant. 2 + Ant. 3
Test Date	Sep. 09, 2015		

Horizontal

	Freq	Level	Limit Line	Over Limit	Read Level	Cable Loss	Antenna Factor	Preamp Factor	A/Pos	T/Pos	Remark	Pol/Phase
	MHz	dBuV/m	dBuV/m	dB	dBuV	dB	dB/m	dB	cm	deg		
1	11510.58	64.09	74.00	-9.91	47.84	10.72	38.90	33.37	222	154	Peak	HORIZONTAL
2	11511.70	52.72	54.00	-1.28	36.47	10.72	38.90	33.37	222	154	Average	HORIZONTAL

Vertical

	Freq	Level	Limit Line	Over Limit	Read Level	Cable Loss	Antenna Factor	Preamp Factor	A/Pos	T/Pos	Remark	Pol/Phase
	MHz	dBuV/m	dBuV/m	dB	dBuV	dB	dB/m	dB	cm	deg		
1	11500.00	51.63	54.00	-2.37	35.38	10.72	38.90	33.37	230	177	Average	VERTICAL
2	11500.13	64.08	74.00	-9.92	47.83	10.72	38.90	33.37	230	177	Peak	VERTICAL



Temperature	25°C	Humidity	53%
Test Engineer	Alvin Li	Configurations	IEEE 802.11ac MCS0/Nss1 VHT40 CH 159 / Ant. 1 + Ant. 2 + Ant. 3
Test Date	Sep. 09, 2015		

Horizontal

	Freq	Level	Limit Line	Over Limit	Read Level	Cable Loss	Antenna Factor	Preamp Factor	A/Pos	T/Pos	Remark	Pol/Phase
	MHz	dBuV/m	dBuV/m	dB	dBuV	dB	dB/m	dB	cm	deg		
1	11590.83	68.57	74.00	-5.43	52.25	10.76	38.95	33.39	221	155	Peak	HORIZONTAL
2	11591.25	53.60	54.00	-0.40	37.28	10.76	38.95	33.39	221	155	Average	HORIZONTAL

Vertical

	Freq	Level	Limit Line	Over Limit	Read Level	Cable Loss	Antenna Factor	Preamp Factor	A/Pos	T/Pos	Remark	Pol/Phase
	MHz	dBuV/m	dBuV/m	dB	dBuV	dB	dB/m	dB	cm	deg		
1	11596.83	53.10	54.00	-0.90	36.77	10.78	38.95	33.40	246	209	Average	VERTICAL
2	11597.44	67.98	74.00	-6.02	51.65	10.78	38.95	33.40	246	209	Peak	VERTICAL



Temperature	25°C	Humidity	53%
Test Engineer	Alvin Li	Configurations	IEEE 802.11ac MCS0/Nss1 VHT80 CH 42 / Ant. 1 + Ant. 2 + Ant. 3
Test Date	Sep. 09, 2015		

Horizontal

	Freq	Level	Limit Line	Over Limit	Read Level	Cable Loss	Antenna Factor	Preamp Factor	A/Pos	T/Pos	Remark	Pol/Phase
	MHz	dBuV/m	dBuV/m	dB	dBuV	dB	dB/m	dB	cm	deg		
1	15631.60	45.38	54.00	-8.62	28.62	12.58	37.98	33.80	165	235	Average	HORIZONTAL
2	15639.94	58.79	74.00	-15.21	42.03	12.58	37.98	33.80	165	235	Peak	HORIZONTAL

Vertical

	Freq	Level	Limit Line	Over Limit	Read Level	Cable Loss	Antenna Factor	Preamp Factor	A/Pos	T/Pos	Remark	Pol/Phase
	MHz	dBuV/m	dBuV/m	dB	dBuV	dB	dB/m	dB	cm	deg		
1	15632.44	45.28	54.00	-8.72	28.52	12.58	37.98	33.80	162	266	Average	VERTICAL
2	15632.79	58.14	74.00	-15.86	41.38	12.58	37.98	33.80	162	266	Peak	VERTICAL

Temperature	25°C	Humidity	53%
Test Engineer	Alvin Li	Configurations	IEEE 802.11ac MCS0/Nss1 VHT80 CH 155 / Ant. 1 + Ant. 2 + Ant. 3
Test Date	Sep. 09, 2015~Sep. 10, 2015		

Horizontal

	Freq	Level	Limit Line	Over Limit	Read Level	Cable Loss	Antenna Factor	Preamp Factor	A/Pos	T/Pos	Remark	Pol/Phase
	MHz	dBuV/m	dBuV/m	dB	dBuV	dB	dB/m	dB	cm	deg		
1	11540.54	63.44	74.00	-10.56	47.17	10.73	38.92	33.38	222	189	Peak	HORIZONTAL
2	11540.71	50.09	54.00	-3.91	33.82	10.73	38.92	33.38	222	189	Average	HORIZONTAL

Vertical

	Freq	Level	Limit Line	Over Limit	Read Level	Cable Loss	Antenna Factor	Preamp Factor	A/Pos	T/Pos	Remark	Pol/Phase
	MHz	dBuV/m	dBuV/m	dB	dBuV	dB	dB/m	dB	cm	deg		
1	11557.88	51.16	54.00	-2.84	34.86	10.75	38.93	33.38	236	176	Average	VERTICAL
2	11559.10	65.83	74.00	-8.17	49.53	10.75	38.93	33.38	236	176	Peak	VERTICAL

Note:

The amplitude of spurious emissions that are attenuated by more than 20dB below the permissible value has no need to be reported.

Emission level (dBuV/m) = 20 log Emission level (uV/m).

Corrected Reading: Antenna Factor + Cable Loss + Read Level - Preamp Factor = Level.

4.7. Band Edge Emissions Measurement

4.7.1. Limit

For transmitters operating in the 5.15-5.25 GHz band: all emissions outside of the 5.15-5.35 GHz band shall not exceed an e.i.r.p. of -27 dBm/MHz.

For transmitters operating in the 5.725-5.85 GHz band: all emissions within the frequency range from the band edge to 10 MHz above or below the band edge shall not exceed an e.i.r.p. of -17 dBm/MHz; for frequencies 10 MHz or greater above or below the band edge, emissions shall not exceed an e.i.r.p. of -27 dBm/MHz.

In addition, In case the emission fall within the restricted band specified on 15.205(a), then the 15.209(a) limit in the table below has to be followed.

Frequencies (MHz)	Field Strength (microvolts/meter)	Measurement Distance (meters)
0.009~0.490	2400/F(kHz)	300
0.490~1.705	24000/F(kHz)	30
1.705~30.0	30	30
30~88	100	3
88~216	150	3
216~960	200	3
Above 960	500	3

4.7.2. Measuring Instruments and Setting

Please refer to section 5 of equipments list in this report. The following table is the setting of the spectrum analyzer.

Spectrum Parameter	Setting
Attenuation	Auto
Span Frequency	100 MHz
RBW / VBW (Emission in restricted band)	1 MHz / 3MHz for Peak, 1 MHz / 1/T for Average
RBW / VBW (Emission in non-restricted band)	1 MHz / 3MHz for Peak

4.7.3. Test Procedures

1. The test procedure is the same as section 4.6.3.

4.7.4. Test Setup Layout

This test setup layout is the same as that shown in section 4.6.4.

4.7.5. Test Deviation

There is no deviation with the original standard.

4.7.6. EUT Operation during Test

The EUT was programmed to be in continuously transmitting mode.

4.7.7. Test Result of Band Edge and Fundamental Emissions

Temperature	25°C	Humidity	53%
Test Engineer	Alvin Li	Configurations	IEEE 802.11a CH 36, 40, 48 / Ant. 1 + Ant. 2 + Ant. 3
Test Date	Sep. 09, 2015~Sep. 10, 2015		

Channel 36

	Freq	Level	Limit Line	Over Limit	Read Level	Cable Loss	Antenna Factor	Preamp Factor	A/Pos	T/Pos	Remark	Pol/Phase
	MHz	dBuV/m	dBuV/m	dB	dBuV	dB	dB/m	dB	cm	deg		
1	5149.23	67.97	74.00	-6.03	61.07	6.21	33.74	33.05	252	266	Peak	VERTICAL
2	5150.00	53.65	54.00	-0.35	46.75	6.21	33.74	33.05	252	266	Average	VERTICAL
3	5179.36	103.97			96.99	6.24	33.79	33.05	252	266	Average	VERTICAL
4	5180.96	113.56			106.58	6.24	33.79	33.05	252	266	Peak	VERTICAL

Item 3, 4 are the fundamental frequency at 5180 MHz.

Channel 40

	Freq	Level	Limit Line	Over Limit	Read Level	Cable Loss	Antenna Factor	Preamp Factor	A/Pos	T/Pos	Remark	Pol/Phase
	MHz	dBuV/m	dBuV/m	dB	dBuV	dB	dB/m	dB	cm	deg		
1	5147.76	47.87	54.00	-6.13	40.97	6.21	33.74	33.05	237	273	Average	VERTICAL
2	5148.08	61.47	74.00	-12.53	54.57	6.21	33.74	33.05	237	273	Peak	VERTICAL
3	5196.80	105.44			98.40	6.27	33.82	33.05	237	273	Average	VERTICAL
4	5196.80	115.32			108.28	6.27	33.82	33.05	237	273	Peak	VERTICAL

Item 3, 4 are the fundamental frequency at 5200 MHz.

Channel 48

	Freq	Level	Limit Line	Over Limit	Read Level	Cable Loss	Antenna Factor	Preamp Factor	A/Pos	T/Pos	Remark	Pol/Phase
	MHz	dBuV/m	dBuV/m	dB	dBuV	dB	dB/m	dB	cm	deg		
1	5138.94	57.85	74.00	-16.15	51.02	6.17	33.71	33.05	258	268	Peak	VERTICAL
2	5150.00	46.16	54.00	-7.84	39.26	6.21	33.74	33.05	258	268	Average	VERTICAL
3	5235.67	105.29			98.17	6.30	33.87	33.05	258	268	Average	VERTICAL
4	5245.29	115.28			108.13	6.30	33.90	33.05	258	268	Peak	VERTICAL
5	5350.96	58.75	74.00	-15.25	51.28	6.47	34.06	33.06	258	268	Peak	VERTICAL
6	5360.67	46.79	54.00	-7.21	39.29	6.47	34.09	33.06	258	268	Average	VERTICAL

Item 3, 4 are the fundamental frequency at 5240 MHz.

Temperature	25°C	Humidity	53%
Test Engineer	Alvin Li	Configurations	IEEE 802.11a CH 149, 157, 165 / Ant. 1 + Ant. 2 + Ant. 3
Test Date	Sep. 09, 2015~Sep. 10, 2015		

Channel 149

	Freq	Level	Limit Line	Over Limit	Read Level	CableAntenna Loss	Antenna Factor	Preamp Factor	A/Pos	T/Pos	Remark	Pol/Phase
	MHz	dBuV/m	dBuV/m	dB	dBuV	dB	dB/m	dB	cm	deg		
1	5712.76	61.22	68.20	-6.98	53.10	6.83	34.42	33.13	252	267	Peak	VERTICAL
2	5724.49	71.93	78.20	-6.27	63.80	6.83	34.43	33.13	252	267	Peak	VERTICAL
3	5742.12	100.48			92.32	6.86	34.44	33.14	252	267	Average	VERTICAL
4	5742.44	110.67			102.51	6.86	34.44	33.14	252	267	Peak	VERTICAL

Item 3, 4 are the fundamental frequency at 5745 MHz.

Channel 157

	Freq	Level	Limit Line	Over Limit	Read Level	CableAntenna Loss	Antenna Factor	Preamp Factor	A/Pos	T/Pos	Remark	Pol/Phase
	MHz	dBuV/m	dBuV/m	dB	dBuV	dB	dB/m	dB	cm	deg		
1	5702.95	60.95	68.20	-7.25	52.84	6.81	34.42	33.12	242	268	Peak	VERTICAL
2	5725.00	59.66	78.20	-18.54	51.53	6.83	34.43	33.13	242	268	Peak	VERTICAL
3	5782.12	108.93			100.72	6.90	34.47	33.16	242	268	Peak	VERTICAL
4	5782.44	99.52			91.31	6.90	34.47	33.16	242	268	Average	VERTICAL
5	5851.92	60.94	78.20	-17.26	52.65	6.95	34.51	33.17	242	268	Peak	VERTICAL
6	5869.62	60.16	68.20	-8.04	51.85	6.97	34.52	33.18	242	268	Peak	VERTICAL

Item 3, 4 are the fundamental frequency at 5785 MHz.

Channel 165

	Freq	Level	Limit Line	Over Limit	Read Level	CableAntenna Loss	Antenna Factor	Preamp Factor	A/Pos	T/Pos	Remark	Pol/Phase
	MHz	dBuV/m	dBuV/m	dB	dBuV	dB	dB/m	dB	cm	deg		
1	5832.05	92.63			84.37	6.92	34.50	33.16	203	255	Average	HORIZONTAL
2	5832.05	102.58			94.32	6.92	34.50	33.16	203	255	Peak	HORIZONTAL
3	5851.60	60.71	78.20	-17.49	52.42	6.95	34.51	33.17	203	255	Peak	HORIZONTAL
4	5860.00	60.39	68.20	-7.81	52.08	6.97	34.52	33.18	203	255	Peak	HORIZONTAL

Item 1, 2 are the fundamental frequency at 5825 MHz.

Temperature	25°C	Humidity	53%
Test Engineer	Alvin Li	Configurations	IEEE 802.11ac MCS0/Nss1 VHT20 CH 36, 40, 48 / Ant. 1 + Ant. 2 + Ant. 3
Test Date	Sep. 09, 2015~Sep. 10, 2015		

Channel 36

	Freq	Level	Limit	Over	Read	CableAntenna	Preamp	A/Pos	T/Pos	Remark	Pol/Phase	
	MHz	dBuV/m	dBuV/m	dB	dBuV	dB	dB/m	dB	cm	deg		
1	5150.00	53.57	54.00	-0.43	46.67	6.21	33.74	33.05	244	274	Average	VERTICAL
2	5150.00	68.80	74.00	-5.20	61.90	6.21	33.74	33.05	244	274	Peak	VERTICAL
3	5172.95	103.66			96.70	6.24	33.77	33.05	244	274	Average	VERTICAL
4	5174.55	113.15			106.17	6.24	33.79	33.05	244	274	Peak	VERTICAL

Item 3, 4 are the fundamental frequency at 5180 MHz.

Channel 40

	Freq	Level	Limit	Over	Read	CableAntenna	Preamp	A/Pos	T/Pos	Remark	Pol/Phase	
	MHz	dBuV/m	dBuV/m	dB	dBuV	dB	dB/m	dB	cm	deg		
1	5150.00	53.36	54.00	-0.64	46.46	6.21	33.74	33.05	277	250	Average	VERTICAL
2	5150.00	68.17	74.00	-5.83	61.27	6.21	33.74	33.05	277	250	Peak	VERTICAL
3	5192.63	105.27			98.26	6.24	33.82	33.05	277	250	Average	VERTICAL
4	5195.51	115.56			108.52	6.27	33.82	33.05	277	250	Peak	VERTICAL

Item 3, 4 are the fundamental frequency at 5200 MHz.

Channel 48

	Freq	Level	Limit	Over	Read	CableAntenna	Preamp	A/Pos	T/Pos	Remark	Pol/Phase	
	MHz	dBuV/m	dBuV/m	dB	dBuV	dB	dB/m	dB	cm	deg		
1	5145.77	46.69	54.00	-7.31	39.79	6.21	33.74	33.05	248	265	Average	VERTICAL
2	5145.77	58.63	74.00	-15.37	51.73	6.21	33.74	33.05	248	265	Peak	VERTICAL
3	5232.31	106.93			99.81	6.30	33.87	33.05	248	265	Average	VERTICAL
4	5235.67	116.89			109.77	6.30	33.87	33.05	248	265	Peak	VERTICAL
5	5350.00	46.83	54.00	-7.17	39.36	6.47	34.06	33.06	248	265	Average	VERTICAL
6	5382.79	59.84	74.00	-14.16	52.29	6.50	34.11	33.06	248	265	Peak	VERTICAL

Item 3, 4 are the fundamental frequency at 5240 MHz.

Temperature	25°C	Humidity	53%
Test Engineer	Alvin Li	Configurations	IEEE 802.11ac MCS0/Nss1 VHT20 CH 149, 157, 165 / Ant. 1 + Ant. 2 + Ant. 3
Test Date	Sep. 09, 2015~Sep. 10, 2015		

Channel 149

	Freq	Level	Limit Line	Over Limit	Read Level	CableAntenna Loss	Antenna Factor	Preamp Factor	A/Pos	T/Pos	Remark	Pol/Phase
	MHz	dBuV/m	dBuV/m	dB	dBuV	dB	dB/m	dB	cm	deg		
1	5697.05	60.81	68.20	-7.39	52.71	6.81	34.41	33.12	250	251	Peak	VERTICAL
2	5725.00	72.91	78.20	-5.29	64.78	6.83	34.43	33.13	250	251	Peak	VERTICAL
3	5742.76	110.27			102.11	6.86	34.44	33.14	250	251	Peak	VERTICAL
4	5744.04	100.53			92.37	6.86	34.44	33.14	250	251	Average	VERTICAL

Item 3, 4 are the fundamental frequency at 5745 MHz.

Channel 157

	Freq	Level	Limit Line	Over Limit	Read Level	CableAntenna Loss	Antenna Factor	Preamp Factor	A/Pos	T/Pos	Remark	Pol/Phase
	MHz	dBuV/m	dBuV/m	dB	dBuV	dB	dB/m	dB	cm	deg		
1	5695.90	59.64	68.20	-8.56	51.54	6.81	34.41	33.12	223	253	Peak	VERTICAL
2	5724.04	59.96	78.20	-18.24	51.83	6.83	34.43	33.13	223	253	Peak	VERTICAL
3	5792.69	99.30			91.08	6.90	34.48	33.16	223	253	Average	VERTICAL
4	5792.69	108.92			100.70	6.90	34.48	33.16	223	253	Peak	VERTICAL
5	5850.64	58.89	78.20	-19.31	50.60	6.95	34.51	33.17	223	253	Peak	VERTICAL
6	5866.41	60.64	68.20	-7.56	52.33	6.97	34.52	33.18	223	253	Peak	VERTICAL

Item 3, 4 are the fundamental frequency at 5785 MHz.

Channel 165

	Freq	Level	Limit Line	Over Limit	Read Level	CableAntenna Loss	Antenna Factor	Preamp Factor	A/Pos	T/Pos	Remark	Pol/Phase
	MHz	dBuV/m	dBuV/m	dB	dBuV	dB	dB/m	dB	cm	deg		
1	5822.12	94.01			85.75	6.92	34.50	33.16	202	233	Average	HORIZONTAL
2	5829.49	103.69			95.43	6.92	34.50	33.16	202	233	Peak	HORIZONTAL
3	5852.89	60.64	78.20	-17.56	52.35	6.95	34.51	33.17	202	233	Peak	HORIZONTAL
4	5899.68	60.58	68.20	-7.62	52.24	6.99	34.54	33.19	202	233	Peak	HORIZONTAL

Item 1, 2 are the fundamental frequency at 5825 MHz.

Temperature	25°C	Humidity	53%
Test Engineer	Alvin Li	Configurations	IEEE 802.11ac MCS0/Nss1 VHT40 CH 38, 46 / Ant. 1 + Ant. 2 + Ant. 3
Test Date	Sep. 09, 2015~Sep. 10, 2015		

Channel 38

	Freq	Level	Limit	Over	Read	CableAntenna	Preamp	A/Pos	T/Pos	Remark	Pol/Phase	
	MHz	dBuV/m	dBuV/m	dB	dBuV	dB	dB/m	dB	cm	deg		
1	5148.97	68.37	74.00	-5.63	61.47	6.21	33.74	33.05	248	282	Peak	VERTICAL
2	5149.62	53.49	54.00	-0.51	46.59	6.21	33.74	33.05	248	282	Average	VERTICAL
3	5186.15	105.28			98.30	6.24	33.79	33.05	248	282	Peak	VERTICAL
4	5188.08	94.27			87.29	6.24	33.79	33.05	248	282	Average	VERTICAL

Item 3, 4 are the fundamental frequency at 5190 MHz.

Channel 46

	Freq	Level	Limit	Over	Read	CableAntenna	Preamp	A/Pos	T/Pos	Remark	Pol/Phase	
	MHz	dBuV/m	dBuV/m	dB	dBuV	dB	dB/m	dB	cm	deg		
1	5138.97	65.89	74.00	-8.11	59.06	6.17	33.71	33.05	227	258	Peak	VERTICAL
2	5144.10	53.83	54.00	-0.17	46.93	6.21	33.74	33.05	227	258	Average	VERTICAL
3	5239.62	103.99			96.87	6.30	33.87	33.05	227	258	Average	VERTICAL
4	5239.94	113.93			106.81	6.30	33.87	33.05	227	258	Peak	VERTICAL

Item 3, 4 are the fundamental frequency at 5230 MHz.

Temperature	25°C	Humidity	53%
Test Engineer	Alvin Li	Configurations	IEEE 802.11ac MCS0/Nss1 VHT40 CH 151, 159 / Ant. 1 + Ant. 2 + Ant. 3
Test Date	Sep. 09, 2015~Sep. 10, 2015		

Channel 151

	Freq	Level	Limit	Over	Read	Cable	Antenna	Preamp	A/Pos	T/Pos	Remark	Pol/Phase
	MHz	dBuV/m	dBuV/m	dB	dBuV	dB	dB/m	dB	cm	deg		
1	5715.00	67.75	68.20	-0.45	59.63	6.83	34.42	33.13	249	261	Peak	VERTICAL
2	5724.23	72.41	78.20	-5.79	64.28	6.83	34.43	33.13	249	261	Peak	VERTICAL
3	5744.10	105.69			97.53	6.86	34.44	33.14	249	261	Peak	VERTICAL
4	5753.72	95.62			87.44	6.86	34.46	33.14	249	261	Average	VERTICAL

Item 3, 4 are the fundamental frequency at 5755 MHz.

Channel 159

	Freq	Level	Limit	Over	Read	Cable	Antenna	Preamp	A/Pos	T/Pos	Remark	Pol/Phase
	MHz	dBuV/m	dBuV/m	dB	dBuV	dB	dB/m	dB	cm	deg		
1	5700.13	60.47	74.00	-13.53	52.37	6.81	34.41	33.12	249	289	Peak	VERTICAL
2	5707.18	47.83	54.00	-6.17	39.71	6.83	34.42	33.13	249	289	Average	VERTICAL
3	5722.56	61.22	78.20	-16.98	53.09	6.83	34.43	33.13	249	289	Peak	VERTICAL
4	5784.42	108.18			99.97	6.90	34.47	33.16	249	289	Peak	VERTICAL
5	5784.74	98.11			89.90	6.90	34.47	33.16	249	289	Average	VERTICAL
6	5852.05	60.49	78.20	-17.71	52.20	6.95	34.51	33.17	249	289	Peak	VERTICAL
7	5860.39	60.20	74.00	-13.80	51.89	6.97	34.52	33.18	249	289	Peak	VERTICAL
8	5876.09	47.07	54.00	-6.93	38.75	6.97	34.53	33.18	249	289	Average	VERTICAL

Item 4, 5 are the fundamental frequency at 5795 MHz.

Temperature	25°C	Humidity	53%
Test Engineer	Alvin Li	Configurations	IEEE 802.11ac MCS0/Nss1 VHT80 CH 42, 155 / Ant. 1 + Ant. 2 + Ant. 3
Test Date	Sep. 09, 2015~Sep. 10, 2015		

Channel 42

	Freq	Level	Limit Line	Over Limit	Read Level	CableAntenna Loss	Antenna Factor	Preamp Factor	A/Pos	T/Pos	Remark	Pol/Phase
	MHz	dBuV/m	dBuV/m	dB	dBuV	dB	dB/m	dB	cm	deg		
1	5148.30	65.53	74.00	-8.47	58.63	6.21	33.74	33.05	252	257	Peak	VERTICAL
2	5150.00	53.46	54.00	-0.54	46.56	6.21	33.74	33.05	252	257	Average	VERTICAL
3	5198.78	103.81			96.77	6.27	33.82	33.05	252	257	Peak	VERTICAL
4	5228.43	90.82			83.70	6.30	33.87	33.05	252	257	Average	VERTICAL
5	5387.89	46.81	54.00	-7.19	39.26	6.50	34.11	33.06	252	257	Average	VERTICAL
6	5395.90	59.32	74.00	-14.68	51.74	6.50	34.14	33.06	252	257	Peak	VERTICAL

Item 3, 4 are the fundamental frequency at 5210 MHz.

Channel 155

	Freq	Level	Limit Line	Over Limit	Read Level	CableAntenna Loss	Antenna Factor	Preamp Factor	A/Pos	T/Pos	Remark	Pol/Phase
	MHz	dBuV/m	dBuV/m	dB	dBuV	dB	dB/m	dB	cm	deg		
1	5709.30	68.06	68.20	-0.14	59.94	6.83	34.42	33.13	252	263	Peak	VERTICAL
2	5725.00	71.74	78.20	-6.46	63.61	6.83	34.43	33.13	252	263	Peak	VERTICAL
3	5746.96	92.43			84.27	6.86	34.44	33.14	252	263	Average	VERTICAL
4	5746.96	102.52			94.36	6.86	34.44	33.14	252	263	Peak	VERTICAL
5	5857.53	63.34	78.20	-14.86	55.04	6.95	34.52	33.17	252	263	Peak	VERTICAL
6	5862.34	62.56	68.20	-5.64	54.25	6.97	34.52	33.18	252	263	Peak	VERTICAL

Item 3, 4 are the fundamental frequency at 5775 MHz.

Note:

Emission level (dBuV/m) = 20 log Emission level (uV/m)

Corrected Reading: Antenna Factor + Cable Loss + Read Level - Preamp Factor = Level

4.8. Frequency Stability Measurement

4.8.1. Limit

In-band emission is maintained within the band of operation under all conditions of normal operation as specified in the user's manual.

The transmitter center frequency tolerance shall be ± 20 ppm maximum for the 5 GHz band (IEEE 802.11n specification).

4.8.2. Measuring Instruments and Setting

Please refer to section 5 of equipments list in this report. The following table is the setting of the spectrum analyzer.

Spectrum Parameter	Setting
Attenuation	Auto
Span Frequency	Entire absence of modulation emissions bandwidth
RBW	10 kHz
VBW	10 kHz
Sweep Time	Auto

4.8.3. Test Procedures

1. The transmitter output (antenna port) was connected to the spectrum analyzer.
2. EUT have transmitted absence of modulation signal and fixed channelize.
3. Set the spectrum analyzer span to view the entire absence of modulation emissions bandwidth.
4. Set RBW = 10 kHz, VBW = 10 kHz with peak detector and maxhold settings.
5. f_c is declaring of channel frequency. Then the frequency error formula is $(f_c - f) / f_c \times 10^6$ ppm and the limit is less than ± 20 ppm (IEEE 802.11n specification).
6. Allow sufficient time (approximately 30 min) for the temperature of the chamber to stabilize, turn the EUT on and measure the operating frequency after 2, 5, and 10 minutes.
7. The test extreme voltage is to change the primary supply voltage from 85 to 115 percent of the nominal value
8. Extreme temperature is $-20^\circ\text{C} \sim 50^\circ\text{C}$.

4.8.4. Test Setup Layout

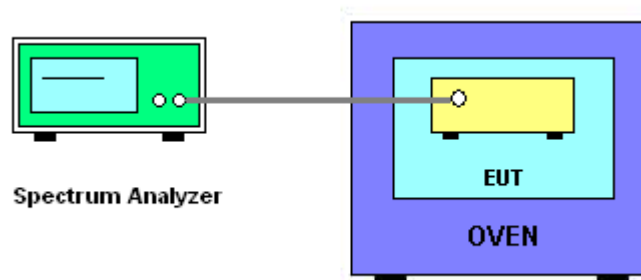

4.8.5. Test Deviation

There is no deviation with the original standard.

4.8.6. EUT Operation during Test

The EUT was programmed to be in continuously un-modulation transmitting mode.

4.8.7. Test Result of Frequency Stability

Temperature	25°C	Humidity	53%
Test Engineer	Nick Peng / Clemens Fang	Test Date	Sep. 10, 2015

Mode: 20 MHz / Ant. 1

Voltage vs. Frequency Stability

Voltage (V)	Measurement Frequency (MHz)			
	5200 MHz			
	0 Minute	2 Minute	5 Minute	10 Minute
126.50	5199.9634	5199.9623	5199.9608	5199.9588
110.00	5199.9622	5199.9609	5199.9593	5199.9574
93.50	5199.9608	5199.9599	5199.9585	5199.9567
Max. Deviation (MHz)	0.0392	0.0401	0.0415	0.0433
Max. Deviation (ppm)	7.54	7.71	7.98	8.33
Result	Complies			

Temperature vs. Frequency Stability

Temperature (°C)	Measurement Frequency (MHz)			
	5200 MHz			
	0 Minute	2 Minute	5 Minute	10 Minute
-20	5199.9676	5199.9663	5199.9646	5199.9625
-10	5199.9661	5199.9649	5199.9633	5199.9614
0	5199.9647	5199.9633	5199.9614	5199.9592
10	5199.9634	5199.9621	5199.9606	5199.9588
20	5199.9622	5199.9609	5199.9593	5199.9574
30	5199.9608	5199.9597	5199.9583	5199.9567
40	5199.9593	5199.9580	5199.9564	5199.9545
50	5199.9576	5199.9564	5199.9549	5199.9526
Max. Deviation (MHz)	0.0424	0.0436	0.0451	0.0474
Max. Deviation (ppm)	8.15	8.38	8.67	9.12
Result	Complies			

Voltage vs. Frequency Stability

Voltage	Measurement Frequency (MHz)			
(V)	5785 MHz			
	0 Minute	2 Minute	5 Minute	10 Minute
126.50	5784.9574	5784.9563	5784.9548	5784.9528
110.00	5784.9562	5784.9549	5784.9533	5784.9514
93.50	5784.9548	5784.9539	5784.9525	5784.9507
Max. Deviation (MHz)	0.0452	0.0461	0.0475	0.0493
Max. Deviation (ppm)	7.81	7.97	8.21	8.52
Result	Complies			

Temperature vs. Frequency Stability

Temperature	Measurement Frequency (MHz)			
(°C)	5785 MHz			
	0 Minute	2 Minute	5 Minute	10 Minute
-20	5784.9616	5784.9603	5784.9586	5784.9565
-10	5784.9601	5784.9589	5784.9573	5784.9554
0	5784.9587	5784.9573	5784.9554	5784.9532
10	5784.9574	5784.9561	5784.9546	5784.9528
20	5784.9562	5784.9549	5784.9533	5784.9514
30	5784.9548	5784.9537	5784.9523	5784.9507
40	5784.9533	5784.9520	5784.9504	5784.9485
50	5784.9516	5784.9504	5784.9489	5784.9466
Max. Deviation (MHz)	0.0484	0.0496	0.0511	0.0534
Max. Deviation (ppm)	8.37	8.57	8.83	9.23
Result	Complies			

Mode: 40 MHz / Ant. 1

Voltage vs. Frequency Stability

Voltage	Measurement Frequency (MHz)			
(V)	5190 MHz			
	0 Minute	2 Minute	5 Minute	10 Minute
126.50	5189.9556	5189.9545	5189.9530	5189.9510
110.00	5189.9544	5189.9531	5189.9515	5189.9496
93.50	5189.9530	5189.9521	5189.9507	5189.9489
Max. Deviation (MHz)	0.0470	0.0479	0.0493	0.0511
Max. Deviation (ppm)	9.06	9.23	9.50	9.85
Result	Complies			

Temperature vs. Frequency Stability

Temperature	Measurement Frequency (MHz)			
(°C)	5190 MHz			
	0 Minute	2 Minute	5 Minute	10 Minute
-20	5189.9598	5189.9585	5189.9568	5189.9547
-10	5189.9583	5189.9571	5189.9555	5189.9536
0	5189.9569	5189.9555	5189.9536	5189.9514
10	5189.9556	5189.9543	5189.9528	5189.9510
20	5189.9544	5189.9531	5189.9515	5189.9496
30	5189.9530	5189.9519	5189.9505	5189.9489
40	5189.9515	5189.9502	5189.9486	5189.9467
50	5189.9498	5189.9486	5189.9471	5189.9448
Max. Deviation (MHz)	0.0502	0.0514	0.0529	0.0552
Max. Deviation (ppm)	9.67	9.90	10.19	10.64
Result	Complies			

Voltage vs. Frequency Stability

Voltage	Measurement Frequency (MHz)			
(V)	5755 MHz			
	0 Minute	2 Minute	5 Minute	10 Minute
126.50	5754.9544	5754.9533	5754.9518	5754.9498
110.00	5754.9532	5754.9519	5754.9503	5754.9484
93.50	5754.9518	5754.9509	5754.9495	5754.9477
Max. Deviation (MHz)	0.0482	0.0491	0.0505	0.0523
Max. Deviation (ppm)	8.38	8.53	8.77	9.09
Result	Complies			

Temperature vs. Frequency Stability

Temperature	Measurement Frequency (MHz)			
(°C)	5755 MHz			
	0 Minute	2 Minute	5 Minute	10 Minute
-20	5754.9586	5754.9573	5754.9556	5754.9535
-10	5754.9571	5754.9559	5754.9543	5754.9524
0	5754.9557	5754.9543	5754.9524	5754.9502
10	5754.9544	5754.9531	5754.9516	5754.9498
20	5754.9532	5754.9519	5754.9503	5754.9484
30	5754.9518	5754.9507	5754.9493	5754.9477
40	5754.9503	5754.9490	5754.9474	5754.9455
50	5754.9486	5754.9474	5754.9459	5754.9436
Max. Deviation (MHz)	0.0514	0.0526	0.0541	0.0564
Max. Deviation (ppm)	8.93	9.14	9.40	9.80
Result	Complies			

Mode: 80 MHz / Ant. 1

Voltage vs. Frequency Stability

Voltage	Measurement Frequency (MHz)			
(V)	5210 MHz			
	0 Minute	2 Minute	5 Minute	10 Minute
126.50	5209.9496	5209.9485	5209.9470	5209.9450
110.00	5209.9484	5209.9471	5209.9455	5209.9436
93.50	5209.9470	5209.9461	5209.9447	5209.9429
Max. Deviation (MHz)	0.0530	0.0539	0.0553	0.0571
Max. Deviation (ppm)	10.17	10.35	10.61	10.96
Result	Complies			

Temperature vs. Frequency Stability

Temperature	Measurement Frequency (MHz)			
(°C)	5210 MHz			
	0 Minute	2 Minute	5 Minute	10 Minute
-20	5209.9538	5209.9525	5209.9508	5209.9487
-10	5209.9523	5209.9511	5209.9495	5209.9476
0	5209.9509	5209.9495	5209.9476	5209.9454
10	5209.9496	5209.9483	5209.9468	5209.9450
20	5209.9484	5209.9471	5209.9455	5209.9436
30	5209.9470	5209.9459	5209.9445	5209.9429
40	5209.9455	5209.9442	5209.9426	5209.9407
50	5209.9438	5209.9426	5209.9411	5209.9390
Max. Deviation (MHz)	0.0562	0.0574	0.0589	0.0610
Max. Deviation (ppm)	10.79	11.02	11.31	11.71
Result	Complies			

Voltage vs. Frequency Stability

Voltage	Measurement Frequency (MHz)			
(V)	5775 MHz			
	0 Minute	2 Minute	5 Minute	10 Minute
126.50	5774.9430	5774.9419	5774.9404	5774.9384
110.00	5774.9418	5774.9405	5774.9389	5774.9370
93.50	5774.9404	5774.9395	5774.9381	5774.9363
Max. Deviation (MHz)	0.0596	0.0605	0.0619	0.0637
Max. Deviation (ppm)	10.32	10.48	10.72	11.03
Result	Complies			

Temperature vs. Frequency Stability

Temperature	Measurement Frequency (MHz)			
(°C)	5775 MHz			
	0 Minute	2 Minute	5 Minute	10 Minute
-20	5774.9472	5774.9459	5774.9442	5774.9421
-10	5774.9457	5774.9445	5774.9429	5774.9410
0	5774.9443	5774.9429	5774.9410	5774.9388
10	5774.9430	5774.9417	5774.9402	5774.9384
20	5774.9418	5774.9405	5774.9389	5774.9370
30	5774.9404	5774.9393	5774.9379	5774.9363
40	5774.9389	5774.9376	5774.9360	5774.9341
50	5774.9372	5774.9360	5774.9345	5774.9322
Max. Deviation (MHz)	0.0628	0.0640	0.0655	0.0678
Max. Deviation (ppm)	10.87	11.08	11.34	11.74
Result	Complies			

4.9. Antenna Requirements

4.9.1. Limit

Except for special regulations, the Low-power Radio-frequency Devices must not be equipped with any jacket for installing an antenna with extension cable. An intentional radiator shall be designed to ensure that no antenna other than that furnished by the responsible party shall be used with the device. The use of a permanently attached antenna or of an antenna that uses a unique coupling to the intentional radiator shall be considered sufficient to comply with the provisions of this Section. The manufacturer may design the unit so that the user can replace a broken antenna, but the use of a standard antenna jack or electrical connector is prohibited. Further, this requirement does not apply to intentional radiators that must be professionally installed.

4.9.2. Antenna Connector Construction

Please refer to section 3.3 in this test report; antenna connector complied with the requirements.

5. LIST OF MEASURING EQUIPMENTS

Instrument	Manufacturer	Model No.	Serial No.	Characteristics	Calibration Date	Remark
EMI Test Receiver	R&S	ESCS 30	100355	9kHz ~ 2.75GHz	Apr. 22, 2015	Conduction (CO01-CB)
LISN	F.C.C.	FCC-LISN-50-16-2	04083	150kHz ~ 100MHz	Dec. 02, 2014	Conduction (CO01-CB)
LISN	Schwarzbeck	NSLK 8127	8127647	9kHz ~ 30MHz	Dec. 02, 2014	Conduction (CO01-CB)
COND Cable	Woken	Cable	01	150kHz ~ 30MHz	Dec. 03, 2014	Conduction (CO01-CB)
Software	Audix	E3	5.410e	-	N.C.R.	Conduction (CO01-CB)
BILOG ANTENNA	Schaffner	CBL6112D	22021	20MHz ~ 2GHz	May 06, 2015	Radiation (O3CH01-CB)
Horn Antenna	EMCO	3115	00075790	750MHz ~ 18GHz	Oct. 28, 2014	Radiation (O3CH01-CB)
Loop Antenna	Teseq	HLA 6120	24155	9kHz - 30 MHz	Mar. 12, 2015*	Radiation (O3CH01-CB)
Horn Antenna	Schwarzbeck	BBHA 9170	BBHA9170252	15GHz ~ 40GHz	Jul. 21, 2015	Radiation (O3CH01-CB)
Pre-Amplifier	Agilent	8447D	2944A10991	0.1MHz ~ 1.3GHz	Feb. 24, 2015	Radiation (O3CH01-CB)
Pre-Amplifier	Agilent	8449B	3008A02310	1GHz ~ 26.5GHz	Jan. 12, 2015	Radiation (O3CH01-CB)
Pre-Amplifier	WM	TF-130N-R1	923365	26GHz ~ 40GHz	Nov. 25, 2014	Radiation (O3CH01-CB)
Spectrum Analyzer	R&S	FSP40	100056	9kHz ~ 40GHz	Nov. 06, 2014	Radiation (O3CH01-CB)
EMI Receiver	Agilent	N9038A	MY52260123	9kHz ~ 8.4GHz	Jan. 21, 2015	Radiation (O3CH01-CB)
RF Cable-low	Woken	Low Cable-1	N/A	30 MHz ~ 1 GHz	Nov. 15, 2014	Radiation (O3CH01-CB)
RF Cable-high	Woken	High Cable-40G-1	N/A	1 GHz ~ 40 GHz	Nov. 15, 2014	Radiation (O3CH01-CB)
RF Cable-high	Woken	High Cable-40G-2	N/A	1 GHz ~ 40 GHz	Nov. 15, 2014	Radiation (O3CH01-CB)
Spectrum analyzer	R&S	FSP40	100979	9kHz~40GHz	Dec. 12, 2014	Conducted (TH01-CB)
RF Cable-high	Woken	RG402	High Cable-7	1 GHz – 26.5 GHz	Nov. 15, 2014	Conducted (TH01-CB)
RF Cable-high	Woken	RG402	High Cable-8	1 GHz – 26.5 GHz	Nov. 15, 2014	Conducted (TH01-CB)
RF Cable-high	Woken	RG402	High Cable-9	1 GHz – 26.5 GHz	Nov. 15, 2014	Conducted (TH01-CB)
RF Cable-high	Woken	RG402	High Cable-10	1 GHz – 26.5 GHz	Nov. 15, 2014	Conducted (TH01-CB)
RF Cable-high	Woken	RG402	High Cable-6	1 GHz – 26.5 GHz	Nov. 15, 2014	Conducted (TH01-CB)
Power Sensor	Agilent	U2021XA	MY53410001	50MHz~18GHz	Nov. 03, 2014	Conducted (TH01-CB)

Note: Calibration Interval of instruments listed above is one year.

“*” Calibration Interval of instruments listed above is two years.

N.C.R. means Non-Calibration required.

6. MEASUREMENT UNCERTAINTY

Test Items	Uncertainty	Remark
Conducted Emission (150kHz ~ 30MHz)	3.2 dB	Confidence levels of 95%
Radiated Emission (30MHz ~ 1,000MHz)	3.6 dB	Confidence levels of 95%
Radiated Emission (1GHz ~ 18GHz)	3.7 dB	Confidence levels of 95%
Radiated Emission (18GHz ~ 40GHz)	3.5 dB	Confidence levels of 95%
Conducted Emission	1.7 dB	Confidence levels of 95%