



**FCC 47 CFR PART 15 SUBPART C**

**TEST REPORT**

**For**

**High Power Touch Screen Wi-Fi Range Extender**

**Model: TAP-EX**

**Trade Name: Amped Wireless**

*Issued to*

**Amped Wireless**  
**13089 Peyton Dr. #C307 Chino Hills California 91709 United States**

*Issued by*

**Compliance Certification Services Inc.**  
**No.11, Wugong 6th Rd., Wugu Dist.,**  
**New Taipei City 24891, Taiwan. (R.O.C.)**  
**<http://www.ccsrf.com>**  
**[service@ccsrf.com](mailto:service@ccsrf.com)**  
**Issued Date: November 13, 2014**



---

*Note: This report shall not be reproduced except in full, without the written approval of Compliance Certification Services Inc. This document may be altered or revised by Compliance Certification Services Inc. personnel only, and shall be noted in the revision section of the document.*



**Revision History**

Rev.	Issue Date	Revisions	Effect Page	Revised By
00	November 13, 2014	Initial Issue	ALL	Becca Chen



## **TABLE OF CONTENTS**

<b>1. TEST RESULT CERTIFICATION.....</b>	<b>4</b>
<b>2. EUT DESCRIPTION .....</b>	<b>5</b>
<b>3. TEST METHODOLOGY .....</b>	<b>6</b>
3.1 EUT CONFIGURATION.....	6
3.2 EUT EXERCISE.....	6
3.3 GENERAL TEST PROCEDURES .....	6
3.4 FCC PART 15.205 RESTRICTED BANDS OF OPERATIONS .....	7
3.5 DESCRIPTION OF TEST MODES .....	8
<b>4. INSTRUMENT CALIBRATION.....</b>	<b>9</b>
4.1 MEASURING INSTRUMENT CALIBRATION .....	9
4.2 MEASUREMENT EQUIPMENT USED.....	9
4.3 MEASUREMENT UNCERTAINTY .....	10
<b>5. FACILITIES AND ACCREDITATIONS .....</b>	<b>11</b>
5.1 FACILITIES .....	11
5.2 EQUIPMENT .....	11
5.3 TABLE OF ACCREDITATIONS AND LISTINGS.....	12
<b>6. SETUP OF EQUIPMENT UNDER TEST .....</b>	<b>13</b>
6.1 SETUP CONFIGURATION OF EUT.....	13
6.2 SUPPORT EQUIPMENT.....	13
<b>7. FCC PART 15.247 REQUIREMENTS.....</b>	<b>14</b>
7.1 6DB BANDWIDTH .....	14
7.2 PEAK POWER .....	34
7.3 AVERAGE POWER .....	36
7.4 BAND EDGES MEASUREMENT .....	38
7.5 PEAK POWER SPECTRAL DENSITY .....	68
7.6 SPURIOUS EMISSIONS .....	88
7.7 RADIATED EMISSIONS .....	107
7.8 POWERLINE CONDUCTED EMISSIONS.....	124
<b>APPENDIX I PHOTOGRAPHS OF TEST SETUP.....</b>	<b>127</b>
<b>APPENDIX 1 - PHOTOGRAPHS OF EUT</b>	



## 1. TEST RESULT CERTIFICATION

**Applicant:** Amped Wireless  
13089 Peyton Dr. #C307 Chino Hills California 91709 United States

**Equipment Under Test:** High Power Touch Screen Wi-Fi Range Extender

**Trade Name:** Amped Wireless

**Model Number:** TAP-EX

**Date of Test:** October 30 ~ October 31, 2014

APPLICABLE STANDARDS	
STANDARD	TEST RESULT
FCC 47 CFR Part 15 Subpart C	No non-compliance noted

### We hereby certify that:

The above equipment was tested by Compliance Certification Services Inc. The test data, data evaluation, test procedures, and equipment configurations shown in this report were made in accordance with the procedures given in ANSI C63.4: 2009 and the energy emitted by the sample EUT tested as described in this report is in compliance with the requirements of FCC Rules Part 15.207, 15.209, 15.247.

The test results of this report relate only to the tested sample EUT identified in this report.

Approved by:

Reviewed by:

Miller Lee  
Section Manager  
Compliance Certification Services Inc.

Angel Cheng  
Section Manager  
Compliance Certification Services Inc.



## 2. EUT DESCRIPTION

<b>Product</b>	High Power Touch Screen Wi-Fi Range Extender
<b>Trade Name</b>	Amped Wireless
<b>Model Number</b>	TAP-EX
<b>Model Discrepancy</b>	N/A
<b>Received Date</b>	October 31, 2014
<b>Power Adapter</b>	ATW / ATW-1210US I/P: 100-240Vac, 50/60Hz, MAX 0.3A O/P: 12Vdc, 1A
<b>Frequency Range</b>	IEEE 802.11b/g mode: 2412 ~ 2462 MHz IEEE 802.11n HT 20 MHz mode 2412 ~ 2462 MHz IEEE 802.11n HT 40 MHz mode: 2422 ~ 2452 MHz
<b>Transmit Power</b>	IEEE 802.11b mode: 27.58 dBm IEEE 802.11g mode: 28.18 dBm IEEE 802.11n HT 20 MHz mode: 24.37 dBm IEEE 802.11n HT 40 MHz mode: 24.57 dBm
<b>Modulation Technique</b>	IEEE 802.11b mode: DSSS IEEE 802.11g mode: OFDM IEEE 802.11n HT 20 MHz mode: OFDM IEEE 802.11n HT 40 MHz mode: OFDM
<b>Number of Channels</b>	IEEE 802.11b/g mode: 11 Channels IEEE 802.11n HT 20 MHz mode: 11 Channels IEEE 802.11n HT 40 MHz mode: 7 Channels
<b>Antenna Specification</b>	1. Multilayer Chip Antenna / Gain: 2.5dBi 2. Dipole Antenna / Gain: 2.0dBi MIMO: Total ANT=2.5+10*LOG(2)=5.5

**Remark:**

1. The sample selected for test was engineering sample that approximated to production product and was provided by manufacturer.
2. This submittal(s) (test report) is intended for FCC ID: **ZTT-TAPEX** filing to comply with Section 15.207, 15.209 and 15.247 of the FCC Part 15, Subpart C Rules.



### **3. TEST METHODOLOGY**

The tests documented in this report were performed in accordance with ANSI C63.4: 2009 and FCC CFR 47 Part 15.207, 15.209, 15.247 and KDB558074.

#### **3.1 EUT CONFIGURATION**

The EUT configuration for testing is installed on RF field strength measurement to meet the Commissions requirement and operating in a manner that intends to maximize its emission characteristics in a continuous normal application.

#### **3.2 EUT EXERCISE**

The EUT was operated in the engineering mode to fix the TX frequency that was for the purpose of the measurements.

According to its specifications, the EUT must comply with the requirements of the Section 15.207, 15.209 and 15.247 under the FCC Rules Part 15 Subpart C.

#### **3.3 GENERAL TEST PROCEDURES**

##### **Conducted Emissions**

The EUT is placed on the turntable, which is 0.8 m above ground plane. According to the requirements in Section 13.1.4.1 of ANSI C63.4 Conducted emissions from the EUT measured in the frequency range between 0.15 MHz and 30MHz using CISPR Quasi-peak and average detector modes.

##### **Radiated Emissions**

The EUT is placed on a turn table, which is 0.8 m above ground plane. The turntable shall rotate 360 degrees to determine the position of maximum emission level. EUT is set 3m away from the receiving antenna, which varied from 1m to 4m to find out the highest emission. And also, each emission was to be maximized by changing the polarization of receiving antenna both horizontal and vertical. In order to find out the maximum emissions, exploratory radiated emission measurements were made according to the requirements in Section 13.1.4.1 of ANSI C63.4.



### 3.4 FCC PART 15.205 RESTRICTED BANDS OF OPERATIONS

(a) Except as shown in paragraph (d) of this section, only spurious emissions are permitted in any of the frequency bands listed below:

MHz	MHz	MHz	GHz
0.090 - 0.110	16.42 - 16.423	399.9 - 410	4.5 - 5.15
<sup>1</sup> 0.495 - 0.505	16.69475 - 16.69525	608 - 614	5.35 - 5.46
2.1735 - 2.1905	16.80425 - 16.80475	960 - 1240	7.25 - 7.75
4.125 - 4.128	25.5 - 25.67	1300 - 1427	8.025 - 8.5
4.17725 - 4.17775	37.5 - 38.25	1435 - 1626.5	9.0 - 9.2
4.20725 - 4.20775	73 - 74.6	1645.5 - 1646.5	9.3 - 9.5
6.215 - 6.218	74.8 - 75.2	1660 - 1710	10.6 - 12.7
6.26775 - 6.26825	108 - 121.94	1718.8 - 1722.2	13.25 - 13.4
6.31175 - 6.31225	123 - 138	2200 - 2300	14.47 - 14.5
8.291 - 8.294	149.9 - 150.05	2310 - 2390	15.35 - 16.2
8.362 - 8.366	156.52475 -	2483.5 - 2500	17.7 - 21.4
8.37625 - 8.38675	156.52525	2655 - 2900	22.01 - 23.12
8.41425 - 8.41475	156.7 - 156.9	3260 - 3267	23.6 - 24.0
12.29 - 12.293	162.0125 - 167.17	3332 - 3339	31.2 - 31.8
12.51975 - 12.52025	167.72 - 173.2	3345.8 - 3358	36.43 - 36.5
12.57675 - 12.57725	240 - 285	3600 - 4400	( <sup>2</sup> )
13.36 - 13.41	322 - 335.4		

<sup>1</sup> Until February 1, 1999, this restricted band shall be 0.490-0.510 MHz.

<sup>2</sup> Above 38.6

(b) Except as provided in paragraphs (d) and (e), the field strength of emissions appearing within these frequency bands shall not exceed the limits shown in Section 15.209. At frequencies equal to or less than 1000 MHz, compliance with the limits in Section 15.209 shall be demonstrated using measurement instrumentation employing a CISPR quasi-peak detector. Above 1000 MHz, compliance with the emission limits in Section 15.209 shall be demonstrated based on the average value of the measured emissions. The provisions in Section 15.35 apply to these measurements.



### **3.5 DESCRIPTION OF TEST MODES**

The EUT (model: TAP-EX) had been tested under operating condition.

Software used to control the EUT for staying in continuous transmitting mode was programmed.

After verification, all tests were carried out with the worst case test modes as shown below except radiated spurious emission below 1GHz and power line conducted emissions below 30MHz, which worst case was in normal link mode only.

The EUT is a 2x2 configuration spatial MIMO (2Tx & 2Rx) without beam forming function that operate in double TX chains and double RX chains. The 2x2 configuration is implemented with two outside TX & RX chains (Chain 0 and 1).

**IEEE 802.11b mode:**

Channel Low (2412MHz), Channel Mid (2437MHz) and Channel High (2462MHz) with 1Mbps data rate were chosen for full testing.

**IEEE 802.11g mode:**

Channel Low (2412MHz), Channel Mid (2437MHz) and Channel High (2462MHz) with 6Mbps data rate were chosen for full testing.

**IEEE 802.11n HT 20 MHz mode:**

Channel Low (2412MHz), Channel Mid (2437MHz) and Channel High (2462MHz) with 6.5Mbps data rate were chosen for full testing.

**IEEE 802.11n HT 40 MHz mode:**

Channel Low (2422MHz), Channel Mid (2437MHz) and Channel High (2452MHz) with 13.5Mbps data rate were chosen for full testing.

The field strength of spurious emission was measured in the following position: EUT stand-up position (Z axis), lie-down position (X, Y axis) and laptop mode. The worst emission was found in stand-up position (Y axis) and the worst case was recorded.





## 4. INSTRUMENT CALIBRATION

### 4.1 MEASURING INSTRUMENT CALIBRATION

The measuring equipment, which was utilized in performing the tests documented herein, has been calibrated in accordance with the manufacturer's recommendations for utilizing calibration equipment, which is traceable to recognized national standards.

### 4.2 MEASUREMENT EQUIPMENT USED

#### Equipment Used for Emissions Measurement

*Remark: Each piece of equipment is scheduled for calibration once a year and Loop Antenna is scheduled for calibration once three years.*

Conducted Emissions Test Site				
Name of Equipment	Manufacturer	Model	Serial Number	Calibration Due
Spectrum Analyzer	Agilent	E4446A	MY43360131	03/19/2015
Power Meter	Anritsu	ML2495A	1012009	06/03/2015
Power Sensor	Anritsu	MA2411A	0917072	06/03/2015

Wugu 966 Chamber A				
Name of Equipment	Manufacturer	Model	Serial Number	Calibration Due
Spectrum Analyzer	Agilent	E4446A	US42510252	10/30/2015
EMI Test Receiver	R&S	ESCI	100064	02/14/2015
Pre-Amplifier	Mini-Circuits	ZFL-1000LN	SF350700823	01/10/2015
Pre-Amplifier	MITEQ	AFS44-00102650-42-10P-44	1415367	11/17/2014
Bilog Antenna	Sunol Sciences	JB3	A030105	09/30/2015
Horn Antenna	EMCO	3117	00055165	01/09/2015
Horn Antenna	EMCO	3116	00026370	10/09/2015
Loop Antenna	EMCO	6502	8905/2356	06/08/2015
Turn Table	CCS	CC-T-1F	N/A	N.C.R
Antenna Tower	CCS	CC-A-1F	N/A	N.C.R
Controller	CCS	CC-C-1F	N/A	N.C.R
Site NSA	CCS	N/A	N/A	12/23/2014
Test S/W	EZ-EMC (CCS-3A1RE)			

Conducted Emission room #A				
Name of Equipment	Manufacturer	Model	Serial Number	Calibration Due
EMI Test Receiver	R&S	ESI	101203	09/09/2015
LISN	R&S	ESH3-Z5	848773/014	12/03/2014
Coaxial Cable	Commate	CFD300-NL	NA	12/03/2014
Test S/W	CCS-3A1-CE			



### 4.3 MEASUREMENT UNCERTAINTY

PARAMETER	UNCERTAINTY
Powerline Conducted Emission	+/- 1.2159
3M Semi Anechoic Chamber / 30M~200M	+/- 4.0138
3M Semi Anechoic Chamber / 200M~1000M	+/- 3.9483
3M Semi Anechoic Chamber / 1G~8G	+/- 2.5975
3M Semi Anechoic Chamber / 8G~18G	+/- 2.6112
3M Semi Anechoic Chamber / 18G~26G	+/- 2.7389
3M Semi Anechoic Chamber / 26G~40G	+/- 2.9683

**Remark:** This uncertainty represents an expanded uncertainty expressed at approximately the 95% confidence level using a coverage factor of  $k=2$ .



## **5. FACILITIES AND ACCREDITATIONS**

### **5.1 FACILITIES**

All measurement facilities used to collect the measurement data are located at

No.199, Chungshen Road, Hsintien City, Taipei Hsien, Taiwan, R.O.C.  
Tel: 886-2-2217-0894 / Fax: 886-2-2217-1029

No.11, Wugong 6th Rd., Wugu Dist., New Taipei City 24891, Taiwan. (R.O.C.)  
Tel: 886-2-2299-9720 / Fax: 886-2-2298-4045

No.81-1, Lane 210, Bade 2nd Rd., Lujhu Township, Taoyuan County 33841, TAIWAN, R.O.C.  
Tel: 886-3-324-0332 / Fax: 886-3-324-5235

The sites are constructed in conformance with the requirements of ANSI C63.7, ANSI C63.4 and CISPR Publication 22.

### **5.2 EQUIPMENT**

Radiated emissions are measured with one or more of the following types of linearly polarized antennas: tuned dipole, biconical, log periodic, bi-log, and/or ridged waveguide, horn. Spectrum analyzers with pre-selectors and quasi-peak detectors are used to perform radiated measurements.



Conducted emissions are measured with Line Impedance Stabilization Networks and EMI Test Receivers.

Calibrated wideband preamplifiers, coaxial cables, and coaxial attenuators are also used for making measurements.

All receiving equipment conforms to CISPR Publication 16-1, "Radio Interference Measuring Apparatus and Measurement Methods."

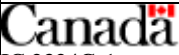

### 5.3 TABLE OF ACCREDITATIONS AND LISTINGS

Country	Agency	Scope of Accreditation	Logo
USA	FCC	3M Semi Anechoic Chamber (FCC MRA: TW1039) to perform FCC Part 15 measurements	 FCC MRA: TW1039
Taiwan	TAF	LP0002, RTTE01, FCC Method-47 CFR Part 15 Subpart C, D, E, RSS-210, RSS-310 IDA TS SRD, AS/NZS 4268, AS/NZS 4771, TS 12.1 & 12.2, ETSI EN 300 440-1, ETSI EN 300 440-2, ETSI EN 300 328, ETSI EN 300 220-1, ETSI EN 300 220-2, ETSI EN 301 893, ETSI EN 301 489-1/3/7/17 FCC OET Bulletin 65 + Supplement C, EN 50360, EN 50361, EN 50371, RSS 102, EN 50383, EN 50385, EN 50392, IEC 62209, CNS 14958-1, CNS 14959 FCC Method -47 CFR Part 15 Subpart B IEC / EN 61000-3-2, IEC / EN 61000-3-3, IEC / EN 61000-4-2/3/4/5/6/8/11	
Canada	Industry Canada	3M Semi Anechoic Chamber (IC 2324G-1 / IC 2324G-2) to perform	 IC 2324G-1 IC 2324G-2

*\* No part of this report may be used to claim or imply product endorsement by A2LA or any agency of the US Government.*



## 6. SETUP OF EQUIPMENT UNDER TEST

### 6.1 SETUP CONFIGURATION OF EUT

See test photographs attached in Appendix II for the actual connections between EUT and support equipment.

### 6.2 SUPPORT EQUIPMENT

No	Equipment	Brand	Model	Series No.	FCC ID	Data Cable	Power Cord
1	Notebook PC	DELL	PP19L	7B3ZP1S	Doc	N/A	AC I/P: Unshielded, 1.8m DC O/P: Unshielded, 1.8m with a core

**Remark:**

1. All the equipment/cables were placed in the worst-case configuration to maximize the emission during the test.
2. Grounding was established in accordance with the manufacturer's requirements and conditions for the intended use.



## 7. FCC PART 15.247 REQUIREMENTS

### 7.1 6DB BANDWIDTH

#### LIMIT

According to §15.247(a)(2), systems using digital modulation techniques may operate in the 902 - 928 MHz, 2400 - 2483.5 MHz, and 5725 - 5850 MHz bands. The minimum 6dB bandwidth shall be at least 500 kHz.

#### Test Configuration

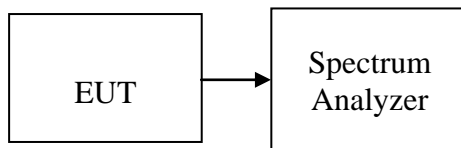

#### TEST PROCEDURE

1. Place the EUT on the table and set it in the transmitting mode.
2. Remove the antenna from the EUT and then connect a low loss RF cable from the antenna port to the spectrum analyzer.
3. Set the spectrum analyzer as RBW = 300 kHz, VBW = 1000 kHz, Sweep = auto.
4. Mark the peak frequency and -6dB (upper and lower) frequency.
5. Repeat until all the rest channels are investigated.

#### TEST RESULTS

*No non-compliance noted.*



**Test Data**

**Test mode: IEEE 802.11b mode**

Channel	Frequency (MHz)	Bandwidth (MHz)	Limit (kHz)	Result
Low	2412	10.25	>500	PASS
Mid	2437	10.3333		PASS
High	2462	10.3333		PASS

**Test mode: IEEE 802.11g mode**

Channel	Frequency (MHz)	Bandwidth (kHz)	Limit (kHz)	Result
Low	2412	16.75	>500	PASS
Mid	2437	16.75		PASS
High	2462	16.75		PASS

**Test mode: IEEE 802.11n HT 20 MHz mode / Chain 0**

Channel	Frequency (MHz)	Bandwidth (MHz)	Limit (kHz)	Result
Low	2412	17.9167	>500	PASS
Mid	2437	17.9167		PASS
High	2462	17.9167		PASS

**Test mode: IEEE 802.11n HT 20 MHz mode / Chain 1**

Channel	Frequency (MHz)	Bandwidth (MHz)	Limit (kHz)	Result
Low	2412	17.9167	>500	PASS
Mid	2437	17.9167		PASS
High	2462	17.9167		PASS

**Test mode: IEEE 802.11n HT 40 MHz mode / Chain 0**

Channel	Frequency (MHz)	Bandwidth (MHz)	Limit (kHz)	Result
Low	2422	36.3334	>500	PASS
Mid	2437	36.4167		PASS
High	2452	36.4167		PASS

**Test mode: IEEE 802.11n HT 40 MHz mode / Chain 1**

Channel	Frequency (MHz)	Bandwidth (MHz)	Limit (kHz)	Result
Low	2422	36.4167	>500	PASS
Mid	2437	36.4167		PASS
High	2452	36.4167		PASS



**Test Plot**

**IEEE 802.11b mode**

**6dB Bandwidth (CH Low)**

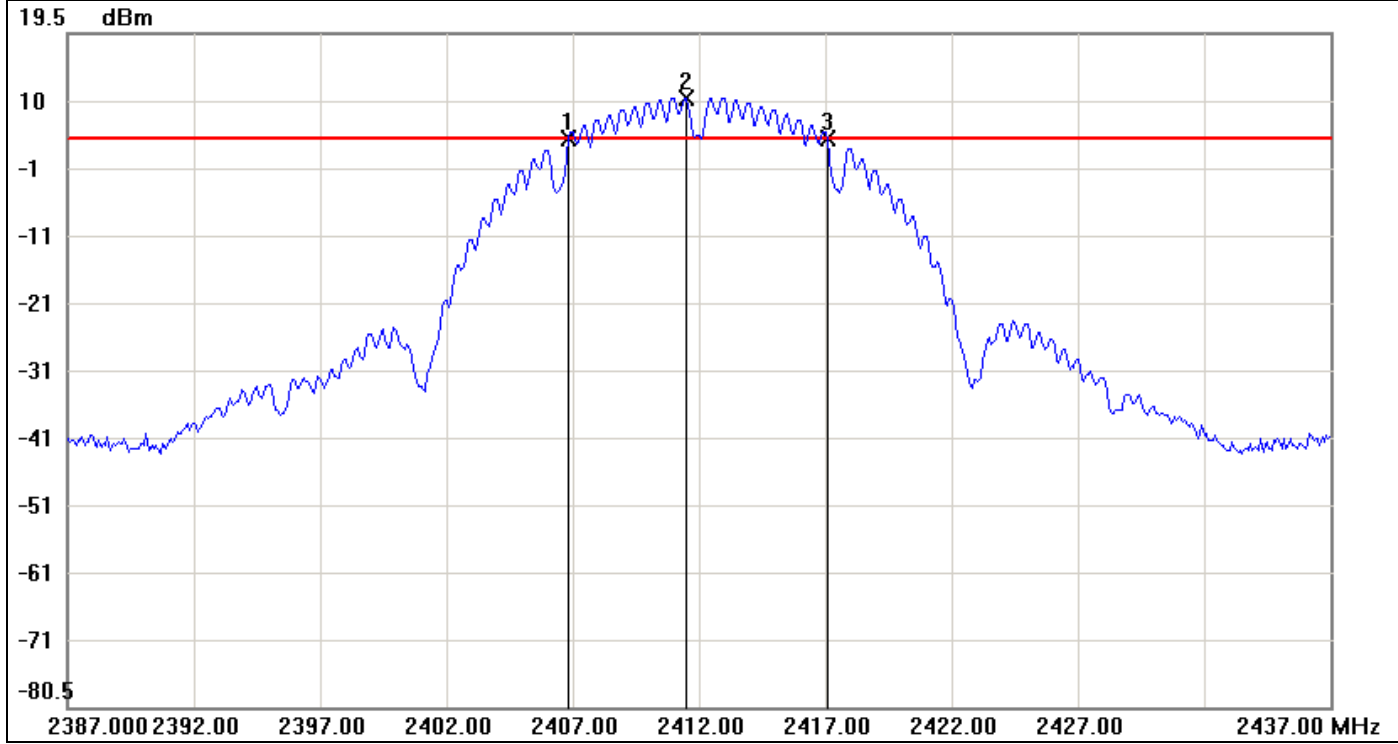

No.	Frequency(MHz)	Result(dBm)	Limit(dBm)	Margin(dBm)
1	2406.8333	3.89	3.93	-0.04
2	2411.5000	9.93	3.93	6.00
3	2417.0833	3.82	3.93	-0.11

No.		$\Delta$ Frequency(MHz)	$\Delta$ Level(dB)
1	mk3-mk1	10.25	-0.07





### 6dB Bandwidth (CH Mid)

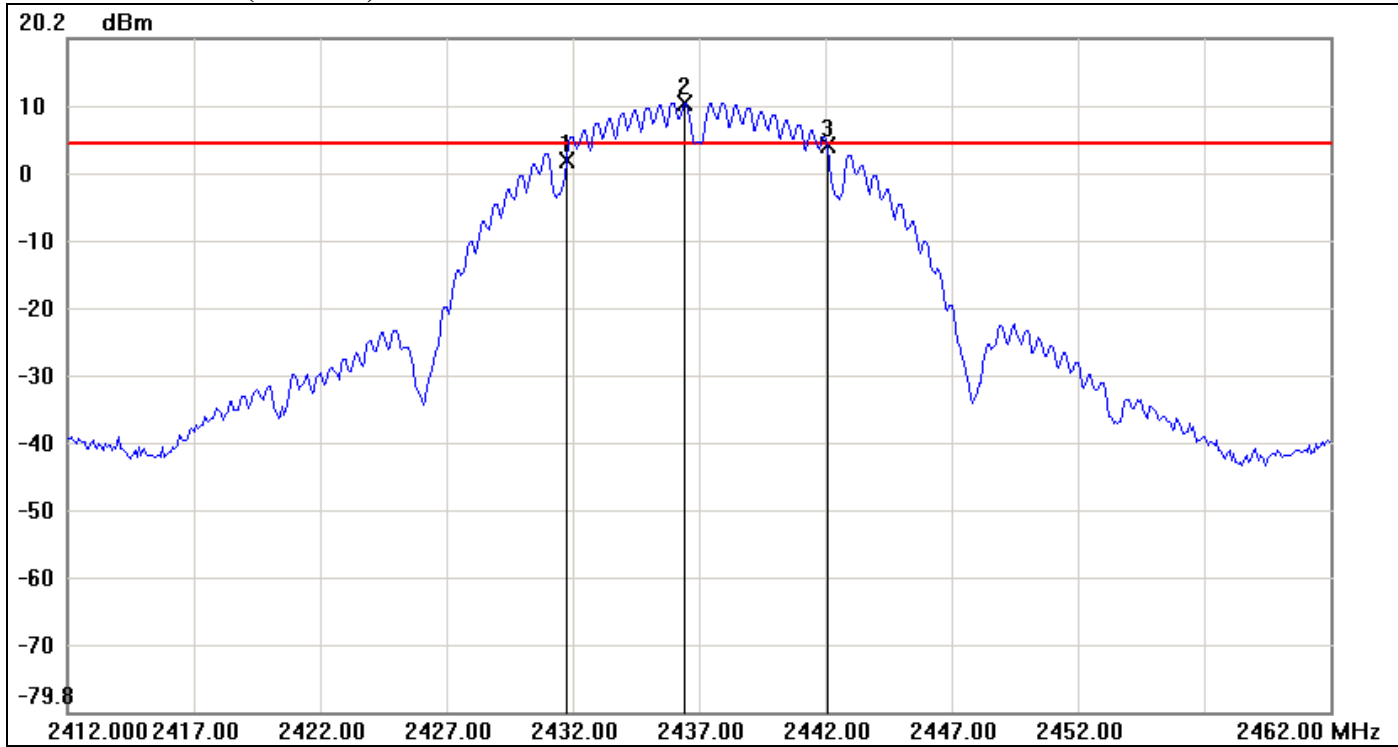

No.	Frequency(MHz)	Result(dBm)	Limit(dBm)	Margin(dBm)
1	2431.7500	2.19	4.69	-2.50
2	2436.4167	10.69	4.69	6.00
3	2442.0833	4.47	4.69	-0.22

No.		$\Delta$ Frequency(MHz)	$\Delta$ Level(dB)
1	mk3-mk1	10.3333	2.28



**6dB Bandwidth (CH High)**

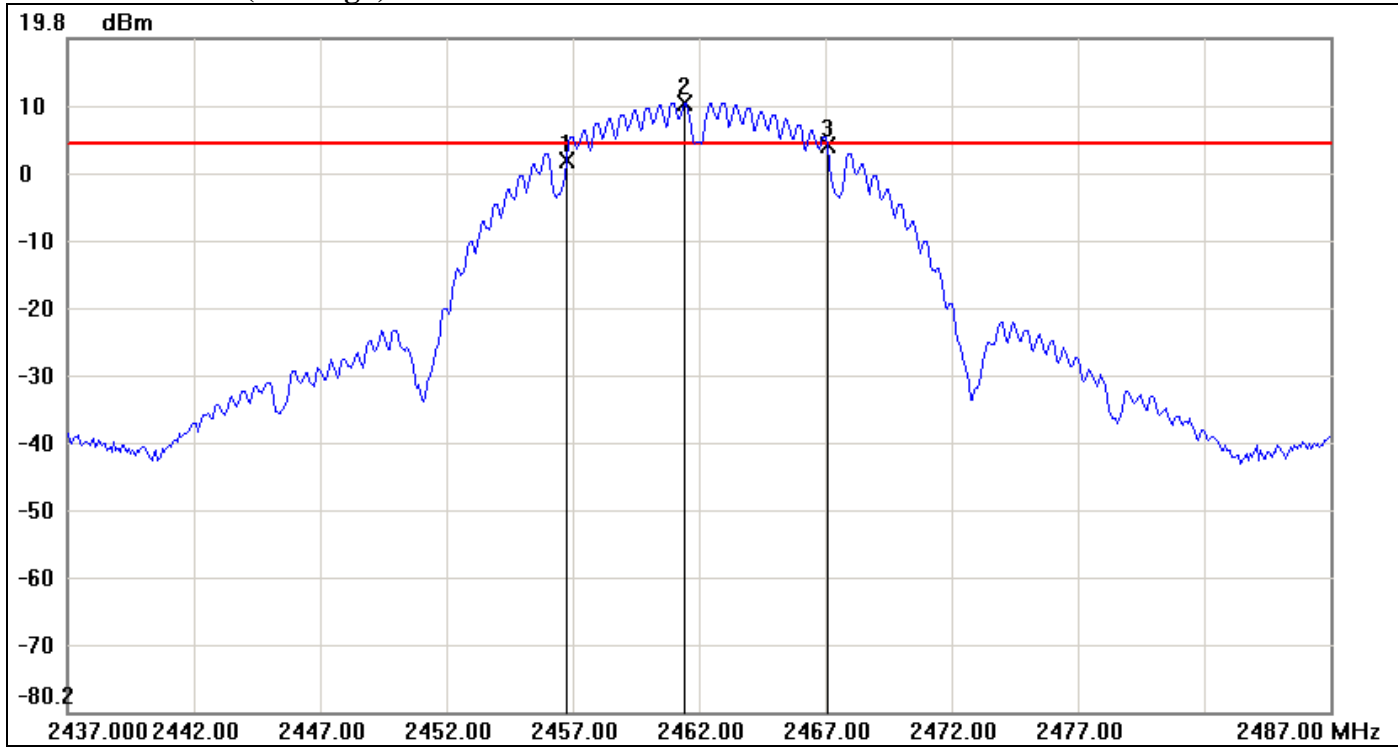

No.	Frequency(MHz)	Result(dBm)	Limit(dBm)	Margin(dBm)
1	2456.7500	1.73	4.26	-2.53
2	2461.4167	10.26	4.26	6.00
3	2467.0833	4.03	4.26	-0.23

No.		$\Delta$ Frequency(MHz)	$\Delta$ Level(dB)
1	mk3-mk1	10.3333	2.3



**IEEE 802.11g mode**

**6dB Bandwidth (CH Low)**

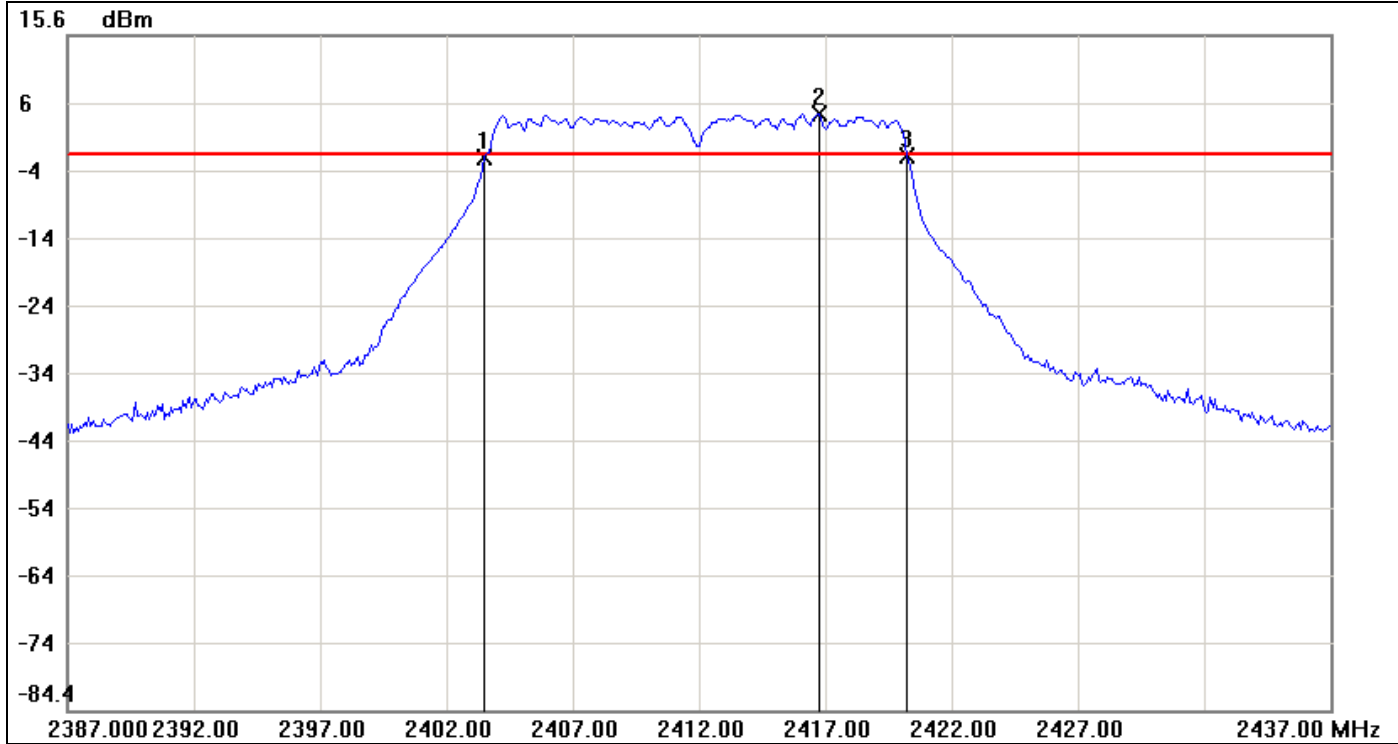

No.	Frequency(MHz)	Result(dBm)	Limit(dBm)	Margin(dBm)
1	2403.5000	-2.63	-2.02	-0.61
2	2416.7500	3.98	-2.02	6.00
3	2420.2500	-2.20	-2.02	-0.18

No.		$\Delta$ Frequency(MHz)	$\Delta$ Level(dB)
1	mk3-mk1	16.75	0.43



**6dB Bandwidth (CH Mid)**

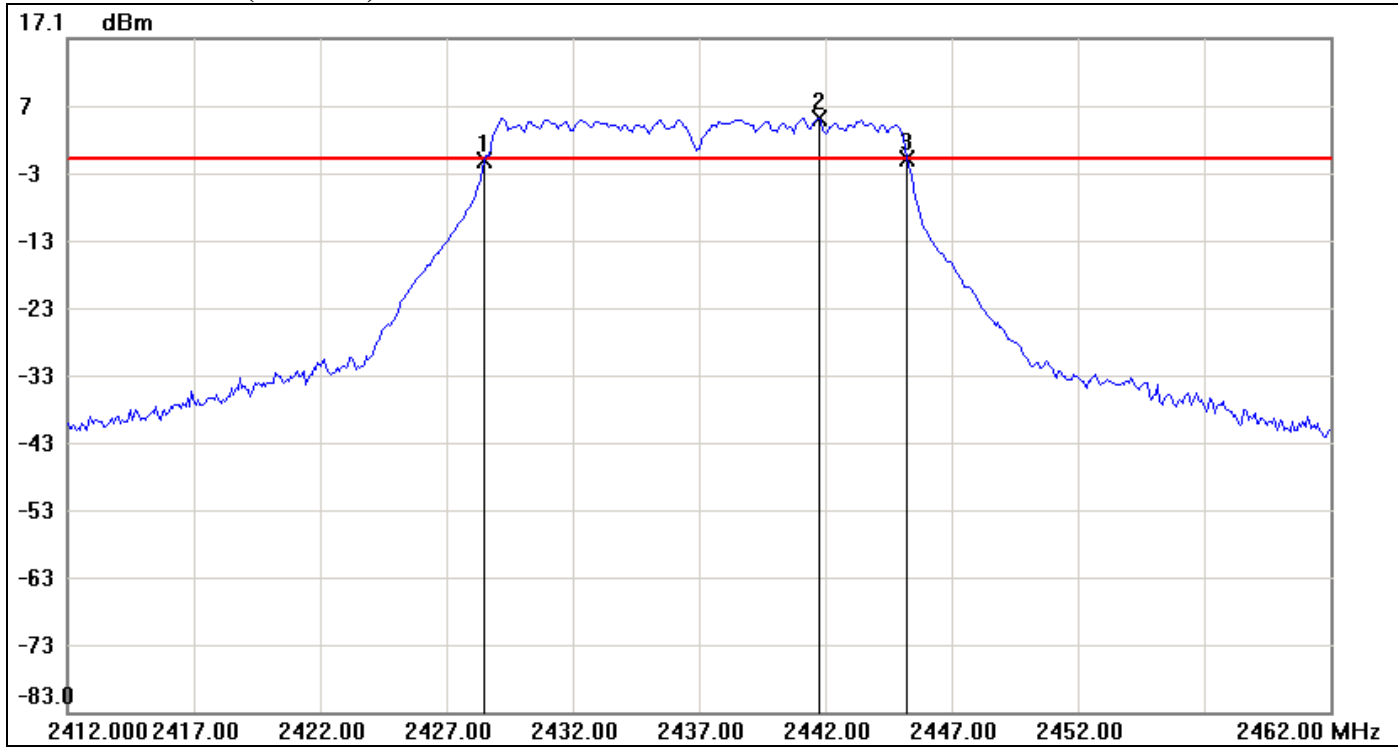

No.	Frequency(MHz)	Result(dBm)	Limit(dBm)	Margin(dBm)
1	2428.5000	-1.10	-0.71	-0.39
2	2441.7500	5.29	-0.71	6.00
3	2445.2500	-0.94	-0.71	-0.23

No.		$\Delta$ Frequency(MHz)	$\Delta$ Level(dB)
1	mk3-mk1	16.75	0.16



**6dB Bandwidth (CH High)**

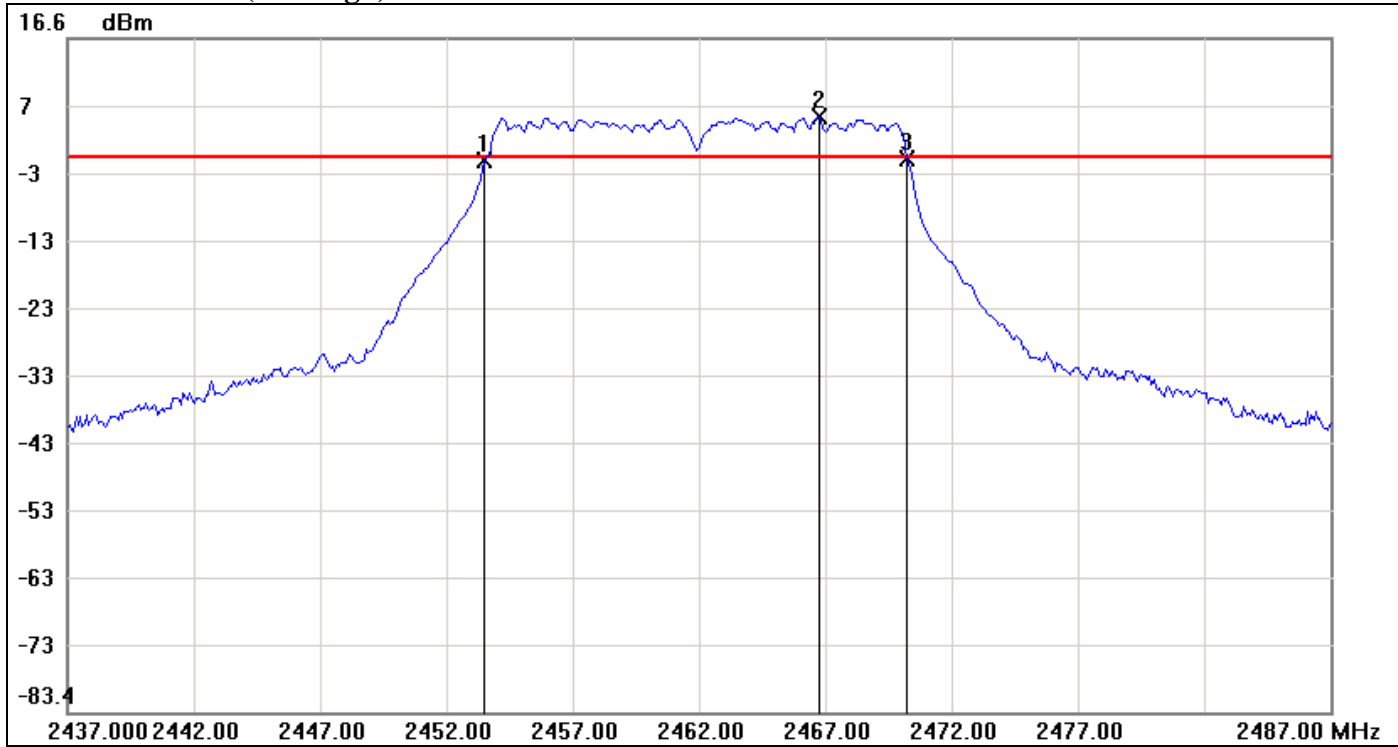

No.	Frequency(MHz)	Result(dBm)	Limit(dBm)	Margin(dBm)
1	2453.5000	-1.51	-1.02	-0.49
2	2466.7500	4.98	-1.02	6.00
3	2470.2500	-1.18	-1.02	-0.16

No.		$\Delta$ Frequency(MHz)	$\Delta$ Level(dB)
1	mk3-mk1	16.75	0.33



**IEEE 802.11n HT 20 MHz mode / Chain 0**

**6dB Bandwidth (CH Low)**

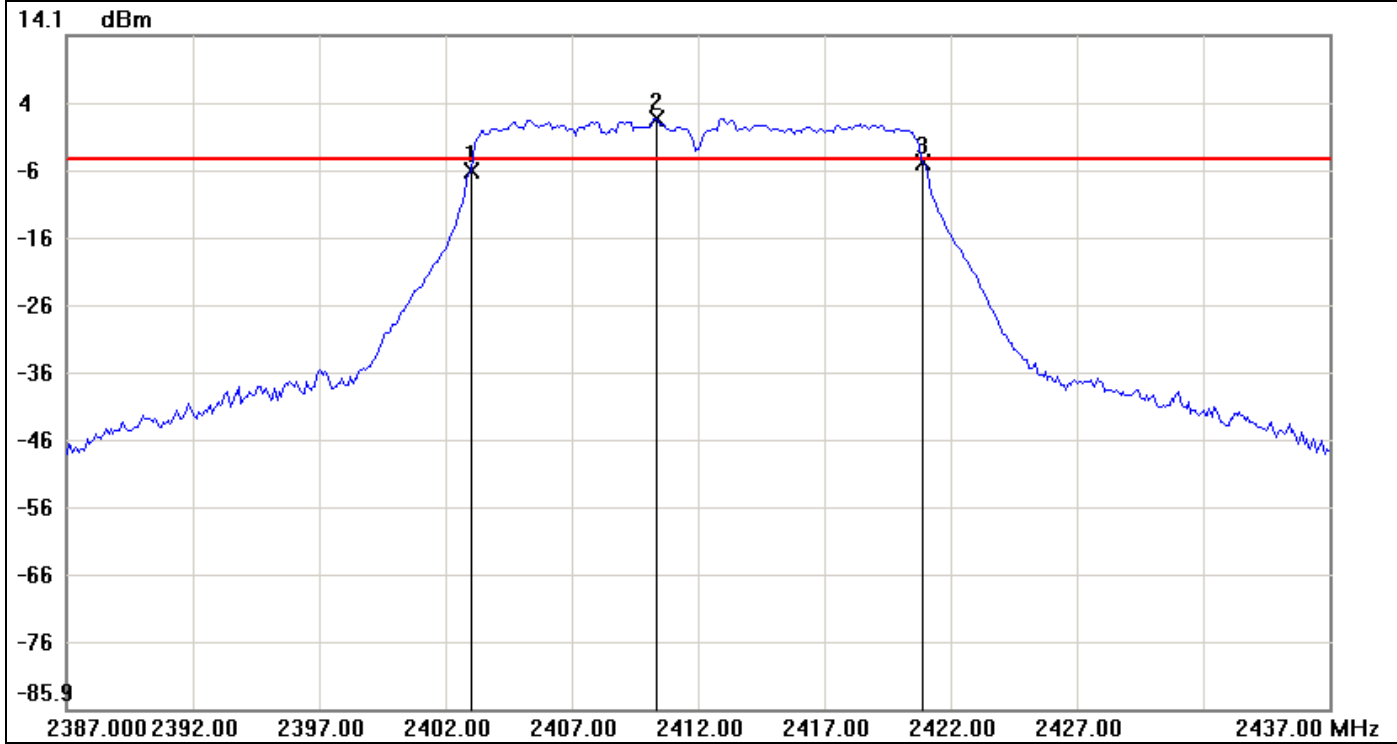

No.	Frequency(MHz)	Result(dBm)	Limit(dBm)	Margin(dBm)
1	2403.0000	-6.08	-4.24	-1.84
2	2410.3333	1.76	-4.24	6.00
3	2420.9167	-4.73	-4.24	-0.49

No.		$\Delta$ Frequency(MHz)	$\Delta$ Level(dB)
1	mk3-mk1	17.9167	1.35



### 6dB Bandwidth (CH Mid)

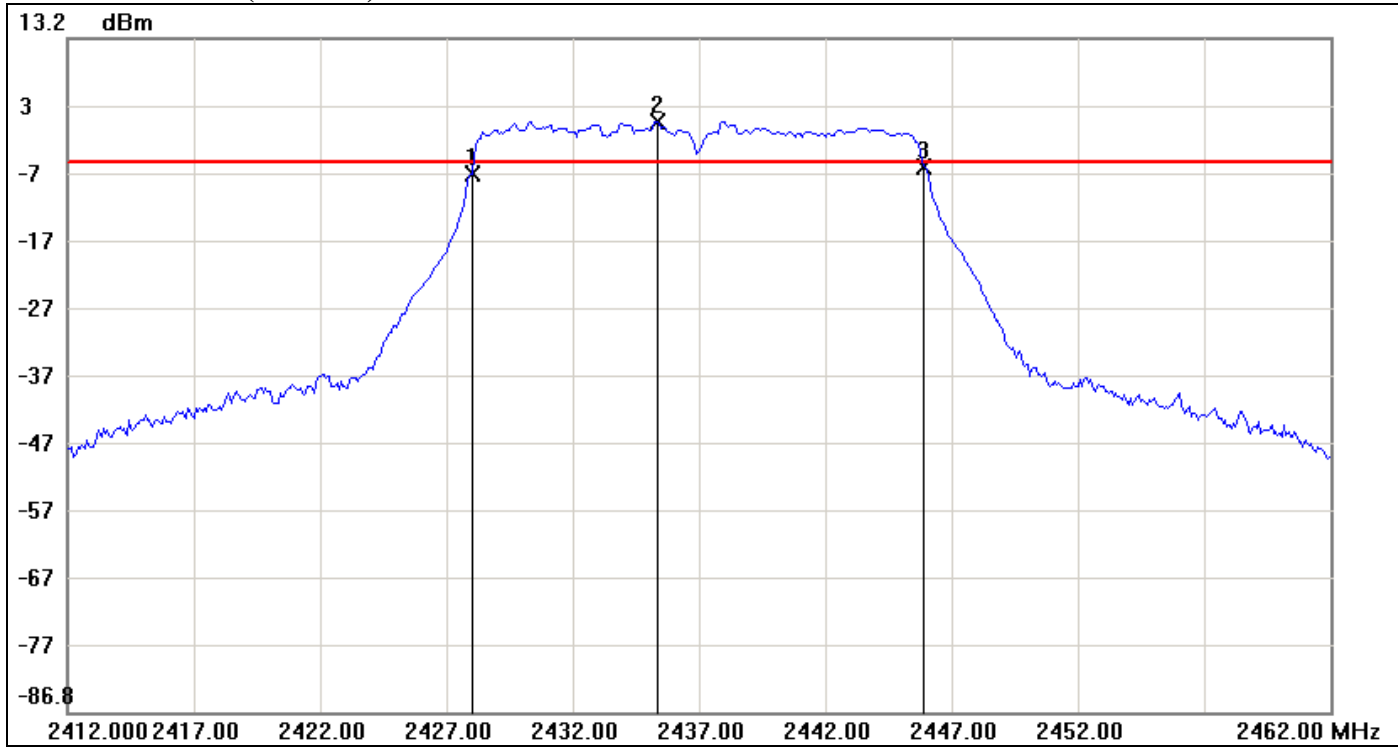

No.	Frequency(MHz)	Result(dBm)	Limit(dBm)	Margin(dBm)
1	2428.0000	-6.77	-5.09	-1.68
2	2435.3333	0.91	-5.09	6.00
3	2445.9167	-5.76	-5.09	-0.67

No.		$\Delta$ Frequency(MHz)	$\Delta$ Level(dB)
1	mk3-mk1	17.9167	1.01



**6dB Bandwidth (CH High)**

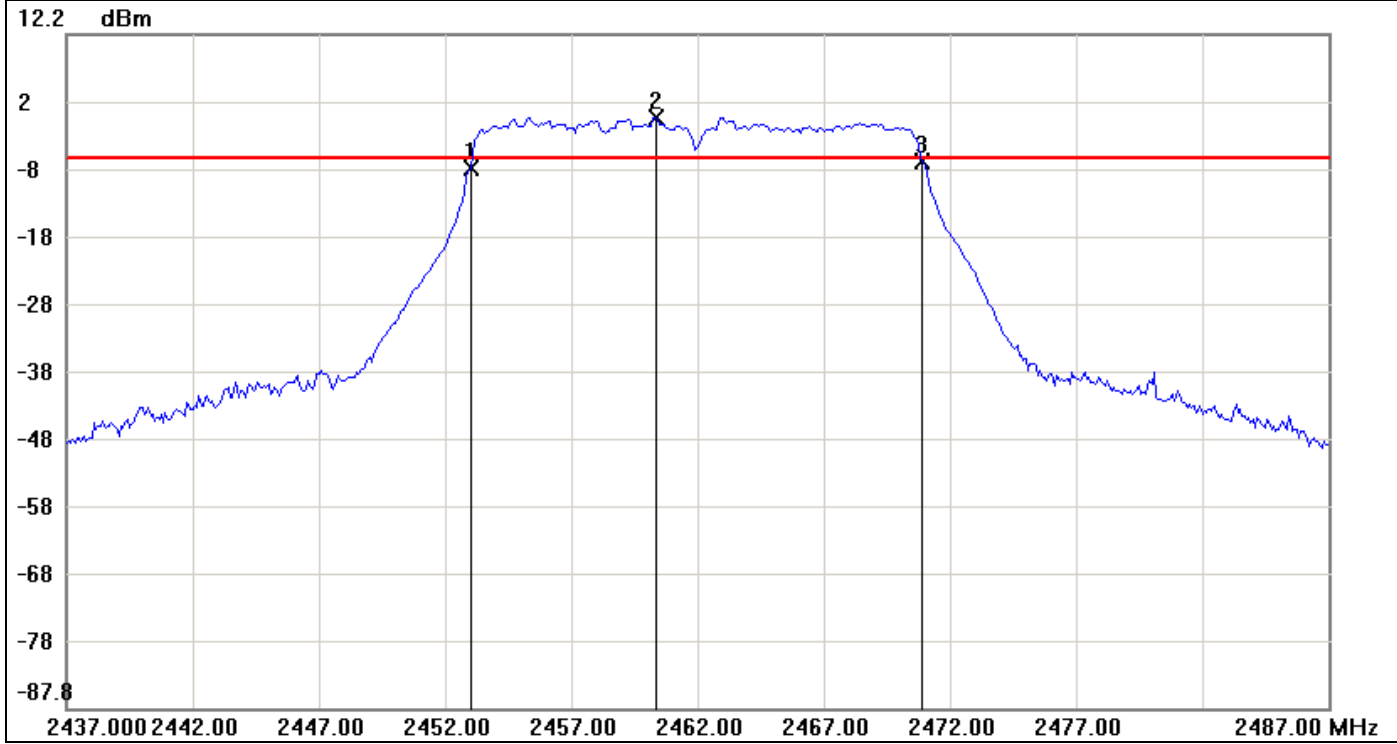

No.	Frequency(MHz)	Result(dBm)	Limit(dBm)	Margin(dBm)
1	2453.0000	-7.77	-6.18	-1.59
2	2460.3333	-0.18	-6.18	6.00
3	2470.9167	-6.61	-6.18	-0.43

No.		$\Delta$ Frequency(MHz)	$\Delta$ Level(dB)
1	mk3-mk1	17.9167	1.16





**IEEE 802.11n HT 20 MHz mode / Chain 1**

**6dB Bandwidth (CH Low)**

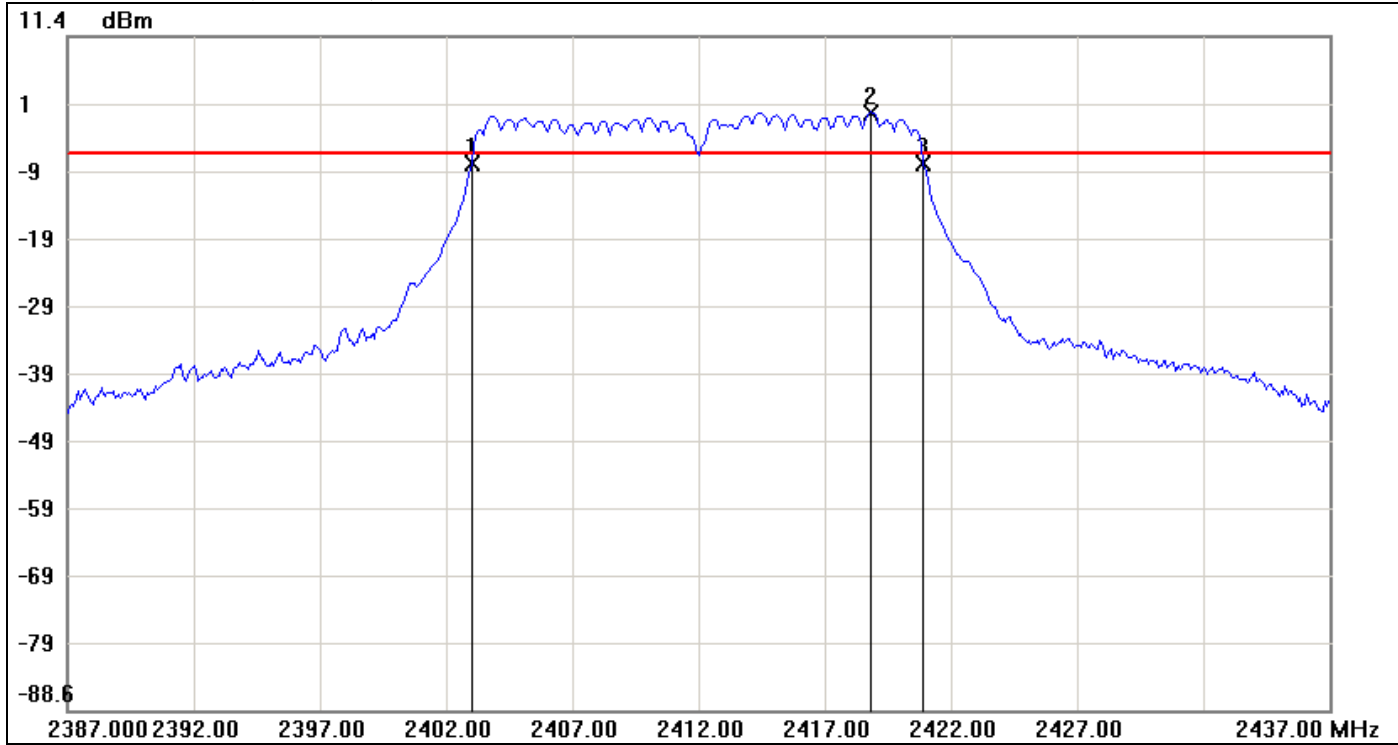

No.	Frequency(MHz)	Result(dBm)	Limit(dBm)	Margin(dBm)
1	2403.0000	-7.47	-5.81	-1.66
2	2418.8333	0.19	-5.81	6.00
3	2420.9167	-7.33	-5.81	-1.52

No.		$\Delta$ Frequency(MHz)	$\Delta$ Level(dB)
1	mk3-mk1	17.9167	0.14



**6dB Bandwidth (CH Mid)**

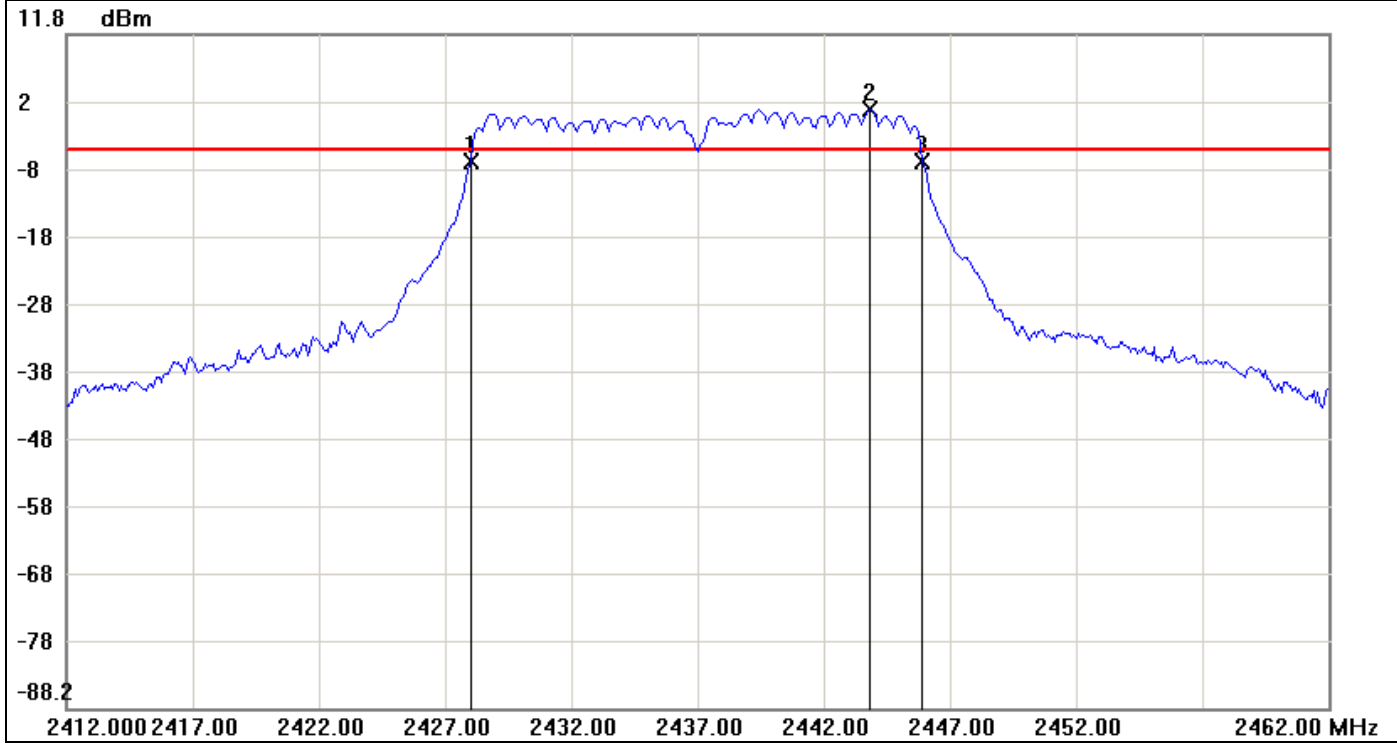

No.	Frequency(MHz)	Result(dBm)	Limit(dBm)	Margin(dBm)
1	2428.0000	-7.10	-5.43	-1.67
2	2443.8333	0.57	-5.43	6.00
3	2445.9167	-7.17	-5.43	-1.74

No.		$\Delta$ Frequency(MHz)	$\Delta$ Level(dB)
1	mk3-mk1	17.9167	-0.07



**6dB Bandwidth (CH High)**

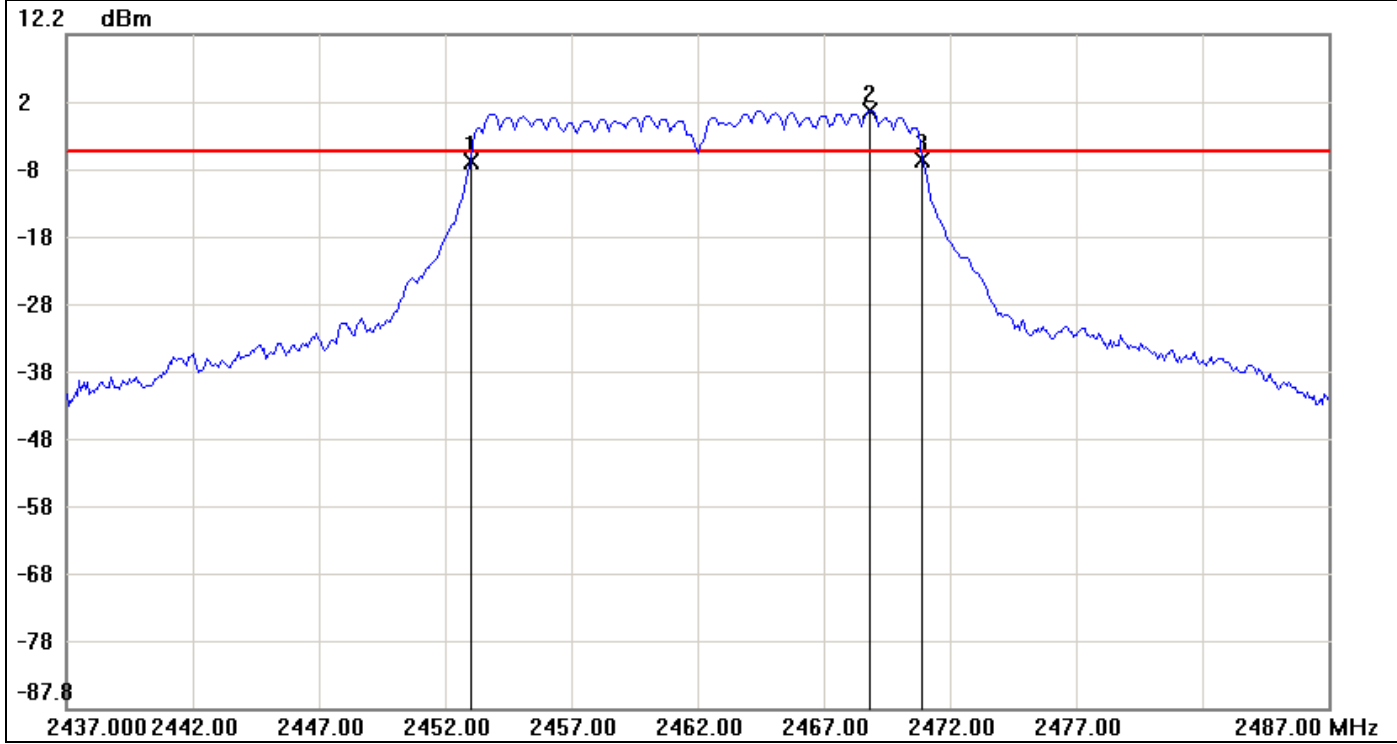

No.	Frequency(MHz)	Result(dBm)	Limit(dBm)	Margin(dBm)
1	2453.0000	-6.64	-5.08	-1.56
2	2468.8333	0.92	-5.08	6.00
3	2470.9167	-6.54	-5.08	-1.46

No.		$\Delta$ Frequency(MHz)	$\Delta$ Level(dB)
1	mk3-mk1	17.9167	0.1



**IEEE 802.11n HT 40 MHz mode / Chain 0**

**6dB Bandwidth (CH Low)**

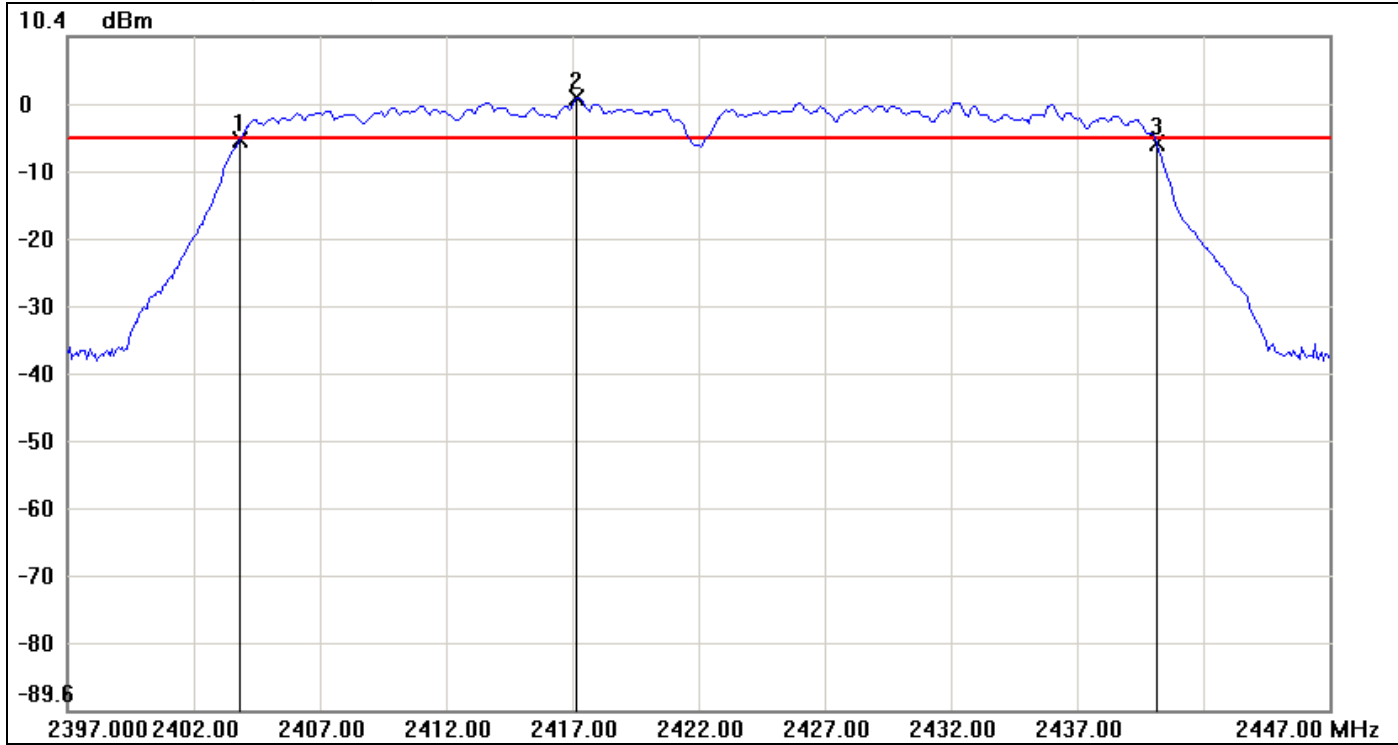

No.	Frequency(MHz)	Result(dBm)	Limit(dBm)	Margin(dBm)
1	2403.8333	-4.96	-4.77	-0.19
2	2417.1667	1.23	-4.77	6.00
3	2440.1667	-5.48	-4.77	-0.71

No.		$\Delta$ Frequency(MHz)	$\Delta$ Level(dB)
1	mk3-mk1	36.3334	-0.52



### 6dB Bandwidth (CH Mid)

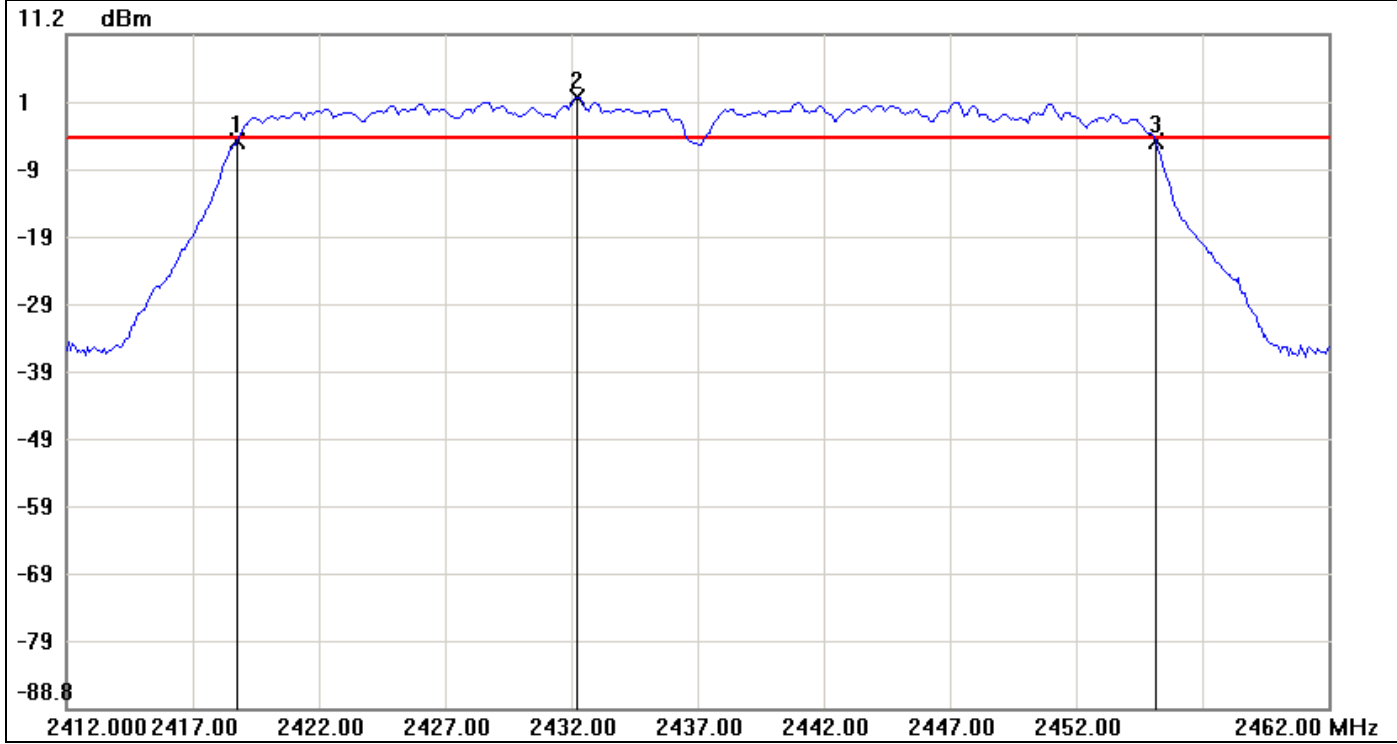

No.	Frequency(MHz)	Result(dBm)	Limit(dBm)	Margin(dBm)
1	2418.7500	-4.62	-4.18	-0.44
2	2432.2500	1.82	-4.18	6.00
3	2455.1667	-4.73	-4.18	-0.55

No.		$\Delta$ Frequency(MHz)	$\Delta$ Level(dB)
1	mk3-mk1	36.4167	-0.11



**6dB Bandwidth (CH High)**

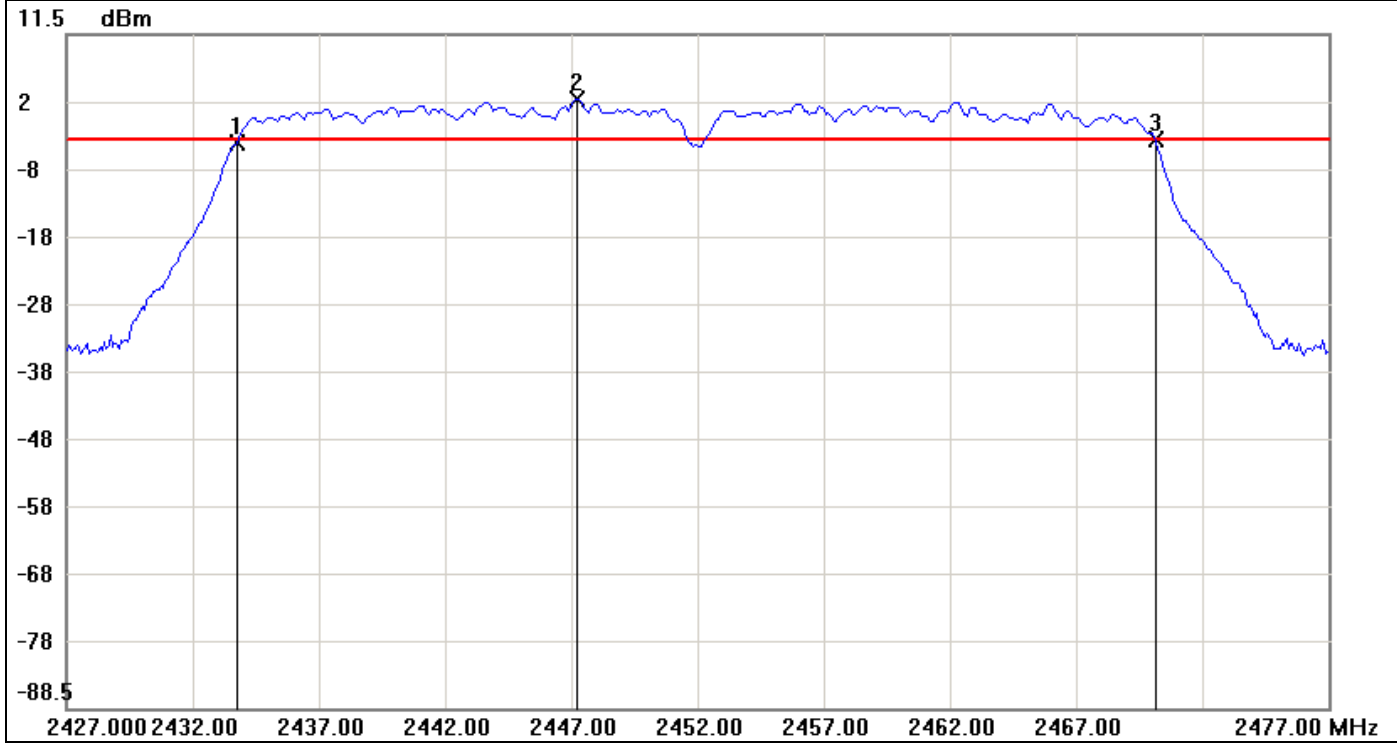

No.	Frequency(MHz)	Result(dBm)	Limit(dBm)	Margin(dBm)
1	2433.7500	-4.56	-3.99	-0.57
2	2447.2500	2.01	-3.99	6.00
3	2470.1667	-4.21	-3.99	-0.22

No.		$\Delta$ Frequency(MHz)	$\Delta$ Level(dB)
1	mk3-mk1	36.4167	0.35



**IEEE 802.11n HT 40 MHz mode / Chain 1**

**6dB Bandwidth (CH Low)**

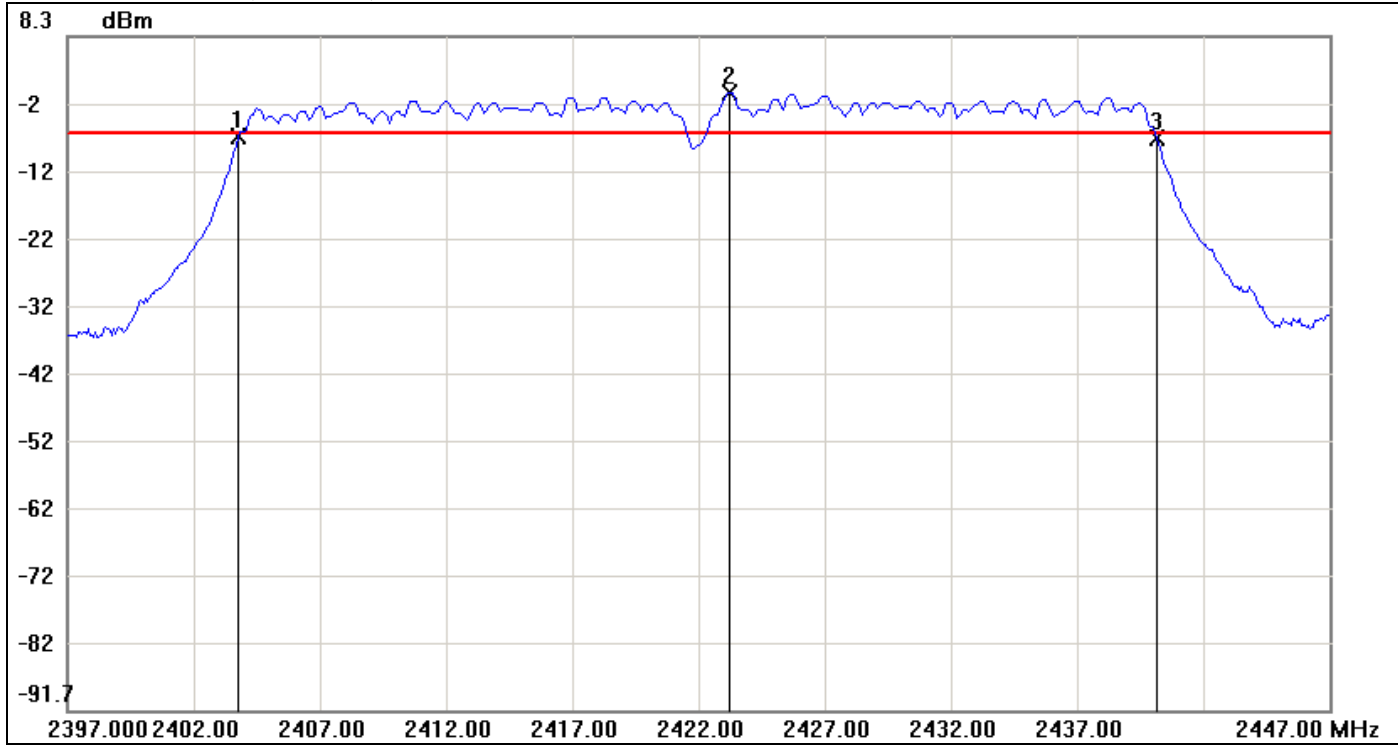

No.	Frequency(MHz)	Result(dBm)	Limit(dBm)	Margin(dBm)
1	2403.7500	-6.69	-6.10	-0.59
2	2423.2500	-0.10	-6.10	6.00
3	2440.1667	-6.80	-6.10	-0.70

No.		$\Delta$ Frequency(MHz)	$\Delta$ Level(dB)
1	mk3-mk1	36.4167	-0.11



### 6dB Bandwidth (CH Mid)

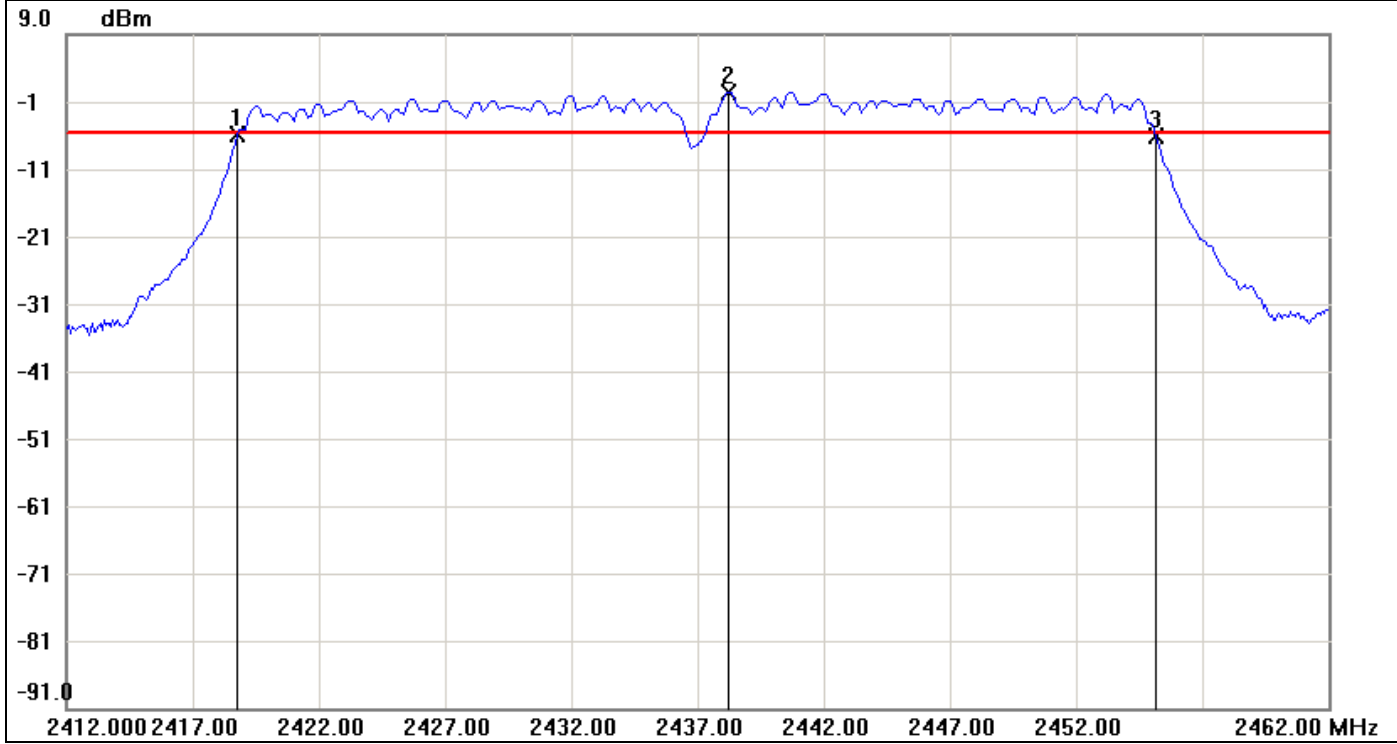

No.	Frequency(MHz)	Result(dBm)	Limit(dBm)	Margin(dBm)
1	2418.7500	-5.93	-5.52	-0.41
2	2438.2500	0.48	-5.52	6.00
3	2455.1667	-6.03	-5.52	-0.51

No.		$\Delta$ Frequency(MHz)	$\Delta$ Level(dB)
1	mk3-mk1	36.4167	-0.1





**6dB Bandwidth (CH High)**

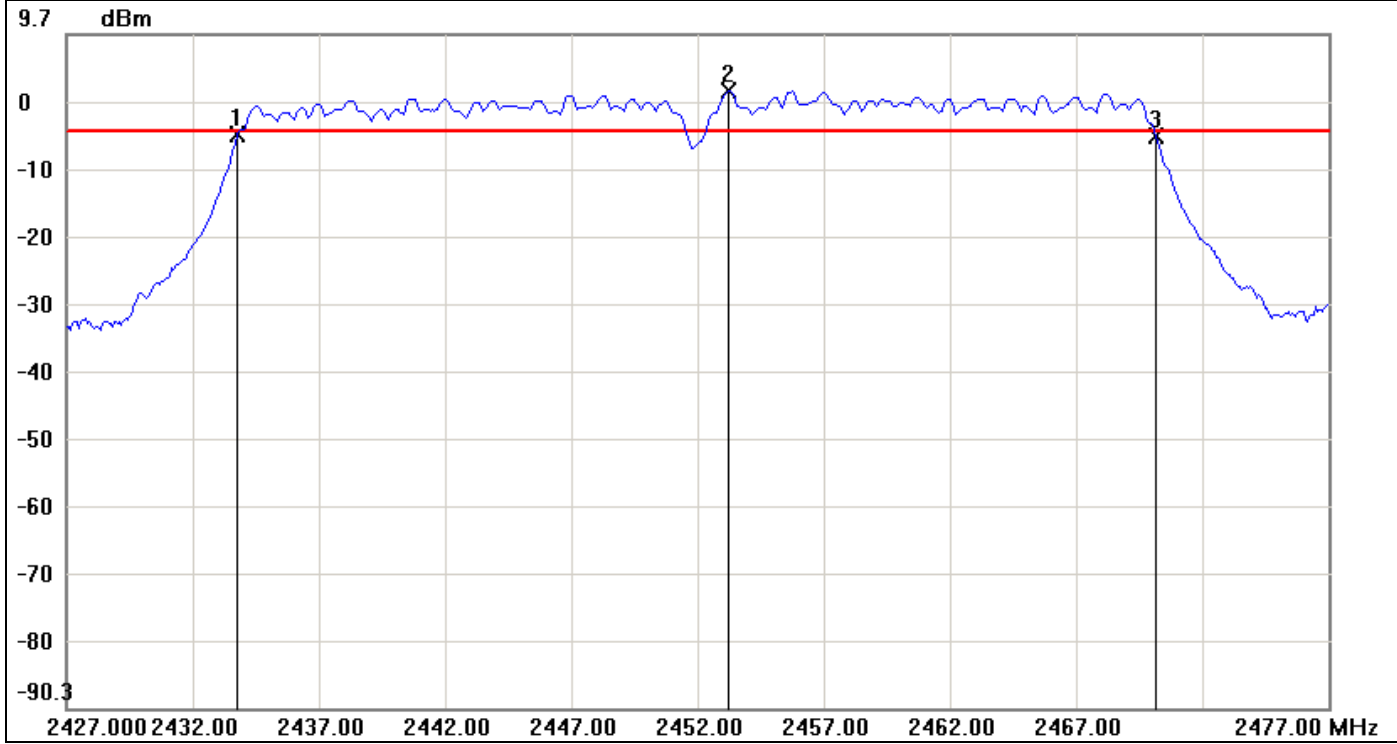

No.	Frequency(MHz)	Result(dBm)	Limit(dBm)	Margin(dBm)
1	2433.7500	-5.13	-4.73	-0.40
2	2453.2500	1.27	-4.73	6.00
3	2470.1667	-5.35	-4.73	-0.62

No.		$\Delta$ Frequency(MHz)	$\Delta$ Level(dB)
1	mk3-mk1	36.4167	-0.22



## **7.2 PEAK POWER**

### **LIMIT**

The maximum peak output power of the intentional radiator shall not exceed the following:

1. According to §15.247(b)(3), for systems using digital modulation in the bands of 902-928 MHz, 2400-2483.5 MHz, and 5725-5850 MHz: 1 Watt.
2. According to §15.247(b)(4), the conducted output power limit specified in paragraph (b) of this section is based on the use of antennas with directional gains that do not exceed 6 dBi. Except as shown in paragraph (c) of this section, if transmitting antennas of directional gain greater than 6 dBi are used, the conducted output power from the intentional radiator shall be reduced below the stated values in paragraphs (b)(1), (b)(2), and (b)(3) of this section, as appropriate, by the amount in dB that the directional gain of the antenna exceeds 6 dBi.

### **Test Configuration**

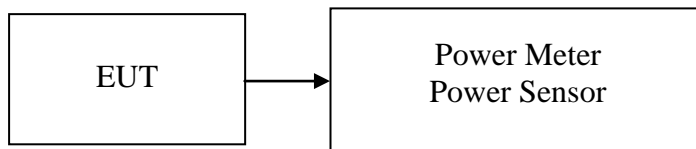

### **TEST PROCEDURE**

The transmitter output is connected to the Power Meter. The Power Meter is set to the peak power detection.



**Test Data**

**Test mode: IEEE 802.11b mode**

Channel	Frequency (MHz)	Output Power (dBm)	Output Power (W)	Limit (W)	Result
Low	2412	<b>27.58</b>	0.5728	1.00	PASS
Mid	2437	27.35	0.5433		PASS
High	2462	27.41	0.5508		PASS

**Test mode: IEEE 802.11g mode**

Channel	Frequency (MHz)	Output Power (dBm)	Output Power (W)	Limit (W)	Result
Low	2412	28.14	0.6516	1.00	PASS
Mid	2437	28.15	0.6531		PASS
High	2462	<b>28.18</b>	0.6577		PASS

**Test mode: IEEE 802.11n HT 20 MHz mode**

Channel	Frequency (MHz)	Chain 0 Output Power (dBm)	Chain 1 Output Power (dBm)	Total Output Power (dBm)	Output Power (W)	Limit (W)	Result
Low	2412	21.22	21.50	<b>24.37</b>	0.2735	1.00	PASS
Mid	2437	20.99	21.35	24.18	0.2618		PASS
High	2462	20.82	21.31	24.08	0.2559		PASS

**Test mode: IEEE 802.11n HT 40 MHz mode**

Channel	Frequency (MHz)	Chain 0 Output Power (dBm)	Chain 1 Output Power (dBm)	Total Output Power (dBm)	Output Power (W)	Limit (W)	Result
Low	2422	21.57	21.55	<b>24.57</b>	0.2864	1.00	PASS
Mid	2437	21.64	21.19	24.43	0.2773		PASS
High	2452	21.51	21.35	24.44	0.2780		PASS

**Remark:**

1. Total Output Power (w) = Chain 0 (10<sup>^(Output Power /10)</sup>/1000)+ Chain 1 (10<sup>^(Output Power /10)</sup>/1000)



### **7.3 AVERAGE POWER**

#### **LIMIT**

None; for reporting purposes only.

#### **Test Configuration**

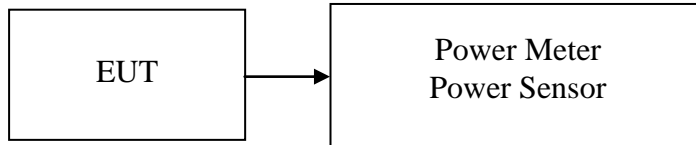

#### **TEST PROCEDURE**

The transmitter output is connected to the Power Meter. The Power Meter is set to the avg power detection.

#### **TEST RESULTS**

*No non-compliance noted.*



## Test Data

### Test mode: IEEE 802.11b mode

Channel	Frequency (MHz)	Output Power (dBm)	Output Power (W)
Low	2412	25.49	0.3656
Mid	2437	25.41	0.3420
High	2462	25.23	0.3334

### Test mode: IEEE 802.11g mode

Channel	Frequency (MHz)	Output Power (dBm)	Output Power (W)
Low	2412	18.32	0.0197
Mid	2437	18.21	0.0194
High	2462	18.23	0.0187

### Test mode: IEEE 802.11n HT 20 MHz mode

Channel	Frequency (MHz)	Chain 0 Output Power (dBm)	Chain 1 Output Power (dBm)	Total Output Power (dBm)	Output Power (W)
Low	2412	17.72	16.05	19.98	0.0325
Mid	2437	17.41	17.02	20.23	0.0312
High	2462	16.64	17.97	20.37	0.0305

### Test mode: IEEE 802.11n HT 40 MHz mode

Channel	Frequency (MHz)	Chain 0 Output Power (dBm)	Chain 1 Output Power (dBm)	Total Output Power (dBm)	Output Power (W)
Low	2422	17.27	15.76	19.59	0.0337
Mid	2437	17.19	16.25	19.76	0.0318
High	2452	17.14	16.63	19.90	0.0318

**Remark:** Total Output Power (w) = Chain 0 ( $10^{(Output Power / 10) / 1000}$ ) + Chain 1 ( $10^{(Output Power / 10) / 1000}$ )



## 7.4 BAND EDGES MEASUREMENT

### LIMIT

According to §15.247(d), in any 100 kHz bandwidth outside the frequency bands in which the spread spectrum intentional radiator is operating, the radio frequency power that is produced by the intentional radiator shall be at least 20 dB below that in the 100 kHz bandwidth within the band that contains the highest level of the desired power, based on either an RF conducted or a radiated measurement, provided the transmitter demonstrates compliance with the peak conducted power limits. In addition, radiated emissions which fall in the restricted bands, as defined in §15.205(a), must also comply with the radiated emission limits specified in 15.209(a) (see Section 15.205(c)).

### Test Configuration

#### For Radiated

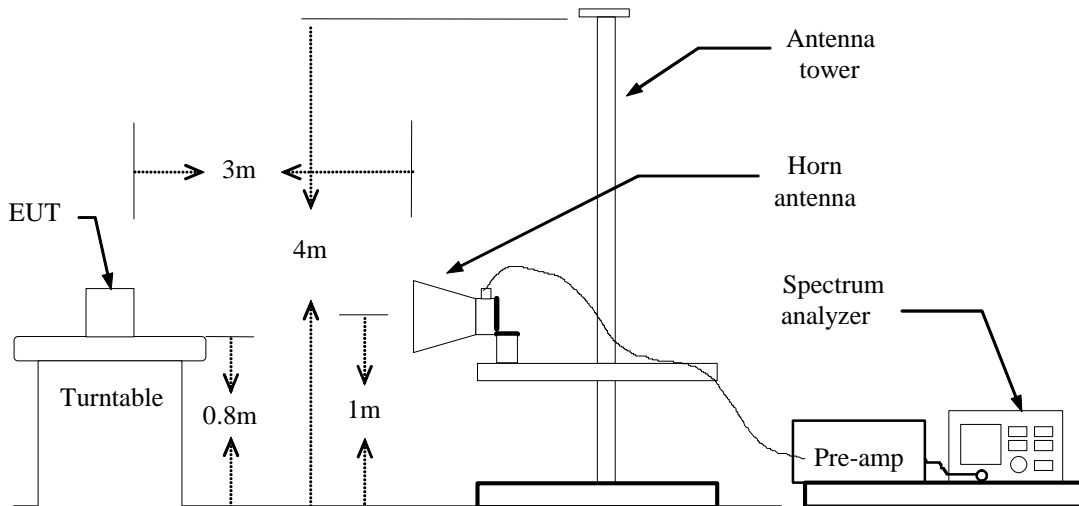

#### For Conducted

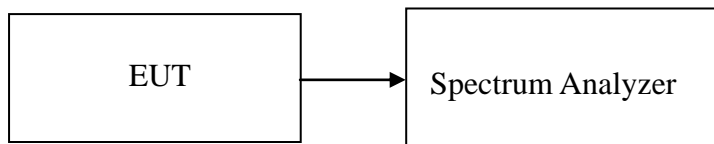



## **TEST PROCEDURE**

### **For Radiated**

1. The EUT is placed on a turntable, which is 0.8m above the ground plane.
2. The turntable shall be rotated for 360 degrees to determine the position of maximum emission level.
3. EUT is set 3m away from the receiving antenna, which is varied from 1m to 4m to find out the highest emission.
4. Set the spectrum analyzer in the following setting in order to capture the lower and upper band-edges of the emission:
  - (a) PEAK: RBW=VBW=1MHz / Sweep=AUTO
  - (b) AVERAGE: RBW=1MHz / VBW=10Hz / Sweep=AUTO
5. Repeat the procedures until all the PEAK and AVERAGE versus POLARIZATION are measured.

### **For Conducted**

Conducted RF measurements of the transmitter output were made to confirm that the EUT antenna port conducted emissions meet the specified limit and to identify any spurious signals that require further investigation or measurements on the radiated emissions site.

The transmitter output is connected to the spectrum analyzer. The resolution bandwidth is set to 100 kHz. The video bandwidth is set to 100 kHz.

## **TEST RESULTS**

Refer to attach spectrum analyzer data chart.



**Band Edges (IEEE 802.11b mode / CH Low)**

**Polarity: Vertical**

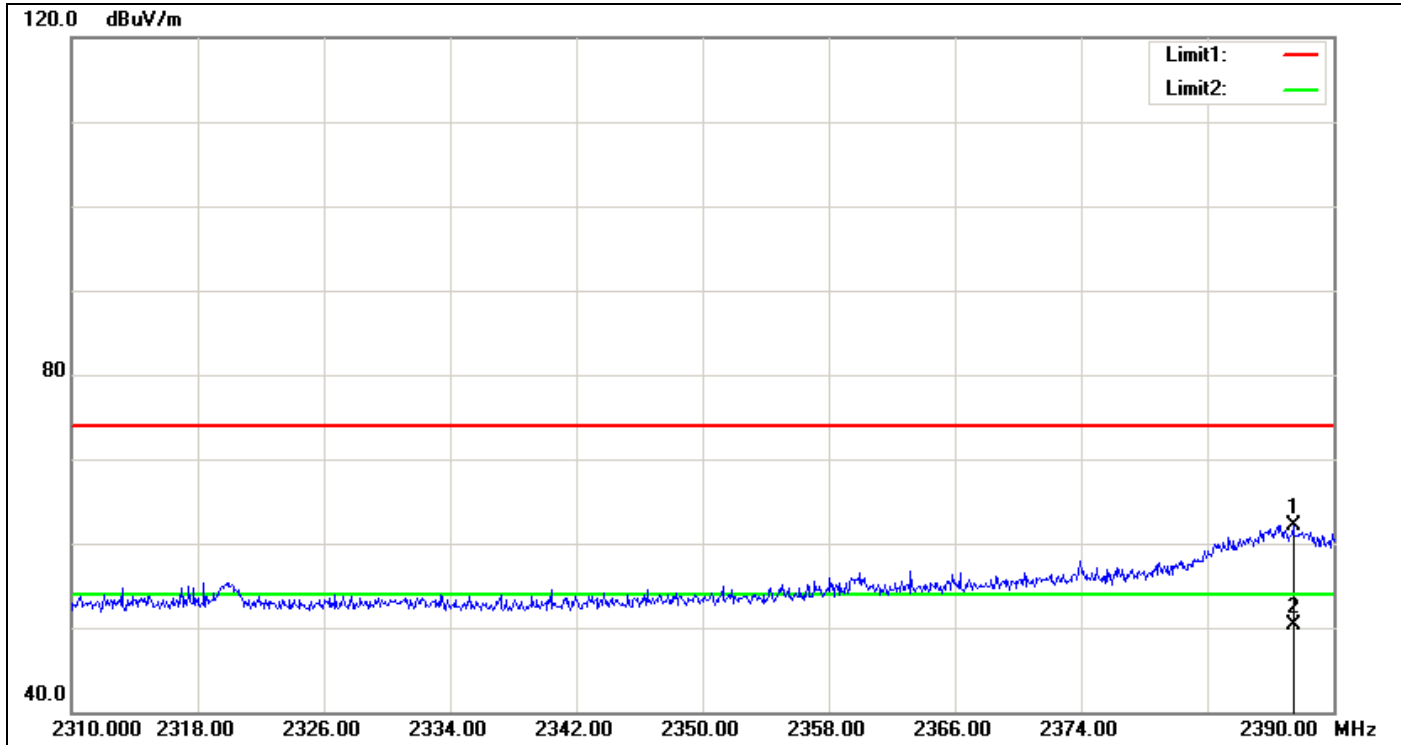

No.	Frequency (MHz)	Reading (dBuV)	Correct Factor(dB/m)	Result (dBuV/m)	Limit (dBuV/m)	Margin (dB)	Height (cm)	Degree (°)	Remark
1	2387.440	63.27	-1.08	62.19	74.00	-11.81	100	297	peak
2	2387.440	51.44	-1.08	50.36	54.00	-3.64	100	297	AVG





**Polarity: Horizontal**

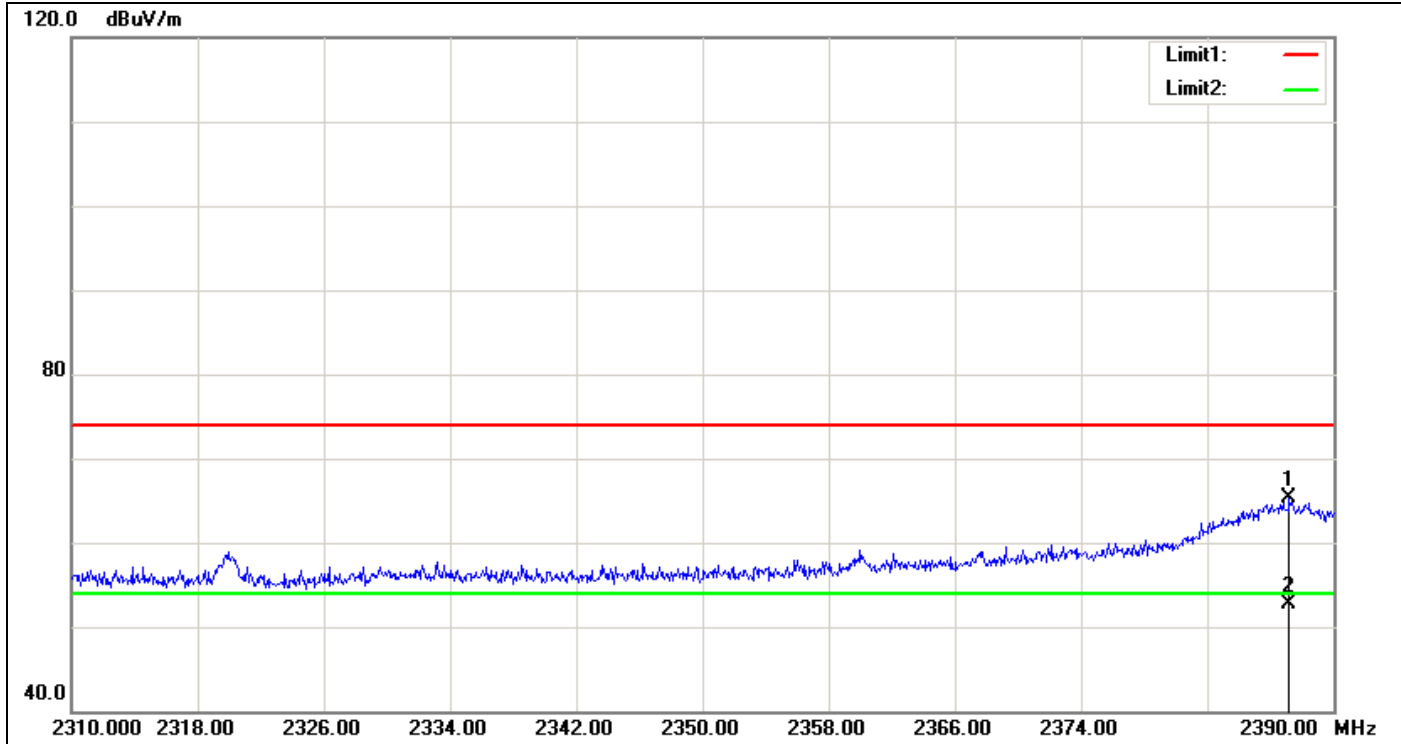

No.	Frequency (MHz)	Reading (dBuV)	Correct Factor(dB/m)	Result (dBuV/m)	Limit (dBuV/m)	Margin (dB)	Height (cm)	Degree (°)	Remark
1	2387.200	66.42	-1.08	65.34	74.00	-8.66	100	300	peak
2	2387.200	53.82	-1.08	52.74	54.00	-1.26	100	300	AVG



**Band Edges (IEEE 802.11b mode / CH High)**

**Polarity: Vertical**

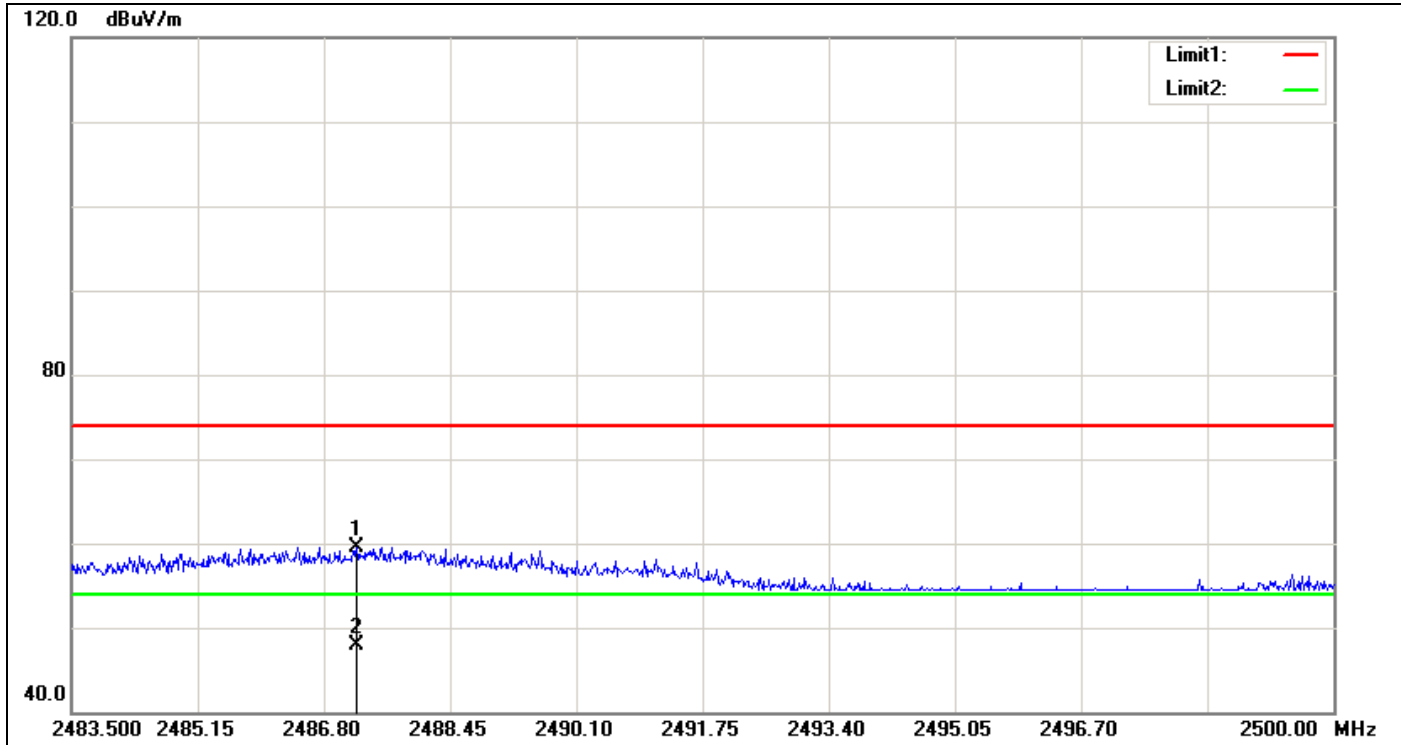

No.	Frequency (MHz)	Reading (dBuV)	Correct Factor(dB/m)	Result (dBuV/m)	Limit (dBuV/m)	Margin (dB)	Height (cm)	Degree (°)	Remark
1	2487.229	60.02	-0.43	59.59	74.00	-14.41	100	3	peak
2	2487.229	48.24	-0.43	47.81	54.00	-6.19	100	3	AVG



**Polarity: Horizontal**

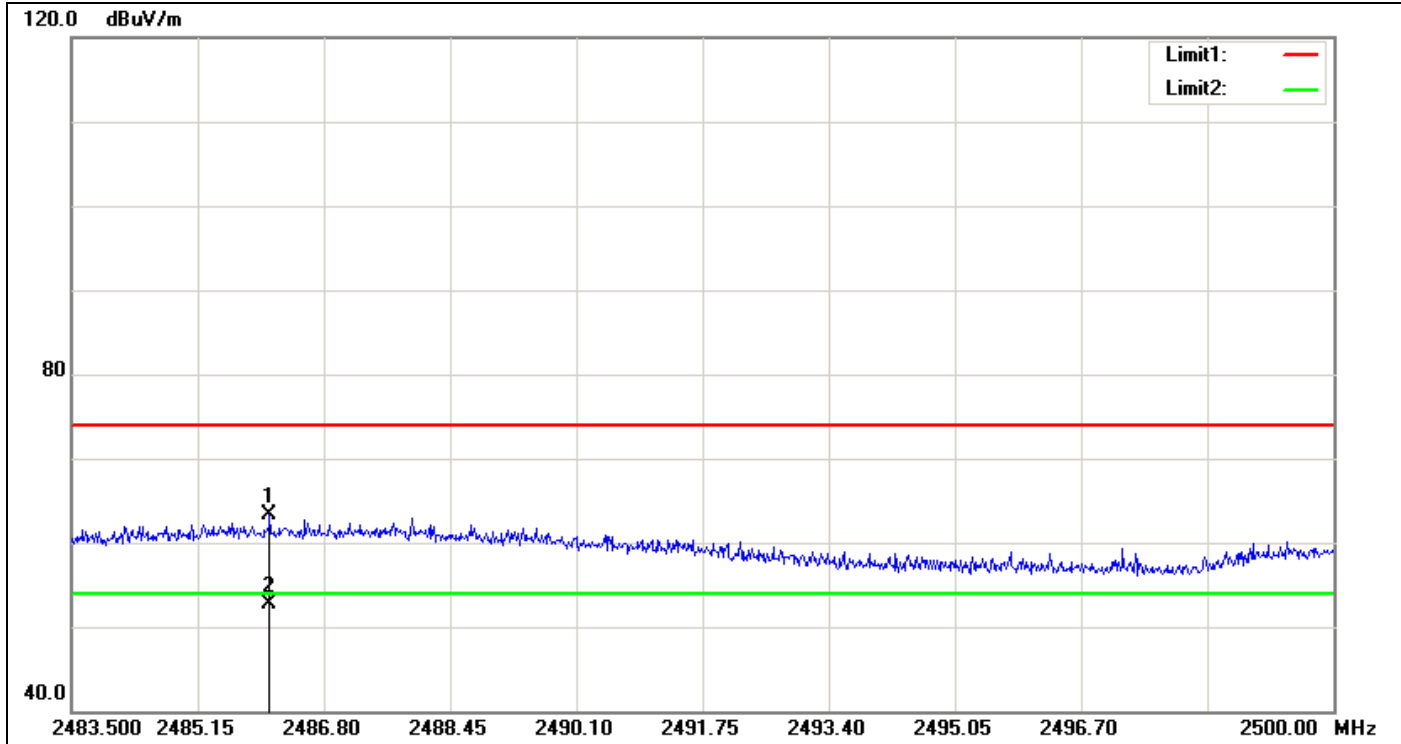

No.	Frequency (MHz)	Reading (dBuV)	Correct Factor(dB/m)	Result (dBuV/m)	Limit (dBuV/m)	Margin (dB)	Height (cm)	Degree (°)	Remark
1	2486.090	63.70	-0.44	63.26	74.00	-10.74	100	324	peak
2	2486.090	53.19	-0.44	52.75	54.00	-1.25	100	324	AVG



**Band Edges (IEEE 802.11g mode / CH Low)**

**Polarity: Vertical**

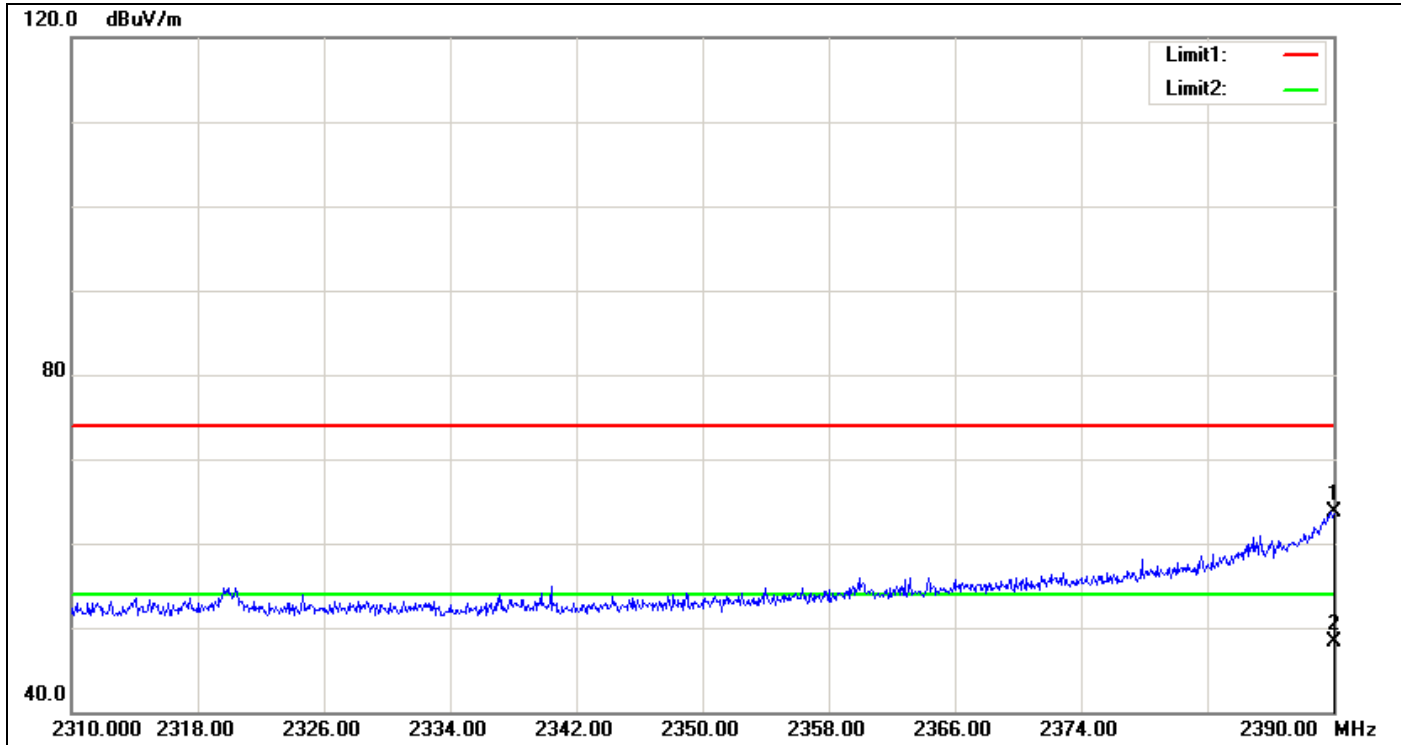

No.	Frequency (MHz)	Reading (dBuV)	Correct Factor(dB/m)	Result (dBuV/m)	Limit (dBuV/m)	Margin (dB)	Height (cm)	Degree (°)	Remark
1	2390.000	64.72	-1.05	63.67	74.00	-10.33	100	65	peak
2	2390.000	49.26	-1.05	48.21	54.00	-5.79	100	65	AVG



**Polarity: Horizontal**

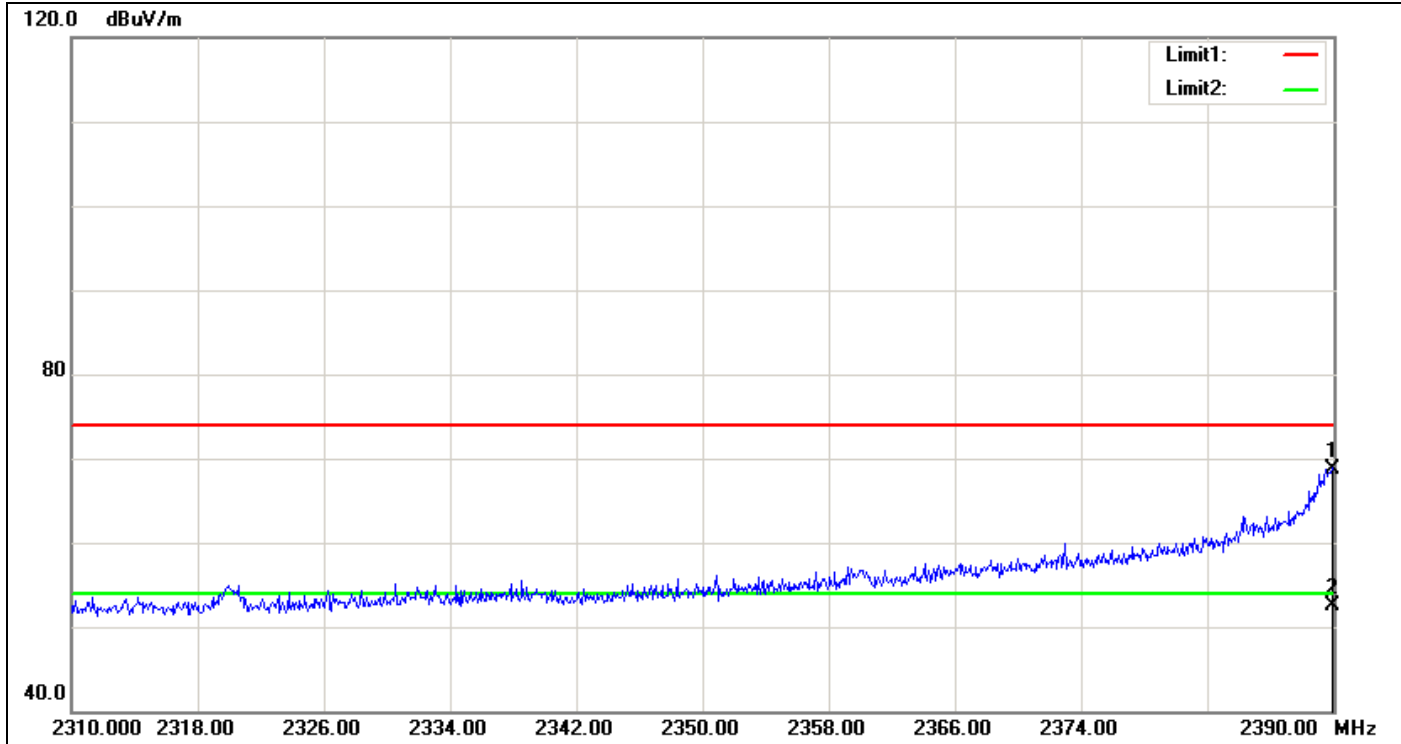

No.	Frequency (MHz)	Reading (dBuV)	Correct Factor(dB/m)	Result (dBuV/m)	Limit (dBuV/m)	Margin (dB)	Height (cm)	Degree ( ° )	Remark
1	2389.920	69.85	-1.05	68.80	74.00	-5.20	100	354	peak
2	2389.920	53.50	-1.05	52.45	54.00	-1.55	100	354	AVG



**Band Edges (IEEE 802.11g mode / CH High)**

**Polarity: Vertical**

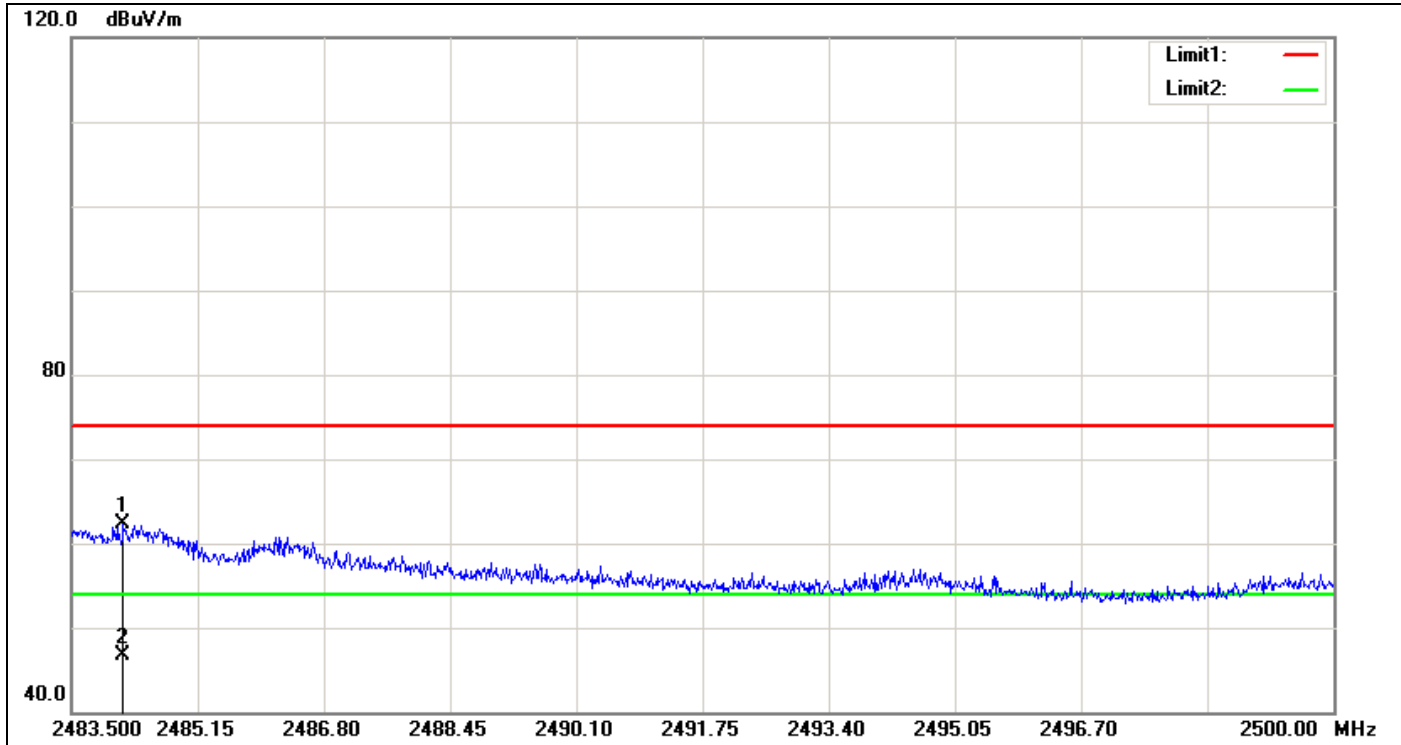

No.	Frequency (MHz)	Reading (dBuV)	Correct Factor(dB/m)	Result (dBuV/m)	Limit (dBuV/m)	Margin (dB)	Height (cm)	Degree (°)	Remark
1	2484.177	62.68	-0.46	62.22	74.00	-11.78	100	87	peak
2	2484.177	47.18	-0.46	46.72	54.00	-7.28	100	87	AVG



**Polarity: Horizontal**

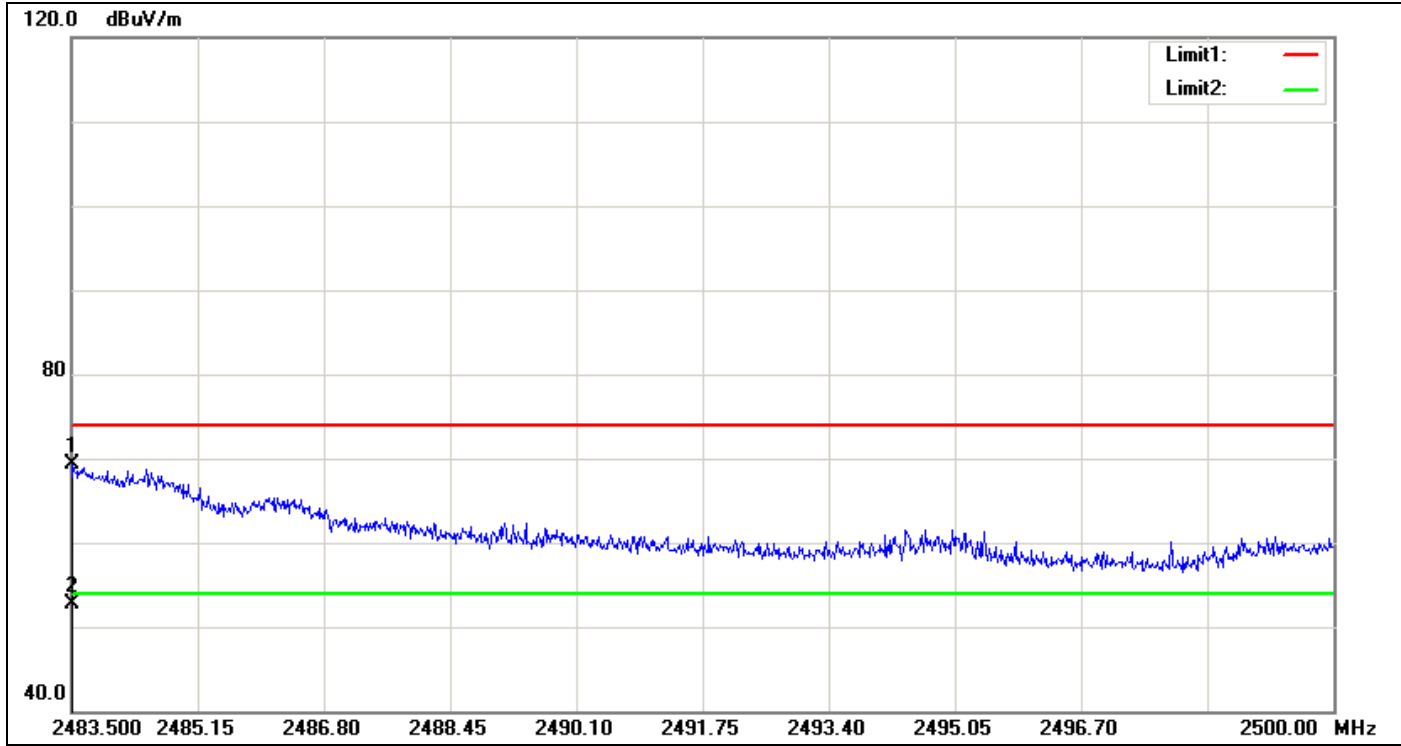

No.	Frequency (MHz)	Reading (dBuV)	Correct Factor(dB/m)	Result (dBuV/m)	Limit (dBuV/m)	Margin (dB)	Height (cm)	Degree ( ° )	Remark
1	2483.517	69.78	-0.47	69.31	74.00	-4.69	100	89	peak
2	2483.517	53.22	-0.47	52.75	54.00	-1.25	100	89	AVG



**Band Edges (IEEE 802.11n HT 20 MHz mode / CH Low)**

**Polarity: Vertical**

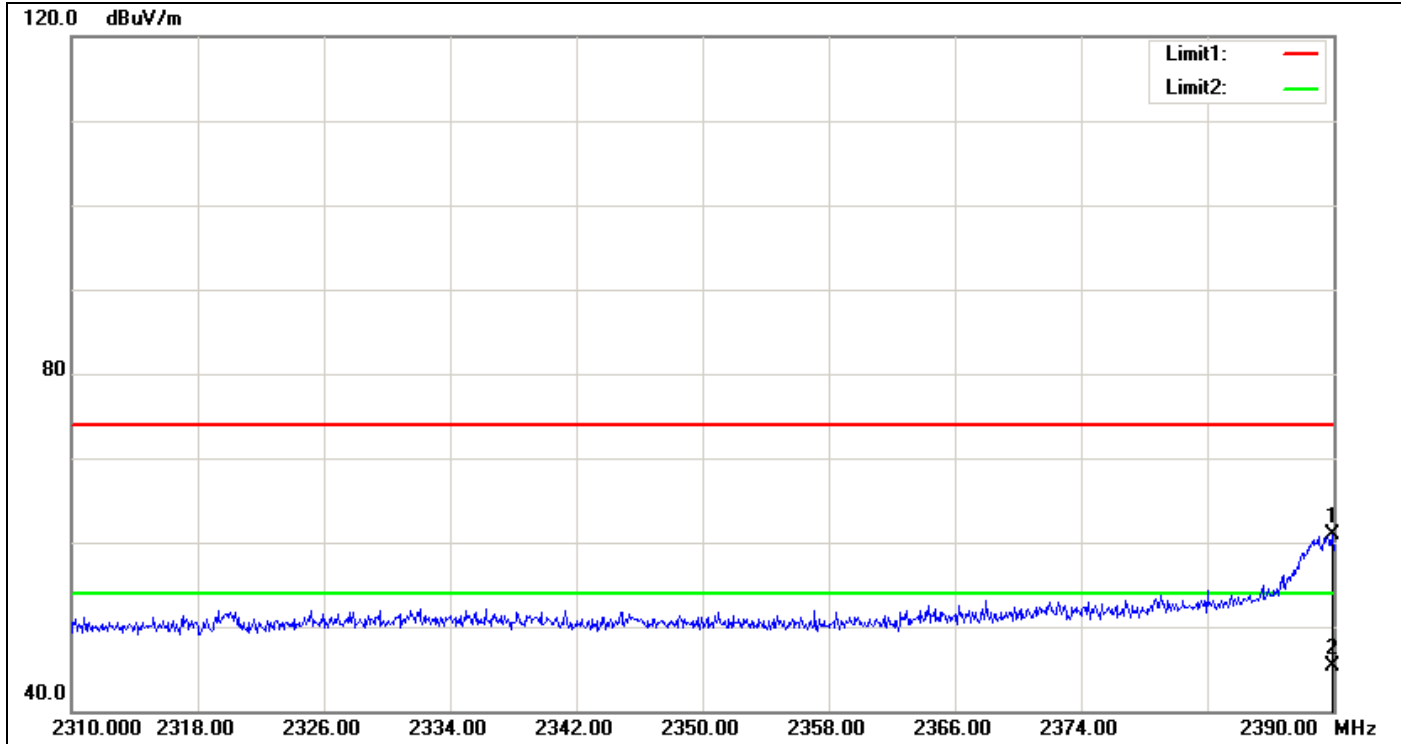

No.	Frequency (MHz)	Reading (dBuV)	Correct Factor(dB/m)	Result (dBuV/m)	Limit (dBuV/m)	Margin (dB)	Height (cm)	Degree (°)	Remark
1	2389.920	61.95	-1.05	60.90	74.00	-13.10	100	353	peak
2	2389.920	46.37	-1.05	45.32	54.00	-8.68	100	353	AVG





**Polarity: Horizontal**

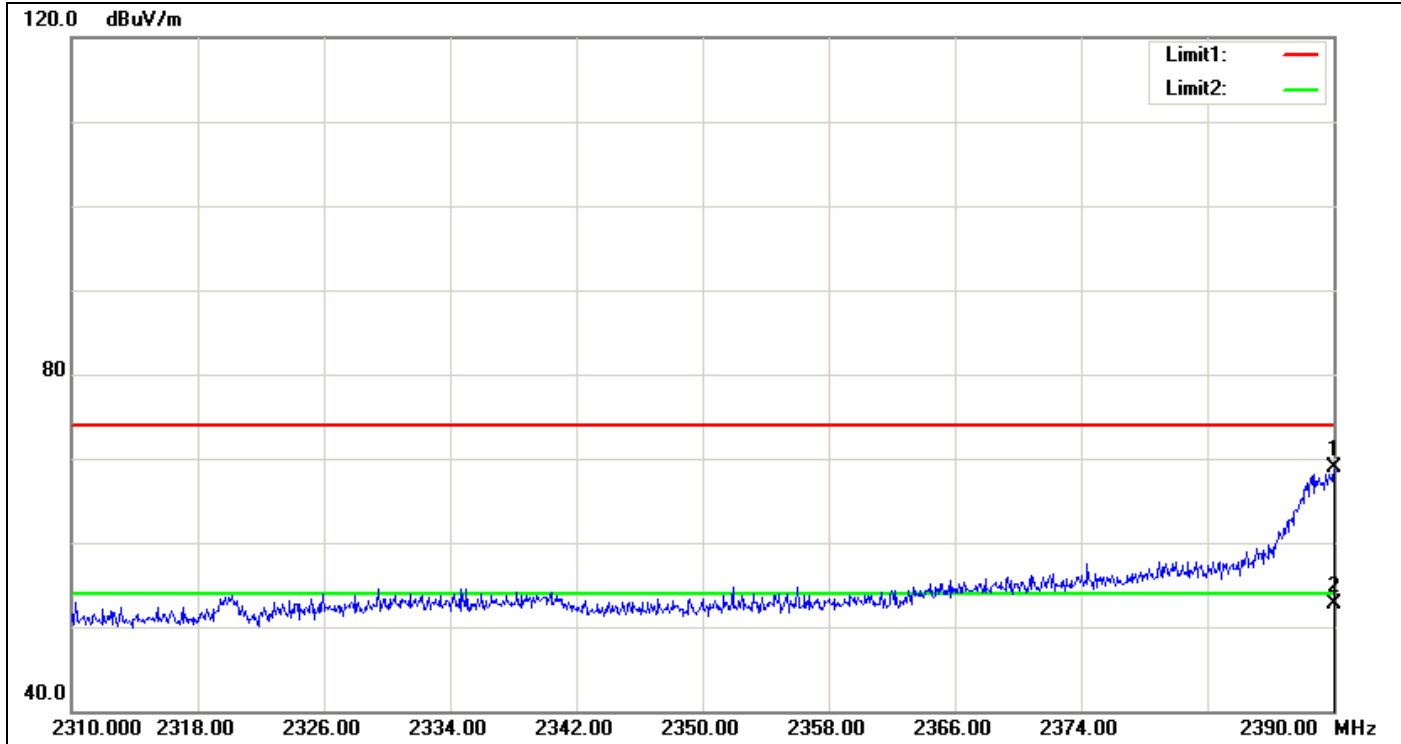

No.	Frequency (MHz)	Reading (dBuV)	Correct Factor(dB/m)	Result (dBuV/m)	Limit (dBuV/m)	Margin (dB)	Height (cm)	Degree ( ° )	Remark
1	2390.000	69.91	-1.05	68.86	74.00	-5.14	100	28	peak
2	2390.000	53.81	-1.05	52.76	54.00	-1.24	100	28	AVG



**Band Edges (IEEE 802.11n HT 20 MHz mode / CH High)**

**Polarity: Vertical**

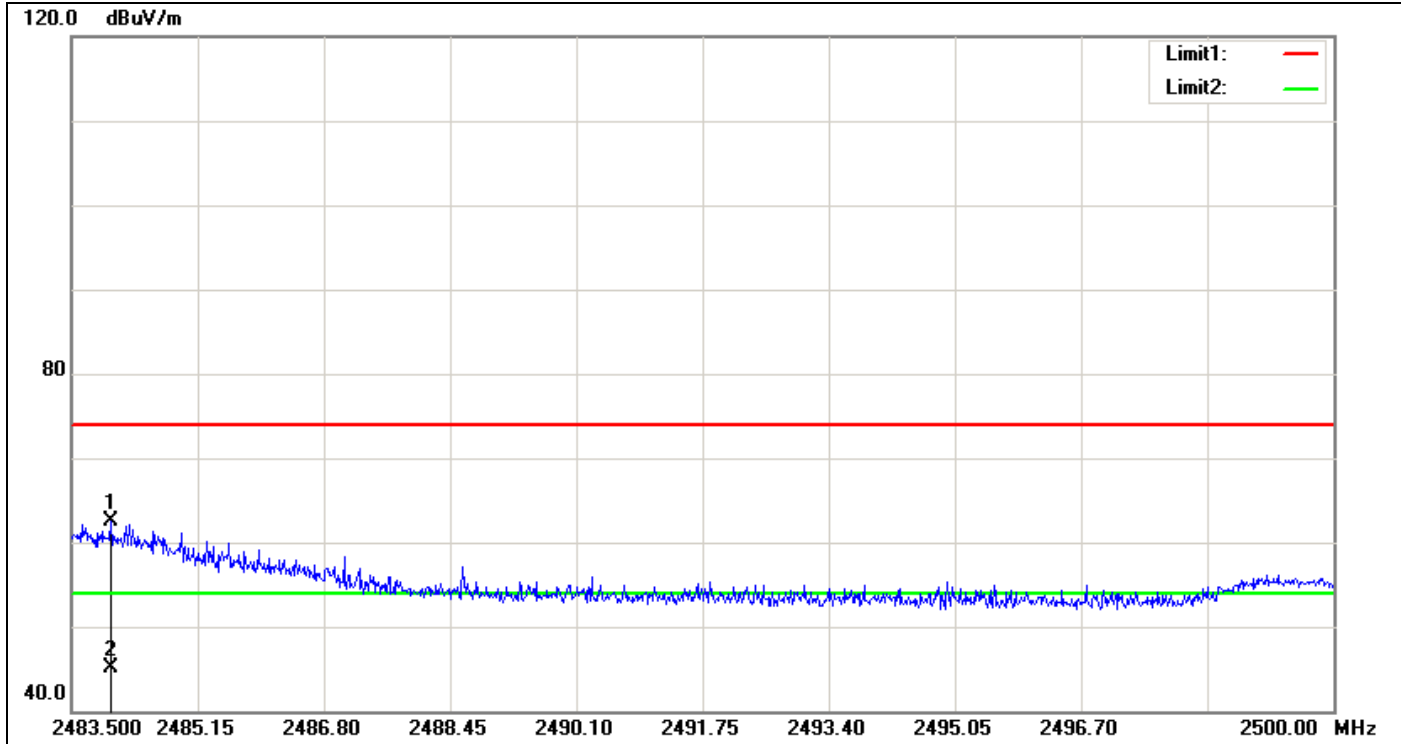

No.	Frequency (MHz)	Reading (dBuV)	Correct Factor(dB/m)	Result (dBuV/m)	Limit (dBuV/m)	Margin (dB)	Height (cm)	Degree (°)	Remark
1	2484.012	62.89	-0.47	62.42	74.00	-11.58	100	114	peak
2	2484.012	45.48	-0.47	45.01	54.00	-8.99	100	114	AVG



**Polarity: Horizontal**

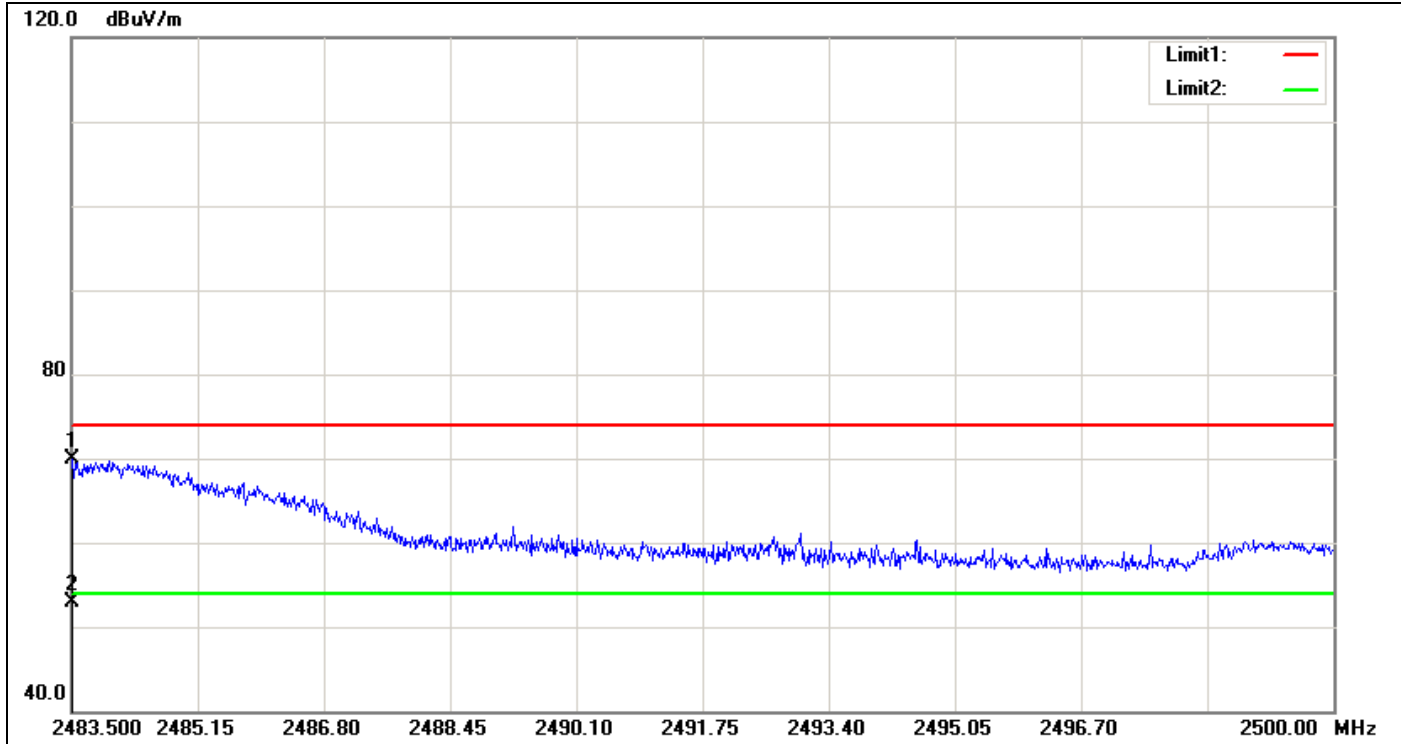

No.	Frequency (MHz)	Reading (dBuV)	Correct Factor(dB/m)	Result (dBuV/m)	Limit (dBuV/m)	Margin (dB)	Height (cm)	Degree ( ° )	Remark
1	2483.517	70.28	-0.47	69.81	74.00	-4.19	100	173	peak
2	2483.517	53.42	-0.47	52.95	54.00	-1.05	100	173	AVG



**Band Edges (IEEE 802.11n HT 40 MHz mode / CH Low)**

**Polarity: Vertical**

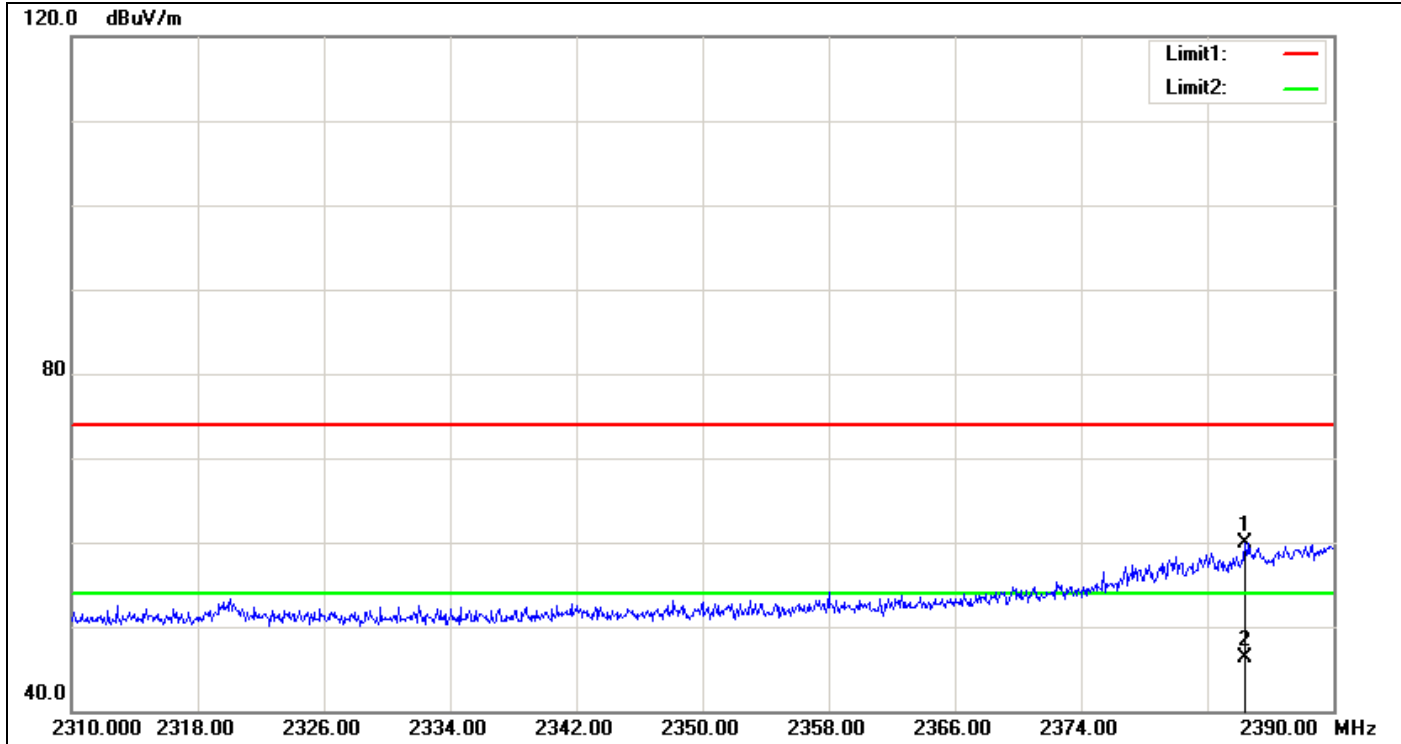

No.	Frequency (MHz)	Reading (dBuV)	Correct Factor(dB/m)	Result (dBuV/m)	Limit (dBuV/m)	Margin (dB)	Height (cm)	Degree (°)	Remark
1	2384.400	61.05	-1.11	59.94	74.00	-14.06	100	137	peak
2	2384.400	47.51	-1.11	46.40	54.00	-7.60	100	137	AVG



**Polarity: Horizontal**

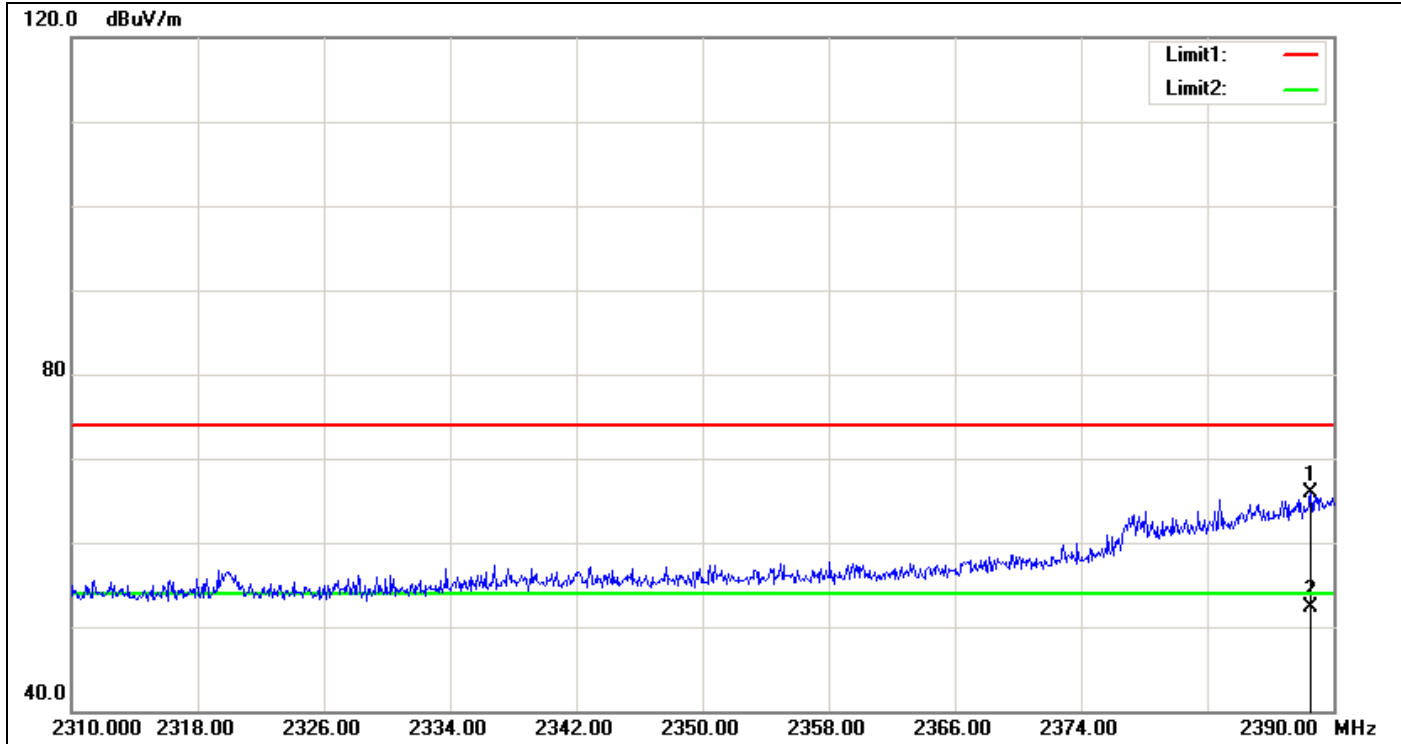

No.	Frequency (MHz)	Reading (dBuV)	Correct Factor(dB/m)	Result (dBuV/m)	Limit (dBuV/m)	Margin (dB)	Height (cm)	Degree ( ° )	Remark
1	2388.560	67.01	-1.06	65.95	74.00	-8.05	100	162	peak
2	2388.560	53.41	-1.06	52.35	54.00	-1.65	100	162	AVG



**Band Edges (IEEE 802.11n HT 40 MHz mode / CH High)**

**Polarity: Vertical**

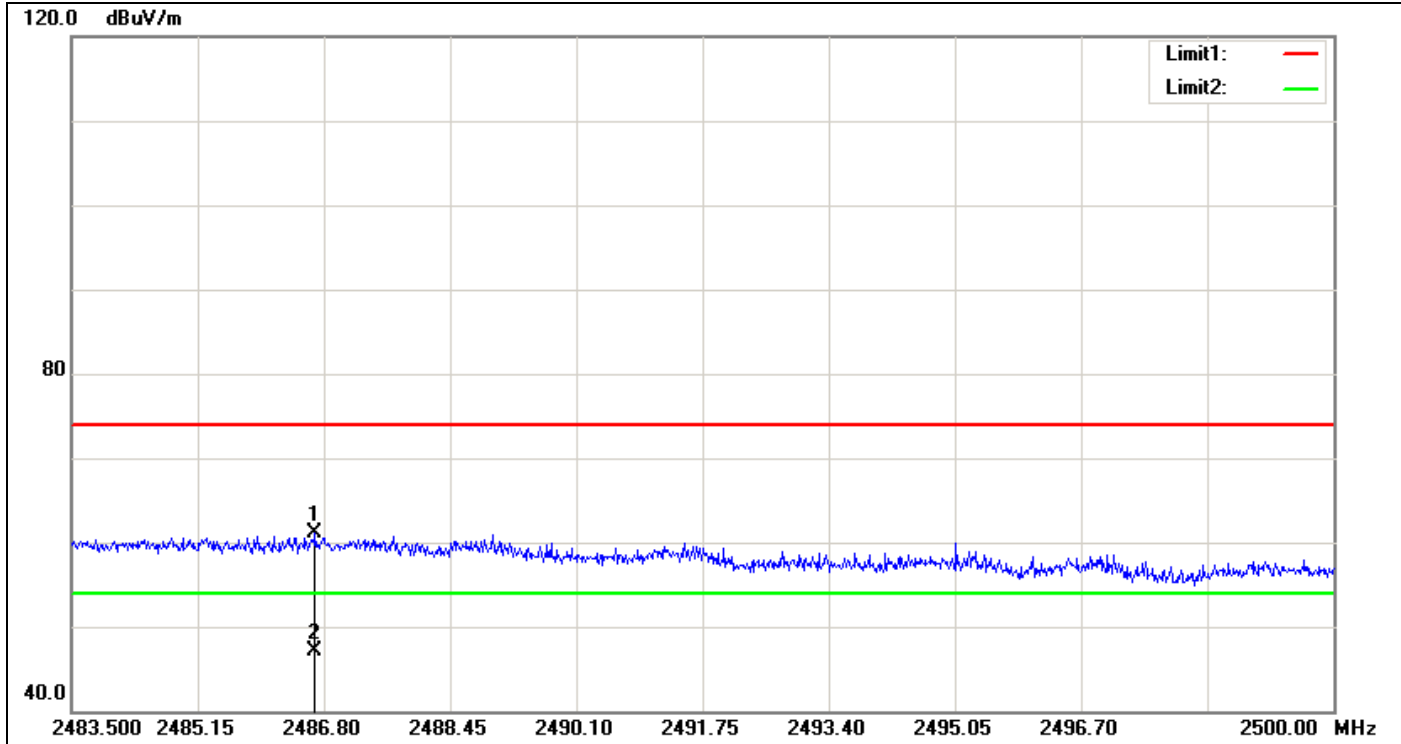

No.	Frequency (MHz)	Reading (dBuV)	Correct Factor(dB/m)	Result (dBuV/m)	Limit (dBuV/m)	Margin (dB)	Height (cm)	Degree (°)	Remark
1	2486.684	61.48	-0.44	61.04	74.00	-12.96	100	222	peak
2	2486.684	47.63	-0.44	47.19	54.00	-6.81	100	222	AVG



**Polarity: Horizontal**

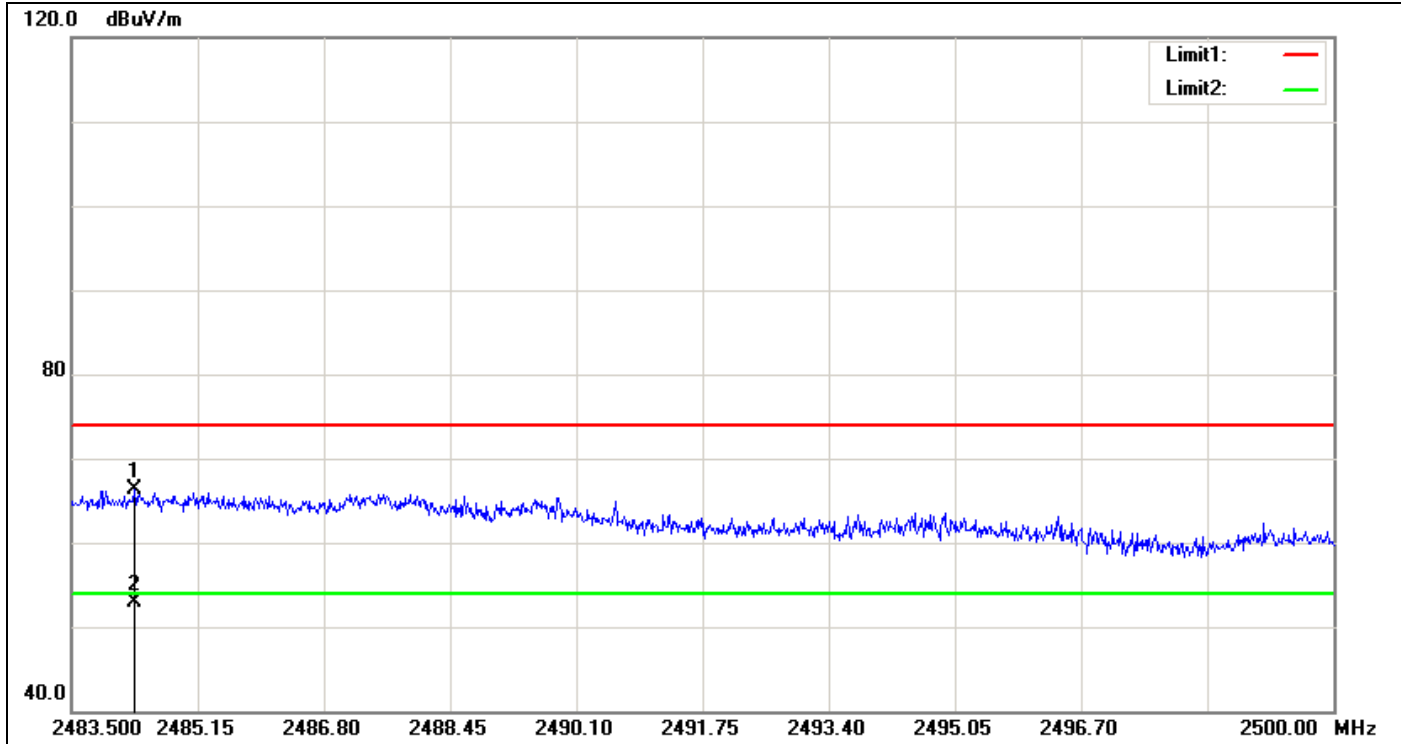

No.	Frequency (MHz)	Reading (dBuV)	Correct Factor(dB/m)	Result (dBuV/m)	Limit (dBuV/m)	Margin (dB)	Height (cm)	Degree ( ° )	Remark
1	2484.325	66.82	-0.46	66.36	74.00	-7.64	100	344	peak
2	2484.325	53.32	-0.46	52.86	54.00	-1.14	100	344	AVG



### Test Plot

#### Conducted Band Edges (IEEE 802.11b mode / CH Low)

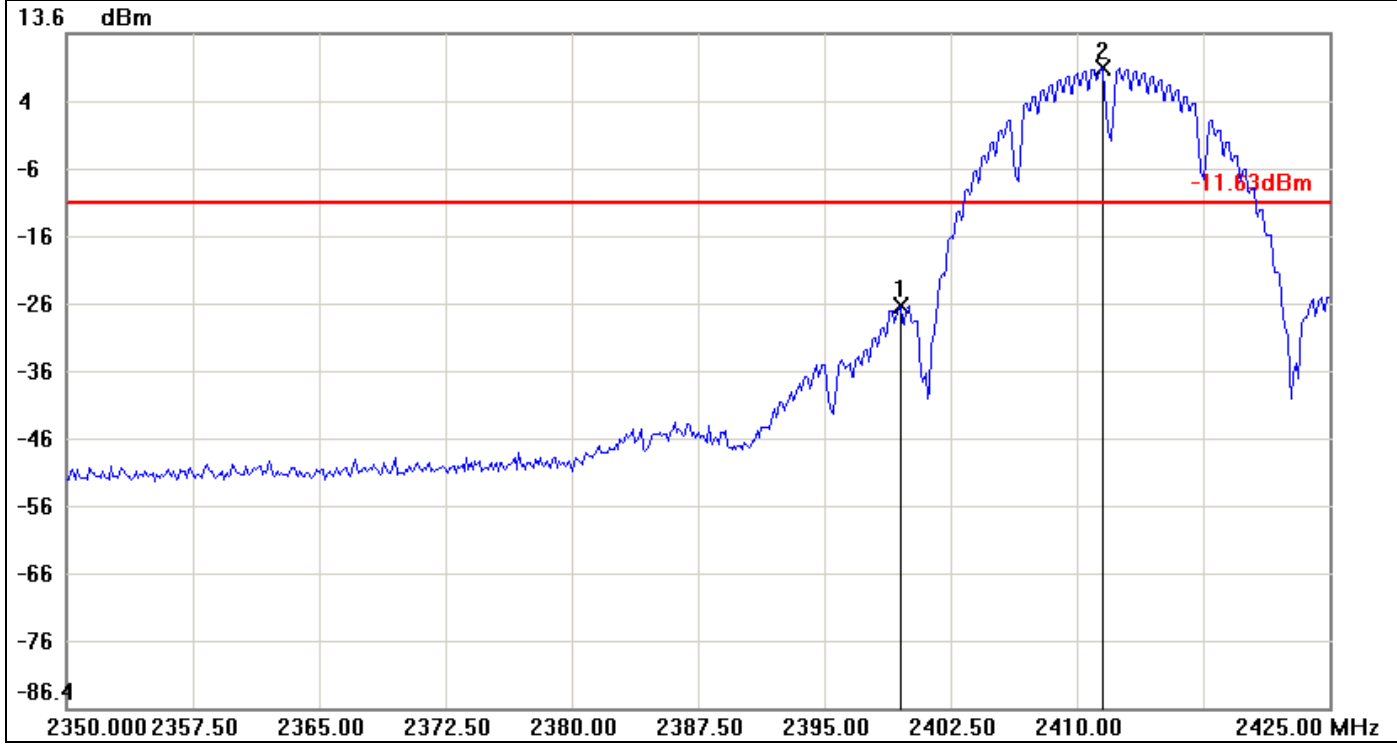

No.	Frequency(MHz)	Result(dBm)	Limit(dBm)	Margin(dBm)
1	2399.5000	-26.68	-11.63	-15.05
2	2411.5000	8.37	-11.63	20.00





### Conducted Band Edges (IEEE 802.11b mode / CH High)

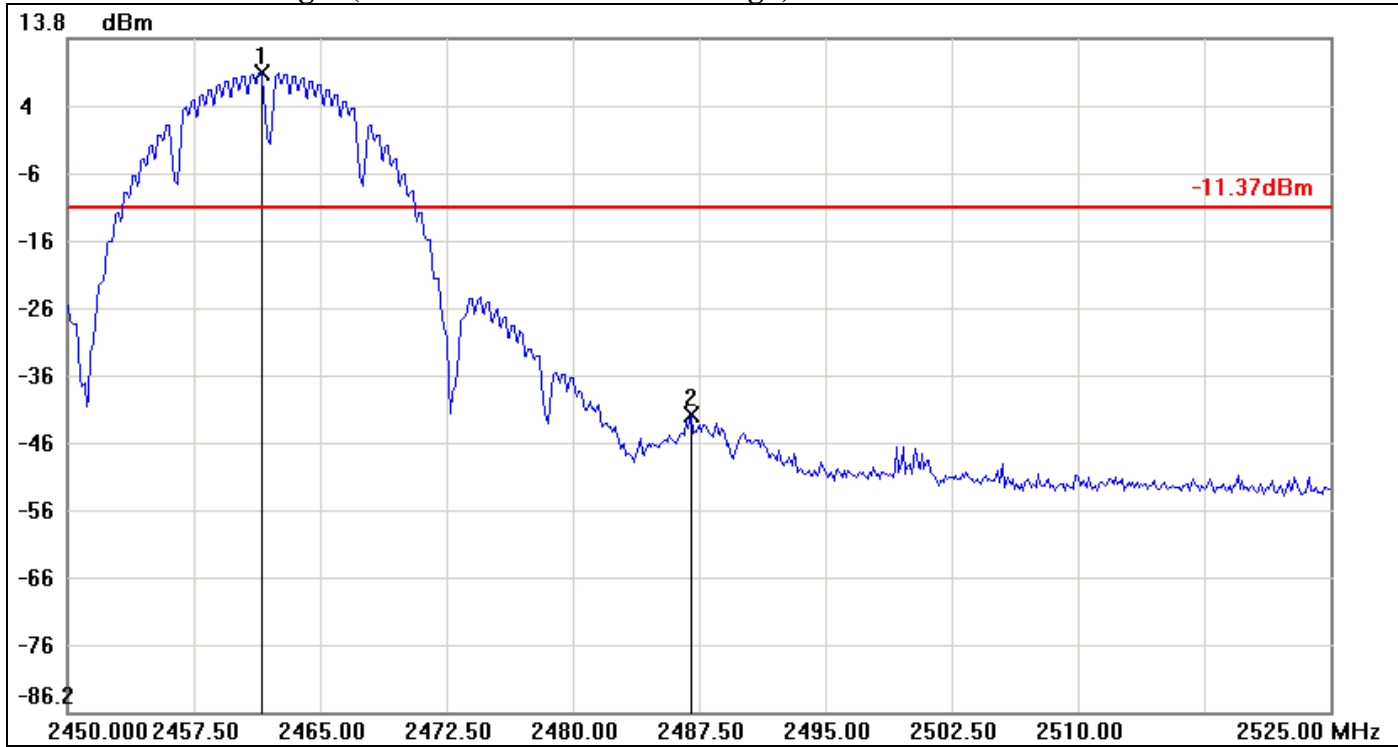

No.	Frequency(MHz)	Result(dBm)	Limit(dBm)	Margin(dBm)
1	2461.5000	8.63	-11.37	20.00
2	2487.0000	-42.13	-11.37	-30.76



### Conducted Band Edges (IEEE 802.11g mode / CH Low)

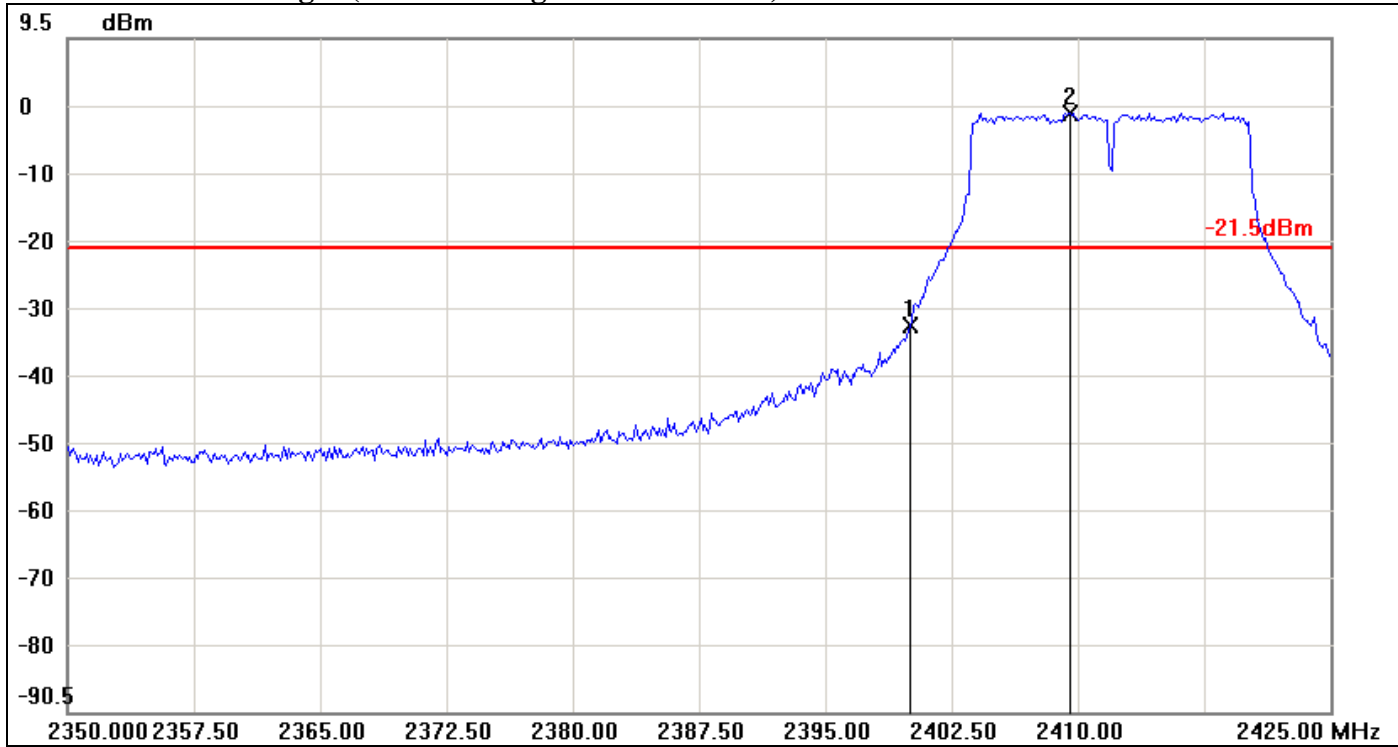

No.	Frequency(MHz)	Result(dBm)	Limit(dBm)	Margin(dBm)
1	2400.0000	-33.05	-21.50	-11.55
2	2409.5000	-1.50	-21.50	20.00



### Conducted Band Edges (IEEE 802.11g mode / CH High)

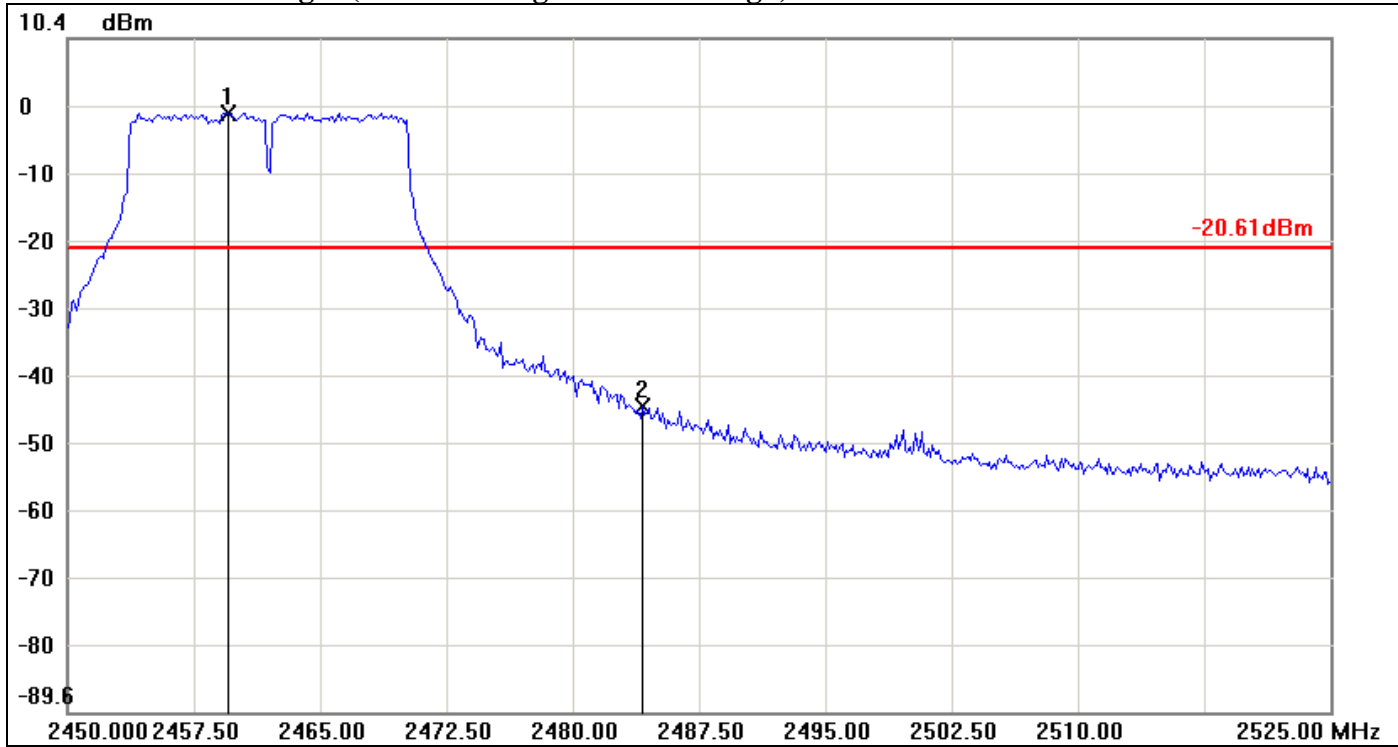

No.	Frequency(MHz)	Result(dBm)	Limit(dBm)	Margin(dBm)
1	2459.5000	-0.61	-20.61	20.00
2	2484.1250	-44.24	-20.61	-23.63



**Conducted Band Edges (IEEE 802.11n HT 20 MHz mode / CH Low / chain 0)**

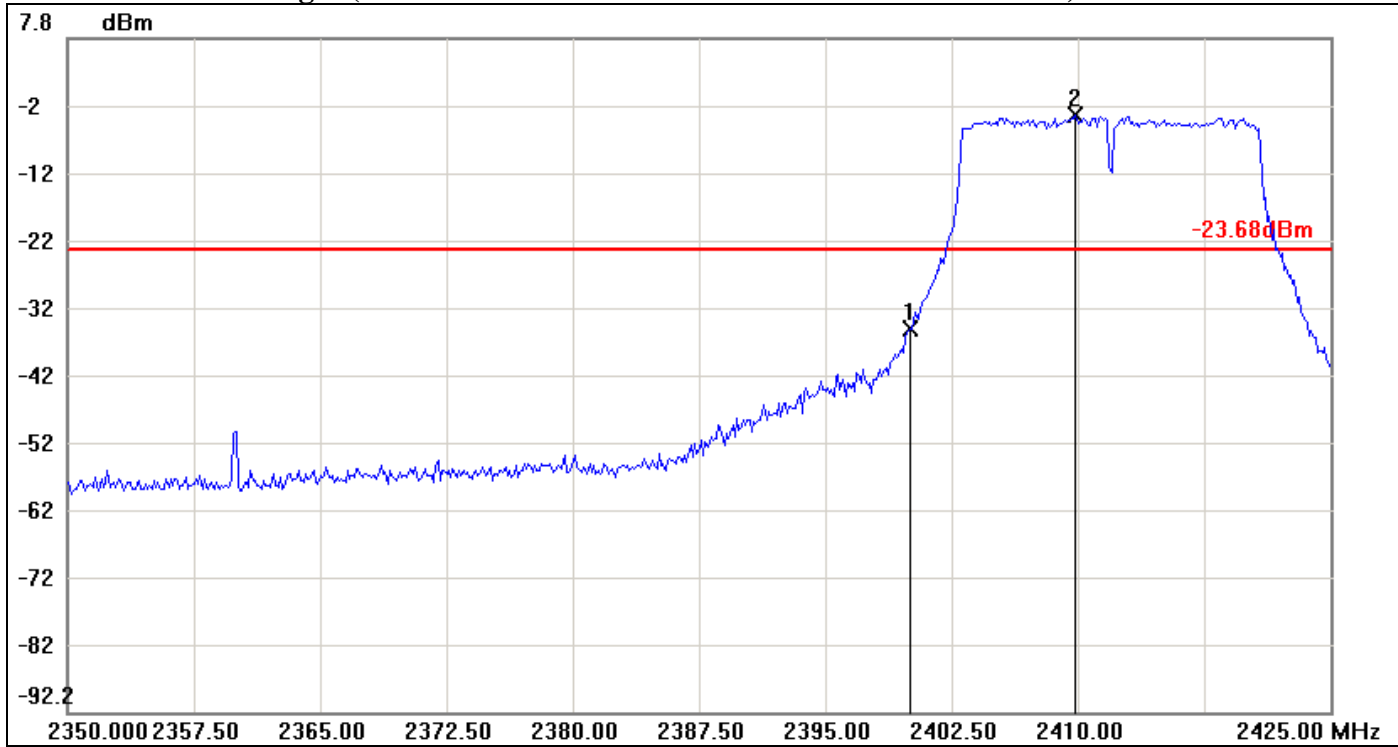

No.	Frequency(MHz)	Result(dBm)	Limit(dBm)	Margin(dBm)
1	2400.0000	-35.38	-23.68	-11.70
2	2409.8750	-3.68	-23.68	20.00



**Conducted Band Edges (IEEE 802.11n HT 20 MHz mode / CH High / chain 0)**

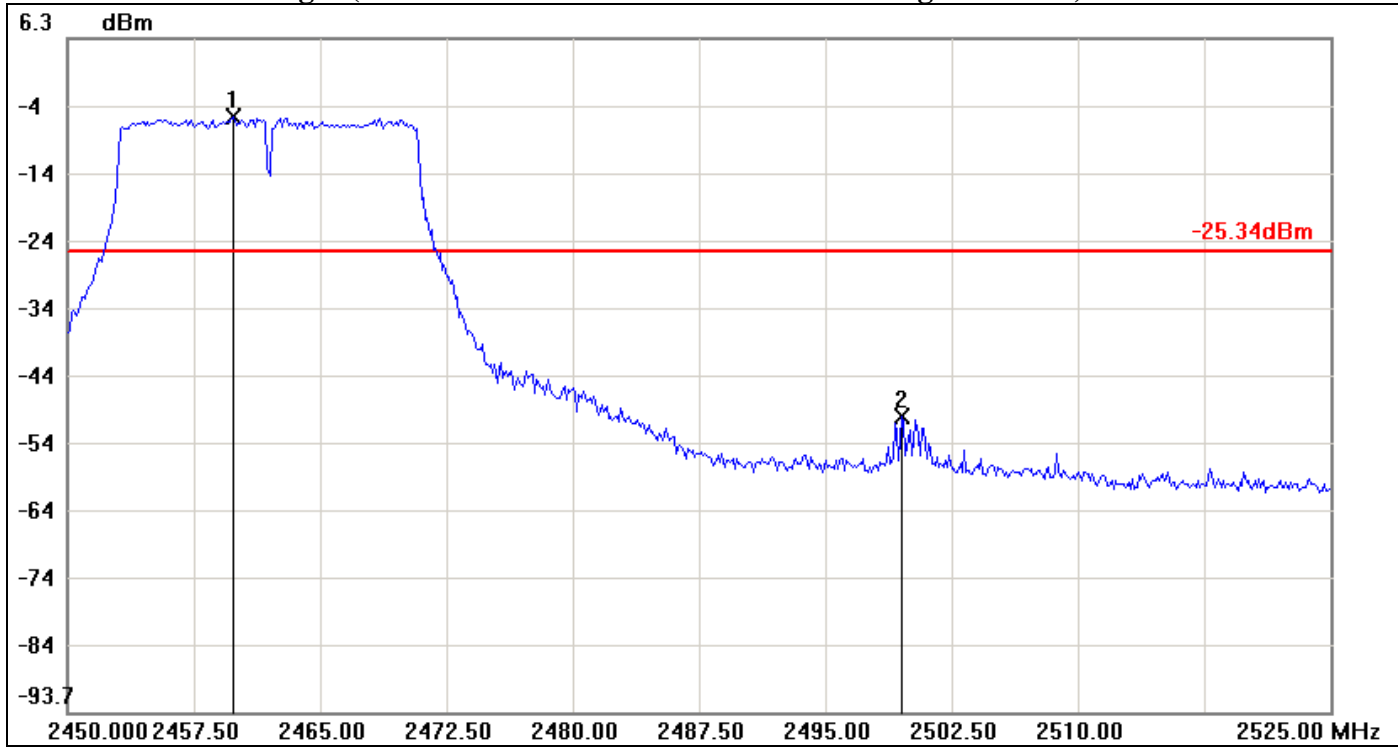

No.	Frequency(MHz)	Result(dBm)	Limit(dBm)	Margin(dBm)
1	2459.8750	-5.34	-25.34	20.00
2	2499.5000	-49.73	-25.34	-24.39



**Conducted Band Edges (IEEE 802.11n HT 20 MHz mode / CH Low / chain 1)**

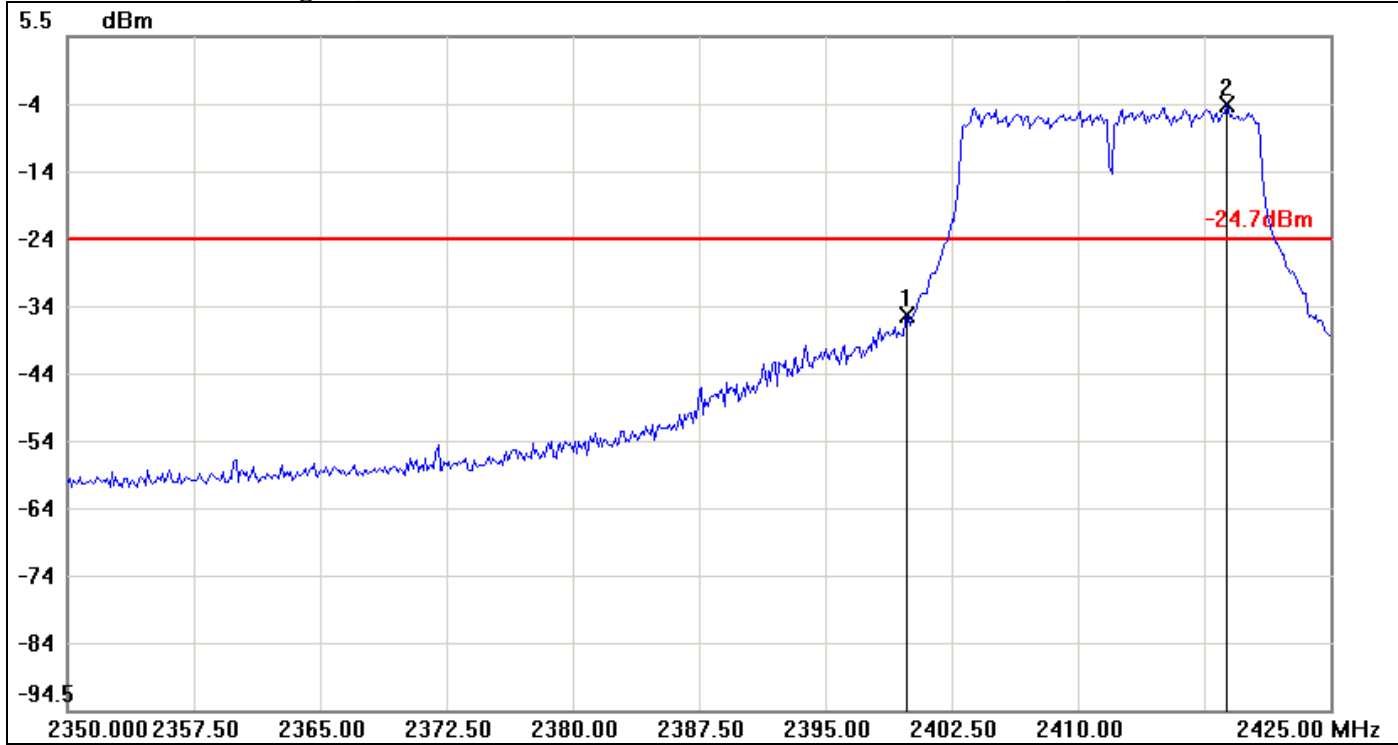

No.	Frequency(MHz)	Result(dBm)	Limit(dBm)	Margin(dBm)
1	2399.8750	-35.80	-24.70	-11.10
2	2418.8750	-4.70	-24.70	20.00



**Conducted Band Edges (IEEE 802.11n HT 20 MHz mode / CH High / chain 1)**

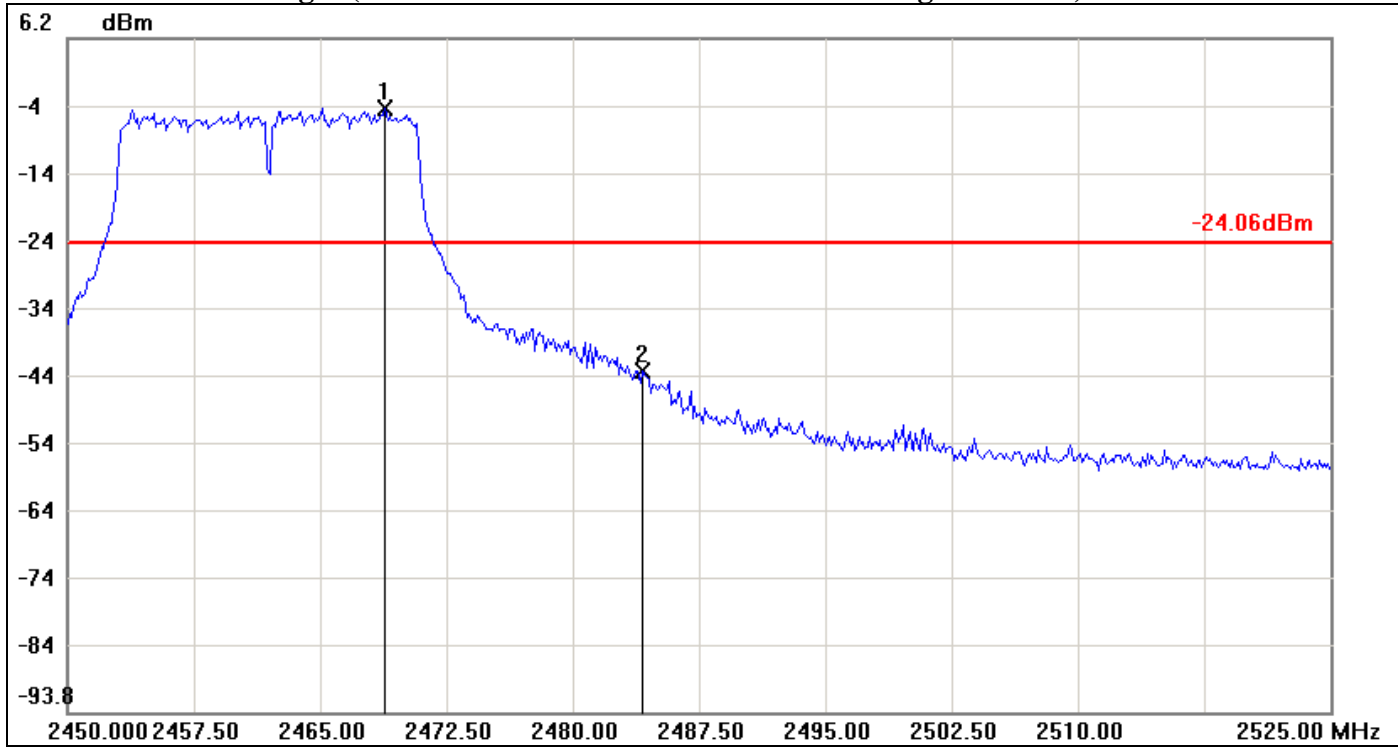

No.	Frequency(MHz)	Result(dBm)	Limit(dBm)	Margin(dBm)
1	2468.8750	-4.06	-24.06	20.00
2	2484.1250	-43.03	-24.06	-18.97



**Conducted Band Edges (IEEE 802.11n HT 40 MHz mode / CH Low / chain 0)**

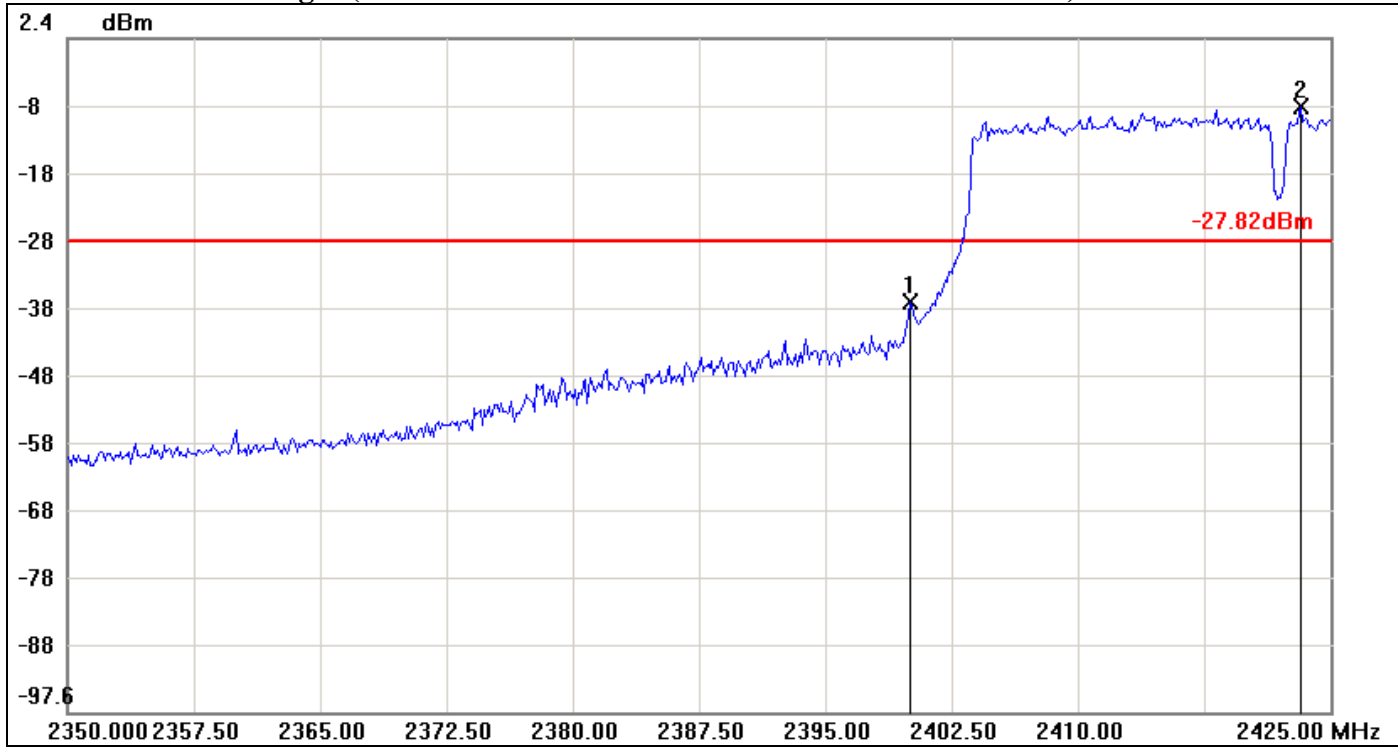

No.	Frequency(MHz)	Result(dBm)	Limit(dBm)	Margin(dBm)
1	2400.0000	-36.68	-27.82	-8.86
2	2423.2500	-7.82	-27.82	20.00





**Conducted Band Edges (IEEE 802.11n HT 40 MHz mode / CH High / chain 0 )**

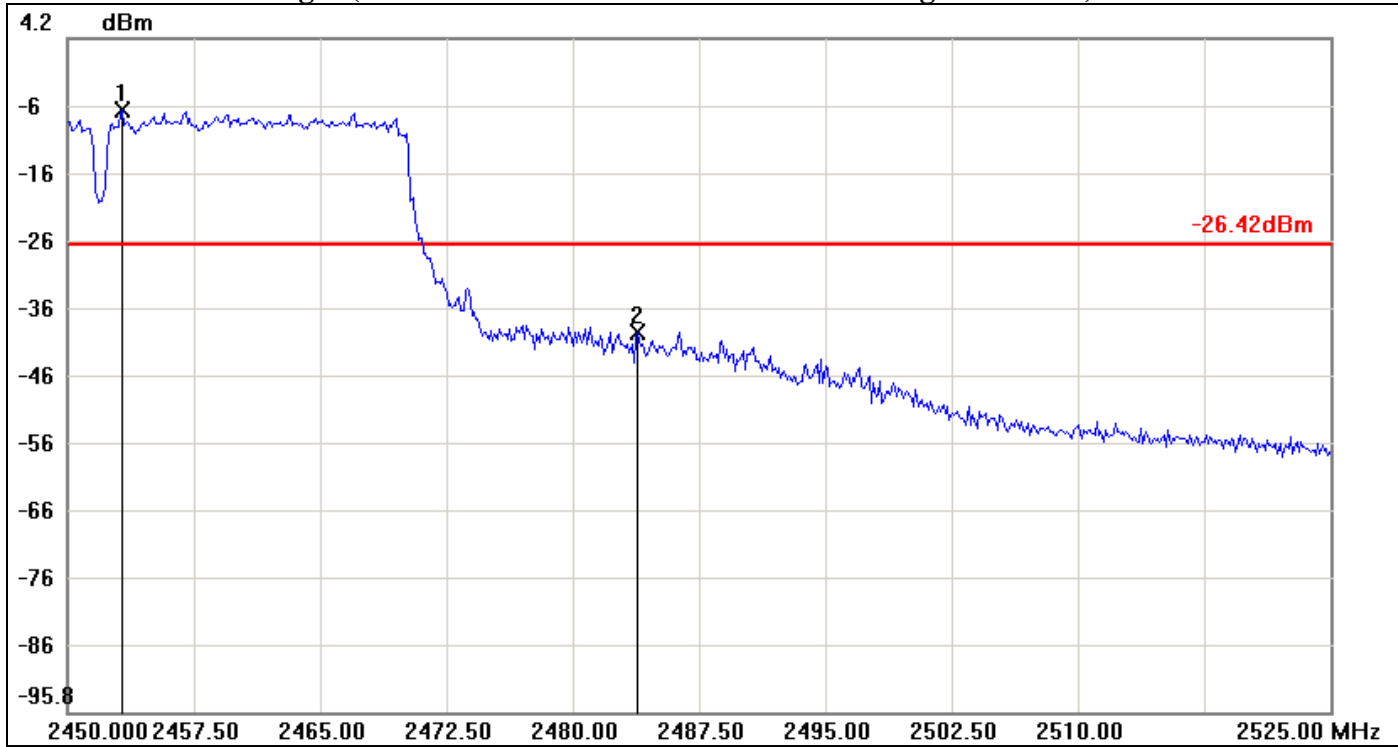

No.	Frequency(MHz)	Result(dBm)	Limit(dBm)	Margin(dBm)
1	2453.2500	-6.42	-26.42	20.00
2	2483.8750	-39.38	-26.42	-12.96



**Conducted Band Edges (IEEE 802.11n HT 40 MHz mode / CH Low / chain 1)**

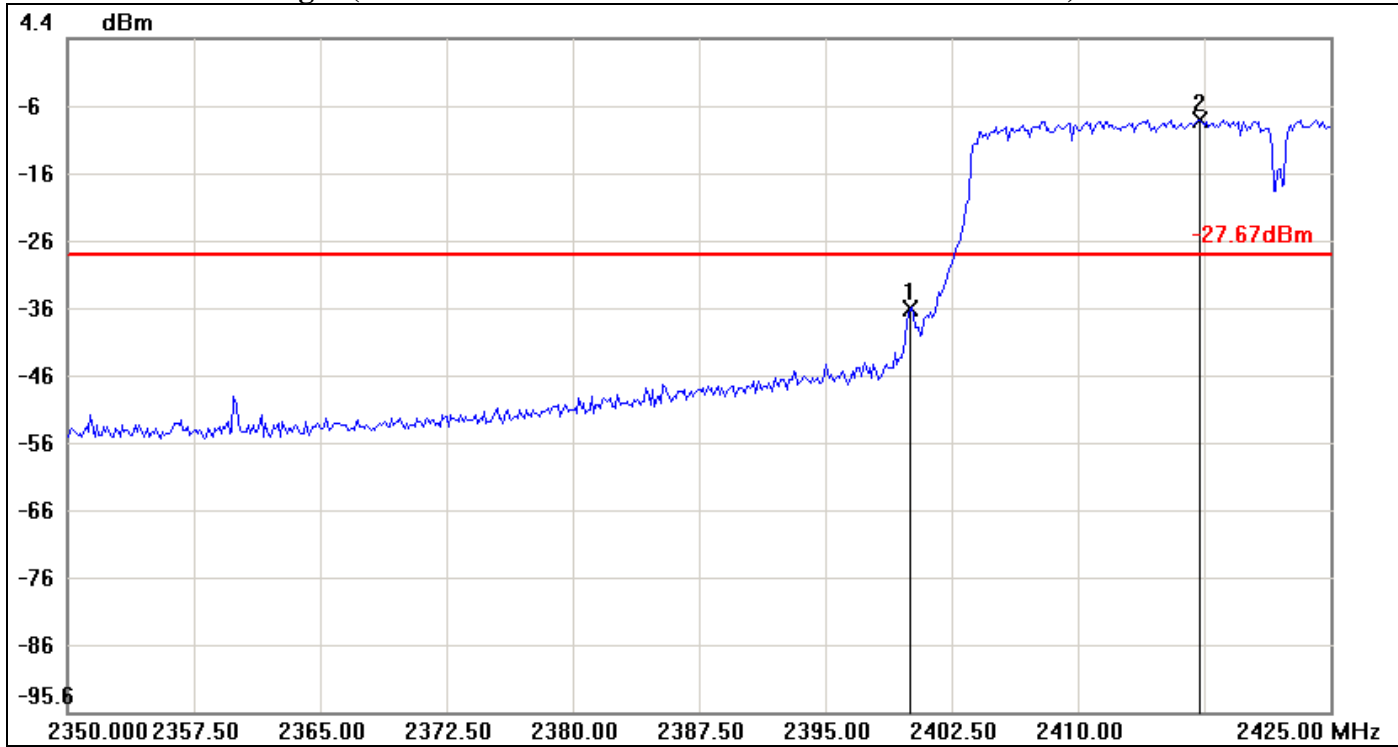

No.	Frequency(MHz)	Result(dBm)	Limit(dBm)	Margin(dBm)
1	2400.0000	-35.65	-27.67	-7.98
2	2417.2500	-7.67	-27.67	20.00



**Conducted Band Edges (IEEE 802.11n HT 40 MHz mode / CH High / chain 1 )**

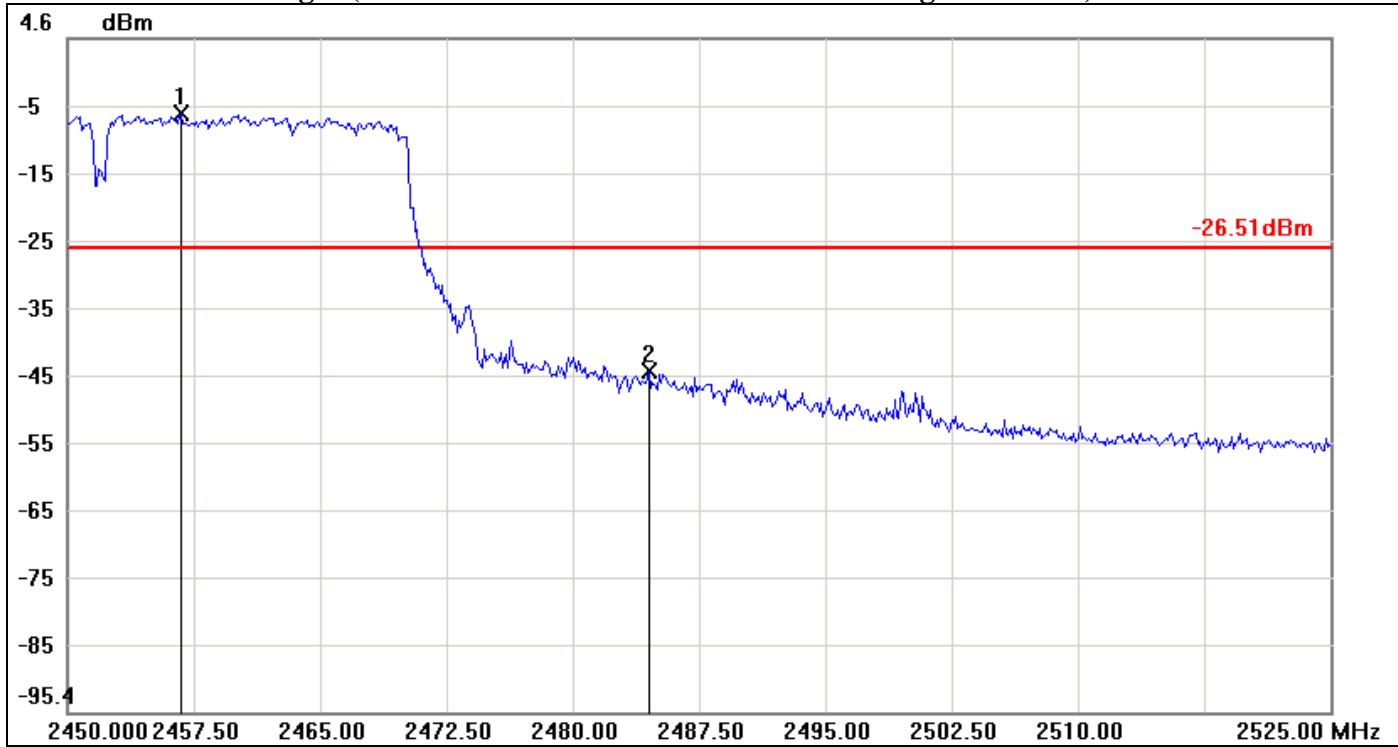

No.	Frequency(MHz)	Result(dBm)	Limit(dBm)	Margin(dBm)
1	2456.7500	-6.51	-26.51	20.00
2	2484.5000	-44.69	-26.51	-18.18



## 7.5 PEAK POWER SPECTRAL DENSITY

### LIMIT

1. According to §15.247(e), for digitally modulated systems, the power spectral density conducted from the intentional radiator to the antenna shall not be greater than 8 dBm in any 3 kHz band during any time interval of continuous transmission.
2. According to §15.247(f), the digital modulation operation of the hybrid system, with the frequency hopping turned off, shall comply with the power density requirements of paragraph (d) of this section.

### Test Configuration

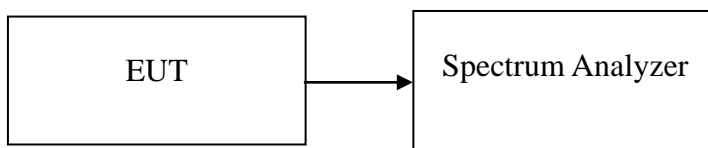

### TEST PROCEDURE

1. Place the EUT on the table and set it in transmitting mode.  
Remove the antenna from the EUT and then connect a low loss RF cable from the antenna port to the spectrum analyzer.
2. Set the spectrum analyzer as RBW=10kHz, VBW=100kHz, Span=1.5 times the DTS bandwidth, Sweep time= auto
3. Record the max reading.
4. Repeat the above procedure until the measurements for all frequencies are completed.

### TEST RESULTS

*No non-compliance noted.*



**Test Data**

**Test mode: IEEE 802.11b mode**

Channel	Frequency (MHz)	PPSD (dBm)	Limit (dBm)	Result
Low	2412	-1.31	8.00	PASS
Mid	2437	-0.81		PASS
High	2462	-1.05		PASS

**Test mode: IEEE 802.11g mode**

Channel	Frequency (MHz)	PPSD (dBm)	Limit (dBm)	Result
Low	2412	-8.96	8.00	PASS
Mid	2437	-7.89		PASS
High	2462	-8.04		PASS

**Test mode: IEEE 802.11n HT 20 MHz mode**

Channel	Frequency (MHz)	Chain 0 PPSD (dBm)	Chain 1 PPSD (dBm)	PPSD (dBm)	Limit (dBm)	Result
Low	2412	-10.09	-13.16	-8.35	8.00	PASS
Mid	2437	-10.84	-12.57	-8.61		PASS
High	2462	-11.71	-12.42	-9.04		PASS

**Test mode: IEEE 802.11n HT 40 MHz mode**

Channel	Frequency (MHz)	Chain 0 PPSD (dBm)	Chain 1 PPSD (dBm)	PPSD (dBm)	Limit (dBm)	Result
Low	2422	-12.99	-15.56	-11.08	8.00	PASS
Mid	2437	-13.84	-15.06	-11.40		PASS
High	2452	-12.91	-14.11	-10.46		PASS

**Remark:**

1. Total PPSD (dBm) = 10\*LOG(10^(Chain 0 PPSD / 10)+10^(Chain 1 PPSD / 10))



**Test Plot**

**IEEE 802.11b mode**

**PPSD (CH Low)**

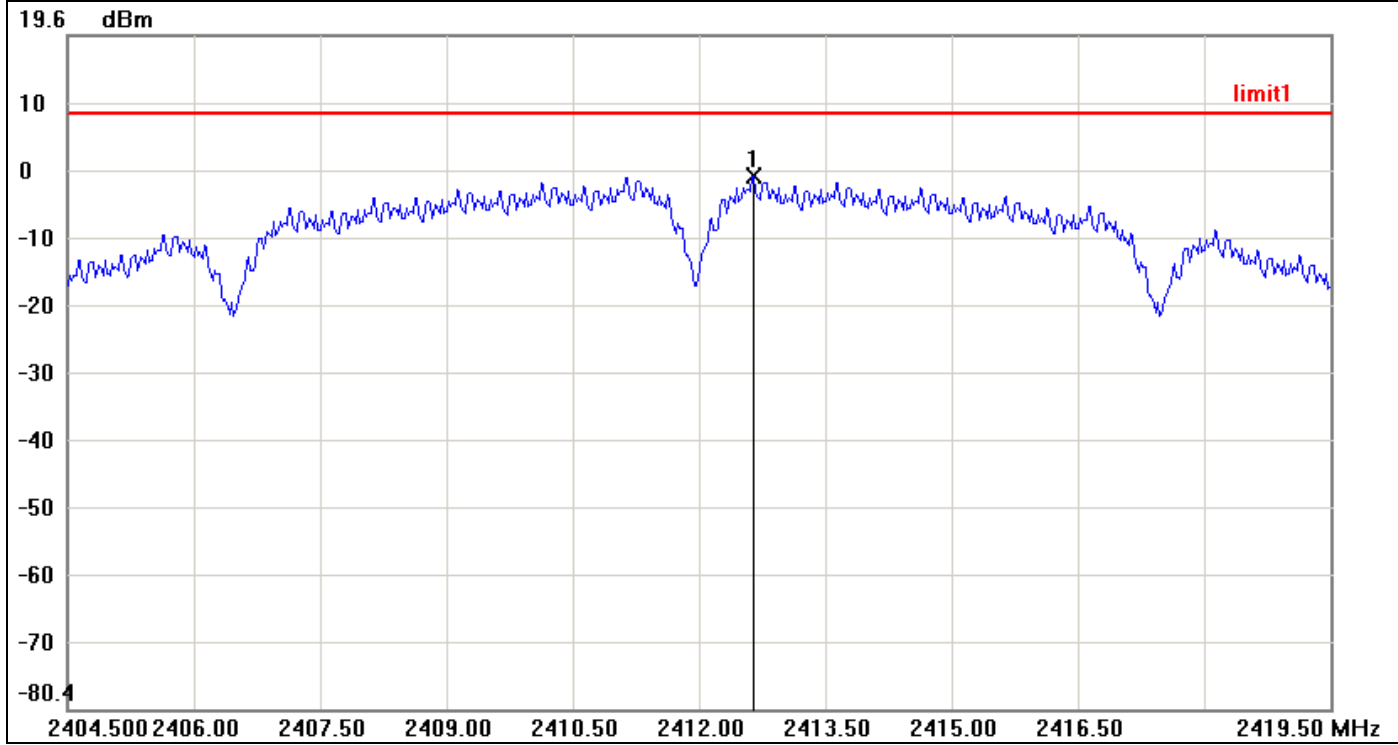

No.	Frequency(MHz)	Result(dBm)	Limit(dBm)	Margin(dBm)
1	2412.6500	-1.31	8.00	-9.31



### PPSD (CH Mid)

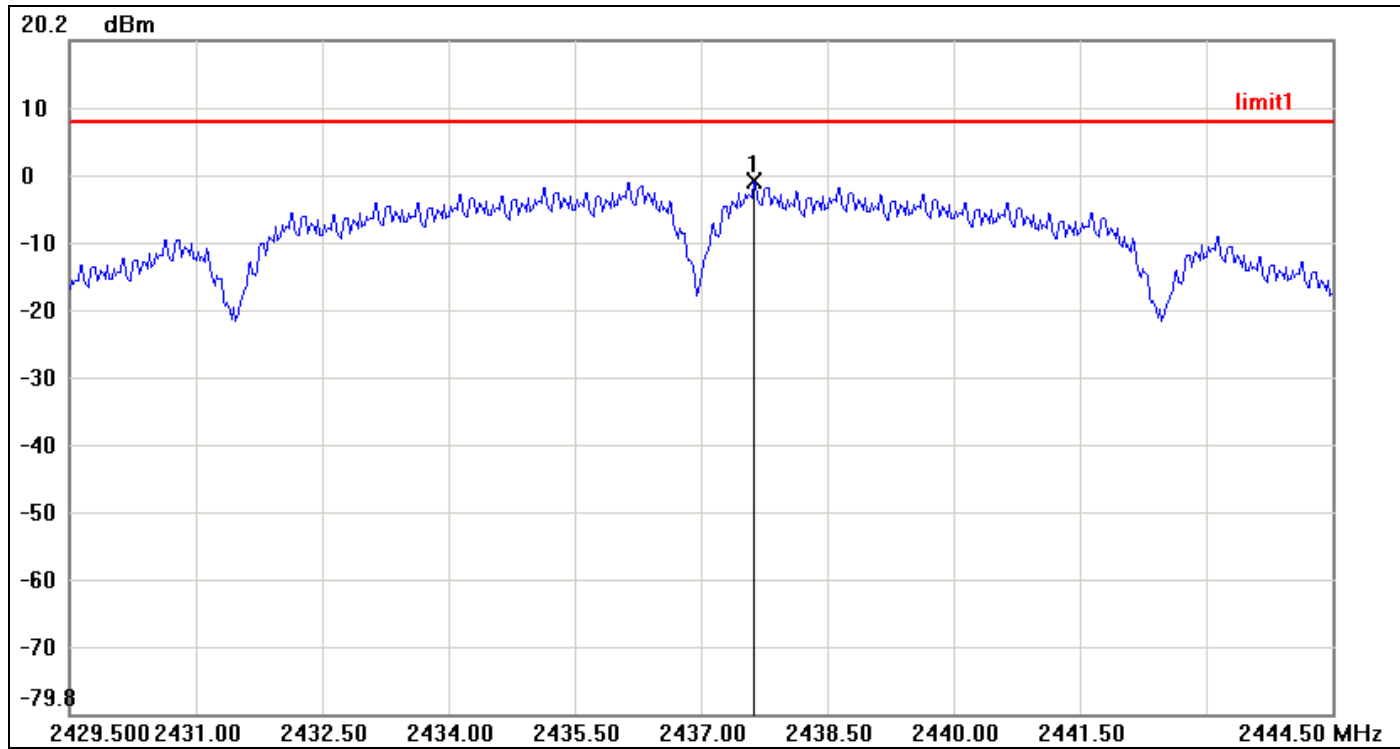

No.	Frequency(MHz)	Result(dBm)	Limit(dBm)	Margin(dBm)
1	2437.6250	-0.81	8.00	-8.81



### PPSD (CH High)

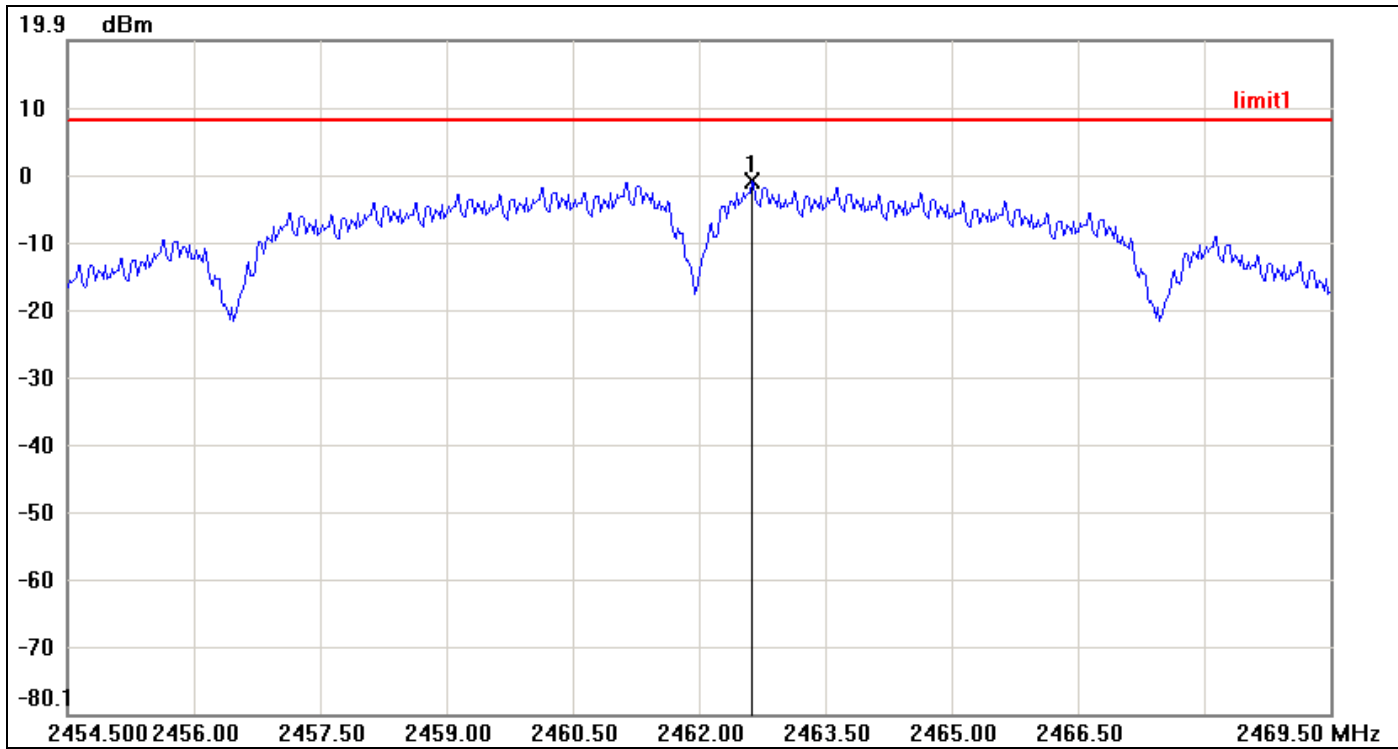

No.	Frequency(MHz)	Result(dBm)	Limit(dBm)	Margin(dBm)
1	2462.6250	-1.05	8.00	-9.05





**IEEE 802.11g mode**

**PPSD (CH Low)**

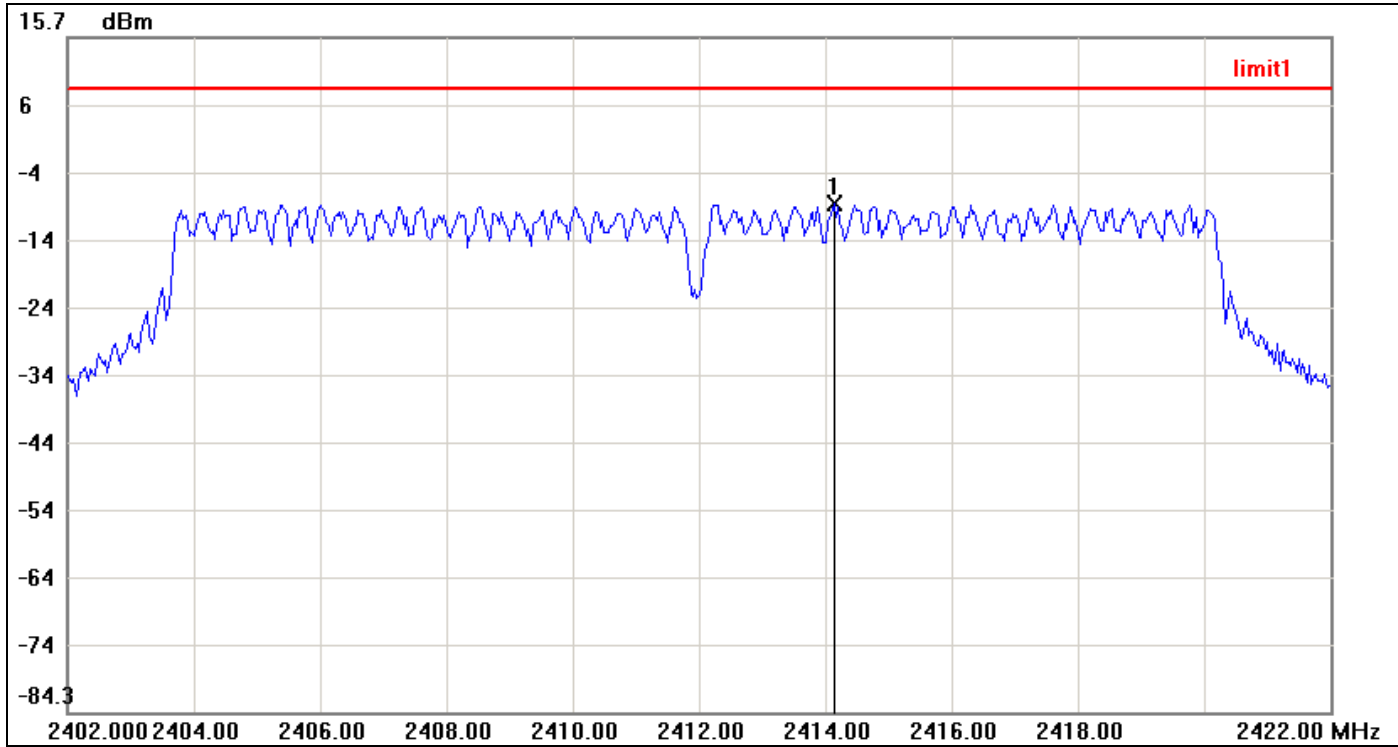

No.	Frequency(MHz)	Result(dBm)	Limit(dBm)	Margin(dBm)
1	2414.1333	-8.96	8.00	-16.96



PPSD (CH Mid)

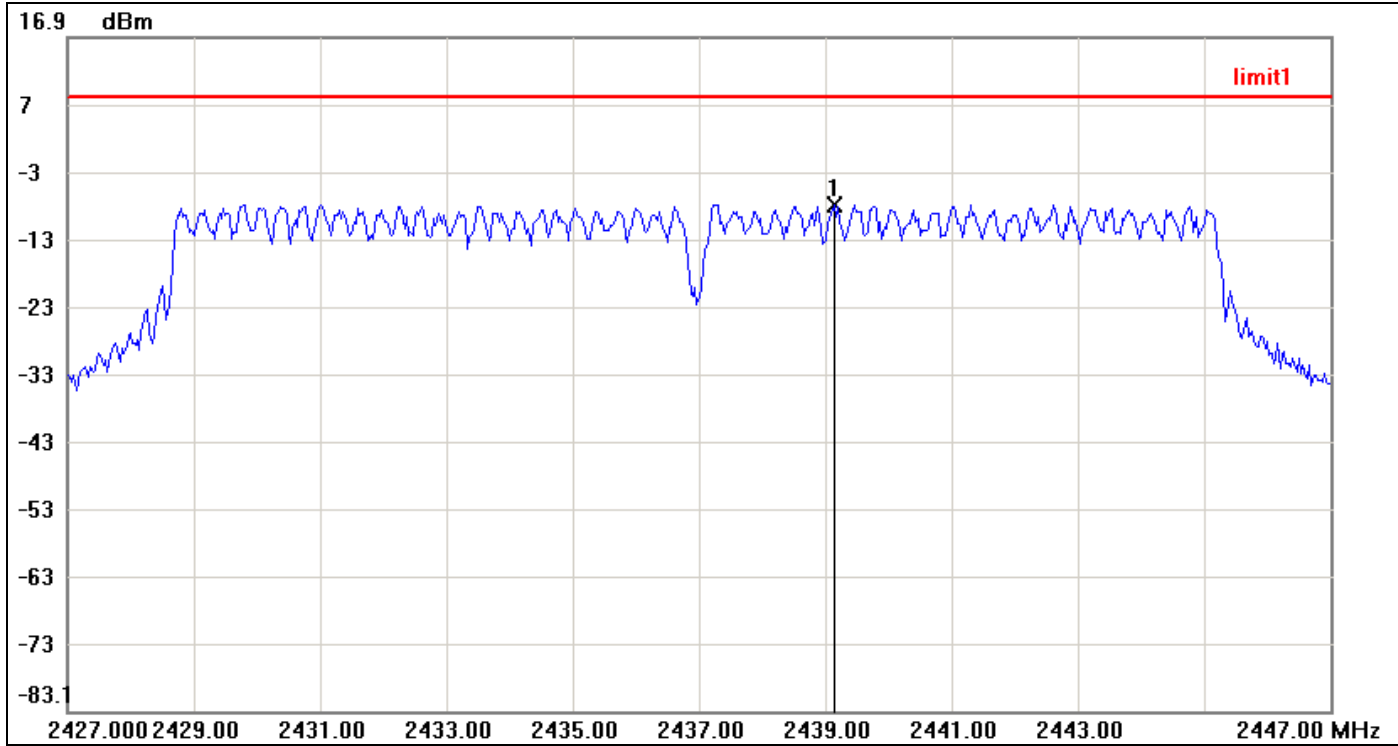

No.	Frequency(MHz)	Result(dBm)	Limit(dBm)	Margin(dBm)
1	2439.1333	-7.89	8.00	-15.89



### PPSD (CH High)

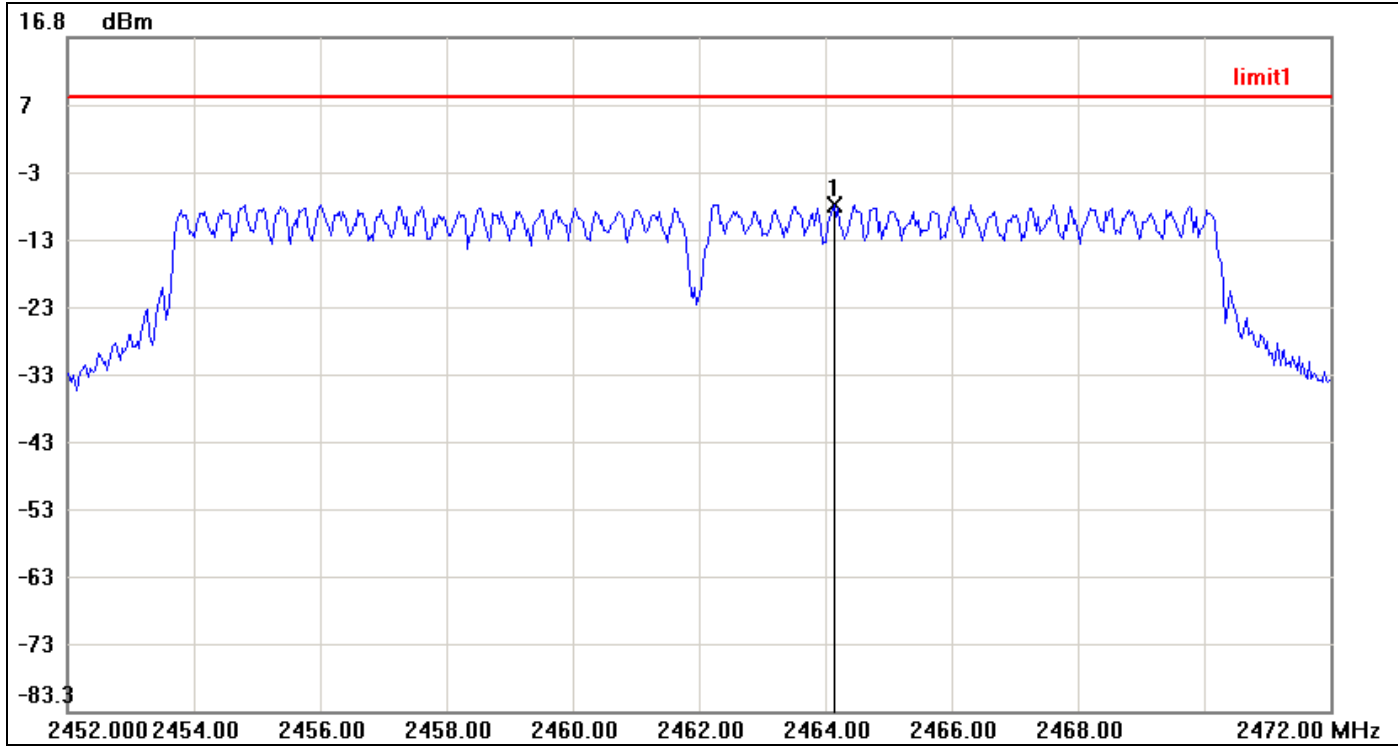

No.	Frequency(MHz)	Result(dBm)	Limit(dBm)	Margin(dBm)
1	2464.1333	-8.04	8.00	-16.04



**IEEE 802.11n HT 20 MHz mode / Chain 0**

**PPSD (CH Low)**

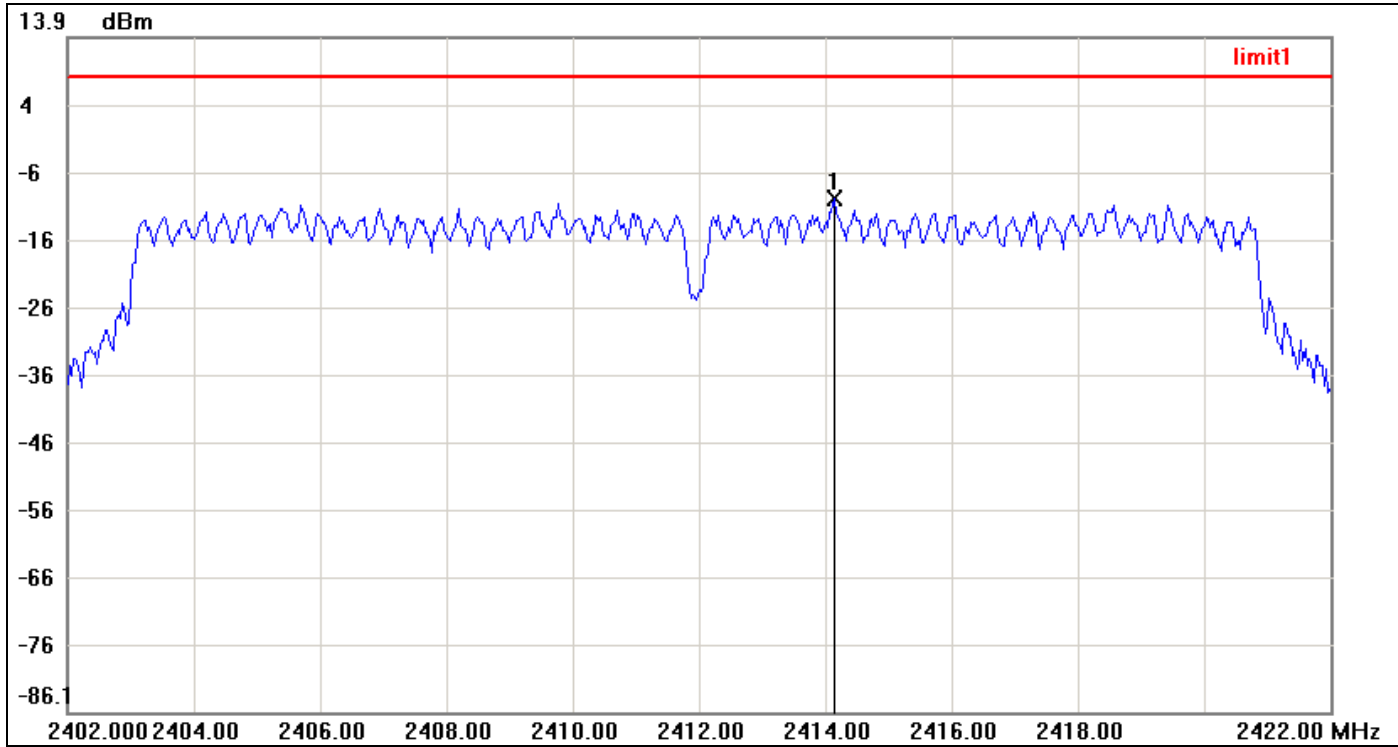

No.	Frequency(MHz)	Result(dBm)	Limit(dBm)	Margin(dBm)
1	2414.1333	-10.09	8.00	-18.09



PPSD (CH Mid)

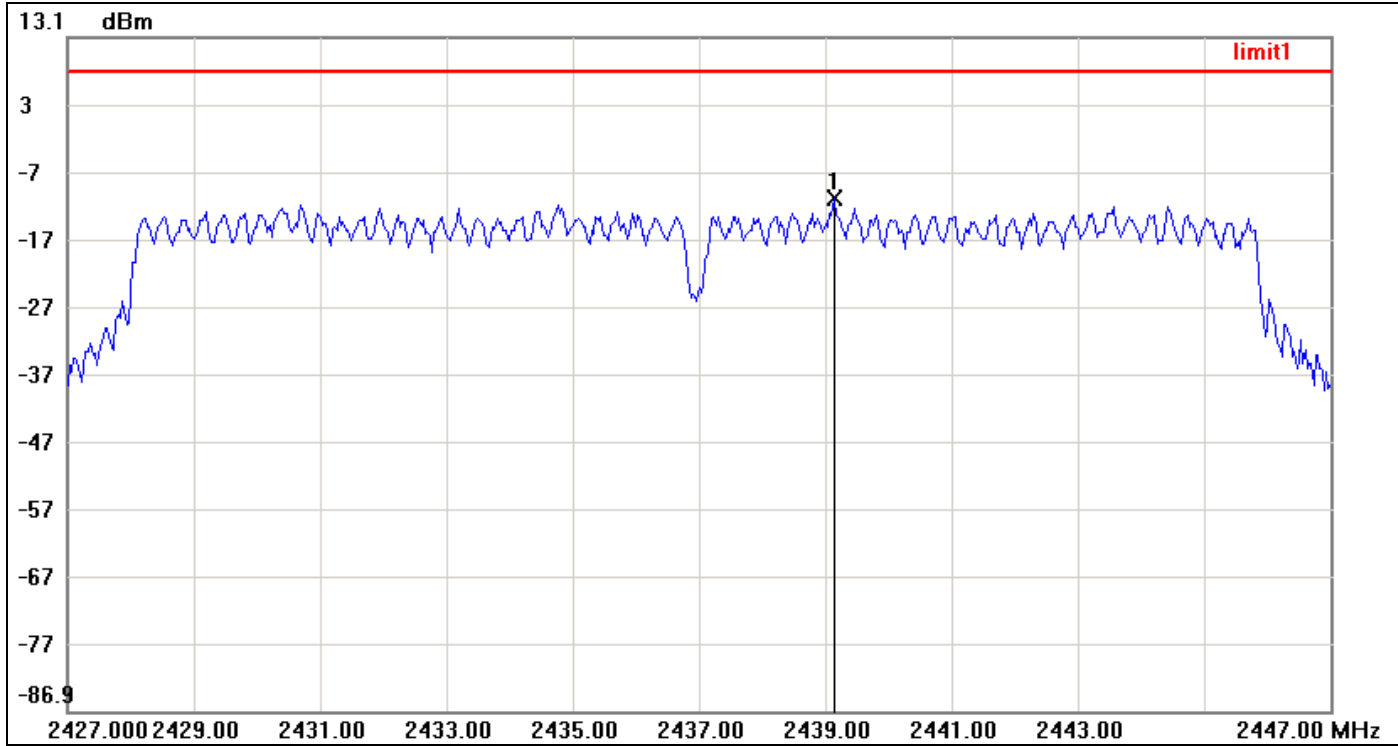

No.	Frequency(MHz)	Result(dBm)	Limit(dBm)	Margin(dBm)
1	2439.1333	-10.84	8.00	-18.84



PPSD (CH High)

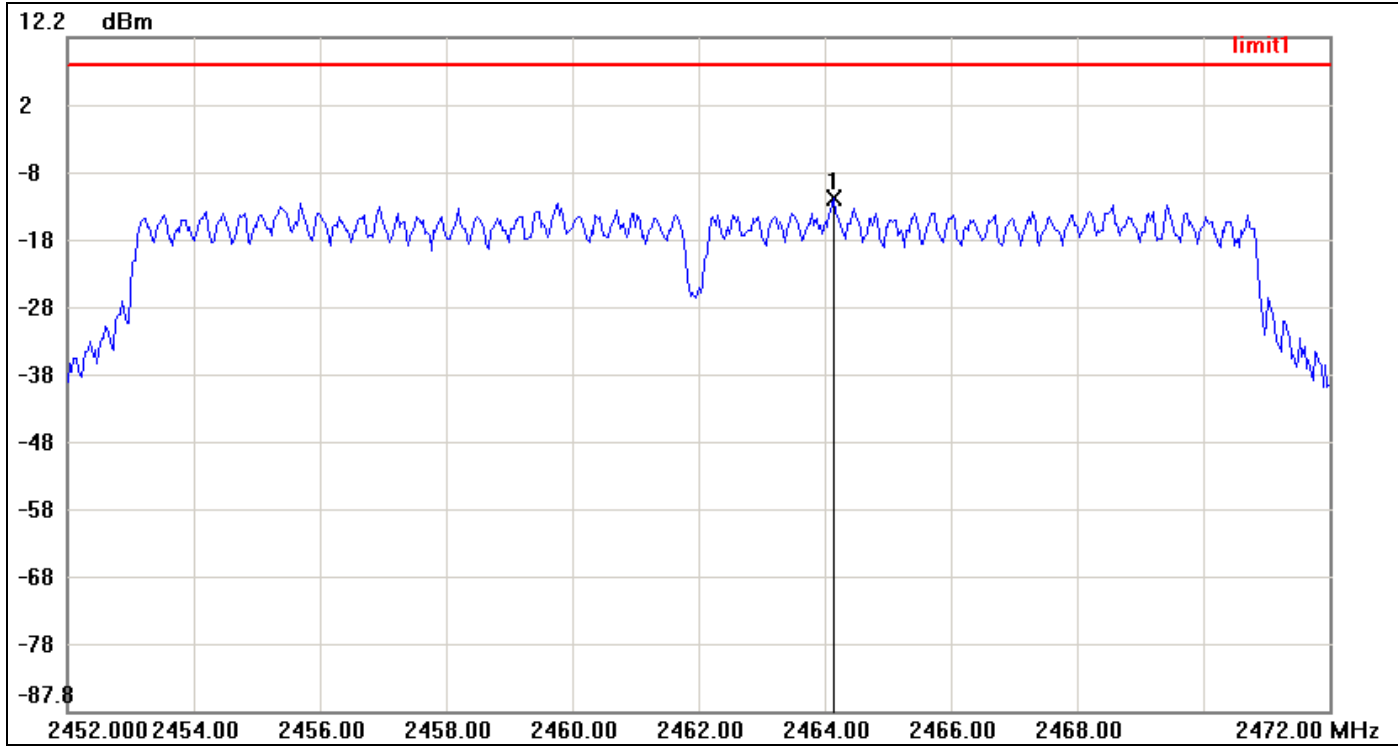

No.	Frequency(MHz)	Result(dBm)	Limit(dBm)	Margin(dBm)
1	2464.1333	-11.71	8.00	-19.71



**IEEE 802.11n HT 20 MHz mode / Chain 1**

**PPSD (CH Low)**

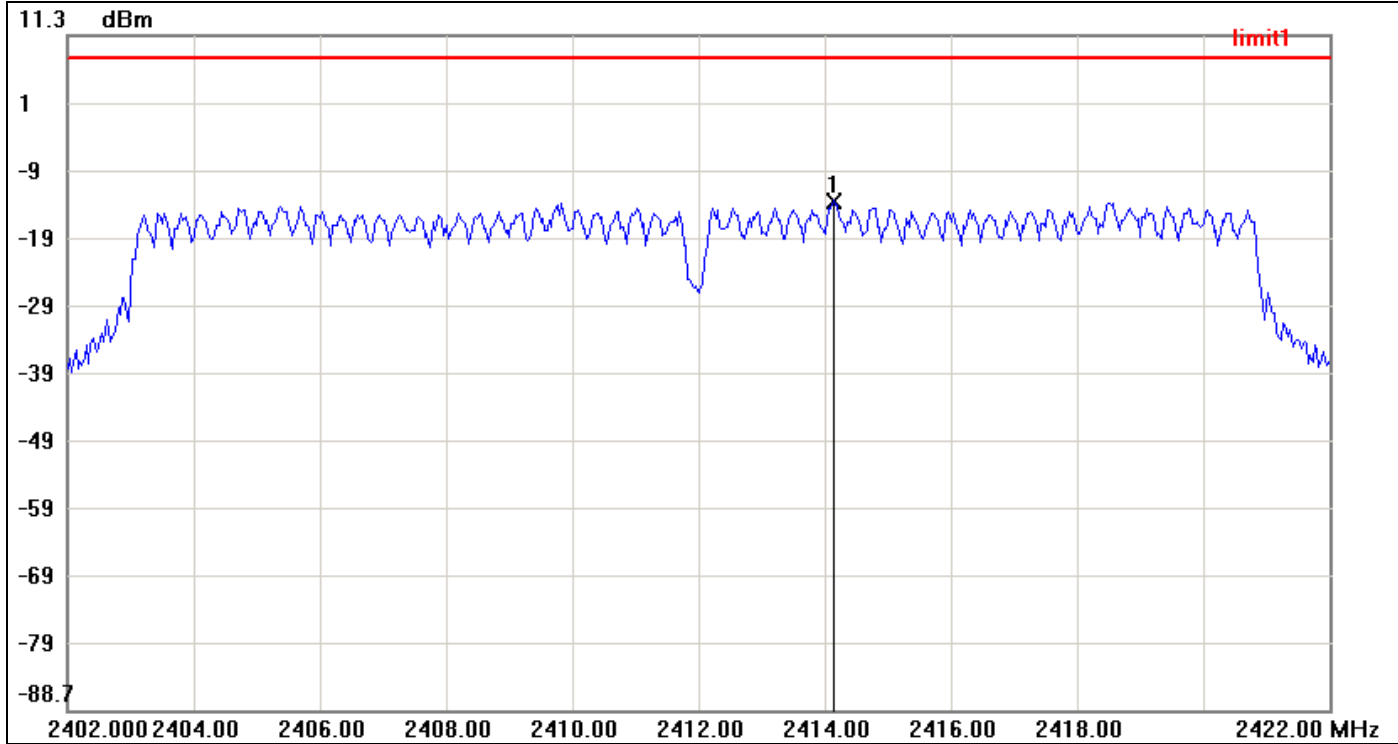

No.	Frequency(MHz)	Result(dBm)	Limit(dBm)	Margin(dBm)
1	2414.1333	-13.16	8.00	-21.16



### PPSD (CH Mid)

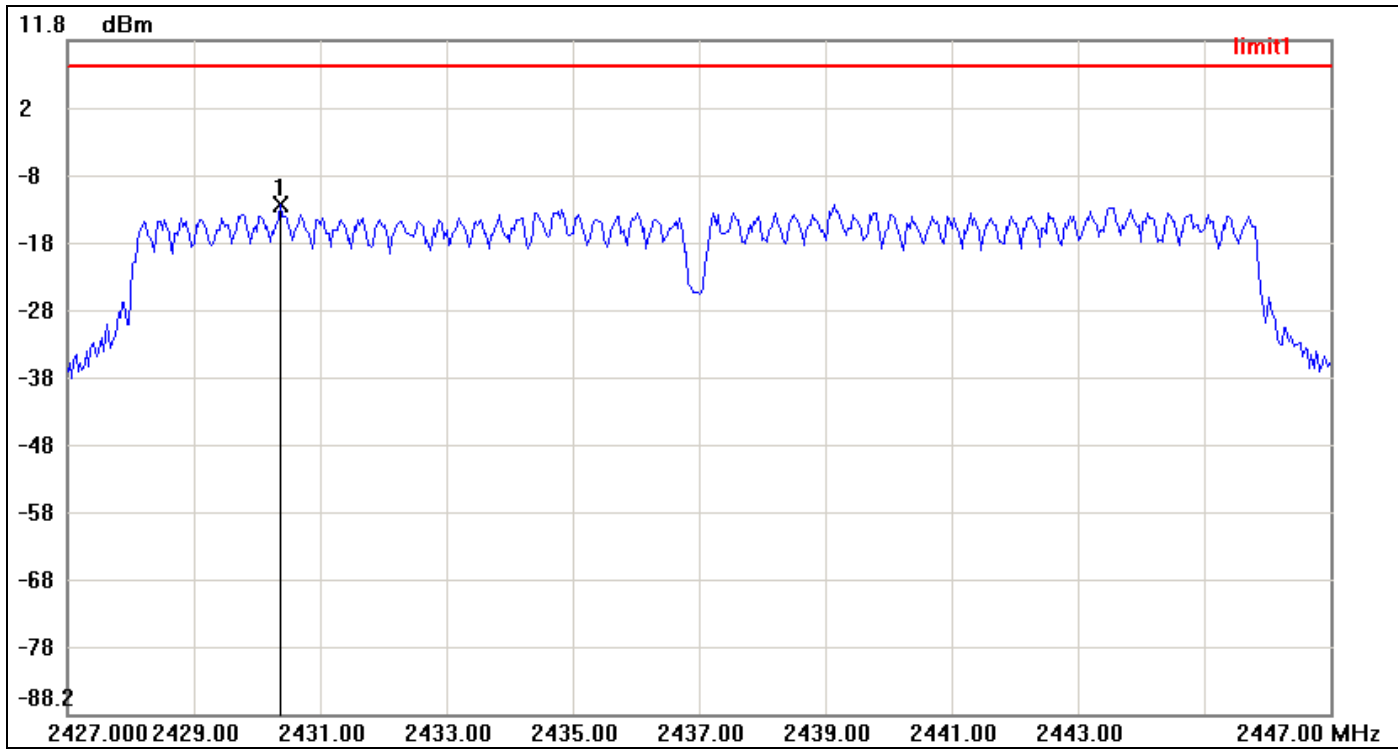

No.	Frequency(MHz)	Result(dBm)	Limit(dBm)	Margin(dBm)
1	2430.3667	-12.57	8.00	-20.57





### PPSD (CH High)

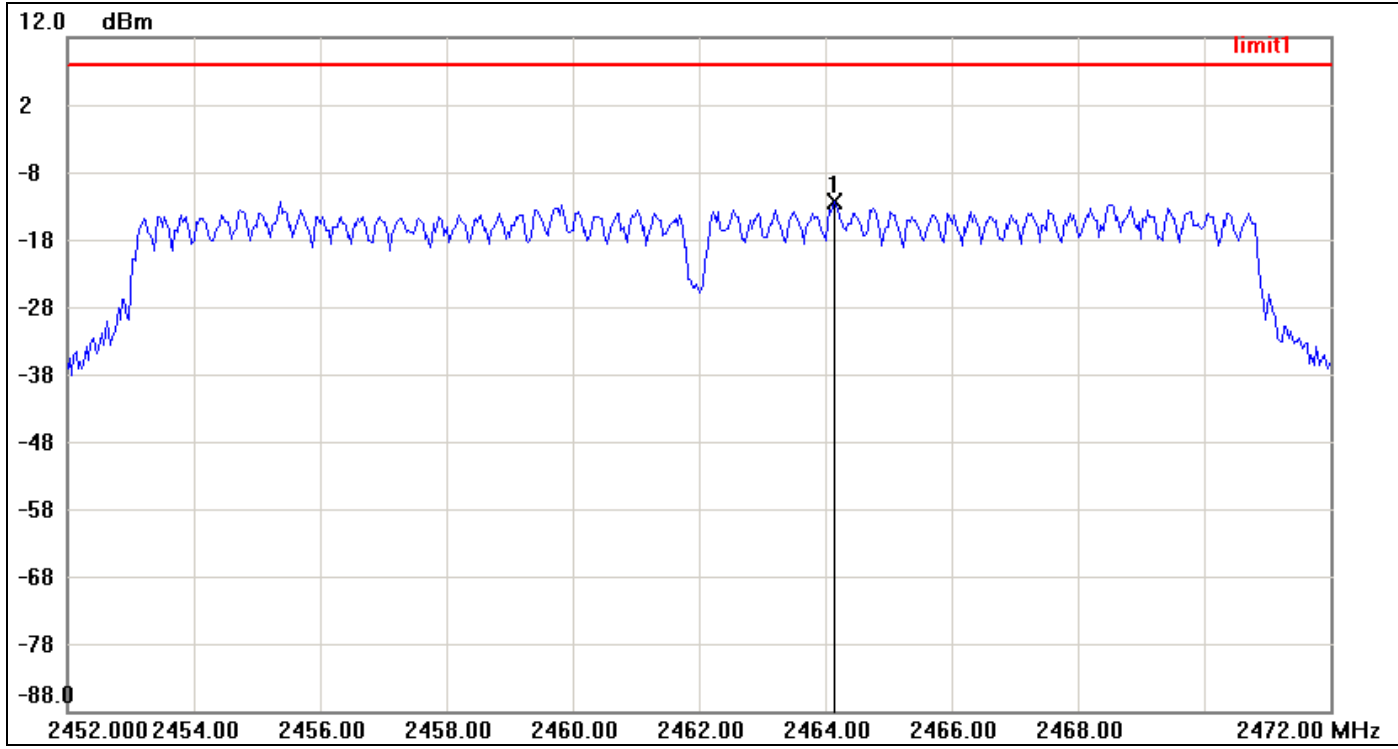

No.	Frequency(MHz)	Result(dBm)	Limit(dBm)	Margin(dBm)
1	2464.1333	-12.42	8.00	-20.42



**IEEE 802.11n HT 40 MHz mode / Chain 0**

**PPSD (CH Low)**

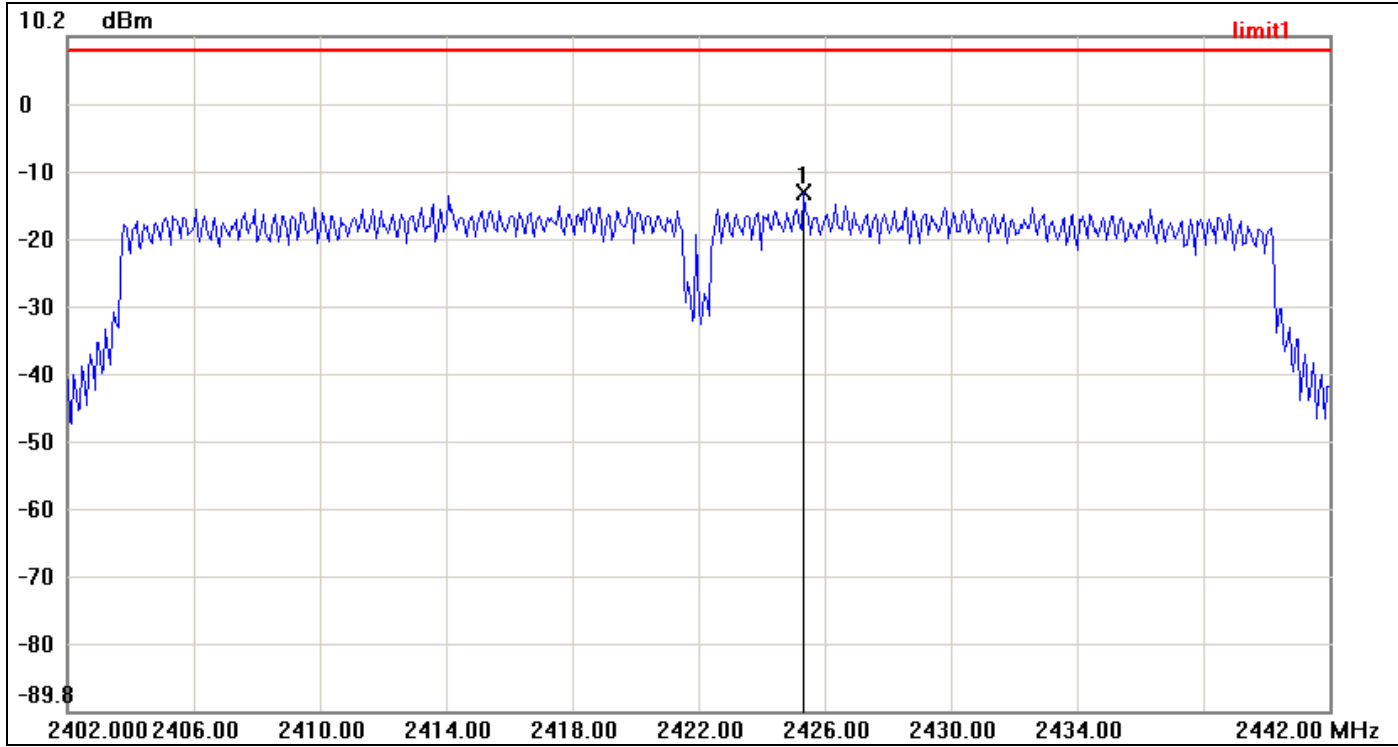

No.	Frequency(MHz)	Result(dBm)	Limit(dBm)	Margin(dBm)
1	2425.3333	-12.99	8.00	-20.99



PPSD (CH Mid)

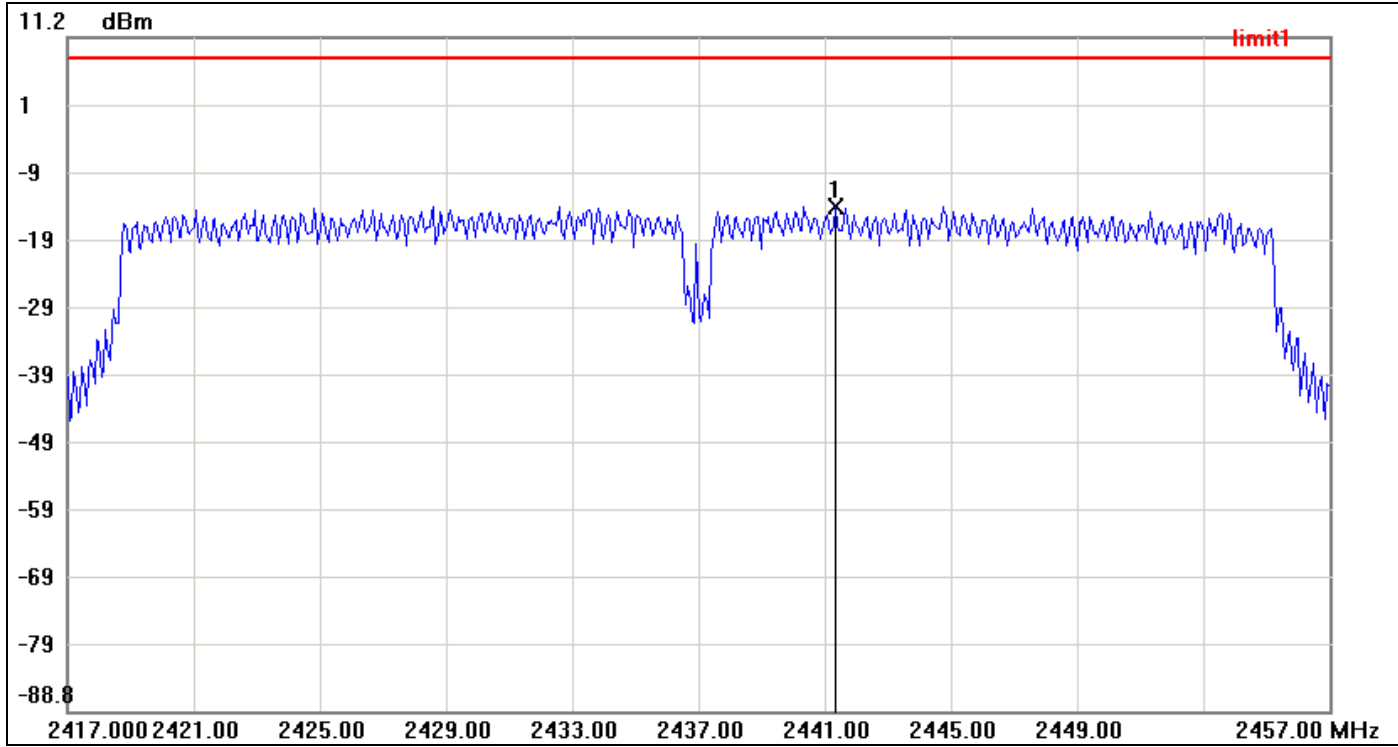

No.	Frequency(MHz)	Result(dBm)	Limit(dBm)	Margin(dBm)
1	2441.3333	-13.84	8.00	-21.84



PPSD (CH High)

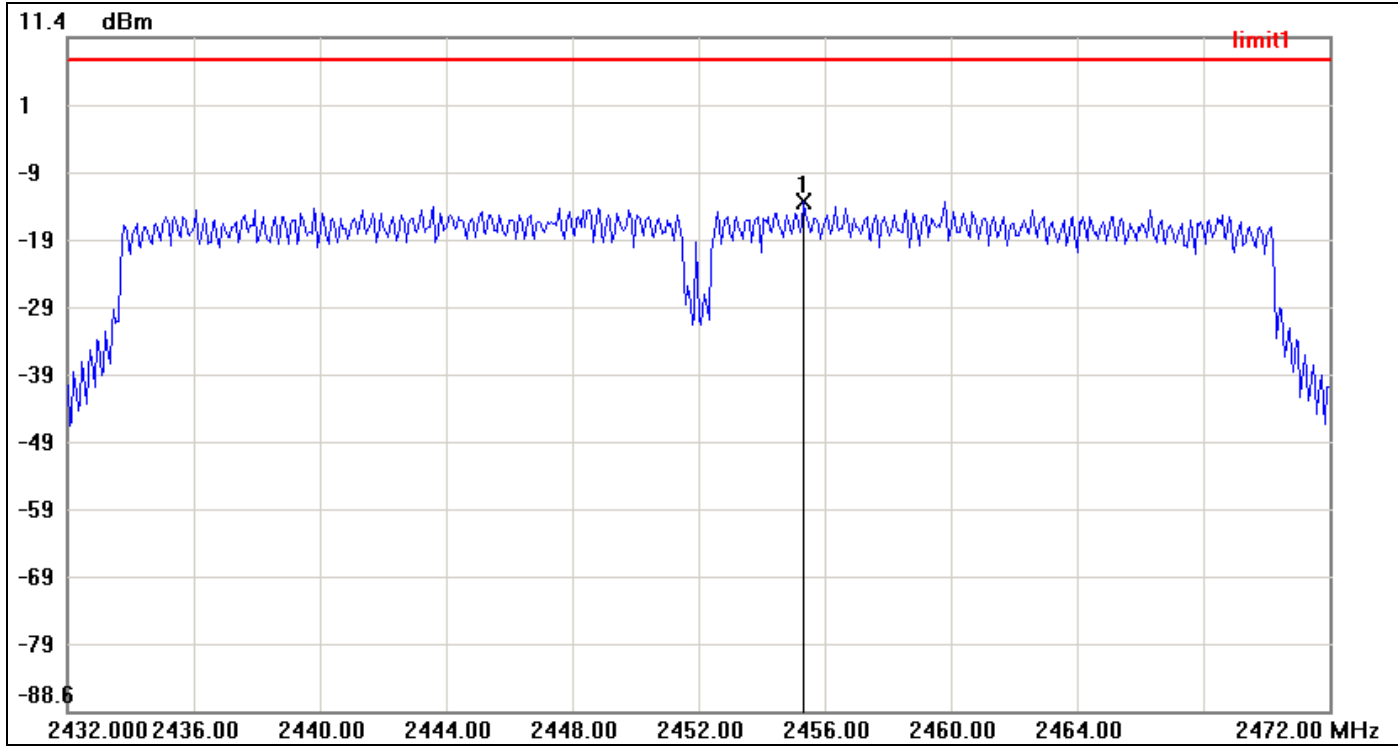

No.	Frequency(MHz)	Result(dBm)	Limit(dBm)	Margin(dBm)
1	2455.3333	-12.91	8.00	-20.91



**IEEE 802.11n HT 40 MHz mode / Chain 1**

**PPSD (CH Low)**

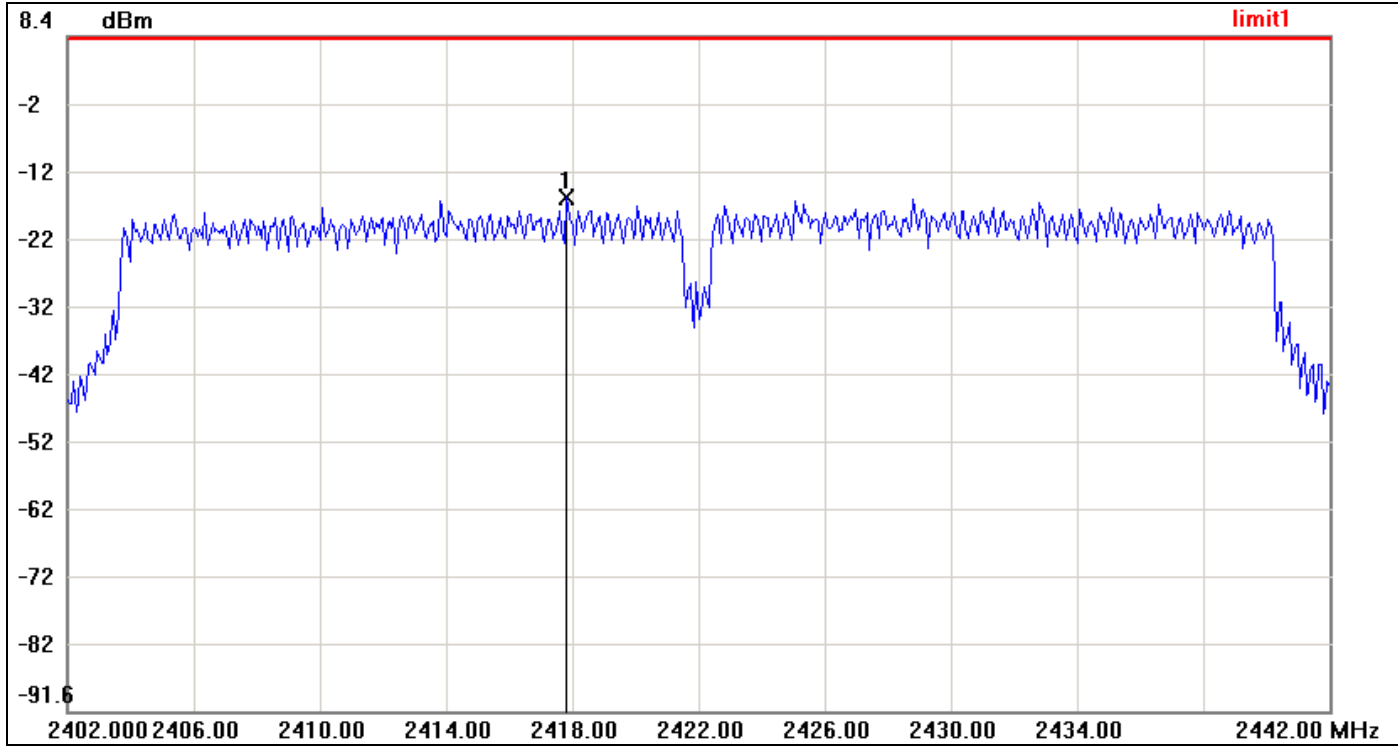

No.	Frequency(MHz)	Result(dBm)	Limit(dBm)	Margin(dBm)
1	2417.8000	-15.56	8.00	-23.56



PPSD (CH Mid)

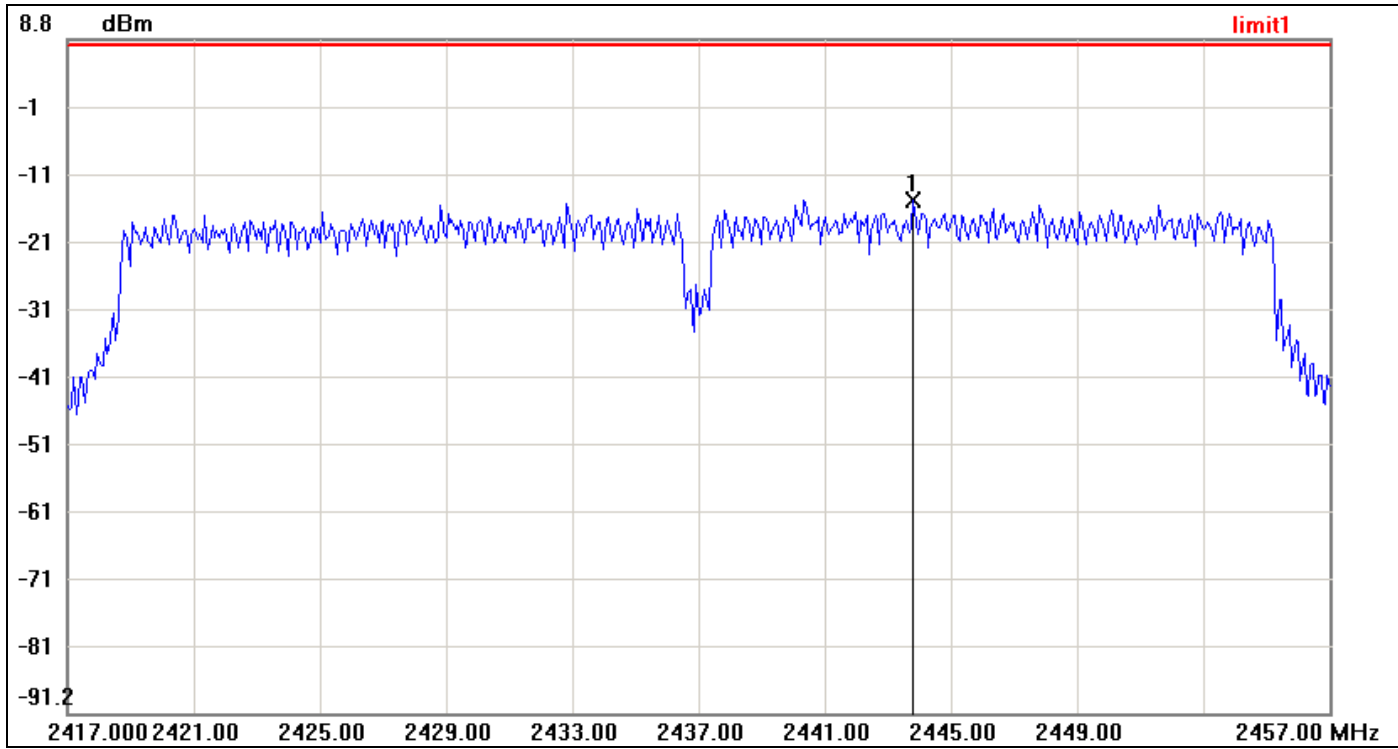

No.	Frequency(MHz)	Result(dBm)	Limit(dBm)	Margin(dBm)
1	2443.8000	-15.06	8.00	-23.06



PPSD (CH High)

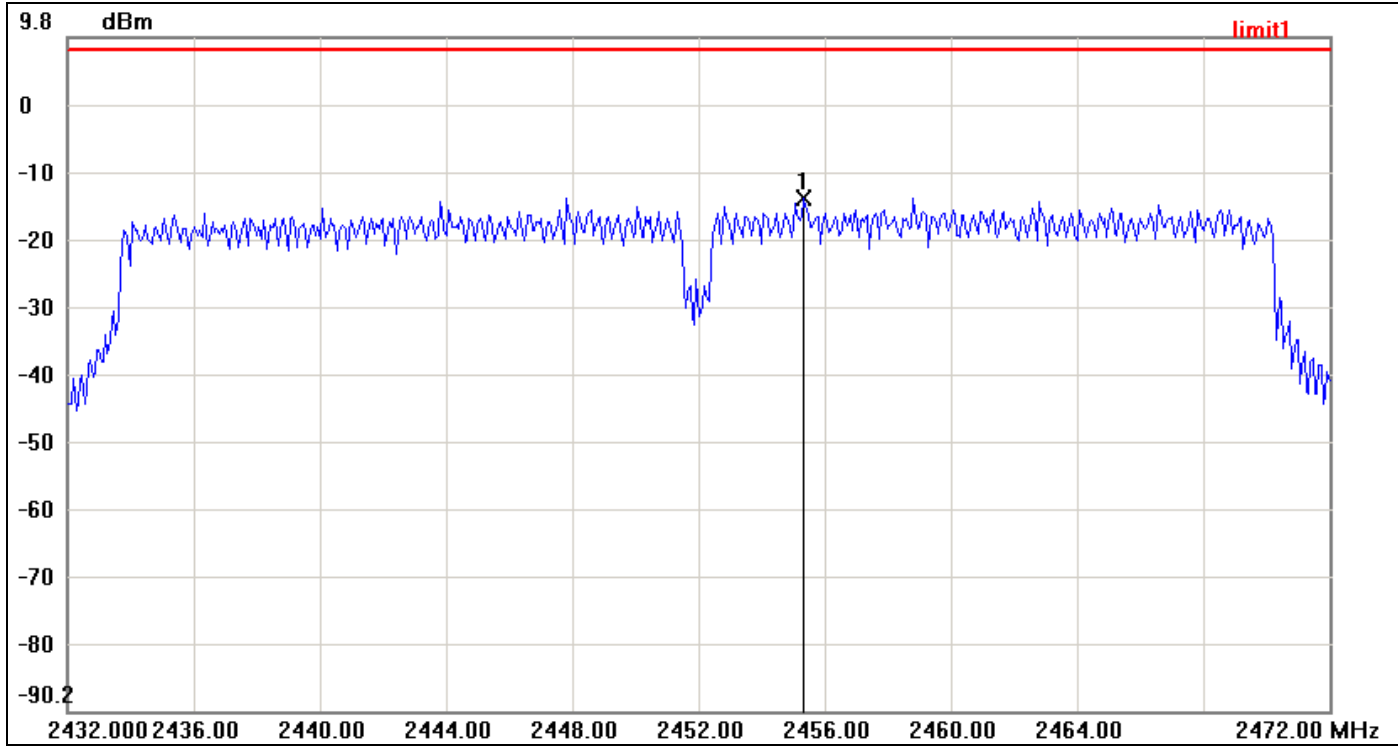

No.	Frequency(MHz)	Result(dBm)	Limit(dBm)	Margin(dBm)
1	2455.3333	-14.11	8.00	-22.11



## 7.6 SPURIOUS EMISSIONS

### 7.6.1 Conducted Measurement

#### LIMIT

According to §15.247(d), in any 100 kHz bandwidth outside the frequency bands in which the spread spectrum intentional radiator is operating, the radio frequency power that is produced by the intentional radiator shall be at least 20 dB below that in the 100 kHz bandwidth within the band that contains the highest level of the desired power, based on either an RF conducted or a radiated measurement, provided the transmitter demonstrates compliance with the peak conducted power limits. In addition, radiated emissions which fall in the restricted bands, as defined in §15.205(a), must also comply with the radiated emission limits specified in 15.209(a) (see Section 15.205(c)).

#### Test Configuration

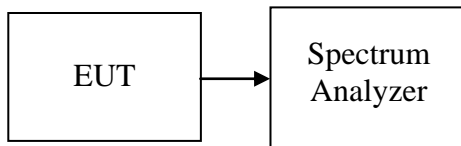

#### TEST PROCEDURE

Conducted RF measurements of the transmitter output were made to confirm that the EUT antenna port conducted emissions meet the specified limit and to identify any spurious signals that require further investigation or measurements on the radiated emissions site.

The transmitter output is connected to the spectrum analyzer. The resolution bandwidth is set to 100 kHz. The video bandwidth is set to 100 kHz.

Measurements are made over the 30MHz to 25GHz range with the transmitter set to the lowest, middle, and highest channels.

#### TEST RESULTS

*No non-compliance noted.*





**Test Plot**

**IEEE 802.11b mode**

**CH Low**

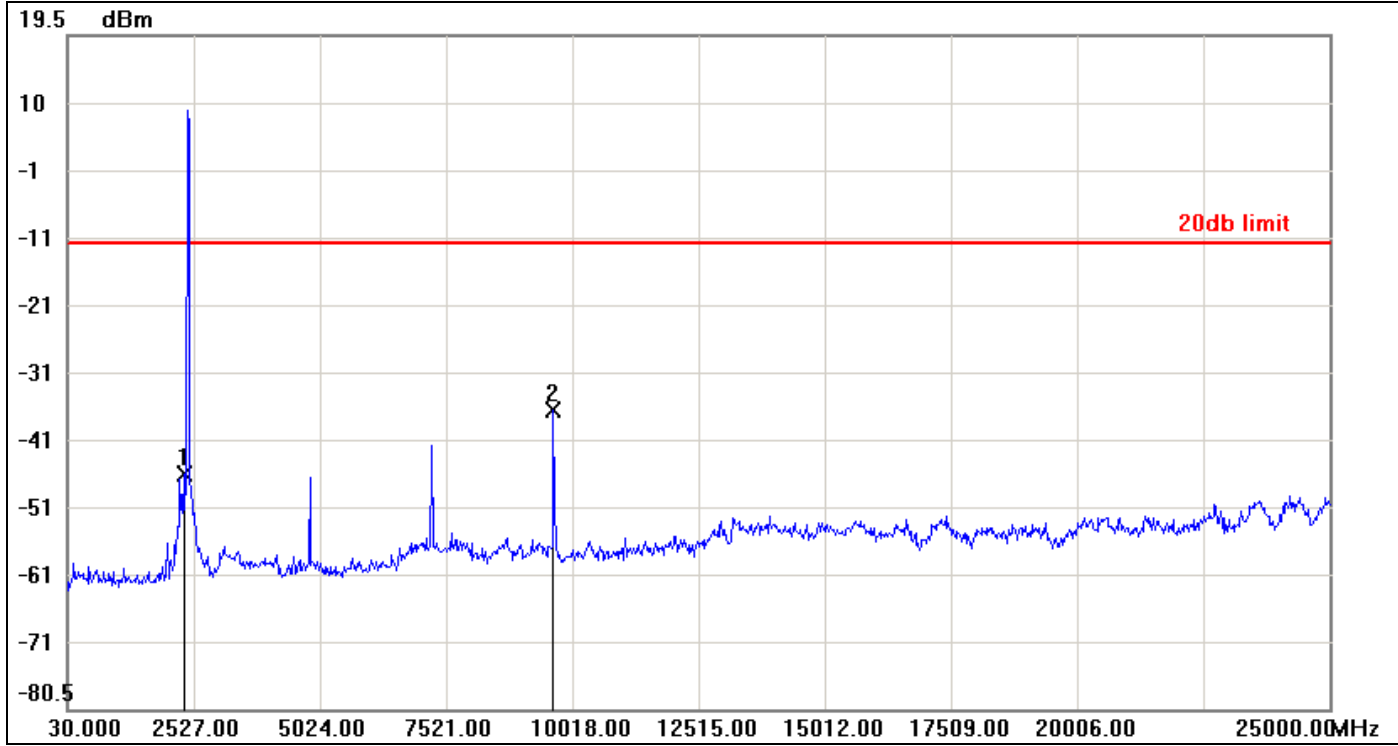

No.	Frequency(MHz)	Result(dBm)	Limit(dBm)	Margin(dBm)
1	2327.2400	-45.65	-11.29	-34.36
2	9643.4500	-36.15	-11.29	-24.86



### CH Mid

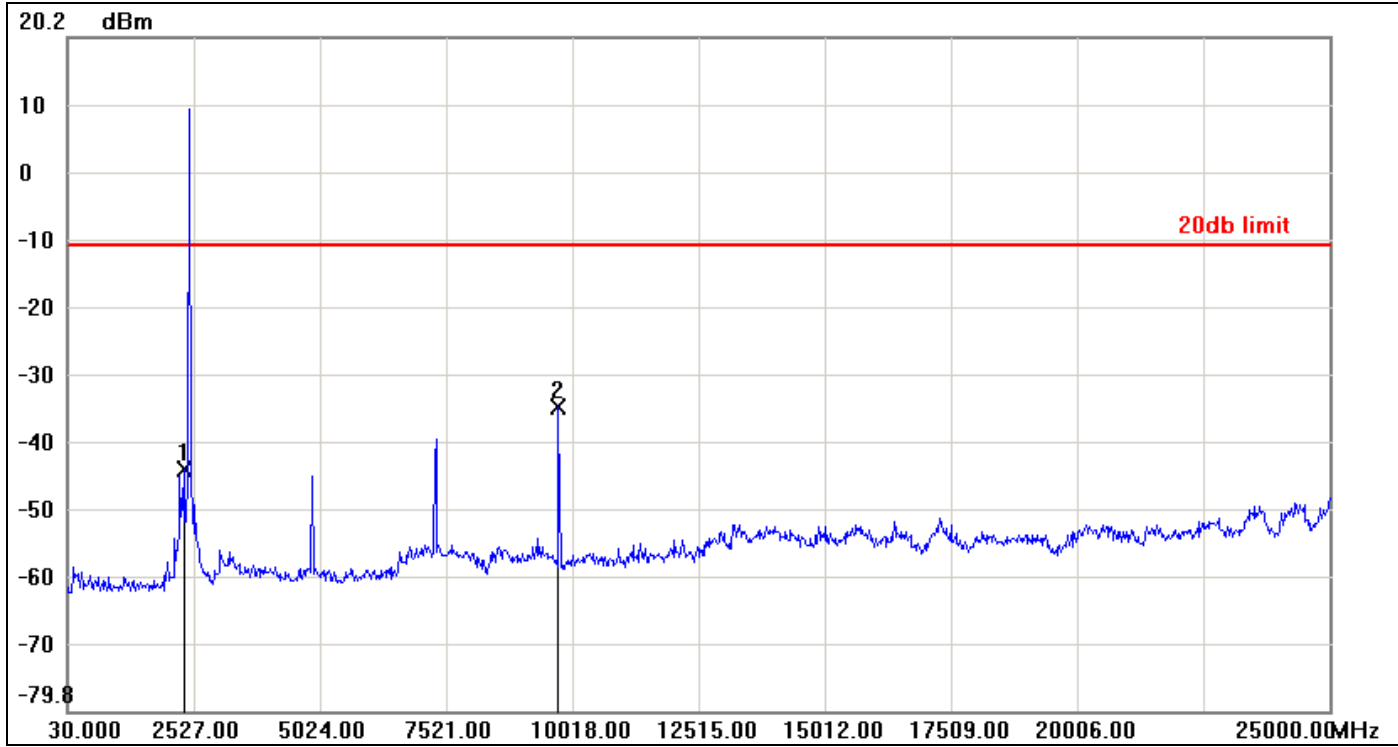

No.	Frequency(MHz)	Result(dBm)	Limit(dBm)	Margin(dBm)
1	2327.2400	-43.96	-10.56	-33.40
2	9743.3300	-34.68	-10.56	-24.12



### CH High

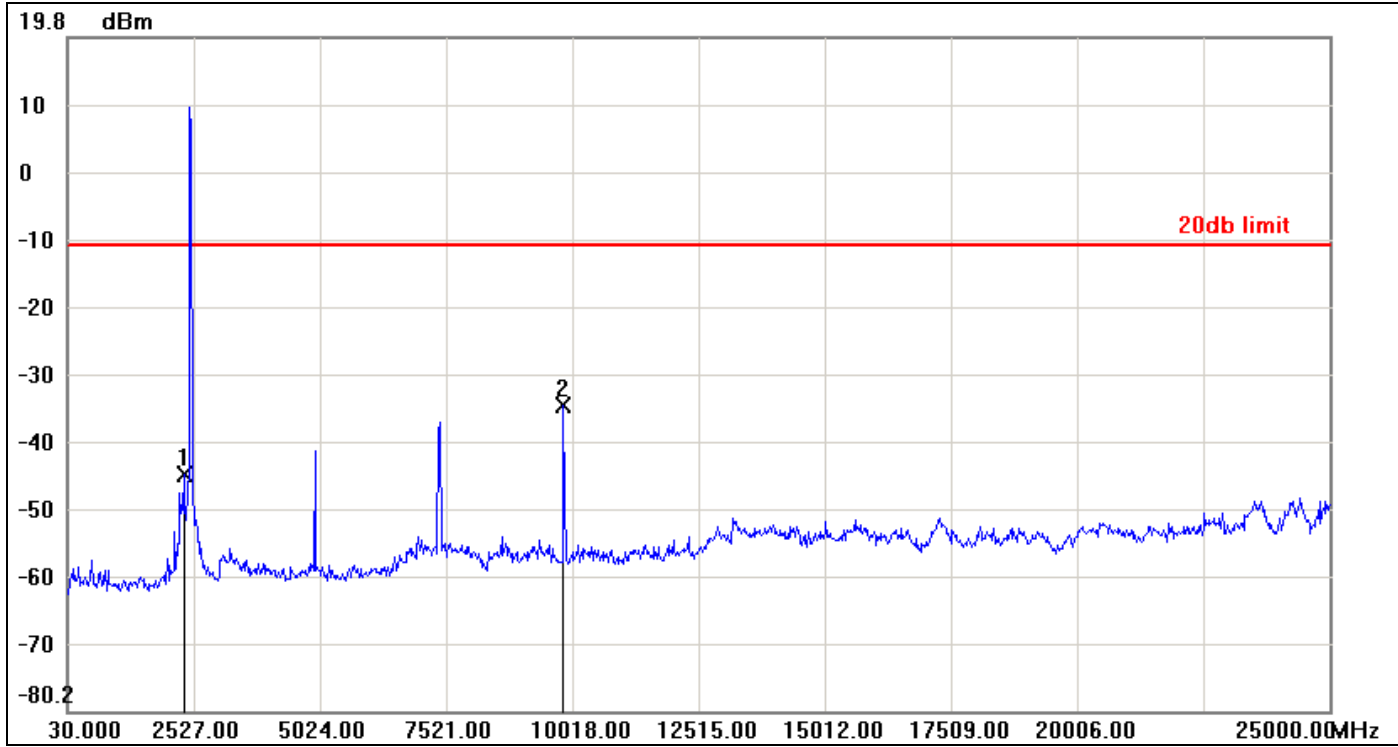

No.	Frequency(MHz)	Result(dBm)	Limit(dBm)	Margin(dBm)
1	2327.2400	-45.10	-10.93	-34.17
2	9843.2100	-34.74	-10.93	-23.81



**IEEE 802.11g mode**

**CH Low**

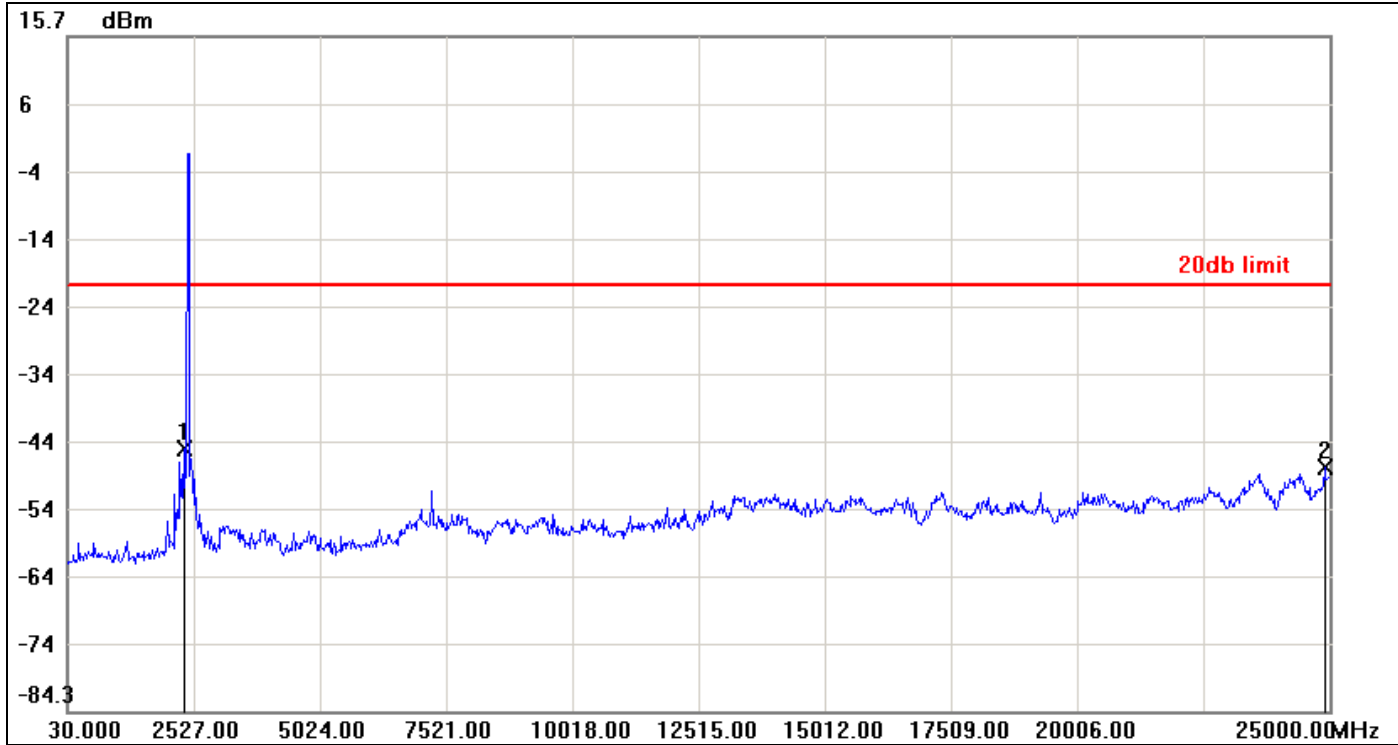

No.	Frequency(MHz)	Result(dBm)	Limit(dBm)	Margin(dBm)
1	2327.2400	-45.43	-21.13	-24.30
2	24900.1200	-48.20	-21.13	-27.07



### CH Mid

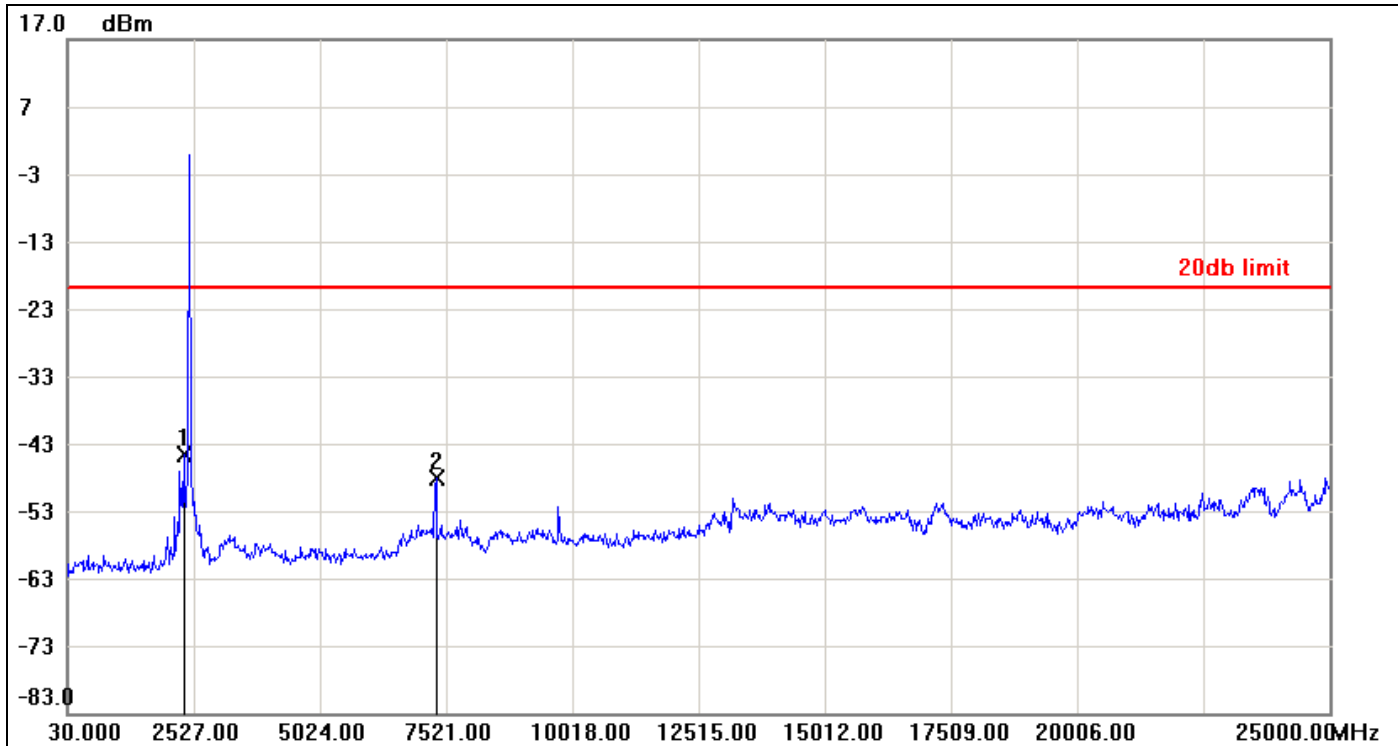

No.	Frequency(MHz)	Result(dBm)	Limit(dBm)	Margin(dBm)
1	2327.2400	-44.70	-19.87	-24.83
2	7321.2400	-48.16	-19.87	-28.29



### CH High

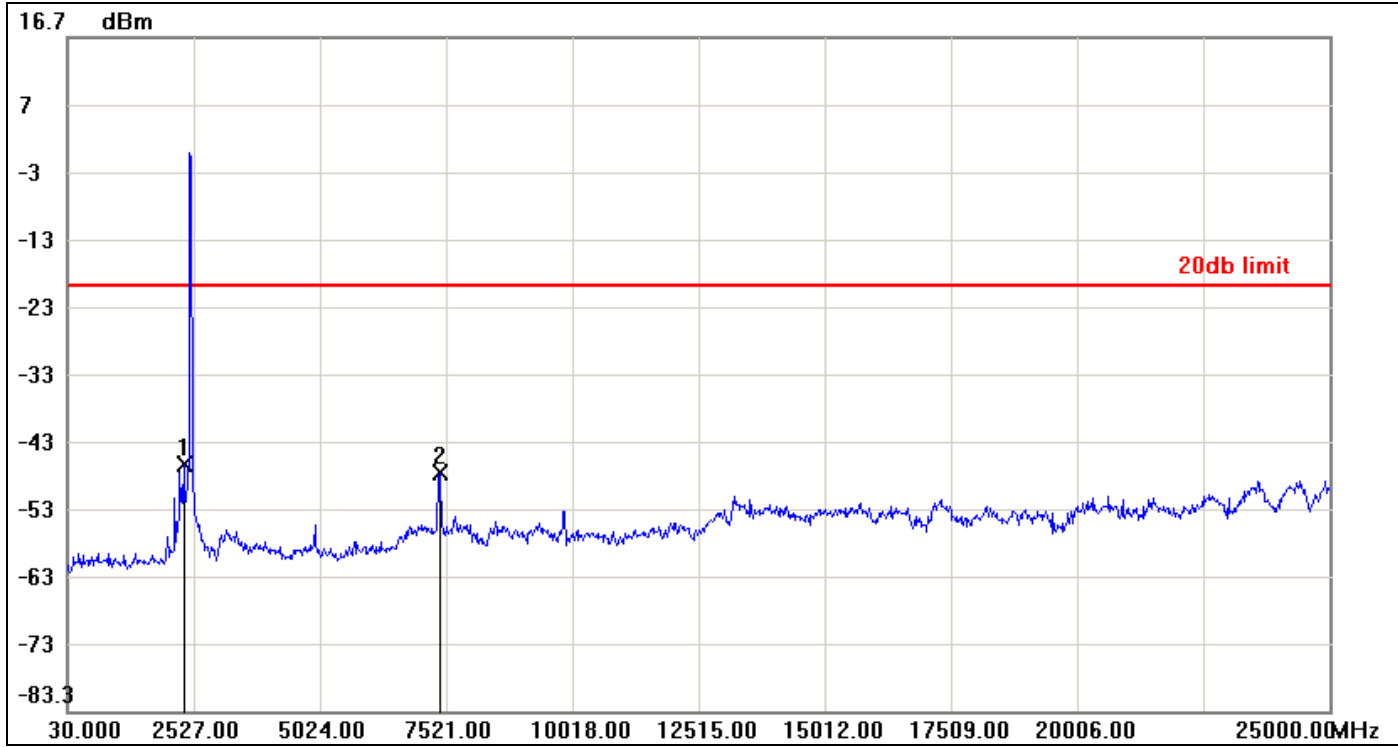

No.	Frequency(MHz)	Result(dBm)	Limit(dBm)	Margin(dBm)
1	2327.2400	-46.76	-20.11	-26.65
2	7396.1500	-47.84	-20.11	-27.73



**IEEE 802.11n HT 20 MHz mode / Chain 0**

**CH Low**

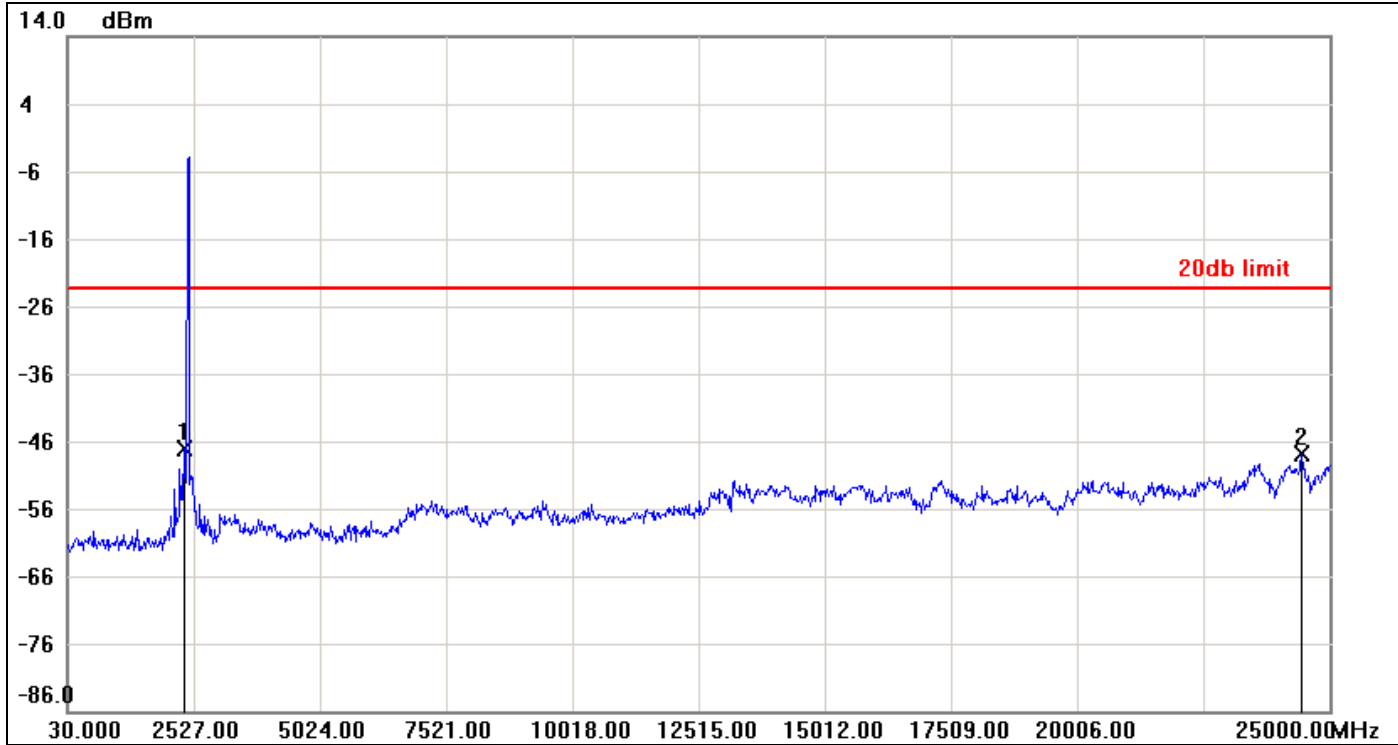

No.	Frequency(MHz)	Result(dBm)	Limit(dBm)	Margin(dBm)
1	2327.2400	-47.16	-23.36	-23.80
2	24450.6600	-47.81	-23.36	-24.45



### CH Mid

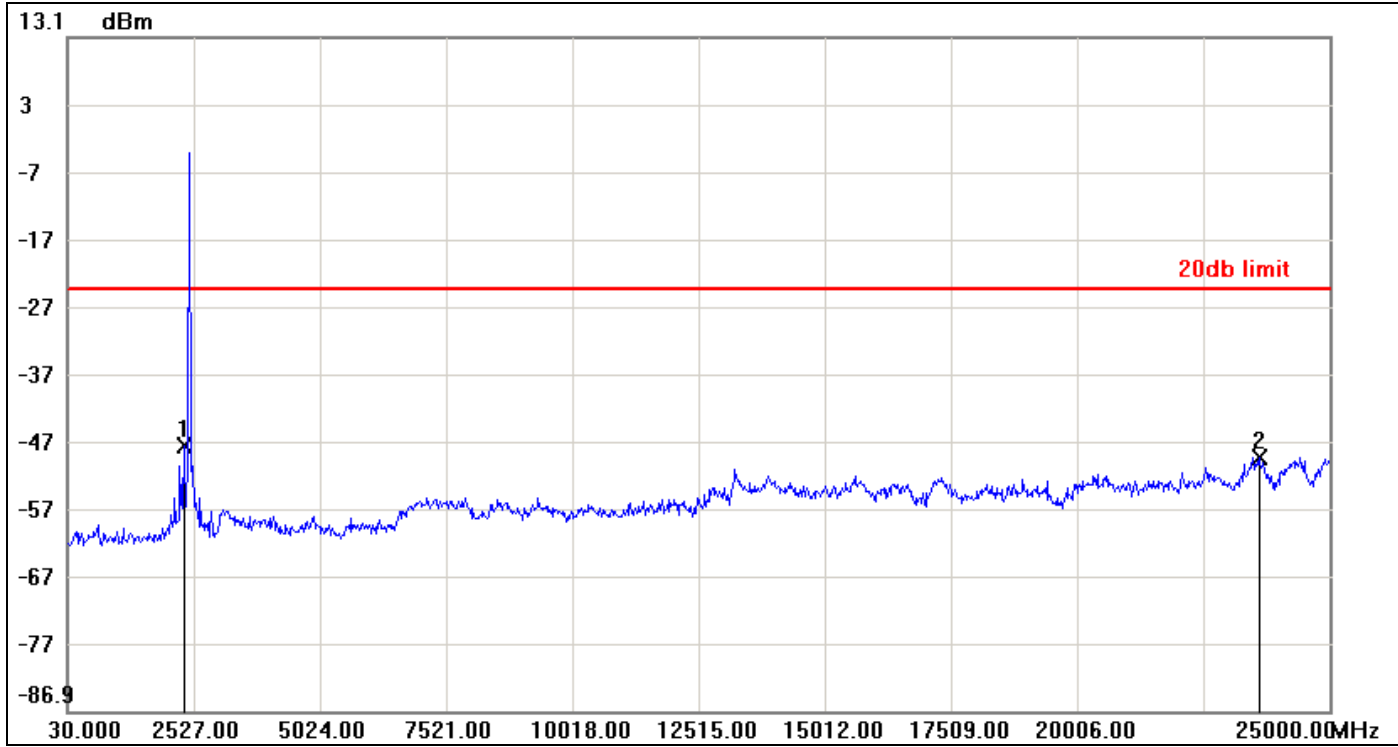

No.	Frequency(MHz)	Result(dBm)	Limit(dBm)	Margin(dBm)
1	2327.2400	-47.51	-24.28	-23.23
2	23601.6800	-49.13	-24.28	-24.85





### CH High

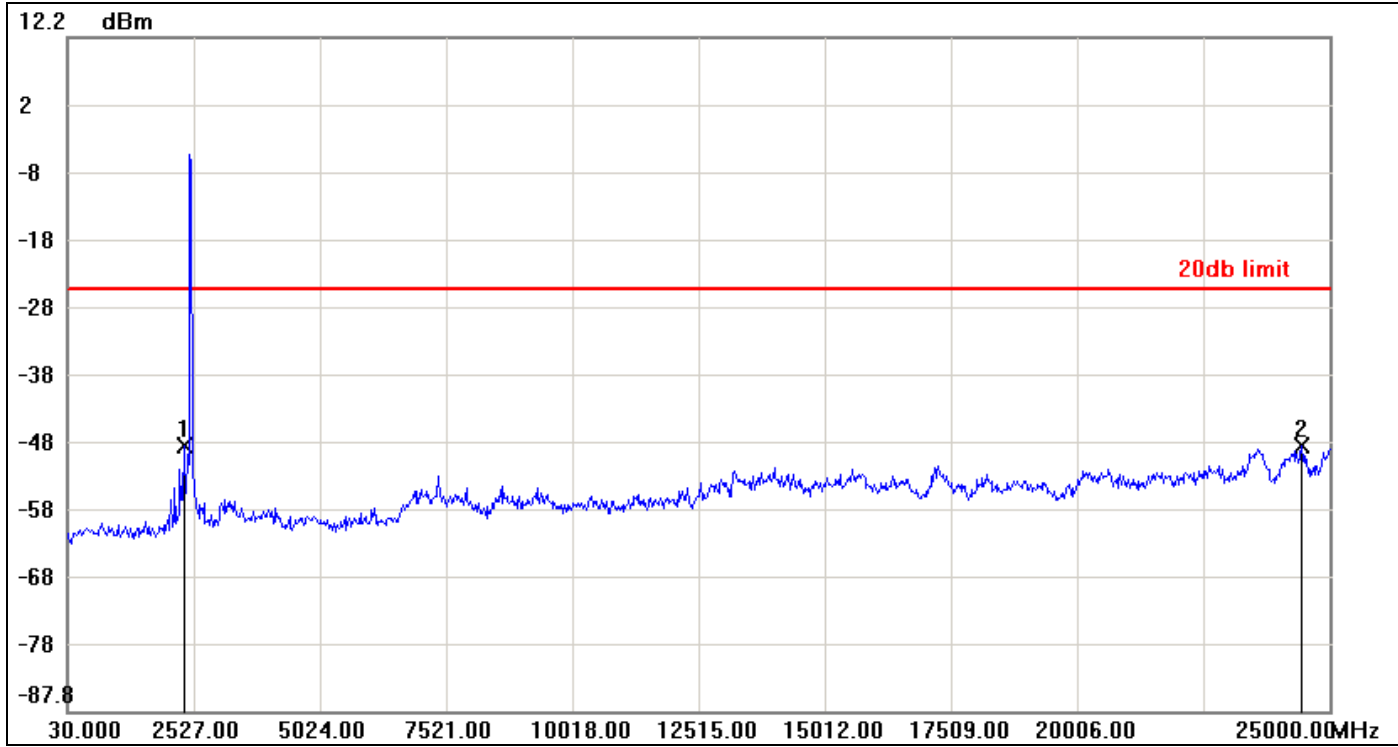

No.	Frequency(MHz)	Result(dBm)	Limit(dBm)	Margin(dBm)
1	2327.2400	-48.43	-25.21	-23.22
2	24450.6600	-48.47	-25.21	-23.26



**IEEE 802.11n HT 20 MHz mode / Chain 1**

**CH Low**

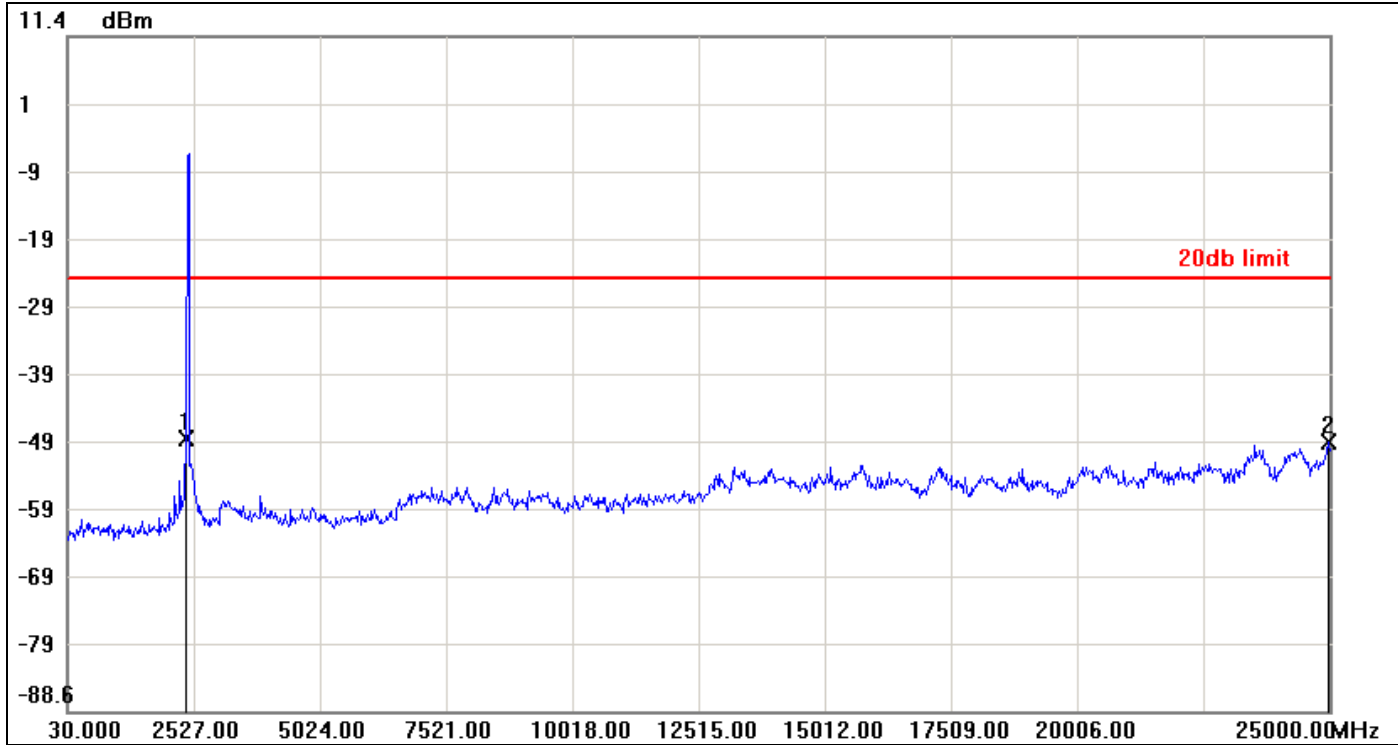

No.	Frequency(MHz)	Result(dBm)	Limit(dBm)	Margin(dBm)
1	2377.1800	-48.20	-24.53	-23.67
2	24975.0300	-48.63	-24.53	-24.10



### CH Mid

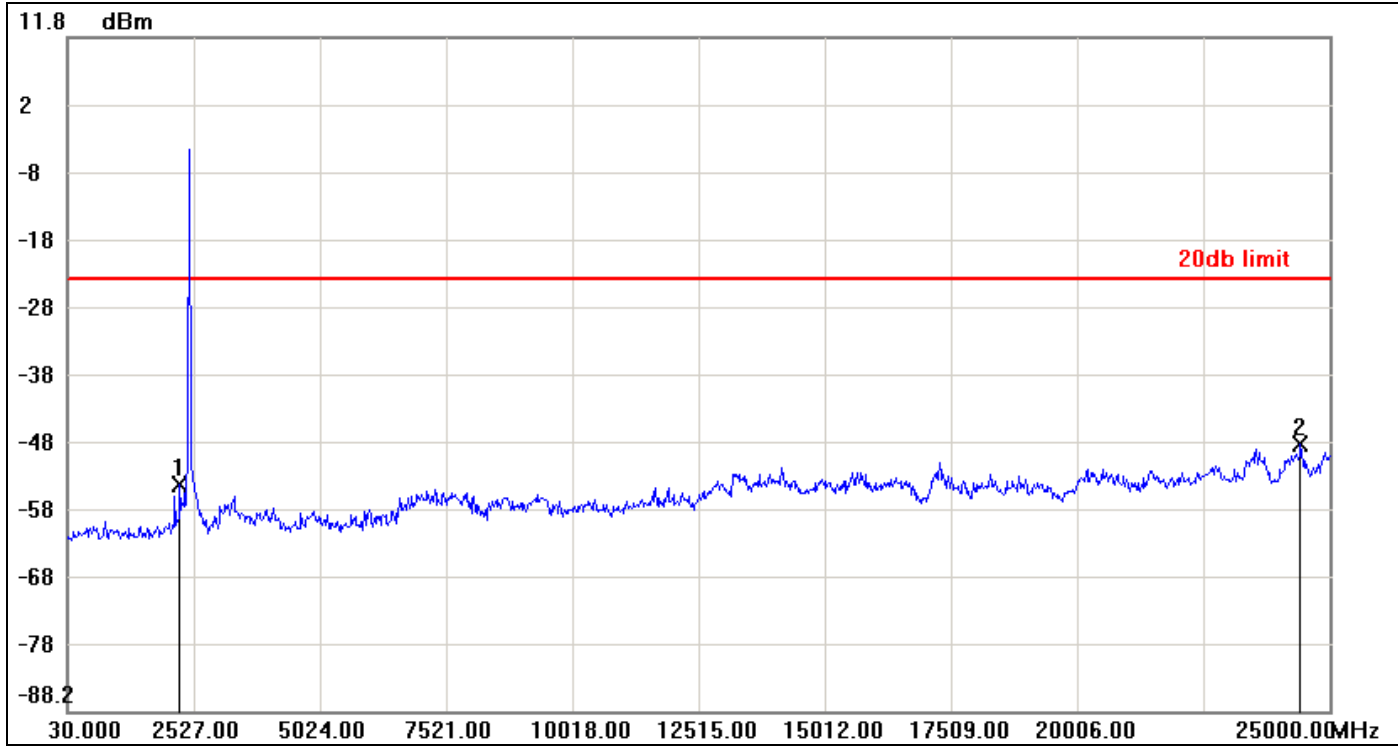

No.	Frequency(MHz)	Result(dBm)	Limit(dBm)	Margin(dBm)
1	2252.3300	-54.49	-23.93	-30.56
2	24425.6900	-48.52	-23.93	-24.59



### CH High

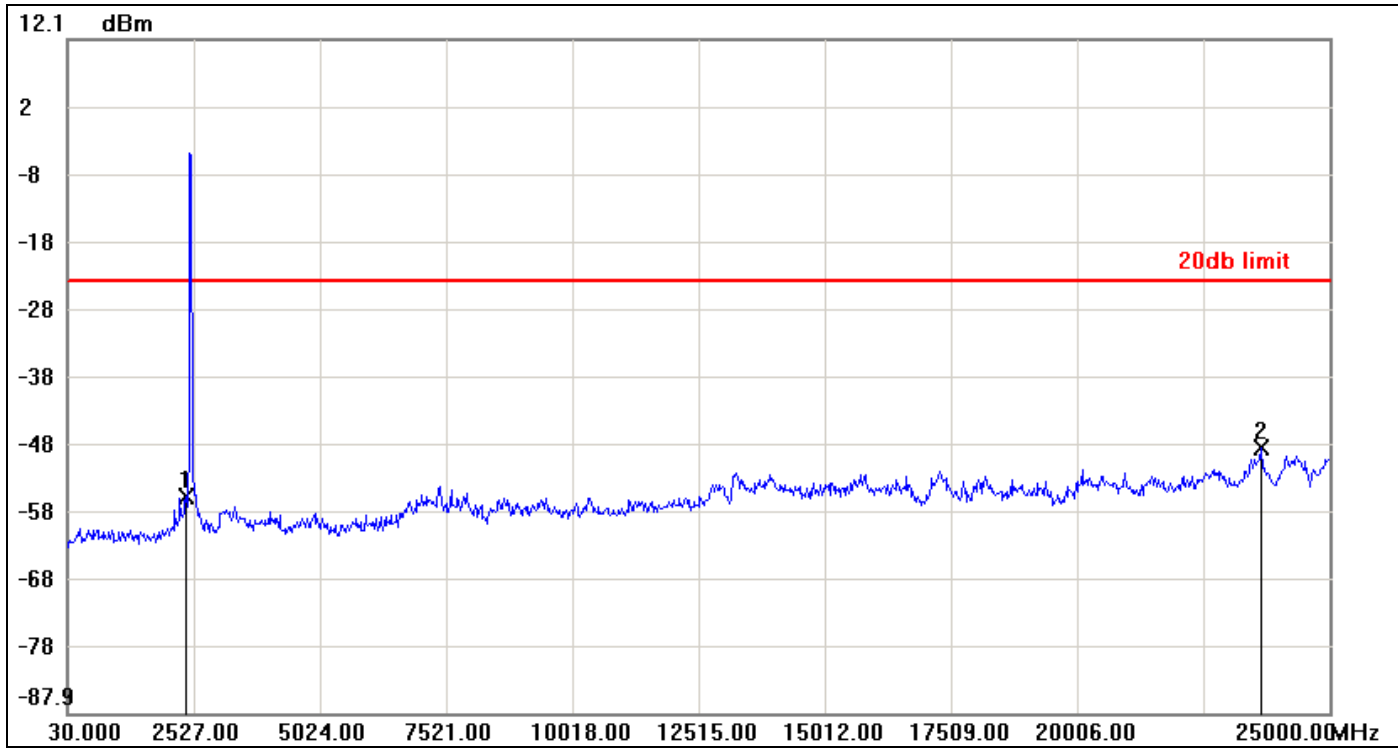

No.	Frequency(MHz)	Result(dBm)	Limit(dBm)	Margin(dBm)
1	2377.1800	-55.82	-23.70	-32.12
2	23651.6200	-48.53	-23.70	-24.83



**IEEE 802.11n HT 40 MHz mode / Chain 0**

**CH Low**

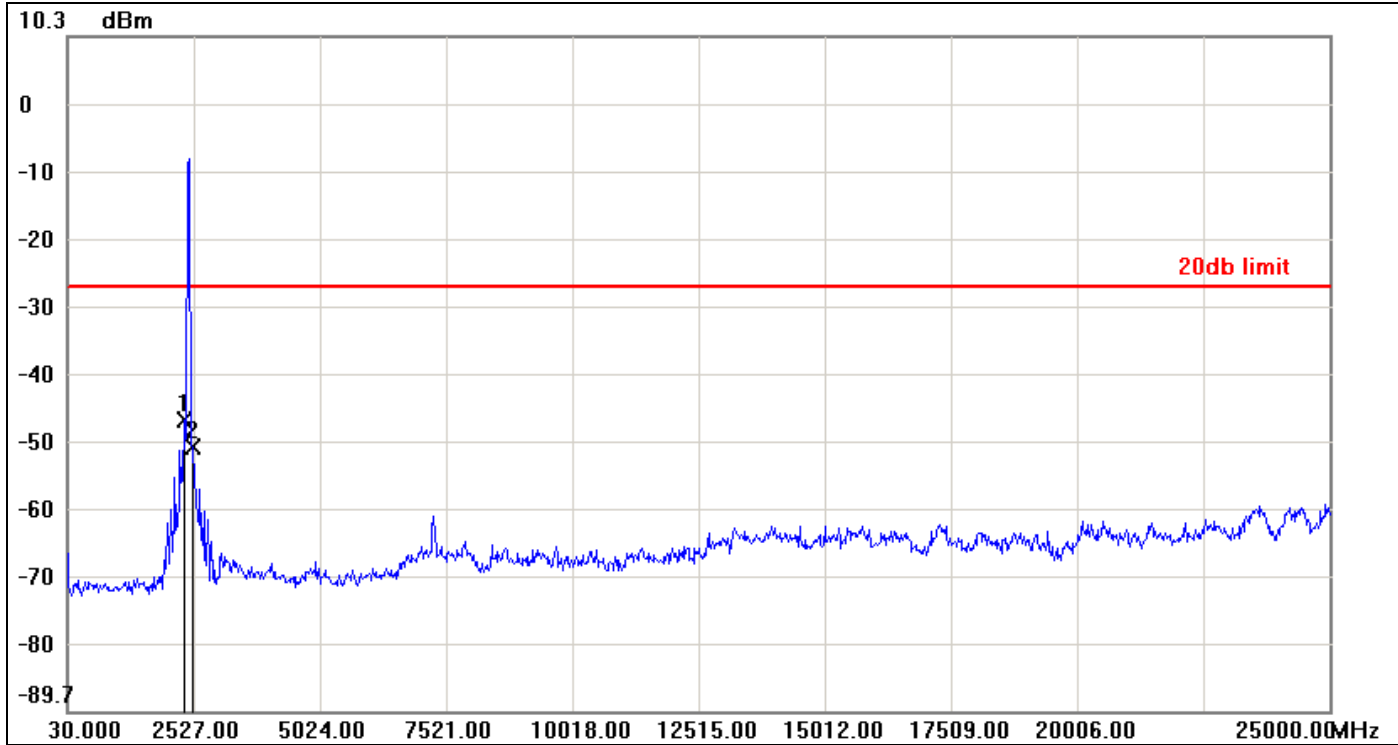

No.	Frequency(MHz)	Result(dBm)	Limit(dBm)	Margin(dBm)
1	2327.2400	-46.65	-26.79	-19.86
2	2502.0300	-50.55	-26.79	-23.76



### CH Mid

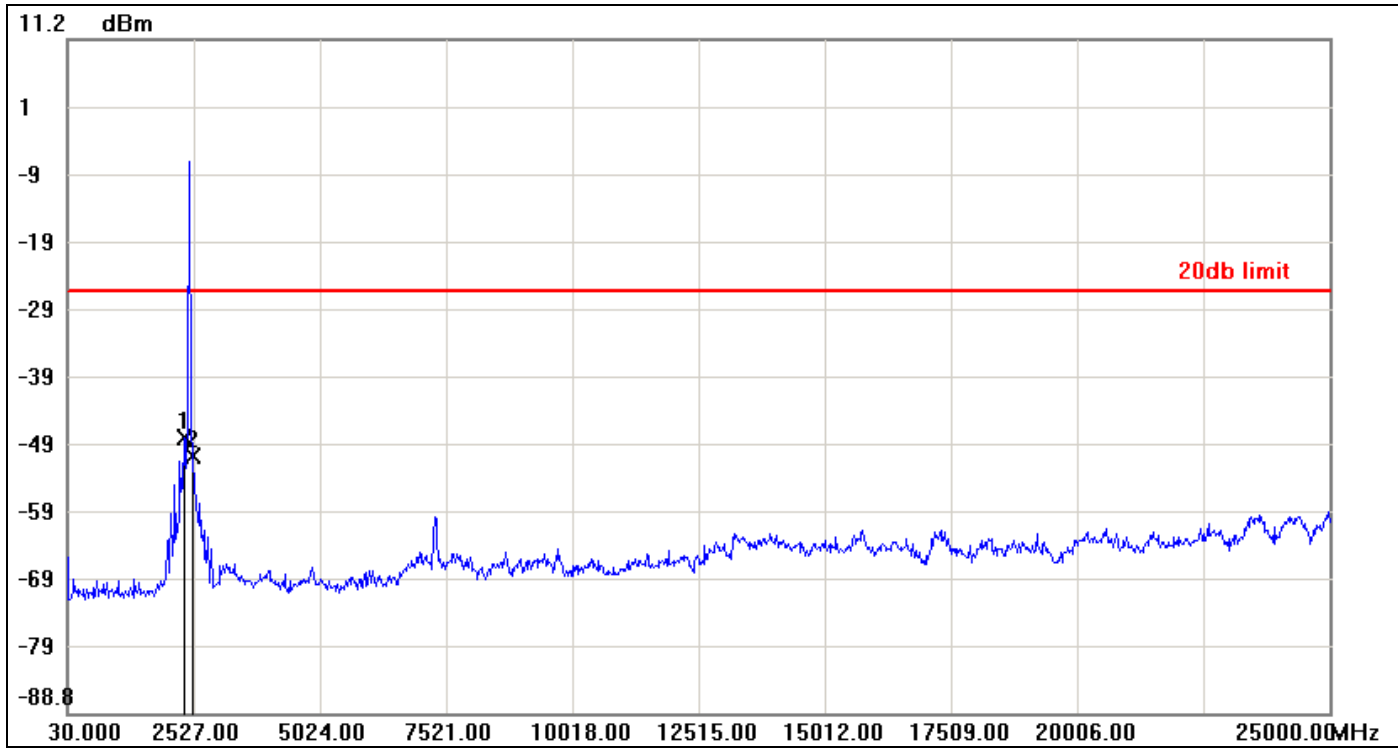

No.	Frequency(MHz)	Result(dBm)	Limit(dBm)	Margin(dBm)
1	2327.2400	-47.81	-26.18	-21.63
2	2502.0300	-50.71	-26.18	-24.53



### CH High

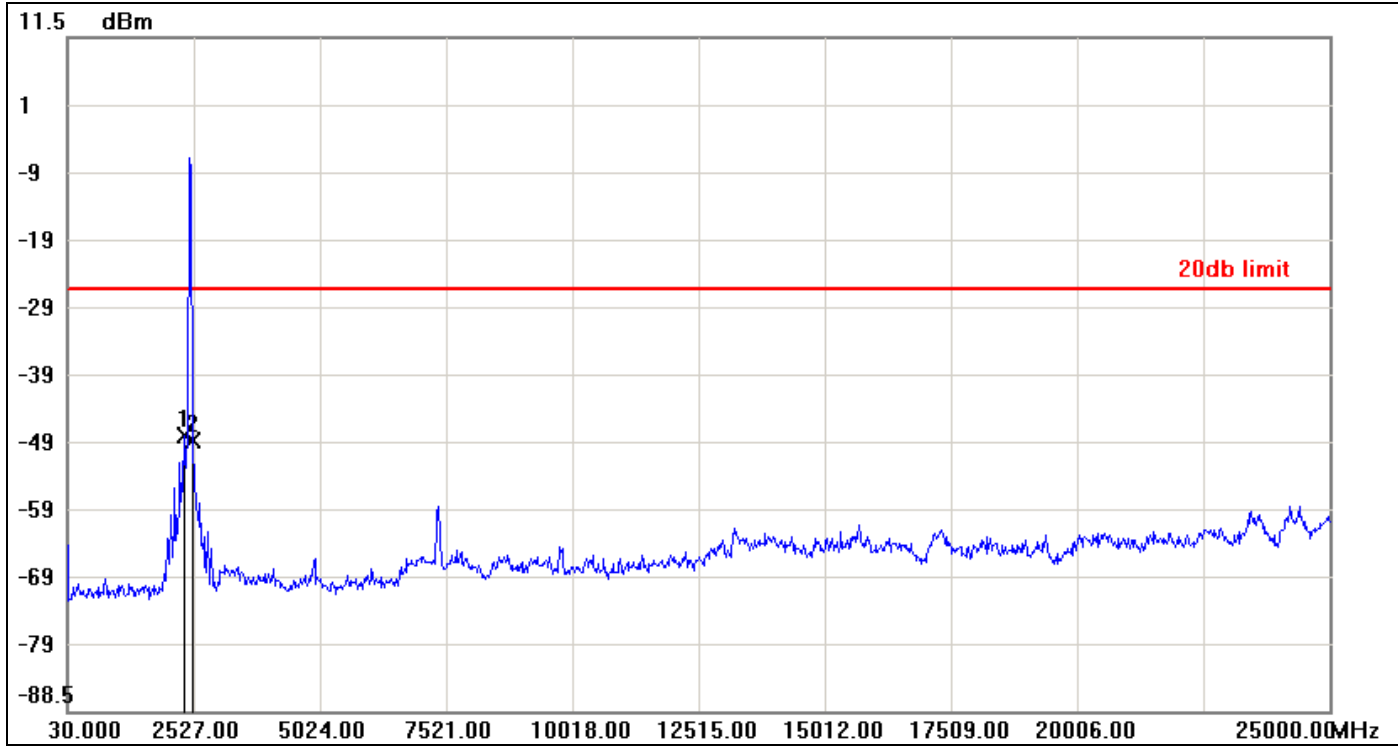

No.	Frequency(MHz)	Result(dBm)	Limit(dBm)	Margin(dBm)
1	2327.2400	-47.57	-25.92	-21.65
2	2502.0300	-48.48	-25.92	-22.56



**IEEE 802.11n HT 40 MHz mode / Chain 1**

**CH Low**

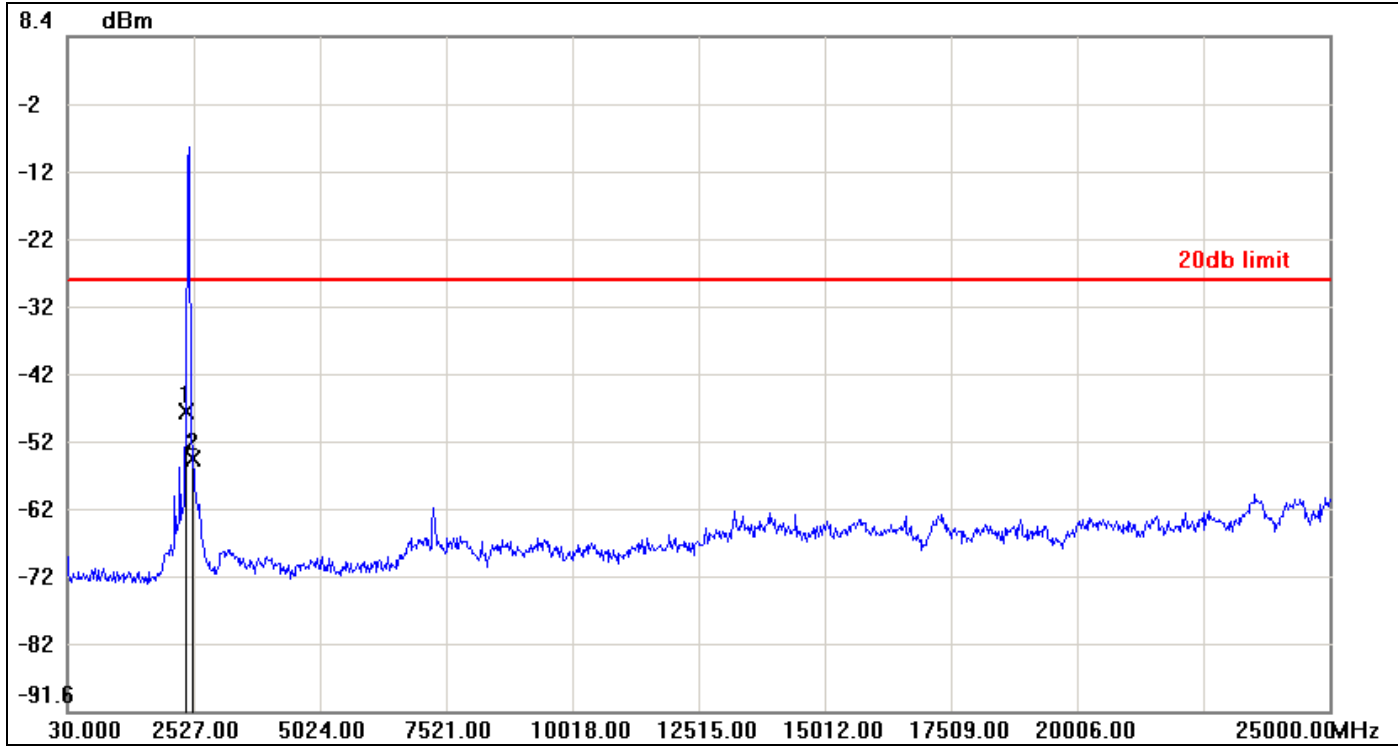

No.	Frequency(MHz)	Result(dBm)	Limit(dBm)	Margin(dBm)
1	2377.1800	-47.23	-27.79	-19.44
2	2502.0300	-54.21	-27.79	-26.42





### CH Mid

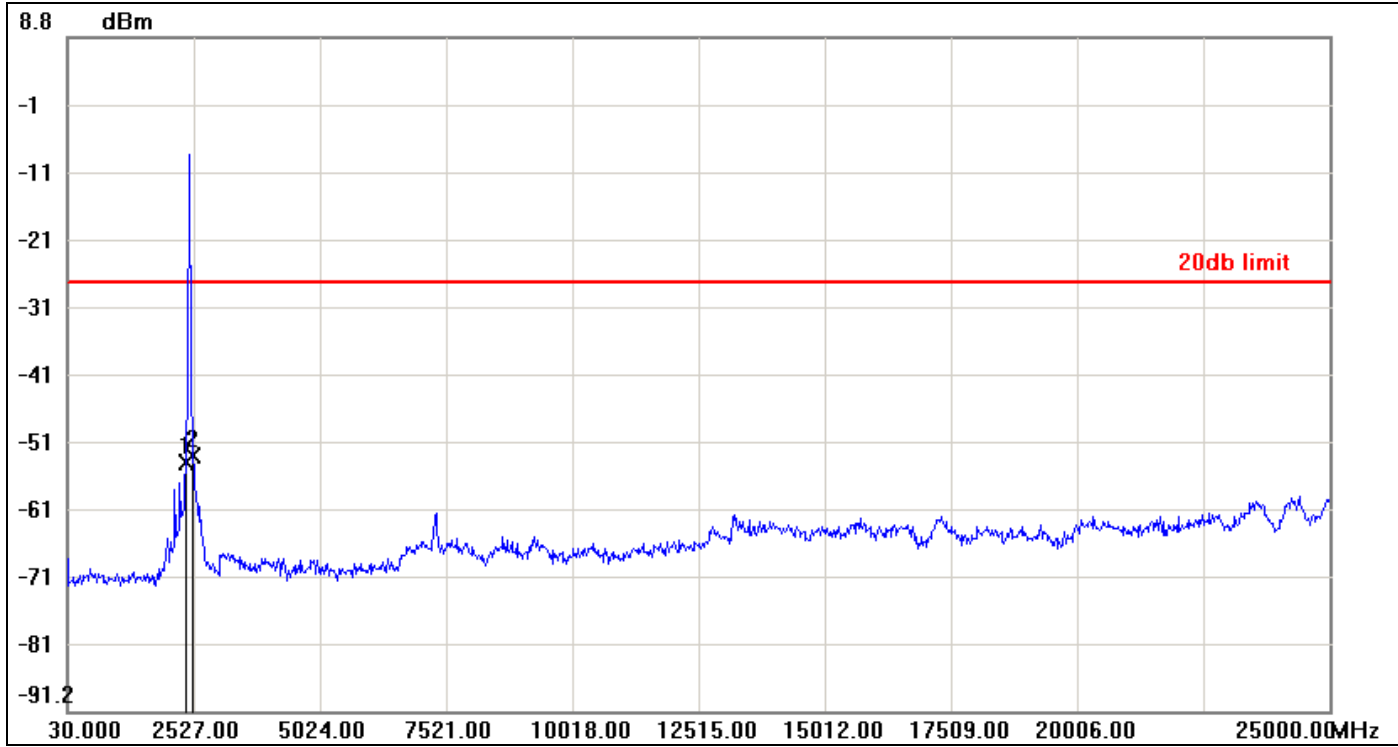

No.	Frequency(MHz)	Result(dBm)	Limit(dBm)	Margin(dBm)
1	2377.1800	-54.36	-27.41	-26.95
2	2502.0300	-53.38	-27.41	-25.97



### CH High

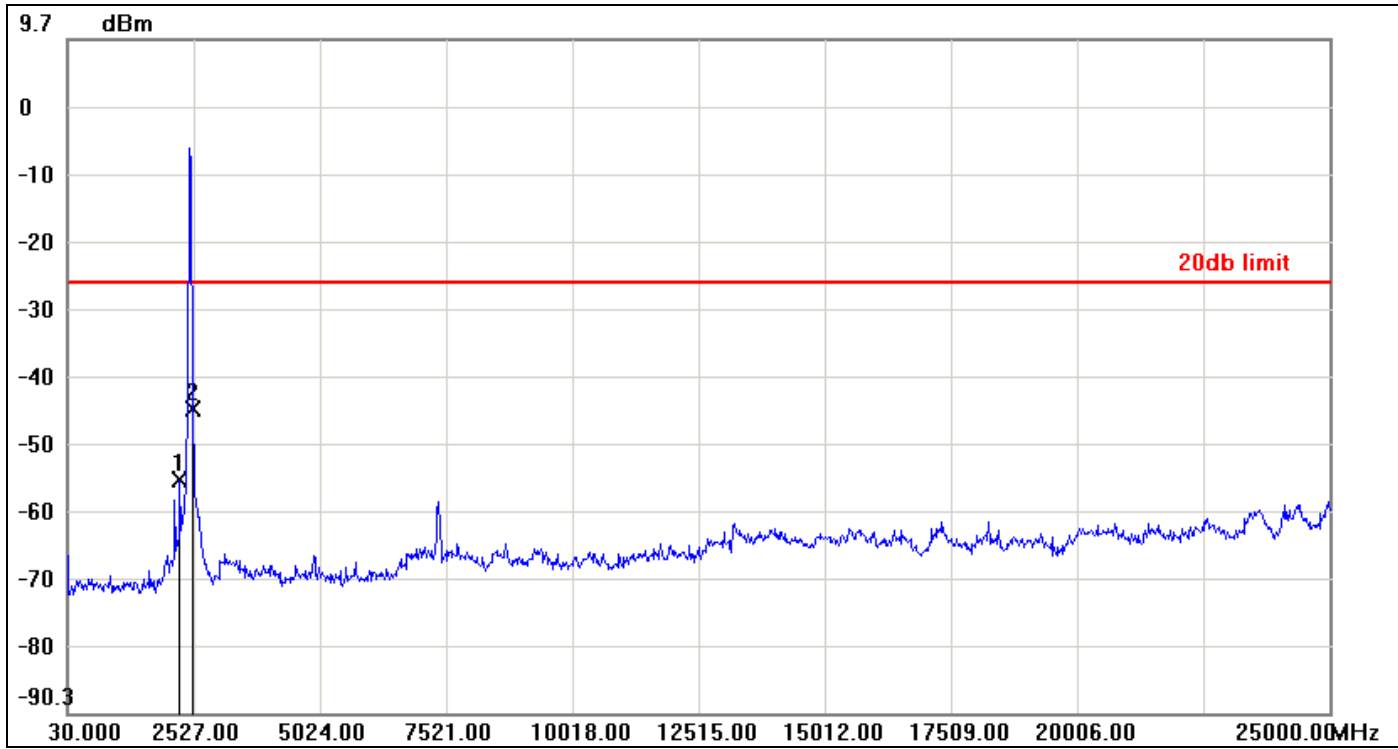

No.	Frequency(MHz)	Result(dBm)	Limit(dBm)	Margin(dBm)
1	2252.3300	-55.77	-26.50	-29.27
2	2502.0300	-45.18	-26.50	-18.68



## 7.7 RADIATED EMISSIONS

### LIMIT

1. According to §15.209(a), except as provided elsewhere in this Subpart, the emissions from an intentional radiator shall not exceed the field strength levels specified in the following table:

Frequency (MHz)	Field Strength ( $\mu\text{V}/\text{m}$ )	Measurement Distance (m)
30-88	100*	3
88-216	150*	3
216-960	200*	3
Above 960	500	3

**Remark:** Except as provided in paragraph (g), fundamental emissions from intentional radiators operating under this Section shall not be located in the frequency bands 54-72 MHz, 76-88 MHz, 174-216 MHz or 470-806 MHz. However, operation within these frequency bands is permitted under other sections of this Part, e.g., Sections 15.231 and 15.241.

2. In the emission table above, the tighter limit applies at the band edges.

Frequency (MHz)	Field Strength ( $\mu\text{V}/\text{m}$ at 3-meter)	Field Strength (dB $\mu\text{V}/\text{m}$ at 3-meter)
30-88	100	40
88-216	150	43.5
216-960	200	46
Above 960	500	54



### Test Configuration

#### 9kHz ~ 30MHz

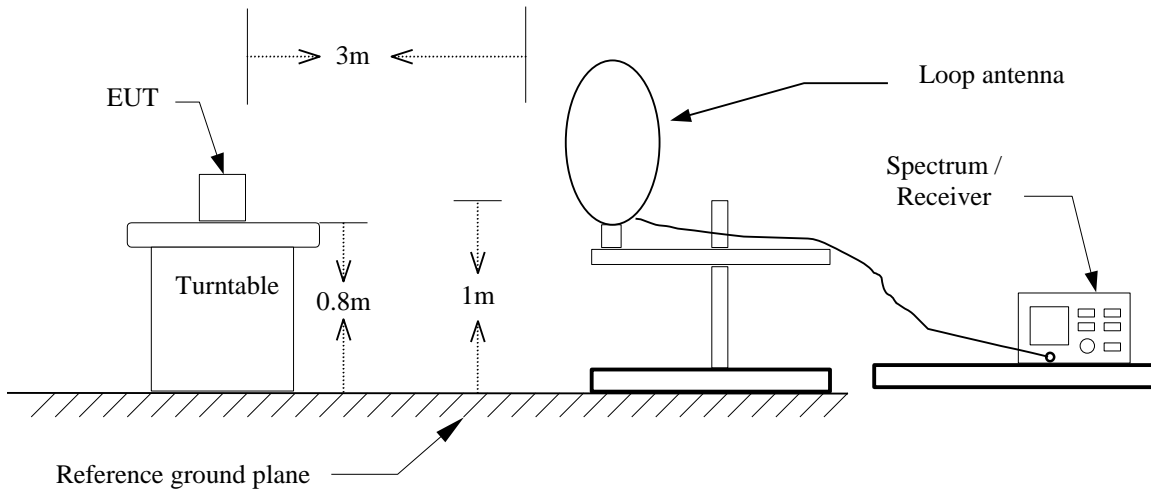

#### 30MHz ~ 1GHz

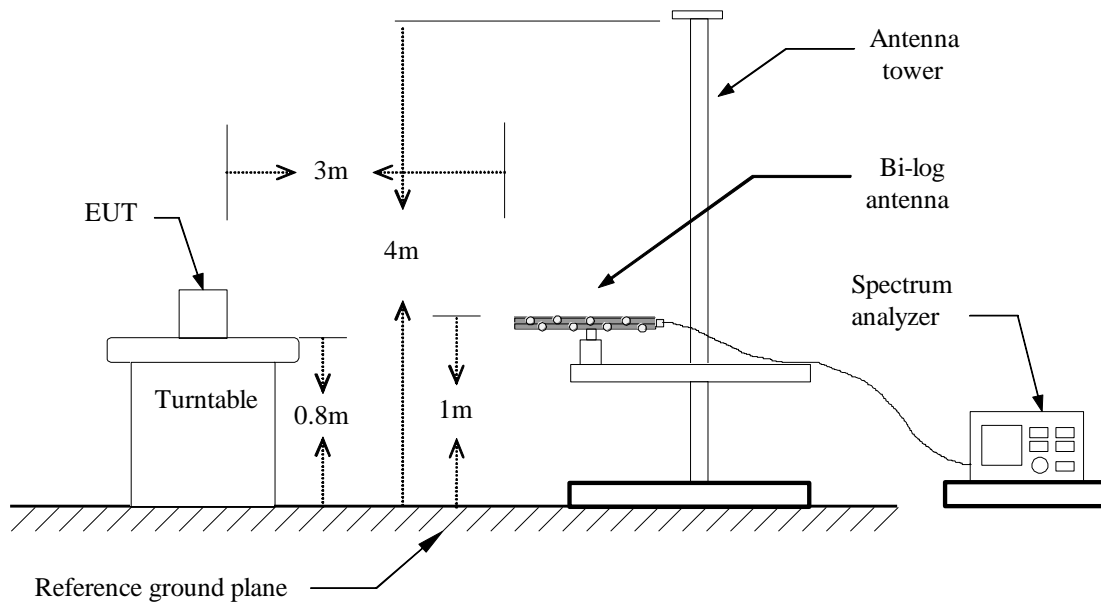



Above 1 GHz

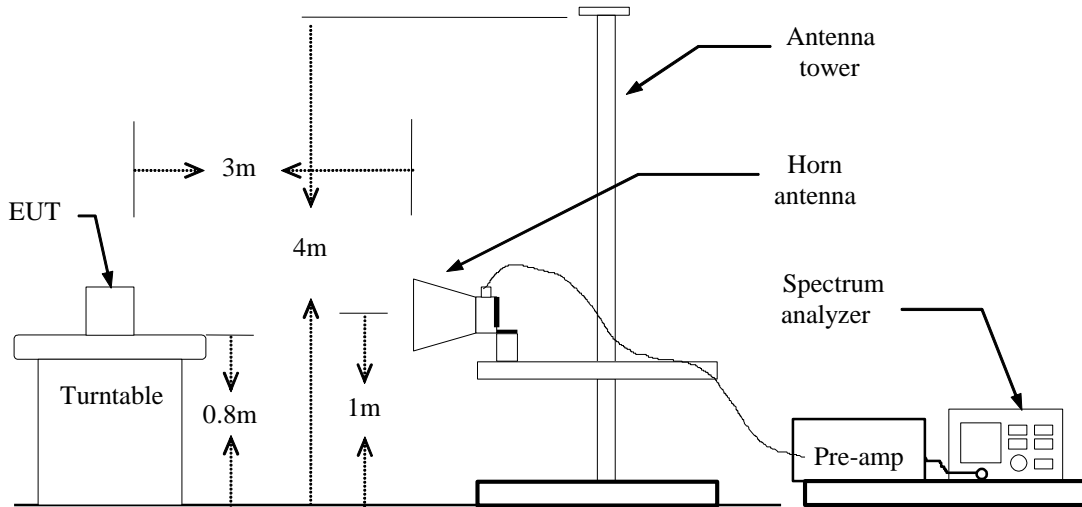



## **TEST PROCEDURE**

1. The EUT is placed on a turntable, which is 0.8m above ground plane.
2. The turntable shall be rotated for 360 degrees to determine the position of maximum emission level.
3. EUT is set 3m away from the receiving antenna, which is varied from 1m to 4m to find out the highest emissions.
4. Maximum procedure was performed on the six highest emissions to ensure EUT compliance.
5. And also, each emission was to be maximized by changing the polarization of receiving antenna both horizontal and vertical.
6. Set the spectrum analyzer in the following setting as:  
Below 1GHz:  
RBW=100kHz / VBW=300kHz / Sweep=AUTO  
Above 1GHz:  
(a) PEAK: RBW=VBW=1MHz / Sweep=AUTO  
(b) AVERAGE: RBW=1MHz / VBW=10Hz / Sweep=AUTO
7. Repeat above procedures until the measurements for all frequencies are complete.

## **TEST RESULTS**

*No non-compliance noted.*



**Below 1GHz**

**Operation Mode:** Normal Link

**Test Date:** October 31, 2014

**Temperature:** 26°C

**Tested by:** David Shu

**Humidity:** 60% RH

**Polarity:** Ver. / Hor.

Frequency (MHz)	Reading (dBuV)	Correction Factor (dB/m)	Result (dBuV/m)	Limit (dBuV/m)	Margin (dB)	Remark	Ant. Pol. (H/V)
63.9500	48.19	-23.39	24.80	40.00	-15.20	Peak	V
75.2667	56.67	-22.83	33.84	40.00	-6.16	Peak	V
170.6500	53.75	-18.85	34.90	43.50	-8.60	Peak	V
396.9833	48.22	-14.09	34.13	46.00	-11.87	Peak	V
502.0667	46.28	-11.80	34.48	46.00	-11.52	Peak	V
613.6167	43.41	-10.18	33.23	46.00	-12.77	Peak	V
115.6833	53.54	-18.14	35.40	43.50	-8.10	peak	H
190.0500	55.33	-18.44	36.89	43.50	-6.61	peak	H
359.8000	45.18	-14.96	30.22	46.00	-15.78	peak	H
503.6833	37.83	-11.77	26.06	46.00	-19.94	peak	H
684.7500	40.79	-8.95	31.84	46.00	-14.16	peak	H
746.1833	41.57	-7.95	33.62	46.00	-12.38	peak	H

**Remark:**

1. No emission found between lowest internal used/generated frequency to 30MHz (9kHz~30MHz)
2. Radiated emissions measured in frequency range from 30 MHz to 1000MHz were made with an instrument using peak/quasi-peak detector mode.
3. Measurements above show only up to 6 maximum emissions noted, or would be lesser, with " N/A " remark, if no specific emissions from the EUT are recorded (ie: margin>20dB from the applicable limit) and considered that's already beyond the background noise floor.
4. Margin (dB) = Result (dBuV/m) – Limit (dBuV/m).



**Above 1 GHz**

**Operation Mode:** TX / IEEE 802.11b / CH Low

**Test Date:** October 30, 2014

**Temperature:** 26°C

**Tested by:** Dennis Li

**Humidity:** 60% RH

**Polarity:** Ver. / Hor.

Frequency (MHz)	Reading (dBuV)	Correction Factor (dB/m)	Result (dBuV/m)	Limit (dBuV/m)	Margin (dB)	Remark	Ant. Pol. (H/V)
1716.000	50.99	-4.20	46.79	74.00	-27.21	peak	V
4825.000	50.93	4.01	54.94	74.00	-19.06	peak	V
4825.000	49.70	4.01	53.71	54.00	-0.29	AVG	V
7235.000	43.06	10.64	53.70	74.00	-20.30	peak	V
7235.000	40.98	10.64	51.62	54.00	-2.38	AVG	V
N/A							
1696.000	50.56	-4.32	46.24	74.00	-27.76	peak	H
4825.000	51.18	4.01	55.19	74.00	-18.81	peak	H
4825.000	49.40	4.01	53.41	54.00	-0.59	AVG	H
7235.000	40.86	10.64	51.50	74.00	-22.50	peak	H
N/A							

**Remark:**

1. Measuring frequencies from 1 GHz to the 10th harmonic of highest fundamental frequency.
2. Radiated emissions measured in frequency above 1000MHz were made with an instrument using peak/average detector mode.
3. Average test would be performed if the peak result were greater than the average limit or as required by the applicant.
4. Data of measurement within this frequency range shown " --- " in the table above means the reading of emissions are attenuated more than 20dB below the permissible limits or the field strength is too small to be measured.
5. Measurements above show only up to 6 maximum emissions noted, or would be lesser, with " N/A " remark, if no specific emissions from the EUT are recorded (ie: margin > 20dB from the applicable limit) and considered that's already beyond the background noise floor.
6. Margin (dB) = Remark result (dBuV/m) – Average limit (dBuV/m).





**Operation Mode:** TX / IEEE 802.11b / CH Mid

**Test Date:** October 30, 2014

**Temperature:** 26°C

**Tested by:** Dennis Li

**Humidity:** 60% RH

**Polarity:** Ver. / Hor.

Frequency (MHz)	Reading (dBuV)	Correction Factor (dB/m)	Result (dBuV/m)	Limit (dBuV/m)	Margin (dB)	Remark	Ant. Pol. (H/V)
1790.000	50.50	-3.75	46.75	74.00	-27.25	peak	V
4875.000	50.60	3.92	54.52	74.00	-19.48	peak	V
4875.000	48.71	3.92	52.63	54.00	-1.37	AVG	V
7310.000	43.68	10.71	54.39	74.00	-19.61	peak	V
7310.000	39.52	10.71	50.23	54.00	-3.77	AVG	V
N/A							
1786.000	50.04	-3.77	46.27	74.00	-27.73	peak	H
4875.000	50.48	3.92	54.40	74.00	-19.60	peak	H
4875.000	48.30	3.92	52.22	54.00	-1.78	AVG	H
7310.000	41.01	10.71	51.72	74.00	-22.28	peak	H
7310.000	37.54	10.71	48.25	54.00	-5.75	AVG	H
N/A							

**Remark:**

1. Measuring frequencies from 1 GHz to the 10th harmonic of highest fundamental frequency.
2. Radiated emissions measured in frequency above 1000MHz were made with an instrument using peak/average detector mode.
3. Average test would be performed if the peak result were greater than the average limit or as required by the applicant.
4. Data of measurement within this frequency range shown “ --- ” in the table above means the reading of emissions are attenuated more than 20dB below the permissible limits or the field strength is too small to be measured.
5. Measurements above show only up to 6 maximum emissions noted, or would be lesser, with “ N/A ” remark, if no specific emissions from the EUT are recorded (ie: margin > 20dB from the applicable limit) and considered that's already beyond the background noise floor.
6. Margin (dB) = Remark result (dBuV/m) – Average limit (dBuV/m).



**Operation Mode:** TX / IEEE 802.11b / CH High

**Test Date:** October 30, 2014

**Temperature:** 26°C

**Tested by:** Dennis Li

**Humidity:** 60% RH

**Polarity:** Ver. / Hor.

Frequency (MHz)	Reading (dBuV)	Correction Factor (dB/m)	Result (dBuV/m)	Limit (dBuV/m)	Margin (dB)	Remark	Ant. Pol. (H/V)
1498.000	51.28	-5.52	45.76	74.00	-28.24	peak	V
4925.000	50.06	3.90	53.96	74.00	-20.04	peak	V
4925.000	48.70	3.90	52.60	54.00	-1.40	AVG	V
7385.000	44.37	10.79	55.16	74.00	-18.84	peak	V
7385.000	40.26	10.79	51.05	54.00	-2.95	AVG	V
N/A							
1862.000	50.44	-3.31	47.13	74.00	-26.87	peak	H
4925.000	50.94	3.90	54.84	74.00	-19.16	peak	H
4925.000	49.78	3.90	53.68	54.00	-0.32	AVG	H
7385.000	40.33	10.79	51.12	74.00	-22.88	peak	H
N/A							

**Remark:**

1. Measuring frequencies from 1 GHz to the 10th harmonic of highest fundamental frequency.
2. Radiated emissions measured in frequency above 1000MHz were made with an instrument using peak/average detector mode.
3. Average test would be performed if the peak result were greater than the average limit or as required by the applicant.
4. Data of measurement within this frequency range shown " --- " in the table above means the reading of emissions are attenuated more than 20dB below the permissible limits or the field strength is too small to be measured.
5. Measurements above show only up to 6 maximum emissions noted, or would be lesser, with " N/A " remark, if no specific emissions from the EUT are recorded (ie: margin > 20dB from the applicable limit) and considered that's already beyond the background noise floor.
6. Margin (dB) = Remark result (dBuV/m) – Average limit (dBuV/m).



**Operation Mode:** TX / IEEE 802.11g / CH Low

**Test Date:** October 30, 2014

**Temperature:** 26°C

**Tested by:** Dennis Li

**Humidity:** 60% RH

**Polarity:** Ver. / Hor.

Frequency (MHz)	Reading (dBuV)	Correction Factor (dB/m)	Result (dBuV/m)	Limit (dBuV/m)	Margin (dB)	Remark	Ant. Pol. (H/V)
1722.000	51.03	-4.16	46.87	74.00	-27.13	peak	V
N/A							
1124.000	52.69	-7.49	45.20	74.00	-28.80	peak	H
N/A							

**Remark:**

1. Measuring frequencies from 1 GHz to the 10th harmonic of highest fundamental frequency.
2. Radiated emissions measured in frequency above 1000MHz were made with an instrument using peak/average detector mode.
3. Average test would be performed if the peak result were greater than the average limit or as required by the applicant.
4. Data of measurement within this frequency range shown “ --- ” in the table above means the reading of emissions are attenuated more than 20dB below the permissible limits or the field strength is too small to be measured.
5. Measurements above show only up to 6 maximum emissions noted, or would be lesser, with “ N/A ” remark, if no specific emissions from the EUT are recorded (ie: margin > 20dB from the applicable limit) and considered that's already beyond the background noise floor.
6. Margin (dB) = Remark result (dBuV/m) – Average limit (dBuV/m).



**Operation Mode:** TX / IEEE 802.11g / CH Mid

**Test Date:** October 30, 2014

**Temperature:** 26°C

**Tested by:** Dennis Li

**Humidity:** 60% RH

**Polarity:** Ver. / Hor.

Frequency (MHz)	Reading (dBuV)	Correction Factor (dB/m)	Result (dBuV/m)	Limit (dBuV/m)	Margin (dB)	Remark	Ant. Pol. (H/V)
1622.000	51.25	-4.77	46.48	74.00	-27.52	peak	V
N/A							
1718.000	50.68	-4.18	46.50	74.00	-27.50	peak	H
N/A							

**Remark:**

1. Measuring frequencies from 1 GHz to the 10th harmonic of highest fundamental frequency.
2. Radiated emissions measured in frequency above 1000MHz were made with an instrument using peak/average detector mode.
3. Average test would be performed if the peak result were greater than the average limit or as required by the applicant.
4. Data of measurement within this frequency range shown “ --- ” in the table above means the reading of emissions are attenuated more than 20dB below the permissible limits or the field strength is too small to be measured.
5. Measurements above show only up to 6 maximum emissions noted, or would be lesser, with “ N/A ” remark, if no specific emissions from the EUT are recorded (ie: margin>20dB from the applicable limit) and considered that's already beyond the background noise floor.
6. Margin (dB) = Remark result (dBuV/m) – Average limit (dBuV/m).



**Operation Mode:** TX / IEEE 802.11g / CH High

**Test Date:** October 30, 2014

**Temperature:** 26°C

**Tested by:** Dennis Li

**Humidity:** 60% RH

**Polarity:** Ver. / Hor.

Frequency (MHz)	Reading (dBuV)	Correction Factor (dB/m)	Result (dBuV/m)	Limit (dBuV/m)	Margin (dB)	Remark	Ant. Pol. (H/V)
1460.000	50.86	-5.72	45.14	74.00	-28.86	peak	V
N/A							
1720.000	50.62	-4.17	46.45	74.00	-27.55	peak	H
N/A							

**Remark:**

1. Measuring frequencies from 1 GHz to the 10th harmonic of highest fundamental frequency.
2. Radiated emissions measured in frequency above 1000MHz were made with an instrument using peak/average detector mode.
3. Average test would be performed if the peak result were greater than the average limit or as required by the applicant.
4. Data of measurement within this frequency range shown “ --- ” in the table above means the reading of emissions are attenuated more than 20dB below the permissible limits or the field strength is too small to be measured.
5. Measurements above show only up to 6 maximum emissions noted, or would be lesser, with “ N/A ” remark, if no specific emissions from the EUT are recorded (ie: margin>20dB from the applicable limit) and considered that's already beyond the background noise floor.
6. Margin (dB) = Remark result (dBuV/m) – Average limit (dBuV/m).



**Operation Mode:** TX / IEEE 802.11n HT 20 MHz mode / CH Low    **Test Date:** October 30, 2014  
**Temperature:** 26°C    **Tested by:** Dennis Li  
**Humidity:** 60% RH    **Polarity:** Ver. / Hor.

Frequency (MHz)	Reading (dBuV)	Correction Factor (dB/m)	Result (dBuV/m)	Limit (dBuV/m)	Margin (dB)	Remark	Ant. Pol. (H/V)
1698.000	51.06	-4.31	46.75	74.00	-27.25	peak	V
N/A							
1818.000	50.14	-3.58	46.56	74.00	-27.44	peak	H
N/A							

**Remark:**

1. Measuring frequencies from 1 GHz to the 10th harmonic of highest fundamental frequency.
2. Radiated emissions measured in frequency above 1000MHz were made with an instrument using peak/average detector mode.
3. Average test would be performed if the peak result were greater than the average limit or as required by the applicant.
4. Data of measurement within this frequency range shown “ --- ” in the table above means the reading of emissions are attenuated more than 20dB below the permissible limits or the field strength is too small to be measured.
5. Measurements above show only up to 6 maximum emissions noted, or would be lesser, with “ N/A ” remark, if no specific emissions from the EUT are recorded (ie: margin>20dB from the applicable limit) and considered that's already beyond the background noise floor.
6. Margin (dB) = Remark result (dBuV/m) – Average limit (dBuV/m).



**Operation Mode:** TX / IEEE 802.11n HT 20 MHz mode / CH Mid    **Test Date:** October 30, 2014  
**Temperature:** 26°C    **Tested by:** Dennis Li  
**Humidity:** 60% RH    **Polarity:** Ver. / Hor.

Frequency (MHz)	Reading (dBuV)	Correction Factor (dB/m)	Result (dBuV/m)	Limit (dBuV/m)	Margin (dB)	Remark	Ant. Pol. (H/V)
1516.000	51.35	-5.41	45.94	74.00	-28.06	peak	V
N/A							
1742.000	50.59	-4.04	46.55	74.00	-27.45	peak	H
N/A							

**Remark:**

1. Measuring frequencies from 1 GHz to the 10th harmonic of highest fundamental frequency.
2. Radiated emissions measured in frequency above 1000MHz were made with an instrument using peak/average detector mode.
3. Average test would be performed if the peak result were greater than the average limit or as required by the applicant.
4. Data of measurement within this frequency range shown “ --- ” in the table above means the reading of emissions are attenuated more than 20dB below the permissible limits or the field strength is too small to be measured.
5. Measurements above show only up to 6 maximum emissions noted, or would be lesser, with “ N/A ” remark, if no specific emissions from the EUT are recorded (ie: margin > 20dB from the applicable limit) and considered that's already beyond the background noise floor.
6. Margin (dB) = Remark result (dBuV/m) – Average limit (dBuV/m).



**Operation Mode:** TX / IEEE 802.11n HT 20 MHz mode / CH High **Test Date:** October 30, 2014

**Temperature:** 26°C

**Tested by:** Dennis Li

**Humidity:** 60% RH

**Polarity:** Ver. / Hor.

Frequency (MHz)	Reading (dBuV)	Correction Factor (dB/m)	Result (dBuV/m)	Limit (dBuV/m)	Margin (dB)	Remark	Ant. Pol. (H/V)
1648.000	51.03	-4.61	46.42	74.00	-27.58	peak	V
N/A							
1628.000	50.36	-4.73	45.63	74.00	-28.37	peak	H
N/A							

**Remark:**

1. Measuring frequencies from 1 GHz to the 10th harmonic of highest fundamental frequency.
2. Radiated emissions measured in frequency above 1000MHz were made with an instrument using peak/average detector mode.
3. Average test would be performed if the peak result were greater than the average limit or as required by the applicant.
4. Data of measurement within this frequency range shown “ --- ” in the table above means the reading of emissions are attenuated more than 20dB below the permissible limits or the field strength is too small to be measured.
5. Measurements above show only up to 6 maximum emissions noted, or would be lesser, with “ N/A ” remark, if no specific emissions from the EUT are recorded (ie: margin>20dB from the applicable limit) and considered that's already beyond the background noise floor.
6. Margin (dB) = Remark result (dBuV/m) – Average limit (dBuV/m).





**Operation Mode:** TX / IEEE 802.11n HT 40 MHz mode  
/ CH Low  
**Temperature:** 26°C  
**Humidity:** 60% RH

**Test Date:** October 30, 2014  
**Tested by:** Dennis Li  
**Polarity:** Ver. / Hor.

Frequency (MHz)	Reading (dBuV)	Correction Factor (dB/m)	Result (dBuV/m)	Limit (dBuV/m)	Margin (dB)	Remark	Ant. Pol. (H/V)
1748.000	50.57	-4.00	46.57	74.00	-27.43	peak	V
N/A							
1852.000	50.90	-3.37	47.53	74.00	-26.47	peak	H
N/A							

**Remark:**

1. Measuring frequencies from 1 GHz to the 10th harmonic of highest fundamental frequency.
2. Radiated emissions measured in frequency above 1000MHz were made with an instrument using peak/average detector mode.
3. Average test would be performed if the peak result were greater than the average limit or as required by the applicant.
4. Data of measurement within this frequency range shown “ --- ” in the table above means the reading of emissions are attenuated more than 20dB below the permissible limits or the field strength is too small to be measured.
5. Measurements above show only up to 6 maximum emissions noted, or would be lesser, with “ N/A ” remark, if no specific emissions from the EUT are recorded (ie: margin>20dB from the applicable limit) and considered that's already beyond the background noise floor.
6. Margin (dB) = Remark result (dBuV/m) – Average limit (dBuV/m).



**Operation Mode:** TX / IEEE 802.11n HT 40 MHz mode  
/ CH Mid  
**Temperature:** 26°C  
**Humidity:** 60% RH

**Test Date:** October 30, 2014  
**Tested by:** Dennis Li  
**Polarity:** Ver. / Hor.

Frequency (MHz)	Reading (dBuV)	Correction Factor (dB/m)	Result (dBuV/m)	Limit (dBuV/m)	Margin (dB)	Remark	Ant. Pol. (H/V)
1864.000	50.29	-3.30	46.99	74.00	-27.01	peak	V
N/A							
1900.000	50.70	-3.08	47.62	74.00	-26.38	peak	H
N/A							

**Remark:**

1. Measuring frequencies from 1 GHz to the 10th harmonic of highest fundamental frequency.
2. Radiated emissions measured in frequency above 1000MHz were made with an instrument using peak/average detector mode.
3. Average test would be performed if the peak result were greater than the average limit or as required by the applicant.
4. Data of measurement within this frequency range shown “ --- ” in the table above means the reading of emissions are attenuated more than 20dB below the permissible limits or the field strength is too small to be measured.
5. Measurements above show only up to 6 maximum emissions noted, or would be lesser, with “ N/A ” remark, if no specific emissions from the EUT are recorded (ie: margin>20dB from the applicable limit) and considered that's already beyond the background noise floor.
6. Margin (dB) = Remark result (dBuV/m) – Average limit (dBuV/m).



**Operation Mode:** TX / IEEE 802.11n HT 40 MHz mode  
/ CH High  
**Temperature:** 26°C  
**Humidity:** 60% RH

**Test Date:** October 30, 2014  
**Tested by:** Dennis Li  
**Polarity:** Ver. / Hor.

Frequency (MHz)	Reading (dBuV)	Correction Factor (dB/m)	Result (dBuV/m)	Limit (dBuV/m)	Margin (dB)	Remark	Ant. Pol. (H/V)
1720.000	50.62	-4.17	46.45	74.00	-27.55	peak	V
N/A							
1606.000	51.54	-4.87	46.67	74.00	-27.33	peak	H
N/A							

**Remark:**

1. Measuring frequencies from 1 GHz to the 10th harmonic of highest fundamental frequency.
2. Radiated emissions measured in frequency above 1000MHz were made with an instrument using peak/average detector mode.
3. Average test would be performed if the peak result were greater than the average limit or as required by the applicant.
4. Data of measurement within this frequency range shown “ --- ” in the table above means the reading of emissions are attenuated more than 20dB below the permissible limits or the field strength is too small to be measured.
5. Measurements above show only up to 6 maximum emissions noted, or would be lesser, with “ N/A ” remark, if no specific emissions from the EUT are recorded (ie: margin>20dB from the applicable limit) and considered that's already beyond the background noise floor.
6. Margin (dB) = Remark result (dBuV/m) – Average limit (dBuV/m).



## 7.8 POWERLINE CONDUCTED EMISSIONS

### LIMIT

According to §15.207(a), except as shown in paragraphs (b) and (c) of this section, for an intentional radiator that is designed to be connected to the public utility (AC) power line, the radio frequency voltage that is conducted back onto the AC power line on any frequency or frequencies within the band 150 kHz to 30 MHz shall not exceed the limits in the following table, as measured using a 50  $\mu$ H/50 ohms line impedance stabilization network (LISN). Compliance with the provisions of this paragraph shall be based on the measurement of the radio frequency voltage between each power line and ground at the power terminal. The lower limit applies at the boundary between the frequency ranges.

Frequency Range (MHz)	Limits (dB $\mu$ V)	
	Quasi-peak	Average
0.15 to 0.50	66 to 56*	56 to 46*
0.50 to 5	56	46
5 to 30	60	50

\* Decreases with the logarithm of the frequency.

### Test Configuration

See test photographs attached in Appendix II for the actual connections between EUT and support equipment.

### TEST PROCEDURE

1. The EUT was placed on a table, which is 0.8m above ground plane.
2. Maximum procedure was performed on the six highest emissions to ensure EUT compliance.
3. Repeat above procedures until all frequency measured were complete.



## TEST RESULTS

The initial step in collecting conducted data is a spectrum analyzer peak scan of the measurement range. Significant peaks are then marked as shown on the following data page, and these signals are then quasi-peaked.

### Test Data

**Operation Mode:** Normal Link                      **Test Date:** October 31, 2014  
**Temperature:** 24°C                                      **Tested by:** Sehni Hu  
**Humidity:** 50% RH

Freq. (MHz)	QP Reading (dBuV)	AV Reading (dBuV)	Corr. factor (dB/m)	QP Result (dBuV/m)	AV Result (dBuV/m)	QP Limit (dBuV)	AV Limit (dBuV)	QP Margin (dB)	AV Margin (dB)	Note
0.1539	28.45	16.27	9.61	38.06	25.88	65.78	55.79	-27.72	-29.91	L1
0.2100	22.86	13.16	9.62	32.48	22.78	63.20	53.21	-30.72	-30.43	L1
0.5820	18.22	11.92	9.63	27.85	21.55	56.00	46.00	-28.15	-24.45	L1
0.7180	17.30	10.92	9.64	26.94	20.56	56.00	46.00	-29.06	-25.44	L1
1.0940	19.46	11.93	9.65	29.11	21.58	56.00	46.00	-26.89	-24.42	L1
25.3420	17.65	10.07	9.95	27.60	20.02	60.00	50.00	-32.40	-29.98	L1
0.1540	29.45	13.52	9.66	39.11	23.18	65.78	55.78	-26.67	-32.60	L2
0.1820	25.68	10.31	9.67	35.35	19.98	64.39	54.39	-29.04	-34.41	L2
0.4140	21.49	18.36	9.67	31.16	28.03	57.57	47.57	-26.41	-19.54	L2
0.5060	22.60	11.39	9.67	32.27	21.06	56.00	46.00	-23.73	-24.94	L2
0.6860	18.78	10.55	9.68	28.46	20.23	56.00	46.00	-27.54	-25.77	L2
21.8260	18.21	12.57	10.02	28.23	22.59	60.00	50.00	-31.77	-27.41	L2

### **Remark:**

1. Measuring frequencies from 0.15 MHz to 30MHz.
2. The emissions measured in frequency range from 0.15 MHz to 30MHz were made with an instrument using Quasi-peak detector and average detector.
3. The IF bandwidth of SPA between 0.15MHz and 30MHz was 10 kHz; the IF bandwidth of Test Receiver between 0.15MHz and 30MHz was 9 kHz;
4. L1 = Line One (Live Line) / L2 = Line Two (Neutral Line)



### Test Plots

#### Conducted emissions (Line 1)

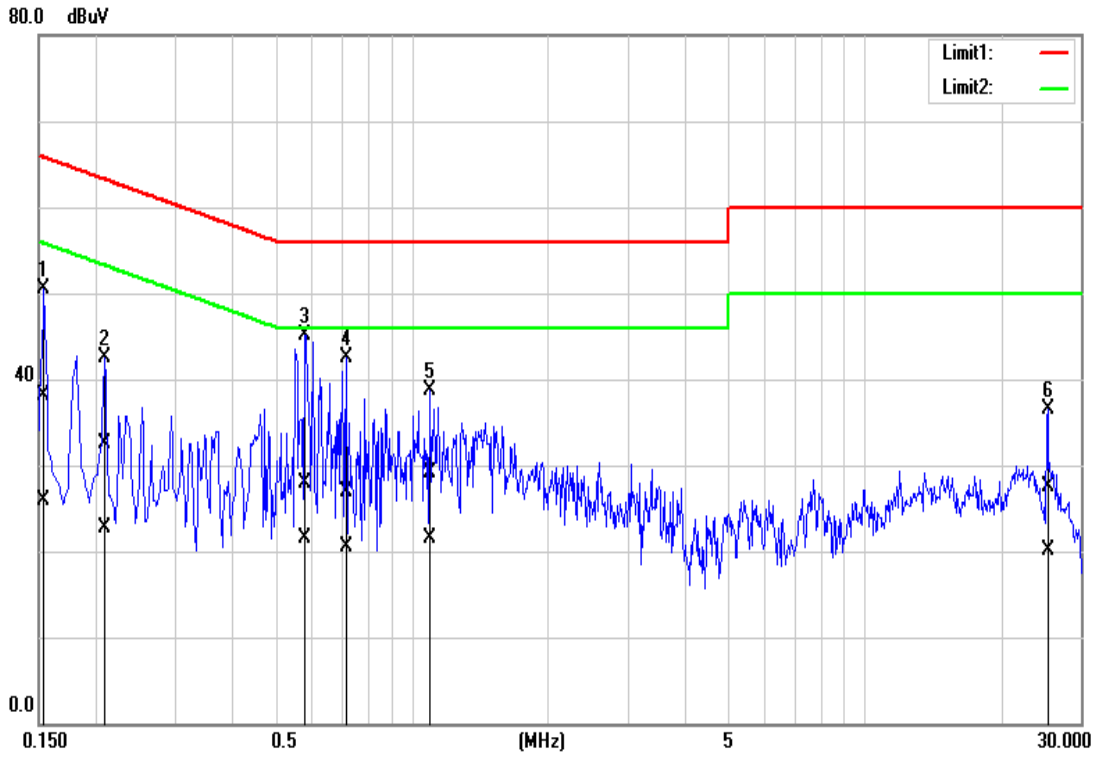

#### Conducted emissions (Line 2)

