



FCC TEST REPORT

According to

FCC Rules and Regulations Part 15 Subpart E

Applicant : Amped Wireless
Address : 13089 Peyton Dr. #C307, Chino Hills CA 91709
Equipment : High Power Wireless-N 600mW Gigabit Dual Band Router
Model No. : R20000G
FCC ID : ZTT-R20000G-2
Trade Name : Amped Wireless

- The test result refers exclusively to the test presented test model / sample.,
- The test result does not include DFS test for 5250 ~ 5350 MHz.
- Without written approval of **CerpPASS Technology Corp.**, the test report shall not be reproduced except in full.
- The EUT is also considered as a kind of computer peripheral, because the connection to computer is necessary for typical use. It has been verified to comply with the requirements of FCC Part 15, Subpart B, Class B (DoC). The test report has been issued separately.



CONTENTS

- 1. Report of Measurements and Examinations.....6
 - 1.1. List of Measurements and Examinations6
- 2. Test Configuration of Equipment under Test.....7
 - 2.1. Feature of Equipment under Test.....7
 - 2.2. Carrier Frequency of Channels7
 - 2.3. Test Mode and Test Software8
 - 2.4. Description of Test System.....8
 - 2.5. General Information of Test.....9
 - 2.6. Measurement Uncertainty9
- 3. Antenna Requirements10
 - 3.1. Standard Applicable10
 - 3.2. Antenna Construction and Directional Gain.....10
- 4. Test of Conducted Emission11
 - 4.1. Test Limit11
 - 4.2. Test Procedures11
 - 4.3. Typical Test Setup12
 - 4.4. Measurement Equipment.....12
 - 4.5. Test Result and Data13
 - 4.6. Test Photographs19
- 5. Test of Radiated Emission20
 - 5.1. Test Limit20
 - 5.2. Test Procedures20
 - 5.3. Typical Test Setup21
 - 5.4. Measurement Equipment.....21
 - 5.5. Test Result and Data (9kHz ~ 30MHz).....22
 - 5.6. Test Result and Data (30MHz ~ 1GHz).....22
 - 5.7. Test Result and Data (1GHz ~ 40GHz).....34
 - 5.8. Test Photographs (30MHz~1GHz)52
 - 5.9. Test Photographs (Above 1GHz)53
- 6. Peak Transmit Power54
 - 6.1. Test Procedure54
 - 6.2. Test Setup Layout54
 - 6.3. Measurement Equipment.....54
 - 6.4. Test Result and Data55
- 7. Peak Power Excursion.....65
 - 7.1. Test Procedure65
 - 7.2. Test Setup Layout65
 - 7.3. Measurement Equipment.....65
 - 7.4. Test Result and Data65
- 8. Peak Power Spectral Density.....75
 - 8.1. Test Procedure75
 - 8.2. Test Setup Layout75
 - 8.3. Measurement Equipment.....75
 - 8.4. Test Result and Data76



9. Frequency Stability.....86

9.1. Test Procedure86

9.2. Test Setup Layout86

9.3. Measurement Equipment.....86

9.4. Test Result and Data87

10. Band Edges Measurement88

10.1. Test Procedure88

10.2. Measurement Equipment.....88

10.3. Test Result and Data88

10.4. Restrict Band Emission Measurement Data92

11. Restricted Bands of Operation.....93

11.1. Labeling Requirement93

Appendix A. Photographs of EUT.....A1 ~ A11



History of this test report

ORIGINAL.

Additional attachment as following record:

Attachment No.	Issue Date	Description



CERTIFICATE OF COMPLIANCE

According to

FCC Rules and Regulations Part 15 Subpart E

Applicant : Amped Wireless
Address : 13089 Peyton Dr. #C307, Chino Hills CA 91709
Equipment : High Power Wireless-N 600mW Gigabit Dual Band Router
Model No. : R20000G
FCC ID : ZTT-R20000G-2
Trade Name : Amped Wireless

I **HEREBY** CERTIFY THAT :

The measurements shown in this test report were made in accordance with the procedures given in **ANSI C63.4** The equipment was **passed** the test performed according to **FCC Rules and Regulations Part 15 Subpart E (2011), and KDB789033.**

The test was carried out on Sep. 04, 2013 at CerpPASS Technology Corp.

Approved by:

Tested by:

Hill Chen
EMC/RF B.U. Assistant Manager

Tom Tai
Engineer



1. Report of Measurements and Examinations

1.1. List of Measurements and Examinations

For Frequency 5.15GHz ~ 5.25GHZ

Applied Standard : FCC Part 15, Subpart E (Section 15.407)		
FCC Rule	Description of Test	Result
15.407(b)(5)	. Conducted Emission	Pass
15.407(b/1/2/3)(b)(5)	. Radiated Emission	Pass
15.407(a/1/2/3)	. Peak Transmit Power	Pass
15.407(a)(6)	. Peak Power Excursion	Pass
15.407(a/1/2/3)	. Peak Power Spectral Density	Pass
15.407(g)	. Frequency Stability	Pass



2. Test Configuration of Equipment under Test

2.1. Feature of Equipment under Test

- Wireless Standard: 802.11a/b/g/n
- Frequency Band: 2.4GHz, 5.0GHz
- Wireless Speed: 2.4GHz: 300Mbps (Tx/Rx)
5.0GHz: 300Mbps (Tx/Rx)
- Amplifier: Dual 2.4GHz 600mW Amplifiers
Dual 5.0GHz Amplifiers
Dual Low Noise Amplifier
- Wireless Sensitivity: -94dBm
- Wireless Output Power: Up to 29dBm
- Wireless Security: WEP, WPA, WPA2, WPA Mixed, WPS
- Processor Clock Speed: 620MHz
- Wireless Coverage Control: 15% - 100% Output Power
- Data Rate:
2.4GHz: 802.11b: 11Mbps, 802.11g: 54Mbps, 802.11n HT20: 130Mbps, 802.11n HT40: 270Mbps
5.0GHz: 802.11a: 54Mbps, 802.11an HT20: 130Mbps, 802.11an HT40: 270Mbps
- Antenna:
-2 x Detachable High Gain
Dual Band 2dBi (for 2.4GHz), 4dBi (for 5GHz) Antennas
-2 x Reverse SMA Connector
- Ports:
-4 x RJ45 10/100/1000 LAN ports
-1 x RJ45 10/100/1000 WAN ports
-USB 2.0 Port for Storage Devices
- Mounting: Wall, Stand or Desktop
- Warranty: 1 Year

2.2. Carrier Frequency of Channels

802.11a, 802.11an HT20 (5150 ~ 5250MHz)

Channel	Frequency(MHz)	Channel	Frequency(MHz)
36	5180	48	5240
40	5200	---	---
44	5220	---	---

802.11 an HT40 (5190 ~ 5230MHz)

Channel	Frequency(MHz)	Channel	Frequency(MHz)
38	5190	46	5230
42	5210	---	---



2.3. Test Mode and Test Software

- a. During testing, the interface cables and equipment positions were varied according to ANSI C63.4.
- b. The complete test system included Notebook and EUT for RF test.
- c. An executive “MD TOOL” under XP was executed to keep transmitting and receiving data via Wireless.
- d. The following test modes were performed for test:
 - 802.11a/an, HT20: CH 36: 5180MHz, CH 44: 5220MHz, CH 48: 5240MHz
 - 802.11an, HT40: CH 38: 5190MHz, CH42: 5120MHz, CH 46: 5230MHz

* Power output of data rate:

802.11a		802.11an HT20		802.11an HT40	
Data Rate (Mbps)	Power output (dBm)	Data Rate (Mbps)	Power output (dBm)	Data Rate (Mbps)	Power output (dBm)
54	8.06	130/15	10.52	270/15	11.66
48	7.97	117/14	10.51	243/14	11.59
36	8.03	104/13	10.45	216/13	11.53
24	8.00	78/12	10.49	162/12	11.54
18	8.00	52/11	10.43	108/11	11.52
12	8.01	39/10	10.43	81/10	11.55
9	8.04	26/9	10.41	54/9	11.58
6	7.97	13/8	10.42	27/8	11.61
---	---	65/7	10.48	135/7	11.56
---	---	58.5/6	10.47	121.5/6	11.59
---	---	52/5	10.41	108/5	11.53
---	---	39/4	10.45	81/4	11.54
---	---	26/3	10.49	54/3	11.52
---	---	19.5/2	10.49	40.5/2	11.55
---	---	13/1	10.41	27/1	11.58
---	---	6.5/0	10.42	13.5/0	11.51

2.4. Description of Test System

Device	Manufacturer	Model No.	Description
Notebook	ASUS	A8J	Power Cable, Unshielding 1.8m

**2.5. General Information of Test**

Test Site :	CerpPASS Technology Corp. 2F-11, No. 3, Yuan Qu St., (Nankang Software Park), Taipei, Taiwan 115, R.O.C.
Test Site Location (OATS2-SD) :	No.68-1, Shihbachongsi, Shihding Township, Taipei City 223, Taiwan, R.O.C.
FCC Registration Number :	TW1049, TW1061, 488071, 390316
IC Registration Number :	4934B-1, 4934D-1
VCCI Registration Number :	T-1173 for Telecommunication Test C-4139 for Conducted emission test R-3428 for Radiated emission test G-97 for radiated disturbance above 1GHz
Frequency Range Investigated:	AC Power Conducted Emission : from 150kHz to 30 MHz Radiated and conducted Emission: from 30 MHz to 40 GHz
Test Distance:	The test distance of radiated emission from antenna to EUT is 3 M.
Laboratory Accreditation	

2.6. Measurement Uncertainty

Measurement Item	Uncertainty
Radiated emission	±4.11dB
Peak Output Power(conducted)	±1.38dB
Peak Output Power(Radiated)	±1.70dB
Power Spectral Density	±1.39dB
Radiated emission(3m)	±4.11dB
Radiated emission(10m)	±3.89dB



3. Antenna Requirements

3.1. Standard Applicable

For intentional device, according to FCC 47 CFR Section 15.203, an intentional radiator shall be designed to ensure that no antenna other than that furnished by the responsible party shall be used with the device.

And according to FCC 47 CFR Section 15.407 (a), if transmitting antennas of directional gain greater than 6dBi are used, the power shall be reduced by the amount in dB that the directional gain of the antenna exceeds 6dBi.

3.2. Antenna Construction and Directional Gain

802.11a, an:

ANT R, ANT L

Antenna Type: Dipole Antenna

Antenna Gain: 4 dBi

Note: Directional gain = $G_{ANT} + 10 \log(N)$ dBi = $4 + 10 \log(2) = 7.01$ (dBi)



4. Test of Conducted Emission

4.1. Test Limit

Conducted Emissions were measured from 150 kHz to 30 MHz with a bandwidth of 9 KHz on the 120 VAC power and return leads of the EUT according to the methods defined in ANSI C63.4-2009 Section 3.1. The EUT was placed on a nonmetallic stand in a shielded room 0.8 meters above the ground plane as shown in section 2.2. The interface cables and equipment positioning were varied within limits of reasonable applications to determine the position produced maximum conducted emissions.

Frequency (MHz)	Quasi Peak (dB μ V)	Average (dB μ V)
0.15 – 0.5	66-56*	56-46*
0.5 – 5.0	56	46
5.0 – 30.0	60	50

*Decreases with the logarithm of the frequency.

4.2. Test Procedures

- a. The EUT was placed 0.4 meter from the conducting wall of the shielding room was kept at least 80 centimeters from any other grounded conducting surface.
- b. Connect EUT to the power mains through a line impedance stabilization network (LISN).
- c. All the support units are connecting to the other LISN.
- d. The LISN provides 50 ohm coupling impedance for the measuring instrument.
- e. The FCC states that a 50 ohm, 50 micro-Henry LISN should be used.
- f. Both sides of AC line were checked for maximum conducted interference.
- g. The frequency range from 150 kHz to 30 MHz was searched.
- h. Set the test-receiver system to Peak Detect Function and Specified Bandwidth with Maximum Hold Mode.



4.3. Typical Test Setup

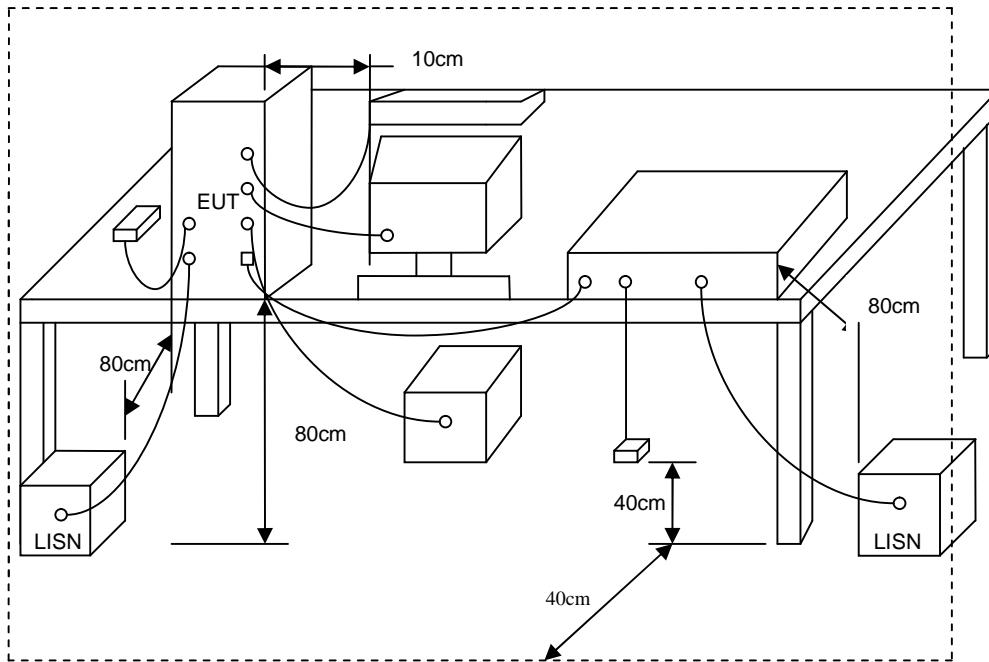

4.4. Measurement Equipment

Instrument/Ancillary	Model No.	Manufacturer	Serial No.	Calibration Date	Valid Date.
EMI Receiver	R&S	ESCI	100821	2012/12/24	2013/12/23
LISN	Schwarzbeck	NSLK 8127	8127-516	2013/03/08	2014/03/07
LISN	Schwarzbeck	NSLK 8127	8127-568	2013/08/26	2014/08/25
Attenuator	HAMEG	HZ560	-----	2013/03/07	2014/03/06



4.5. Test Result and Data

Power	: AC 120V	Pol/Phase	: LINE
Test Mode 1	: 802.11a, CH36	Temperature	: 26 °C
Test Date	: Sep. 04, 2013	Humidity	: 48 %

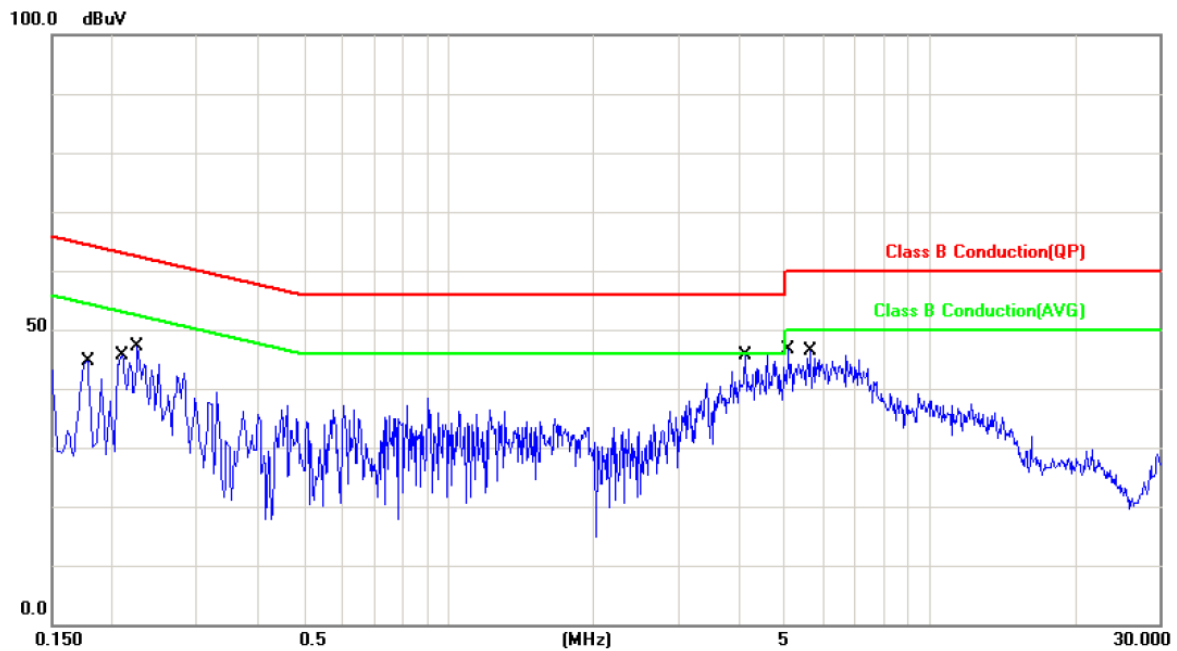

No.	Frequency (MHz)	Factor (dBuV)	Reading (dBuV)	Level (dBuV)	Limit (dBuV)	Margin (dB)	Detector	P/F
1	0.1780	10.45	31.15	41.60	64.57	-22.97	QP	P
2	0.1780	10.45	22.21	32.66	54.57	-21.91	AVG	P
3	0.2100	10.42	33.20	43.62	63.20	-19.58	QP	P
4	0.2100	10.42	25.22	35.64	53.20	-17.56	AVG	P
5	0.2260	10.41	34.64	45.05	62.59	-17.54	QP	P
6	0.2260	10.41	22.59	33.00	52.59	-19.59	AVG	P
7	4.1459	10.51	27.76	38.27	56.00	-17.73	QP	P
8	4.1459	10.51	18.55	29.06	46.00	-16.94	AVG	P
9	5.0858	10.57	29.46	40.03	60.00	-19.97	QP	P
10	5.0858	10.57	20.28	30.85	50.00	-19.15	AVG	P
11	5.6419	10.60	30.36	40.96	60.00	-19.04	QP	P
12	5.6419	10.60	20.25	30.85	50.00	-19.15	AVG	P

Note: Level = Reading + Factor
Margin = Level – Limit



Power	: AC 120V	Pol/Phase	: NEUTRAL
Test Mode 1	: 802.11a, CH36	Temperature	: 26 °C
Test Date	: Sep. 04, 2013	Humidity	: 48 %

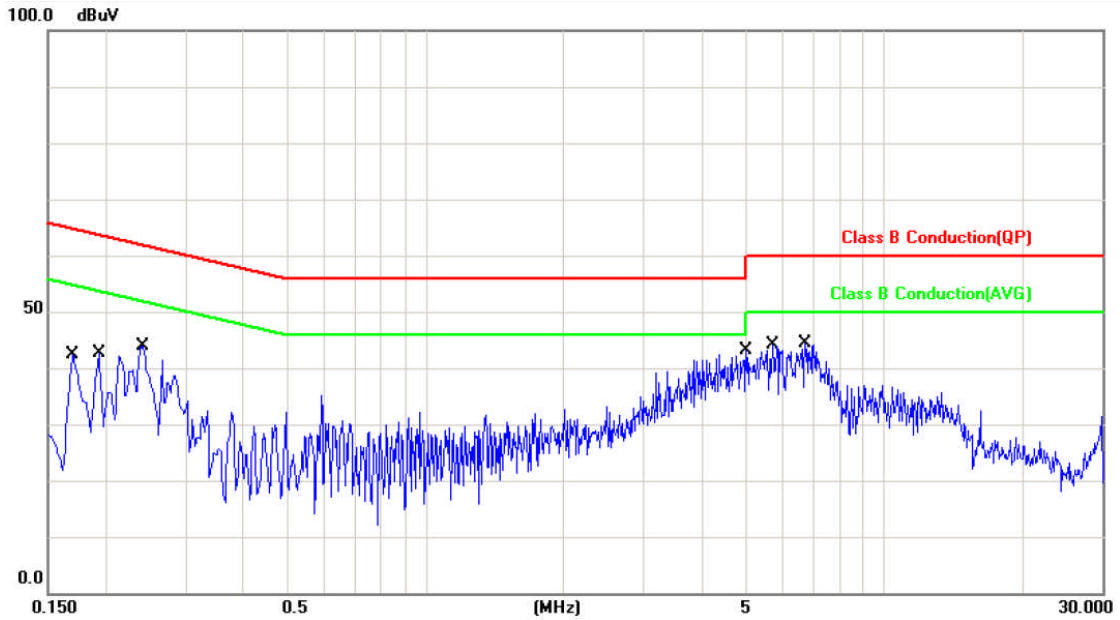

No.	Frequency (MHz)	Factor (dBuV)	Reading (dBuV)	Level (dBuV)	Limit (dBuV)	Margin (dB)	Detector	P/F
1	0.1700	10.44	30.16	40.60	64.96	-24.36	QP	P
2	0.1700	10.44	17.67	28.11	54.96	-26.85	AVG	P
3	0.1940	10.41	24.35	34.76	63.86	-29.10	QP	P
4	0.1940	10.41	12.62	23.03	53.86	-30.83	AVG	P
5	0.2420	10.38	32.56	42.94	62.02	-19.08	QP	P
6	0.2420	10.38	24.23	34.61	52.02	-17.41	AVG	P
7	5.0139	10.52	26.42	36.94	60.00	-23.06	QP	P
8	5.0139	10.52	17.55	28.07	50.00	-21.93	AVG	P
9	5.7419	10.55	26.36	36.91	60.00	-23.09	QP	P
10	5.7419	10.55	17.51	28.06	50.00	-21.94	AVG	P
11	6.7379	10.60	26.30	36.90	60.00	-23.10	QP	P
12	6.7379	10.60	17.27	27.87	50.00	-22.13	AVG	P

Note: Level = Reading + Factor
Margin = Level – Limit



Power	: AC 120V	Pol/Phase	: LINE
Test Mode 2	: 802.11an HT20, CH36	Temperature	: 26 °C
Test Date	: Sep. 04, 2013	Humidity	: 48 %

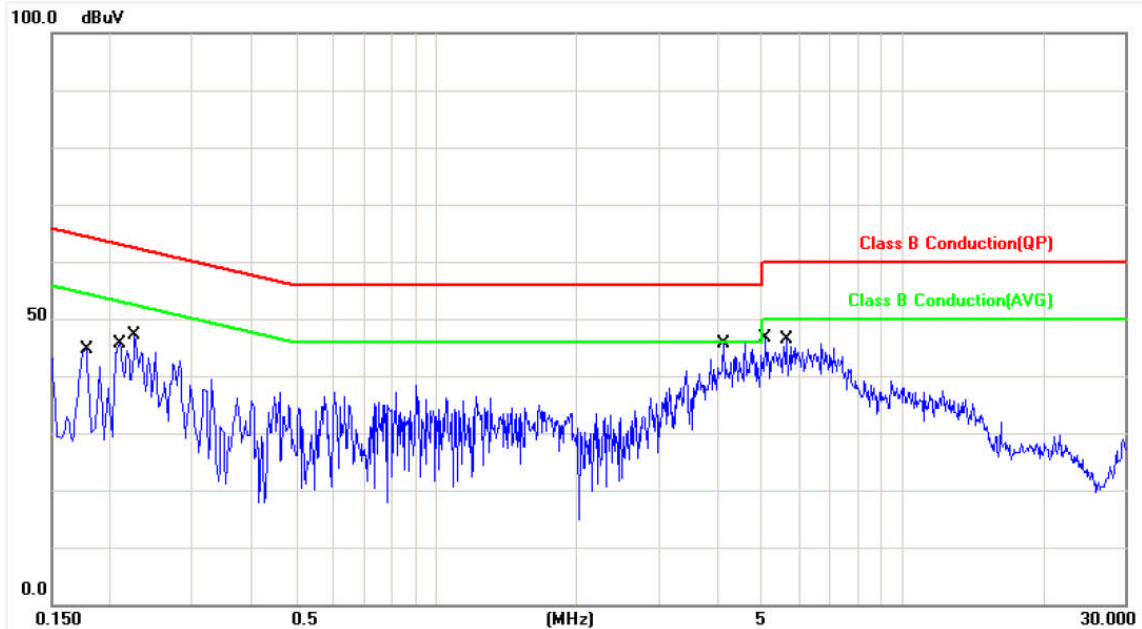

No.	Frequency (MHz)	Factor (dBuV)	Reading (dBuV)	Level (dBuV)	Limit (dBuV)	Margin (dB)	Detector	P/F
1	0.1780	10.45	31.22	41.67	64.57	-22.90	QP	P
2	0.1780	10.45	22.31	32.76	54.57	-21.81	AVG	P
3	0.2100	10.42	33.40	43.82	63.20	-19.38	QP	P
4	0.2100	10.42	25.61	36.03	53.20	-17.17	AVG	P
5	0.2260	10.41	34.55	44.96	62.59	-17.63	QP	P
6	0.2260	10.41	22.67	33.08	52.59	-19.51	AVG	P
7	4.1459	10.51	27.48	37.99	56.00	-18.01	QP	P
8	4.1459	10.51	18.59	29.10	46.00	-16.90	AVG	P
9	5.0858	10.57	29.61	40.18	60.00	-19.82	QP	P
10	5.0858	10.57	20.42	30.99	50.00	-19.01	AVG	P
11	5.6419	10.60	30.29	40.89	60.00	-19.11	QP	P
12	5.6419	10.60	20.34	30.94	50.00	-19.06	AVG	P

Note: Level = Reading + Factor

Margin = Level – Limit



Power	: AC 120V	Pol/Phase	: NEUTRAL
Test Mode 2	: 802.11an HT20, CH36	Temperature	: 26 °C
Test Date	: Sep. 04, 2013	Humidity	: 48 %

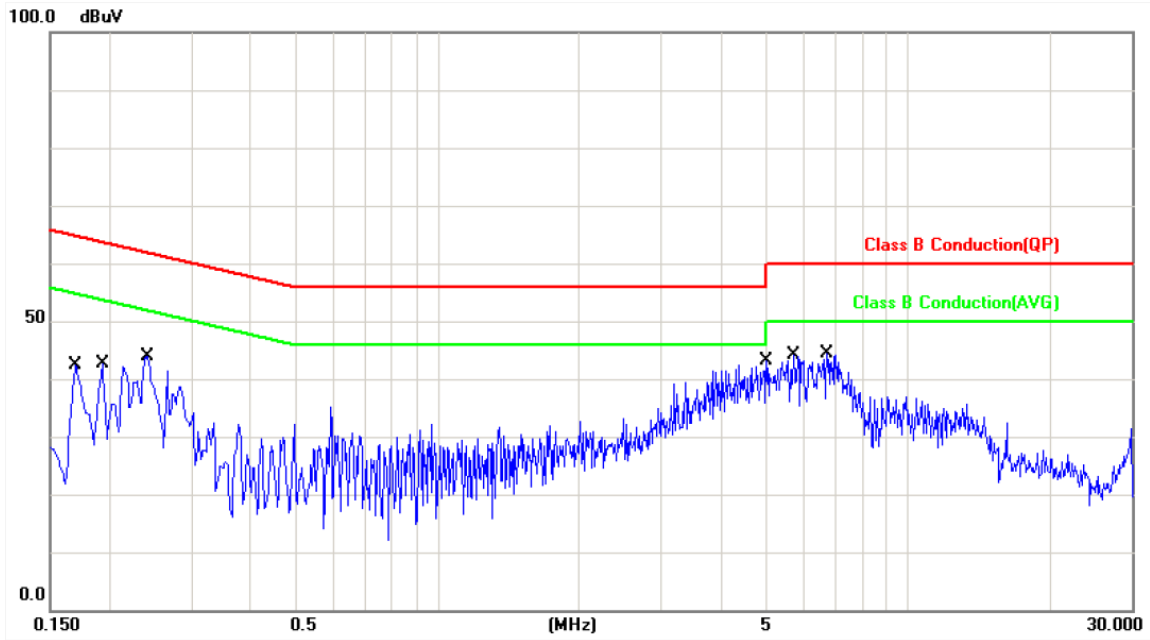

No.	Frequency (MHz)	Factor (dBuV)	Reading (dBuV)	Level (dBuV)	Limit (dBuV)	Margin (dB)	Detector	P/F
1	0.1700	10.44	30.12	40.56	64.96	-24.40	QP	P
2	0.1700	10.44	17.74	28.18	54.96	-26.78	AVG	P
3	0.1940	10.41	24.36	34.77	63.86	-29.09	QP	P
4	0.1940	10.41	12.58	22.99	53.86	-30.87	AVG	P
5	0.2420	10.38	32.61	42.99	62.02	-19.03	QP	P
6	0.2420	10.38	24.24	34.62	52.02	-17.40	AVG	P
7	5.0139	10.52	26.49	37.01	60.00	-22.99	QP	P
8	5.0139	10.52	17.75	28.27	50.00	-21.73	AVG	P
9	5.7419	10.55	26.32	36.87	60.00	-23.13	QP	P
10	5.7419	10.55	17.58	28.13	50.00	-21.87	AVG	P
11	6.7379	10.60	26.27	36.87	60.00	-23.13	QP	P
12	6.7379	10.60	17.18	27.78	50.00	-22.22	AVG	P

Note: Level = Reading + Factor
 Margin = Level – Limit



Power	: AC 120V	Pol/Phase	: LINE
Test Mode 3	: 802.11an HT40, CH38	Temperature	: 26 °C
Test Date	: Sep. 04, 2013	Humidity	: 48 %

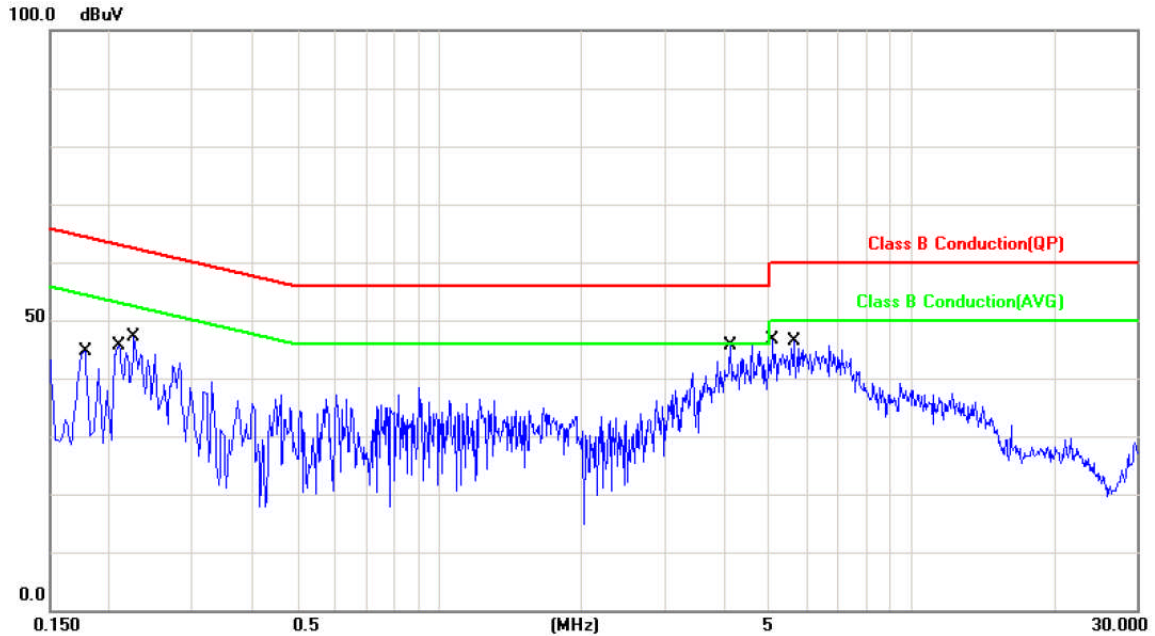

No.	Frequency (MHz)	Factor (dBuV)	Reading (dBuV)	Level (dBuV)	Limit (dBuV)	Margin (dB)	Detector	P/F
1	0.1780	10.45	31.23	41.68	64.57	-22.89	QP	P
2	0.1780	10.45	22.25	32.70	54.57	-21.87	AVG	P
3	0.2100	10.42	33.24	43.66	63.20	-19.54	QP	P
4	0.2100	10.42	25.52	35.94	53.20	-17.26	AVG	P
5	0.2260	10.41	34.46	44.87	62.59	-17.72	QP	P
6	0.2260	10.41	22.59	33.00	52.59	-19.59	AVG	P
7	4.1459	10.51	27.74	38.25	56.00	-17.75	QP	P
8	4.1459	10.51	18.54	29.05	46.00	-16.95	AVG	P
9	5.0858	10.57	29.27	39.84	60.00	-20.16	QP	P
10	5.0858	10.57	20.49	31.06	50.00	-18.94	AVG	P
11	5.6419	10.60	30.12	40.72	60.00	-19.28	QP	P
12	5.6419	10.60	20.36	30.96	50.00	-19.04	AVG	P

Note: Level = Reading + Factor

Margin = Level – Limit



Power	: AC 120V	Pol/Phase	: NEUTRAL
Test Mode 3	: 802.11an HT40, CH38	Temperature	: 26 °C
Test Date	: Sep. 04, 2013	Humidity	: 48 %

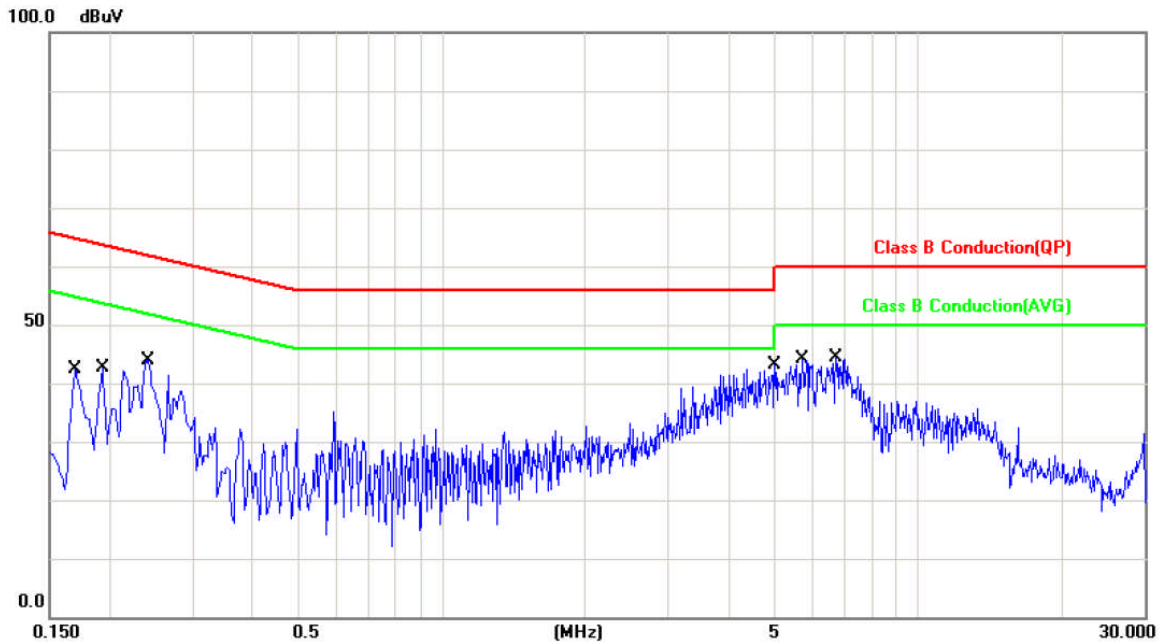

No.	Frequency (MHz)	Factor (dBuV)	Reading (dBuV)	Level (dBuV)	Limit (dBuV)	Margin (dB)	Detector	P/F
1	0.1700	10.44	30.15	40.59	64.96	-24.37	QP	P
2	0.1700	10.44	17.65	28.09	54.96	-26.87	AVG	P
3	0.1940	10.41	24.33	34.74	63.86	-29.12	QP	P
4	0.1940	10.41	12.85	23.26	53.86	-30.60	AVG	P
5	0.2420	10.38	32.59	42.97	62.02	-19.05	QP	P
6	0.2420	10.38	24.41	34.79	52.02	-17.23	AVG	P
7	5.0139	10.52	26.26	36.78	60.00	-23.22	QP	P
8	5.0139	10.52	17.77	28.29	50.00	-21.71	AVG	P
9	5.7419	10.55	26.36	36.91	60.00	-23.09	QP	P
10	5.7419	10.55	17.58	28.13	50.00	-21.87	AVG	P
11	6.7379	10.60	26.28	36.88	60.00	-23.12	QP	P
12	6.7379	10.60	17.47	28.07	50.00	-21.93	AVG	P

Note: Level = Reading + Factor
Margin = Level – Limit



5. Test of Radiated Emission

5.1. Test Limit

For transmitters operating in the 5.15-5.35 GHz band: all emissions outside of the 5.15-5.35 GHz band shall not exceed an EIRP of -27 dBm/MHz (68.3dBuV/m at 3m). For transmitters operating in the 5.47-5.725 GHz band: all emissions outside of the 5.47-5.725 GHz band shall not exceed an EIRP of -27 dBm/MHz (68.3dBuV/m at 3m). In addition, In case the emission fall within the restricted band specified on 15.205(a), then the 15.209(a) limit in the table below has to be followed.

Frequencies (MHz)	Field Strength (micorvolts/meter)	Measurement Distance (meters)
0.009-0.490	2400/F(KHz)	300
0.490~1.705	24000/F(KHz)	30
1.705~30.0	30	30
30~88	100	3
88~216	150	3
216~960	200	3
Above 960	500	3

5.2. Test Procedures

- The EUT was placed on a rotatable table top 0.8 meter above ground.
- The EUT was set 3 meters from the interference receiving antenna which was mounted on the top of a variable height antenna tower.
- The table was rotated 360 degrees to determine the position of the highest radiation.
- The antenna is a broadband antenna and its height is varied between one meter and four meters above ground to find the maximum value of the field strength both horizontal polarization and vertical polarization of the antenna are set to make the measurement.
- For each suspected emission the EUT was arranged to its worst case and then tune the antenna tower (from 1 M to 4 M) and turn table (from 0 degree to 360 degrees) to find the maximum reading.
- Set the test-receiver system to Peak or CISPR quasi-peak Detect Function and specified bandwidth with Maximum Hold Mode.
- If the emission level of the EUT in peak mode was 3 dB lower than the limit specified, then testing will be stopped and peak values of EUT will be reported, otherwise, the emissions which do not have 3 dB margin will be repeated one by one using the quasi-peak method and reported.
- For testing above 1GHz, the emission level of the EUT in peak mode was 20dB lower than average limit (that means the emission level in peak mode also complies with the limit in average mode), then testing will be stopped and peak values of EUT will be reported, otherwise, the emissions will be measured in average mode again and reported.



5.3. Typical Test Setup

For radiated emissions below 30MHz

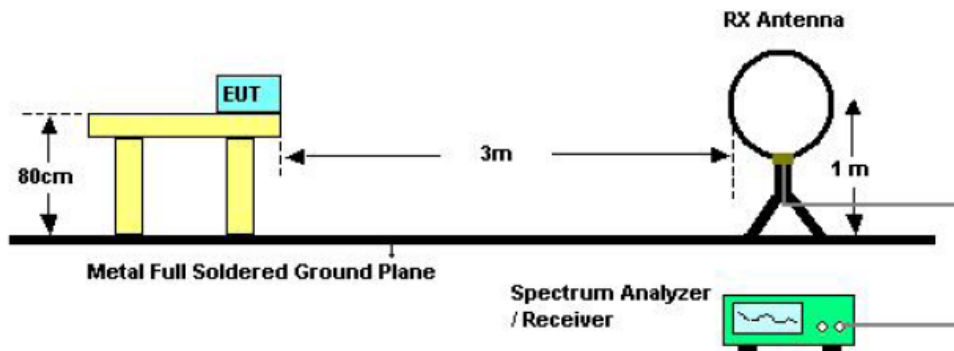

For radiated emissions above 30MHz

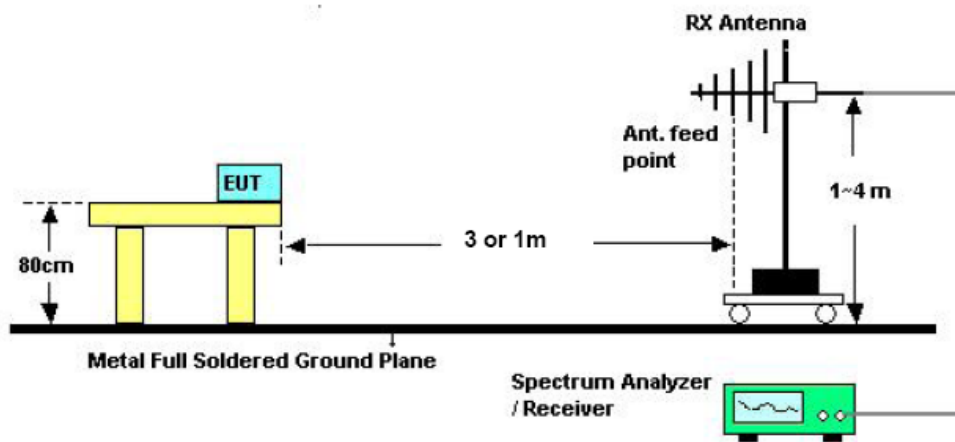

Above 10 GHz shall be extrapolated to the specified distance using an extrapolation factor of 20 dB/decade from 3m to 1m.

Distance extrapolation factor = $20 \log(\text{specific distance [3m]} / \text{test distance [1m]})$ (dB);

Limit line = specific limits (dBUV) + distance extrapolation factor [9.54 dB].

5.4. Measurement Equipment

Instrument/Ancillary	Manufacturer	Model No.	Serial No.	Calibration Date	Valid Date
EMI Receiver	R&S	ESCI	100443	2013/01/15	2014/01/14
Bilog Antenna	Schwarzbeck	VULB 9168	369	2013/03/06	2014/03/05
Amplifier	QuieTek	AP/0100A	CHM0906075	2013/01/15	2014/01/14
SPECTRUM ANALYZER	R&S	FSP40	100219	2012/09/13	2013/09/12
HORN ANTENNA	EMCO	3115	31601	2012/09/13	2013/09/12
PREAMPLIFIER	EMC	EMC012635	980029	2012/09/12	2013/09/11



5.5. Test Result and Data (9kHz ~ 30MHz)

The 9kHz - 30MHz spurious emission is under limit 20dB more.

5.6. Test Result and Data (30MHz ~ 1GHz)

Power	: AC 120V	Pol/Phase	: VERTICAL
Test Mode 1	: 802.11a, CH36	Temperature	: 25 °C
Memo	:	Humidity	: 47 %

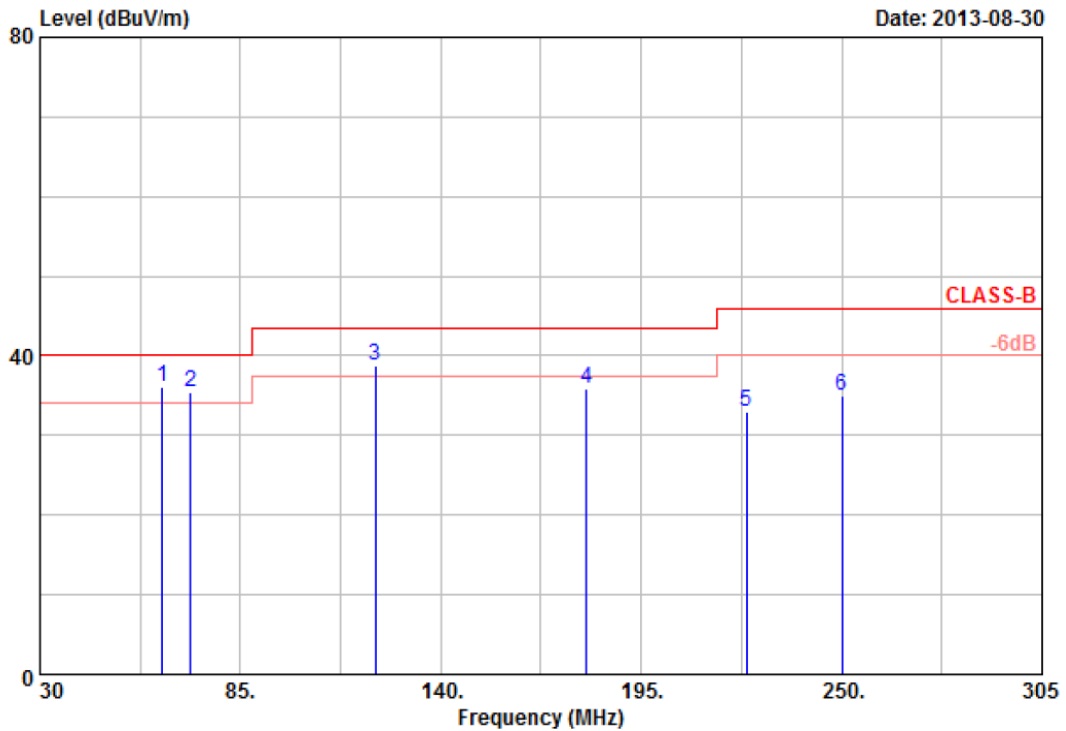

Item	Freq	Read Value	Factor	Result	Limit	Margin	Remark	Ant Pos	Tab Pos
	MHz	dBuV	dB/m	dBuV/m	dBuV/m	dB		cm	Deg
1	63.55	47.73	-11.57	36.16	40.00	-3.84	QP	101	0
2	71.25	46.17	-10.63	35.54	40.00	-4.46	QP	101	0
3	122.13	43.47	-4.76	38.71	43.50	-4.79	QP	101	0
4	179.88	40.98	-5.06	35.92	43.50	-7.58	Peak	101	0
5	223.88	39.69	-6.63	33.06	46.00	-12.94	Peak	101	0
6	250.00	46.48	-11.52	34.96	46.00	-11.04	Peak	101	0

Notes:

1. Result = Read Value + Factor
2. Factor = Antenna Factor + Cable Loss - Amplifier
3. The resolution bandwidth of test receiver/spectrum analyzer is 120KHz and video bandwidth is 300kHz for Peak detection and Quasi-peak detection at frequency below 1GHz.
4. According to technical experiences, all spurious emission of 802.11a/an mode at Band1~4 channel are almost the same below 1GHz, so that the channel 36 or 38(for HT40), channel 149 or 151(for HT40) was chosen as representative in final test.
5. The data is worse case.



Power	: AC 120V	Pol/Phase	: VERTICAL
Test Mode 1	: 802.11a, CH36	Temperature	: 25 °C
Memo	:	Humidity	: 47 %

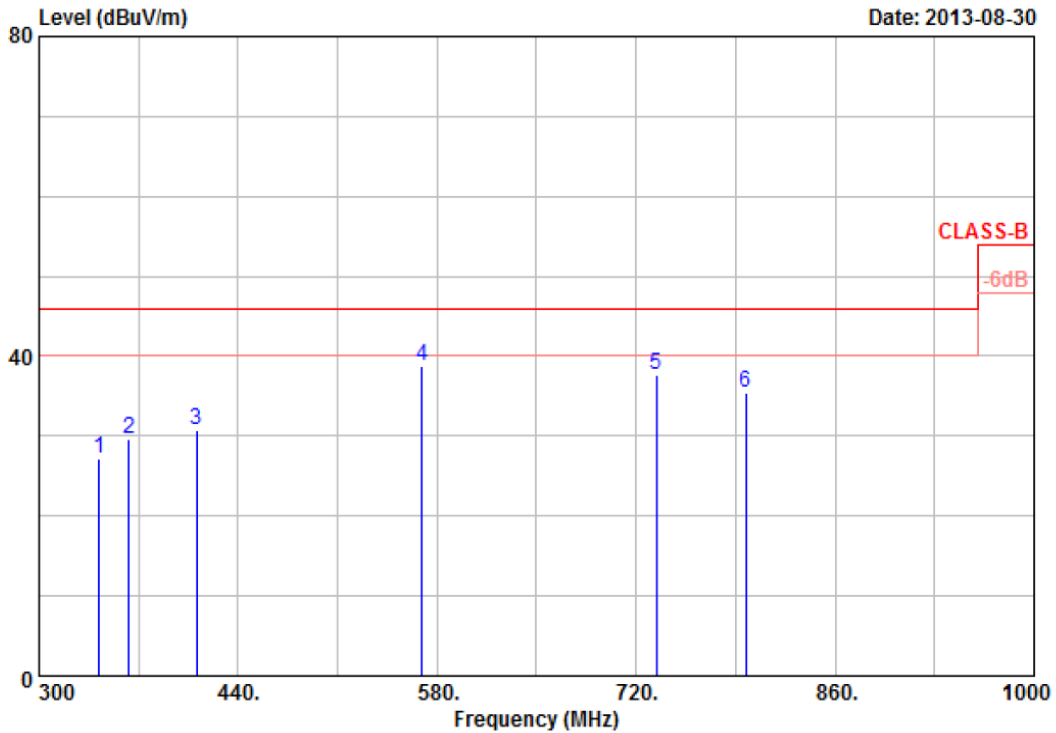

Item	Freq MHz	Read Value dBuV	Factor dB/m	Result dBuV/m	Limit dBuV/m	Margin dB	Remark	Ant Pos cm	Tab Pos Deg
1	342.00	34.46	-7.36	27.10	46.00	-18.90	Peak	101	0
2	363.00	38.25	-8.72	29.53	46.00	-16.47	Peak	101	0
3	410.60	36.63	-5.83	30.80	46.00	-15.20	Peak	101	0
4	569.50	31.11	7.60	38.71	46.00	-7.29	Peak	101	0
5	734.00	30.84	6.92	37.76	46.00	-8.24	Peak	101	0
6	797.00	29.44	5.94	35.38	46.00	-10.62	Peak	101	0

Notes:

1. Result = Read Value + Factor
2. Factor = Antenna Factor + Cable Loss - Amplifier
3. The resolution bandwidth of test receiver/spectrum analyzer is 120KHz and video bandwidth is 300kHz for Peak detection and Quasi-peak detection at frequency below 1GHz.
4. According to technical experiences, all spurious emission of 802.11a/an mode at Band1~4 channel are almost the same below 1GHz, so that the channel 36 or 38 (for HT40), channel 149 or 151 (for HT40) was chosen as representative in final test.
5. The data is worse case.



Power	: AC 120V	Pol/Phase	: HORIZONTAL
Test Mode 1	: 802.11a, CH36	Temperature	: 25 °C
Memo	:	Humidity	: 47 %

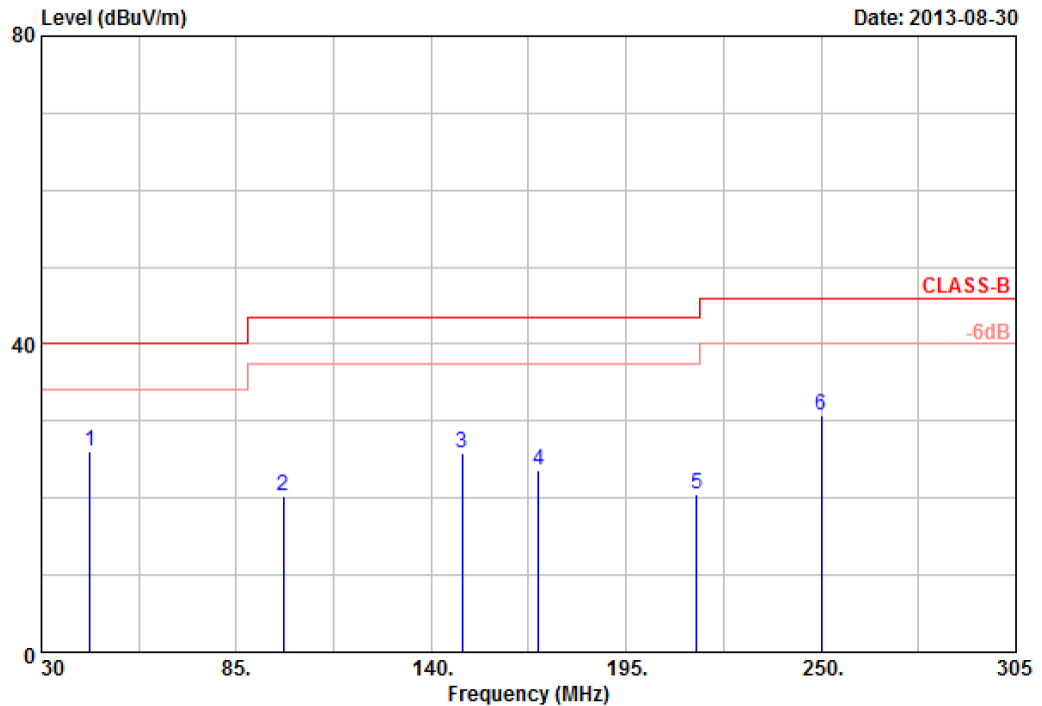

Item	Freq	Read Value	Factor	Result	Limit	Margin	Remark	Ant Pos	Tab Pos
	MHz	dBuV	dB/m	dBuV/m	dBuV/m	dB		cm	Deg
1	43.75	34.05	-8.03	26.02	40.00	-13.98	Peak	101	0
2	98.20	38.85	-18.63	20.22	43.50	-23.28	Peak	101	0
3	148.80	40.65	-14.69	25.96	43.50	-17.54	Peak	101	0
4	170.25	34.89	-11.29	23.60	43.50	-19.90	Peak	101	0
5	214.80	37.07	-16.46	20.61	43.50	-22.89	Peak	101	0
6	250.00	44.18	-13.52	30.66	46.00	-15.34	Peak	101	0

Notes:

1. Result = Read Value + Factor
2. Factor = Antenna Factor + Cable Loss - Amplifier
3. The resolution bandwidth of test receiver/spectrum analyzer is 120KHz and video bandwidth is 300kHz for Peak detection and Quasi-peak detection at frequency below 1GHz.
4. According to technical experiences, all spurious emission of 802.11a/an mode at Band1~4 channel are almost the same below 1GHz, so that the channel 36 or 38 (for HT40), channel 149 or 151 (for HT40) was chosen as representative in final test.
5. The data is worse case.



Power	: AC 120V	Pol/Phase	: HORIZONTAL
Test Mode 1	: 802.11a, CH36	Temperature	: 25 °C
Memo	:	Humidity	: 47 %

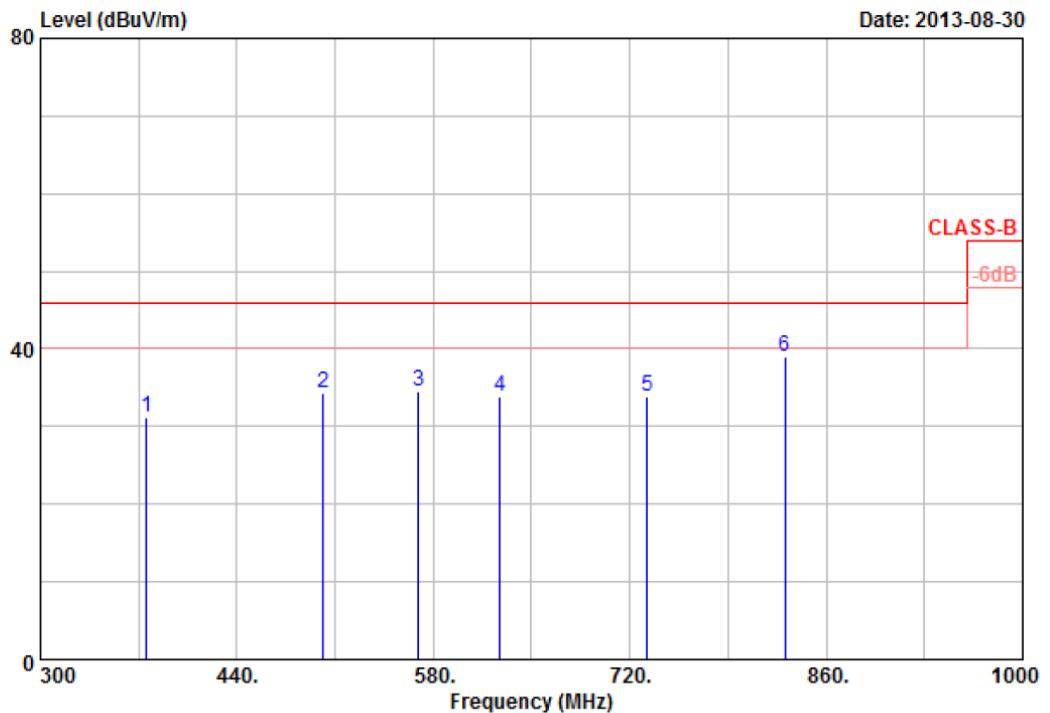

Item	Freq	Read Value	Factor	Result	Limit	Margin	Remark	Ant Pos	Tab Pos
	MHz	dBuV	dB/m	dBuV/m	dBuV/m	dB		cm	Deg
1	375.60	42.83	-11.68	31.15	46.00	-14.85	Peak	101	0
2	501.60	34.32	0.10	34.42	46.00	-11.58	Peak	101	0
3	569.50	31.20	3.36	34.56	46.00	-11.44	Peak	101	0
4	627.60	30.05	3.92	33.97	46.00	-12.03	Peak	101	0
5	732.60	29.84	3.98	33.82	46.00	-12.18	Peak	101	0
6	830.60	30.35	8.59	38.94	46.00	-7.06	Peak	101	0

Notes:

1. Result = Read Value + Factor
2. Factor = Antenna Factor + Cable Loss - Amplifier
3. The resolution bandwidth of test receiver/spectrum analyzer is 120KHz and video bandwidth is 300kHz for Peak detection and Quasi-peak detection at frequency below 1GHz.
4. According to technical experiences, all spurious emission of 802.11a/an mode at Band1~4 channel are almost the same below 1GHz, so that the channel 36 or 38 (for HT40), channel 149 or 151 (for HT40) was chosen as representative in final test.
5. The data is worse case.



Power	: AC 120V	Pol/Phase	: VERTICAL
Test Mode 2	: 802.11an HT20, CH36	Temperature	: 25 °C
Memo	:	Humidity	: 47 %

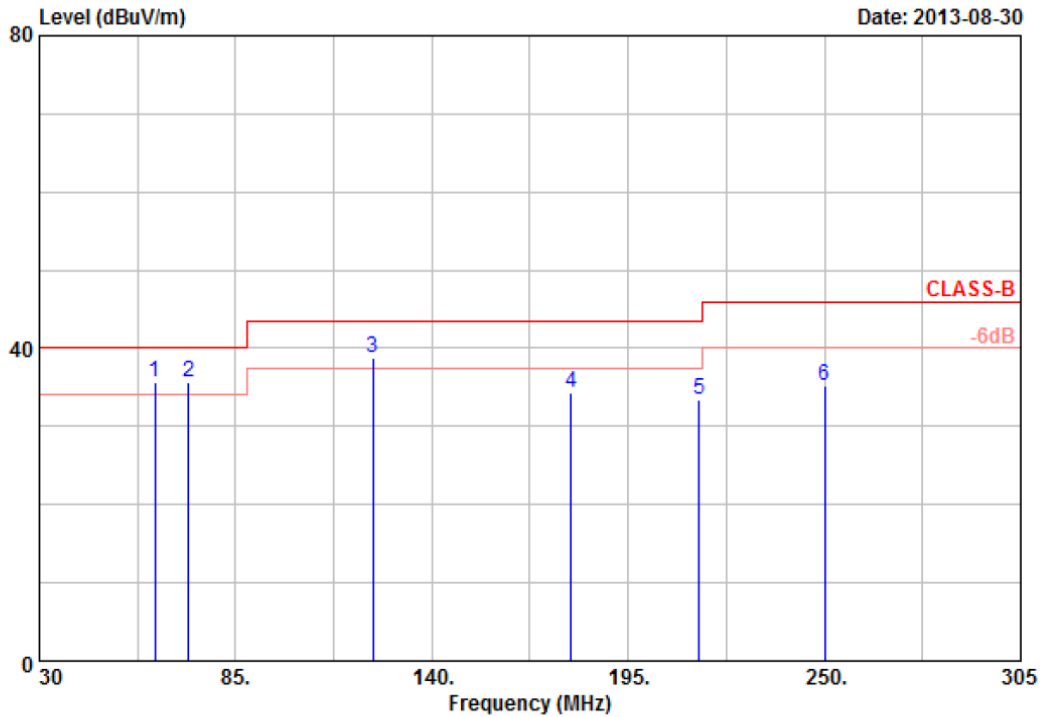

Item	Freq	Read Value	Factor	Result	Limit	Margin	Remark	Ant Pos	Tab Pos
	MHz	dBuV	dB/m	dBuV/m	dBuV/m	dB		cm	Deg
1	62.45	47.08	-11.33	35.75	40.00	-4.25	QP	101	0
2	71.80	46.30	-10.55	35.75	40.00	-4.25	QP	101	0
3	123.50	43.63	-4.84	38.79	43.50	-4.71	QP	101	0
4	179.05	40.72	-6.31	34.41	43.50	-9.09	Peak	101	0
5	214.80	40.50	-6.99	33.51	43.50	-9.99	Peak	101	0
6	250.00	46.79	-11.52	35.27	46.00	-10.73	Peak	101	0

Notes:

1. Result = Read Value + Factor
2. Factor = Antenna Factor + Cable Loss - Amplifier
3. The resolution bandwidth of test receiver/spectrum analyzer is 120KHz and video bandwidth is 300KHz for Peak detection and Quasi-peak detection at frequency below 1GHz.
4. According to technical experiences, all spurious emission of 802.11a/an mode at Band1~4 channel are almost the same below 1GHz, so that the channel 36 or 38 (for HT40), channel 149 or 151 (for HT40) was chosen as representative in final test.
5. The data is worse case.



Power	: AC 120V	Pol/Phase	: VERTICAL
Test Mode 2	: 802.11an HT20, CH36	Temperature	: 25 °C
Memo	:	Humidity	: 47 %

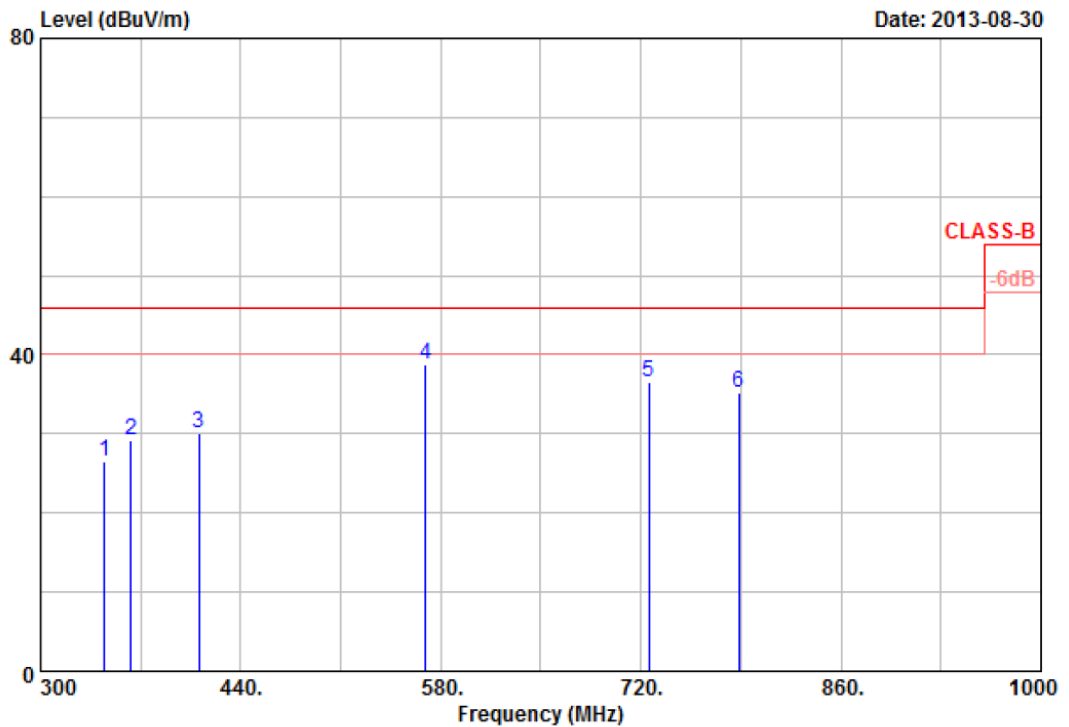

Item	Freq	Read Value	Factor	Result	Limit	Margin	Remark	Ant Pos	Tab Pos
	MHz	dBuV	dB/m	dBuV/m	dBuV/m	dB		cm	Deg
1	344.80	33.89	-7.36	26.53	46.00	-19.47	Peak	101	0
2	363.00	37.94	-8.72	29.22	46.00	-16.78	Peak	101	0
3	410.60	35.84	-5.83	30.01	46.00	-15.99	Peak	101	0
4	569.50	31.27	7.60	38.87	46.00	-7.13	Peak	101	0
5	725.60	30.39	6.12	36.51	46.00	-9.49	Peak	101	0
6	788.60	30.29	4.88	35.17	46.00	-10.83	Peak	101	0

Notes:

1. Result = Read Value + Factor
2. Factor = Antenna Factor + Cable Loss - Amplifier
3. The resolution bandwidth of test receiver/spectrum analyzer is 120KHz and video bandwidth is 300kHz for Peak detection and Quasi-peak detection at frequency below 1GHz.
4. According to technical experiences, all spurious emission of 802.11a/an mode at Band1~4 channel are almost the same below 1GHz, so that the channel 36 or 38 (for HT40), channel 149 or 151 (for HT40) was chosen as representative in final test.
5. The data is worse case.



Power	: AC 120V	Pol/Phase	: HORIZONTAL
Test Mode 2	: 802.11an HT20, CH36	Temperature	: 25 °C
Memo	:	Humidity	: 47 %

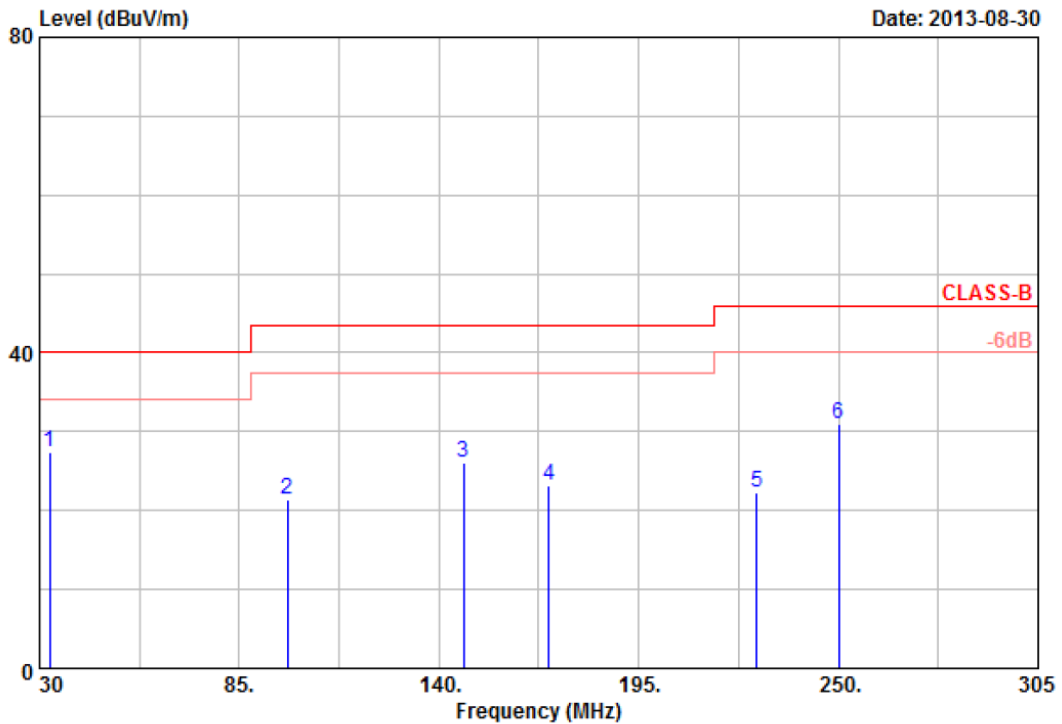

Item	Freq MHz	Read Value dBuV	Factor dB/m	Result dBuV/m	Limit dBuV/m	Margin dB	Remark	Ant Pos cm	Tab Pos Deg
1	32.75	33.73	-6.25	27.48	40.00	-12.52	Peak	101	0
2	98.20	39.98	-18.63	21.35	43.50	-22.15	Peak	101	0
3	146.88	40.70	-14.67	26.03	43.50	-17.47	Peak	101	0
4	170.25	34.50	-11.29	23.21	43.50	-20.29	Peak	101	0
5	227.45	37.27	-14.95	22.32	46.00	-23.68	Peak	101	0
6	250.00	44.54	-13.52	31.02	46.00	-14.98	Peak	101	0

Notes:

1. Result = Read Value + Factor
2. Factor = Antenna Factor + Cable Loss - Amplifier
3. The resolution bandwidth of test receiver/spectrum analyzer is 120KHz and video bandwidth is 300kHz for Peak detection and Quasi-peak detection at frequency below 1GHz.
4. According to technical experiences, all spurious emission of 802.11a/n mode at Band1~4 channel are almost the same below 1GHz, so that the channel 36 or 38 (for HT40), channel 149 or 151 (for HT40) was chosen as representative in final test.
5. The data is worse case.



Power	: AC 120V	Pol/Phase	: HORIZONTAL
Test Mode 2	: 802.11an HT20, CH36	Temperature	: 25 °C
Memo	:	Humidity	: 47 %

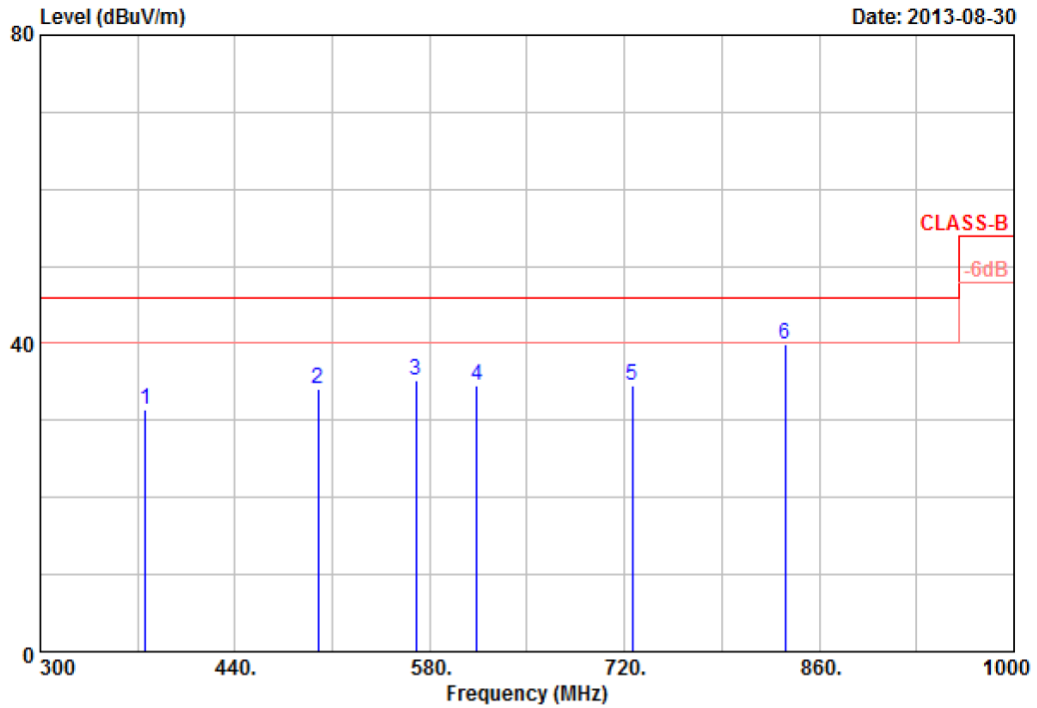

Item	Freq	Read Value	Factor	Result	Limit	Margin	Remark	Ant Pos	Tab Pos
	MHz	dBuV	dB/m	dBuV/m	dBuV/m	dB		cm	Deg
1	375.60	43.16	-11.68	31.48	46.00	-14.52	Peak	101	0
2	499.50	34.38	-0.22	34.16	46.00	-11.84	Peak	101	0
3	570.20	31.83	3.42	35.25	46.00	-10.75	Peak	101	0
4	613.60	30.96	3.55	34.51	46.00	-11.49	Peak	101	0
5	725.60	30.85	3.60	34.45	46.00	-11.55	Peak	101	0
6	835.50	30.94	8.89	39.83	46.00	-6.17	Peak	101	0

Notes:

1. Result = Read Value + Factor
2. Factor = Antenna Factor + Cable Loss - Amplifier
3. The resolution bandwidth of test receiver/spectrum analyzer is 120KHz and video bandwidth is 300kHz for Peak detection and Quasi-peak detection at frequency below 1GHz.
4. According to technical experiences, all spurious emission of 802.11a/an mode at Band1~4 channel are almost the same below 1GHz, so that the channel 36 or 38 (for HT40), channel 149 or 151 (for HT40) was chosen as representative in final test.
5. The data is worse case.



Power	: AC 120V	Pol/Phase	: VERTICAL
Test Mode 3	: 802.11an HT40, CH38	Temperature	: 25 °C
Memo	:	Humidity	: 47 %

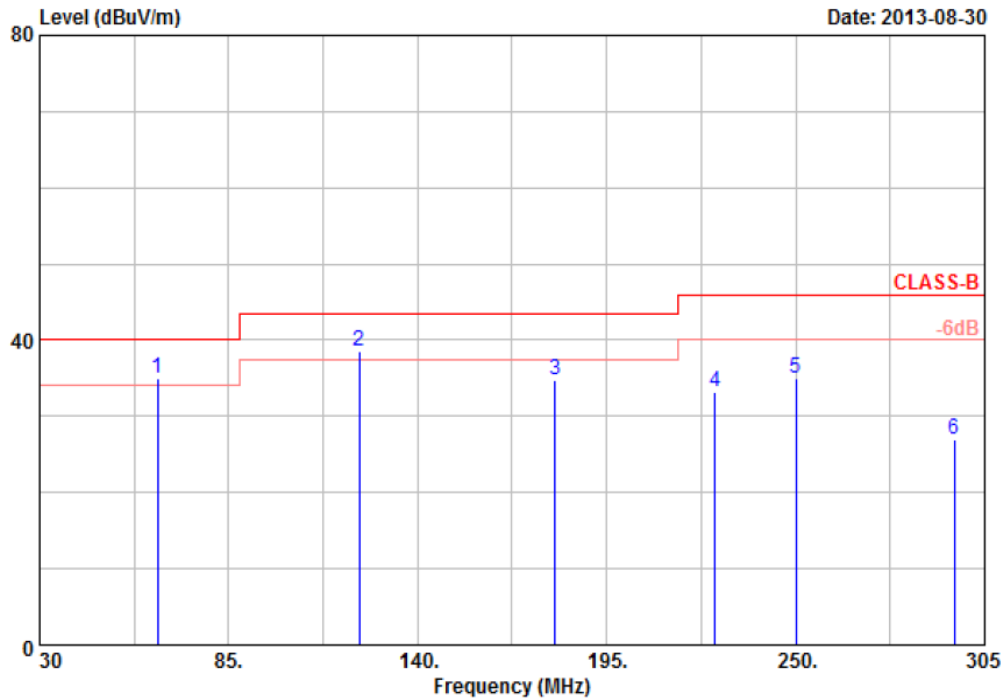

Item	Freq MHz	Read Value dBuV	Factor dB/m	Result dBuV/m	Limit dBuV/m	Margin dB	Remark	Ant Pos cm	Tab Pos Deg
1	64.38	46.83	-11.75	35.08	40.00	-4.92	QP	101	0
2	122.95	43.35	-4.81	38.54	43.50	-4.96	QP	101	0
3	179.88	39.74	-5.06	34.68	43.50	-8.82	Peak	101	0
4	226.63	40.29	-7.14	33.15	46.00	-12.85	Peak	101	0
5	250.00	46.44	-11.52	34.92	46.00	-11.08	Peak	101	0
6	296.20	36.37	-9.38	26.99	46.00	-19.01	Peak	101	0

Notes:

1. Result = Read Value + Factor
2. Factor = Antenna Factor + Cable Loss - Amplifier
3. The resolution bandwidth of test receiver/spectrum analyzer is 120KHz and video bandwidth is 300kHz for Peak detection and Quasi-peak detection at frequency below 1GHz.
4. According to technical experiences, all spurious emission of 802.11a/an mode at Band1~4 channel are almost the same below 1GHz, so that the channel 36 or 38 (for HT40), channel 149 or 151 (for HT40) was chosen as representative in final test.
5. The data is worse case.



Power	: AC 120V	Pol/Phase	: VERTICAL
Test Mode 3	: 802.11an HT40, CH38	Temperature	: 25 °C
Memo	:	Humidity	: 47 %

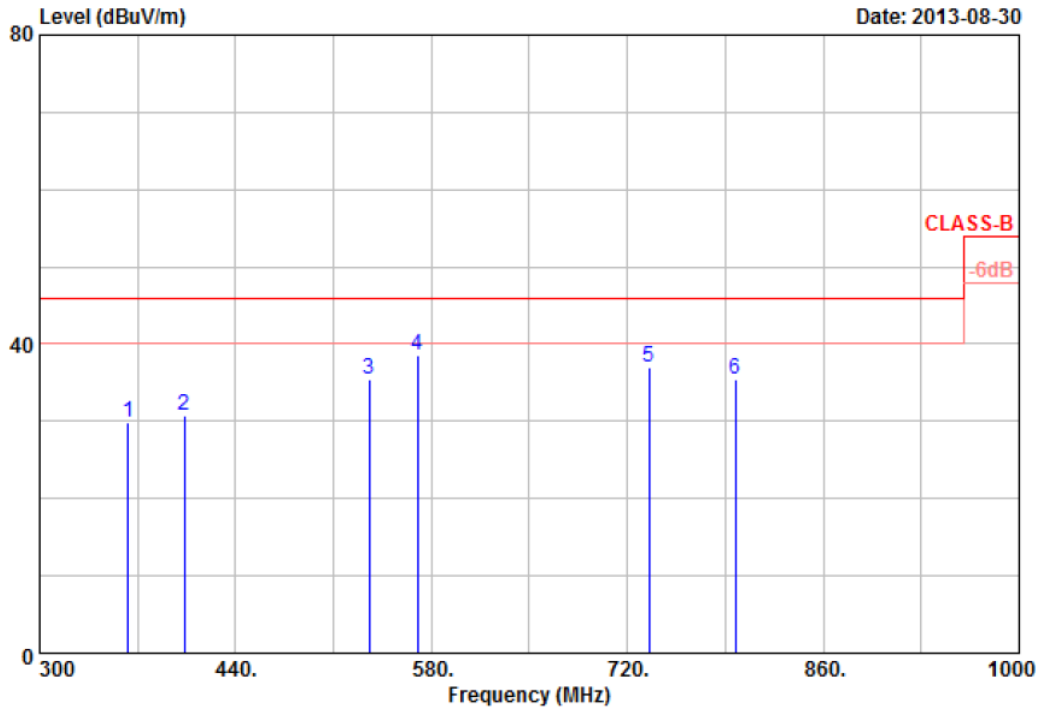

Item	Freq	Read Value	Factor	Result	Limit	Margin	Remark	Ant Pos	Tab Pos
	MHz	dBuV	dB/m	dBuV/m	dBuV/m	dB		cm	Deg
1	363.00	38.56	-8.72	29.84	46.00	-16.16	Peak	101	0
2	403.60	36.46	-5.76	30.70	46.00	-15.30	Peak	101	0
3	535.20	31.96	3.45	35.41	46.00	-10.59	Peak	101	0
4	570.20	30.90	7.59	38.49	46.00	-7.51	Peak	101	0
5	735.40	30.32	6.62	36.94	46.00	-9.06	Peak	101	0
6	797.00	29.38	5.94	35.32	46.00	-10.68	Peak	101	0

Notes:

1. Result = Read Value + Factor
2. Factor = Antenna Factor + Cable Loss - Amplifier
3. The resolution bandwidth of test receiver/spectrum analyzer is 120KHz and video bandwidth is 300kHz for Peak detection and Quasi-peak detection at frequency below 1GHz.
4. According to technical experiences, all spurious emission of 802.11a/an mode at Band1~4 channel are almost the same below 1GHz, so that the channel 36 or 38 (for HT40), channel 149 or 151 (for HT40) was chosen as representative in final test.
5. The data is worse case.



Power	: AC 120V	Pol/Phase	: HORIZONTAL
Test Mode 3	: 802.11an HT40, CH38	Temperature	: 25 °C
Memo	:	Humidity	: 47 %

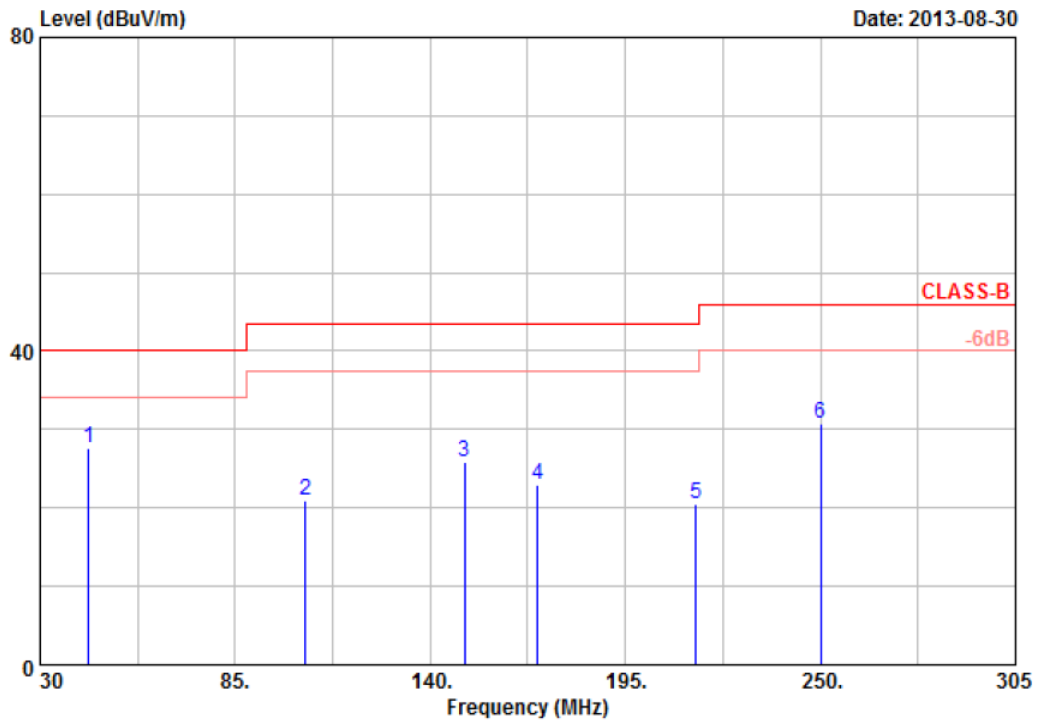

Item	Freq MHz	Read Value dBuV	Factor dB/m	Result dBuV/m	Limit dBuV/m	Margin dB	Remark	Ant Pos cm	Tab Pos Deg
1	43.75	35.61	-8.03	27.58	40.00	-12.42	Peak	101	0
2	104.80	39.73	-18.80	20.93	43.50	-22.57	Peak	101	0
3	149.63	40.61	-14.70	25.91	43.50	-17.59	Peak	101	0
4	170.25	34.29	-11.29	23.00	43.50	-20.50	Peak	101	0
5	214.80	36.94	-16.46	20.48	43.50	-23.02	Peak	101	0
6	250.00	44.21	-13.52	30.69	46.00	-15.31	Peak	101	0

Notes:

1. Result = Read Value + Factor
2. Factor = Antenna Factor + Cable Loss - Amplifier
3. The resolution bandwidth of test receiver/spectrum analyzer is 120KHz and video bandwidth is 300kHz for Peak detection and Quasi-peak detection at frequency below 1GHz.
4. According to technical experiences, all spurious emission of 802.11a/an mode at Band1~4 channel are almost the same below 1GHz, so that the channel 36 or 38 (for HT40), channel 149 or 151 (for HT40) was chosen as representative in final test.
5. The data is worse case.



Power	: AC 120V	Pol/Phase	: HORIZONTAL
Test Mode 3	: 802.11an HT40, CH38	Temperature	: 25 °C
Memo	:	Humidity	: 47 %

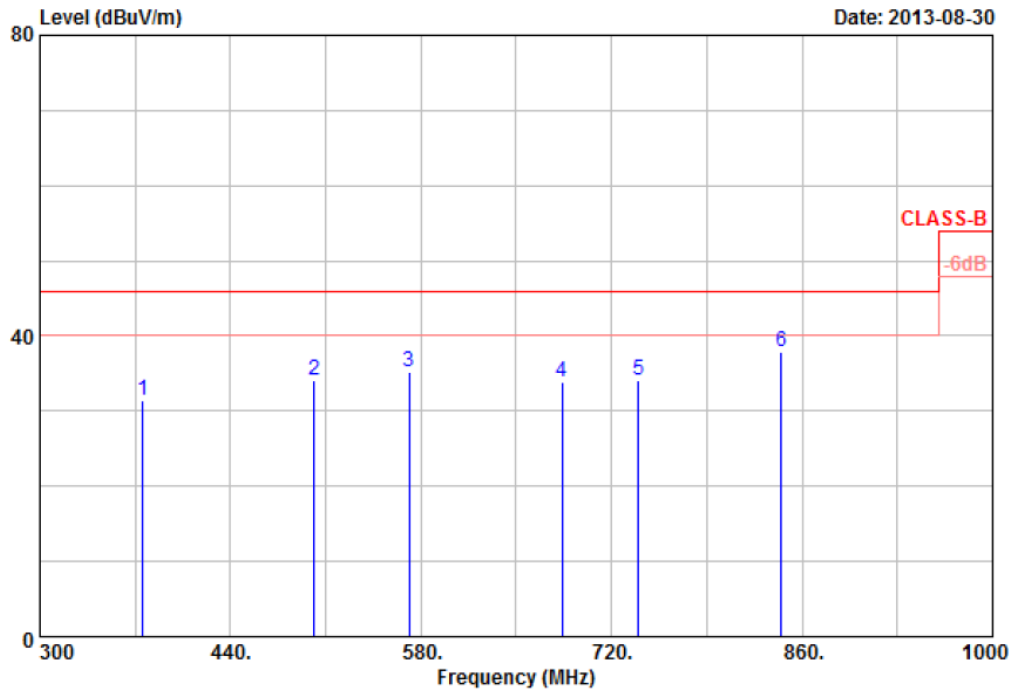

Item	Freq	Read Value	Factor	Result	Limit	Margin	Remark	Ant Pos	Tab Pos
	MHz	dBuV	dB/m	dBuV/m	dBuV/m	dB		cm	Deg
1	375.60	43.11	-11.68	31.43	46.00	-14.57	Peak	101	0
2	501.60	34.10	0.10	34.20	46.00	-11.80	Peak	101	0
3	571.60	32.43	2.88	35.31	46.00	-10.69	Peak	101	0
4	683.60	31.37	2.57	33.94	46.00	-12.06	Peak	101	0
5	739.60	30.52	3.67	34.19	46.00	-11.81	Peak	101	0
6	844.60	30.05	7.74	37.79	46.00	-8.21	Peak	101	0

Notes:

1. Result = Read Value + Factor
2. Factor = Antenna Factor + Cable Loss - Amplifier
3. The resolution bandwidth of test receiver/spectrum analyzer is 120KHz and video bandwidth is 300kHz for Peak detection and Quasi-peak detection at frequency below 1GHz.
4. According to technical experiences, all spurious emission of 802.11a/n mode at Band1~4 channel are almost the same below 1GHz, so that the channel 36 or 38 (for HT40), channel 149 or 151 (for HT40) was chosen as representative in final test.
5. The data is worse case.



5.7. Test Result and Data (1GHz ~ 40GHz)

Power	: AC 120V	Pol/Phase	: VERTICAL
Test Mode 1	: 802.11a, CH36	Temperature	: 26 °C
Memo	:	Humidity	: 48 %

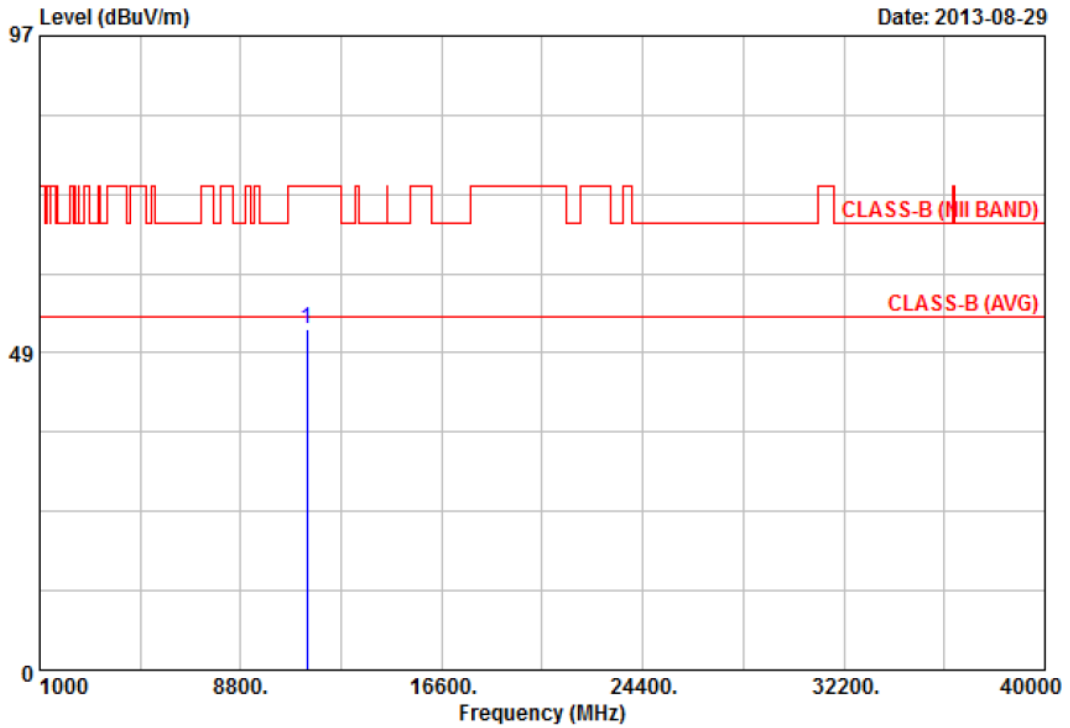

Item	Freq	Read Value	Factor	Result	Limit	Margin	Remark	Ant Pos	Tab Pos
	MHz	dBuV	dB/m	dBuV/m	dBuV/m	dB		cm	Deg
1	11360.64	44.85	7.34	52.19	74.00	-21.81	Peak	101	186

Notes:

1. Result = Read Value + Factor
2. Factor = Antenna Factor + Cable Loss - Amplifier
3. The resolution bandwidth of test receiver/spectrum analyzer is 120KHz and video bandwidth is 300kHz for Peak detection and Quasi-peak detection at frequency below 1GHz.
4. The resolution bandwidth of test receiver/spectrum analyzer is 1MHz and video bandwidth is 3MHz for Peak detection at frequency above 1GHz.
5. The resolution bandwidth of test receiver/spectrum analyzer is 1MHz and video bandwidth is 3MHz (detector sample mode) for Average detection at frequency above 1GHz.
6. The other emissions is too low to be measured.
7. The data is worse case.



Power	: AC 120V	Pol/Phase	: HORIZONTAL
Test Mode 1	: 802.11a, CH36	Temperature	: 26 °C
Memo	:	Humidity	: 48 %

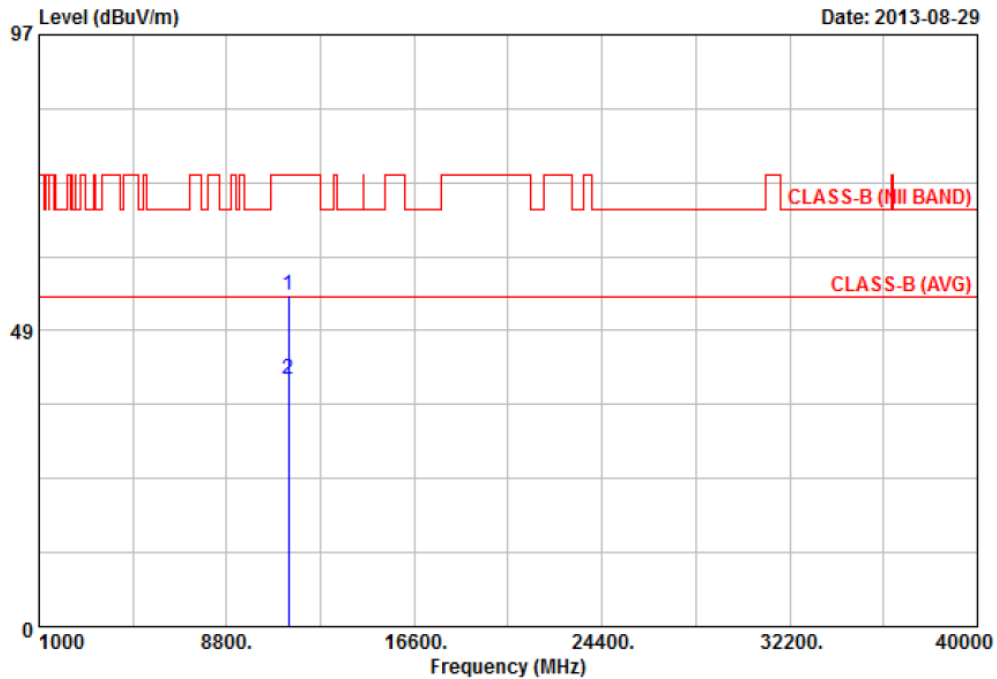

Item	Freq	Read Value	Factor	Result	Limit	Margin	Remark	Ant Pos	Tab Pos
	MHz	dBuV	dB/m	dBuV/m	dBuV/m	dB		cm	Deg
1	11359.54	44.21	10.05	54.26	74.00	-19.74	Peak	101	186
2	11360.24	30.41	10.06	40.47	54.00	-13.53	Average	101	186

Notes:

1. Result = Read Value + Factor
2. Factor = Antenna Factor + Cable Loss - Amplifier
3. The resolution bandwidth of test receiver/spectrum analyzer is 120KHz and video bandwidth is 300kHz for Peak detection and Quasi-peak detection at frequency below 1GHz.
4. The resolution bandwidth of test receiver/spectrum analyzer is 1MHz and video bandwidth is 3MHz for Peak detection at frequency above 1GHz.
5. The resolution bandwidth of test receiver/spectrum analyzer is 1MHz and video bandwidth is 3MHz (detector sample mode) for Average detection at frequency above 1GHz.
6. The other emissions is too low to be measured.
7. The data is worse case.