



# FCC TEST REPORT

According to

## FCC Rules and Regulations Part 15 Subpart C

Applicant	: Amped Wireless
Address	: 13089 Peyton Dr. #C307, Chino Hills CA 91709
Equipment	: Bluetooth Speaker Adapter
Model No.	: BTSA1
FCC ID.	: ZTT-BTSA1
Trade Name	: Amped Wireless

- The test result refers exclusively to the test presented test model / sample.,
- Without written approval of **CerpPASS Technology Corp.** the test report shall not be reproduced except in full.
- The EUT is also considered as a kind of computer peripheral, because the connection to computer is necessary for typical use. It has been verified to comply with the requirements of FCC Part 15, Subpart B, Class B (DoC). The test report has been issued separately.



## Contents

<b>1. Report of Measurements and Examinations</b> .....	<b>6</b>
1.1 List of Measurements and Examinations.....	6
<b>2. Test Configuration of Equipment under Test</b> .....	<b>7</b>
2.1 Feature of Equipment under Test.....	7
2.2 Carrier Frequency of Channels.....	7
2.3 Test Mode & Test Software.....	8
2.4 Description of Test System.....	8
2.5 General Information of Test.....	9
2.6 Measurement Uncertainty.....	9
<b>3. Antenna Requirements</b> .....	<b>10</b>
3.1 Standard Applicable.....	10
3.2 Antenna Construction and Directional Gain.....	10
<b>4. Test of Conducted Emission</b> .....	<b>11</b>
4.1 Test Limit.....	11
4.2 Test Procedures.....	11
4.3 Typical Test Setup.....	12
4.4 Measurement Equipment.....	12
4.5 Test Result and Data.....	13
4.6 Test Photographs.....	19
<b>5. Test of Radiated Emission</b> .....	<b>20</b>
5.1 Test Limit.....	20
5.2 Test Procedures.....	20
5.3 Typical Test Setup.....	21
5.4 Measurement equipment.....	21
5.5 Test Result and Data (9kHz ~ 30MHz).....	22
5.6 Test Result and Data (30MHz ~ 1GHz).....	22
5.7 Test Result and Data (1GHz ~ 25GHz).....	34
5.8 Test Photographs (30MHz ~ 1GHz).....	52
5.9 Test Photographs (1GHz ~ 25GHz).....	53
<b>6. 20dB Bandwidth Measurement Data</b> .....	<b>54</b>
6.1 Test Limit.....	54
6.2 Test Procedures.....	54
6.3 Test Setup Layout.....	54
6.4 Measurement equipment.....	54
6.5 Test Result and Data.....	55
<b>7. Frequencies Separation</b> .....	<b>61</b>
7.1 Test Limit.....	61
7.2 Test Procedures.....	61
7.3 Test Setup Layout.....	61
7.4 Measurement equipment.....	61
7.5 Test Result and Data.....	62
<b>8. Dwell Time on each channel</b> .....	<b>68</b>
8.1 Test Limit.....	68



8.2 Test Procedures ..... 68

8.3 Test Setup Layout ..... 68

8.4 Measurement equipment ..... 68

8.5 Test Result and Data ..... 69

**9. Number of Hopping Channels ..... 78**

9.1 Test Limit ..... 78

9.2 Test Procedures ..... 78

9.3 Test Setup Layout ..... 78

9.4 Measurement equipment ..... 78

9.5 Test Result and Data ..... 78

**10. Maximum Peak Output Power ..... 81**

10.1 Test Limit ..... 81

10.2 Test Procedures ..... 81

10.3 Test Setup Layout ..... 81

10.4 Measurement equipment ..... 81

10.5 Test Result and Data ..... 82

**11. Band Edges Measurement ..... 88**

11.1 Test Limit ..... 88

11.2 Test Procedure ..... 88

11.3 Test Setup Layout ..... 88

11.4 List of Measuring Equipment Used ..... 88

11.5 Test Result and Data ..... 88

11.6 Restrict band emission Measurement Data ..... 95

**12. Restricted Bands of Operation ..... 98**

12.1 Labeling Requirement ..... 98

**Appendix A. Photographs of EUT ..... A1 ~ A6**





# CERTIFICATE OF COMPLIANCE

According to

## FCC Rules and Regulations Part 15 Subpart C

Applicant : Amped Wireless  
Address : 13089 Peyton Dr. #C307, Chino Hills CA  
91709  
Equipment : Bluetooth Speaker Adapter  
Model No. : BTSA1  
FCC ID. : ZTT-BTSA1

**I HEREBY CERTIFY THAT :**

The measurements shown in this test report were made in accordance with the procedures given in **ANSI C63.4** The equipment was **passed** the test performed according to **FCC Rules and Regulations Part 15 Subpart C (2010)**.

The test was carried out on Apr. 30, 2014 at **CerpPASS Technology Corp.**

Approval by :

Test Engineer:

Hill Chen  
EMC/RF B.U. Assistant Manager

Aiden Lu  
Engineer



## 1. Report of Measurements and Examinations

### 1.1 List of Measurements and Examinations

FCC Rule	Description of Test	Result
15.203	. Antenna Requirement	Pass
15.207	. Conducted Emission	Pass
15.209	. Radiated Emission	Pass
15.247(a)(1)	. Channel Carrier Frequencies Separation	Pass
15.247(a)(1)	. 20dB Bandwidth Measurement	Pass
15.247(a)(1)	. Dwell Time	Pass
15.247(b)	. Number of Hopping Channels	Pass
15.247(b)	. Peak Output Power Measurement Data	Pass
15.247(d)	. Band Edges Measurement Data	Pass



## 2. Test Configuration of Equipment under Test

### 2.1 Feature of Equipment under Test

Frequency Range	2402-2480MHz
Type of Modulation	GFSK, $\pi/4$ -DQPSK, 8DPSK
Channel of Bandwidth	1MHz
Type of Antenna	Dipole Antenna/ External
Antenna Gain	2 dBi

### 2.2 Carrier Frequency of Channels

Channel	Frequency (MHz)	Channel	Frequency (MHz)	Channel	Frequency (MHz)	Channel	Frequency (MHz)
00	2402	20	2422	40	2442	60	2462
01	2403	21	2423	41	2443	61	2463
02	2404	22	2424	42	2444	62	2464
03	2405	23	2425	43	2445	63	2465
04	2406	24	2426	44	2446	64	2466
05	2407	25	2427	45	2447	65	2467
06	2408	26	2428	46	2448	66	2468
07	2409	27	2429	47	2449	67	2469
08	2410	28	2430	48	2450	68	2470
09	2411	29	2431	49	2451	69	2471
10	2412	30	2432	50	2452	70	2472
11	2413	31	2433	51	2453	71	2473
12	2414	32	2434	52	2454	72	2474
13	2415	33	2435	53	2455	73	2475
14	2416	34	2436	54	2456	74	2476
15	2417	35	2437	55	2457	75	2477
16	2418	36	2438	56	2458	76	2478
17	2419	37	2439	57	2459	77	2479
18	2420	38	2440	58	2460	78	2480
19	2421	39	2441	59	2461	---	---



### 2.3 Test Mode & Test Software

- a. During testing, the interface cables and equipment positions were varied according to ANSI C63.4
- b. The test program “ BlueTest3(2.5)” was executed to keep transmit and receive data via Bluetooth.
- c. The following test mode was performed for conduction and radiation test:
  - GFSK: CH 00: 2402MHz, CH 39: 2441MHz, CH 78: 2480MHz.
  - $\pi/4$ -DQPSK: CH 00: 2402MHz, CH 39: 2441MHz, CH 78: 2480MHz.
  - 8DPSK: CH 00: 2402MHz, CH 39: 2441MHz, CH 78: 2480MHz.

### 2.4 Description of Test System

Device	Manufacturer	Model No.	Description
Notebook	ASUS	A8J	Power Cable, Unshielding 1.8m





## 2.5 General Information of Test

Test Site :	Cerpass Technology Corp. 2F-11, No. 3, Yuan Qu St., (Nankang Software Park), Taipei, Taiwan 115, R.O.C.
Test Site Location (OATS2-SD) :	No.68-1, Shihbachongsi, Shihding Township, Taipei City 223, Taiwan, R.O.C.
FCC Registration Number:	TW1049, TW1061, 390316, 488071
IC Registration Number :	4934B-1, 4934D-1
VCCI Registration Number:	T-1173 for Telecommunication Test C-4139 for Conducted emission test R-3428 for Radiated emission test G-97 for Radiated emission test above 1GHz
Frequency Range Investigated:	Conducted: from 150kHz to 30 MHz Radiation: from 30 MHz to 24800MHz
Test Distance:	The test distance of radiated emission from antenna to EUT is 3 M.
Laboratory Accreditation :	 NVLAP LAB CODE: 200954-0

## 2.6 Measurement Uncertainty

Measurement Item	Measurement Frequency	Polarization	Uncertainty
Conducted Emission	9 kHz ~ 30 MHz	LINE/NEUTRAL	3.25 dB
Radiated Emission	30 MHz ~ 1,000 MHz	Vertical / Horizontal	3.93 dB
	1,000 MHz ~ 18,000 MHz	Vertical / Horizontal	5.18dB
6 dB Bandwidth	---	---	7500 Hz
Maximum Peak Output Power	---	---	1.4 dB
100kHz Bandwidth of Frequency Band Edges	---	---	2.2 dB
Power Spectral Density	---	---	2.2 dB



### 3. Antenna Requirements

#### 3.1 Standard Applicable

For intentional device, according to FCC 47 CFR Section 15.203, an intentional radiator shall be designed to ensure that no antenna other than that furnished by the responsible party shall be used with the device.

And according to FCC 47 CFR Section 15.247 (b), if transmitting antennas of directional gain greater than 6dBi are used, the power shall be reduced by the amount in dB that the directional gain of the antenna exceeds 6dBi.

#### 3.2 Antenna Construction and Directional Gain

Antenna type: Dipole Antenna

Antenna Gain: 2 dBi



## 4. Test of Conducted Emission

### 4.1 Test Limit

Conducted Emissions were measured from 150 kHz to 30 MHz with a bandwidth of 9 KHz on the 120 VAC power and return leads of the EUT according to the methods defined in ANSI C63.4-2009 Section 3.1. The EUT was placed on a nonmetallic stand in a shielded room 0.8 meters above the ground plane as shown in section 2.2. The interface cables and equipment positioning were varied within limits of reasonable applications to determine the position produced maximum conducted emissions.

Frequency (MHz)	Quasi Peak (dB $\mu$ V)	Average (dB $\mu$ V)
0.15 – 0.5	66-56*	56-46*
0.5 – 5.0	56	46
5.0 – 30.0	60	50

\*Decreases with the logarithm of the frequency.

### 4.2 Test Procedures

- a. The EUT was placed 0.4 meter from the conducting wall of the shielding room was kept at least 80 centimeters from any other grounded conducting surface.
- b. Connect EUT to the power mains through a line impedance stabilization network (LISN).
- c. All the support units are connecting to the other LISN.
- d. The LISN provides 50 ohm coupling impedance for the measuring instrument.
- e. The FCC states that a 50 ohm, 50 micro-Henry LISN should be used.
- f. Both sides of AC line were checked for maximum conducted interference.
- g. The frequency range from 150 kHz to 30 MHz was searched.
- h. Set the test-receiver system to Peak Detect Function and Specified Bandwidth with Maximum Hold Mode.



### 4.3 Typical Test Setup

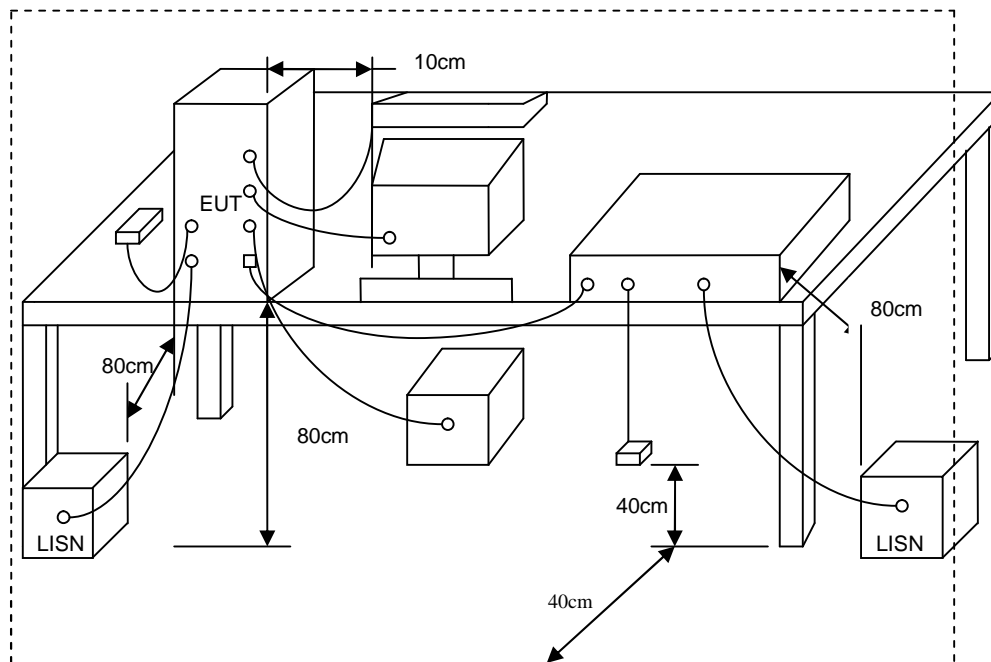

### 4.4 Measurement Equipment

Instrument	Model No.	Manufacturer	Serial No.	Calibration Date	Valid Date
EMI Receiver	R&S	ESCI	100821	2013/09/18	2014/09/17
LISN	Rolf Heine	NNB-2/16Z	02/10191	2013/09/30	2014/09/29
LISN	Schwarzbeck	NSLK 8127	8127-568	2013/08/30	2014/08/29



### 4.5 Test Result and Data

Power	: AC 120V	Pol/Phase	: LINE
Test Mode 1	: GFSK, CH0	Temperature	: 22 °C
Test Date	: Oct. 21, 2013	Humidity	: 61 %

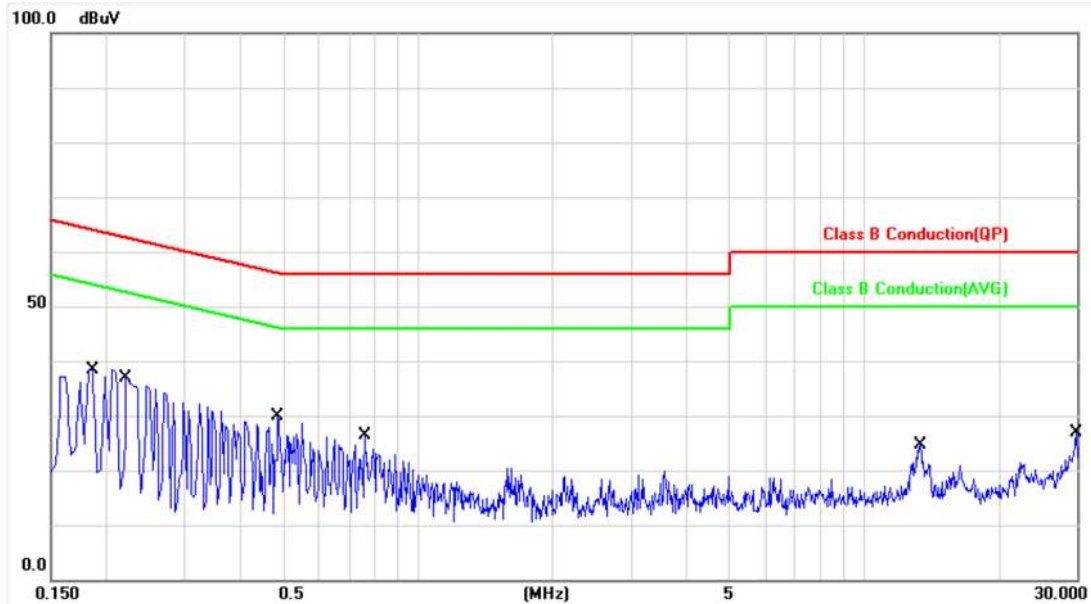

No.	Frequency (MHz)	Factor (dBuV)	Reading (dBuV)	Level (dBuV)	Limit (dBuV)	Margin (dB)	Detector	P/F
1	0.1860	10.39	22.91	33.30	64.21	-30.91	QP	P
2	0.1860	10.39	5.43	15.82	54.21	-38.39	AVG	P
3	0.2220	10.36	21.50	31.86	62.74	-30.88	QP	P
4	0.2220	10.36	3.93	14.29	52.74	-38.45	AVG	P
5	0.4860	10.28	10.77	21.05	56.24	-35.19	QP	P
6	0.4860	10.28	-0.21	10.07	46.24	-36.17	AVG	P
7	0.7620	10.29	5.90	16.19	56.00	-39.81	QP	P
8	0.7620	10.29	-0.67	9.62	46.00	-36.38	AVG	P
9	13.3620	10.86	11.00	21.86	60.00	-38.14	QP	P
10	13.3620	10.86	3.51	14.37	50.00	-35.63	AVG	P
11	29.9460	11.44	7.87	19.31	60.00	-40.69	QP	P
12	29.9460	11.44	1.26	12.70	50.00	-37.30	AVG	P

Note: Level = Reading + Factor  
 Margin = Level – Limit



Power	: AC 120V	Pol/Phase	: NEUTRAL
Test Mode 1	: GFSK, CH0	Temperature	: 22 °C
Test Date	: Oct. 21, 2013	Humidity	: 61 %

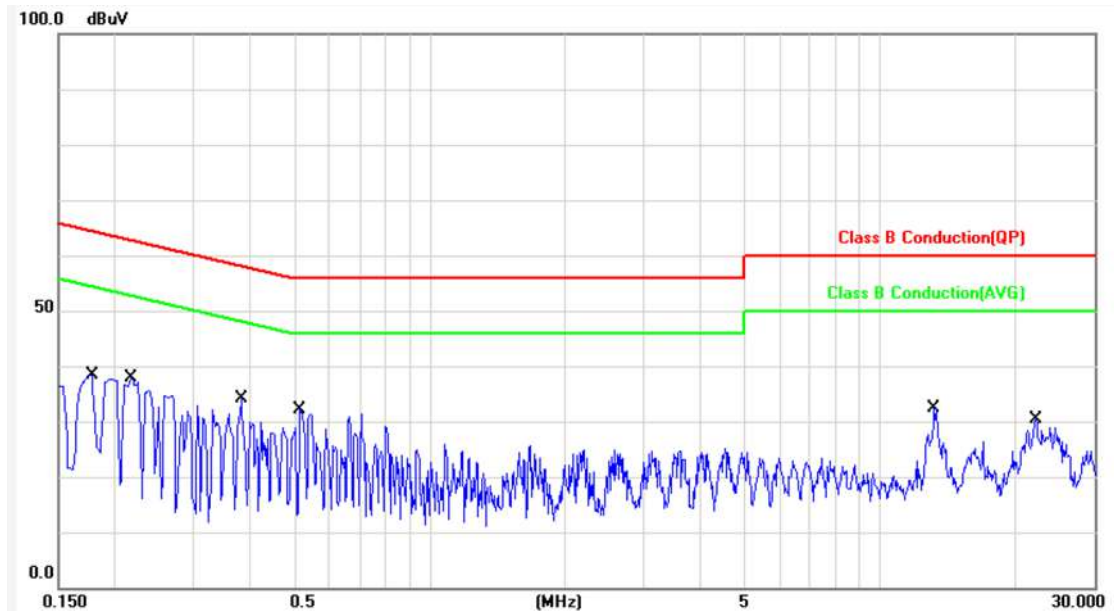

No.	Frequency (MHz)	Factor (dBuV)	Reading (dBuV)	Level (dBuV)	Limit (dBuV)	Margin (dB)	Detector	P/F
1	0.1780	10.39	22.84	33.23	64.57	-31.34	QP	P
2	0.1780	10.39	10.88	21.27	54.57	-33.30	AVG	P
3	0.2180	10.35	21.84	32.19	62.89	-30.70	QP	P
4	0.2180	10.35	5.40	15.75	52.89	-37.14	AVG	P
5	0.3820	10.30	14.76	25.06	58.23	-33.17	QP	P
6	0.3820	10.30	2.92	13.22	48.23	-35.01	AVG	P
7	0.5180	10.27	16.07	26.34	56.00	-29.66	QP	P
8	0.5180	10.27	4.34	14.61	46.00	-31.39	AVG	P
9	13.2020	10.85	8.39	19.24	60.00	-40.76	QP	P
10	13.2020	10.85	1.47	12.32	50.00	-37.68	AVG	P
11	22.2660	11.17	8.22	19.39	60.00	-40.61	QP	P
12	22.2660	11.17	0.45	11.62	50.00	-38.38	AVG	P

Note: Level = Reading + Factor  
Margin = Level – Limit



Power	: AC 120V	Pol/Phase	: LINE
Test Mode 2	: $\pi/4$ -DQPSK, CH0	Temperature	: 22 °C
Test Date	: Oct. 21, 2013	Humidity	: 61 %

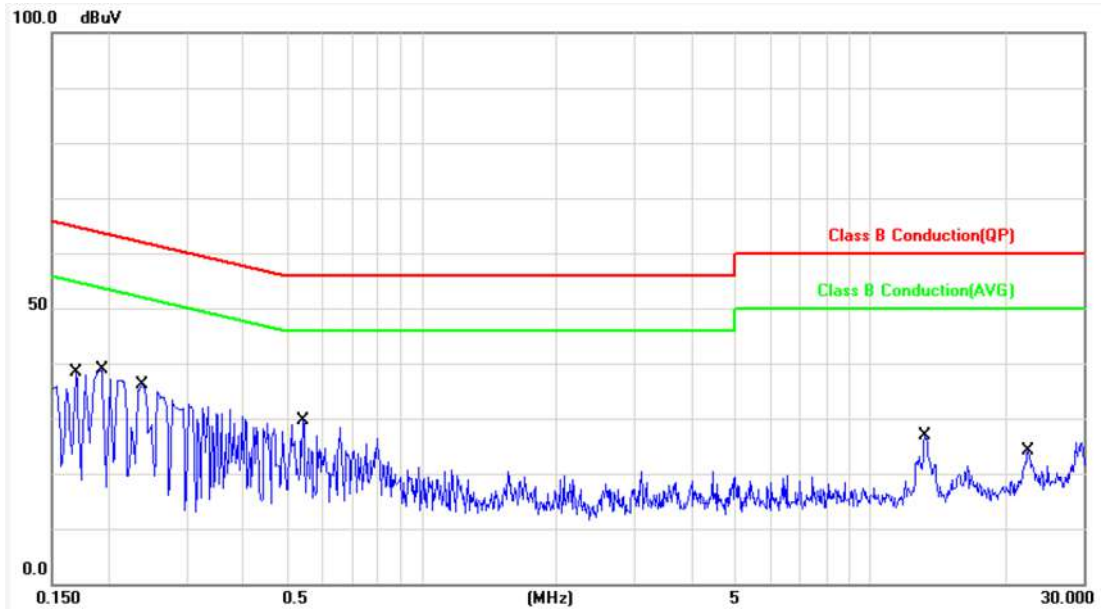

No.	Frequency (MHz)	Factor (dBuV)	Reading (dBuV)	Level (dBuV)	Limit (dBuV)	Margin (dB)	Detector	P/F
1	0.1700	10.41	22.16	32.57	64.96	-32.39	QP	P
2	0.1700	10.41	7.73	18.14	54.96	-36.82	AVG	P
3	0.1940	10.38	22.80	33.18	63.86	-30.68	QP	P
4	0.1940	10.38	6.55	16.93	53.86	-36.93	AVG	P
5	0.2380	10.35	20.41	30.76	62.16	-31.40	QP	P
6	0.2380	10.35	3.13	13.48	52.16	-38.68	AVG	P
7	0.5460	10.27	10.41	20.68	56.00	-35.32	QP	P
8	0.5460	10.27	0.81	11.08	46.00	-34.92	AVG	P
9	13.3220	10.86	9.94	20.80	60.00	-39.20	QP	P
10	13.3220	10.86	2.64	13.50	50.00	-36.50	AVG	P
11	22.6380	11.19	5.25	16.44	60.00	-43.56	QP	P
12	22.6380	11.19	-0.10	11.09	50.00	-38.91	AVG	P

Note: Level = Reading + Factor  
Margin = Level – Limit



Power	: AC 120V	Pol/Phase	: NEUTRAL
Test Mode 2	: $\pi/4$ -DQPSK, CH0	Temperature	: 22 °C
Test Date	: Oct. 21, 2013	Humidity	: 61 %

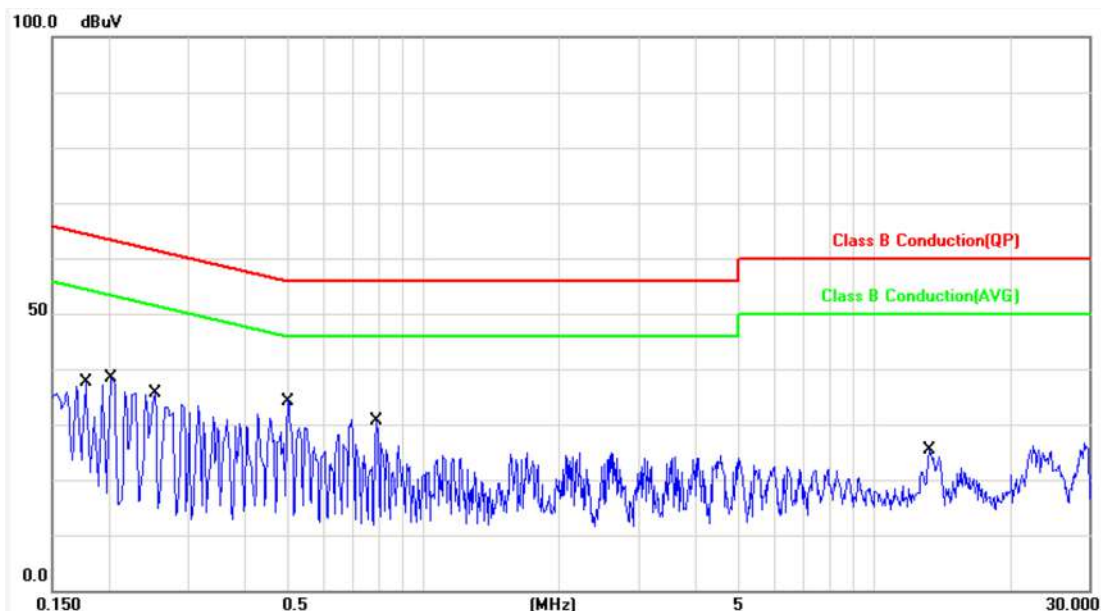

No.	Frequency (MHz)	Factor (dBuV)	Reading (dBuV)	Level (dBuV)	Limit (dBuV)	Margin (dB)	Detector	P/F
1	0.1780	10.39	22.66	33.05	64.57	-31.52	QP	P
2	0.1780	10.39	10.87	21.26	54.57	-33.31	AVG	P
3	0.2020	10.36	22.58	32.94	63.52	-30.58	QP	P
4	0.2020	10.36	6.31	16.67	53.52	-36.85	AVG	P
5	0.2540	10.34	19.64	29.98	61.62	-31.64	QP	P
6	0.2540	10.34	3.68	14.02	51.62	-37.60	AVG	P
7	0.5020	10.27	15.93	26.20	56.00	-29.80	QP	P
8	0.5020	10.27	4.35	14.62	46.00	-31.38	AVG	P
9	0.7900	10.29	13.98	24.27	56.00	-31.73	QP	P
10	0.7900	10.29	2.57	12.86	46.00	-33.14	AVG	P
11	13.2740	10.85	12.20	23.05	60.00	-36.95	QP	P
12	13.2740	10.85	3.98	14.83	50.00	-35.17	AVG	P

Note: Level = Reading + Factor  
Margin = Level – Limit





Power	: AC 120V	Pol/Phase	: LINE
Test Mode 3	: 8DPSK	Temperature	: 22 °C
Test Date	: Oct. 21, 2013	Humidity	: 61 %

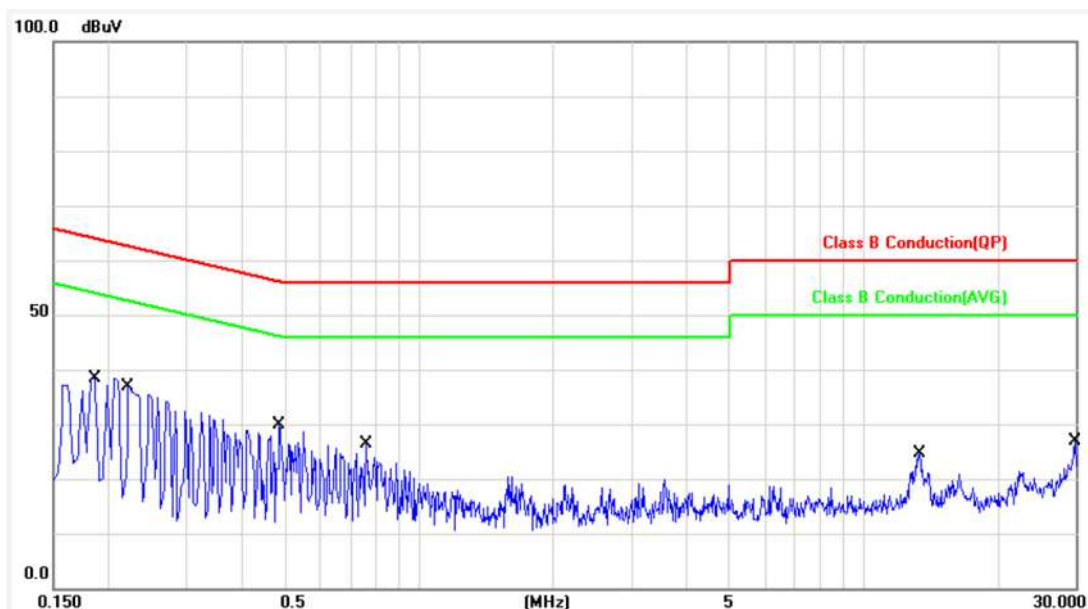

No.	Frequency (MHz)	Factor (dBuV)	Reading (dBuV)	Level (dBuV)	Limit (dBuV)	Margin (dB)	Detector	P/F
1	0.1860	10.37	23.25	33.62	64.21	-30.59	QP	P
2	0.1860	10.37	5.09	15.46	54.21	-38.75	AVG	P
3	0.2220	10.34	21.19	31.53	62.74	-31.21	QP	P
4	0.2220	10.34	3.81	14.15	52.74	-38.59	AVG	P
5	0.4860	10.25	11.21	21.46	56.24	-34.78	QP	P
6	0.4860	10.25	0.48	10.73	46.24	-35.51	AVG	P
7	0.7620	10.24	6.12	16.36	56.00	-39.64	QP	P
8	0.7620	10.24	-0.76	9.48	46.00	-36.52	AVG	P
9	13.3620	10.66	11.09	21.75	60.00	-38.25	QP	P
10	13.3620	10.66	4.17	14.83	50.00	-35.17	AVG	P
11	29.9460	11.17	8.09	19.26	60.00	-40.74	QP	P
12	29.9460	11.17	1.46	12.63	50.00	-37.37	AVG	P

Note: Level = Reading + Factor  
Margin = Level – Limit



Power	: AC 120V	Pol/Phase	: NEUTRAL
Test Mode 3	: 8DPSK	Temperature	: 22 °C
Test Date	: Oct. 21, 2013	Humidity	: 61 %

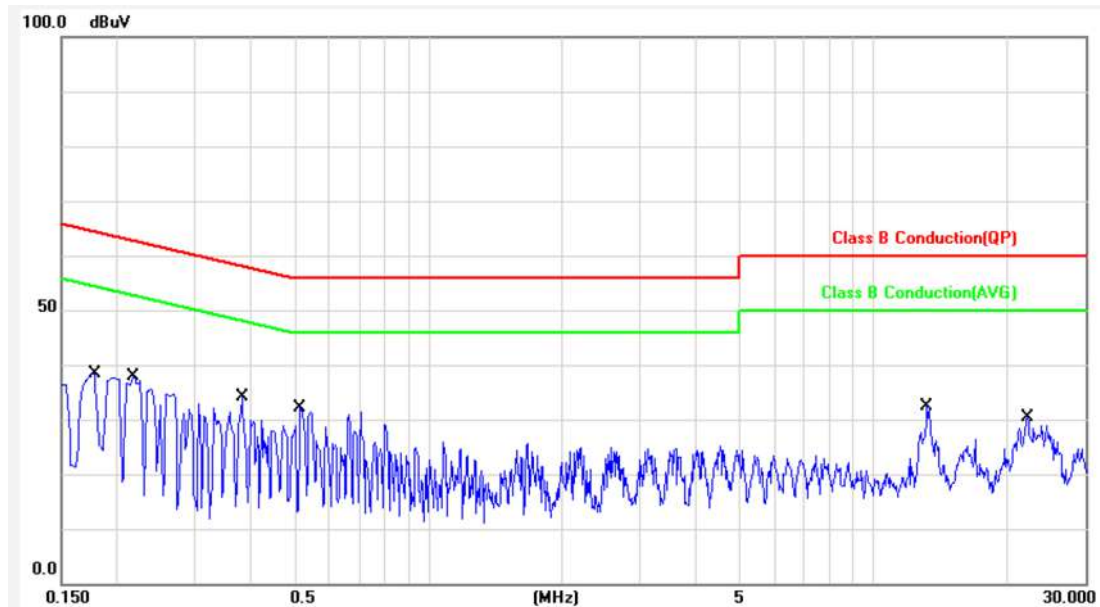

No.	Frequency (MHz)	Factor (dBuV)	Reading (dBuV)	Level (dBuV)	Limit (dBuV)	Margin (dB)	Detector	P/F
1	0.1780	10.37	23.16	33.53	64.57	-31.04	QP	P
2	0.1780	10.37	10.96	21.33	54.57	-33.24	AVG	P
3	0.2180	10.33	22.42	32.75	62.89	-30.14	QP	P
4	0.2180	10.33	5.48	15.81	52.89	-37.08	AVG	P
5	0.3820	10.27	14.86	25.13	58.23	-33.10	QP	P
6	0.3820	10.27	3.14	13.41	48.23	-34.82	AVG	P
7	0.5180	10.24	15.98	26.22	56.00	-29.78	QP	P
8	0.5180	10.24	4.23	14.47	46.00	-31.53	AVG	P
9	13.2020	10.65	9.10	19.75	60.00	-40.25	QP	P
10	13.2020	10.65	1.81	12.46	50.00	-37.54	AVG	P
11	22.2660	10.93	8.97	19.90	60.00	-40.10	QP	P
12	22.2660	10.93	0.48	11.41	50.00	-38.59	AVG	P

Note: Level = Reading + Factor  
Margin = Level – Limit



## 5. Test of Radiated Emission

### 5.1 Test Limit

Radiated emissions from 30 MHz to 25 GHz were measured according to the methods defines in ANSI C63.4-2009. The EUT was placed, 0.8 meter above the ground plane, as shown in section 5.6.3. The interface cables and equipment positions were varied within limits of reasonable applications to determine the positions producing maximum radiated emissions For unintentional device, according to § 15.109(a), except for Class A digital devices, the field strength of radiated emissions from unintentional radiators at a distance of 3 meters shall not exceed the following values:

Frequency (MHz)	Distance Meters	Radiated ( $\mu V / M$ )	Radiated (dB $\mu V / M$ )
30-88	3	100	40.0
88-216	3	150	43.5
216-960	3	200	46.0
Above 960	3	500	54.0

For unintentional device, according to CISPR PUB.22, for Class B digital devices, the general requirement of field strength of radiated emissions from intentional radiators at a distance of 10 meters shall not exceed the above table.

Frequency (MHz)	Distance Meters	Radiated (dB $\mu V / M$ )
30-230	10	30
230-1000	10	37

### 5.2 Test Procedures

- The EUT was placed on a rotatable table top 0.8 meter above ground.
- The EUT was set 3 meters from the interference receiving antenna which was mounted on the top of a variable height antenna tower.
- The table was rotated 360 degrees to determine the position of the highest radiation.
- The antenna is a broadband antenna and its height is varied between one meter and four meters above ground to find the maximum value of the field strength both horizontal polarization and vertical polarization of the antenna are set to make the measurement.
- For each suspected emission the EUT was arranged to its worst case and then tune the antenna tower (from 1 M to 4 M) and turn table (from 0 degree to 360 degrees) to find the maximum reading.
- Set the test-receiver system to Peak or CISPR quasi-peak Detect Function and specified bandwidth with Maximum Hold Mode.
- If the emission level of the EUT in peak mode was 3 dB lower than the limit specified, then testing will be stopped and peak values of EUT will be reported, otherwise, the emissions which do not have 3 dB margin will be repeated one by one using the quasi-peak method and reported.
- For testing above 1GHz, the emission level of the EUT in peak mode was 20dB lower than average limit (that means the emission level in peak mode also complies with the limit in average mode), then testing will be stopped and peak values of EUT will be reported, otherwise, the emissions will be measured in average mode again and reported.



### 5.3 Typical Test Setup

For radiated emissions below 30MHz

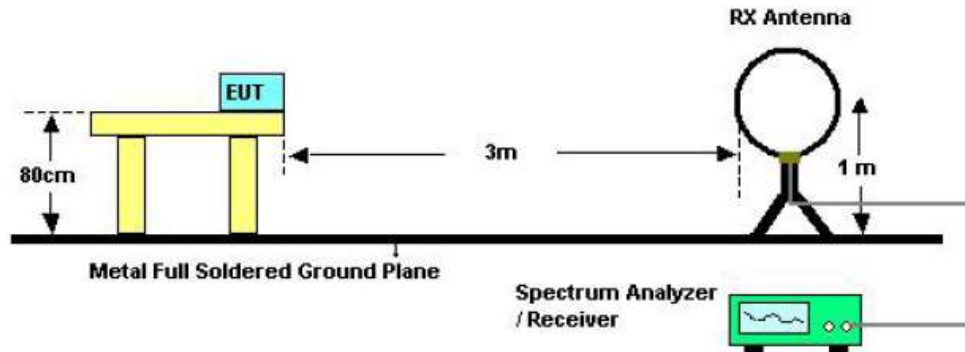

For radiated emissions above 30MHz

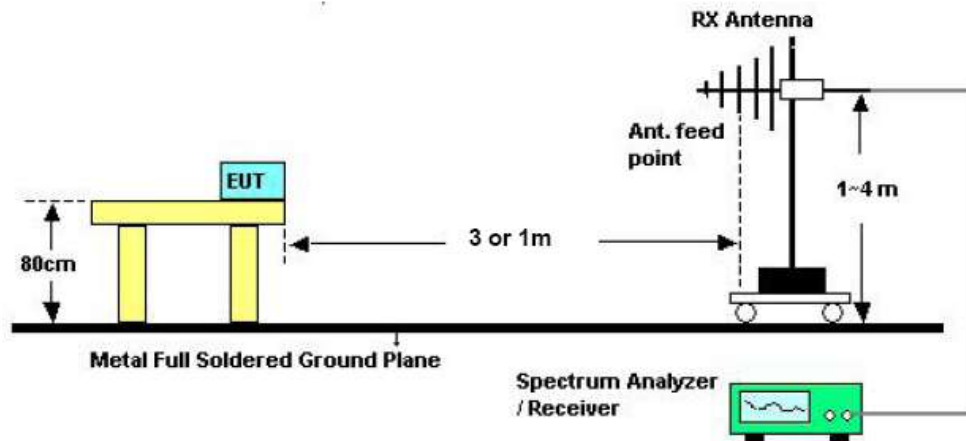

Above 10 GHz shall be extrapolated to the specified distance using an extrapolation factor of 20 dB/decade from 3m to 1m.

Distance extrapolation factor =  $20 \log (\text{specific distance [3m]} / \text{test distance [1m]})$  (dB);

Limit line = specific limits (dBuV) + distance extrapolation factor [9.54 dB].

### 5.4 Measurement equipment

Instrument/Ancillary	Manufacturer	Model No.	Serial No.	Calibration Date	Valid Date
Bilog Antenna	Schwarzbeck	VULB 9168	275	2013/10/01	2014/09/30
Amplifier	QuieTek	AP/0100A	CHM0906075	2013/09/30	2014/09/29
SPECTRUM ANALYZER	R&S	FSP40	100219	2013/09/14	2014/09/13
HORN ANTENNA	EMCO	3115	31601	2013/09/18	2014/09/17
PREAMPLIFIER	MITEQ	AMF-7D-00101800 -30-10P	1835099	2013/12/10	2014/12/09



### 5.5 Test Result and Data (9kHz ~ 30MHz)

The 9kHz-30MHz spurious emission is under limit 20dB more.

### 5.6 Test Result and Data (30MHz ~ 1GHz)

Power	: AC 120V	Pol/Phase	: VERTICAL
Test Mode	: Transmit	Temperature	: 25 °C
Operation Channel	: 0	Humidity	: 58 %
Modulation Type	: GFSK (1 Mbps)	Atmospheric Pressure	: 1020 hPa

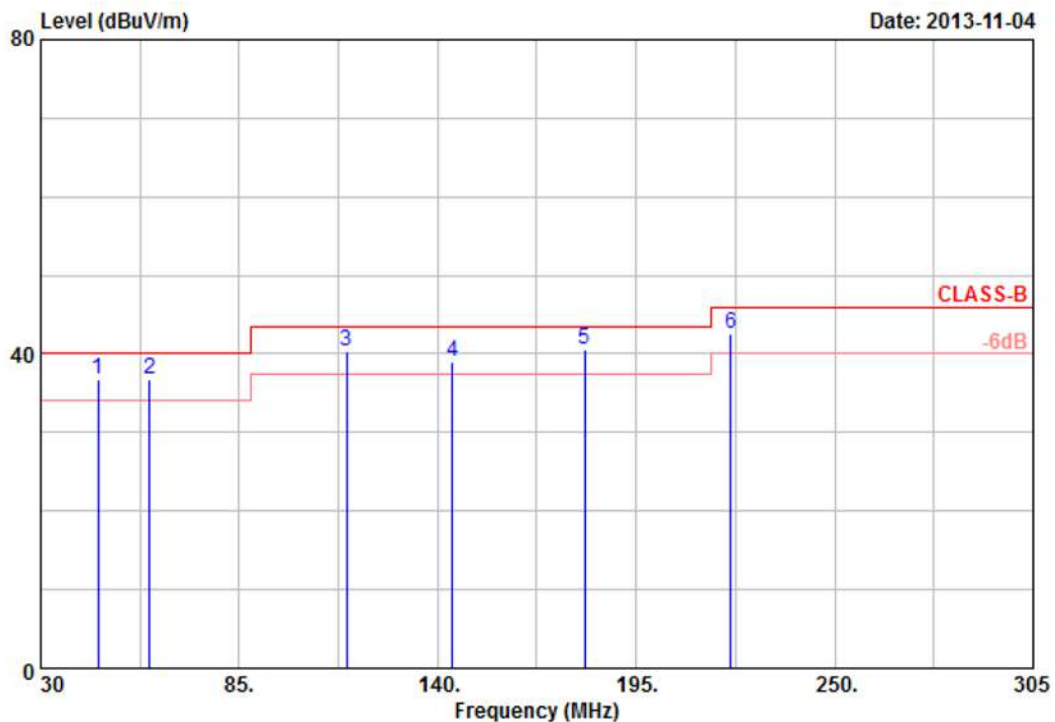

Item	Freq	Read Value	Factor	Result	Limit	Margin	Remark	Ant Pos	Tab Pos
	MHz	dBuV	dB/m	dBuV/m	dBuV/m	dB		cm	Deg
1	45.95	39.05	-2.20	36.85	40.00	-3.15	QP	100	360
2	60.25	47.55	-10.86	36.69	40.00	-3.31	QP	100	360
3	114.70	47.19	-6.87	40.32	43.50	-3.18	QP	100	360
4	144.13	47.83	-8.74	39.09	43.50	-4.41	QP	100	360
5	180.70	46.65	-6.16	40.49	43.50	-3.01	QP	100	360
6	221.13	48.81	-6.18	42.63	46.00	-3.37	QP	100	360

- Remarks:
1. Result = Read Value + Factor
  2. Factor = Antenna Factor + Cable Loss - Amplifier
  3. According to technical experiences, all spurious emission of BT mode at channel 0,39,78 are almost the same below 1GHz, so that the channel 0 was chosen as representative in final test.
  4. The data is worst case.



Power	: AC 120V	Pol/Phase	: VERTICAL
Test Mode	: Transmit	Temperature	: 25 °C
Operation Channel	: 0	Humidity	: 58 %
Modulation Type	: GFSK (1 Mbps)	Atmospheric Pressure	: 1020 hPa

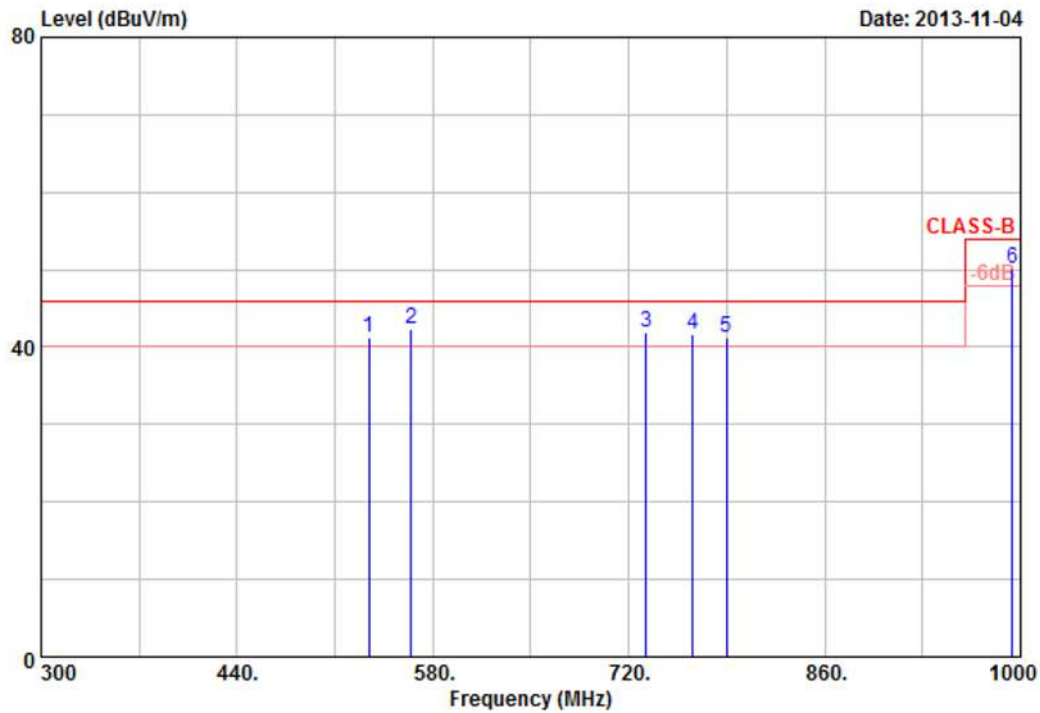

Item	Freq	Read Value	Factor	Result	Limit	Margin	Remark	Ant Pos	Tab Pos
	MHz	dBuV	dB/m	dBuV/m	dBuV/m	dB		cm	Deg
1	534.50	37.87	3.30	41.17	46.00	-4.83	QP	100	0
2	564.60	35.76	6.59	42.35	46.00	-3.65	QP	100	0
3	732.60	34.89	7.02	41.91	46.00	-4.09	QP	100	0
4	765.50	38.21	3.55	41.76	46.00	-4.24	QP	100	0
5	790.00	36.03	5.14	41.17	46.00	-4.83	QP	100	0
6	994.40	41.68	8.38	50.06	54.00	-3.94	QP	100	0

Remarks: 1. Result = Read Value + Factor  
 2. Factor = Antenna Factor + Cable Loss - Amplifier  
 3. According to technical experiences, all spurious emission of BT mode at channel 0,39,78 are almost the same below 1GHz, so that the channel 0 was chosen as representative in final test.  
 4. The data is worst case.





Power	: AC 120V	Pol/Phase	: HORIZONTAL
Test Mode	: Transmit	Temperature	: 25 °C
Operation Channel	: 0	Humidity	: 58 %
Modulation Type	: GFSK (1 Mbps)	Atmospheric Pressure	: 1020 hPa

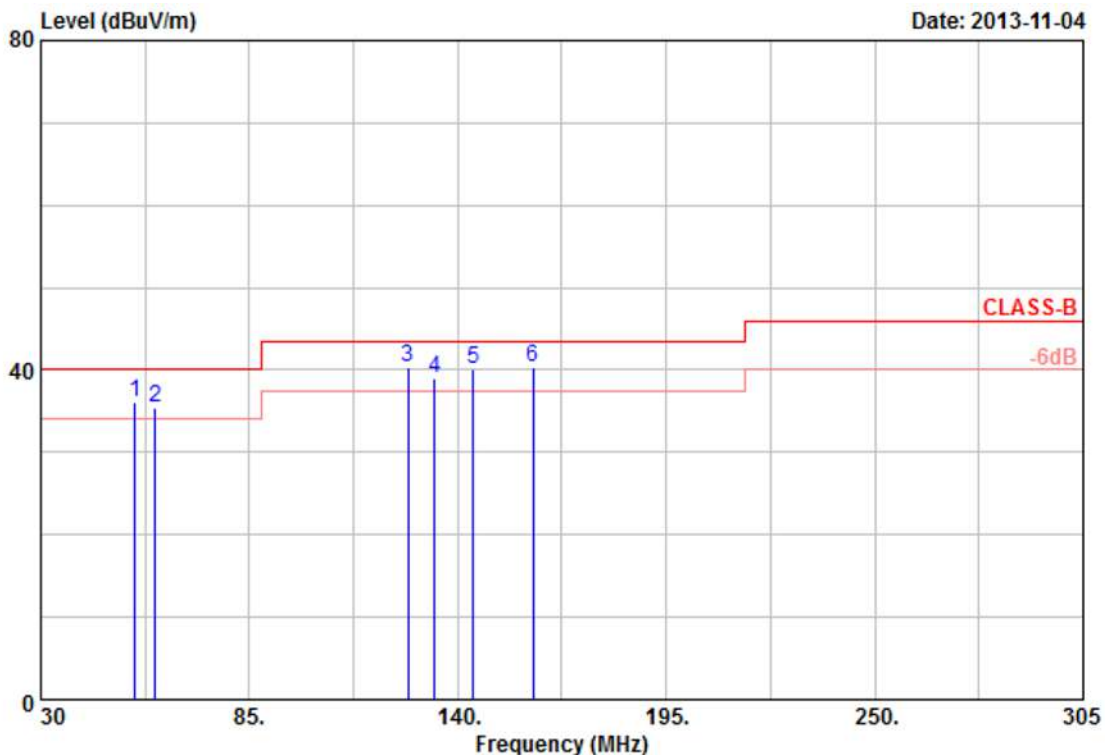

Item	Freq	Read Value	Factor	Result	Limit	Margin	Remark	Ant Pos	Tab Pos
	MHz	dBuV	dB/m	dBuV/m	dBuV/m	dB		cm	Deg
1	54.75	47.63	-11.60	36.03	40.00	-3.97	QP	100	360
2	60.25	52.80	-17.41	35.39	40.00	-4.61	QP	100	360
3	126.80	58.11	-17.78	40.33	43.50	-3.17	QP	100	360
4	133.95	54.22	-15.30	38.92	43.50	-4.58	QP	100	360
5	144.13	54.84	-14.64	40.20	43.50	-3.30	QP	100	360
6	159.80	57.80	-17.36	40.44	43.50	-3.06	QP	100	360

Remarks: 1. Result = Read Value + Factor  
 2. Factor = Antenna Factor + Cable Loss - Amplifier  
 3. According to technical experiences, all spurious emission of BT mode at channel 0,39,78 are almost the same below 1GHz, so that the channel 0 was chosen as representative in final test.  
 4. The data is worst case.



Power	: AC 120V	Pol/Phase	: HORIZONTAL
Test Mode	: Transmit	Temperature	: 25 °C
Operation Channel	: 0	Humidity	: 58 %
Modulation Type	: GFSK (1 Mbps)	Atmospheric Pressure	: 1020 hPa

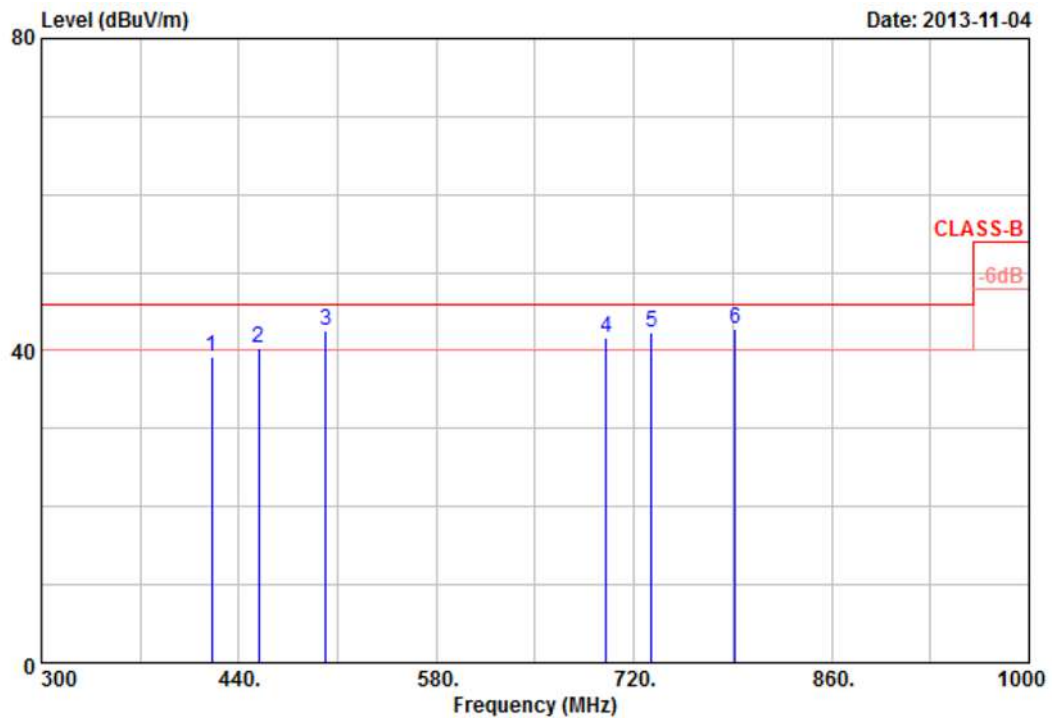

Item	Freq	Read Value	Factor	Result	Limit	Margin	Remark	Ant Pos	Tab Pos
	MHz	dBuV	dB/m	dBuV/m	dBuV/m	dB		cm	Deg
1	420.40	47.55	-8.38	39.17	46.00	-6.83	Peak	100	0
2	454.00	45.03	-4.67	40.36	46.00	-5.64	QP	100	0
3	501.60	42.52	0.10	42.62	46.00	-3.38	QP	100	0
4	700.40	39.47	2.19	41.66	46.00	-4.34	QP	100	0
5	732.60	38.44	3.98	42.42	46.00	-3.58	QP	100	0
6	791.40	37.63	5.22	42.85	46.00	-3.15	QP	100	0

Remarks: 1. Result = Read Value + Factor  
 2. Factor = Antenna Factor + Cable Loss - Amplifier  
 3. According to technical experiences, all spurious emission of BT mode at channel 0,39,78 are almost the same below 1GHz, so that the channel 0 was chosen as representative in final test.  
 4. The data is worst case.





Power	: AC 120V	Pol/Phase	: VERTICAL
Test Mode	: Transmit	Temperature	: 25 °C
Operation Channel	: 0	Humidity	: 58 %
Modulation Type	: $\pi/4$ -DQPSK (2 Mbps)	Atmospheric Pressure	: 1020 hPa

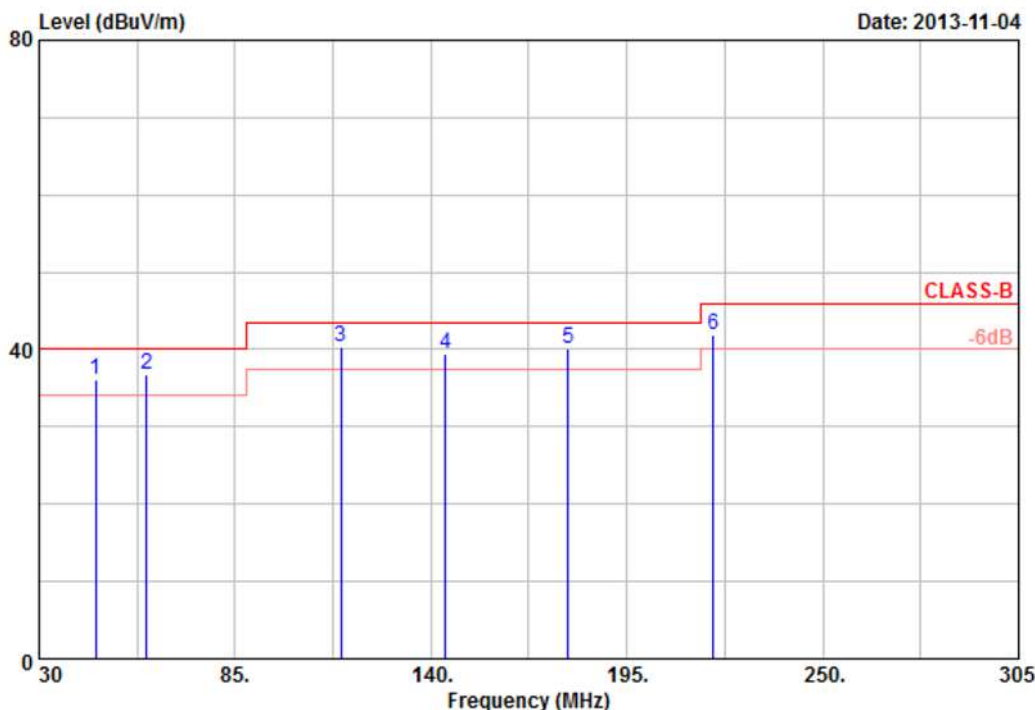

Item	Freq	Read Value	Factor	Result	Limit	Margin	Remark	Ant Pos	Tab Pos
	MHz	dBuV	dB/m	dBuV/m	dBuV/m	dB		cm	Deg
1	45.95	38.36	-2.20	36.16	40.00	-3.84	QP	100	360
2	60.25	47.64	-10.86	36.78	40.00	-3.22	QP	100	360
3	114.70	47.16	-6.87	40.29	43.50	-3.21	QP	100	360
4	144.13	48.23	-8.74	39.49	43.50	-4.01	QP	100	360
5	178.50	47.20	-7.14	40.06	43.50	-3.44	QP	100	360
6	219.20	47.92	-6.13	41.79	46.00	-4.21	QP	100	360

Remarks: 1. Result = Read Value + Factor  
 2. Factor = Antenna Factor + Cable Loss - Amplifier  
 3. According to technical experiences, all spurious emission of BT mode at channel 0,39,78 are almost the same below 1GHz, so that the channel 0 was chosen as representative in final test.  
 4. The data is worst case.



Power	: AC 120V	Pol/Phase	: VERTICAL
Test Mode	: Transmit	Temperature	: 25 °C
Operation Channel	: 0	Humidity	: 58 %
Modulation Type	: $\pi/4$ -DQPSK (2 Mbps)	Atmospheric Pressure	: 1020 hPa

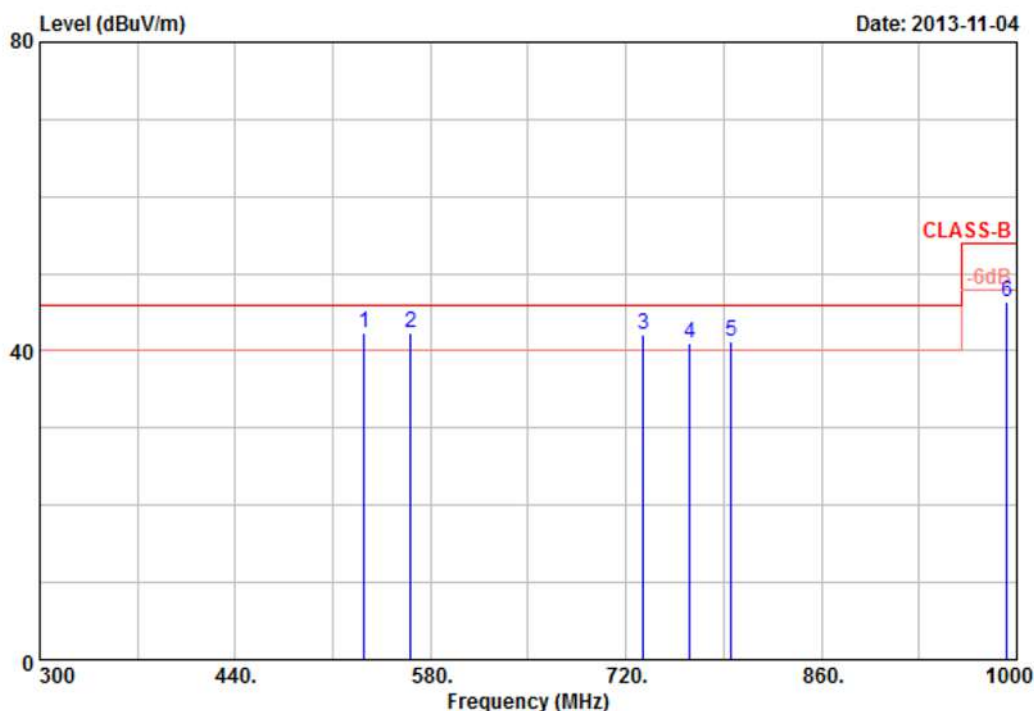

Item	Freq	Read Value	Factor	Result	Limit	Margin	Remark	Ant Pos	Tab Pos
	MHz	dBuV	dB/m	dBuV/m	dBuV/m	dB		cm	Deg
1	532.40	40.02	2.23	42.25	46.00	-3.75	QP	100	0
2	566.00	35.64	6.78	42.42	46.00	-3.58	QP	100	0
3	732.60	35.02	7.02	42.04	46.00	-3.96	QP	100	0
4	765.50	37.50	3.55	41.05	46.00	-4.95	QP	100	0
5	795.60	35.23	6.06	41.29	46.00	-4.71	QP	100	0
6	993.00	38.00	8.40	46.40	54.00	-7.60	Peak	100	0

Remarks: 1. Result = Read Value + Factor  
 2. Factor = Antenna Factor + Cable Loss - Amplifier  
 3. According to technical experiences, all spurious emission of BT mode at channel 0,39,78 are almost the same below 1GHz, so that the channel 0 was chosen as representative in final test.  
 4. The data is worst case.



Power	: AC 120V	Pol/Phase	: HORIZONTAL
Test Mode	: Transmit	Temperature	: 25 °C
Operation Channel	: 0	Humidity	: 58 %
Modulation Type	: $\pi/4$ -DQPSK (2 Mbps)	Atmospheric Pressure	: 1020 hPa

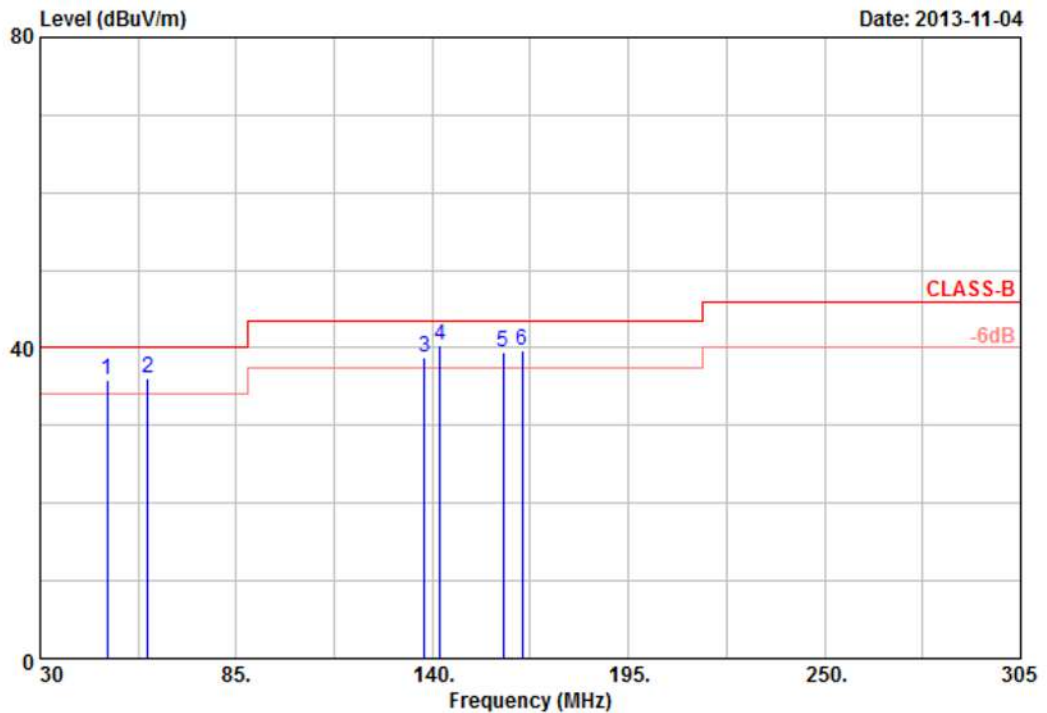

Item	Freq	Read Value	Factor	Result	Limit	Margin	Remark	Ant Pos	Tab Pos
	MHz	dBuV	dB/m	dBuV/m	dBuV/m	dB		cm	Deg
1	48.70	44.70	-8.83	35.87	40.00	-4.13	QP	100	360
2	60.25	53.53	-17.41	36.12	40.00	-3.88	QP	100	360
3	137.80	53.48	-14.67	38.81	43.50	-4.69	QP	100	360
4	142.20	55.10	-14.65	40.45	43.50	-3.05	QP	100	360
5	159.80	56.73	-17.36	39.37	43.50	-4.13	QP	100	360
6	165.30	55.76	-16.08	39.68	43.50	-3.82	QP	100	360

Remarks: 1. Result = Read Value + Factor  
 2. Factor = Antenna Factor + Cable Loss - Amplifier  
 3. According to technical experiences, all spurious emission of BT mode at channel 0, 39, 78 are almost the same below 1GHz, so that the channel 0 was chosen as representative in final test.  
 4. The data is worst case.



Power	: AC 120V	Pol/Phase	: HORIZONTAL
Test Mode	: Transmit	Temperature	: 25 °C
Operation Channel	: 0	Humidity	: 58 %
Modulation Type	: $\pi/4$ -DQPSK (2 Mbps)	Atmospheric Pressure	: 1020 hPa

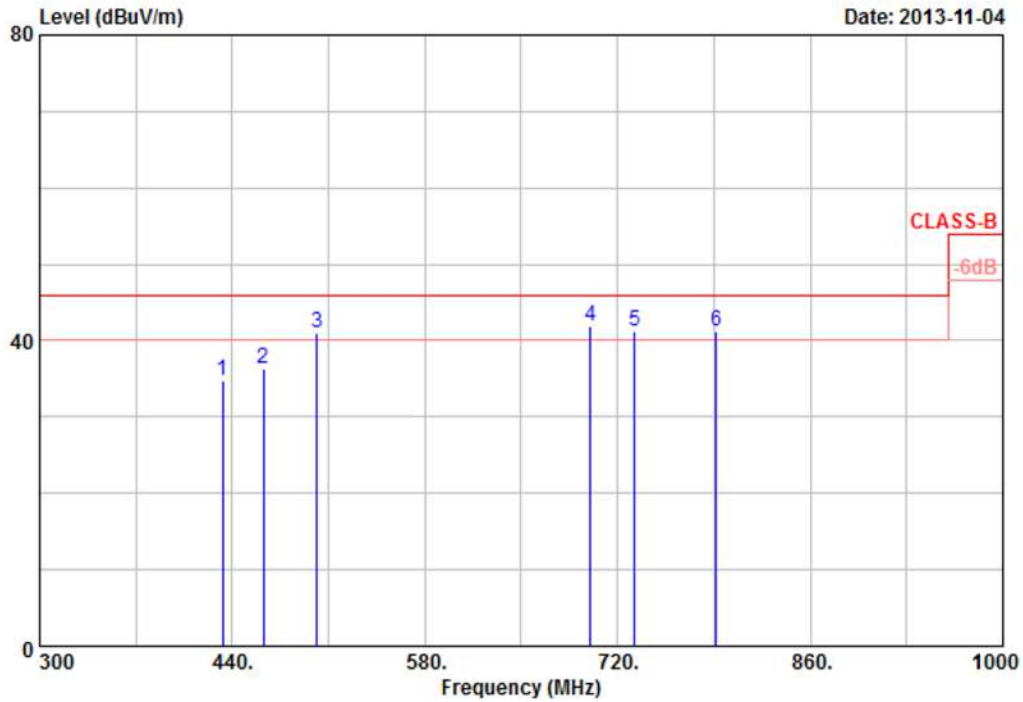

Item	Freq	Read Value	Factor	Result	Limit	Margin	Remark	Ant Pos	Tab Pos
	MHz	dBuV	dB/m	dBuV/m	dBuV/m	dB		cm	Deg
1	433.00	41.76	-6.94	34.82	46.00	-11.18	Peak	100	0
2	462.40	41.47	-5.06	36.41	46.00	-9.59	Peak	100	0
3	501.60	40.99	0.10	41.09	46.00	-4.91	QP	100	0
4	700.40	39.77	2.19	41.96	46.00	-4.04	QP	100	0
5	732.60	37.25	3.98	41.23	46.00	-4.77	QP	100	0
6	791.40	35.89	5.22	41.11	46.00	-4.89	QP	100	0

Remarks: 1. Result = Read Value + Factor  
 2. Factor = Antenna Factor + Cable Loss - Amplifier  
 3. According to technical experiences, all spurious emission of BT mode at channel 0,39,78 are almost the same below 1GHz, so that the channel 0 was chosen as representative in final test.  
 4. The data is worst case.



Power	: AC 120V	Pol/Phase	: VERTICAL
Test Mode	: Transmit	Temperature	: 25 °C
Operation Channel	: 0	Humidity	: 58 %
Modulation Type	: 8DPSK (3 Mbps)	Atmospheric Pressure	: 1020 hPa

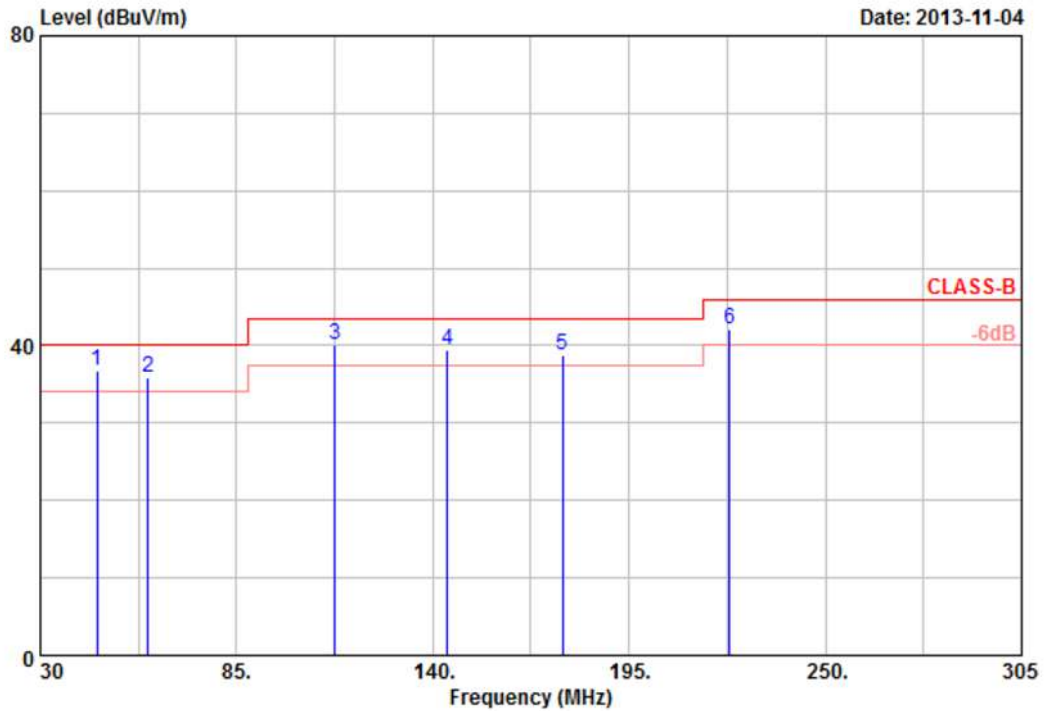

Item	Freq	Read Value	Factor	Result	Limit	Margin	Remark	Ant Pos	Tab Pos
	MHz	dBuV	dB/m	dBuV/m	dBuV/m	dB		cm	Deg
1	45.95	38.91	-2.20	36.71	40.00	-3.29	QP	100	360
2	60.25	46.83	-10.86	35.97	40.00	-4.03	QP	100	360
3	112.50	47.02	-6.99	40.03	43.50	-3.47	QP	100	360
4	144.13	48.14	-8.74	39.40	43.50	-4.10	QP	100	360
5	176.30	49.21	-10.48	38.73	43.50	-4.77	QP	100	360
6	223.05	48.63	-6.49	42.14	46.00	-3.86	QP	100	360

Remarks: 1. Result = Read Value + Factor  
 2. Factor = Antenna Factor + Cable Loss - Amplifier  
 3. According to technical experiences, all spurious emission of BT mode at channel 0,39,78 are almost the same below 1GHz, so that the channel 0 was chosen as representative in final test.  
 4. The data is worst case.





Power	: AC 120V	Pol/Phase	: VERTICAL
Test Mode	: Transmit	Temperature	: 25 °C
Operation Channel	: 0	Humidity	: 58 %
Modulation Type	: 8DPSK (3 Mbps)	Atmospheric Pressure	: 1020 hPa

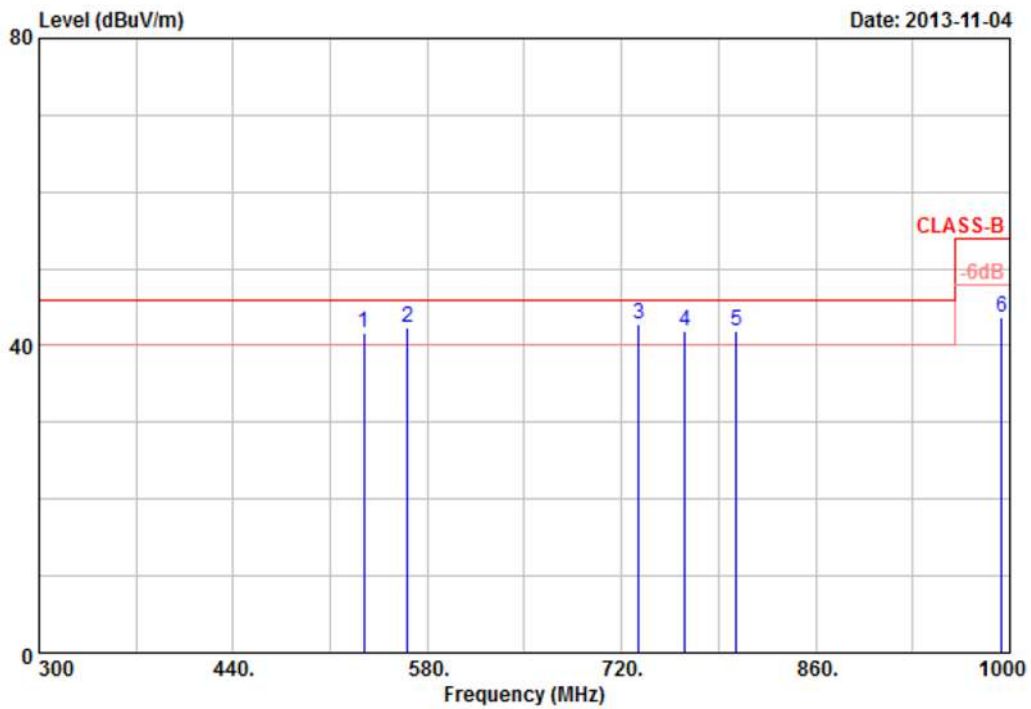

Item	Freq	Read Value	Factor	Result	Limit	Margin	Remark	Ant Pos	Tab Pos
	MHz	dBuV	dB/m	dBuV/m	dBuV/m	dB		cm	Deg
1	534.50	38.46	3.30	41.76	46.00	-4.24	QP	100	0
2	566.00	35.46	6.78	42.24	46.00	-3.76	QP	100	0
3	732.60	35.86	7.02	42.88	46.00	-3.12	QP	100	0
4	765.50	38.24	3.55	41.79	46.00	-4.21	QP	100	0
5	802.60	36.96	5.03	41.99	46.00	-4.01	QP	100	0
6	994.40	35.30	8.38	43.68	54.00	-10.32	Peak	100	0

Remarks: 1. Result = Read Value + Factor  
 2. Factor = Antenna Factor + Cable Loss - Amplifier  
 3. According to technical experiences, all spurious emission of BT mode at channel 0,39,78 are almost the same below 1GHz, so that the channel 0 was chosen as representative in final test.  
 4. The data is worst case.



Power	: AC 120V	Pol/Phase	: HORIZONTAL
Test Mode	: Transmit	Temperature	: 25 °C
Operation Channel	: 0	Humidity	: 58 %
Modulation Type	: 8DPSK (3 Mbps)	Atmospheric Pressure	: 1020 hPa

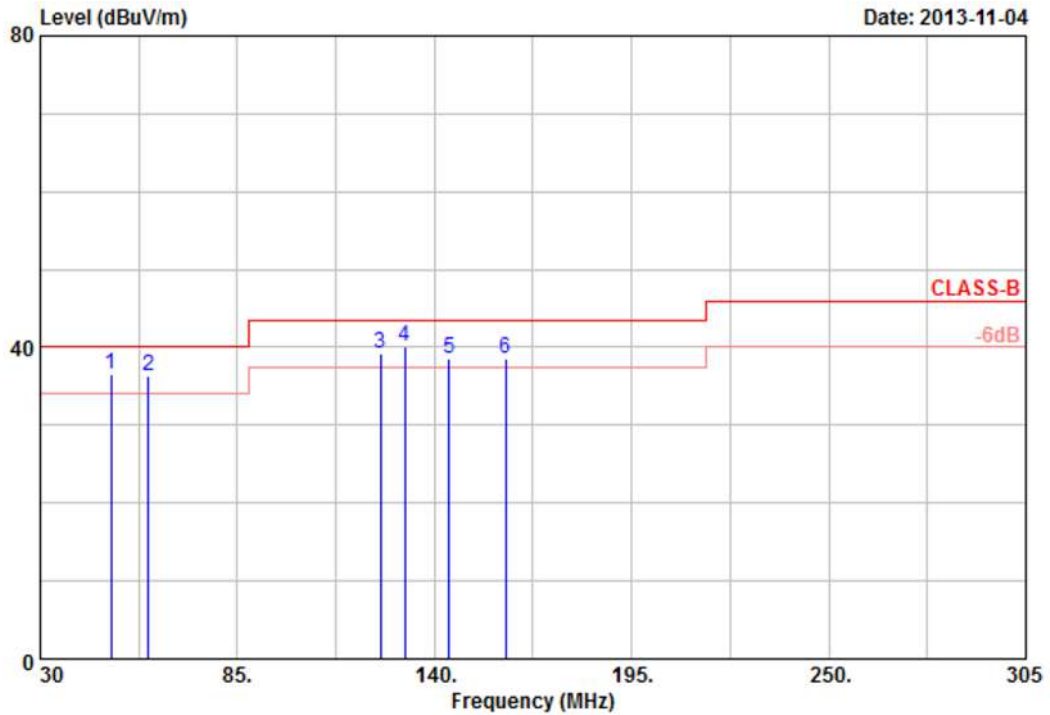

Item	Freq	Read Value	Factor	Result	Limit	Margin	Remark	Ant Pos	Tab Pos
	MHz	dBuV	dB/m	dBuV/m	dBuV/m	dB		cm	Deg
1	49.80	45.61	-9.01	36.60	40.00	-3.40	QP	100	360
2	60.25	53.64	-17.41	36.23	40.00	-3.77	QP	100	360
3	124.88	57.15	-17.86	39.29	43.50	-4.21	QP	100	360
4	131.75	56.76	-16.61	40.15	43.50	-3.35	QP	100	360
5	144.13	53.14	-14.64	38.50	43.50	-5.00	QP	100	360
6	159.80	55.98	-17.36	38.62	43.50	-4.88	QP	100	360

Remarks: 1. Result = Read Value + Factor  
 2. Factor = Antenna Factor + Cable Loss - Amplifier  
 3. According to technical experiences, all spurious emission of BT mode at channel 0,39,78 are almost the same below 1GHz, so that the channel 0 was chosen as representative in final test.  
 4. The data is worst case.



Power	: AC 120V	Pol/Phase	: HORIZONTAL
Test Mode	: Transmit	Temperature	: 25 °C
Operation Channel	: 0	Humidity	: 58 %
Modulation Type	: 8DPSK (3 Mbps)	Atmospheric Pressure	: 1020 hPa

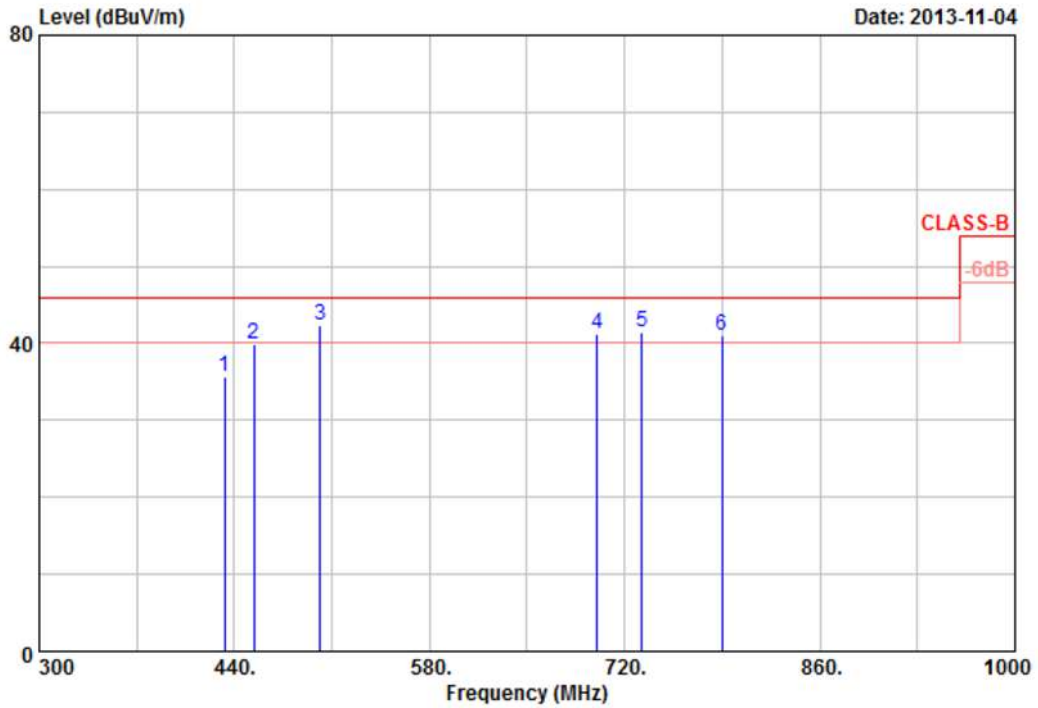

Item	Freq	Read Value	Factor	Result	Limit	Margin	Remark	Ant Pos	Tab Pos
	MHz	dBuV	dB/m	dBuV/m	dBuV/m	dB		cm	Deg
1	433.00	42.55	-6.94	35.61	46.00	-10.39	Peak	100	0
2	454.00	44.58	-4.67	39.91	46.00	-6.09	Peak	100	0
3	501.60	42.33	0.10	42.43	46.00	-3.57	QP	100	0
4	700.40	38.98	2.19	41.17	46.00	-4.83	QP	100	0
5	732.60	37.49	3.98	41.47	46.00	-4.53	QP	100	0
6	790.00	36.11	4.98	41.09	46.00	-4.91	QP	100	0

Remarks: 1. Result = Read Value + Factor  
 2. Factor = Antenna Factor + Cable Loss - Amplifier  
 3. According to technical experiences, all spurious emission of BT mode at channel 0,39,78 are almost the same below 1GHz, so that the channel 0 was chosen as representative in final test.  
 4. The data is worst case.





5.7 Test Result and Data (1GHz ~ 25GHz)

Power	: AC 120V	Pol/Phase	: VERTICAL
Test Mode	: Transmit	Temperature	: 25 °C
Operation Channel	: 0	Humidity	: 58 %
Modulation Type	: GFSK (1Mbps)	Atmospheric Pressure	: 1020 hPa

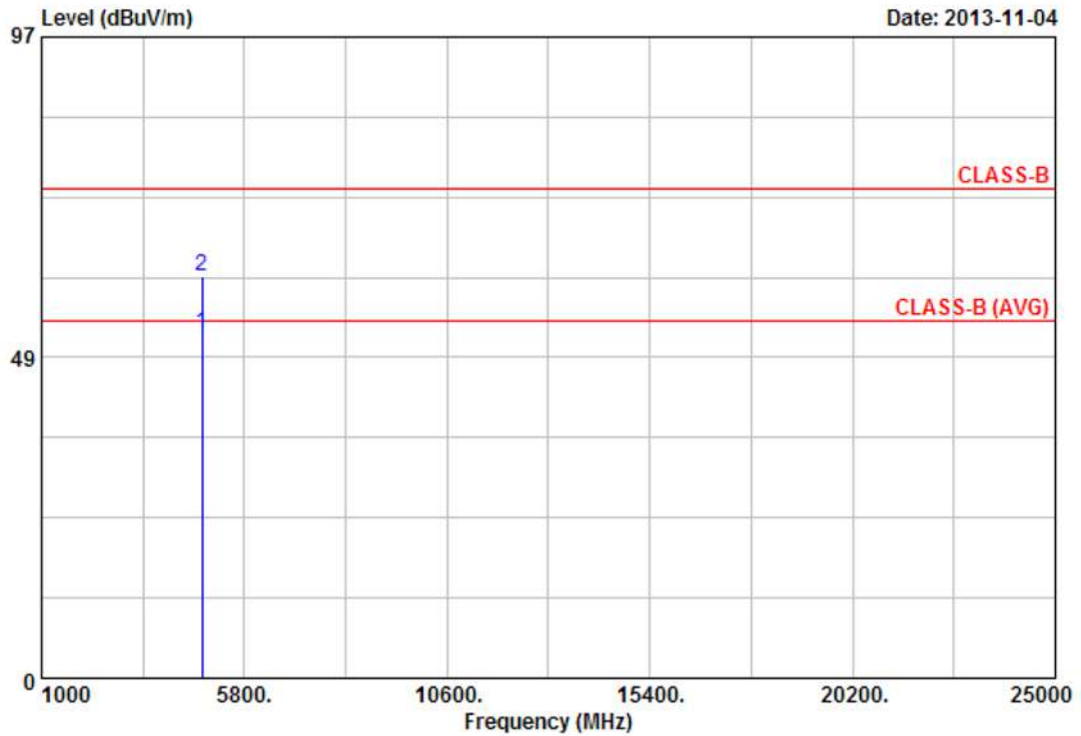

Item	Freq	Read Value	Factor	Result	Limit	Margin	Remark	Ant Pos	Tab Pos
	MHz	dBuV	dB/m	dBuV/m	dBuV/m	dB		cm	Deg
1	4803.97	41.70	10.34	52.04	54.00	-1.96	Average	100	158
2	4804.36	50.40	10.34	60.74	74.00	-13.26	Peak	100	158

Notes:

1. Result = Read Value + Factor
2. Factor = Antenna Factor + Cable Loss - Amplifier
3. The resolution bandwidth of test receiver/spectrum analyzer is 120KHz and video bandwidth is 300kHz for Peak detection and Quasi-peak detection at frequency below 1GHz.
4. The resolution bandwidth of test receiver/spectrum analyzer is 1MHz and video bandwidth is 3MHz for Peak detection at frequency above 1GHz.
5. The resolution bandwidth of test receiver/spectrum analyzer is 1MHz and video bandwidth is 10Hz for Average detection at frequency above 1GHz.
6. The other emissions is too low to be measured.
7. The data is worse case.



Power	: AC 120V	Pol/Phase	: HORIZONTAL
Test Mode	: Transmit	Temperature	: 25 °C
Operation Channel	: 0	Humidity	: 58 %
Modulation Type	: GFSK (1Mbps)	Atmospheric Pressure	: 1020 hPa

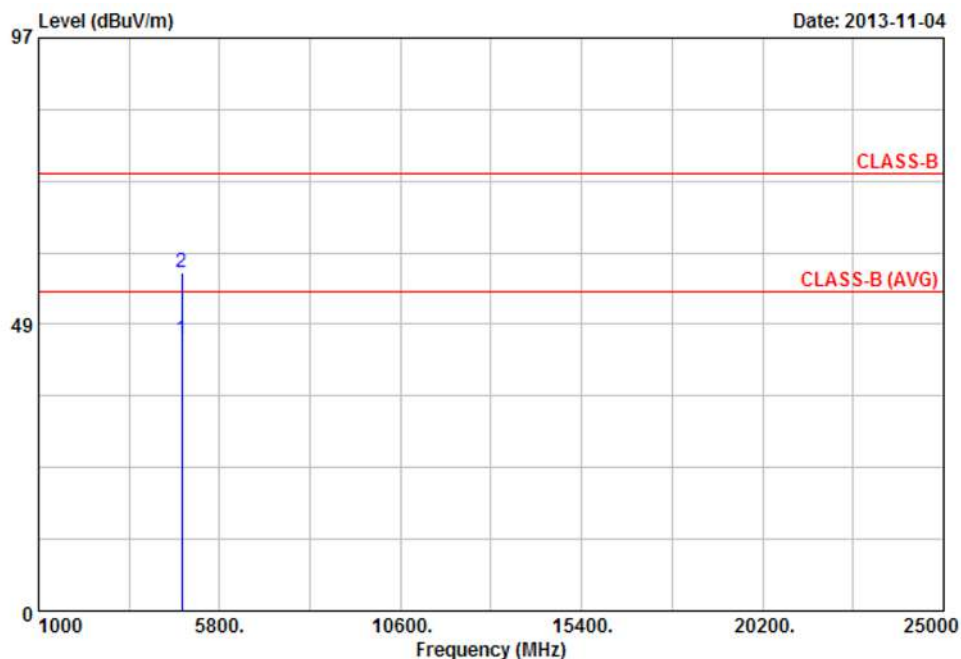

Item	Freq	Read Value	Factor	Result	Limit	Margin	Remark	Ant Pos	Tab Pos
	MHz	dBuV	dB/m	dBuV/m	dBuV/m	dB		cm	Deg
1	4804.05	36.60	9.32	45.92	54.00	-8.08	Average	100	180
2	4804.22	47.96	9.32	57.28	74.00	-16.72	Peak	100	180

Notes:

1. Result = Read Value + Factor
2. Factor = Antenna Factor + Cable Loss - Amplifier
3. The resolution bandwidth of test receiver/spectrum analyzer is 120KHz and video bandwidth is 300kHz for Peak detection and Quasi-peak detection at frequency below 1GHz.
4. The resolution bandwidth of test receiver/spectrum analyzer is 1MHz and video bandwidth is 3MHz for Peak detection at frequency above 1GHz.
5. The resolution bandwidth of test receiver/spectrum analyzer is 1MHz and video bandwidth is 10Hz for Average detection at frequency above 1GHz.
6. The other emissions is too low to be measured.
7. The data is worse case.



Power	: AC 120V	Pol/Phase	: VERTICAL
Test Mode	: Transmit	Temperature	: 25 °C
Operation Channel	: 39	Humidity	: 58 %
Modulation Type	: GFSK (1Mbps)	Atmospheric Pressure	: 1020 hPa

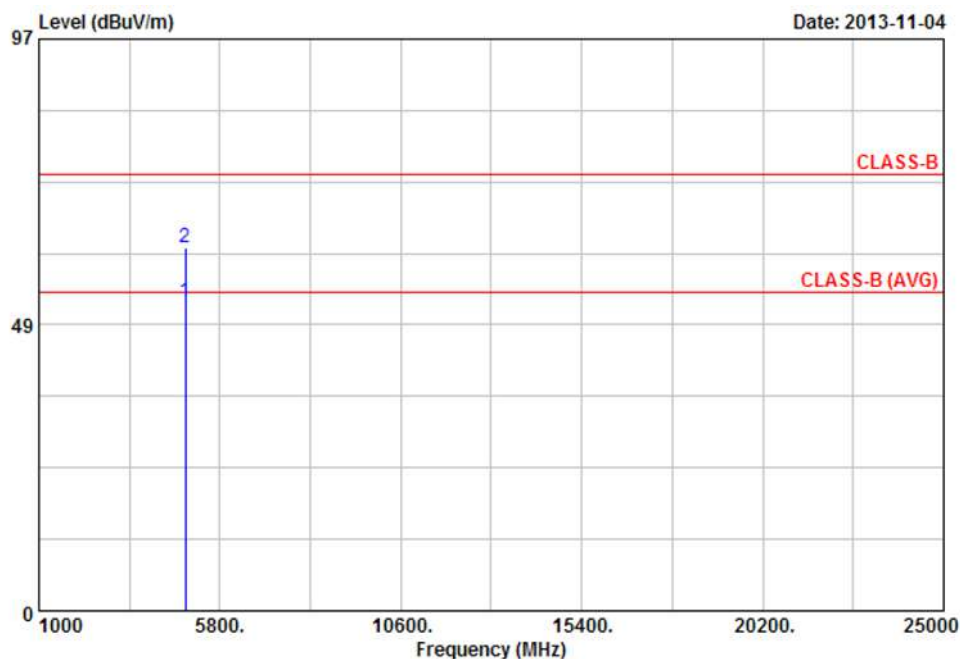

Item	Freq	Read Value	Factor	Result	Limit	Margin	Remark	Ant Pos	Tab Pos
	MHz	dBuV	dB/m	dBuV/m	dBuV/m	dB		cm	Deg
1	4882.03	41.84	10.67	52.51	54.00	-1.49	Average	100	162
2	4882.48	51.06	10.67	61.73	74.00	-12.27	Peak	100	162

Notes:

1. Result = Read Value + Factor
2. Factor = Antenna Factor + Cable Loss - Amplifier
3. The resolution bandwidth of test receiver/spectrum analyzer is 120KHz and video bandwidth is 300kHz for Peak detection and Quasi-peak detection at frequency below 1GHz.
4. The resolution bandwidth of test receiver/spectrum analyzer is 1MHz and video bandwidth is 3MHz for Peak detection at frequency above 1GHz.
5. The resolution bandwidth of test receiver/spectrum analyzer is 1MHz and video bandwidth is 10Hz for Average detection at frequency above 1GHz.
6. The other emissions is too low to be measured.
7. The data is worse case.



Power	: AC 120V	Pol/Phase	: HORIZONTAL
Test Mode	: Transmit	Temperature	: 25 °C
Operation Channel	: 39	Humidity	: 58 %
Modulation Type	: GFSK (1Mbps)	Atmospheric Pressure	: 1020 hPa

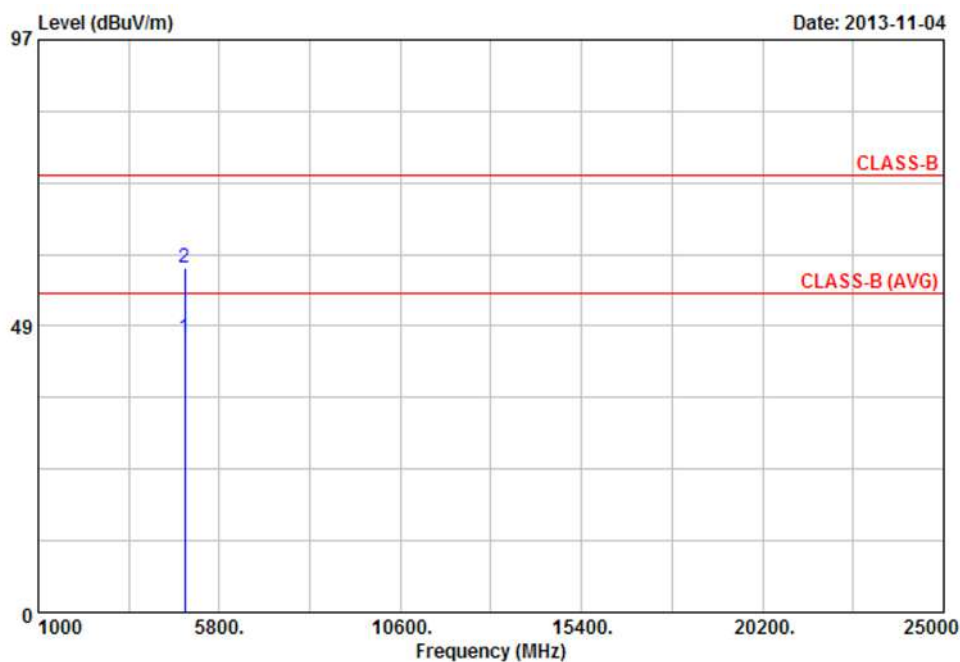

Item	Freq	Read Value	Factor	Result	Limit	Margin	Remark	Ant Pos	Tab Pos
	MHz	dBuV	dB/m	dBuV/m	dBuV/m	dB		cm	Deg
1	4881.93	35.71	10.69	46.40	54.00	-7.60	Average	100	211
2	4882.22	47.60	10.70	58.30	74.00	-15.70	Peak	100	211

Notes:

1. Result = Read Value + Factor
2. Factor = Antenna Factor + Cable Loss - Amplifier
3. The resolution bandwidth of test receiver/spectrum analyzer is 120KHz and video bandwidth is 300kHz for Peak detection and Quasi-peak detection at frequency below 1GHz.
4. The resolution bandwidth of test receiver/spectrum analyzer is 1MHz and video bandwidth is 3MHz for Peak detection at frequency above 1GHz.
5. The resolution bandwidth of test receiver/spectrum analyzer is 1MHz and video bandwidth is 10Hz for Average detection at frequency above 1GHz.
6. The other emissions is too low to be measured.
7. The data is worse case.



Power	: AC 120V	Pol/Phase	: VERTICAL
Test Mode	: Transmit	Temperature	: 25 °C
Operation Channel	: 78	Humidity	: 58 %
Modulation Type	: GFSK (1Mbps)	Atmospheric Pressure	: 1020 hPa

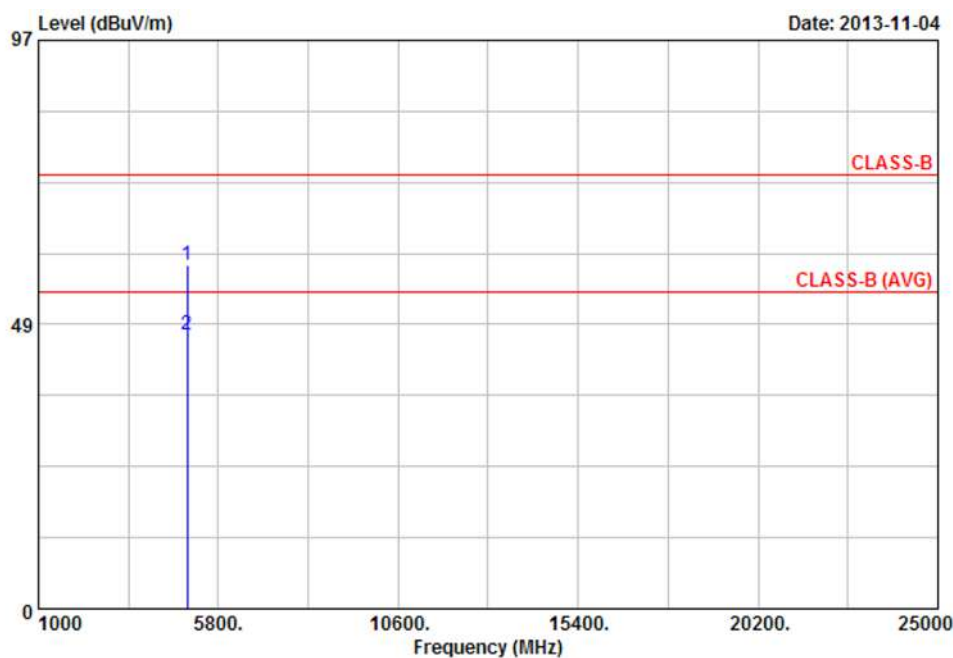

Item	Freq	Read Value	Factor	Result	Limit	Margin	Remark	Ant Pos	Tab Pos
	MHz	dBuV	dB/m	dBuV/m	dBuV/m	dB		cm	Deg
1	4959.84	47.04	11.61	58.65	74.00	-15.35	Peak	100	182
2	4960.03	35.15	11.61	46.76	54.00	-7.24	Average	100	182

Notes:

1. Result = Read Value + Factor
2. Factor = Antenna Factor + Cable Loss - Amplifier
3. The resolution bandwidth of test receiver/spectrum analyzer is 120KHz and video bandwidth is 300kHz for Peak detection and Quasi-peak detection at frequency below 1GHz.
4. The resolution bandwidth of test receiver/spectrum analyzer is 1MHz and video bandwidth is 3MHz for Peak detection at frequency above 1GHz.
5. The resolution bandwidth of test receiver/spectrum analyzer is 1MHz and video bandwidth is 10Hz for Average detection at frequency above 1GHz.
6. The other emissions is too low to be measured.
7. The data is worse case.





Power	: AC 120V	Pol/Phase	: HORIZONTAL
Test Mode	: Transmit	Temperature	: 25 °C
Operation Channel	: 78	Humidity	: 58 %
Modulation Type	: GFSK (1Mbps)	Atmospheric Pressure	: 1020 hPa

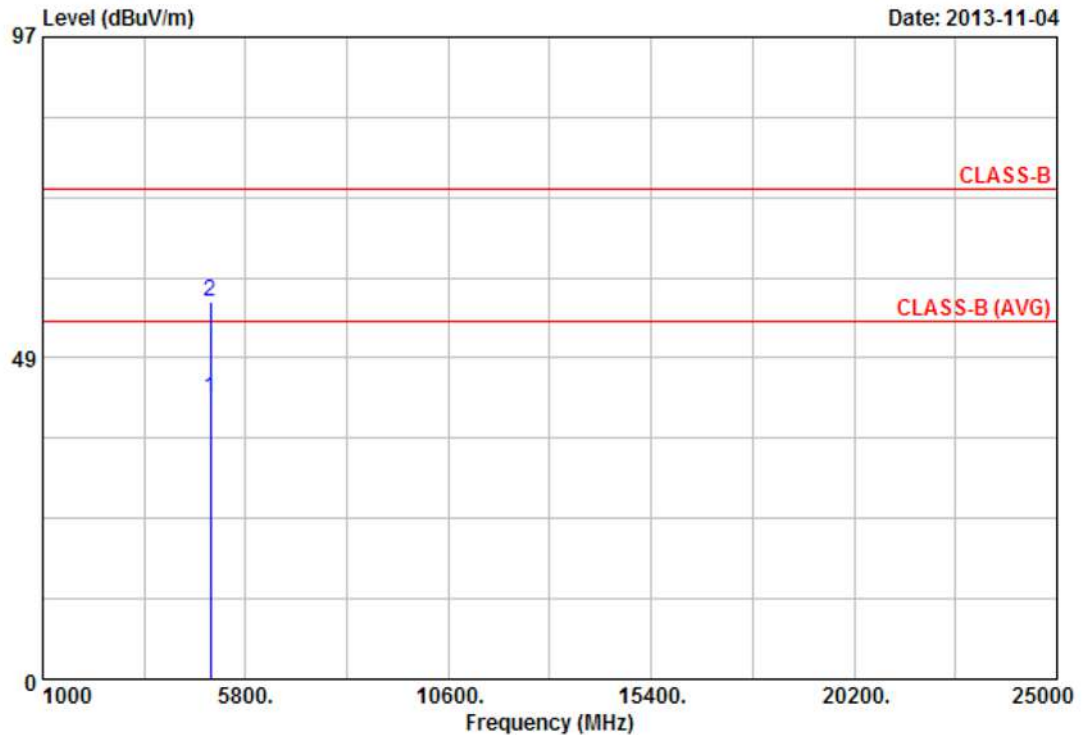

Item	Freq	Read Value	Factor	Result	Limit	Margin	Remark	Ant Pos	Tab Pos
	MHz	dBuV	dB/m	dBuV/m	dBuV/m	dB		cm	Deg
1	4959.97	31.74	10.75	42.49	54.00	-11.51	Average	100	212
2	4961.10	46.16	10.74	56.90	74.00	-17.10	Peak	100	212

Notes:

1. Result = Read Value + Factor
2. Factor = Antenna Factor + Cable Loss - Amplifier
3. The resolution bandwidth of test receiver/spectrum analyzer is 120KHz and video bandwidth is 300kHz for Peak detection and Quasi-peak detection at frequency below 1GHz.
4. The resolution bandwidth of test receiver/spectrum analyzer is 1MHz and video bandwidth is 3MHz for Peak detection at frequency above 1GHz.
5. The resolution bandwidth of test receiver/spectrum analyzer is 1MHz and video bandwidth is 10Hz for Average detection at frequency above 1GHz.
6. The other emissions is too low to be measured.
7. The data is worse case.



Power	: AC 120V	Pol/Phase	: VERTICAL
Test Mode	: Transmit	Temperature	: 25 °C
Operation Channel	: 0	Humidity	: 58 %
Modulation Type	: $\pi/4$ -DQPSK (2 Mbps)	Atmospheric Pressure	: 1020 hPa

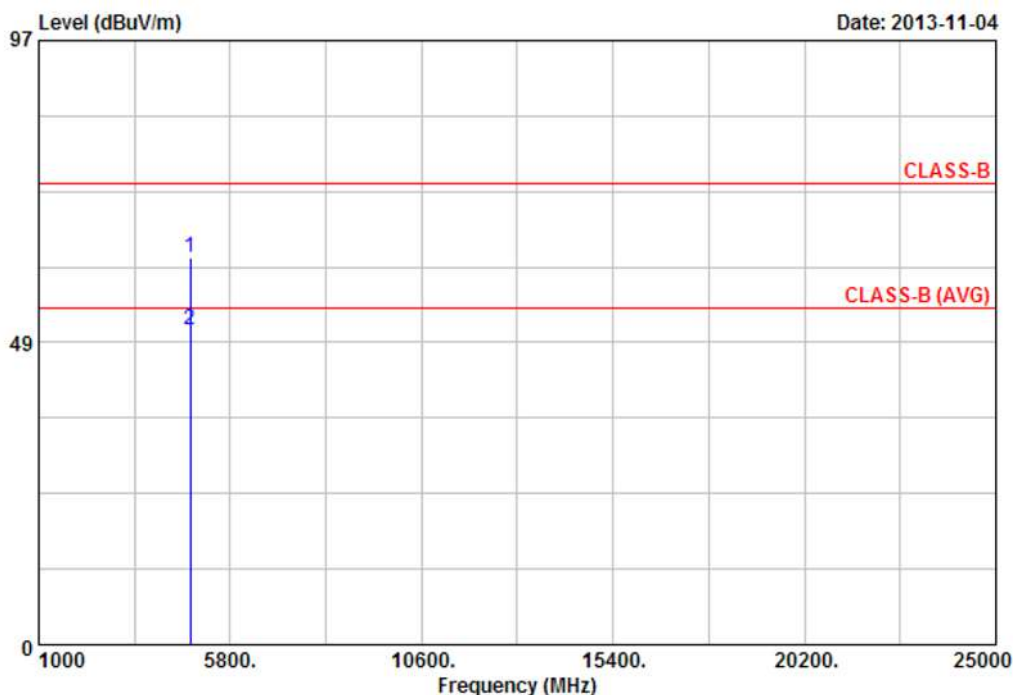

Item	Freq	Read Value	Factor	Result	Limit	Margin	Remark	Ant Pos	Tab Pos
	MHz	dBuV	dB/m	dBuV/m	dBuV/m	dB		cm	Deg
1	4803.84	51.85	10.34	62.19	74.00	-11.81	Peak	100	170
2	4804.03	40.14	10.34	50.48	54.00	-3.52	Average	100	170

Notes:

1. Result = Read Value + Factor
2. Factor = Antenna Factor + Cable Loss - Amplifier
3. The resolution bandwidth of test receiver/spectrum analyzer is 120KHz and video bandwidth is 300KHz for Peak detection and Quasi-peak detection at frequency below 1GHz.
4. The resolution bandwidth of test receiver/spectrum analyzer is 1MHz and video bandwidth is 3MHz for Peak detection at frequency above 1GHz.
5. The resolution bandwidth of test receiver/spectrum analyzer is 1MHz and video bandwidth is 10Hz for Average detection at frequency above 1GHz.
6. The other emissions is too low to be measured.
7. The data is worse case.



Power	: AC 120V	Pol/Phase	: HORIZONTAL
Test Mode	: Transmit	Temperature	: 25 °C
Operation Channel	: 0	Humidity	: 58 %
Modulation Type	: $\pi/4$ -DQPSK (2 Mbps)	Atmospheric Pressure	: 1020 hPa

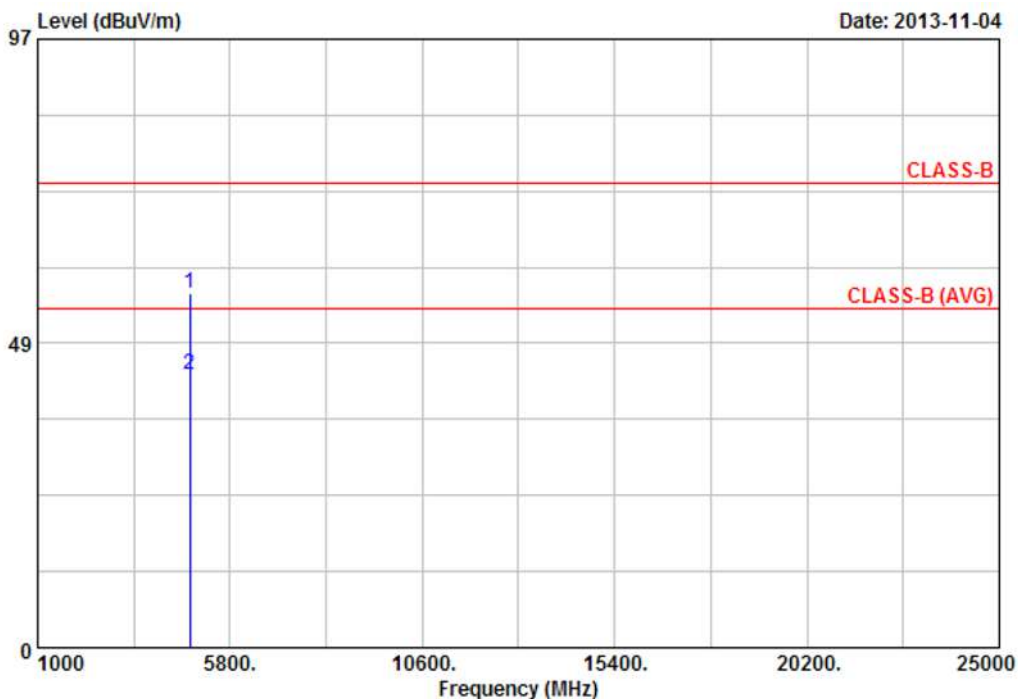

Item	Freq	Read Value	Factor	Result	Limit	Margin	Remark	Ant Pos	Tab Pos
	MHz	dBuV	dB/m	dBuV/m	dBuV/m	dB		cm	Deg
1	4803.54	47.20	9.31	56.51	74.00	-17.49	Peak	100	179
2	4804.07	34.23	9.32	43.55	54.00	-10.45	Average	100	179

Notes:

1. Result = Read Value + Factor
2. Factor = Antenna Factor + Cable Loss - Amplifier
3. The resolution bandwidth of test receiver/spectrum analyzer is 120KHz and video bandwidth is 300kHz for Peak detection and Quasi-peak detection at frequency below 1GHz.
4. The resolution bandwidth of test receiver/spectrum analyzer is 1MHz and video bandwidth is 3MHz for Peak detection at frequency above 1GHz.
5. The resolution bandwidth of test receiver/spectrum analyzer is 1MHz and video bandwidth is 10Hz for Average detection at frequency above 1GHz.
6. The other emissions is too low to be measured.
7. The data is worse case.





Power	: AC 120V	Pol/Phase	: VERTICAL
Test Mode	: Transmit	Temperature	: 25 °C
Operation Channel	: 39	Humidity	: 58 %
Modulation Type	: $\pi/4$ -DQPSK (2 Mbps)	Atmospheric Pressure	: 1020 hPa

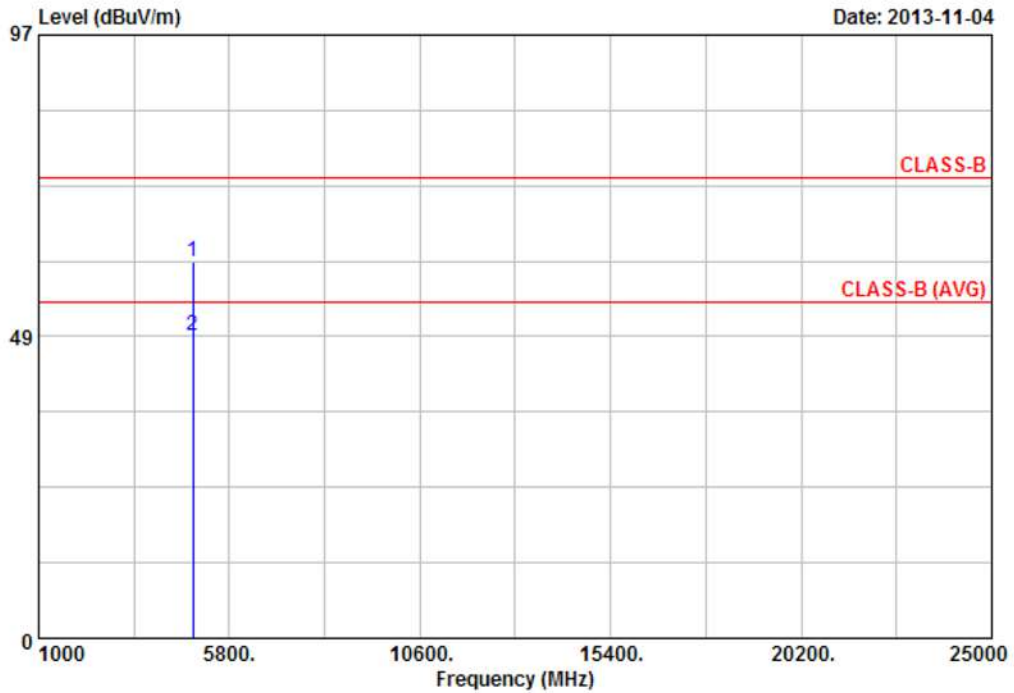

Item	Freq	Read Value	Factor	Result	Limit	Margin	Remark	Ant Pos	Tab Pos
	MHz	dBuV	dB/m	dBuV/m	dBuV/m	dB		cm	Deg
1	4881.84	49.90	10.67	60.57	74.00	-13.43	Peak	100	172
2	4882.01	37.99	10.67	48.66	54.00	-5.34	Average	100	172

Notes:

1. Result = Read Value + Factor
2. Factor = Antenna Factor + Cable Loss - Amplifier
3. The resolution bandwidth of test receiver/spectrum analyzer is 120KHz and video bandwidth is 300kHz for Peak detection and Quasi-peak detection at frequency below 1GHz.
4. The resolution bandwidth of test receiver/spectrum analyzer is 1MHz and video bandwidth is 3MHz for Peak detection at frequency above 1GHz.
5. The resolution bandwidth of test receiver/spectrum analyzer is 1MHz and video bandwidth is 10Hz for Average detection at frequency above 1GHz.
6. The other emissions is too low to be measured.
7. The data is worse case.



Power	: AC 120V	Pol/Phase	: HORIZONTAL
Test Mode	: Transmit	Temperature	: 25 °C
Operation Channel	: 39	Humidity	: 58 %
Modulation Type	: $\pi/4$ -DQPSK (2 Mbps)	Atmospheric Pressure	: 1020 hPa

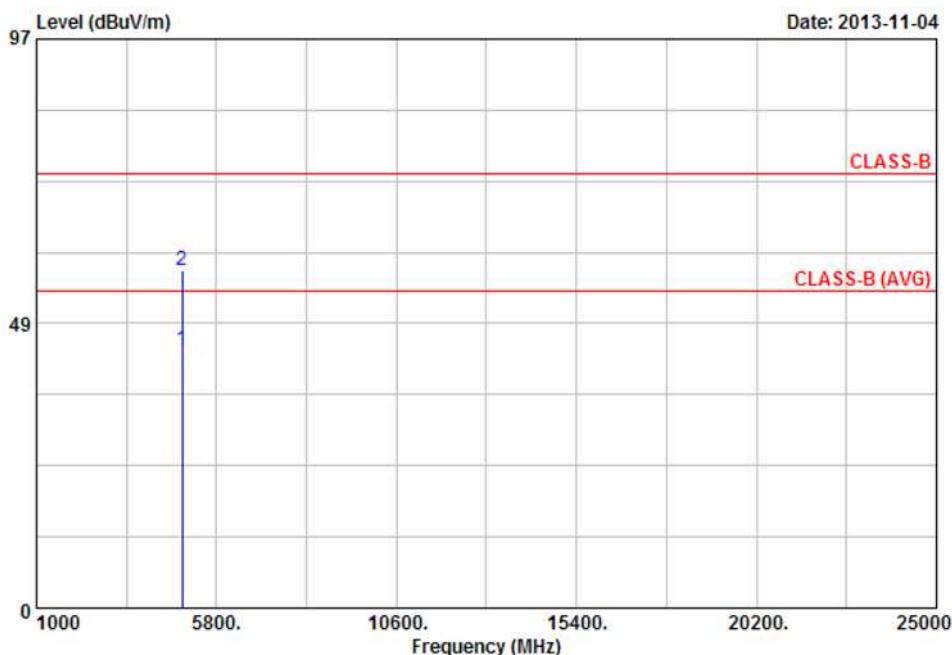

Item	Freq	Read Value	Factor	Result	Limit	Margin	Remark	Ant Pos	Tab Pos
	MHz	dBuV	dB/m	dBuV/m	dBuV/m	dB		cm	Deg
1	4882.05	33.30	10.69	43.99	54.00	-10.01	Average	100	209
2	4882.75	46.72	10.71	57.43	74.00	-16.57	Peak	100	209

Notes:

1. Result = Read Value + Factor
2. Factor = Antenna Factor + Cable Loss - Amplifier
3. The resolution bandwidth of test receiver/spectrum analyzer is 120KHz and video bandwidth is 300kHz for Peak detection and Quasi-peak detection at frequency below 1GHz.
4. The resolution bandwidth of test receiver/spectrum analyzer is 1MHz and video bandwidth is 3MHz for Peak detection at frequency above 1GHz.
5. The resolution bandwidth of test receiver/spectrum analyzer is 1MHz and video bandwidth is 10Hz for Average detection at frequency above 1GHz.
6. The other emissions is too low to be measured.
7. The data is worse case.



Power	: AC 120V	Pol/Phase	: VERTICAL
Test Mode	: Transmit	Temperature	: 25 °C
Operation Channel	: 78	Humidity	: 58 %
Modulation Type	: $\pi/4$ -DQPSK (2 Mbps)	Atmospheric Pressure	: 1020 hPa

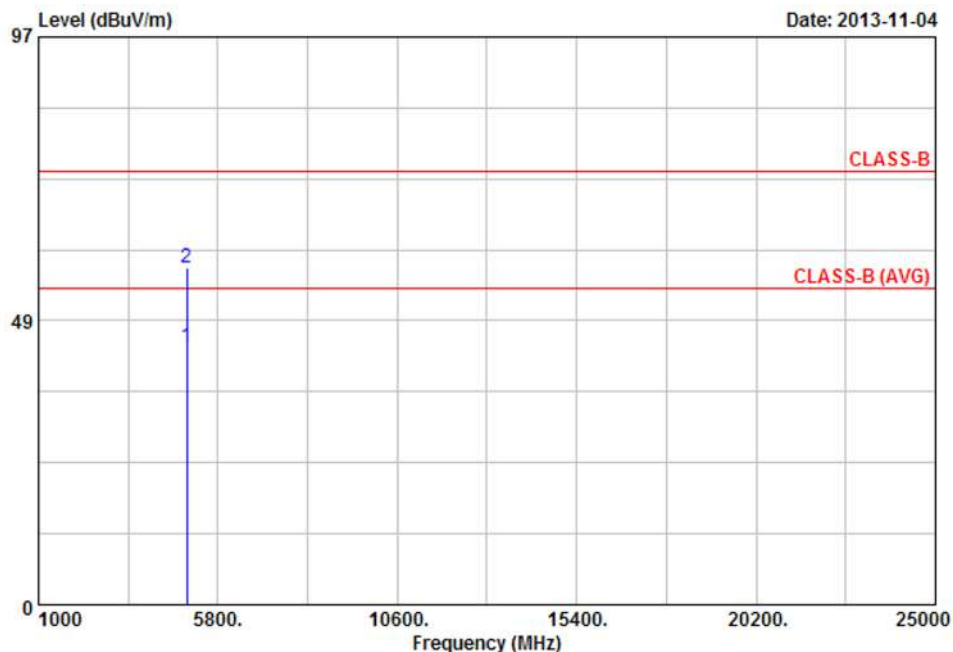

Item	Freq	Read Value	Factor	Result	Limit	Margin	Remark	Ant Pos	Tab Pos
	MHz	dBuV	dB/m	dBuV/m	dBuV/m	dB		cm	Deg
1	4960.05	32.35	11.61	43.96	54.00	-10.04	Average	100	175
2	4960.09	45.97	11.61	57.58	74.00	-16.42	Peak	100	175

Notes:

1. Result = Read Value + Factor
2. Factor = Antenna Factor + Cable Loss - Amplifier
3. The resolution bandwidth of test receiver/spectrum analyzer is 120KHz and video bandwidth is 300KHz for Peak detection and Quasi-peak detection at frequency below 1GHz.
4. The resolution bandwidth of test receiver/spectrum analyzer is 1MHz and video bandwidth is 3MHz for Peak detection at frequency above 1GHz.
5. The resolution bandwidth of test receiver/spectrum analyzer is 1MHz and video bandwidth is 10Hz for Average detection at frequency above 1GHz.
6. The other emissions is too low to be measured.
7. The data is worse case.



Power	: AC 120V	Pol/Phase	: HORIZONTAL
Test Mode	: Transmit	Temperature	: 25 °C
Operation Channel	: 78	Humidity	: 58 %
Modulation Type	: $\pi/4$ -DQPSK (2 Mbps)	Atmospheric Pressure	: 1020 hPa

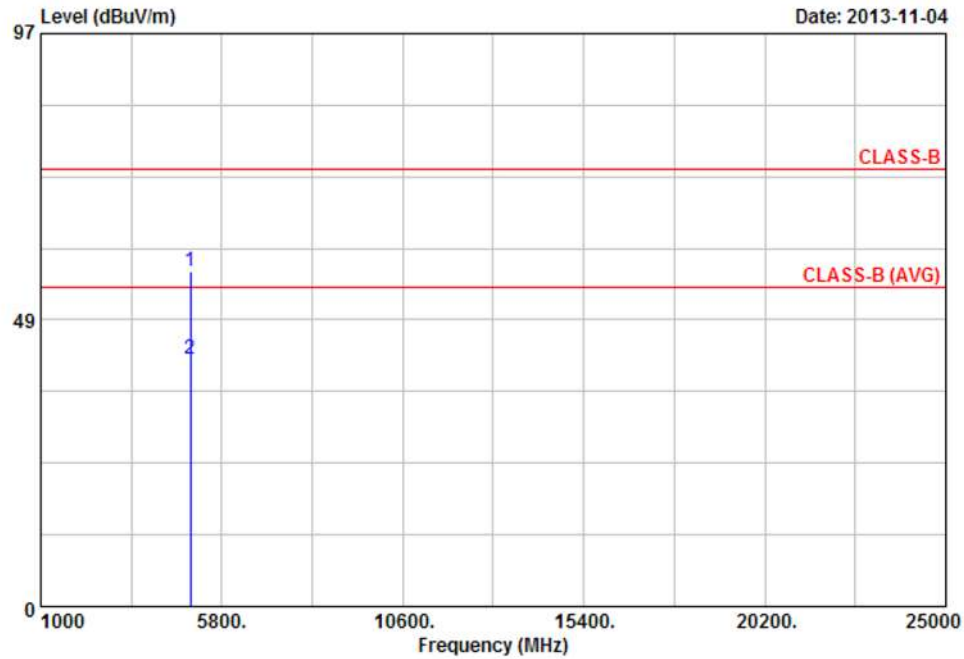

Item	Freq	Read Value	Factor	Result	Limit	Margin	Remark	Ant Pos	Tab Pos
	MHz	dBuV	dB/m	dBuV/m	dBuV/m	dB		cm	Deg
1	4959.33	45.95	10.76	56.71	74.00	-17.29	Peak	100	215
2	4959.99	31.26	10.75	42.01	54.00	-11.99	Average	100	215

Notes:

1. Result = Read Value + Factor
2. Factor = Antenna Factor + Cable Loss - Amplifier
3. The resolution bandwidth of test receiver/spectrum analyzer is 120KHz and video bandwidth is 300kHz for Peak detection and Quasi-peak detection at frequency below 1GHz.
4. The resolution bandwidth of test receiver/spectrum analyzer is 1MHz and video bandwidth is 3MHz for Peak detection at frequency above 1GHz.
5. The resolution bandwidth of test receiver/spectrum analyzer is 1MHz and video bandwidth is 10Hz for Average detection at frequency above 1GHz.
6. The other emissions is too low to be measured.
7. The data is worse case.



Power	: AC 120V	Pol/Phase	: VERTICAL
Test Mode	: Transmit	Temperature	: 25 °C
Operation Channel	: 0	Humidity	: 58 %
Modulation Type	: 8DPSK (3 Mbps)	Atmospheric Pressure	: 1020 hPa

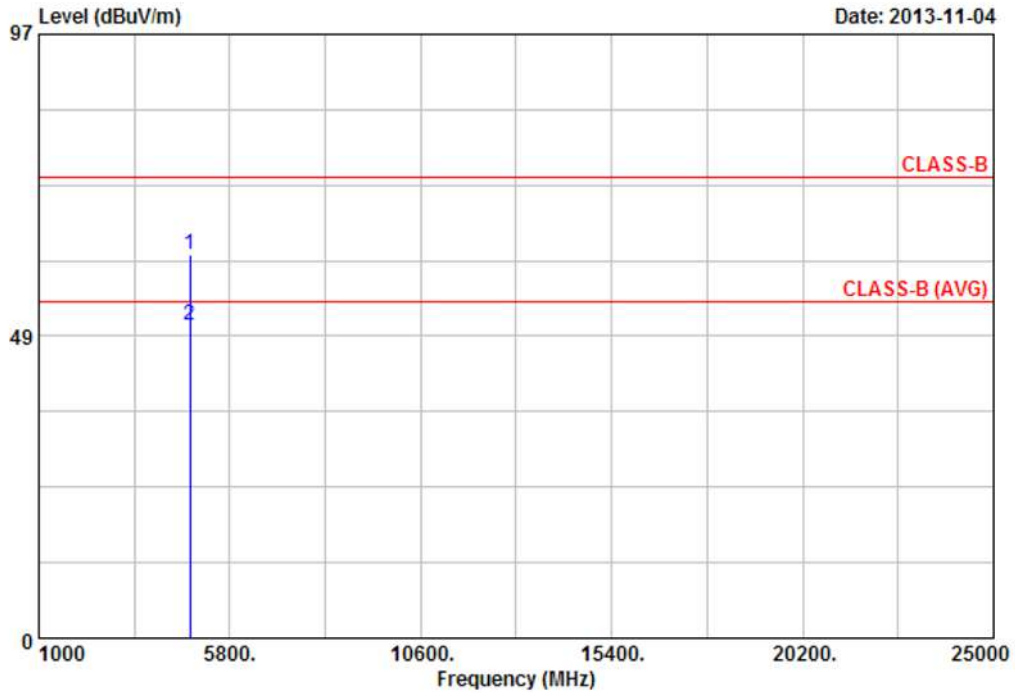

Item	Freq	Read Value	Factor	Result	Limit	Margin	Remark	Ant Pos	Tab Pos
	MHz	dBuV	dB/m	dBuV/m	dBuV/m	dB		cm	Deg
1	4804.00	51.32	10.34	61.66	74.00	-12.34	Peak	100	176
2	4804.03	39.86	10.34	50.20	54.00	-3.80	Average	100	176

Notes:

1. Result = Read Value + Factor
2. Factor = Antenna Factor + Cable Loss - Amplifier
3. The resolution bandwidth of test receiver/spectrum analyzer is 120KHz and video bandwidth is 300kHz for Peak detection and Quasi-peak detection at frequency below 1GHz.
4. The resolution bandwidth of test receiver/spectrum analyzer is 1MHz and video bandwidth is 3MHz for Peak detection at frequency above 1GHz.
5. The resolution bandwidth of test receiver/spectrum analyzer is 1MHz and video bandwidth is 10Hz for Average detection at frequency above 1GHz.
6. The other emissions is too low to be measured.
7. The data is worse case.





Power	: AC 120V	Pol/Phase	: HORIZONTAL
Test Mode	: Transmit	Temperature	: 25 °C
Operation Channel	: 0	Humidity	: 58 %
Modulation Type	: 8DPSK (3 Mbps)	Atmospheric Pressure	: 1020 hPa

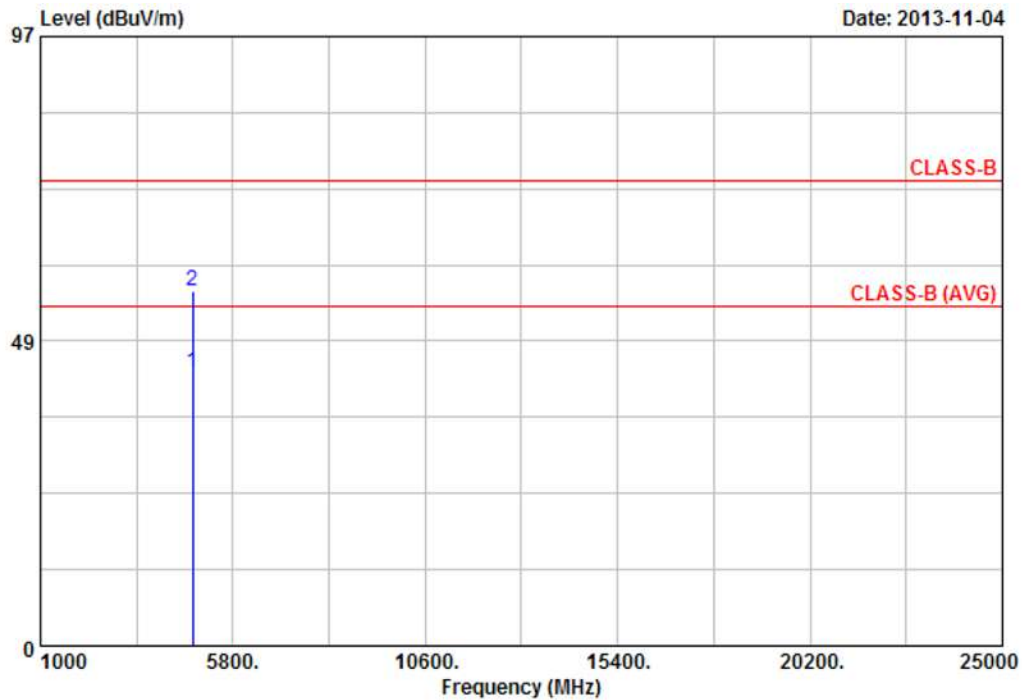

Item	Freq	Read Value	Factor	Result	Limit	Margin	Remark	Ant Pos	Tab Pos
	MHz	dBuV	dB/m	dBuV/m	dBuV/m	dB		cm	Deg
1	4804.09	34.06	9.32	43.38	54.00	-10.62	Average	100	184
2	4804.46	47.19	9.32	56.51	74.00	-17.49	Peak	100	184

Notes:

1. Result = Read Value + Factor
2. Factor = Antenna Factor + Cable Loss - Amplifier
3. The resolution bandwidth of test receiver/spectrum analyzer is 120KHz and video bandwidth is 300kHz for Peak detection and Quasi-peak detection at frequency below 1GHz.
4. The resolution bandwidth of test receiver/spectrum analyzer is 1MHz and video bandwidth is 3MHz for Peak detection at frequency above 1GHz.
5. The resolution bandwidth of test receiver/spectrum analyzer is 1MHz and video bandwidth is 10Hz for Average detection at frequency above 1GHz.
6. The other emissions is too low to be measured.
7. The data is worse case.



Power	: AC 120V	Pol/Phase	: VERTICAL
Test Mode	: Transmit	Temperature	: 25 °C
Operation Channel	: 39	Humidity	: 58 %
Modulation Type	: 8DPSK (3 Mbps)	Atmospheric Pressure	: 1020 hPa

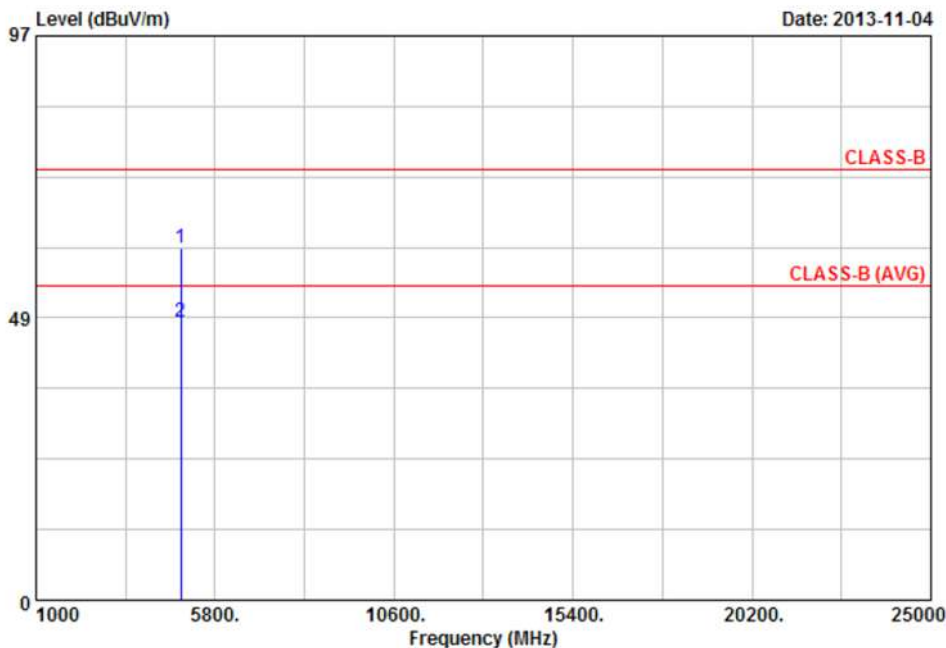

Item	Freq	Read Value	Factor	Result	Limit	Margin	Remark	Ant Pos	Tab Pos
	MHz	dBuV	dB/m	dBuV/m	dBuV/m	dB		cm	Deg
1	4881.85	49.87	10.67	60.54	74.00	-13.46	Peak	100	167
2	4882.01	37.29	10.67	47.96	54.00	-6.04	Average	100	167

Notes:

1. Result = Read Value + Factor
2. Factor = Antenna Factor + Cable Loss - Amplifier
3. The resolution bandwidth of test receiver/spectrum analyzer is 120KHz and video bandwidth is 300kHz for Peak detection and Quasi-peak detection at frequency below 1GHz.
4. The resolution bandwidth of test receiver/spectrum analyzer is 1MHz and video bandwidth is 3MHz for Peak detection at frequency above 1GHz.
5. The resolution bandwidth of test receiver/spectrum analyzer is 1MHz and video bandwidth is 10Hz for Average detection at frequency above 1GHz.
6. The other emissions is too low to be measured.
7. The data is worse case.





Power	: AC 120V	Pol/Phase	: HORIZONTAL
Test Mode	: Transmit	Temperature	: 25 °C
Operation Channel	: 39	Humidity	: 58 %
Modulation Type	: 8DPSK (3 Mbps)	Atmospheric Pressure	: 1020 hPa

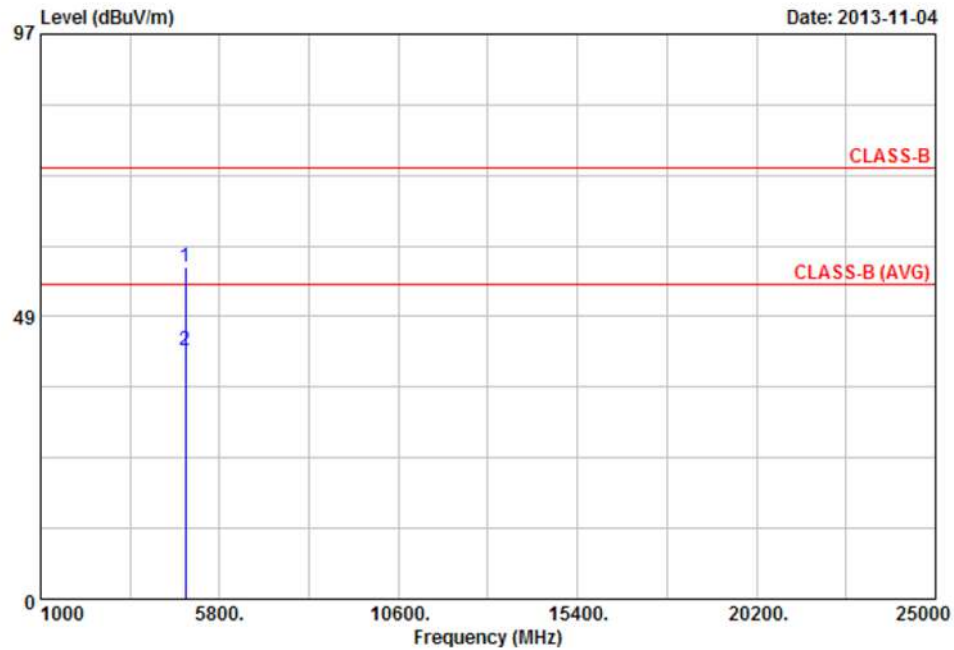

Item	Freq	Read Value	Factor	Result	Limit	Margin	Remark	Ant Pos	Tab Pos
	MHz	dBuV	dB/m	dBuV/m	dBuV/m	dB		cm	Deg
1	4881.81	46.19	10.69	56.88	74.00	-17.12	Peak	100	236
2	4881.95	32.12	10.69	42.81	54.00	-11.19	Average	100	236

Notes:

1. Result = Read Value + Factor
2. Factor = Antenna Factor + Cable Loss - Amplifier
3. The resolution bandwidth of test receiver/spectrum analyzer is 120KHz and video bandwidth is 300kHz for Peak detection and Quasi-peak detection at frequency below 1GHz.
4. The resolution bandwidth of test receiver/spectrum analyzer is 1MHz and video bandwidth is 3MHz for Peak detection at frequency above 1GHz.
5. The resolution bandwidth of test receiver/spectrum analyzer is 1MHz and video bandwidth is 10Hz for Average detection at frequency above 1GHz.
6. The other emissions is too low to be measured.
7. The data is worse case.



Power	: AC 120V	Pol/Phase	: VERTICAL
Test Mode	: Transmit	Temperature	: 25 °C
Operation Channel	: 78	Humidity	: 58 %
Modulation Type	: 8DPSK (3 Mbps)	Atmospheric Pressure	: 1020 hPa

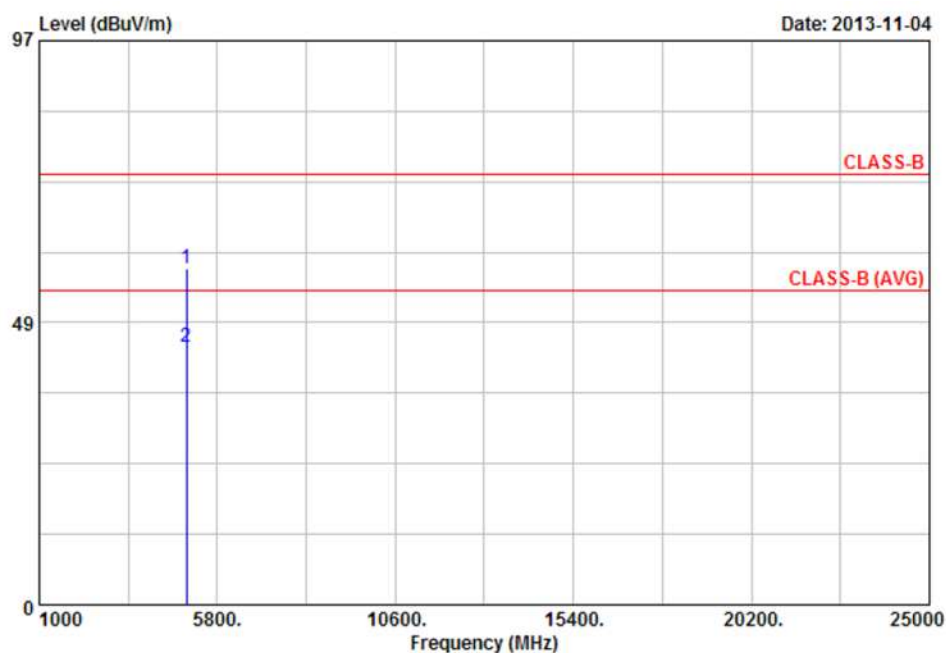

Item	Freq	Read Value	Factor	Result	Limit	Margin	Remark	Ant Pos	Tab Pos
	MHz	dBuV	dB/m	dBuV/m	dBuV/m	dB		cm	Deg
1	4959.92	46.30	11.61	57.91	74.00	-16.09	Peak	100	185
2	4960.07	32.79	11.61	44.40	54.00	-9.60	Average	100	185

Notes:

1. Result = Read Value + Factor
2. Factor = Antenna Factor + Cable Loss - Amplifier
3. The resolution bandwidth of test receiver/spectrum analyzer is 120KHz and video bandwidth is 300kHz for Peak detection and Quasi-peak detection at frequency below 1GHz.
4. The resolution bandwidth of test receiver/spectrum analyzer is 1MHz and video bandwidth is 3MHz for Peak detection at frequency above 1GHz.
5. The resolution bandwidth of test receiver/spectrum analyzer is 1MHz and video bandwidth is 10Hz for Average detection at frequency above 1GHz.
6. The other emissions is too low to be measured.
7. The data is worse case.



Power	: AC 120V	Pol/Phase	: HORIZONTAL
Test Mode	: Transmit	Temperature	: 25 °C
Operation Channel	: 78	Humidity	: 58 %
Modulation Type	: 8DPSK (3 Mbps)	Atmospheric Pressure	: 1020 hPa

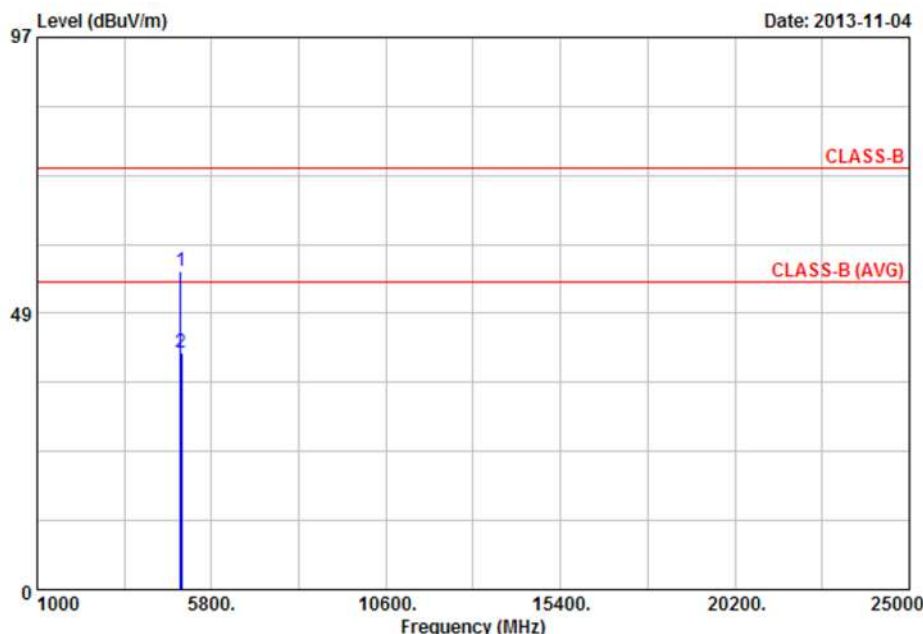

Item	Freq	Read Value	Factor	Result	Limit	Margin	Remark	Ant Pos	Tab Pos
	MHz	dBuV	dB/m	dBuV/m	dBuV/m	dB		cm	Deg
1	4957.48	45.15	10.76	55.91	74.00	-18.09	Peak	100	204
2	4960.11	30.97	10.75	41.72	54.00	-12.28	Average	100	204

Notes:

1. Result = Read Value + Factor
2. Factor = Antenna Factor + Cable Loss - Amplifier
3. The resolution bandwidth of test receiver/spectrum analyzer is 120KHz and video bandwidth is 300kHz for Peak detection and Quasi-peak detection at frequency below 1GHz.
4. The resolution bandwidth of test receiver/spectrum analyzer is 1MHz and video bandwidth is 3MHz for Peak detection at frequency above 1GHz.
5. The resolution bandwidth of test receiver/spectrum analyzer is 1MHz and video bandwidth is 10Hz for Average detection at frequency above 1GHz.
6. The other emissions is too low to be measured.
7. The data is worse case.



## 6. 20dB Bandwidth Measurement Data

### 6.1 Test Limit

Frequency hopping systems shall have hopping channel carrier frequencies separated by a minimum of 25 kHz or the 20 dB bandwidth of the hopping channel, whichever is greater. Alternatively, frequency hopping systems operating in the 2400–2483.5 MHz band may have hopping channel carrier frequencies that are separated by 25 kHz or two-thirds of the 20 dB bandwidth of the hopping channel, whichever is greater, provided the systems operate with an output power no greater than 125 mW.

### 6.2 Test Procedures

- a. The transmitter output was connected to the spectrum analyzer.
- b. Set RBW of spectrum analyzer to 30 KHz and VBW to 100 KHz.
- c. The 20 dB bandwidth is defined as the total spectrum the power of which is higher than peak power minus 20 dB.

### 6.3 Test Setup Layout

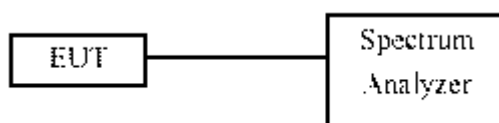

### 6.4 Measurement equipment

Instrument/Ancillary	Model No.	Manufacturer	Serial No.	Calibration Date	Valid Date
Spectrum Analyzer	R&S	FSP40	100219	2013/09/14	2014/09/13



### 6.5 Test Result and Data

Test Date: Apr. 30, 2014

Temperature: 24 °C

Atmospheric pressure: 1018 hPa

Humidity: 51 %

Modulation Type	Channel	Frequency (MHz)	20dB Bandwidth (KHz)	2/3 20dB Bandwidth (KHz)
GFSK (1Mbps)	00	2402	804.00	536.00
	39	2441	796.00	530.67
	78	2480	812.00	541.33
$\pi/4$ -DQPSK (2 Mbps)	00	2402	1284.00	856.00
	39	2441	1276.00	850.67
	78	2480	1348.00	898.67
8DPSK (3Mbps)	00	2402	1312.00	874.67
	39	2441	1308.00	872.00
	78	2480	1316.00	877.33



Modulation Standard: GFSK (1Mbps)  
Channel: 00

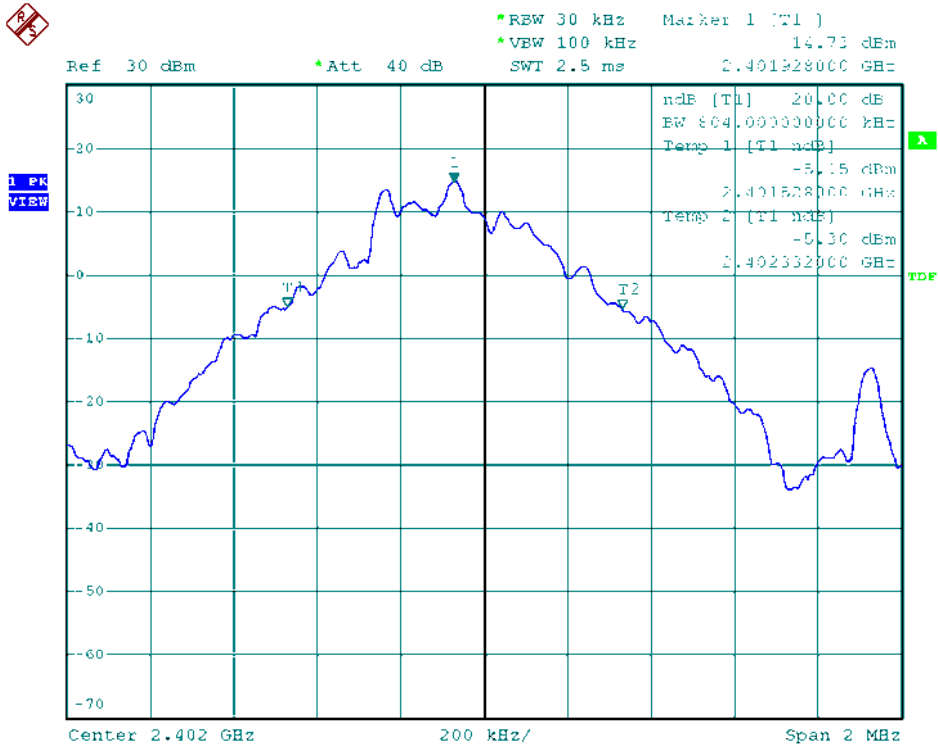

Modulation Standard: GFSK (1Mbps)  
Channel: 39

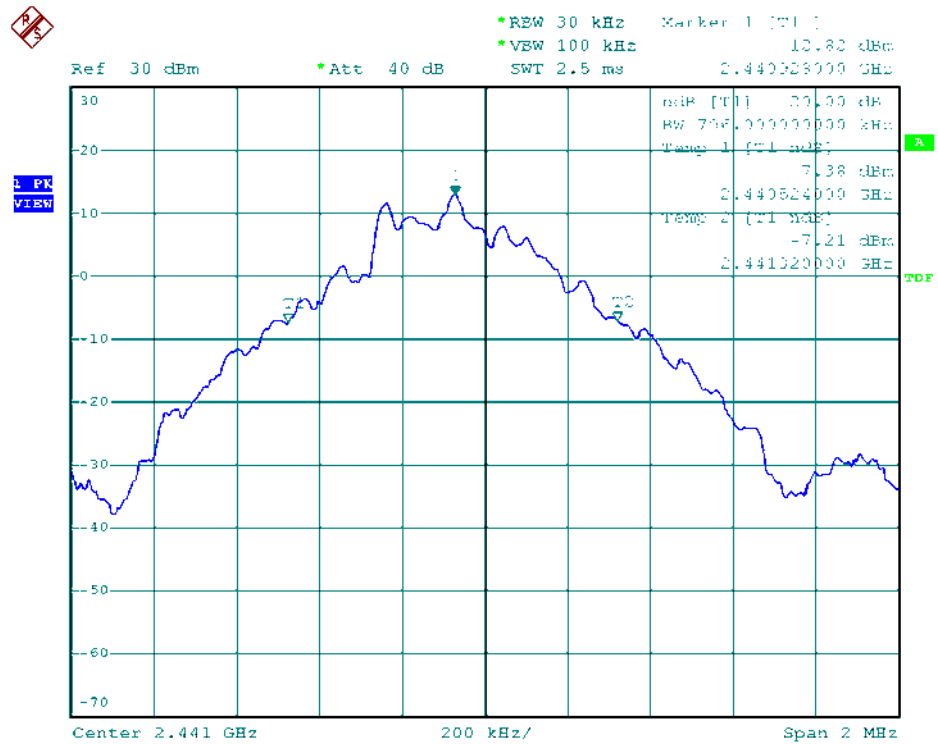





Modulation Standard: GFSK (1Mbps)  
Channel: 78

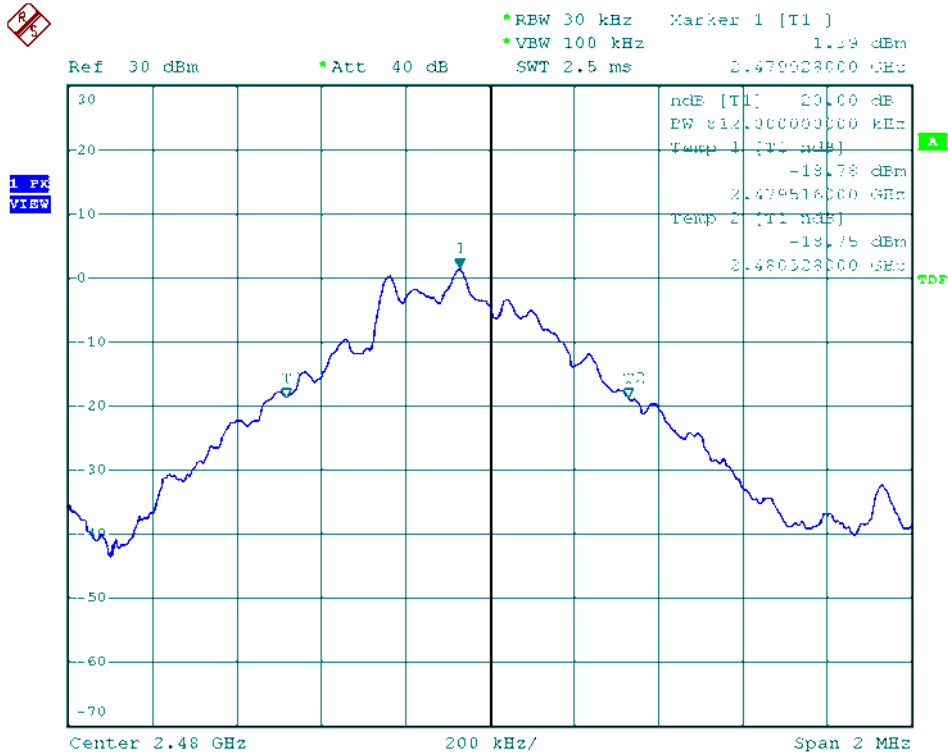

Modulation Standard:  $\pi/4$ -DQPSK (2Mbps)  
Channel: 00

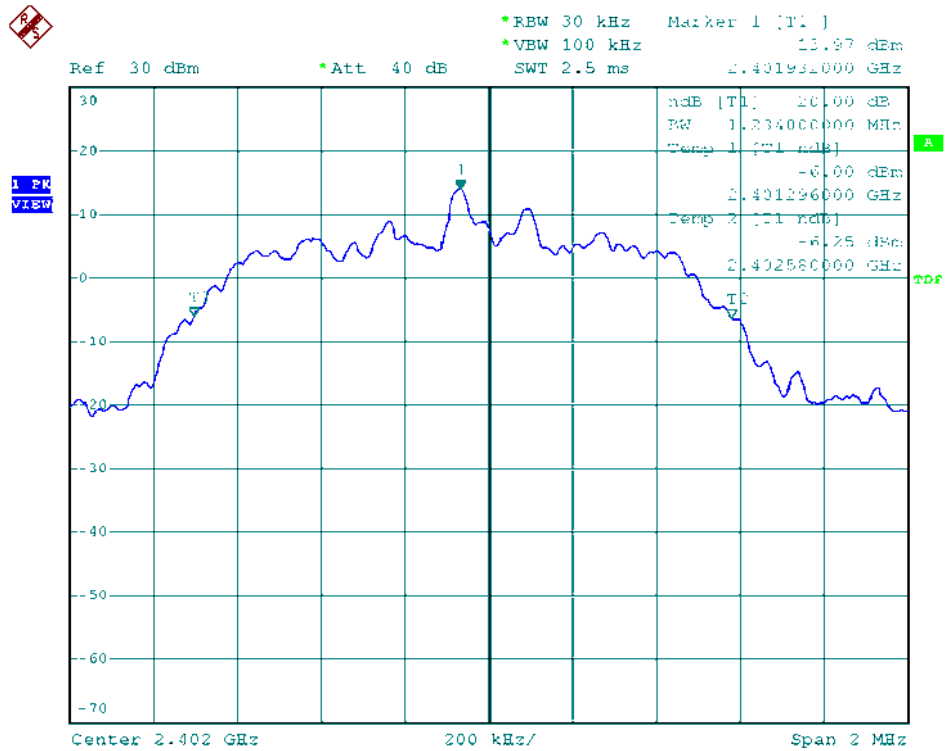



Modulation Standard:  $\pi/4$ -DQPSK (2Mbps)  
Channel: 39

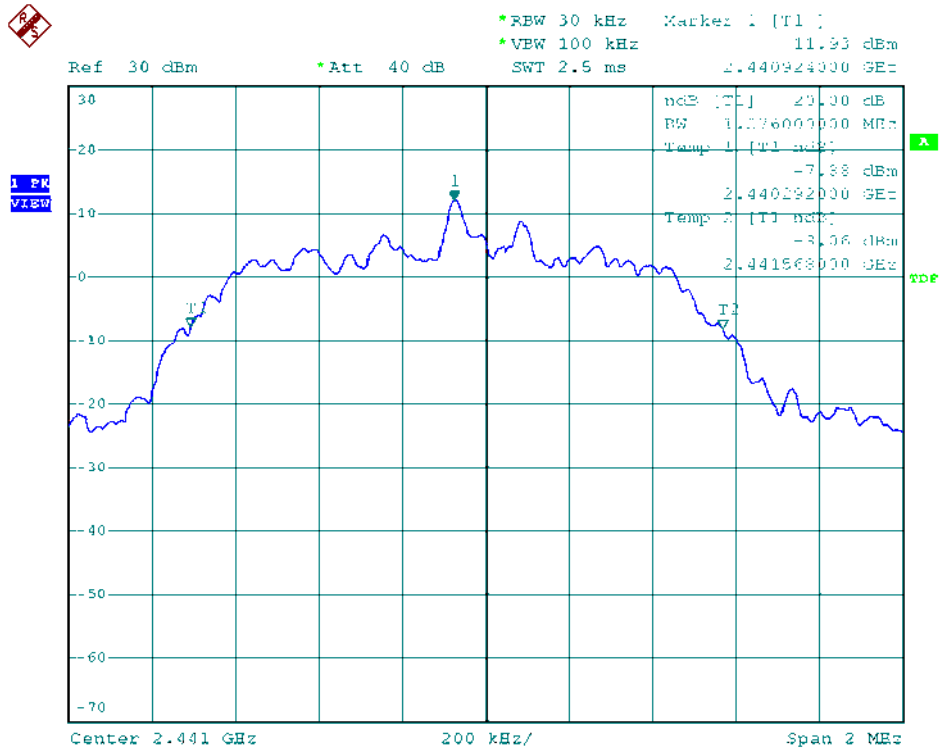

Modulation Standard:  $\pi/4$ -DQPSK (2Mbps)  
Channel: 78

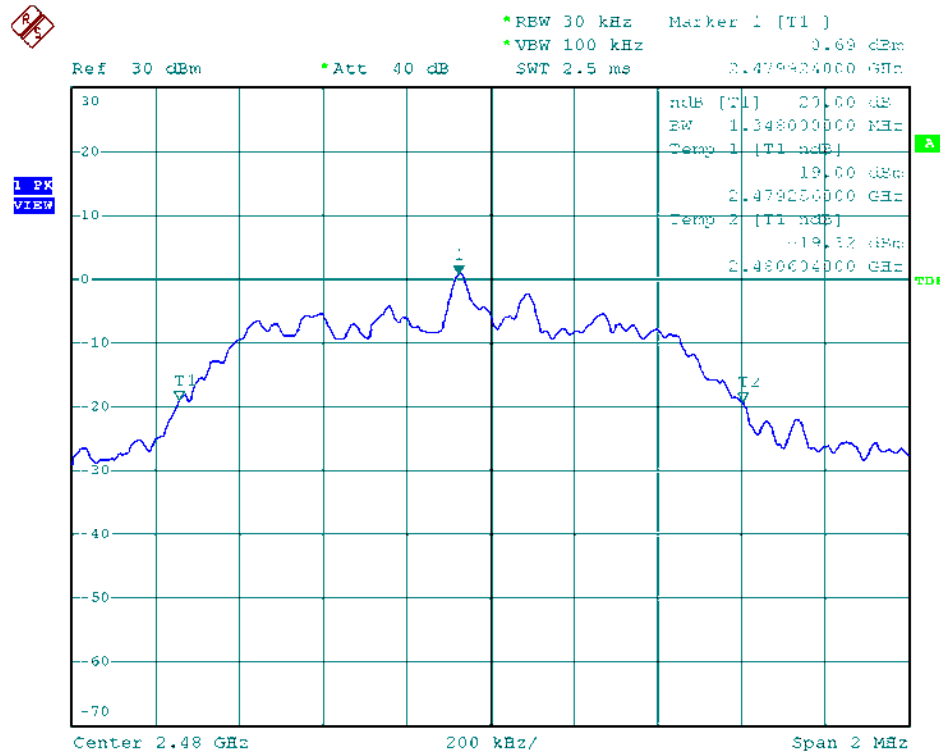



Modulation Standard: 8DPSK (3Mbps)  
Channel: 00

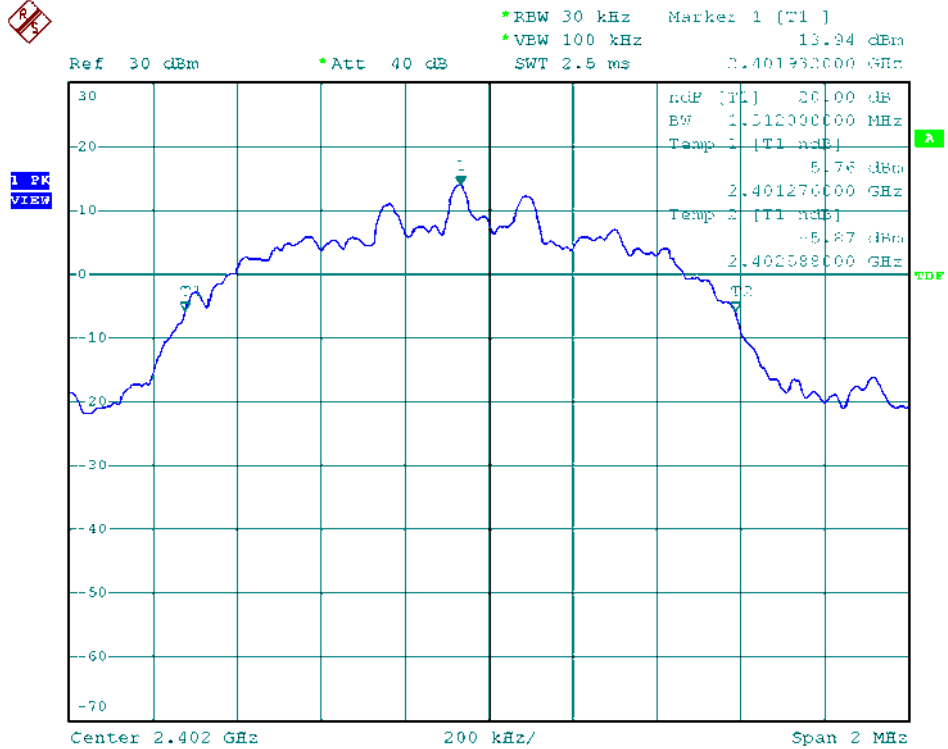

Modulation Standard: 8DPSK (3Mbps)  
Channel: 39

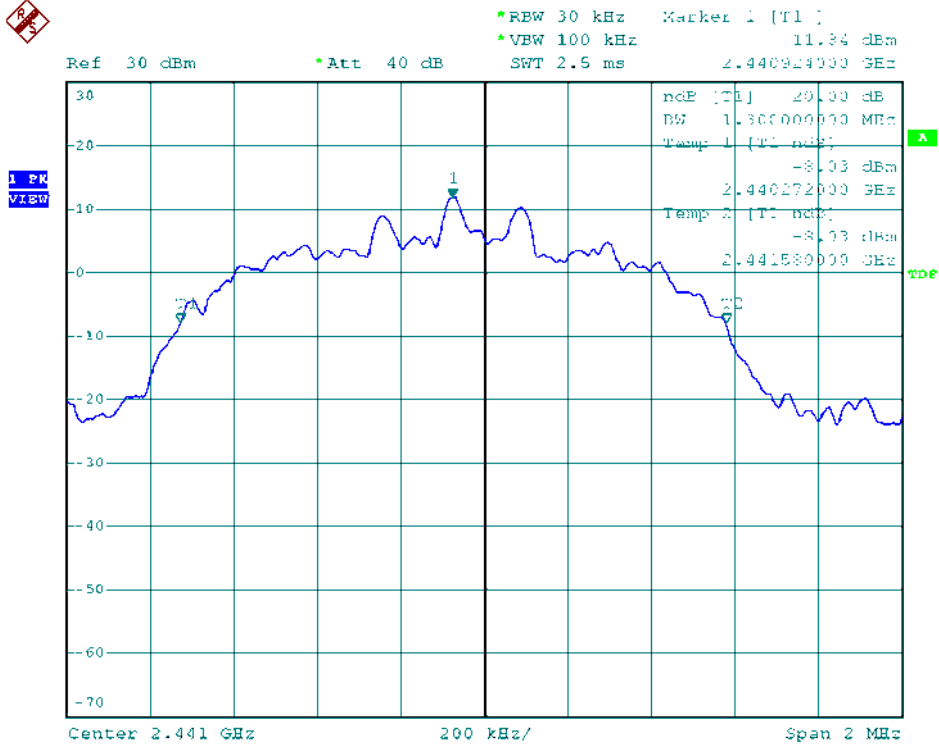



Modulation Standard: 8DPSK (3Mbps)  
Channel: 78



\*RBW 30 kHz    Marker 1 [T1]  
\*VBW 100 kHz    0.40 dBm  
SWT 2.5 ms    2.479924000 GHz

Ref 30 dBm    \*Att 40 dB

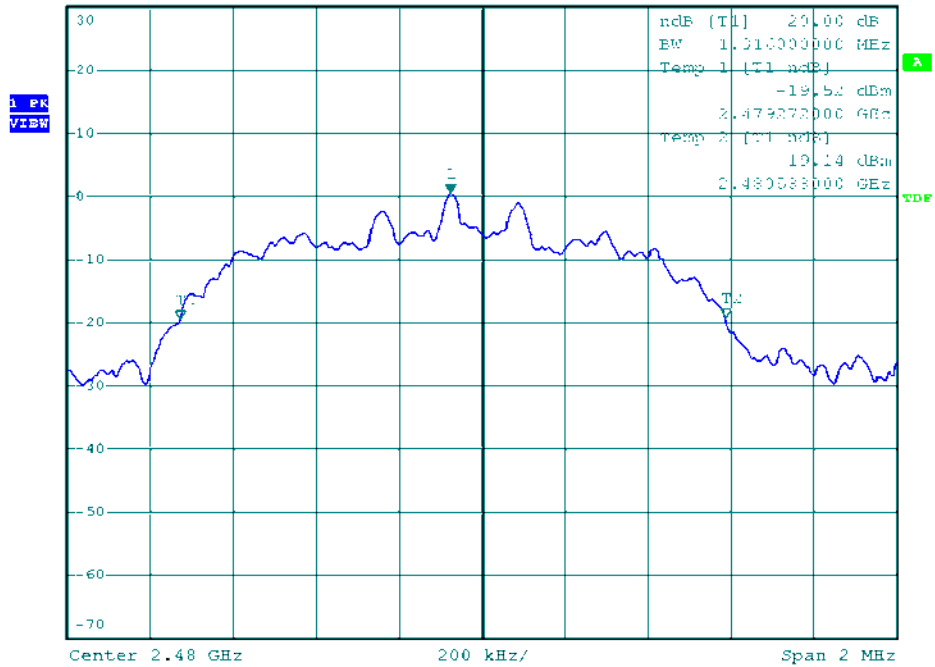



## 7. Frequencies Separation

### 7.1 Test Limit

Frequency hopping systems shall have hopping channel carrier frequencies separated by a minimum of 25 kHz or the 20 dB bandwidth of the hopping channel, whichever is greater.

### 7.2 Test Procedures

- a. The transmitter output was connected to the spectrum analyzer.
- b. Set RBW of spectrum analyzer to 100 KHz and VBW to 100 KHz.
- c. By using the MaxHold function record the separation of two adjacent channels.
- d. Measure the frequency difference of these two adjacent channels.

### 7.3 Test Setup Layout

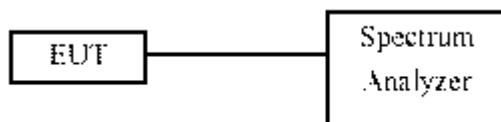

### 7.4 Measurement equipment

Instrument/Ancillary	Model No.	Manufacturer	Serial No.	Calibration Date	Valid Date
Spectrum Analyzer	R&S	FSP40	100219	2013/09/14	2014/09/13



### 7.5 Test Result and Data

Test Date: Apr. 30, 2014

Temperature: 24 °C

Atmospheric pressure: 1018 hPa

Humidity: 51 %

Modulation Type	Channel	Frequency (MHz)	Frequency Separation (MHz)
GFSK (1Mbps)	00	2402	1.000
	39	2441	1.004
	78	2480	1.000
$\pi/4$ -DQPSK (2 Mbps)	00	2402	1.004
	39	2441	1.004
	78	2480	1.004
8DPSK (3Mbps)	00	2402	0.996
	39	2441	1.004
	78	2480	1.004





Modulation Standard: GFSK (1Mbps)  
Channel: 00

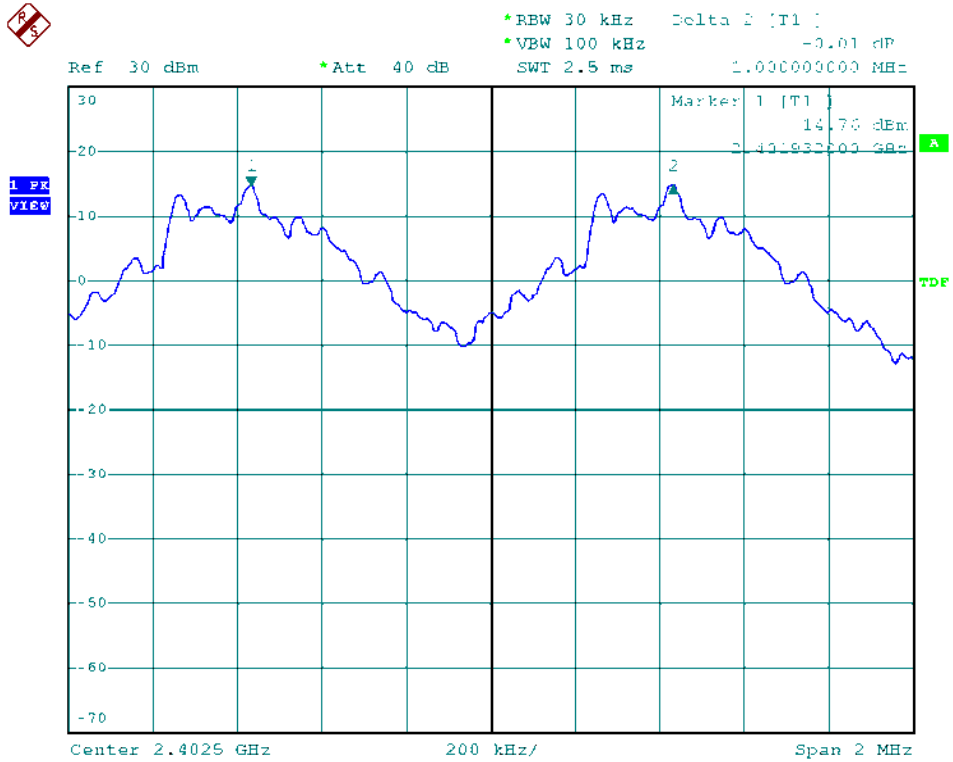

Modulation Standard: GFSK (1Mbps)  
Channel: 39

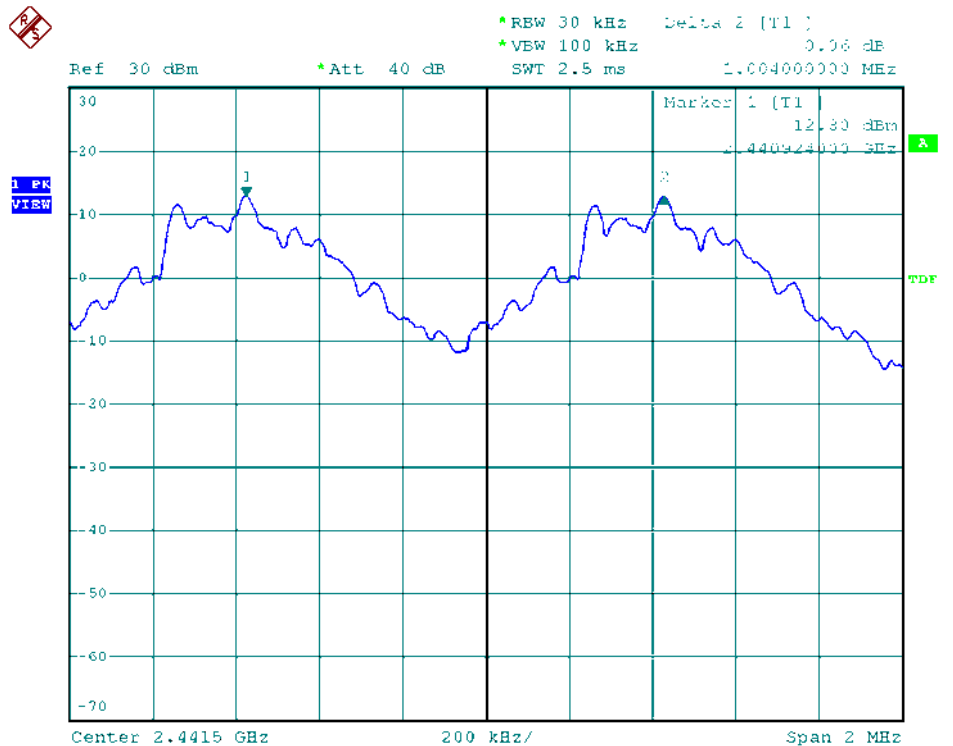



Modulation Standard: GFSK (1Mbps)  
Channel: 78

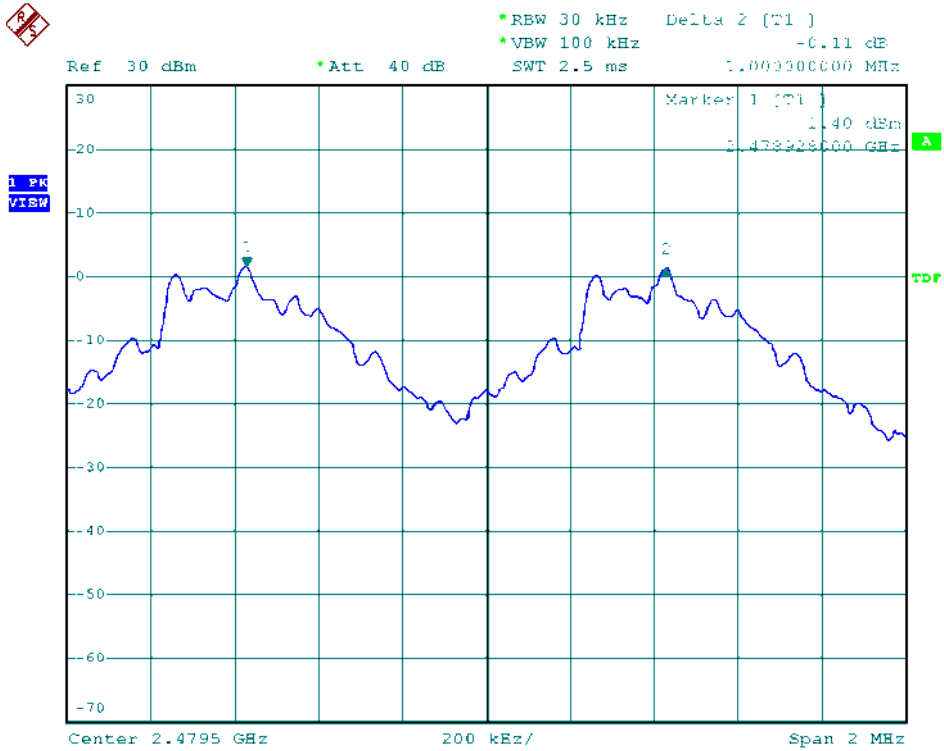

Modulation Standard:  $\pi/4$ -DQPSK (2Mbps)  
Channel: 00

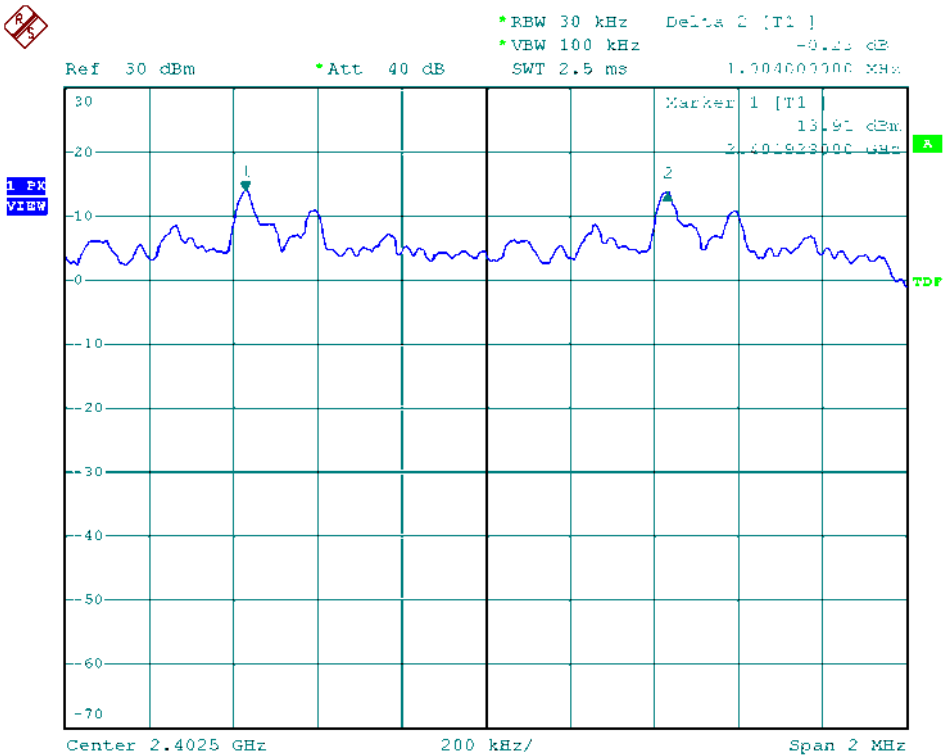



Modulation Standard:  $\pi/4$ -DQPSK (2Mbps)  
Channel: 39

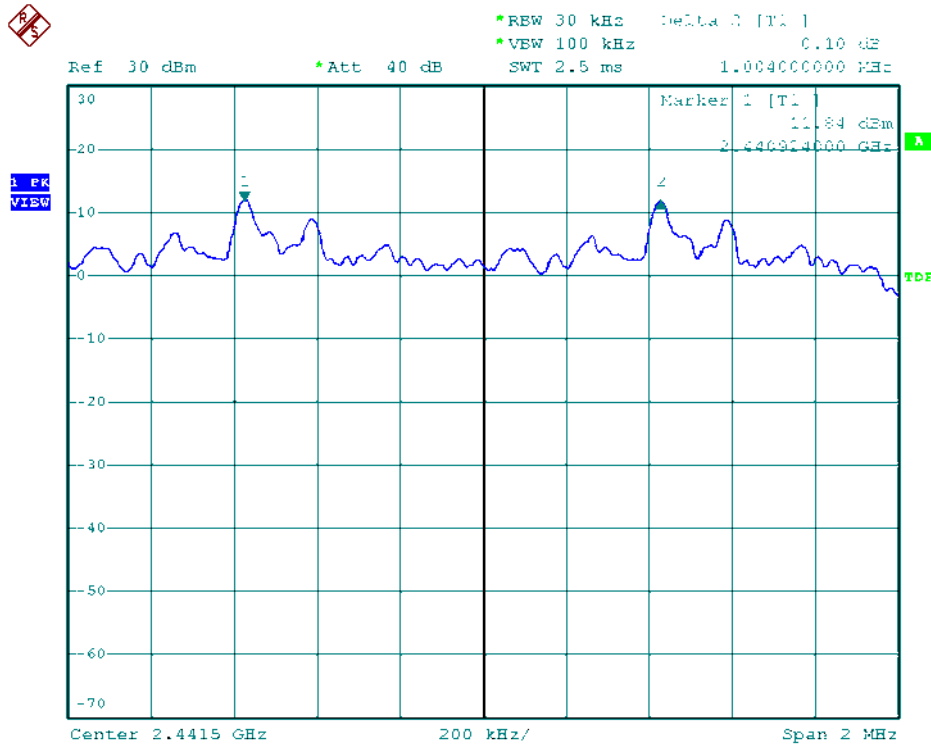

Modulation Standard:  $\pi/4$ -DQPSK (2Mbps)  
Channel: 78

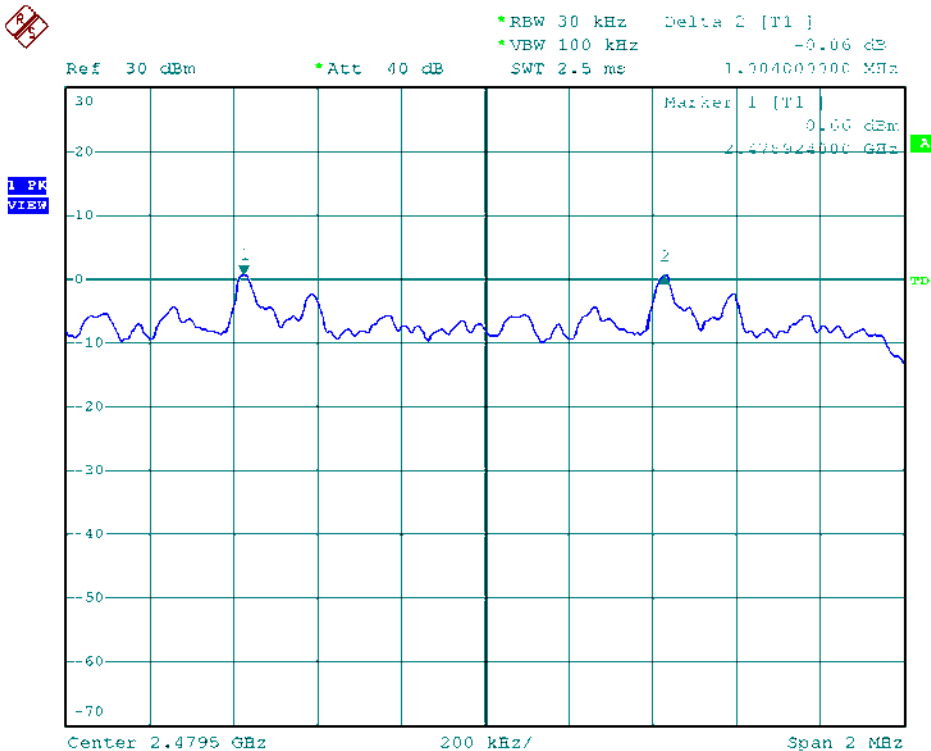



Modulation Standard: 8DPSK (3Mbps)  
Channel: 00

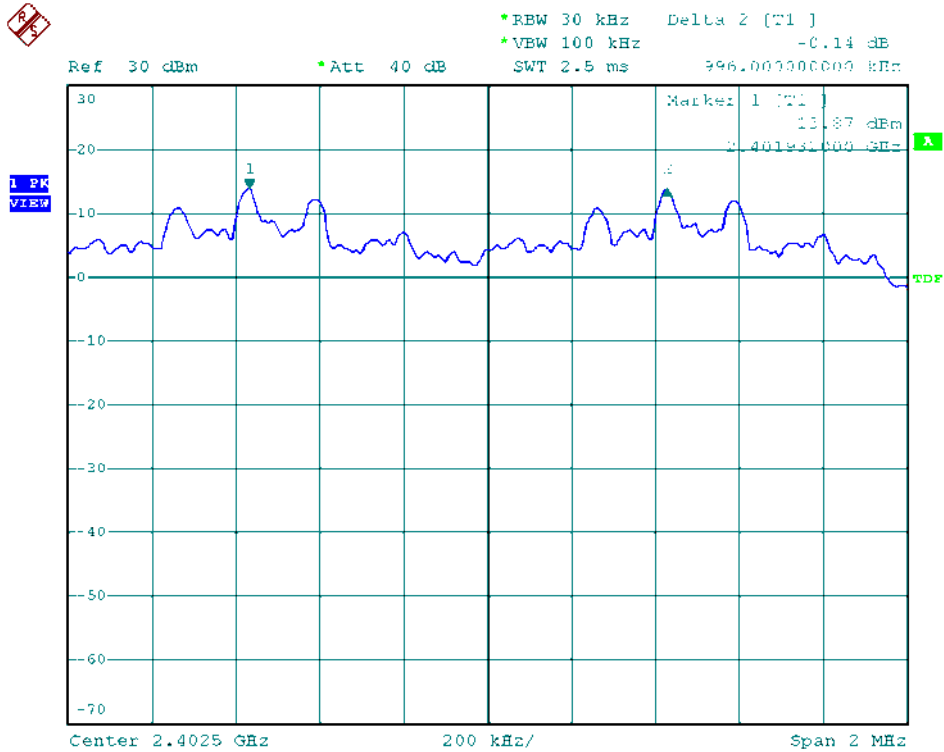

Modulation Standard: 8DPSK (3Mbps)  
Channel: 39

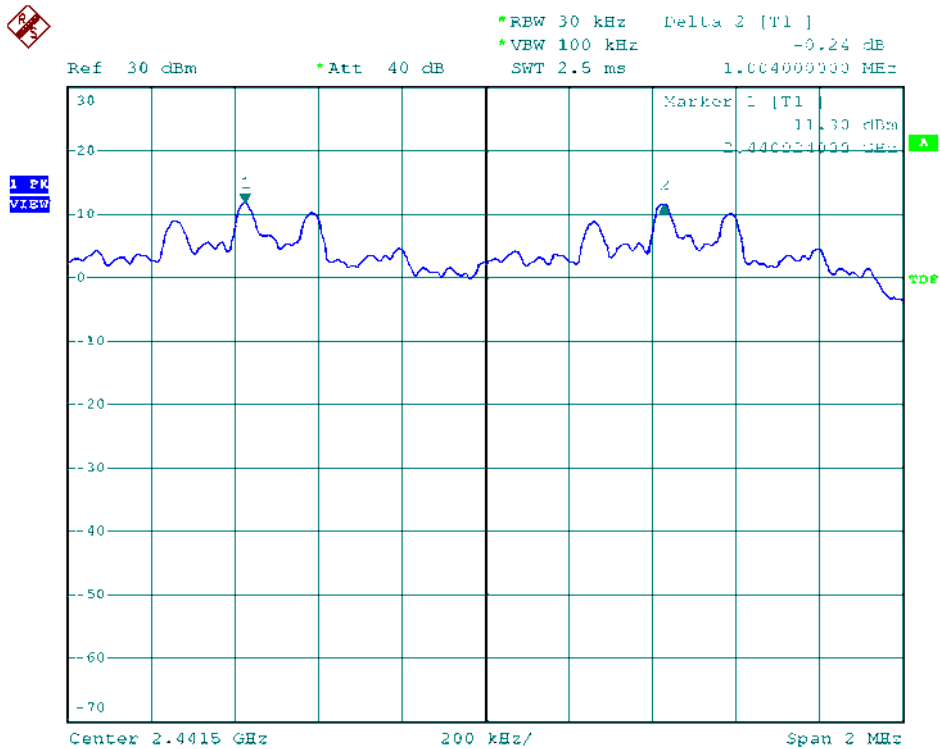



Modulation Standard: 8DPSK (3Mbps)  
Channel: 78

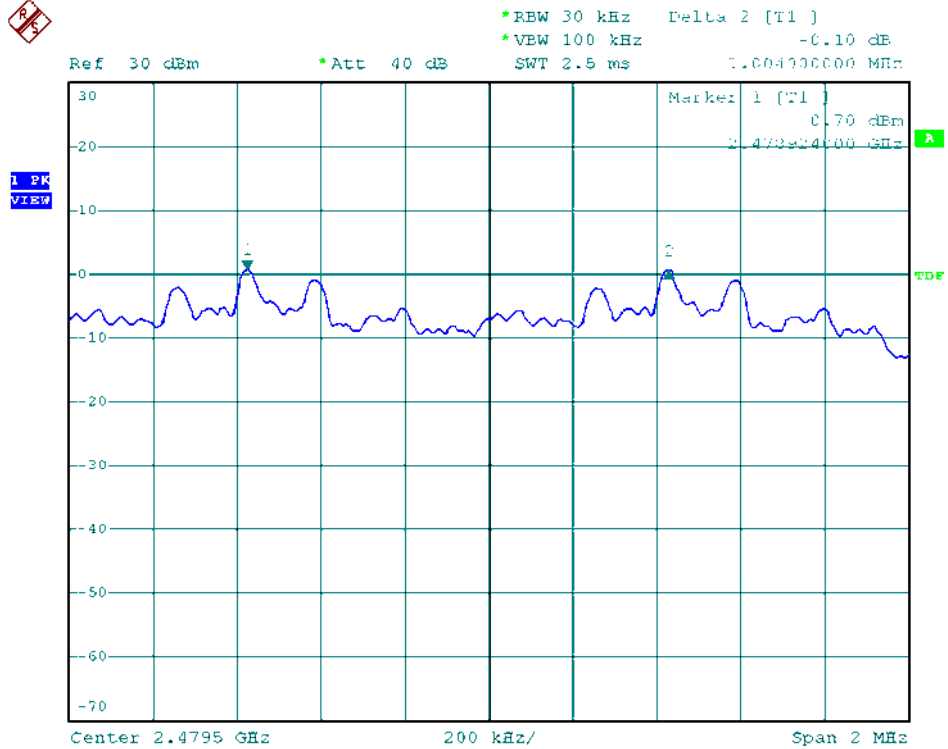



## 8. Dwell Time on each channel

### 8.1 Test Limit

The average time of occupancy on any channel shall not be greater than 0.4 seconds within a period of 0.4 seconds multiplied by the number of hopping channels employed.

### 8.2 Test Procedures

1. The transmitter output was connected to the spectrum analyzer.
2. Adjust the center frequency to measure frequency, then set zero span mode.
2. Set RBW of spectrum analyzer to 1 MHz and VBW to 1 MHz.
4. Measure the time duration of one transmission on the measured frequency.

### 8.3 Test Setup Layout

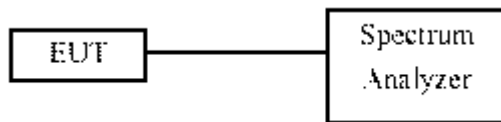

### 8.4 Measurement equipment

Instrument/Ancillary	Model No.	Manufacturer	Serial No.	Calibration Date	Valid Date
Spectrum Analyzer	R&S	FSP40	100219	2013/09/14	2014/09/13



## 8.5 Test Result and Data

Test Date: Apr. 30, 2014

Temperature: 24 °C

Atmospheric pressure: 1018 hPa

Humidity: 51 %

Modulation Type	Channel	Frequency (MHz)	Dwell Time (ms)
GFSK DH1	00	2402	129.96
	39	2441	129.96
	78	2480	129.96
GFSK DH3	00	2402	268.48
	39	2441	267.20
	78	2480	267.20
GFSK DH5	00	2402	312.31
	39	2441	312.31
	78	2480	312.31
$\pi/4$ -DQPSK 2DH5	00	2402	313.38
	39	2441	313.38
	78	2480	313.38
8DPSK 3DH5	00	2402	313.38
	39	2441	313.38
	78	2480	313.38

Test period: 0.4(second/ channel) x 79 channel=31.6 second

Example:

CH0,DH1 mode=  $0.406 \text{ (ms)} * (1600/2)/79 * 31.6 = 129.96 \text{ (ms)}$

CH0,DH3 mode =  $1.678 \text{ (ms)} * (1600/4)/79 * 31.6 = 268.31 \text{ (ms)}$

CH0,DH5 mode =  $2.924 \text{ (ms)} * (1600/6)/79 * 31.6 = 312.31 \text{ (ms)}$





Modulation Standard: GFSK (1Mbps)  
Channel: 00, Rate: DH1

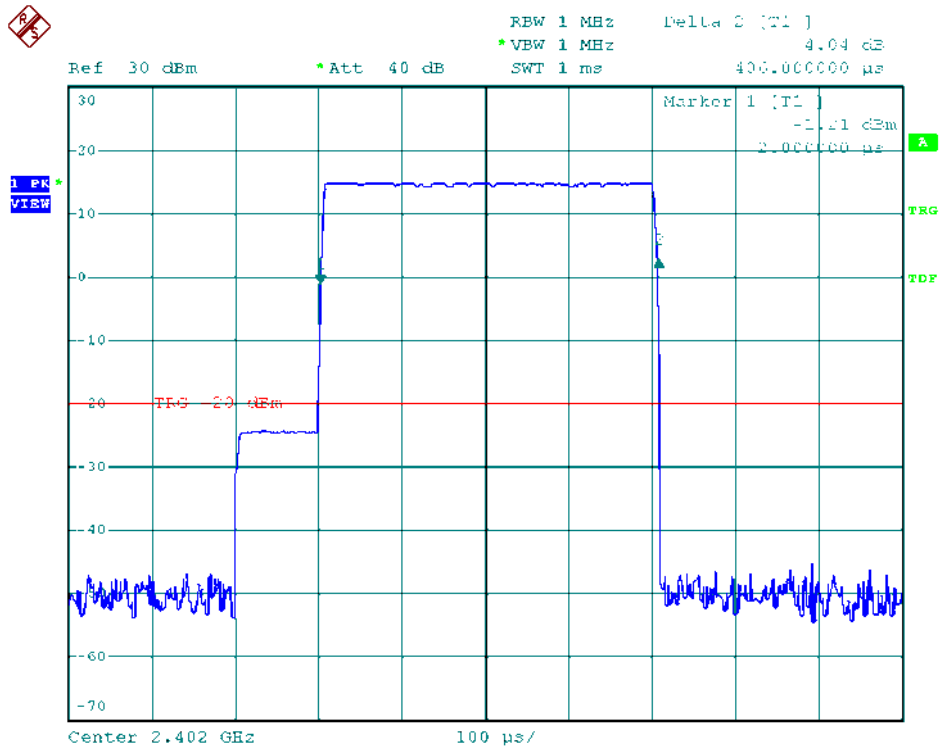

Modulation Standard: GFSK (1Mbps)  
Channel: 00, Rate: DH3

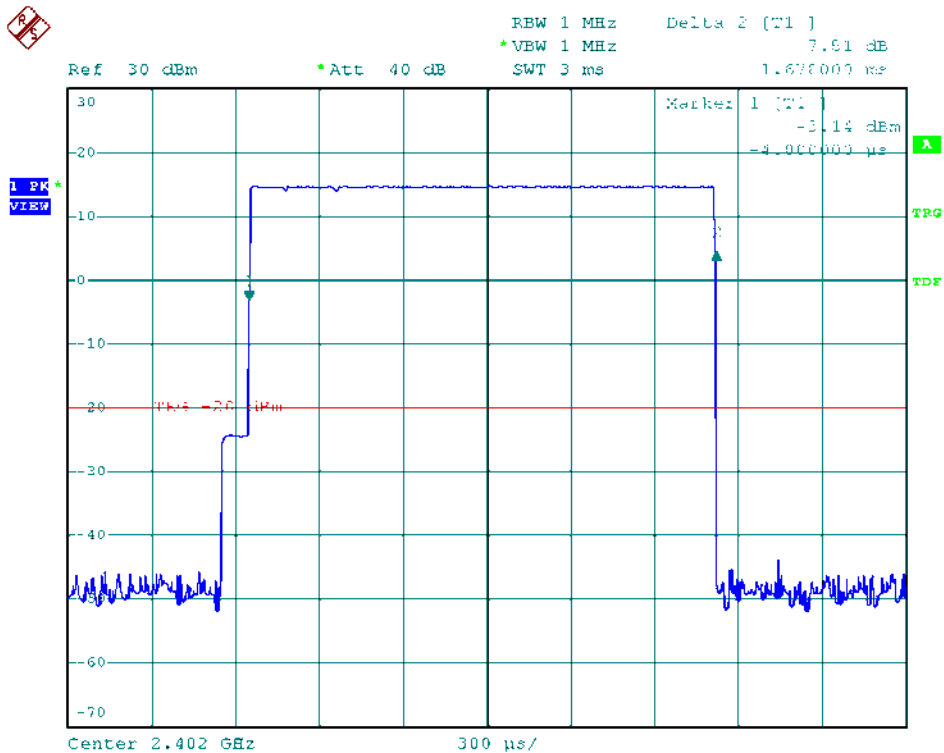



Modulation Standard: GFSK (1Mbps)  
Channel: 00, Rate: DH5

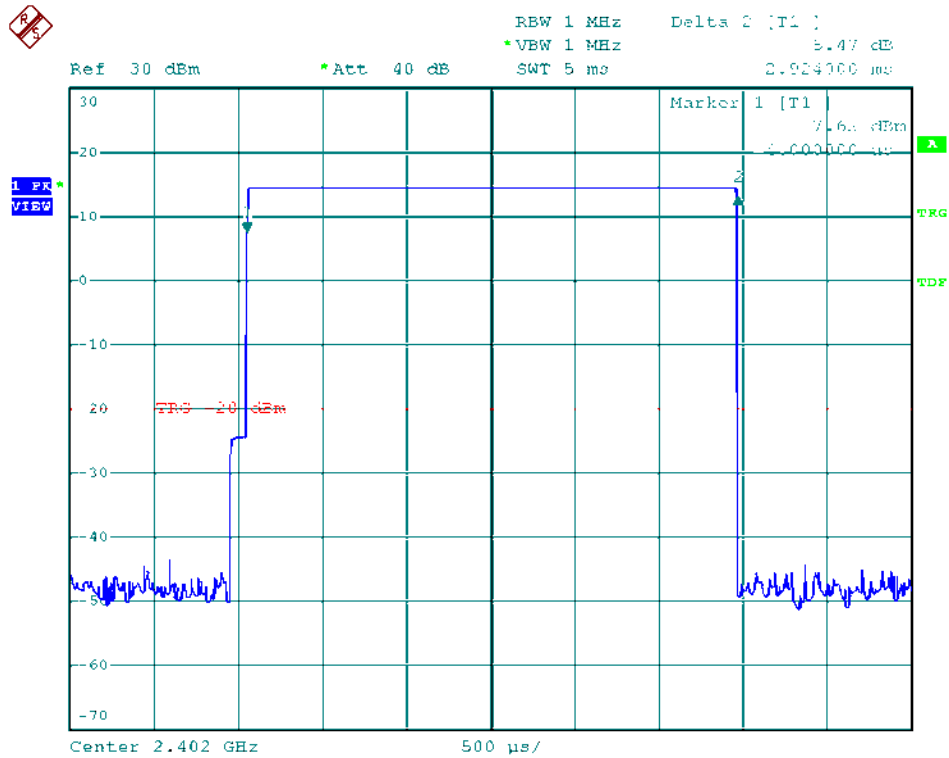

Modulation Standard: GFSK (1Mbps)  
Channel: 39, Rate: DH1

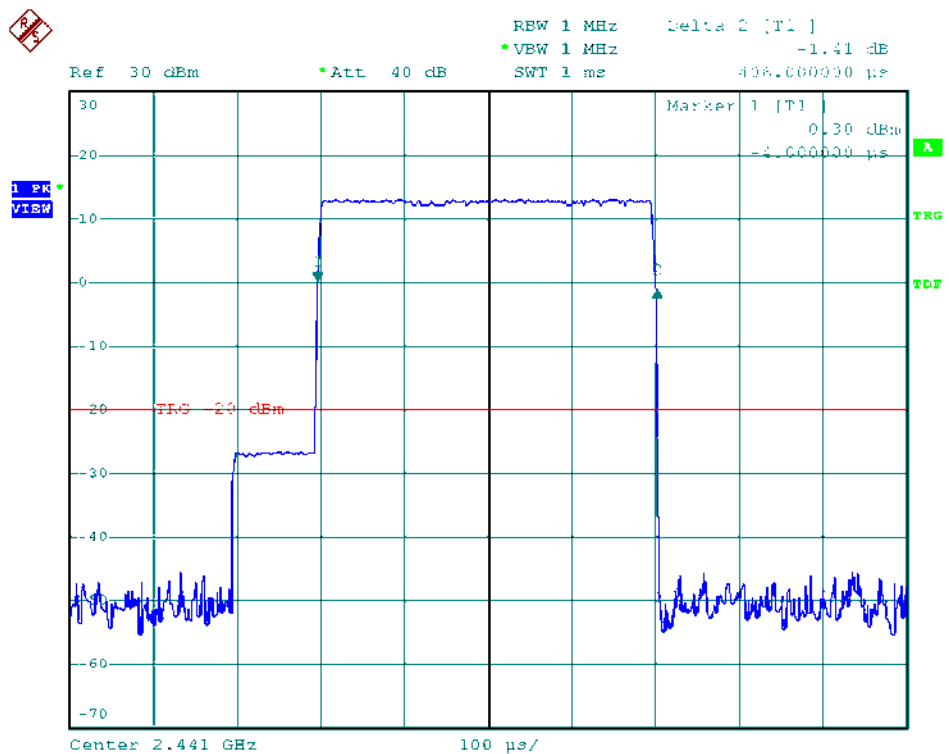



Modulation Standard: GFSK (1Mbps)  
Channel: 39, Rate: DH3

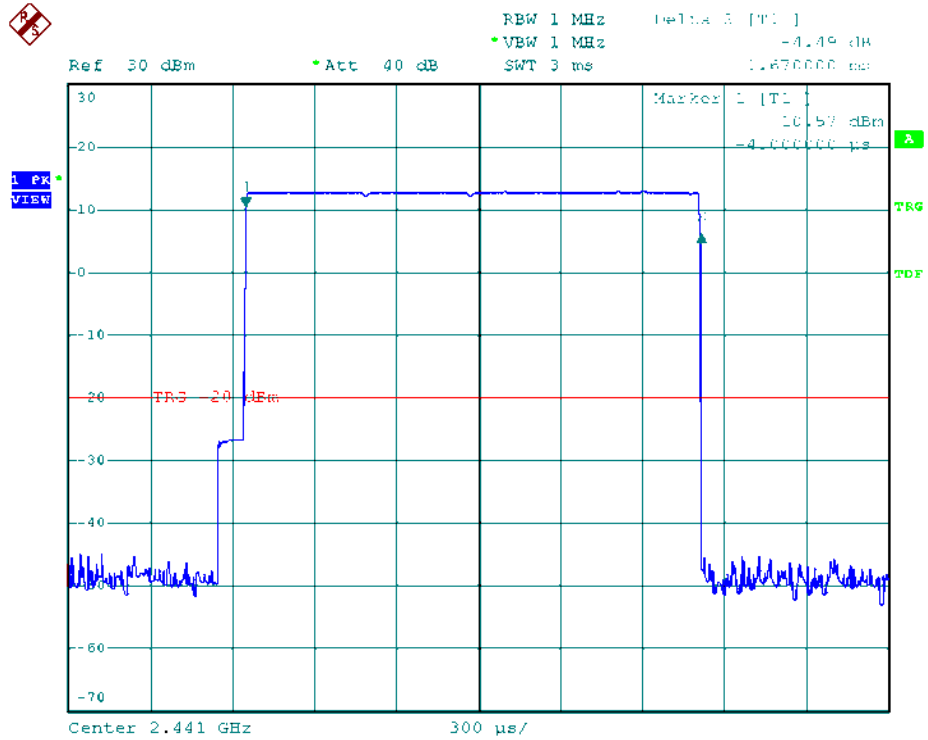

Modulation Standard: GFSK (1Mbps)  
Channel: 39, Rate: DH5

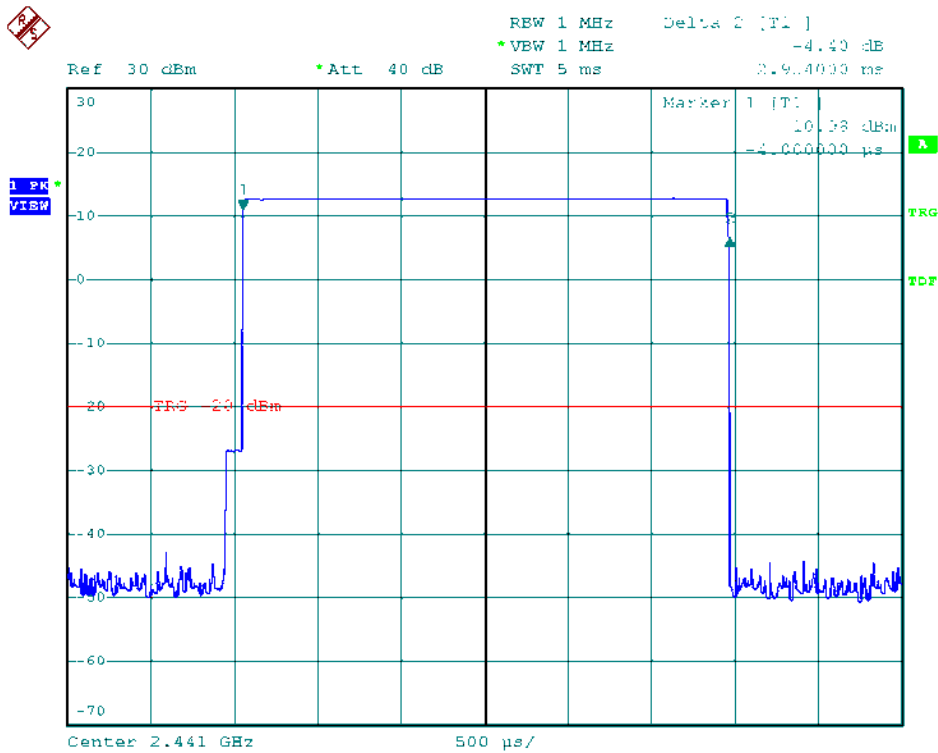



Modulation Standard: GFSK (1Mbps)  
Channel: 78, Rate: DH1

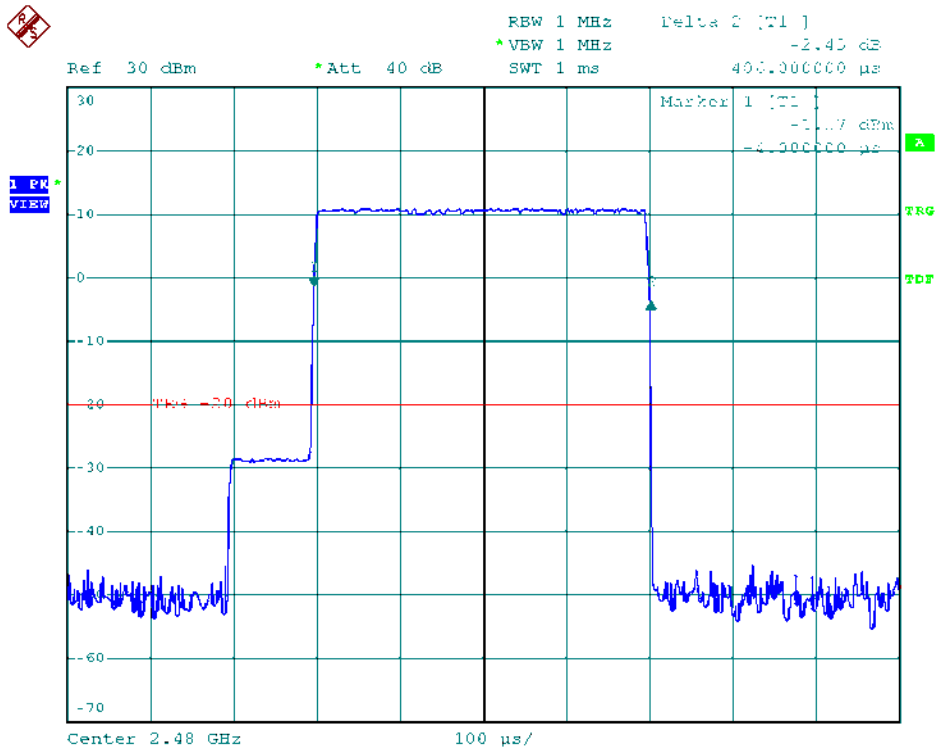

Modulation Standard: GFSK (1Mbps)  
Channel: 78, Rate: DH3

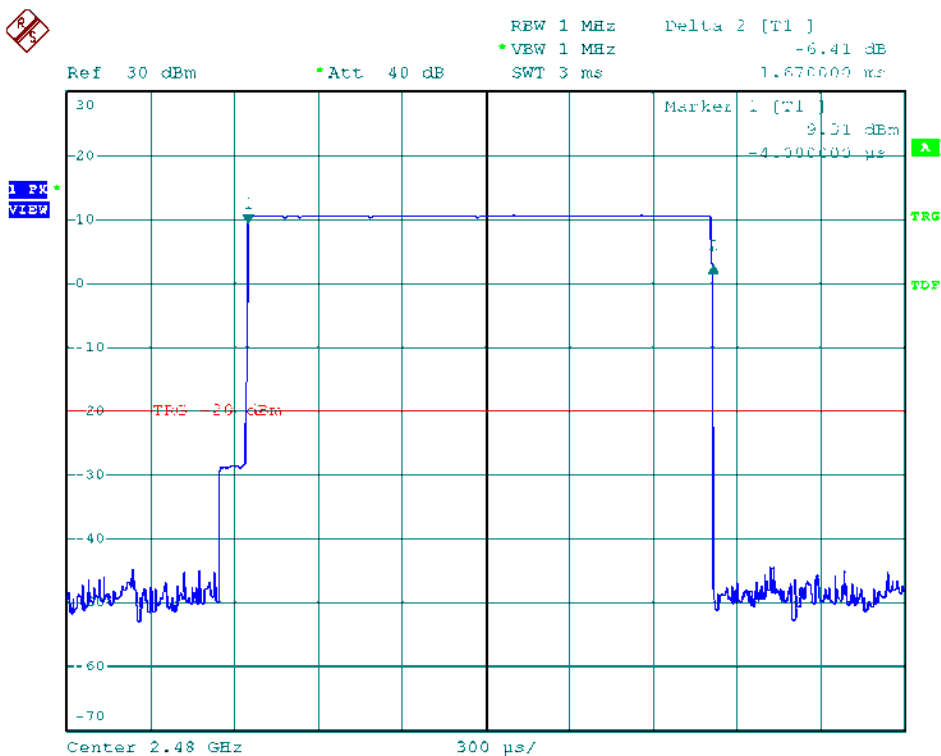



Modulation Standard: GFSK (1Mbps)  
Channel: 78, Rate: DH5

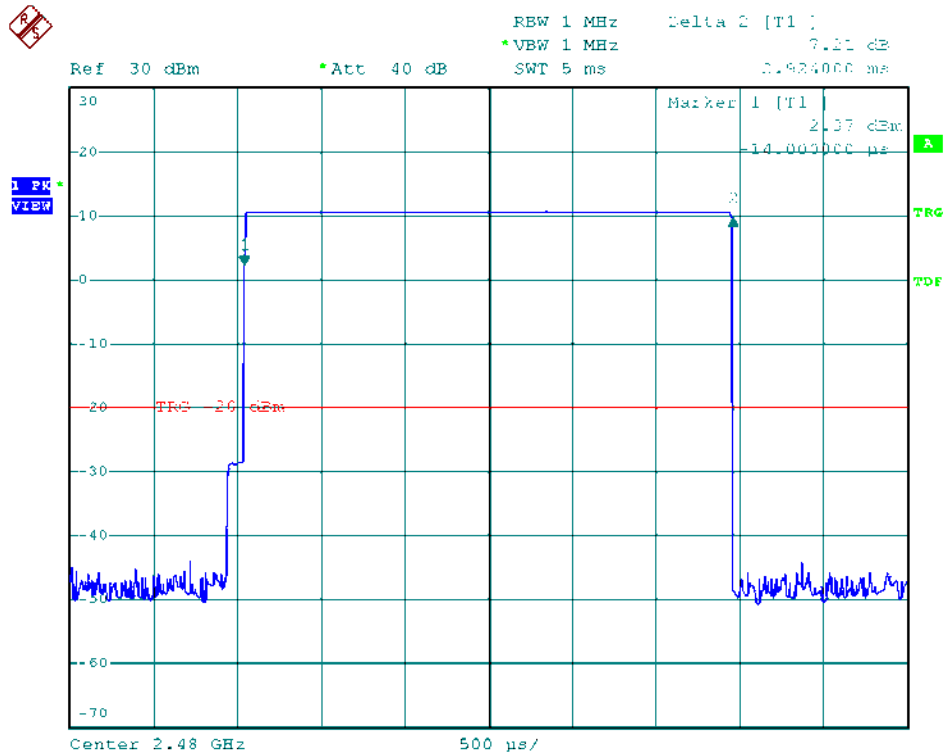

Modulation Standard:  $\pi/4$ -DQPSK (2Mbps)  
Channel: 00, Rate: 2DH5

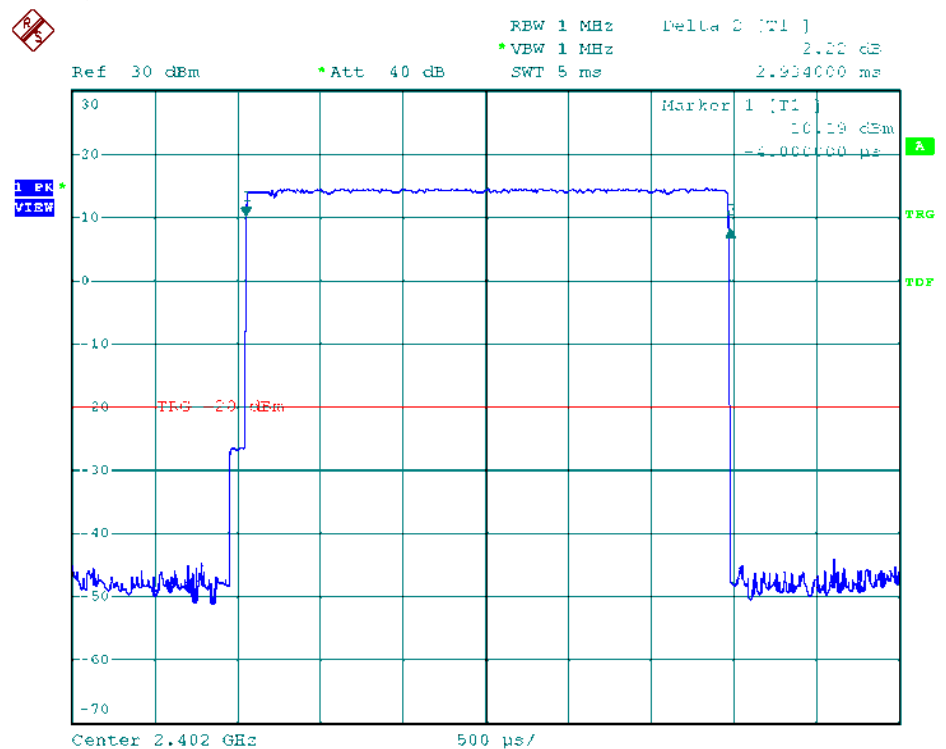



Modulation Standard:  $\pi/4$ -DQPSK (2Mbps)  
Channel: 39, Rate: 2DH5

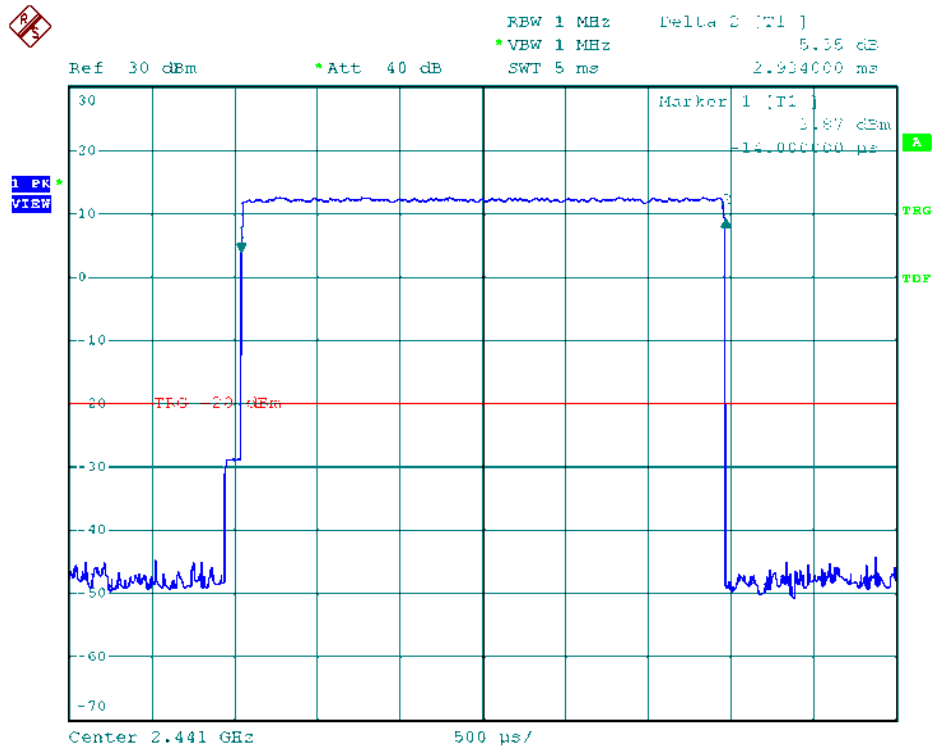

Modulation Standard:  $\pi/4$ -DQPSK (2Mbps)  
Channel: 78, Rate: 2DH5

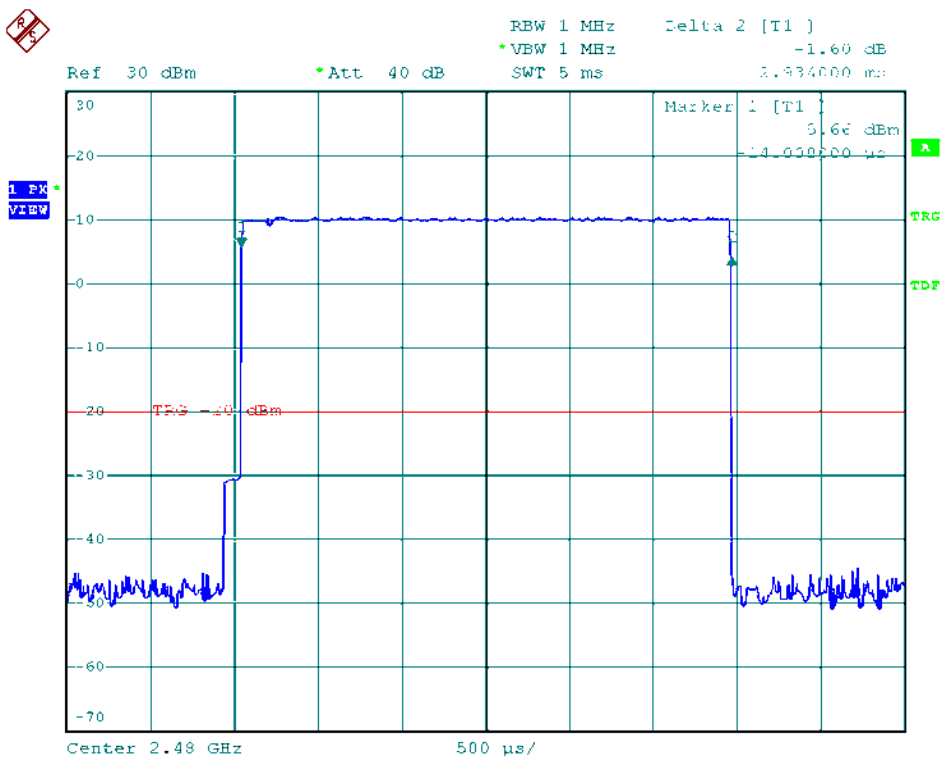



Modulation Standard: 8DPSK (3Mbps)  
Channel: 00, Rate: 3DH5

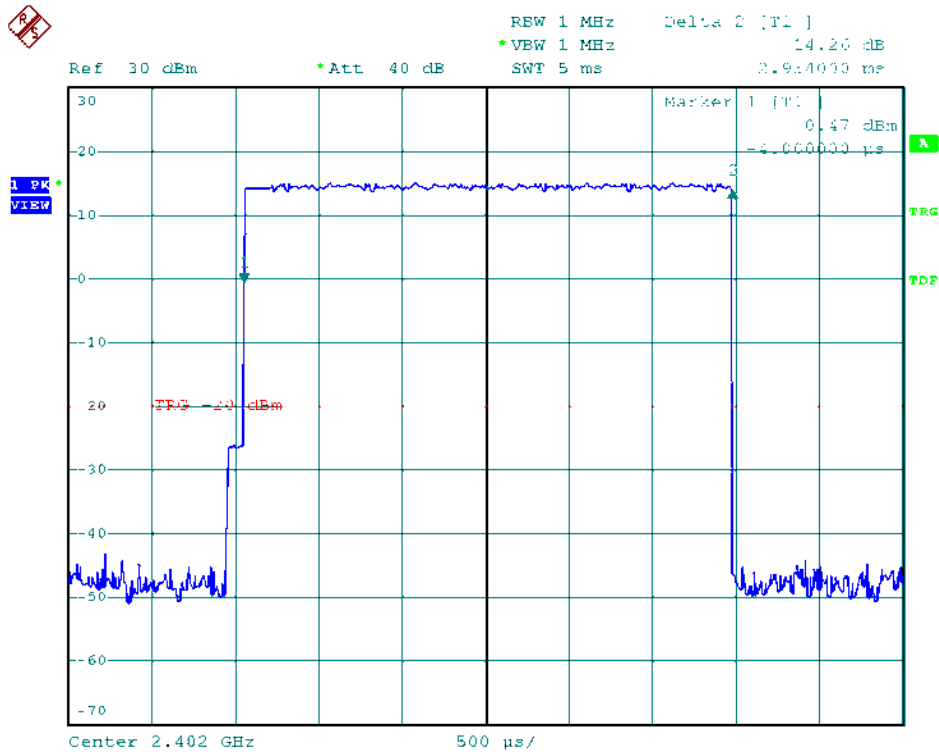

Modulation Standard: 8DPSK (3Mbps)  
Channel: 39, Rate: 3DH5

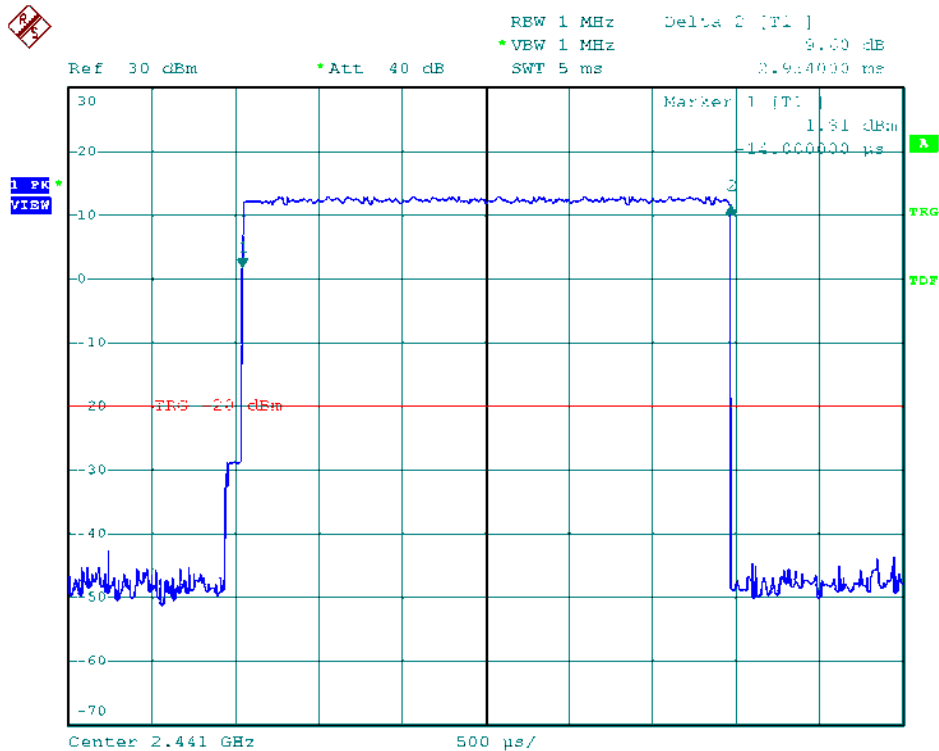





Modulation Standard: 8DPSK (3Mbps)  
Channel: 78, Rate: 3DH5

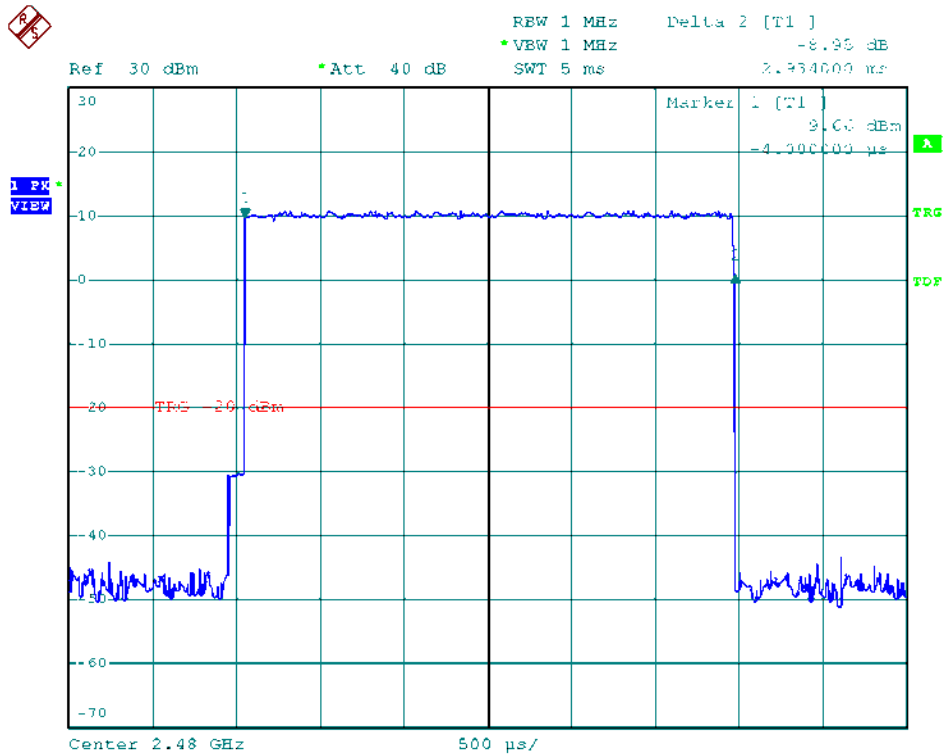



## 9. Number of Hopping Channels

### 9.1 Test Limit

Frequency hopping systems in the 2400 ~ 2483.5 MHz band shall use at least 15 channels.

### 9.2 Test Procedures

- a. The transmitter output was connected to the spectrum analyzer.
- b. 2. Set RBW of spectrum analyzer to 100 KHz and VBW to 100 KHz.
- c. 3. Set the MaxHold function, and then keep the EUT in hopping mode. Record all the signals from each channel until each one has been record.

### 9.3 Test Setup Layout

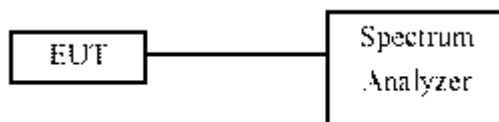

### 9.4 Measurement equipment

Instrument/Ancillary	Model No.	Manufacturer	Serial No.	Calibration Date	Valid Date
Spectrum Analyzer	R&S	FSP40	100219	2013/09/14	2014/09/13

### 9.5 Test Result and Data

Test Date: Apr. 30, 2014

Temperature: 24 °C

Atmospheric pressure: 1018 hPa

Humidity: 51 %

Modulation Type	Hopping Channels
GFSK (1Mbps)	79
$\pi/4$ -DQPSK (2Mbps)	79
8DPSK (3Mbps)	79



Modulation Standard: GFSK (1Mbps)

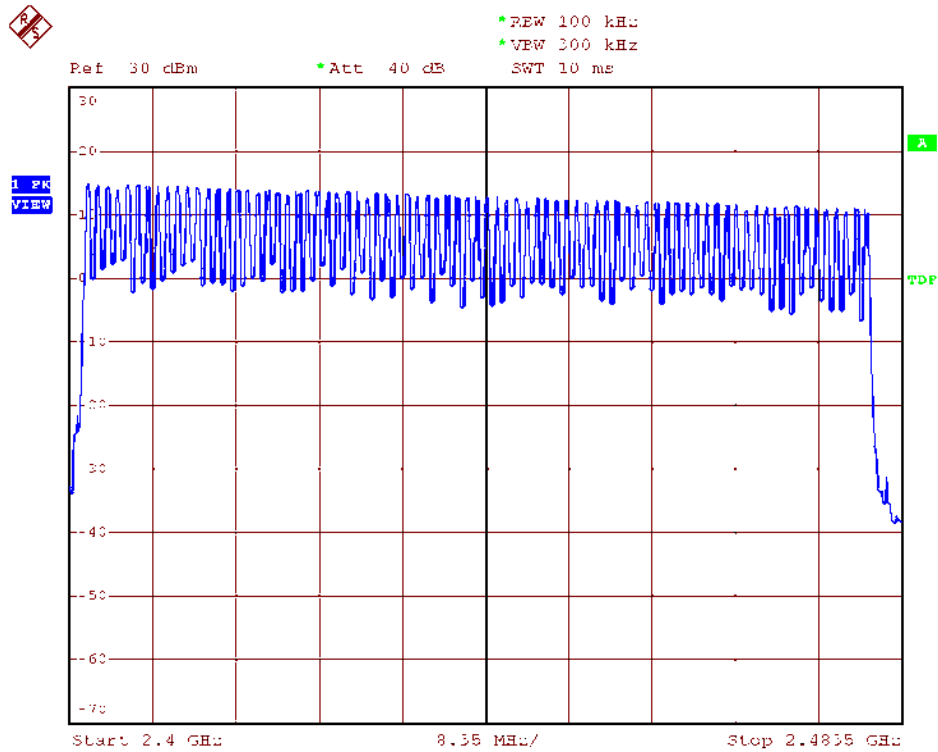

Modulation Standard:  $\pi/4$ -DQPSK (2Mbps)

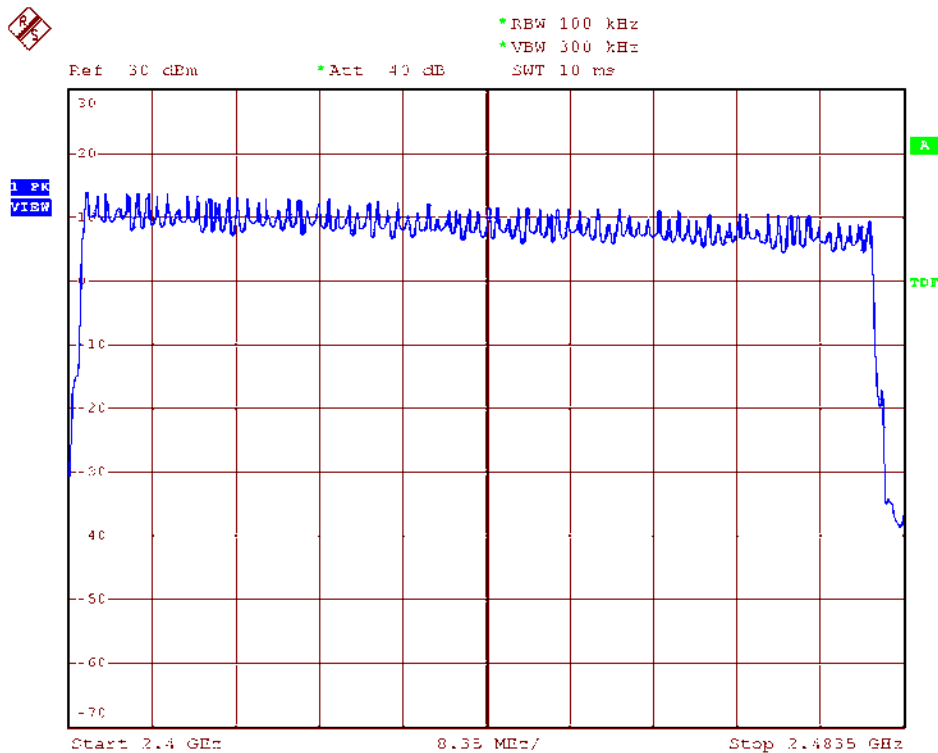



Modulation Standard: 8DPSK (3Mbps)

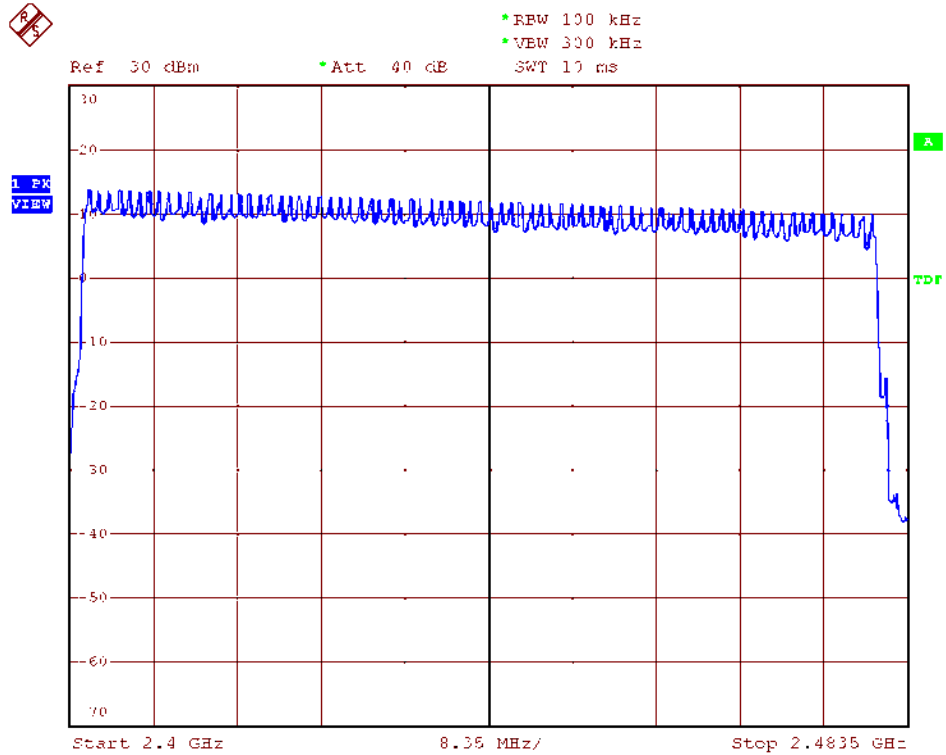



## 10. Maximum Peak Output Power

### 10.1 Test Limit

The Maximum Peak Output Power Measurement is 30dBm.

### 10.2 Test Procedures

The antenna port( RF output )of the EUT was connected to the input( RF input )of a power meter. Power was read directly from the meter and cable loss connection was added to the reading to obtain power at the EUT antenna terminal. The EUT Output Power was set to maximum to produce the worse case test result.

### 10.3 Test Setup Layout

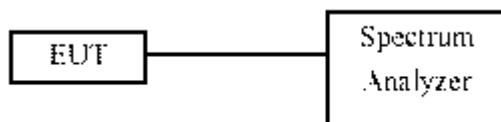

### 10.4 Measurement equipment

Instrument/Ancillary	Model No.	Manufacturer	Serial No.	Calibration Date	Valid Date
Spectrum Analyzer	R&S	FSP40	100219	2013/09/14	2014/09/13



### 10.5 Test Result and Data

Test Date: Apr. 30, 2014

Temperature: 24 °C

Atmospheric pressure: 1018 hPa

Humidity: 51 %

Modulation Type	Channel	Frequency (MHz)	Output Power (dBm)	Output Power (mW)
GFSK (1Mbps)	00	2402	14.09	25.64
	39	2441	14.15	26.00
	78	2480	14.00	25.12
$\pi/4$ -DQPSK (2Mbps)	00	2402	14.62	28.97
	39	2441	14.78	30.06
	78	2480	14.42	27.67
8DPSK (3Mbps)	00	2402	14.70	29.51
	39	2441	14.98	31.48
	78	2480	14.58	28.71



Modulation Standard: GFSK (1Mbps)  
Channel: 00

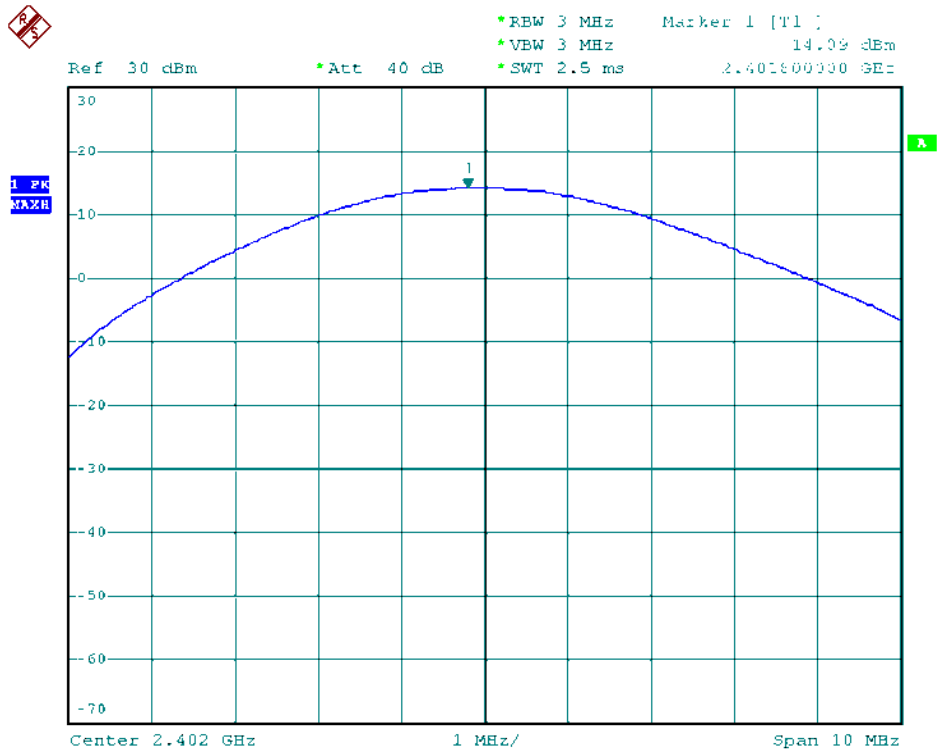

Modulation Standard: GFSK (1Mbps)  
Channel: 39

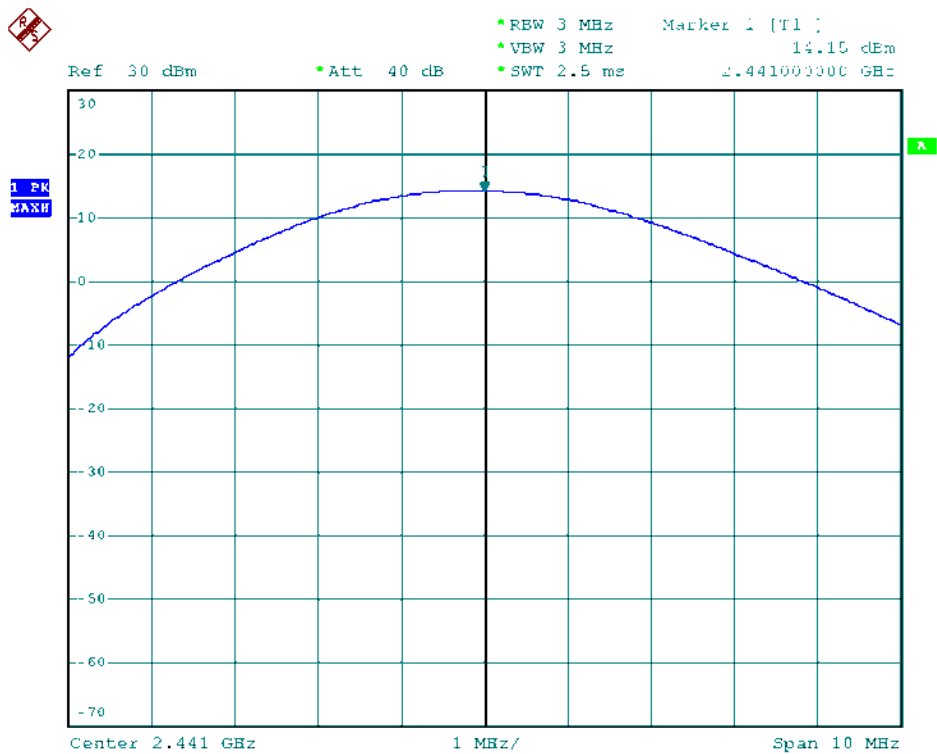





Modulation Standard: GFSK (1Mbps)  
Channel: 78

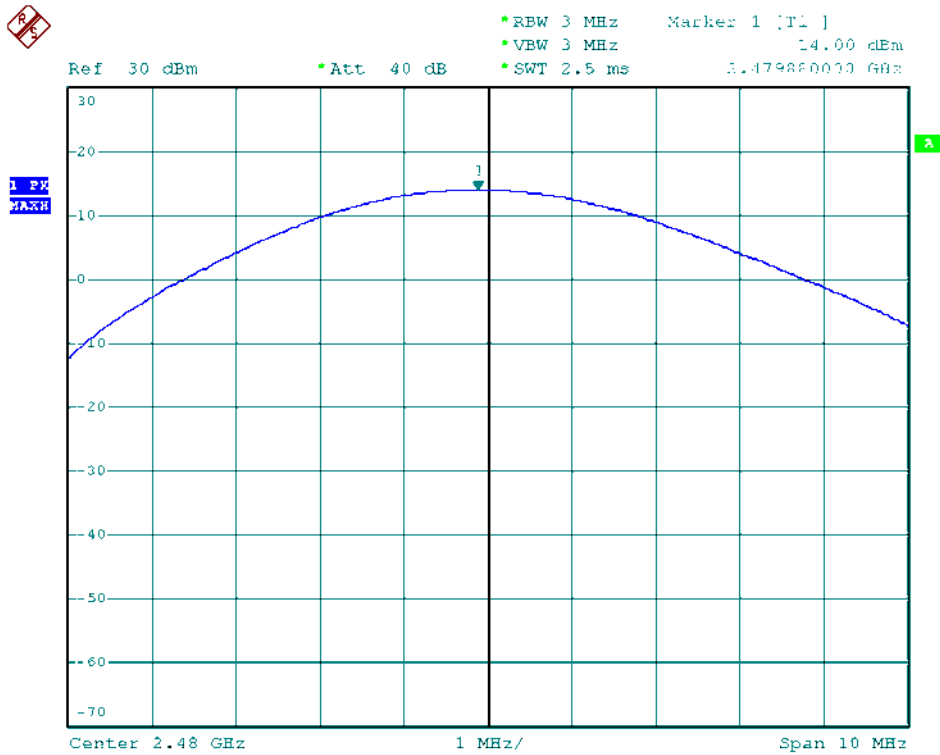

Modulation Standard:  $\pi/4$ -DQPSK (2Mbps)  
Channel: 00

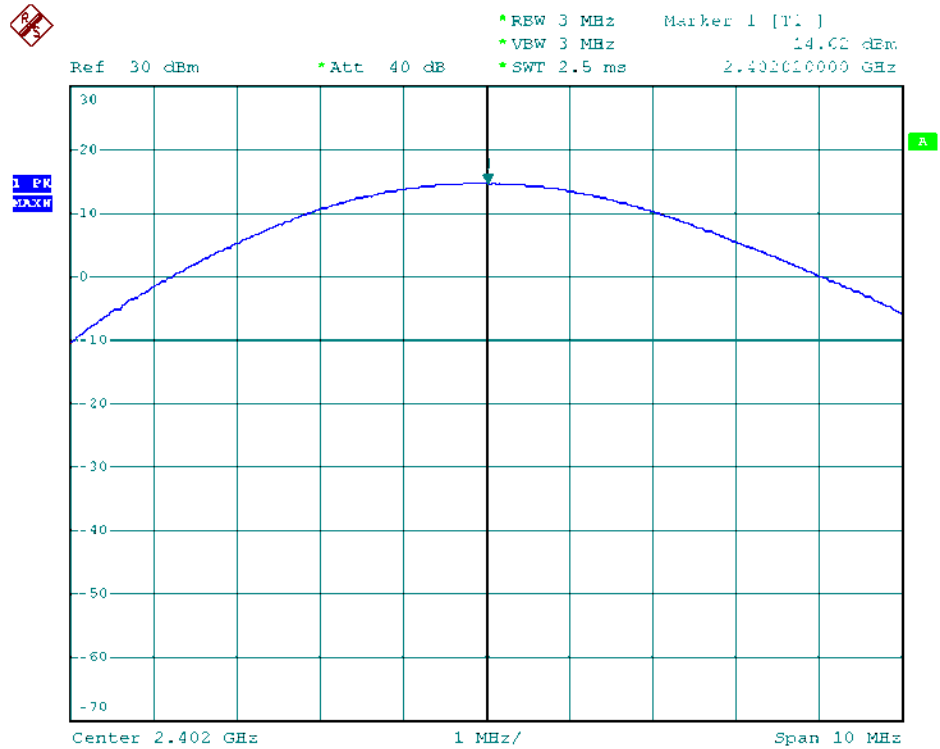



Modulation Standard:  $\pi/4$ -DQPSK (2Mbps)  
Channel: 39

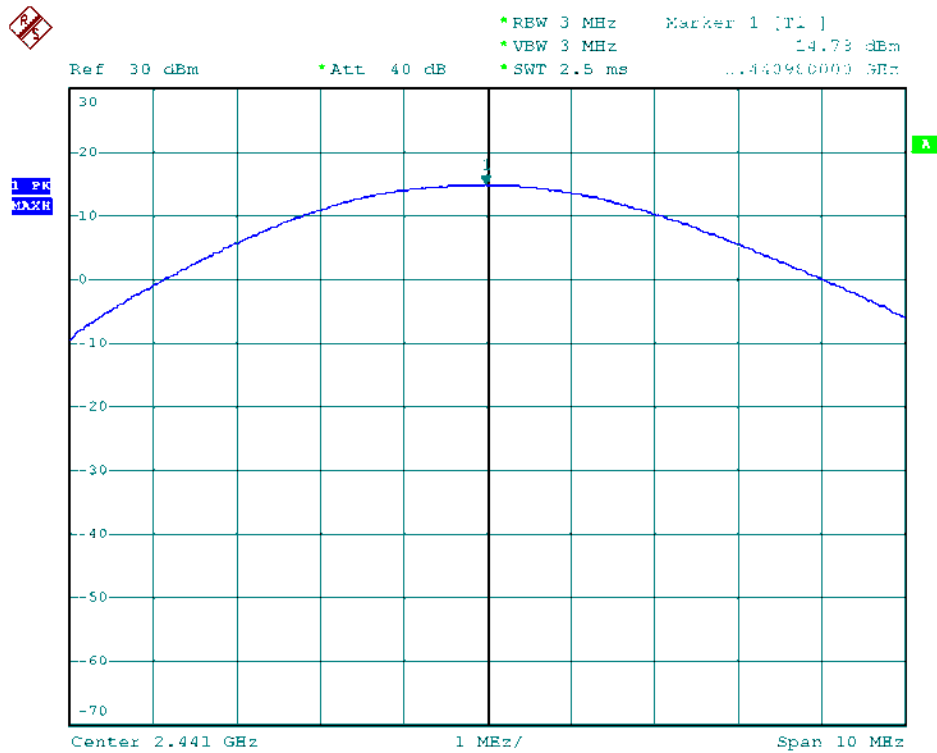

Modulation Standard:  $\pi/4$ -DQPSK (2Mbps)  
Channel: 78

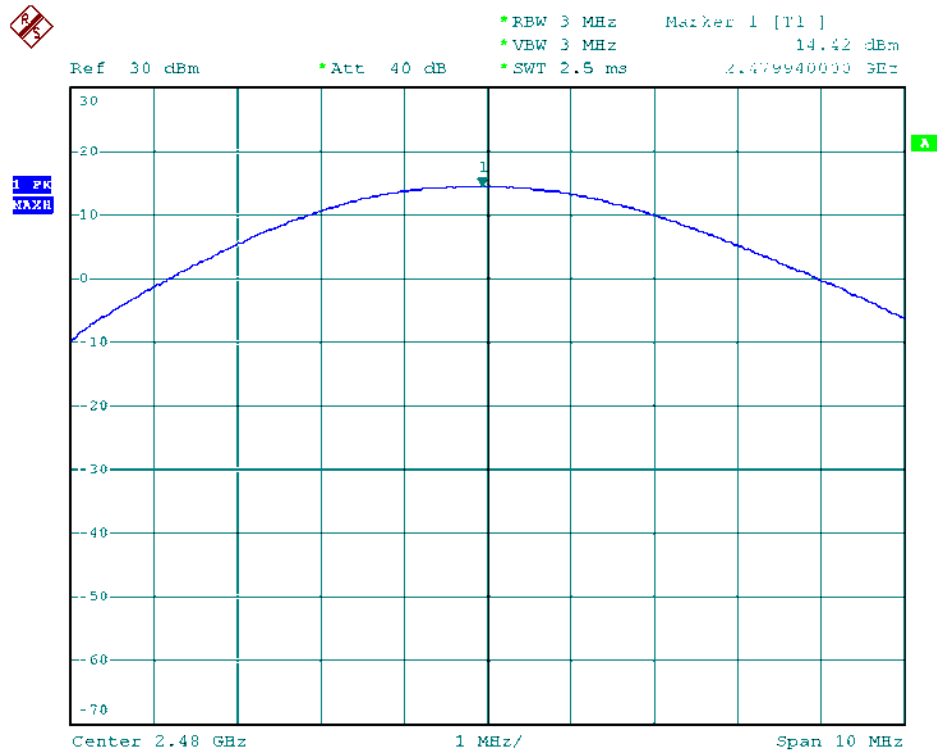



Modulation Standard: 8DPSK (3Mbps)  
Channel: 00

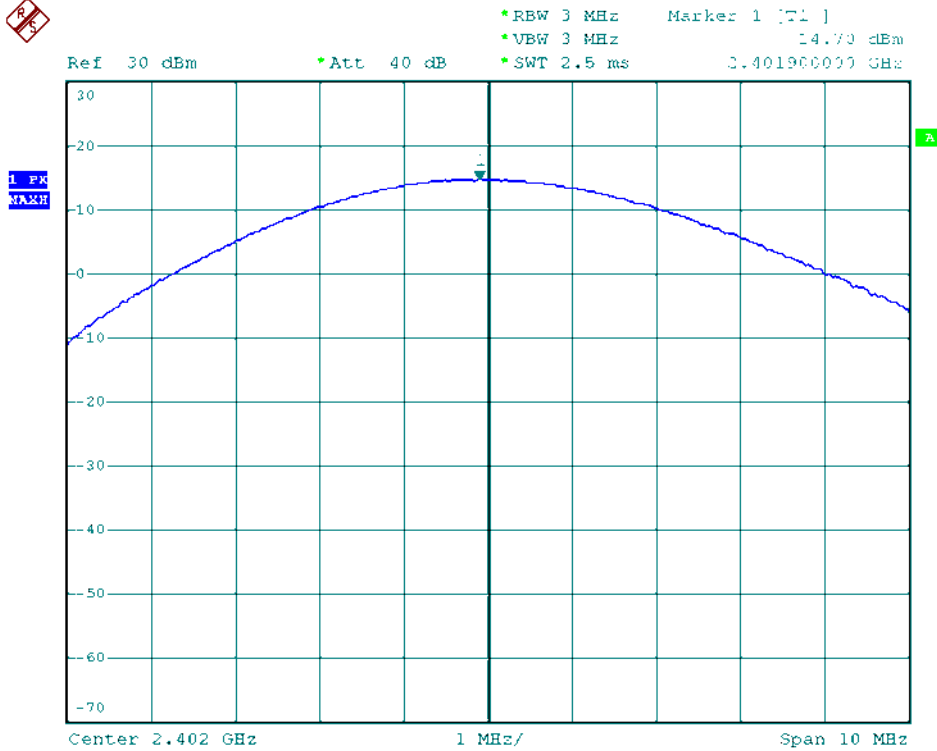

Modulation Standard: 8DPSK (3Mbps)  
Channel: 39

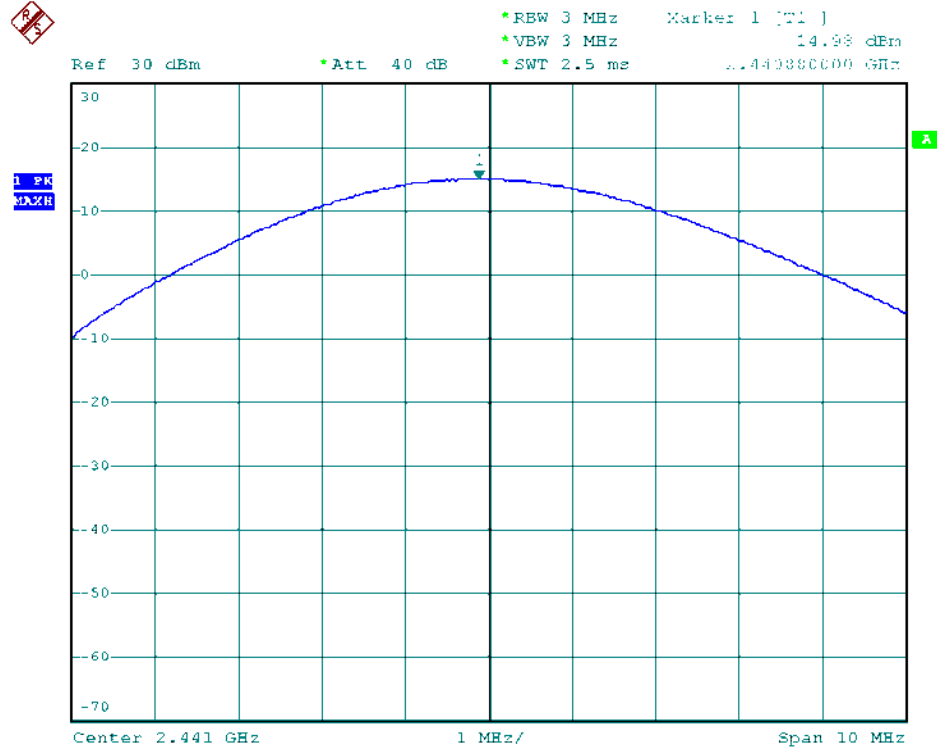



Modulation Standard: 8DPSK (3Mbps)  
Channel: 78



RBW 3 MHz    Marker 1 (01)  
VBW 3 MHz    14.58 dBm  
SWT 2.5 ms    2.470880000 GHz

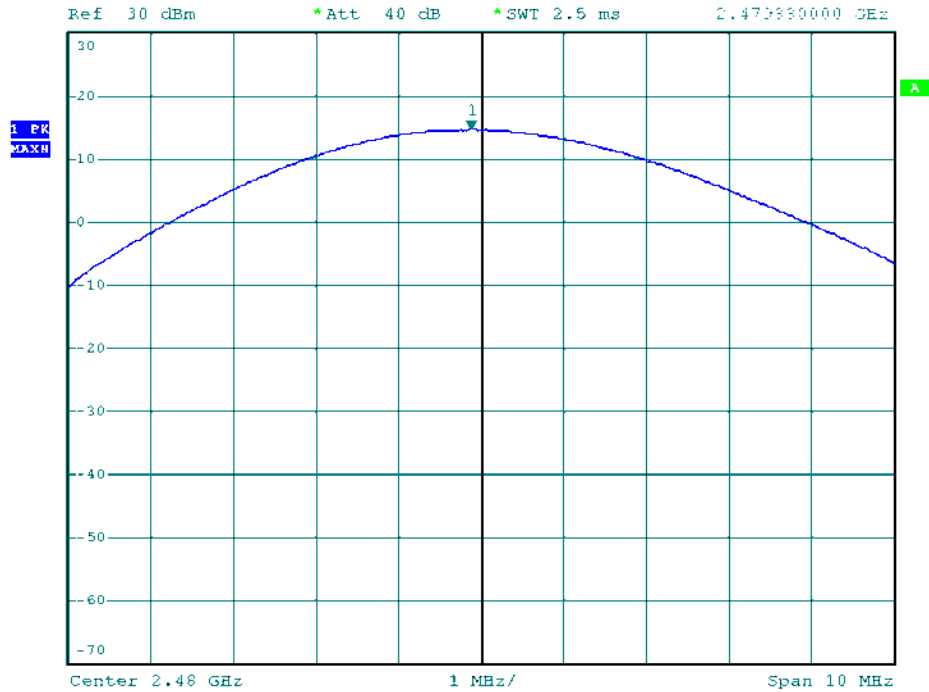



## 11. Band Edges Measurement

### 11.1 Test Limit

Below -20dB of the highest emission level of operating band (in 100kHz Resolution Bandwidth).

### 11.2 Test Procedure

- The transmitter output was connected to the spectrum analyzer via a low lose cable.
- Set both RBW and VBW of spectrum analyzer to 100 KHz with convenient frequency span including 100 KHz bandwidth from band edge.
- The band edges was measured and recorded.

### 11.3 Test Setup Layout

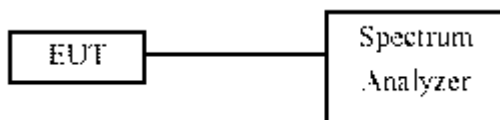

### 11.4 List of Measuring Equipment Used

Instrument/Ancillary	Model No.	Manufacturer	Serial No.	Calibration Date	Valid Date
Spectrum Analyzer	R&S	FSP40	100219	2013/09/14	2014/09/13

### 11.5 Test Result and Data

Test Date: Apr. 30, 2014

Temperature: 24 °C

Atmospheric pressure: 1018 hPa

Humidity: 51 %

Modulation Type	Channel	Frequency	Max. Value in frequency(MHz)	Max. Value (dBm)
GFSK (1Mbps)	00	2402	2399.60	-25.40
	78	2480	2484.90	-45.48
$\pi/4$ -DQPSK (2Mbps)	00	2402	2399.80	-28.16
	78	2480	2483.50	-45.93
8DPSK (3Mbps)	00	2402	2399.80	-28.21
	78	2480	2483.50	-43.40



Modulation Standard: GFSK (1Mbps)  
Channel: 00

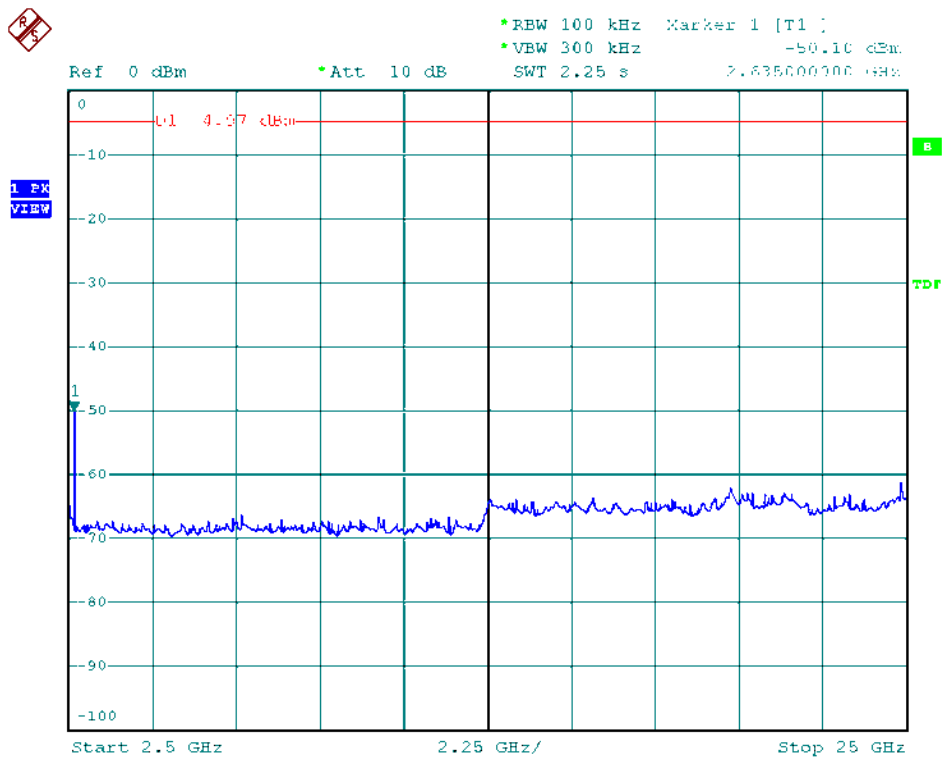
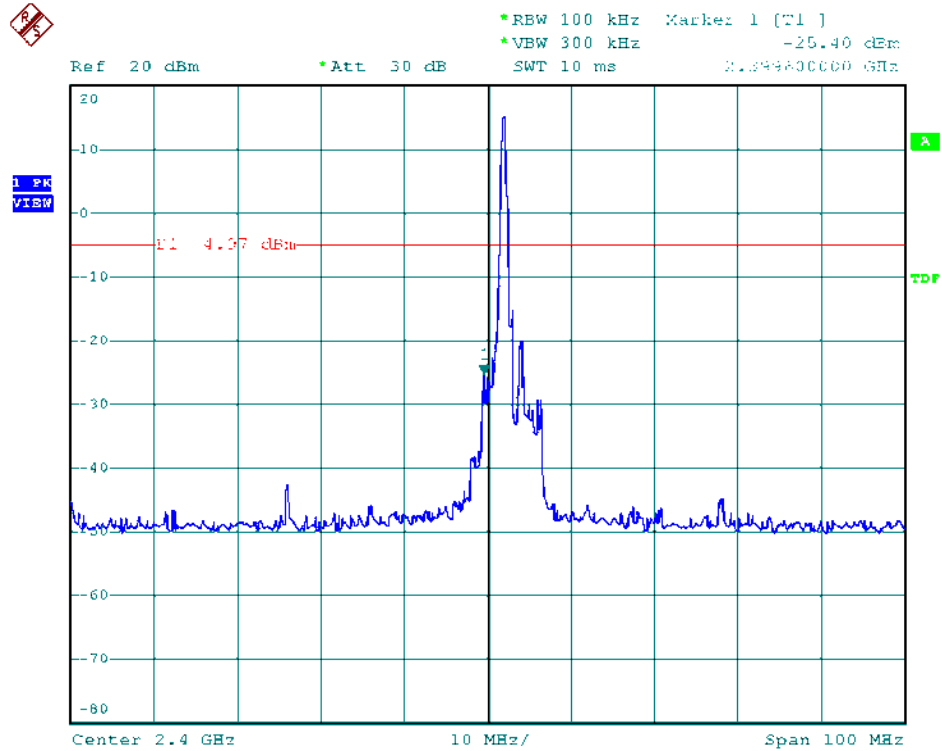



Modulation Standard: GFSK (1Mbps)  
Channel: 78

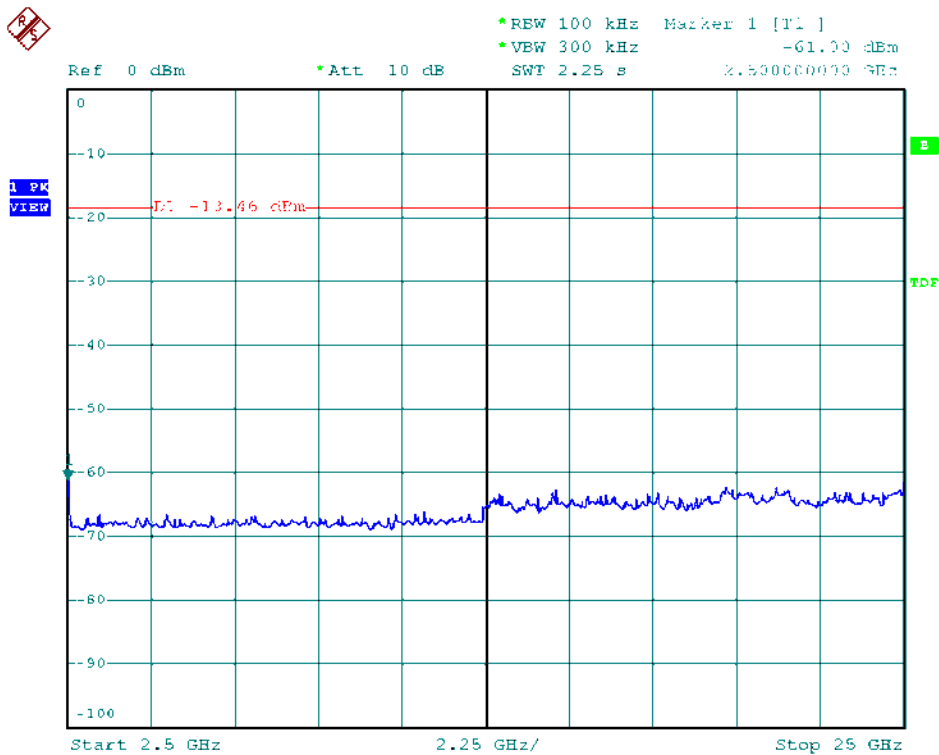
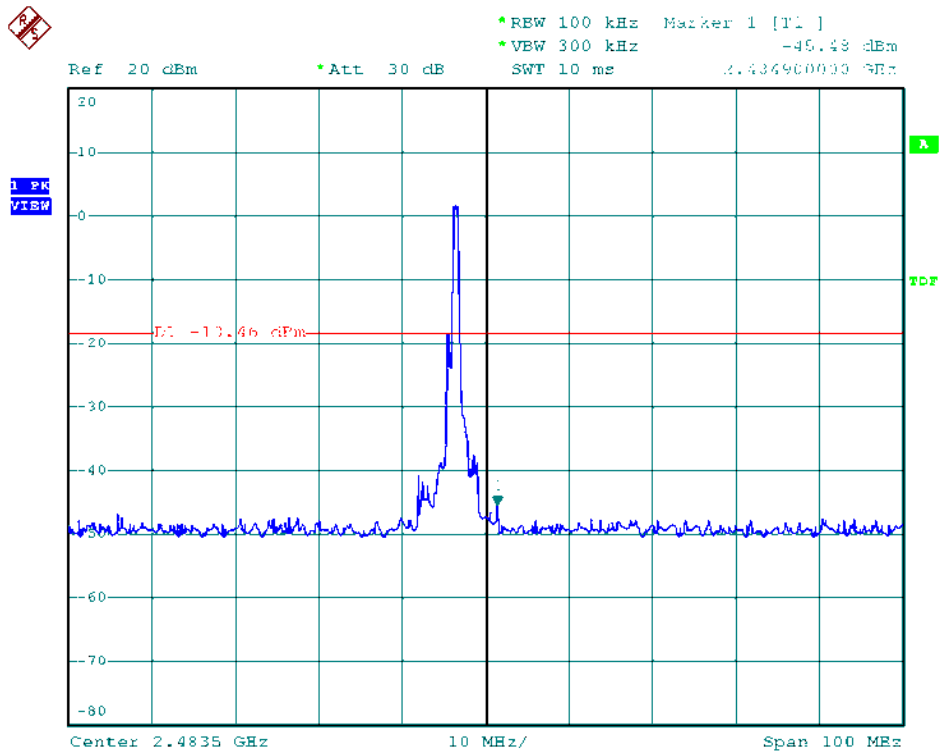





Modulation Standard:  $\pi/4$ -DQPSK (2Mbps)  
Channel: 00

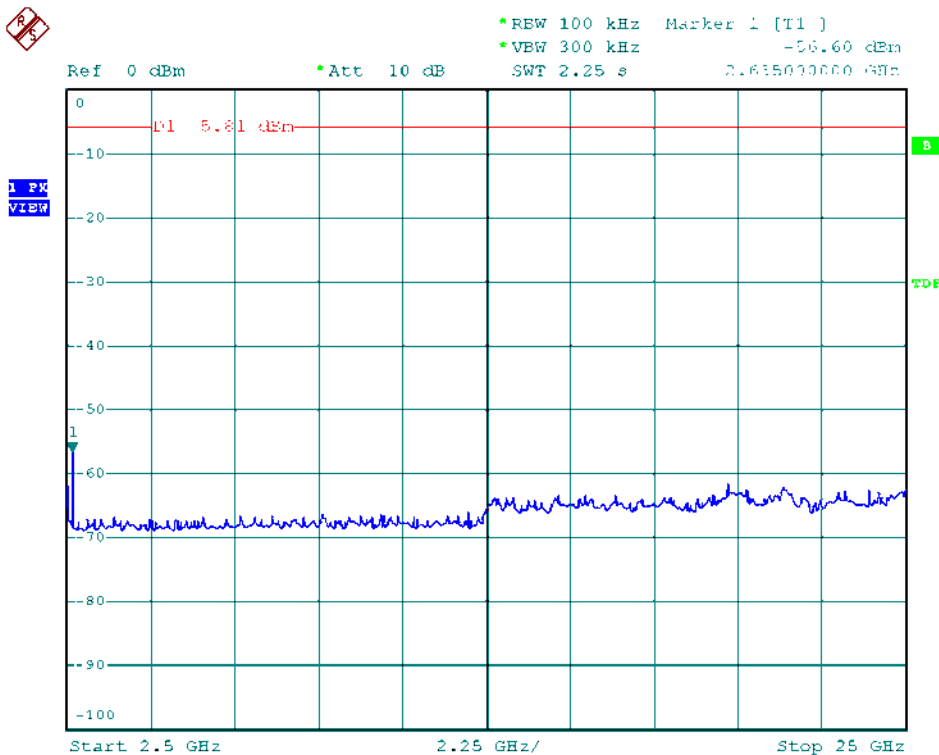
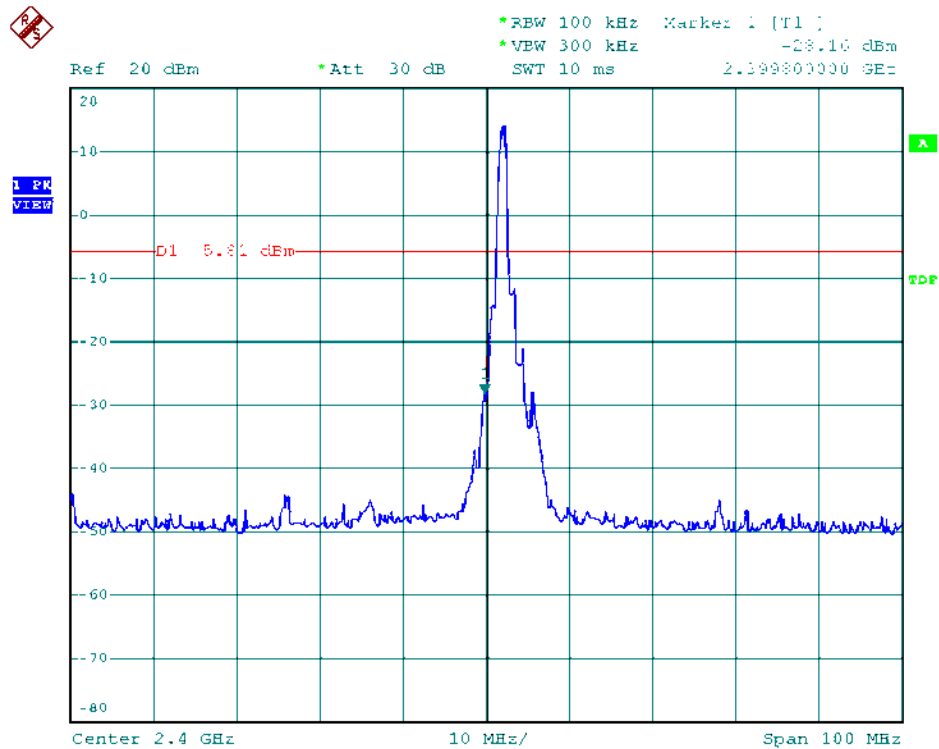



Modulation Standard:  $\pi/4$ -DQPSK (2Mbps)  
Channel: 78

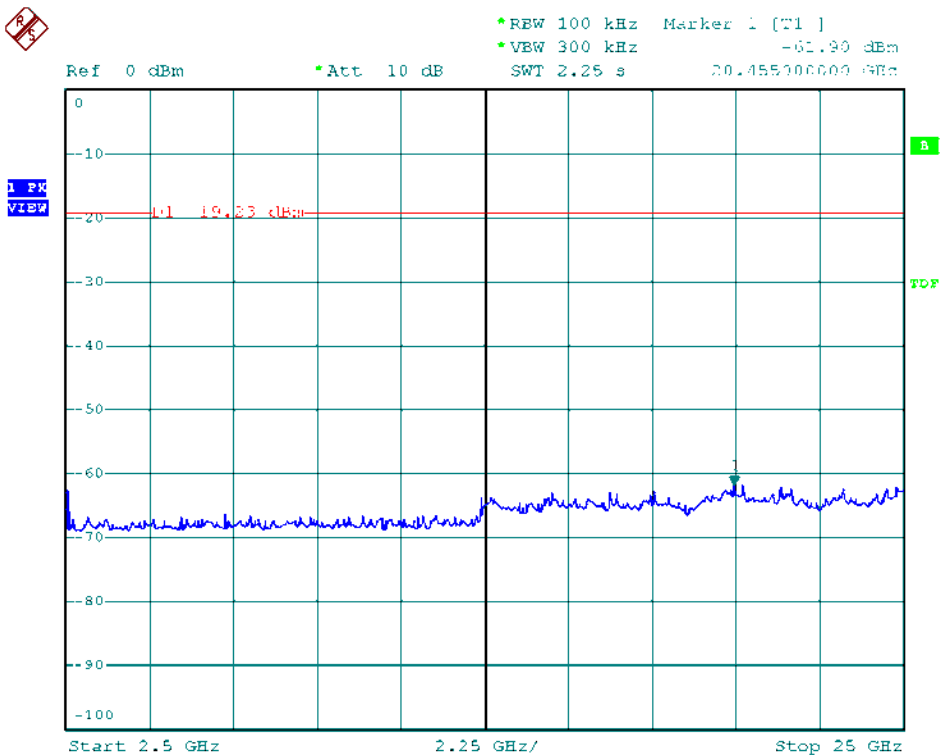
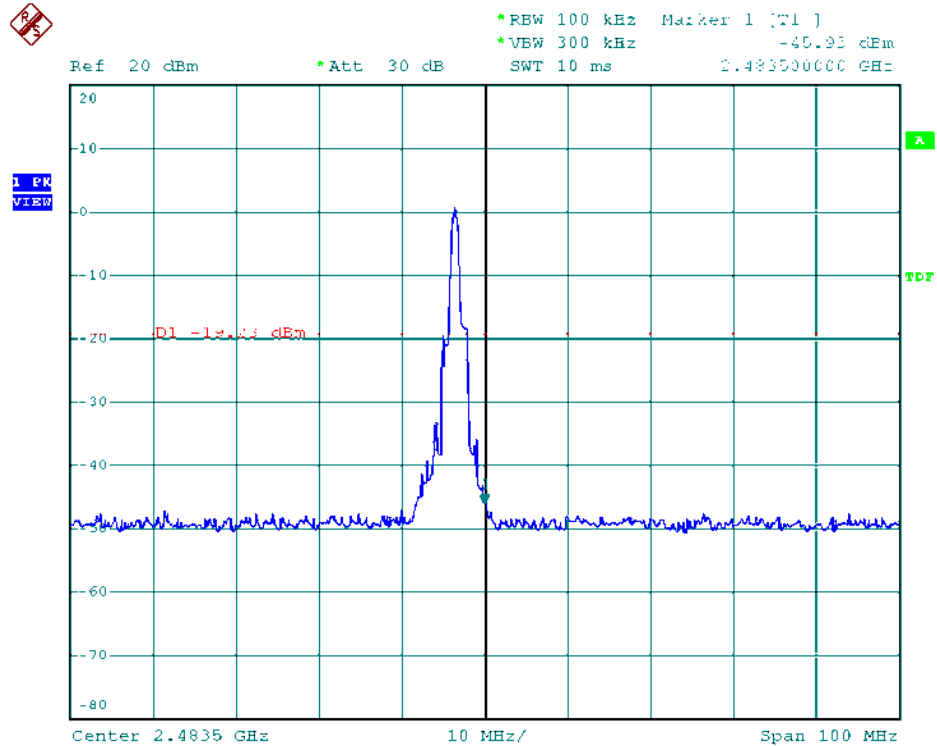



Modulation Standard: 8DPSK (3Mbps)  
Channel: 00

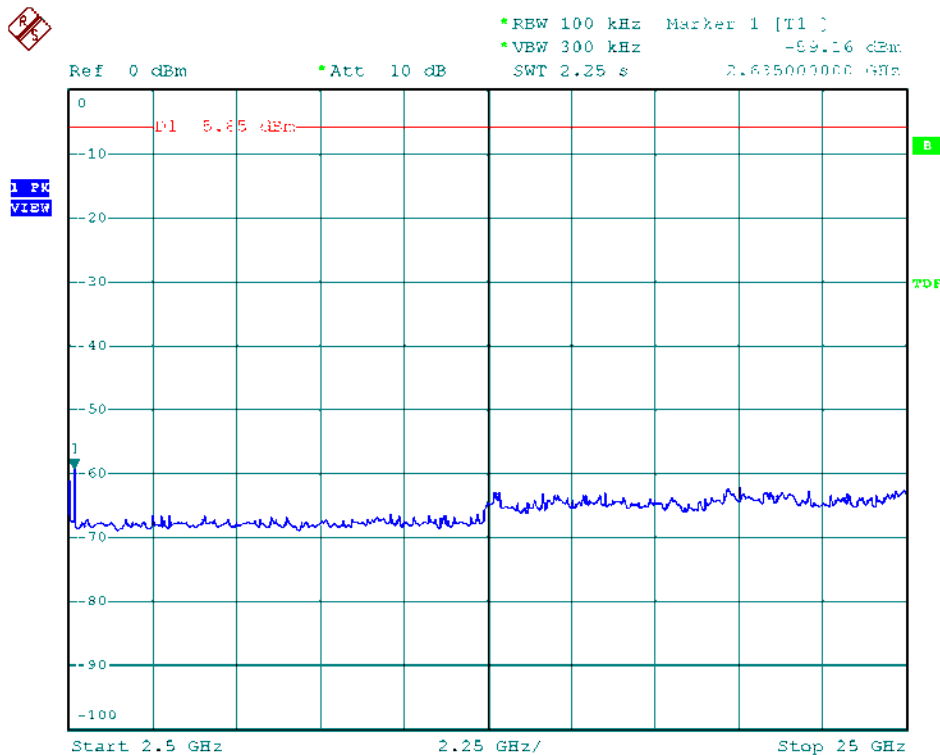
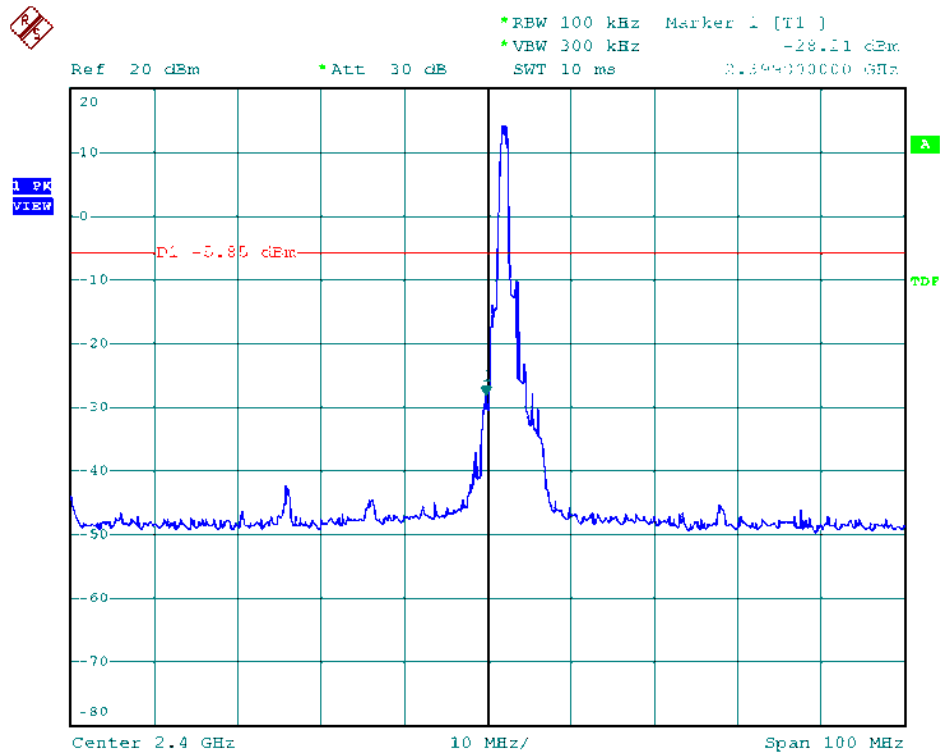



Modulation Standard: 8DPSK (3Mbps)  
Channel: 78

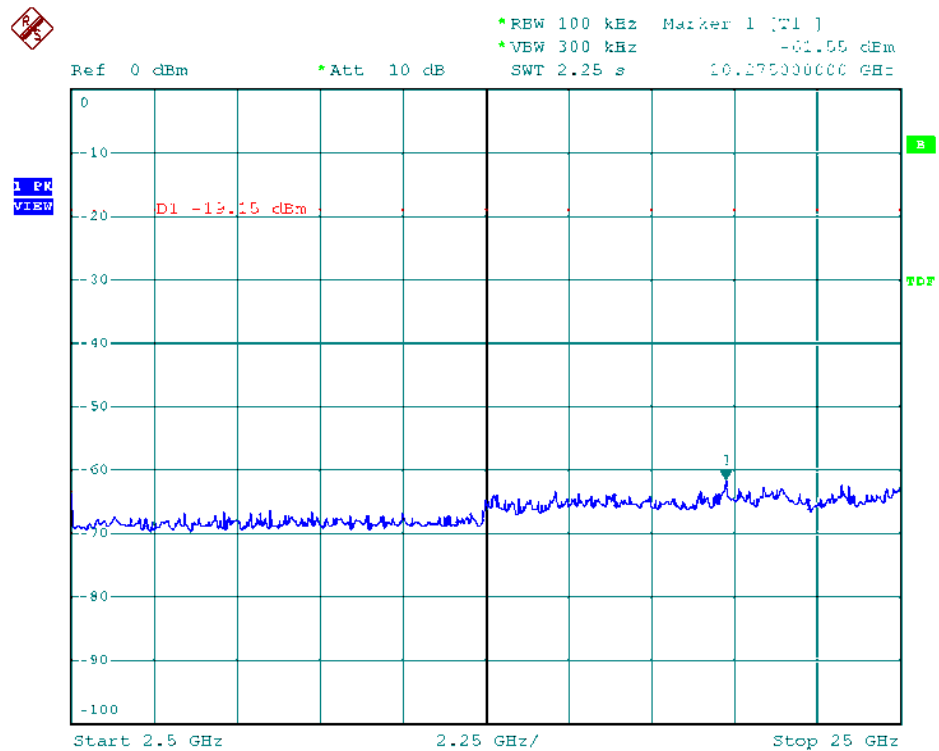
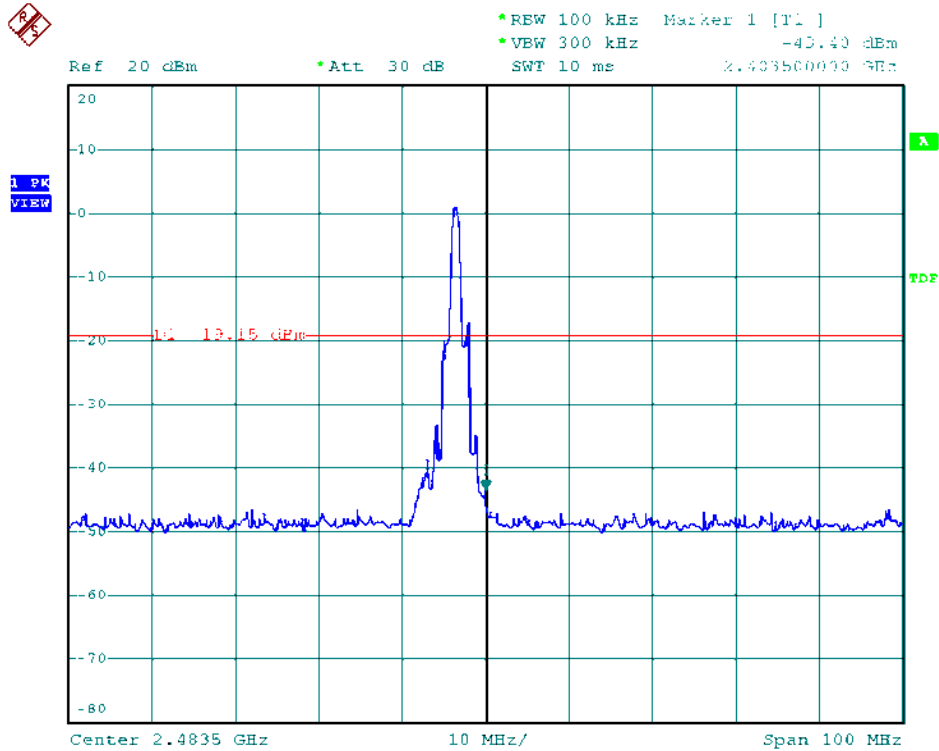

**11.6 Restrict band emission Measurement Data**

Test Date: Apr. 14, 2014

Temperature: 24 °C

Atmospheric pressure: 1018 hPa

Humidity: 51 %

Modulation Standard: GFSK (1Mbps)

Channel 0						Fundamental Frequency: 2402 MHz				
Frequency (MHz)	Ant-Pol H/V	Meter Reading	Corrected Factor	Result (dBuV/m)	Remark	Limit@3m (dBuV/m)		Margin (dB)	Table (Deg.)	Ant High (m)
						Peak	Ave.			
2356.74	H	58.34	2.32	60.66	Peak	74	54	-13.34	114	1.00
2389.81	H	46.35	2.46	48.61	Ave	74	54	-5.19	113	1.00
2370.54	V	58.22	2.38	60.60	Peak	74	54	-13.40	131	1.00
2389.81	V	46.36	2.46	48.82	Ave	74	54	-5.16	130	1.00
Channel 78						Fundamental Frequency: 2480 MHz				
2487.09	H	59.09	2.84	61.93	Peak	74	54	-12.07	106	1.00
2483.52	H	46.79	2.83	49.62	Ave	74	54	-4.38	106	1.00
2491.98	V	61.57	2.65	64.42	Peak	74	54	-9.58	130	1.00
2483.52	V	46.71	2.83	49.54	Ave	74	54	-4.46	129	1.00

## Notes:

1. Result = Meter Reading + Factor
2. Factor = Antenna Factor + Cable Loss – Amplifier
3. The resolution bandwidth of test receiver/spectrum analyzer is 1 MHz and video bandwidth is 3 MHz for Peak detection at frequency above 1GHz.
4. The resolution bandwidth of test receiver/spectrum analyzer is 1MHz and video bandwidth is 10Hz for Average detection at frequency above 1GHz



Test Date: Apr. 14, 2014

Temperature: 24 °C

Atmospheric pressure: 1018 hPa

Humidity: 51 %

Modulation Standard:  $\pi/4$ -DQPSK (2Mbps)

Channel 0						Fundamental Frequency: 2402 MHz				
Frequency (MHz)	Ant-Pol H/V	Meter Reading	Corrected Factor	Result (dBuV/m)	Remark	Limit@3m (dBuV/m)		Margin (dB)	Table (Deg.)	Ant High (m)
						Peak	Ave.			
2361.70	H	58.44	2.34	60.78	Peak	74	54	-13.22	121	1.00
2389.81	H	46.40	2.46	48.86	Ave	74	54	-5.14	121	1.00
2330.70	V	58.73	2.22	60.95	Peak	74	54	-13.05	137	1.00
2389.81	V	46.40	2.46	48.86	Ave	74	54	-5.14	136	1.00
Channel 78						Fundamental Frequency: 2480 MHz				
2484.25	H	58.93	2.83	61.76	Peak	74	54	-12.24	107	1.00
2483.52	H	46.78	2.83	49.61	Ave	74	54	-4.39	107	1.00
2489.61	V	62.36	2.65	65.21	Peak	74	54	-8.79	134	1.00
2483.52	V	46.65	2.83	49.48	Ave	74	54	-4.52	134	1.00

## Notes:

1. Result = Meter Reading + Factor
2. Factor = Antenna Factor + Cable Loss – Amplifier
3. The resolution bandwidth of test receiver/spectrum analyzer is 1 MHz and video bandwidth is 3 MHz for Peak detection at frequency above 1GHz.
4. The resolution bandwidth of test receiver/spectrum analyzer is 1MHz and video bandwidth is 10Hz for Average detection at frequency above 1GHz



Test Date: Apr. 14, 2014

Temperature: 24 °C

Atmospheric pressure: 1018 hPa

Humidity: 51 %

Modulation Standard: 8DPSK (3Mbps)

Channel 0						Fundamental Frequency: 2402 MHz				
Frequency (MHz)	Ant-Pol H/V	Meter Reading	Corrected Factor	Result (dBuV/m)	Remark	Limit@3m (dBuV/m)		Margin (dB)	Table (Deg.)	Ant High (m)
						Peak	Ave.			
2357.84	H	58.17	2.34	60.51	Peak	74	54	-13.49	119	1.00
2389.81	H	46.35	2.46	48.81	Ave	74	54	-5.19	119	1.00
2357.84	V	58.43	2.34	60.77	Peak	74	54	-13.23	130	1.00
2389.81	V	46.35	2.46	48.81	Ave	74	54	-5.19	129	1.00
Channel 78						Fundamental Frequency: 2480 MHz				
2490.30	H	58.52	2.85	61.37	Peak	74	54	-12.63	108	1.00
2483.52	H	46.77	2.83	49.60	Ave	74	54	-4.40	108	1.00
2499.12	V	62.13	2.89	65.02	Peak	74	54	-8.98	132	1.00
2483.52	V	46.65	2.83	49.48	Ave	74	54	-4.52	132	1.00

Notes:

1. Result = Meter Reading + Factor
2. Factor = Antenna Factor + Cable Loss – Amplifier
3. The resolution bandwidth of test receiver/spectrum analyzer is 1 MHz and video bandwidth is 3 MHz for Peak detection at frequency above 1GHz.
4. The resolution bandwidth of test receiver/spectrum analyzer is 1MHz and video bandwidth is 10Hz for Average detection at frequency above 1GHz



## 12. Restricted Bands of Operation

Only spurious emissions are permitted in any of the frequency bands listed below:

MHz	MHz	MHz	GHz
0.09000 – 0.11000	16.42000 – 16.42300	399.9 – 410.0	4.500 – 5.250
0.49500 – 0.505**	16.69475 – 16.69525	608.0 – 614.0	5.350 – 5.460
2.17350 – 2.19050	16.80425 – 16.80475	960.0 – 1240.0	7.250 – 7.750
4.12500 – 4.12800	25.50000 – 25.67000	1300.0 – 1427.0	8.025 – 8.500
4.17725 – 4.17775	37.50000 – 38.25000	1435.0 – 1626.5	9.000 – 9.200
4.20725 – 4.20775	73.00000 – 74.60000	1645.5 – 1646.5	9.300 – 9.500
6.21500 – 6.21800	74.80000 – 75.20000	1660.0 – 1710.0	10.600 – 12.700
6.26775 – 6.26825	108.00000 – 121.94000	1718.8 – 1722.2	13.250 – 13.400
6.31175 – 6.31225	123.00000 – 138.00000	2200.0 – 2300.0	14.470 – 14.500
8.29100 – 8.29400	149.90000 – 150.05000	2310.0 – 2390.0	15.350 – 16.200
8.36200 – 8.36600	156.52475 – 156.52525	2483.5 – 2500.0	17.700 – 21.400
8.37625 – 8.38675	156.70000 – 156.90000	2655.0 – 2900.0	22.010 – 23.120
8.41425 – 8.41475	162.01250 – 167.17000	3260.0 – 3267.0	23.600 – 24.000
12.29000 – 12.29300	167.72000 – 173.20000	3332.0 – 3339.0	31.200 – 31.800
12.51975 – 12.52025	240.00000 – 285.00000	3345.8 – 3358.0	36.430 – 36.500
12.57675 – 12.57725	322.00000 – 335.40000	3600.0 – 4400.0	Above 38.6
13.36000 – 13.41000			

\*\* : Until February 1, 1999, this restricted band shall be 0.490-0.510 MHz

### 12.1 Labeling Requirement

The device shall bear the following statement in a conspicuous location on the device:

This device complies with part 15 of the FCC Rules. Operation is subject to the following two conditions: (1) This device may not cause harmful interference, and (2) this device must accept any interference received, including interference that may cause undesired operation.