

Hearing Aid Compatibility (HAC) RF Emissions Test Report

APPLICANT : b mobile HK Limited
EQUIPMENT : Mobile Phone
MODEL NAME : S748
FCC ID : ZSW-S748
Date : March 19, 2012
Report No : 12050024-HAC-RF-V3
M Category : M3

(This report supersedes NONE)



FCC HAC RF Emission Test Report

To: FCC 47 CFR 20.19 , ANSI C63.19

SIEMIC, INC.
Accessing global markets



Statement of Compliance

Date of Issue : March 19 2012
Company Name : b mobile HK Limited
Product Name/Model : Mobile Phone/S748
Stipulated Standard: (1) CFR 20.19 , ANSI C63.19:2007

The maximum results of RF Emission of Hearing Aid Compliance (HAC) found during testing for the EUT are as follows (with expanded uncertainty $\pm 12.71\%$):



Band	HAC RF Emission Test Result		M Rating
GSM850	E-Field(V/m)	166.34	M3
	H-Field(A/m)	0.45	M3
PCS1900	E-Field(V/m)	76.54	M3
	H-Field(A/m)	0.25	M3

Equipment complied with the specification [X]
 Equipment did not comply with the specification []

This wireless mobile and/or portable device has been shown to be in compliance with HAC limits (HAC Rated category M3) specified in guidelines FCC 47 CFR §20.19 and ANSI Standard ANSI C63.19:2007.

I attest to the accuracy of the data. All measurements were performed by myself or were made under my supervision and are correct to the best of my knowledge and belief. I assume full responsibility for the completeness of these measurements and vouch for the qualifications of all persons taking them.

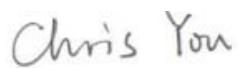
Modifications made to the product : None

This Test Report is Issued Under the Authority of:		
		
Chris You Test Engineer	Alex Liu Technical Manager	

We, SIEMIC Inc would like to declare that the tested sample has been evaluated in accordance with the procedure and shown the compliance with the applicable technical standards.

The test results in this report apply exclusively to the tested model / sample. Without written approval of SIEMIC INC. The test report shall not be reproduced except in full.

Laboratory Introduction

SIEMIC, headquartered in the heart of Silicon Valley, with superior facilities in US and Asia, is one of the leading independent testing and certification facilities providing customers with one-stop shop services for Compliance Testing and Global Certifications.



In addition to [testing](#) and [certification](#), SIEMIC provides initial design reviews and [compliance management](#) through out a project. Our extensive experience with [China](#), [Asia Pacific](#), [North America](#), [European](#), and [international](#) compliance requirements, assures the fastest, most cost effective way to attain regulatory compliance for the [global markets](#).

Accreditations for Conformity Assessment

Country/Region	Accreditation Body	Scope
USA	FCC, A2LA	EMC , RF/Wireless , Telecom
Canada	IC, A2LA, NIST	EMC, RF/Wireless , Telecom
Taiwan	BSMI , NCC , NIST	EMC, RF, Telecom , Safety
Hong Kong	OFTA , NIST	RF/Wireless ,Telecom
Australia	NATA, NIST	EMC, RF, Telecom , Safety
Korea	KCC/RRA, NIST	EMI, EMS, RF , Telecom, Safety
Japan	VCCI, JATE, TELEC, RFT	EMI, RF/Wireless, Telecom
Mexico	NOM, COFETEL, Caniety	Safety, EMC , RF/Wireless, Telecom
Europe	A2LA, NIST	EMC, RF, Telecom , Safety

Accreditations for Product Certifications

Country	Accreditation Body	Scope
USA	FCC TCB, NIST	EMC , RF , Telecom
Canada	IC FCB , NIST	EMC , RF , Telecom
Singapore	iDA, NIST	EMC , RF , Telecom



SIEMIC, INC.

Accessing global markets

Title: FCC HAC RF Emission Test Report for GSM Mobile Phone
Model: S748
To: CFR 20.19 , ANSI C63.19:2007

Serial#: 12050024-HAC-RF-V3
Issue Date: Mar 19th 2012
Page: 4 of 74
www.siemc.com

This page has been left blank intentionally.



CONTENTS

1	TECHNICAL DETAILS	6
2	APPLIED STANDARD.....	7
3	TEST CONDITION, CONFIGURATION, LOCATION	8
4	HAC RF EMISSIONS TEST SYSTEM	9
5	HAC E/H PROBE MODULATION FACTOR.....	17
6	LIST OF EQUIPMENTS	19
7	HAC RF EMISSIONS MEASUREMENT UNCERTAINTY	20
8	SYSTEM VALIDATION.....	21
9	HAC RF TEST RESULT	22
ANNEX A	HAC RF EMISSIONS VALIDATION.....	23
ANNEX B	HAC RF EMISSIONS DATA	27
ANNEX C	TEST SETUP PHOTO.....	40
ANNEX D	CALIBRATION REPORT	41



1 TECHNICAL DETAILS

Purpose	Compliance testing of Mobile Phone model QS900 with HAC RF Emission.
Applicant / Client	b mobile HK Limited G/F. 144 UN CHAU STREET, SHAM SHUI PO, KOWLOON HONG KONG, CHINA
Manufacturer	NINGBO BIRD CO., LTD No.999 Dacheng East Road, Fenghua City, Zhejiang
Laboratory performing the tests	SIEMIC Laboratories Suite 311, Building 1, Section 30, No.2 Kefa Road, Science and Technology Park Nan Shan District, Shenzhen 518057, Guangdong, P.R.C Tel: +(86) 0755-26014629 VIP Line:950-4038-0435
Test report reference number	12050024-HAC-RF
Date EUT received	Feb-14-2012
Standard applied	CFR 20.19 , ANSI C63.19:2007
Dates of test (from – to)	March 2th 2012
No of Units:	1
Equipment Category:	PCE
Trade Name:	B Mobile
Model Name:	S748
RF Operating Frequency (ies)	GSM850 : 824.2 ~ 848.8 MHz(TX) / 869.2 ~ 893.8 MHz(RX) GSM1900 : 1850.2 ~ 1909.8 MHz(TX) / 1930.2 ~ 1989.8 MHz(RX)
RF Conducted Power (dBm)	GSM850 : 32.09dBm GSM1900 : 28.29dBm
Antenna Type:	Fixed Antenna Type
Modulation:	GSM / GPRS : GMSK BT:GFSK
FCC ID:	ZSW-S748
IC ID:	NA

2 Applied Standard

The ANSI Standard ANSI C63.19-2007 represents performance requirements for acceptable interoperability of hearing aids with wireless communications devices. When these parameters are met, a hearing aid operates acceptably in close proximity to a wireless communications device.

The federal communication commission (FCC) adopted ANSI C63.19 as HAC test standard.

The following AWF(Articulation Weighting Factor) shall be used for the standard transmission protocols:

Standard	Technology	AWF (dB)
TIA/EIA/IS-2000	CDMA	0
TIA/EIA-136	TDMA (50Hz)	0
J-STD-007	GSM (217)	-5
T1/T1P1/3GPP	UMTS (WCDMA)	0
iDENTM	TDMA (22 and 11 Hz)	0

Category	Telephone RF Parameter		
	Near Field	AWF	E Field Emissions (V / M)
<u>< 960 MHz</u>			
Category M1	0	631.0 – 1122.0 V/m	1.91 – 3.39 A/m
	-5	473.2 – 841.4 V/m	1.43 – 2.54 A/m
Category M2	0	354.8 – 631.0 V/m	1.07 – 1.91 A/m
	-5	266.1 – 473.2 V/m	0.80 – 1.43 A/m
Category M3	0	199.5 – 354.8 V/m	0.6 – 1.07 A/m
	-5	149.6 – 266.1 V/m	0.45 – 0.80 A/m
Category M4	0	< 199.5 V/m	< 0.60 A/m
	-5	< 149.6 V/m	< 0.45 A/m
<u>> 960 MHz</u>			
Category M1	0	199.5 – 354.8 V/m	0.60 – 1.07 A/m
	-5	149.6 – 266.1 V/m	0.45 – 0.80 A/m
Category M2	0	112.2 – 199.5 V/m	0.34 – 0.60 A/m
	-5	84.1 – 149.6 V/m	0.25 – 0.45 A/m
Category M3	0	63.1 – 112.2 V/m	0.19 – 0.34 A/m
	-5	47.3 – 84.1 V/m	0.14 – 0.25 A/m
Category M4	0	< 63.1 V/m	< 0.19 A/m
	-5	< 47.3 V/m	< 0.14 A/m

3 Test Condition, Configuration, Location

Ambient Condition

Temperature: 20 ~ 24 C

Humidity : < 60 %

Testing Configuration

The device was controlled by using a base station emulator R&S CMU200. Communication between the device and the emulator was established by air link. The power control bits was set to "Always Up" from the emulator to radiate maximum output power during all testing

Measurements were performed on the low, middle and high channels of all bands

Description of Device Under test

Air-Interface	Band (MHz)	Type	C63.19/ Tested	Simultaneous Transmissions Note: Not to be test	Concurred single transmission	Reduced power 20.19(c)(1)	Voice Over Digital Transport (Data)
GSM	850	VO	Yes	Yes Bluetooth	Yes GPRS, Bluetooth Not rated	No	NA
	1900					No	NA
	GPRS	DT	NA	NA	Yes *see note	NA *	Yes
Bluetooth	2450	DT	NA	Yes GSM	NA *	NA *	Yes

Note: 1. the device only support GSM voice call mode, and performed at GSM850/1900 for HAC RF-emission testing.

2. No power reduced option applies for GSM1900.

3. * HAC Rating was not based on concurrent voice and data modes, Non current mode was found to represent worst case rating for both M and T rating

4 HAC RF Emissions Test System

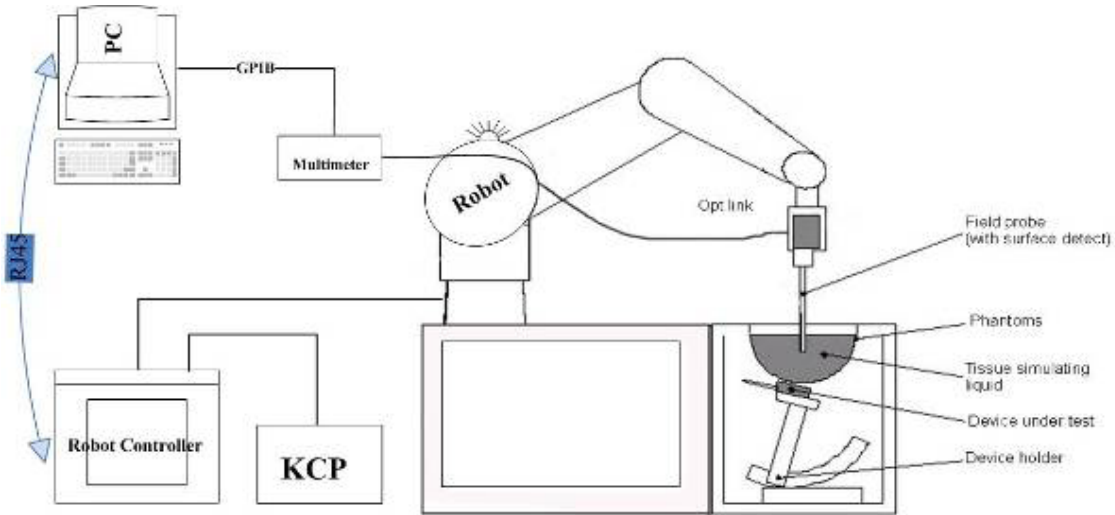

These measurements were performed with the automated near-field scanning system OPENSAR from SATIMO. The system is based on a high precision robot (working range: 850 mm), which positions the probes with a positional repeatability of better than ± 0.02 mm. Special E- and H-field probes have been developed for measurements close to material discontinuity, the sensors of which are directly loaded with a Schottky diode and connected via highly resistive lines to the data acquisition unit.

The OPENSAR system for performing compliance tests consist of the following items:

1. A standard high precision 6-axis robot (KUKA) with controller and software.
2. KUKA Control Panel (KCP).
3. A dosimetric probe, i.e., an isotropic E-field probe optimized and calibrated for usage in tissue simulating liquid. The probe is equipped with an optical surface detector system.
4. The functions of the PC plug-in card are to perform the time critical task such as signal filtering, surveillance of the robot operation fast movement interrupts.
5. A computer operating Windows XP.
6. OPENSAR software.
7. Remote control with teaches pendant and additional circuitry for robot safety such as warning lamps, etc.
8. The SAM phantom enabling testing left-hand right-hand and body usage.
9. The Position device for handheld EUT.
10. Tissue simulating liquid mixed according to the given recipes (see Application Note).
11. System validation dipoles to validate the proper functioning of the system.

COMOHAC E-Field Probe

The probe could be checked by measuring the resistance of the three dipoles
 Probe calibration is realized by using the waveguide method as described in the IEEE 1309-2005 standard.



Frequency Range	100 MHz - 3 GHz
Probe length	330 mm
Length of one dipole	3.3 mm
Maximum external diameter	8 mm
Probe extremity diameter	6 mm
Distance between dipoles/probe extremity	3.5 mm
Resistance of the three dipole (at the connector)	Dipole 1: R1=1.337 MΩ Dipole 2: R2=1.125 MΩ Dipole 3: R3=1.338 MΩ
Diode Compression Point	Dipole 1: DCP1=129 mV Dipole 2: DCP2=128 mV Dipole 3: DCP3=129 mV

HAC field measurements take place in the close near field with high gradients. Increasing the measuring distance from the source will generally decrease the measured field values (in case of the validation dipole approx. 10% per mm).

Magnetic field sensors are measuring the integral of the H-field across their sensor area surrounded by the loop. They are calibrated in a precise, homogeneous field. When measuring a gradient field, the result will be very close to the field in the center of the loop which is equivalent to the value of a homogeneous field equivalent to the center value. But it will be different from the field at the field at the border of the loop.

Consequently, two sensors with different loop diameters – both calibrated ideally – would give different results when measuring from the edge of the probe sensor elements. The behavior for electrically small E-field sensors is equivalent. See below for distance plots from a WD which show the conservative nature of field readings at the probe element center vs. measurements at the sensor end:

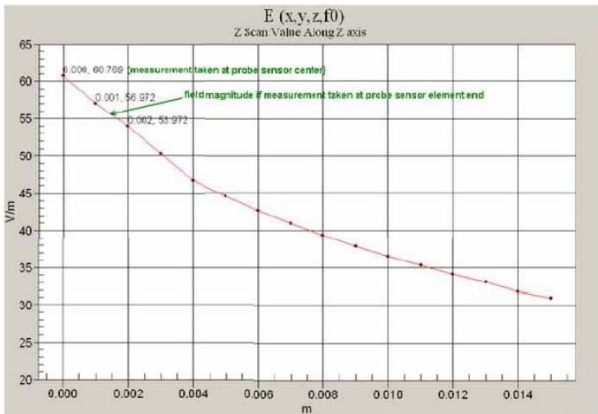

Z-Axis Scan at maximum point above a typical wireless device for E-field

COMOHAC H-Field Probe

The probe could be checked by measuring the resistance of the three ways.
Probe calibration is realized by using the waveguide method as described in the IEEE 1309-2005 standard.



Frequency Range	100 MHz - 30 GHz
Probe length	330 mm
Dimension of one loop	3.3 mm
Maximum external diameter	8 mm
Probe extremity diameter	6 mm
Distance between dipoles/probe extremity	3 mm
Resistance of the three dipole (at the connector)	Dipole 1: R1=1.337 MΩ Dipole 2: R2=1.125 MΩ Dipole 3: R3=1.338 MΩ
Diode Compression Point	Dipole 1: DCP1=129 mV Dipole 2: DCP2=128 mV Dipole 3: DCP3=129 mV

HAC field measurements take place in the close near field with high gradients. Increasing the measuring distance from the source will generally decrease the measured field values (in case of the validation dipole approx. 10% per mm).

Magnetic field sensors are measuring the integral of the H-field across their sensor area surrounded by the loop. They are calibrated in a precise, homogeneous field. When measuring a gradient field, the result will be very close to the field in the center of the loop which is equivalent to the value of a homogeneous field equivalent to the center value. But it will be different from the field at the field at the border of the loop.

Consequently, two sensors with different loop diameters – both calibrated ideally – would give different results when measuring from the edge of the probe sensor elements. The behavior for electrically small E-field sensors is equivalent. See below for distance plots from a WD which show the conservative nature of field readings at the probe element center vs. measurements at the sensor end:

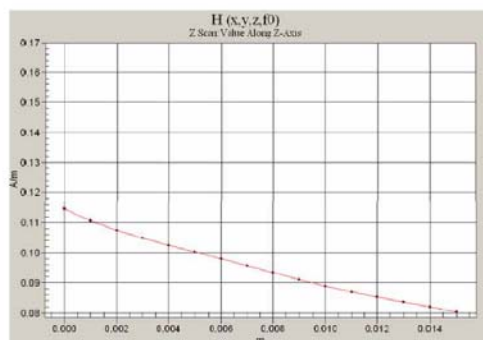

Z-Axis Scan at maximum point above a typical wireless device for H-field

Device Holder

the Mounting Device enables the rotation of the mounted transmitter in spherical coordinates whereby the rotation points is the ear opening. The devices can be easily, accurately, and repeatedly positioned according to the FCC and CENELEC specifications. The device holder can be locked at different phantom locations (left head, right head, flat phantom).



Data Evaluation

The OPENHAC software automatically executes the following procedure to calculate the field units from the microvolt readings at the probe connector. The parameters used in the valuation are stored in the configuration modules of the software:

Probe Parameters	- -Sensitivity	Normi , ai0, ai1, ai2
	- - Conversion factor	ConvFi
	- - Diode compression point Dcpi	dcpi
Device Parameter	- Frequency	f
	- Crest factor	cf
Media Parametrs	- Conductivity	σ
	- Density	ρ

These parameters must be set correctly in the software. They can either be found in the component documents or be imported into the software from the configuration files issued for the OPENHAC components.

The first step of the evaluation is a linearization of the filtered input signal to account for the compression characteristics of the detector diode. The compensation depends on the input signal, the diode type and the DC-transmission factor from the diode to the evaluation electronics. If the exciting field is pulsed, the crest factor of the signal must be known to correctly compensate for peak power. The formula for each channel can be given as:

$$V_i = U_i + U_i^2 \cdot \frac{cf}{dcp_i}$$

- Where V_i = Compensated signal of channel i ($i = x, y, z$)
 U_i = Input signal of channel i ($i = x, y, z$)
 cf = Crest factor of exciting field (DASY parameter)
 dcp_i = Diode compression point (DASY parameter)



From the compensated input signals the primary field data for each channel can be evaluated:

$$E\text{-field probes: } E_i = \sqrt{\frac{V_i}{Norm_i \cdot ConvF}}$$

$$H\text{-field probes: } H_i = \sqrt{V_i} \cdot \frac{a_{i10} + a_{i11}f + a_{i12}f^2}{f}$$

Where V_i = Compensated signal of channel i ($i = x, y, z$)

$Norm_i$ = Sensor sensitivity of channel i ($i = x, y, z$)
 $\mu V/(V/m)^2$ for E0field Probes

$ConvF$ = Sensitivity enhancement in solution

a_{ij} = Sensor sensitivity factors for H-field probes

f = Carrier frequency (GHz)

E_i = Electric field strength of channel i in V/m

H_i = Magnetic field strength of channel i in A/m

The RSS value of the field components gives the total field strength (Hermitian magnitude):

$$E_{rss} = \sqrt{E_x^2 + E_y^2 + E_z^2}$$

The primary field data are used to calculate the derived field units.

The measurement/integration time per point, as specified by the system manufacturer is > 500 ms. The signal response time is evaluated as the time required by the system to reach 90% of the expected final value after an on/off switch of the power source with an integration time of 500 ms and a probe response time of < 5 ms. In the current implementation, OpenHAC waits longer than 100 ms after having reached the grid point before starting a measurement, i.e., the response time uncertainty is negligible.

If the device under test does not emit a CW signal, the integration time applied to measure the electric field at a specific point may introduce additional uncertainties due to the discretization. The tolerances for the different systems had the worst-case of 2.6%.

Device Reference Points

The DUT was put on device holder and adjusted to the accurate and reliable position. Please refer to Appendix E for the Setup photographs

Below diagram illustrate the references and reference plane that shall be used in a typical DUT emissions measurement. The principle of this section is applied to DUT with similar geometry.

The grid is 5 cm by 5 cm area that is divided into 9 evenly sized blocks or sub-grids.

The grid is centered on the audio frequency output transducer of the DUT.

The grid is in a reference plane, which is defined as the planar area that contains the highest point in the area of the phone that normally rests against the user's ear. It is parallel to the centerline of the receiver area of the phone and is defined by the points of the receiver-end of the DUT handset, which, in normal handset use, rest against the ear.

The measurement plane is parallel to, and 15 mm in front of, the reference plane.



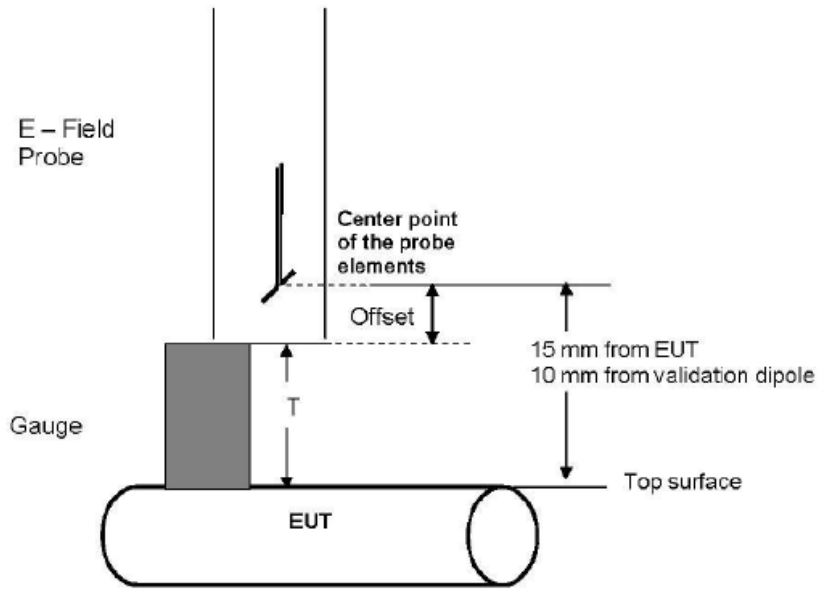

Gauge block with E-field probe

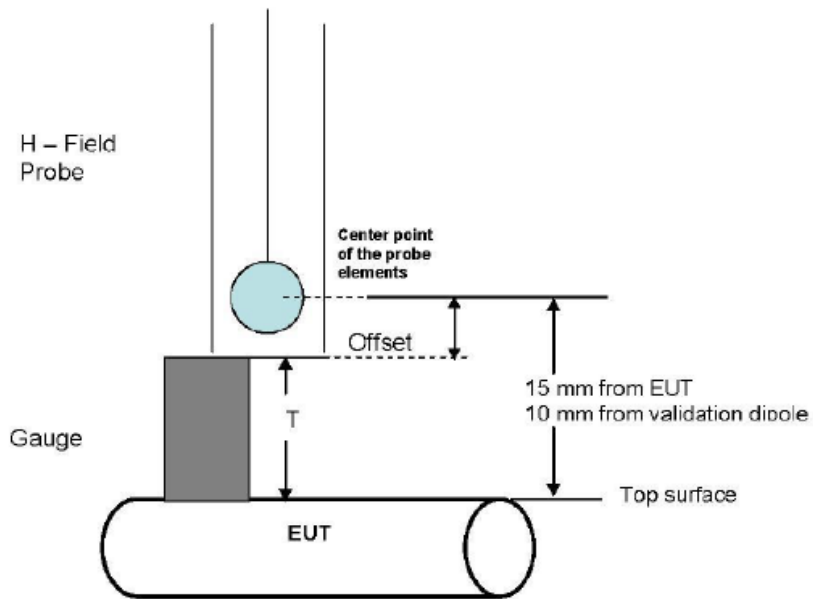

Gauge block with H-field probe

HAC RF Emission Test Procedure

The following illustrate a typical RF emissions test scan over a wireless communications device:

1. Proper operation of the field probe, probe measurement system, other instrumentation, and the positioning system was confirmed.
2. DUT is positioned in its intended test position, acoustic output point of the device perpendicular to the field probe.
3. The DUT operation for maximum rated RF output power was configured and confirmed with the base station simulator, at the test channel and other normal operating parameters as intended for the test. The battery was ensured to be fully charged before each test.
4. The center sub-grid was centered over the center of the acoustic output (also audio band magnetic output, if applicable). The DUT audio output was positioned tangent (as physically possible) to the measurement plane.
5. A surface calibration was performed before each setup change to ensure repeatable spacing and proper maintenance of the measurement plane using the test Arch.
6. The measurement system measured the field strength at the reference location.
7. Measurements at 5 mm increments in the 5 x 5 cm region were performed and recorded. A 360° rotation about the azimuth axis at the maximum interpolated position was measured. For the worst-case condition, the peak reading from this rotation was used in re-evaluating the HAC category.
8. The system performed a drift evaluation by measuring the field at the reference location.
9. Steps 1 ~ 8 were done for both the E and H-Field measurements.

5 HAC E/H Probe Modulation factor

A calibration shall be made of the modulation response of the probe and its instrumentation chain. This calibration shall be performed with the field probe, attached to the instrumentation that is to be used with it during the measurement. The response of the probe system to a CW field at the frequency(s) of interest is compared to its response to a modulated signal with equal peak amplitude. The field level of the test signals shall be more than 10 dB above the ambient level and the noise floor of the instrumentation being used. The ratio of the CW reading to that taken with a modulated field shall be applied to the readings taken of modulated fields of the specified type.

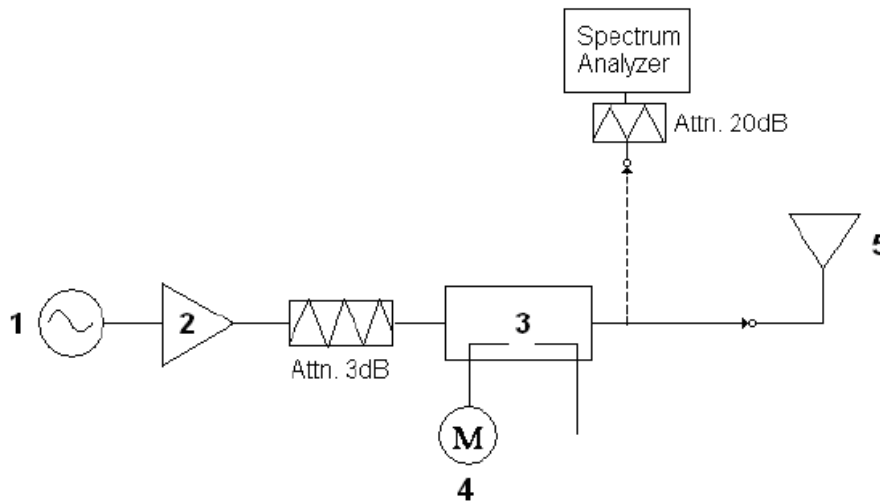

This was done using the following procedure:

1. Fixing the probe in a set location relative to a field generating device.
2. Illuminate the probe with a CW signal at the intended measurement frequency.
3. Record the reading of the probe measurement system of the CW signal.
4. Determine the level of the CW signal being used to drive the field generating device.
5. Substitute a signal using the same modulation as that used by the intended WD for the CW signal.
6. Set the peak amplitude during transmission of the modulated signal to equal the amplitude of the CW signal.
7. Record the reading of the probe measurement system of the modulated signal.
8. The ratio of the CW to modulated signal reading is the modulation factor.
9. Repeat 2-8 steps at intended measurement frequency for both E and H field probe.

PMF Summary:

Frequency	Modulation	E Field	H Field	PMF	
		V/M	A/M	E Field	H Field
835	CW	201.36	0.391	-	-
835	AM 80%	90.55	0.166	2.22	2.35
835	GSM	70.62	0.136	2.85	2.87
1880	CW	116.65	0.330	-	-
1880	AM 80%	53.34	0.144	2.19	2.29
1880	GSM	41.25	0.116	2.83	2.84

Note: Modulation factor = CW / WD_GSM



SIEMIC, INC.
Accessing global markets

Title: FCC HAC RF Emission Test Report for GSM Mobile Phone
Model: S748
To: CFR 20.19, ANSI C63.19:2007

Serial#: 12050024-HAC-RF-V3
Issue Date: Mar 19th 2012
Page: 18 of 74
www.sieminc.com

Zero Span Spectrum Plots for RF Field Probe Modulation Factor

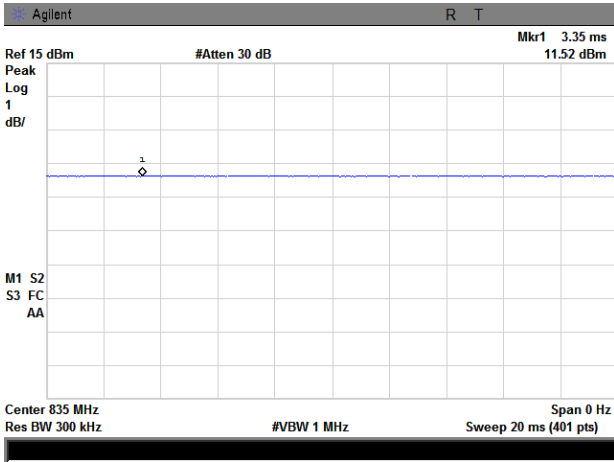

835MHz- CW

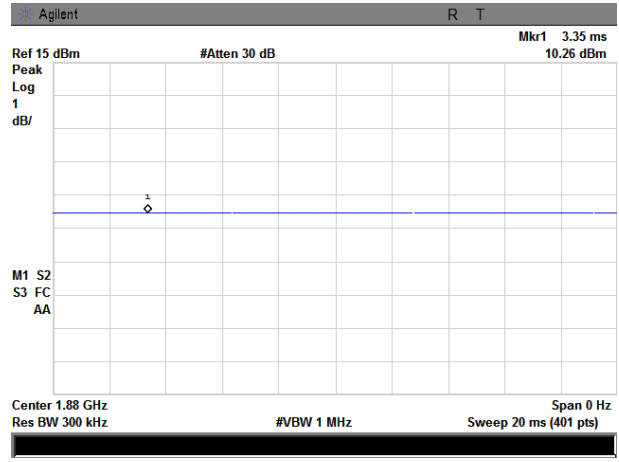

1880MHz- CW

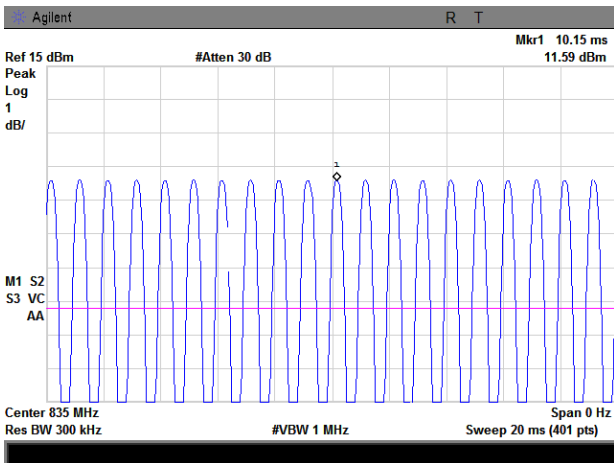

835MHz- 80% AM

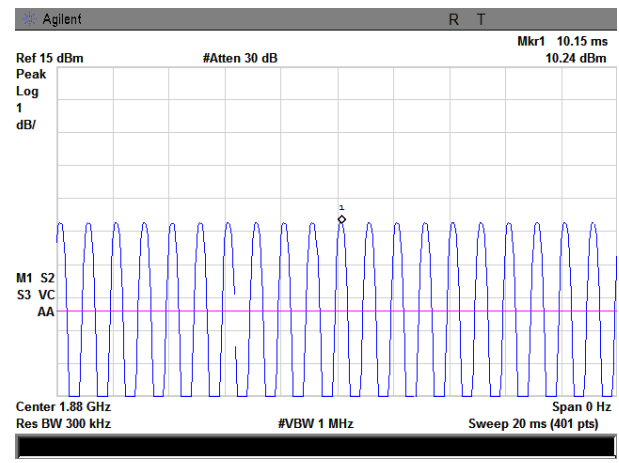

1880MHz- 80% AM

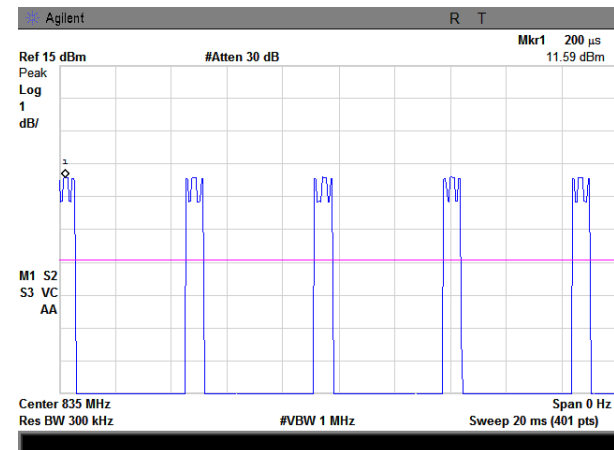

835MHz- GSM

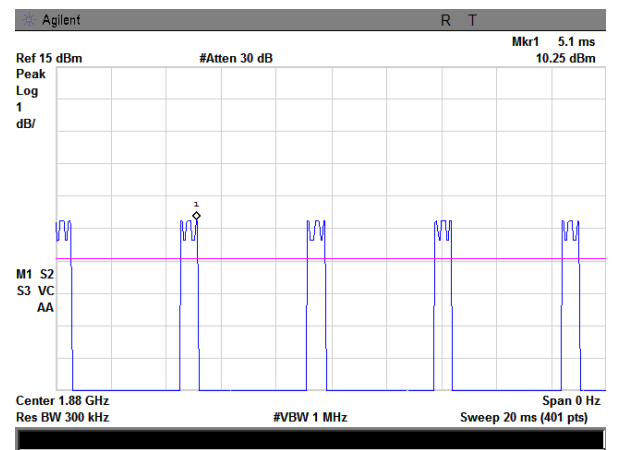

1880MHz- GSM



6 List of Equipments

Name of Equipment	Manufacturer	Type/Model	Serial Number	Calibration Due
P C	Compaq	PV 3.06GHz	375052-AA1	N/A
Signal Generator	Agilent	8665B-008	3744A01304	5/17/2012
MultiMeter	Keithley	MiltiMeter 2000	1259033	08/13/2012
S-Parameter Network Analyzer	Agilent	8753ES	US38161019	08/04/2012
Wireless Communication Test Set	R & S	CMU200	111078	07/22/2012
Power Meter	HP	437B	3038A03648	5/17/2012
COMOHAC E-Field Probe	SATIMO	EPH25	SN 3110 EPH25	06/01/2012
COMOHAC H-Field Probe	SATIMO	HPH38	SN 3110 HPH38	06/01/2012
COMOSAR Open Coaxial Probe	SATIMO	OCP36	SN 31/10 OCP36	06/01/2012
T-Coil Probe	SATIMO	TCP17	SN 31/10 TCP17	06/01/2012
Communication Antenna	SATIMO	ANTA30	SN 31/10 ANTA30	N/A
Laptop POSITIONING DEVICE	SATIMO	LSH63	SN 31/10 LSH13	N/A
Mobile Phone POSITIONING DEVICE	SATIMO	MSH63	SN 31/10 MSH63	N/A
COMOHAC Broadband Dipole 800-950	SATIMO	COMOHAC Broadband Dipole 800-950MHz	SN 31/10 DHA25	06/01/2012
COMOHAC Broadband Dipole 1700-2000	SATIMO	COMOHAC Broadband Dipole 1700-2000MHz	SN 31/10 DHB26	06/01/2012
COMOHAC TELEPHONE MAGNETIC FIELD SIMULATOR	SATIMO	TMFS08	SN 31/10 TMFS08	06/01/2012
DUMMY PROBE	ANTENNESSA	None	SN 31/10	N/A
SAM PHANTOM	SATIMO	SAM77	SN 31/10 SAM77	N/A
Elliptic Phantom	SATIMO	ELLI17	SN 31-10 ELLI17	N/A
PHANTOM TABLE	SATIMO	N/A	N/A	N/A
6 AXIS ROBOT	KUKA	KR5	949319	N/A
High Power Solid State Amplifier (80MHz-1000MHz)	Instruments for Industry	CMC150	M631-0408	N/A
Medium Power Solid State Amplifier (0.8-4.2GHz)	Instruments for Industry	S41-25	M629-0408	N/A
Wave Tube Amplifier 4-8 GHz at 20Watt	Hughes Aircraft Company	1277H02F000	81	N/A



7 HAC RF Emissions Measurement Uncertainty

Uncertainty Component	Tolerances (dB) / %	Probability Distribution	Divisor	Ci	Uncertainty (dB)	Uncertainty (%)
Measurement System Related						
RF Reflections	0.1 dB	R	$\sqrt{3}$	1	0.06	N/A
Field Probe Conv. Factor	0.2 dB	R	$\sqrt{3}$	1	0.12	N/A
Field Probe Anisotropy	0.25 dB	R	$\sqrt{3}$	1	0.14	N/A
Positioning Accuracy	0.1 dB	R	$\sqrt{3}$	1	0.06	N/A
Probe Cable Placement	0.1 dB	R	$\sqrt{3}$	1	0.06	N/A
System Repeatability	0.2 dB	R	$\sqrt{3}$	1	0.12	N/A
EUT Repeatability	0.1 dB	N	1	1	0.10	N/A
<i>Combined Standard Uncertainty :</i>					0.26	6.36 %
Test Sample Related						
Device Positioning Vertical	4.7 %	R	$\sqrt{3}$	0.67	N/A	1.8 %
Device Positioning Lateral	1.0 %	R	$\sqrt{3}$	1	N/A	0.6 %
Device Holder	2.4 %	R	$\sqrt{3}$	1	N/A	1.4 %
Test Sample	0.3 %	N	1	1	N/A	0.3 %
Power drift	5 %	R	$\sqrt{3}$	1	N/A	1.7 %
PMF Calculation						
Power Sensor	1.0 %	R	$\sqrt{3}$	1	N/A	0.6 %
Dual Directional Coupler	1.0 %	R	$\sqrt{3}$	1	N/A	0.6 %
Phantom and setup Related						
Phantom Thickness	2.4 %	R	$\sqrt{3}$	0.67	N/A	0.9 %
Combined Standard Uncertainty						7.1 %
Expanded Standard Uncertainty (K=2, confidence 95%)						14.2 %

8 System Validation

System Validation

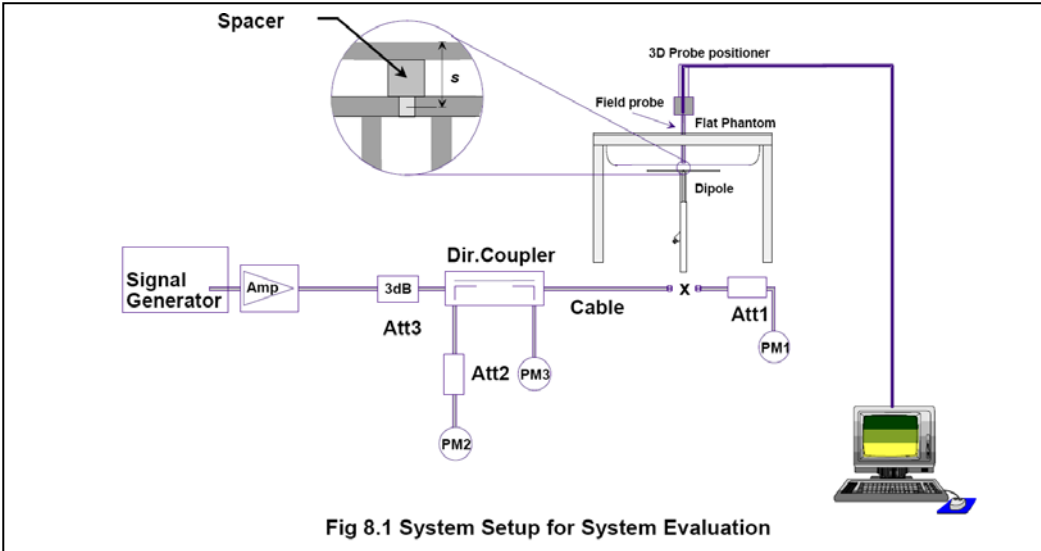

Fig 8.1 System Setup for System Evaluation

The system performance check verifies that the system operates within its specifications. System and operator errors can be detected and corrected. It is recommended that the system performance check be performed prior to any usage of the system in order to guarantee reproducible results. The system performance check uses normal HAC measurements in a simplified setup with a well characterized source. This setup was selected to give a high sensitivity to all parameters that might fail or vary over time. The system check does not intend to replace the calibration of the components, but indicates situations where the system uncertainty is exceeded due to drift or failure.

In the simplified setup for system evaluation, the DUT is replaced by a calibrated dipole and the power source is replaced by a continuous wave that comes from a signal generator. The calibrated dipole must be placed beneath the flat phantom section of the SAM twin phantom with the correct distance holder. The distance holder should touch the phantom surface with a light pressure at the reference marking and be oriented parallel to the long side of the phantom. The equipment setup is shown below:

1. Signal Generator
2. Amplifier
3. Directional Coupler
4. Power Meter
5. Calibrated Dipole

Comparing to the original E-field or H-field value provided by SATIMO, the validation data should be within its specification of 25 %. Below Table shows the target value and measured value. The table below indicates the system performance check can meet the variation criterion and the plots can be referred to Appendix A of this report. The results are normalized to 20dBm forward input power and compared with the reference E-Field and H-Field value below.

Measurement Date	Frequency (MHz)	Target Value (V/M)	Measured E Field (V/M)	Deviation (%)	Input Power (dBm)
March 02 2012	835	210	226.10	7.6	20
March 02 2012	1900	153	163.17	6.6	20
Measurement Date	Frequency (MHz)	Target Value (A/M)	Measured H Field (A/M)	Deviation (%)	Input Power (dBm)
March 02 2012	835	0.445	0.432	-2.9	20
March 02 2012	1900	0.445	0.436	-2.0	20



9 HAC RF Test Result

DUT Conducted Average Output Power (Unit: dBm)

Burst Average Power (dBm);								
Band	GSM850				GSM1900			
Channel	128	190	251	Tune up Power tolerant	512	661	810	Tune up Power tolerant
Frequency (MHz)	824.2	836.6	848.8	/	1850.2	1880	1909.8	/
GSM Voice (1 uplink),GMSK	32.09	31.90	31.82	33±2	28.29	28.21	28.27	30±2
GPRS Multi-Slot Class 8 (1 uplink),GMSK	31.93	31.81	31.69	33±2	28.08	28.01	28.07	30±2
GPRS Multi-Slot Class 10 (2 uplink),GMSK	31.09	30.96	30.85	30±2	27.17	27.11	27.18	28±2
GPRS Multi-Slot Class 12 (4 uplink),GMSK	28.60	28.52	28.44	28±2	25.67	25.63	25.70	26±2

Remark :
GPRS, CS1 coding scheme.
Multi-Slot Class 8 , Support Max 4 downlink, 1 uplink , 5 working link
Multi-Slot Class 10 , Support Max 4 downlink, 2 uplink , 5 working link
Multi-Slot Class 12 , Support Max 4 downlink, 4 uplink , 5 working link

HAC E Field Test Result Summary

Operating Mode	Channel	EUT Configuration	Peak E Field (V/M)	M rating
GSM850	Low	Standard	158.42	M3
	Mid	Standard	161.79	M3
	High	Standard	166.34	M3
GSM1900	Low	Standard	76.54	M3
	Mid	Standard	74.17	M3
	High	Standard	72.15	M3

HAC H Field Test Result Summary

Operating Mode	Channel	EUT Configuration	Peak H Field (A/M)	M rating
GSM850	Low	Standard	0.45	M4
	Mid	Standard	0.45	M3
	High	Standard	0.45	M3
GSM1900	Low	Standard	0.25	M3
	Mid	Standard	0.24	M3
	High	Standard	0.24	M3



Annex A HAC RF Emissions Validation

CW850

Lower Band

Frequency (MHz): 835.000000

Input power: 20dBm

Surface HAC

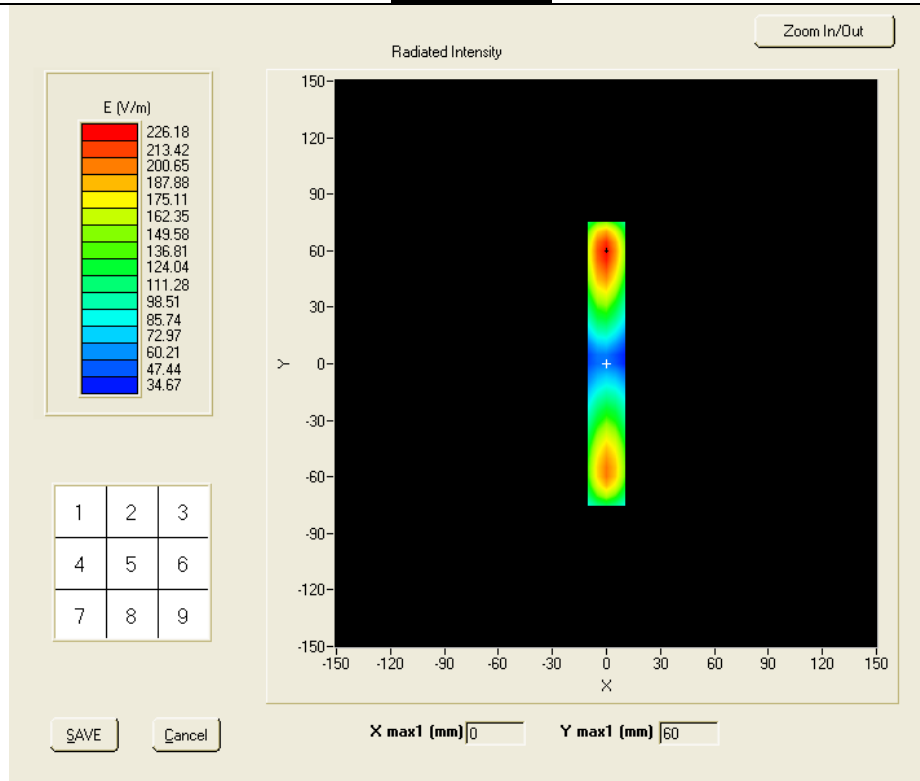

Probe Modulation Factor = 1.000000

Maximum value of total field = 226.10 V/m

CW850
Lower Band
Frequency (MHz): 835.000000
Input power: 20dBm

Surface HAC

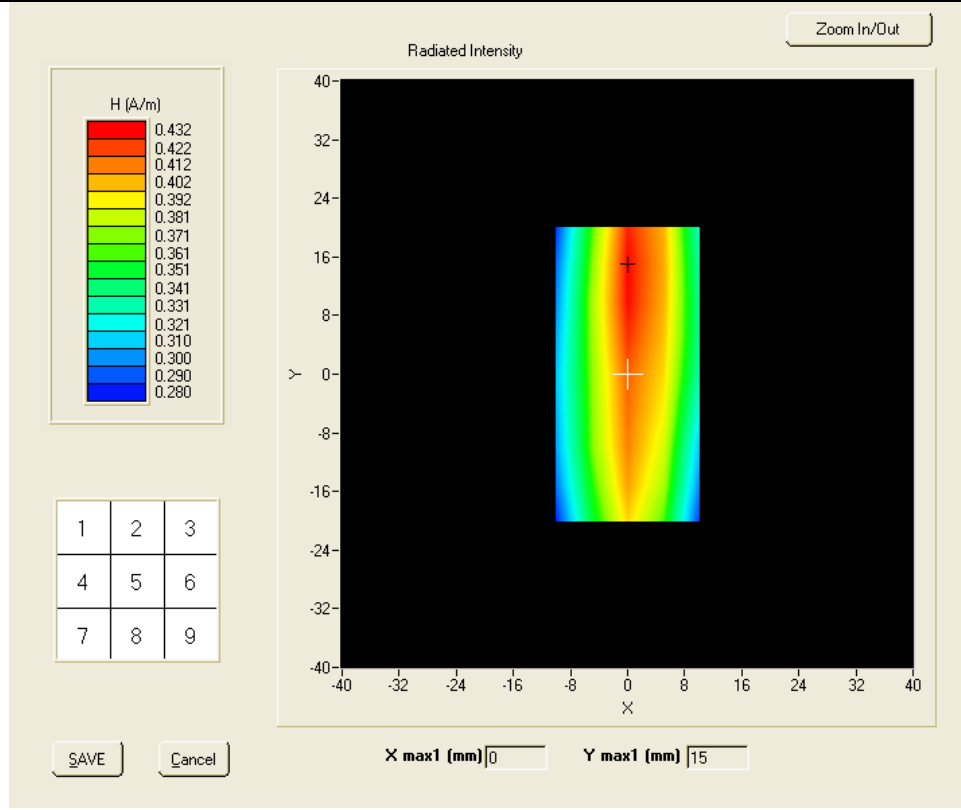

Probe Modulation Factor = 1.000000
Maximum value of total field = 0.432 A/m

CW1900
Middle Band
Frequency (MHz): 1880.00000
Input power: 20dBm

Surface HAC

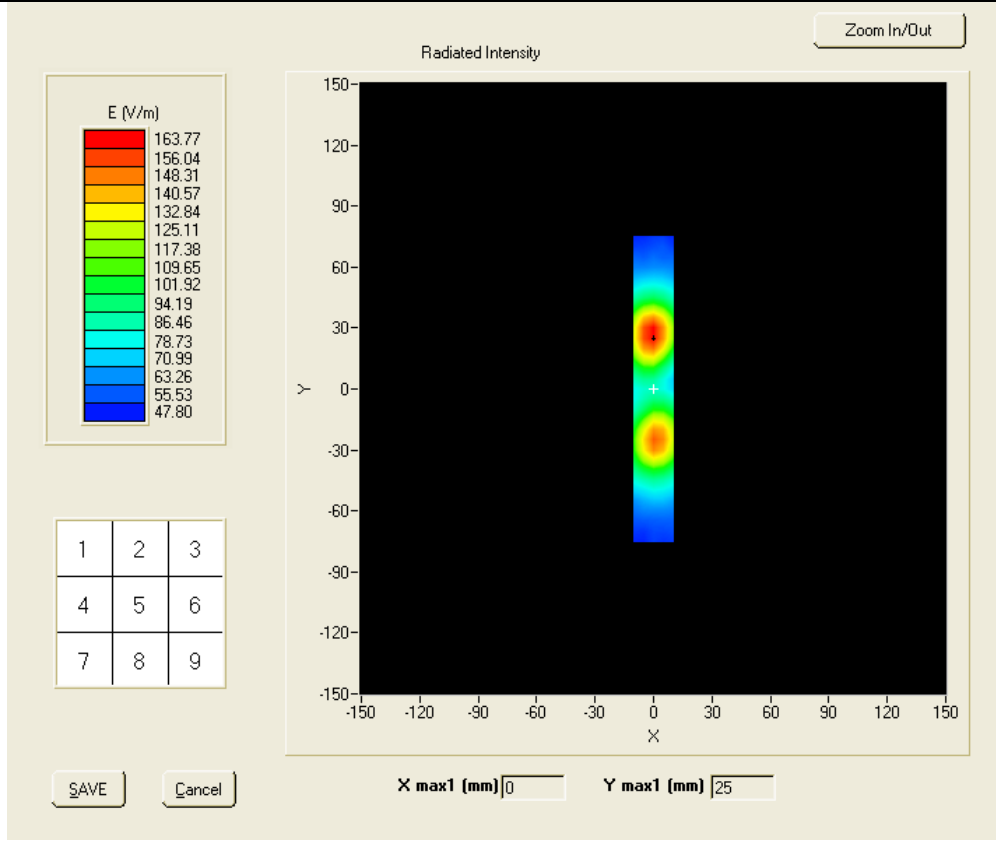

Probe Modulation Factor = 1.000000
Maximum value of total field = 163.17 V/m

CW1900
Middle Band
Frequency (MHz): 1880.000000
Input power: 20dBm

Surface HAC

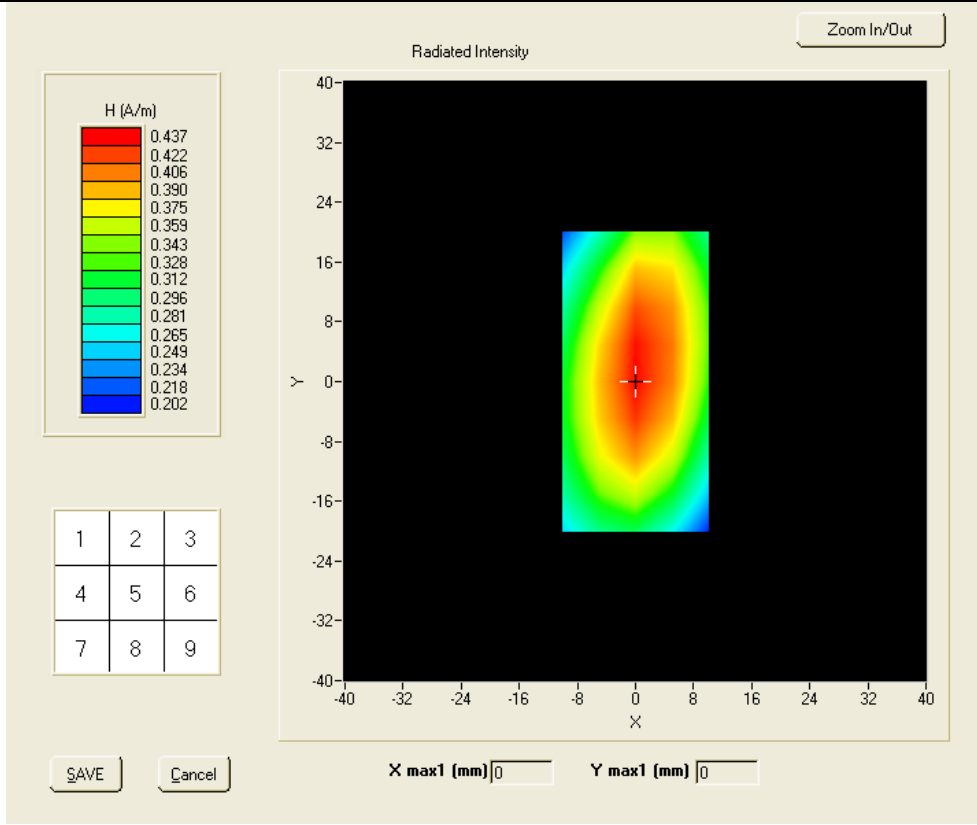

Probe Modulation Factor = 1.000000
Maximum value of total field = 0.436 A/m



Annex B HAC RF Emissions Data

<u>Item</u>	<u>Type</u>	<u>Band</u>	<u>Test Configurations</u>
1	Standard Phone	GSM850	E Field
2	Standard Phone	GSM850	H Field
3	Standard Phone	GSM850	E Field
4	Standard Phone	GSM850	H Field
5	Standard Phone	GSM850	E Field
6	Standard Phone	GSM850	H Field
7	Standard Phone	GSM1900	E Field
8	Standard Phone	GSM1900	H Field
9	Standard Phone	GSM1900	E Field
10	Standard Phone	GSM1900	H Field
11	Standard Phone	GSM1900	E Field
12	Standard Phone	GSM1900	H Field

Test Item 1

GSM850

Lower Band

Frequency (MHz): 824.200000

E-Field

Surface HAC

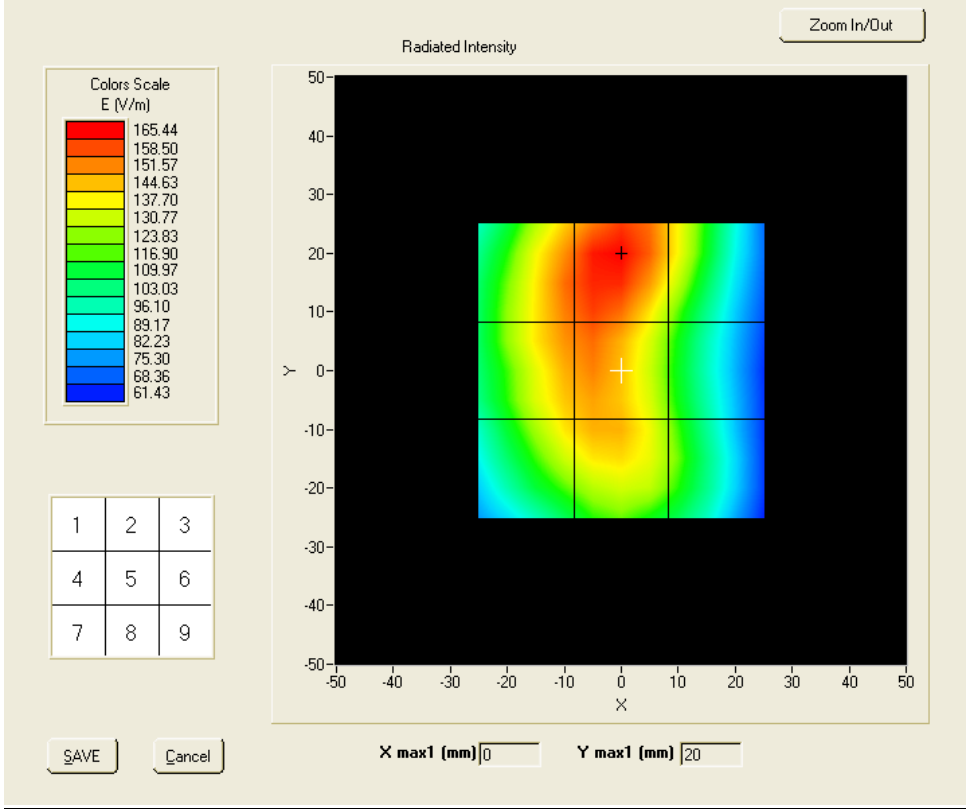

Probe Modulation Factor = 2.85
 Maximum value of total field = 158.42 V/m
 Hearing Aid Near-Field Category: M3 (AWF -5 dB)

E In V/m

Grid 1: 158.62	Grid 2: 166.14	Grid 3: 138.42
Grid 4: 155.70	Grid 5: 158.42	Grid 6: 119.54
Grid 7: 144.47	Grid 8: 147.21	Grid 9: 122.06

Test Item 2

GSM850

Lower Band

Frequency (MHz): 824.200000

H-Field

Surface HAC

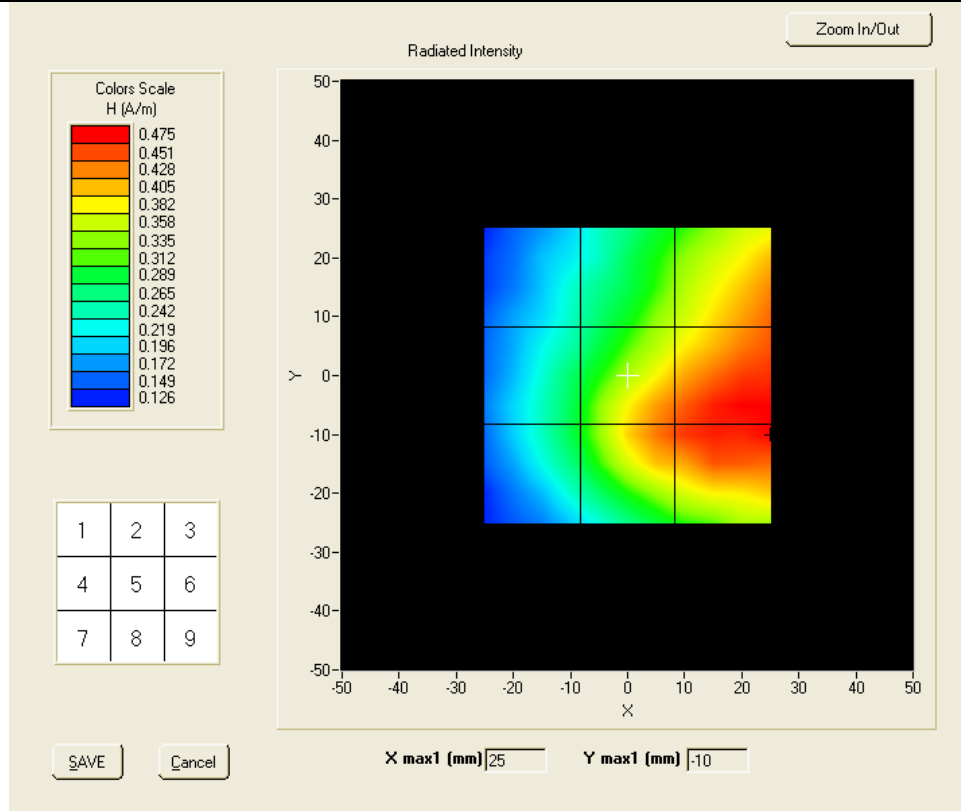

Probe Modulation Factor = 2.87
 Maximum value of total field = 0.45 A/m
 Hearing Aid Near-Field Category: M4 (AWF -5 dB)

H In A/M

Grid 1: 0.25	Grid 2: 0.35	Grid 3: 0.44
Grid 4: 0.30	Grid 5: 0.45	Grid 6: 0.48
Grid 7: 0.30	Grid 8: 0.45	Grid 9: 0.48

Test Item 3

GSM850

Middle Band

Frequency (MHz): 836.600000

E-Field

Surface HAC

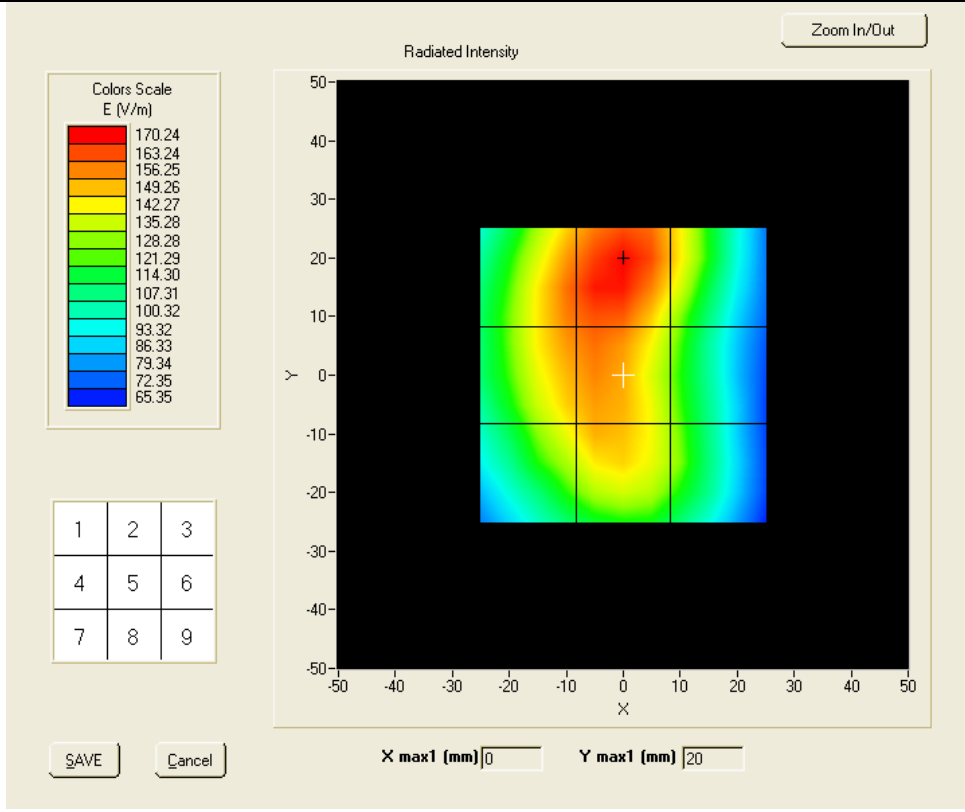

Probe Modulation Factor = 2.85
 Maximum value of total field = 161.79 V/m
 Hearing Aid Near-Field Category: M3 (AWF -5 dB)

E In V/M

Grid 1: 163.37	Grid 2: 170.65	Grid 3: 144.48
Grid 4: 159.33	Grid 5: 161.79	Grid 6: 127.13
Grid 7: 147.54	Grid 8: 152.49	Grid 9: 128.10

Test Item 4

GSM850

Middle Band

Frequency (MHz): 836.600000

H-Field

Surface HAC

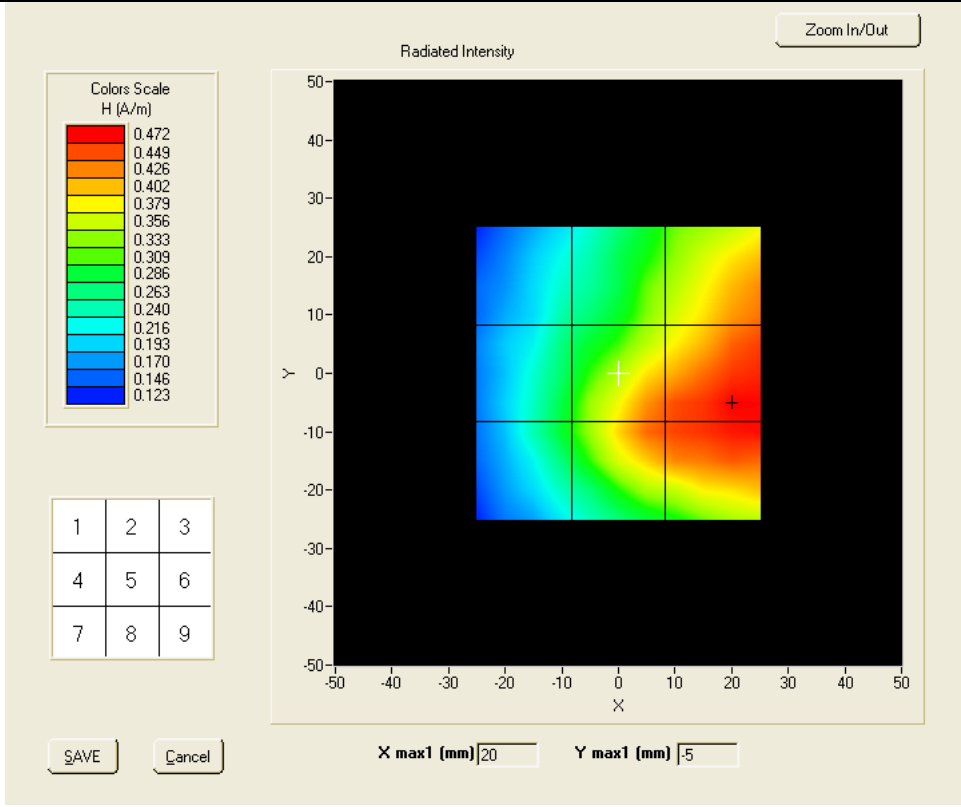

Probe Modulation Factor = 2.87
 Maximum value of total field = 0.45 A/m
 Hearing Aid Near-Field Category: M3 (AWF -5 dB)

H In A/M

Grid 1: 0.25	Grid 2: 0.36	Grid 3: 0.43
Grid 4: 0.31	Grid 5: 0.45	Grid 6: 0.47
Grid 7: 0.31	Grid 8: 0.45	Grid 9: 0.47

Test Item 5

GSM850

Higher Band

Frequency (MHz): 848.600000

E-Field

Surface HAC

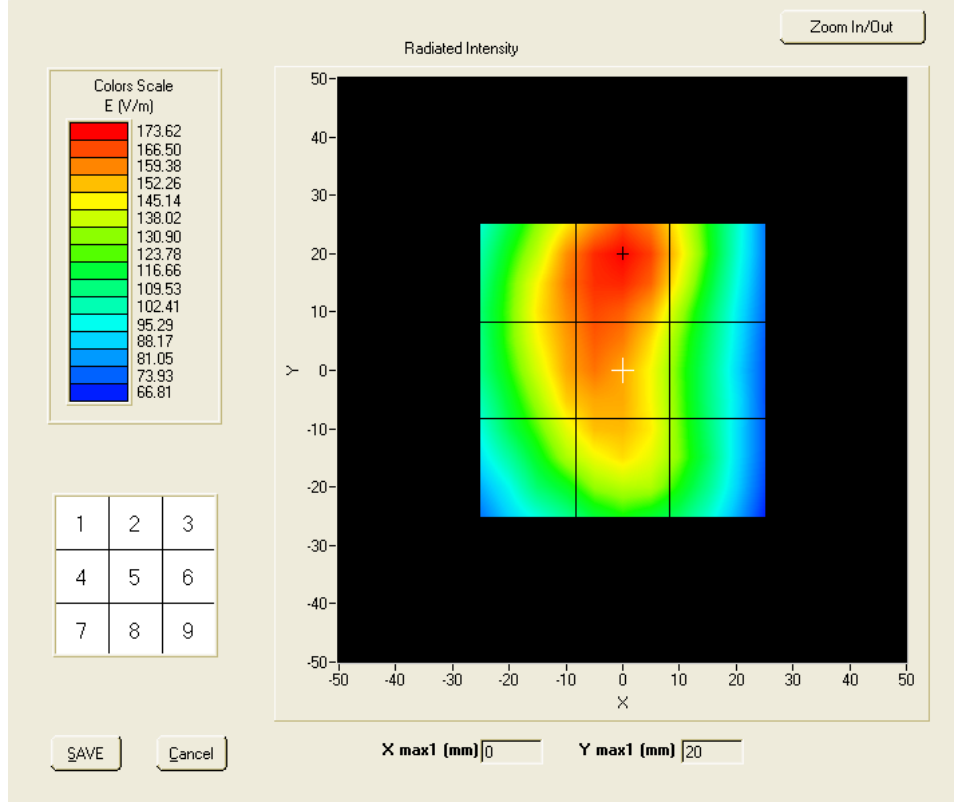

Probe Modulation Factor = 2.85
 Maximum value of total field = 166.34 V/m
 Hearing Aid Near-Field Category: M3 (AWF -5 dB)

E In VM

Grid 1: 165.83	Grid 2: 173.69	Grid 3: 148.22
Grid 4: 162.25	Grid 5: 166.34	Grid 6: 133.61
Grid 7: 149.54	Grid 8: 154.45	Grid 9: 130.56

Test Item 6

GSM850

Higher Band

Frequency (MHz): 848.600000

H-Field

Surface HAC

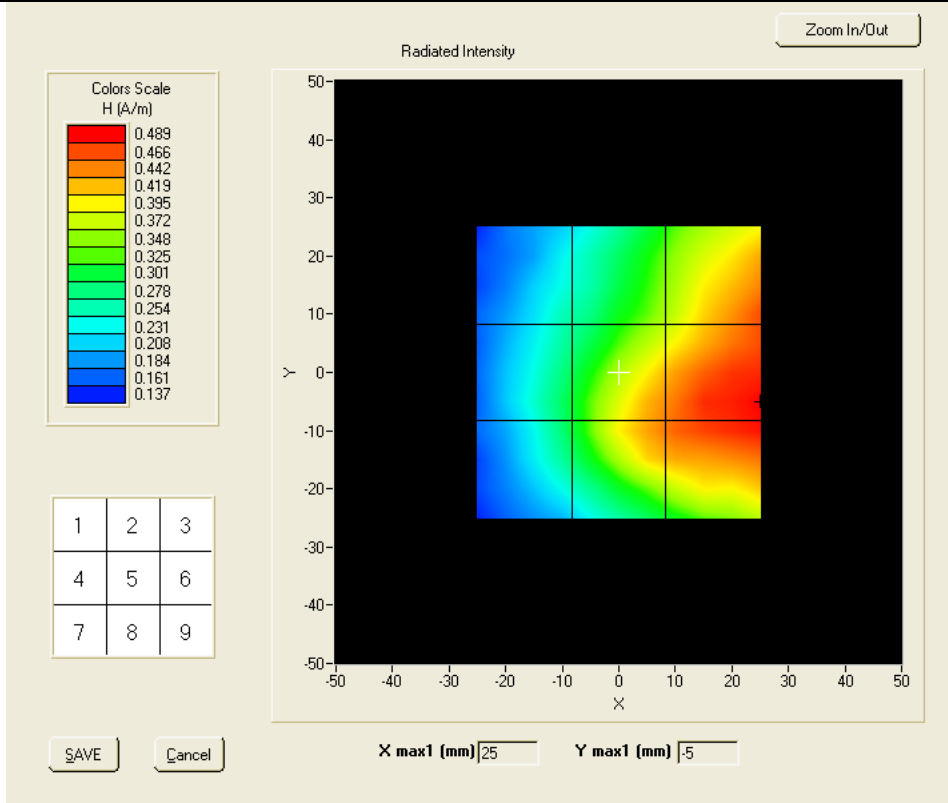

Probe Modulation Factor = 2.87
 Maximum value of total field = 0.45 A/m
 Hearing Aid Near-Field Category: M3 (AWF -5 dB)

H In A/M

Grid 1: 0.26	Grid 2: 0.36	Grid 3: 0.46
Grid 4: 0.31	Grid 5: 0.45	Grid 6: 0.49
Grid 7: 0.31	Grid 8: 0.45	Grid 9: 0.49

Test Item 7

GSM1900

Lower Band

Frequency (MHz): 1850.200000

E-Field

Surface HAC

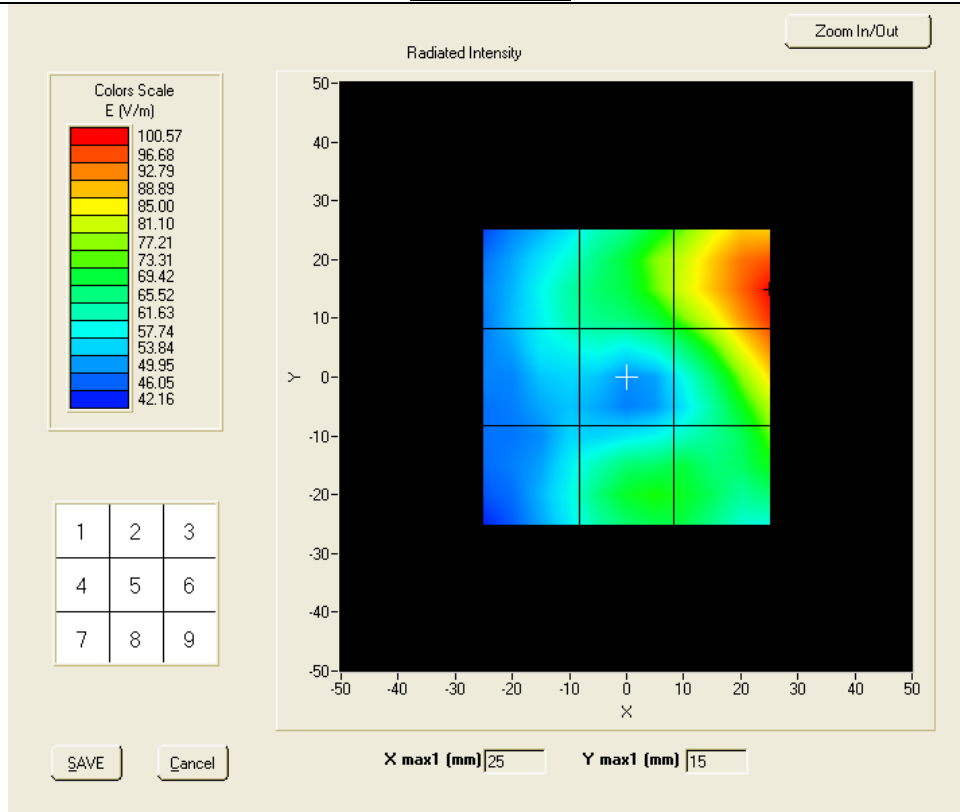

Probe Modulation Factor = 2.83
 Maximum value of total field = 76.54 V/m
 Hearing Aid Near-Field Category: M3 (AWF -5 dB)

E In V/M

Grid 1: 64.62	Grid 2: 81.28	Grid 3: 100.59
Grid 4: 62.61	Grid 5: 73.09	Grid 6: 97.21
Grid 7: 60.65	Grid 8: 73.08	Grid 9: 76.54

Test Item 8

GSM1900

Lower Band

Frequency (MHz): 1850.200000

H-Field

Surface HAC

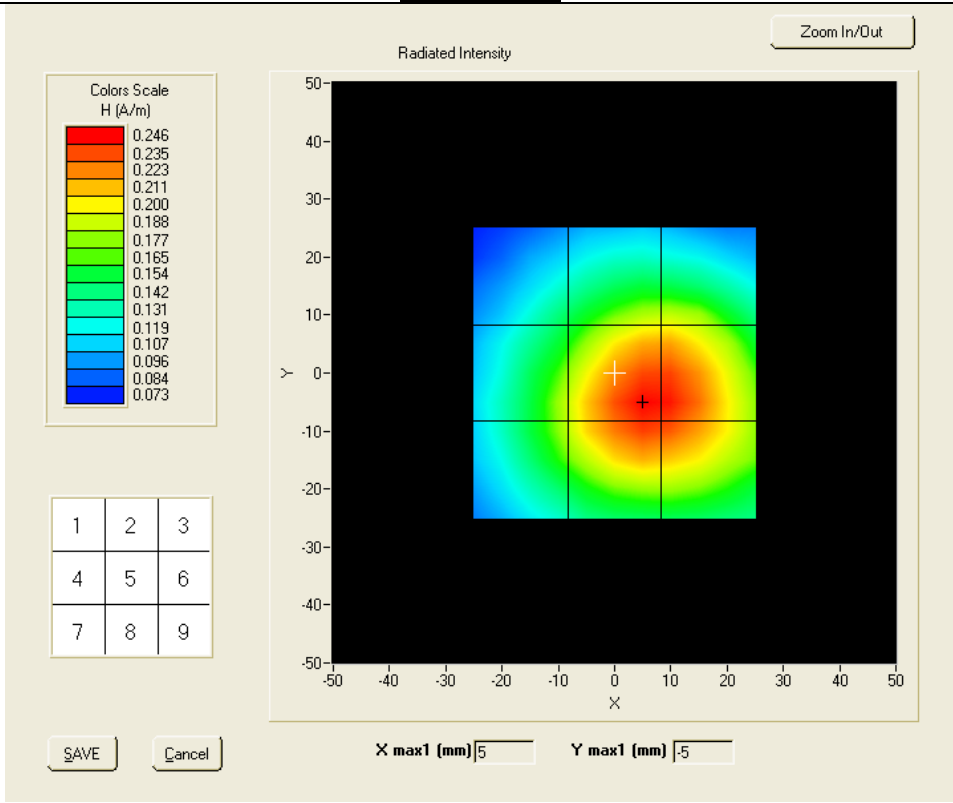

Probe Modulation Factor = 2.84
 Maximum value of total field = 0.25 A/m
 Hearing Aid Near-Field Category: M3 (AWF -5 dB)

H In A/M

Grid 1: 0.15	Grid 2: 0.19	Grid 3: 0.19
Grid 4: 0.19	Grid 5: 0.25	Grid 6: 0.24
Grid 7: 0.19	Grid 8: 0.24	Grid 9: 0.24

Test Item 9

GSM1900

Middle Band

Frequency (MHz): 1880.000000

E-Field

Surface HAC

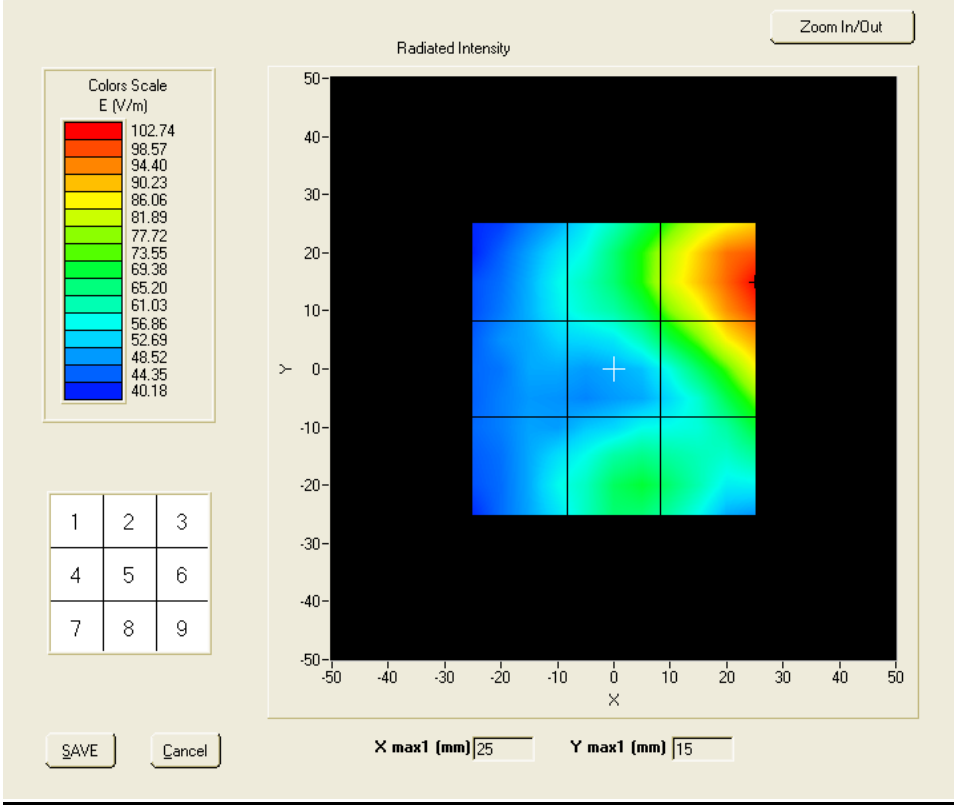

Probe Modulation Factor = 2.83
 Maximum value of total field = 74.17 V/m
 Hearing Aid Near-Field Category: M3 (AWF -5 dB)

E In V/M

Grid 1: 58.04	Grid 2: 81.75	Grid 3: 102.74
Grid 4: 56.26	Grid 5: 74.17	Grid 6: 97.87
Grid 7: 57.81	Grid 8: 69.66	Grid 9: 72.08

Test Item 10

GSM1900

Middle Band

Frequency (MHz): 1880.000000

H-Field

Surface HAC

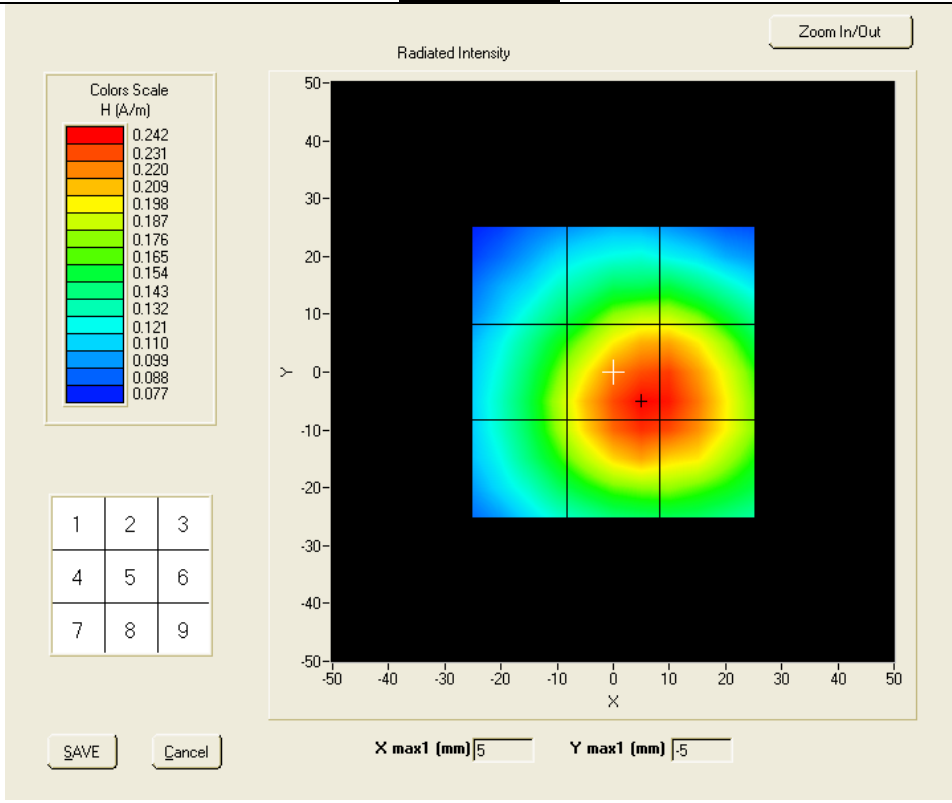

Probe Modulation Factor = 2.84
 Maximum value of total field = 0.24 A/m
 Hearing Aid Near-Field Category: M3 (AWF -5 dB)

H In A/M

Grid 1: 0.15	Grid 2: 0.18	Grid 3: 0.18
Grid 4: 0.19	Grid 5: 0.24	Grid 6: 0.24
Grid 7: 0.19	Grid 8: 0.24	Grid 9: 0.24

Test Item 11

GSM1900

higher Band

Frequency (MHz): 1909.800000

E-Field

Surface HAC

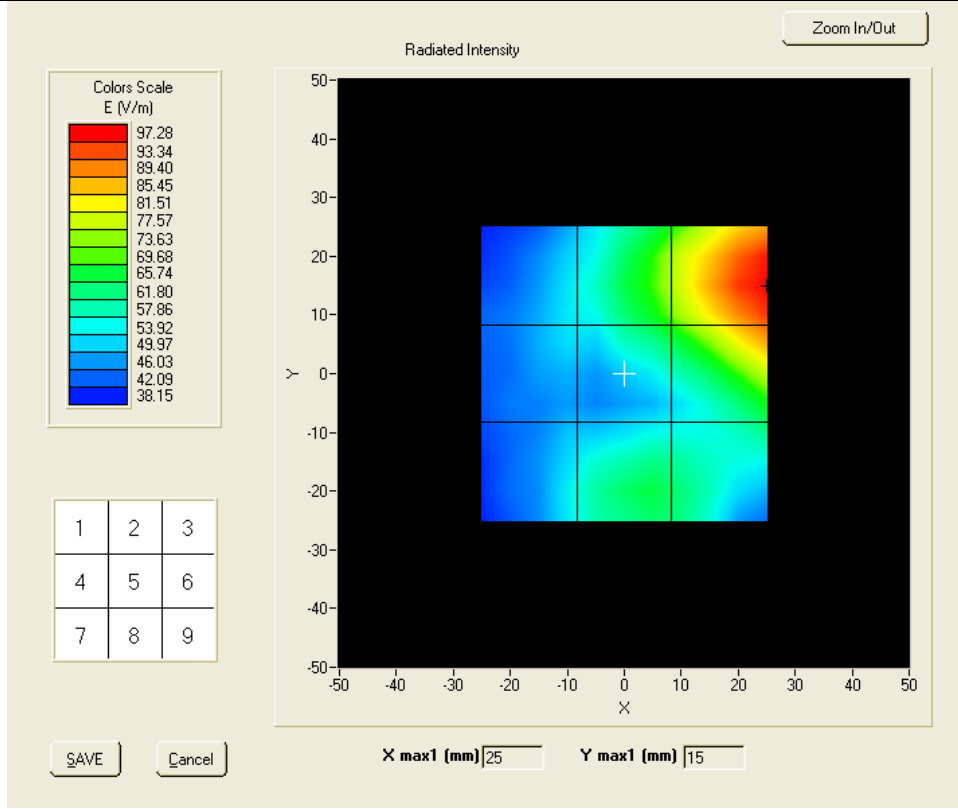

Probe Modulation Factor = 2.83
 Maximum value of total field = 72.15 V/m
 Hearing Aid Near-Field Category: M3 (AWF -5 dB)

E In V/M

Grid 1: 53.37	Grid 2: 77.35	Grid 3: 97.46
Grid 4: 52.12	Grid 5: 72.15	Grid 6: 93.23
Grid 7: 55.74	Grid 8: 65.33	Grid 9: 63.26

Test Item 12

GSM1900

higher Band

Frequency (MHz): 1909.800000

H-Field

Surface HAC

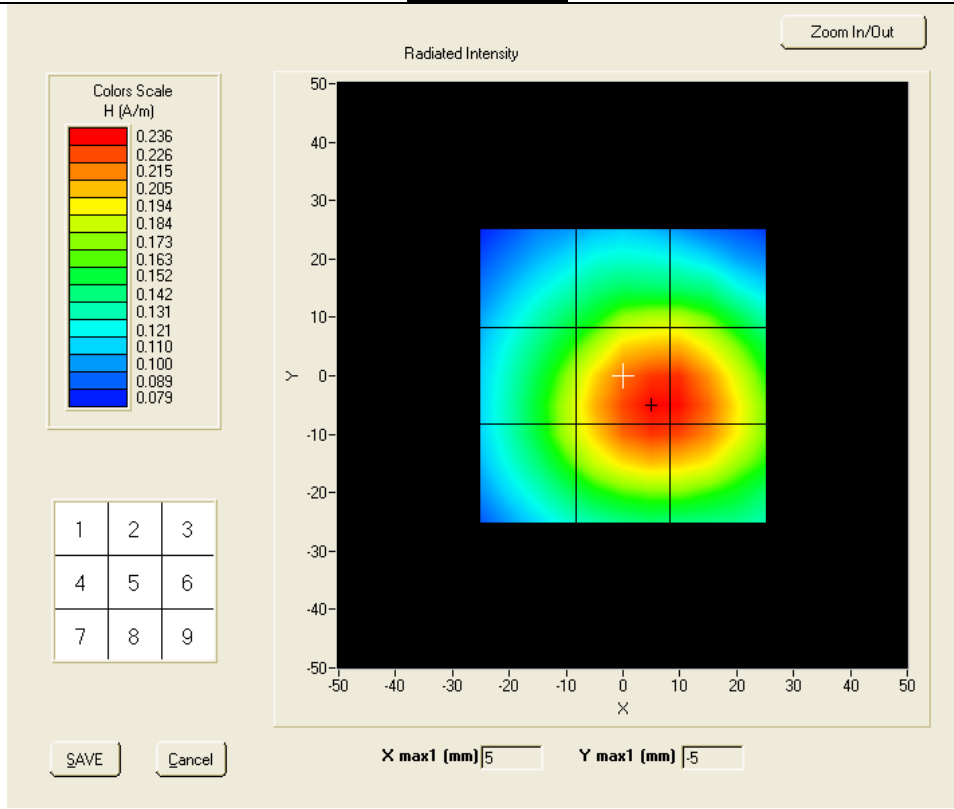

Probe Modulation Factor = 2.84
 Maximum value of total field = 0.24 A/m
 Hearing Aid Near-Field Category: M3 (AWF -5 dB)

H In A/M

Grid 1: 0.15	Grid 2: 0.18	Grid 3: 0.18
Grid 4: 0.19	Grid 5: 0.24	Grid 6: 0.24
Grid 7: 0.19	Grid 8: 0.23	Grid 9: 0.23



SIEMIC, INC.
Accessing global markets

Title: FCC HAC RF Emission Test Report for GSM Mobile Phone
Model: S748
To: CFR 20.19 , ANSI C63.19:2007

Serial#: 12050024-HAC-RF-V3
Issue Date: Mar 19th 2012
Page: 40 of 74
www.siemac.com

Annex C TEST SETUP PHOTO





SIEMIC, INC.
Accessing global markets

Title: FCC HAC RF Emission Test Report for GSM Mobile Phone
Model: S748
To: CFR 20.19 , ANSI C63.19:2007

Serial#: 12050024-HAC-RF-V3
Issue Date: Mar 19th 2012
Page: 41 of 74
www.siemc.com

Annex D CALIBRATION REPORT



SIEMIC, Inc.

Accessing global markets

Title: FCC HAC RF Emission Test Report for GSM Mobile Phone
Model: S748
To: CFR 20.19 , ANSI C63.19:2007

Serial#: 12050024-HAC-RF-V3
Issue Date: Mar 19th 2012
Page: 42 of 74
www.siemc.com



COMOHAC H-Field Probe Calibration

Ref : ACR.158.2.11.SATU.A

SIEMIC TESTING AND CERTIFICATION SERVICES

SUITE 311, BUILDING 1, SECTION 30 ,NO.2 KEFA ROAD,
SCIENCE AND TECHNOLOGY PARK
NAN SHAN DISTRICT, SHENZHEN 518057 , GUANGDONG
,P.R.C.

SATIMO COMOHAC H-FIELD PROBE

Calibrated at SATIMO US
2105 Barrett Park Dr. - Kennesaw, GA 30144



06/01/2011

Summary:

This document presents the method and results from an accredited COMOHAC H-Field Probe calibration performed in SATIMO USA using the CALIBAIR test bench, for use with a SATIMO COMOHAC system only. All calibration results are traceable to national metrology institutions.



COMOHAC H-FIELD PROBE CALIBRATION REPORT

Ref: ACR.158.2.11.SATUA

	<i>Name</i>	<i>Function</i>	<i>Date</i>	<i>Signature</i>
<i>Prepared by :</i>	Jérôme LUC	Product Manager	6/7/2011	<i>JS</i>
<i>Checked by :</i>	Jérôme LUC	Product Manager	6/7/2011	<i>JS</i>
<i>Approved by :</i>	Kim RUTKOWSKI	Quality Manager	6/7/2011	<i>Kim Rutkowski</i>

	<i>Customer Name</i>
<i>Distribution :</i>	SIEMIC Testing and Certification Services

<i>Issue</i>	<i>Date</i>	<i>Modifications</i>
A	6/7/2011	Initial release



TABLE OF CONTENTS

1 Device Under Test 4

2 Product Description 4

 2.1 General Information 4

3 Measurement Method 4

 3.1 Linearity 4

 3.2 Sensitivity 5

 3.3 Isotropy 5

 3.4 Probe Modulation Response 5

4 Measurement Uncertainty 5

5 Calibration Measurement Results 5

 5.1 Sensitivity in air 6

 5.2 Linearity 7

 5.3 Isotropy 8

6 List of Equipment 9



1 DEVICE UNDER TEST

Device Under Test	
Device Type	COMOHAC H FIELD PROBE
Manufacturer	Satimo
Model	SCH
Serial Number	SN 43/10 HPH42
Product Condition (new / used)	New
Frequency Range of Probe	0.7GHz-2.5GHz
Resistance of Three Loops at Connector	Loop 1: R1=0.427 MΩ Loop 2: R2=0.448 MΩ Loop 3: R3=0.485 MΩ

A yearly calibration interval is recommended.

2 PRODUCT DESCRIPTION

2.1 GENERAL INFORMATION

Satimo's COMOHAC H field Probes are built in accordance to the ANSI C63.19 and IEEE 1309 standards.



Figure 1 – Satimo COMOHAC H field Probe

Probe Length	330 mm
Dimension of one loop	3.3 mm
Maximum external diameter	8 mm
Probe Tip External Diameter	5 mm
Distance between loops / probe extremity	3 mm

3 MEASUREMENT METHOD

All methods used to perform the measurements and calibrations comply with the ANSI C63.19 and IEEE 1309 standards.

3.1 LINEARITY

The linearity was determined using a standard dipole with the probe positioned 10 mm above the dipole. The input power of the dipole was adjusted from -15 to 36 dBm using a 1dB step (to cover the range 0.01A/m to 2A/m).



3.2 SENSITIVITY

The sensitivity factors of the three loops were determined using the waveguide method outlined in the fore mentioned standards.

3.3 ISOTROPY

The axial isotropy was evaluated by exposing the probe to a reference wave from a standard dipole. The probe was rotated along its main axis from 0 - 360 degrees in 15 degree steps.

3.4 PROBE MODULATION RESPONSE

The modulation factor was determined by illuminating the probe with a reference wave from a standard dipole 10 mm away, applying first a CW signal and then a modulated signal (both at same power level). The modulation factor is the ratio, in linear units, of the CW to modulated signal reading.

4 MEASUREMENT UNCERTAINTY

The guidelines outlined in the IEEE 1528 and IEC/CEI 62209 standards were followed to generate the measurement uncertainty associated with an H-field probe calibration using the waveguide technique. All uncertainties listed below represent an expanded uncertainty expressed at approximately the 95% confidence level using a coverage factor of k=2, traceable to the Internationally Accepted Guides to Measurement Uncertainty.

Uncertainty analysis of the probe calibration in waveguide					
ERROR SOURCES	Uncertainty value (%)	Probability Distribution	Divisor	ci	Standard Uncertainty (%)
Incident or forward power	3.00%	Rectangular	$\sqrt{3}$	1	1.732%
Reflected power	3.00%	Rectangular	$\sqrt{3}$	1	1.732%
Field homogeneity	3.00%	Rectangular	$\sqrt{3}$	1	1.732%
Field probe positioning	5.00%	Rectangular	$\sqrt{3}$	1	2.887%
Field probe linearity	3.00%	Rectangular	$\sqrt{3}$	1	1.732%
Combined standard uncertainty					4.509%
Expanded uncertainty 95 % confidence level k = 2					9.018%

5 CALIBRATION MEASUREMENT RESULTS

Calibration Parameters	
Lab Temperature	21 °C
Lab Humidity	45 %



5.1 SENSITIVITY IN AIR

Frequency	Normx loop 1 (mV/(A/m) ²)	Normy loop 2 (mV/(A/m) ²)	Normz loop 3 (mV/(A/m) ²)
0.7-1.0 GHz	57.4	63.2	55.3
1.7-2.0 GHz	284.1	322.8	291.4

DCP dipole 1 (mV)	DCP dipole 2 (mV)	DCP dipole 3 (mV)
120	121	119

Calibration curves

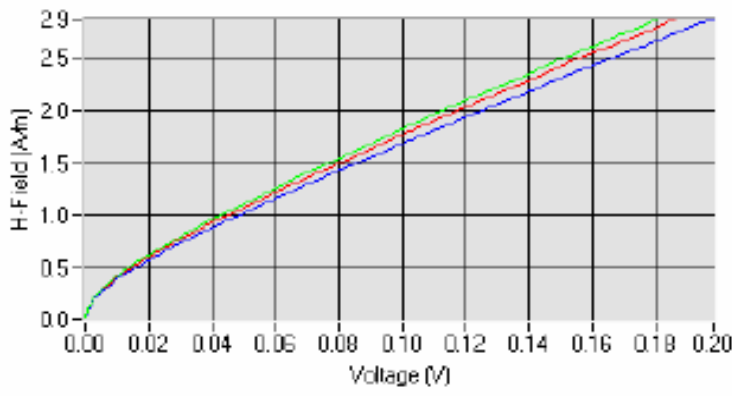

Loop 1
Loop 2
Loop 3

Calibration curves at 835 MHz

Calibration curves

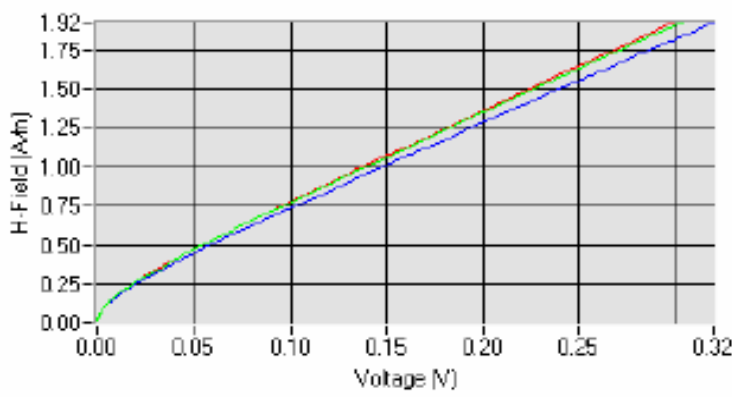

Loop 1
Loop 2
Loop 3

Calibration curves at 1900 MHz



5.2 LINEARITY

Linearity

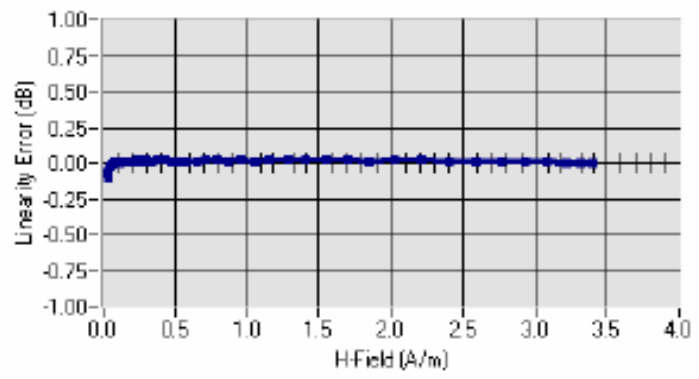

Linearity: $\pm 2.37\%$ (± 0.10 dB)

Linearity at 835 MHz

Linearity

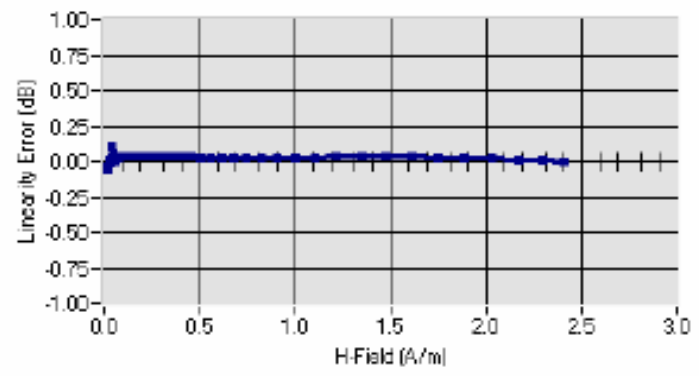

Linearity: $\pm 2.45\%$ (± 0.11 dB)

Linearity at 1900 MHz



SIEMIC, Inc.

Accessing global markets

Title: FCC HAC RF Emission Test Report for GSM Mobile Phone
Model: S748
To: CFR 20.19, ANSI C63.19:2007

Serial#: 12050024-HAC-RF-V3
Issue Date: Mar 19th 2012
Page: 49 of 74
www.siemac.com



COMOHA C H-FIELD PROBE CALIBRATION REPORT

Ref: ACR.158.2.11.SATUA

5.3 ISOTROPY

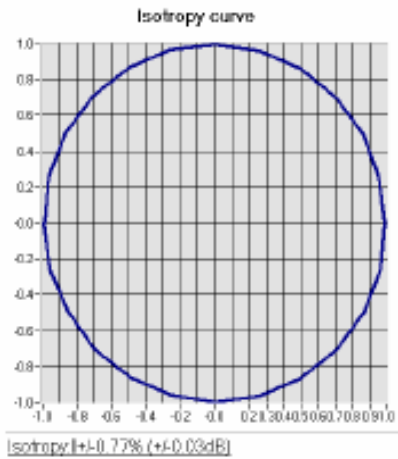

Isotropy at 835 MHz

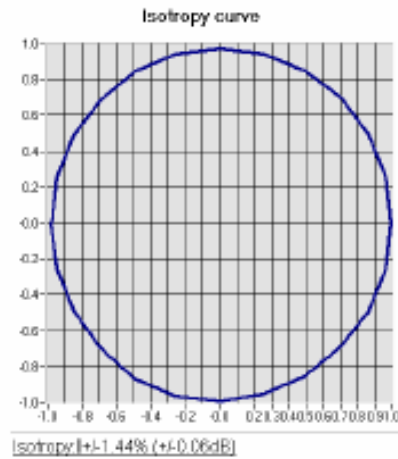

Isotropy at 1900 MHz



6 LIST OF EQUIPMENT

Equipment Summary Sheet				
Equipment Description	Manufacturer / Model	Identification No.	Current Calibration Date	Next Calibration Date
HAC positioning ruler	Satimo	TABH12 SN 42/09	Validated. No cal required.	Validated. No cal required.
COMOHAC Test Bench	Version 2	NA	Validated. No cal required.	Validated. No cal required.
Network Analyzer	Rhode & Schwarz ZVA	SN100132	02/2010	02/2013
Reference Probe	Satimo	EPH28 SN 08/11	Characterized prior to test. No cal required.	Characterized prior to test. No cal required.
Reference Probe	Satimo	HPH38 SN31/10	Characterized prior to test. No cal required.	Characterized prior to test. No cal required.
Multimeter	Keithley 2000	1188656	11/2010	11/2013
Signal Generator	Agilent E4438C	MY49070581	12/2010	12/2013
Amplifier	Aethercomm	SN 046	Characterized prior to test. No cal required.	Characterized prior to test. No cal required.
Power Meter	HP E4418A	US38261498	11/2010	11/2013
Power Sensor	HP ECP-E26A	US37181460	11/2010	11/2013
Directional Coupler	Narda 4216-20	01386	Characterized prior to test. No cal required.	Characterized prior to test. No cal required.
Waveguide	Mega Industries	069Y7-158-13-712	Validated. No cal required.	Validated. No cal required.
Waveguide Transition	Mega Industries	069Y7-158-13-701	Validated. No cal required.	Validated. No cal required.
Waveguide Termination	Mega Industries	069Y7-158-13-701	Validated. No cal required.	Validated. No cal required.
Temperature / Humidity Sensor	Control Company	11-661-9	3/2010	3/2012



SIEMIC, Inc.

Accessing global markets

Title: FCC HAC RF Emission Test Report for GSM Mobile Phone
Model: S748
To: CFR 20.19 , ANSI C63.19:2007

Serial#: 12050024-HAC-RF-V3
Issue Date: Mar 19th 2012
Page: 51 of 74
www.siemic.com



COMOHAC E-Field Probe Calibration Report

Ref: ACR.158.1.11.SATU.A

SIEMIC TESTING AND CERTIFICATION SERVICES

SUITE 311, BUILDING 1, SECTION 30 ,NO.2 KEFA ROAD,
SCIENCE AND TECHNOLOGY PARK
NAN SHAN DISTRICT, SHENZHEN 518057 , GUANGDONG
,P.R.C.

SATIMO COMOHAC E-FIELD PROBE

Calibrated at SATIMO US
2105 Barrett Park Dr. - Kennesaw, GA 30144



06/01/2011

Summary:

This document presents the method and results from an accredited COMOHAC E-Field Probe calibration performed in SATIMO USA using the CALIBAIR test bench, for use with a SATIMO COMOHAC system only. All calibration results are traceable to national metrology institutions.



COMOHAC E-FIELD PROBE CALIBRATION REPORT

Ref: ACR.158.1.11.SATU.A

	<i>Name</i>	<i>Function</i>	<i>Date</i>	<i>Signature</i>
<i>Prepared by :</i>	Jérôme LUC	Product Manager	6/7/2011	<i>JS</i>
<i>Checked by :</i>	Jérôme LUC	Product Manager	6/7/2011	<i>JS</i>
<i>Approved by :</i>	Kim RUTKOWSKI	Quality Manager	6/7/2011	<i>Kim Rutkowski</i>

	<i>Customer Name</i>
<i>Distribution :</i>	SIEMIC Testing and Certification Services

<i>Issue</i>	<i>Date</i>	<i>Modifications</i>
A	6/7/2011	Initial release



TABLE OF CONTENTS

1 Device Under Test..... 3

2 Product Description..... 3

 2.1 General Information..... 3

3 Measurement Method..... 3

 3.1 Linearity..... 3

 3.2 Sensitivity..... 3

 3.3 Isotropy..... 3

 3.4 Probe Modulation Response..... 3

4 Measurement Uncertainty..... 3

5 Calibration Measurement Results..... 3

 5.1 Sensitivity in air..... 3

 5.2 Linearity..... 3

 5.3 Isotropy..... 3

6 List of Equipment..... 3

1 DEVICE UNDER TEST

Device Under Test



Device Type	COMOHAC E FIELD PROBE
Manufacturer	Satimo
Model	SCE
Serial Number	SN 24/11 EPH30
Product Condition (new / used)	New
Frequency Range of Probe	0.7GHz-2.5GHz
Resistance of Three Dipoles at Connector	Dipole 1: R1=2.985 MΩ Dipole 2: R2=2.574 MΩ Dipole 3: R3=3.128 MΩ

A yearly calibration interval is recommended.

2 PRODUCT DESCRIPTION

2.1 GENERAL INFORMATION

Satimo's COMOHAC E field Probes are built in accordance to the ANSI C63.19 and IEEE 1309 standards.



Figure 1 – Satimo COMOHAC E field Probe

Probe Length	330 mm
Length of Individual Dipoles	3.3 mm
Maximum external diameter	8 mm
Probe Tip External Diameter	5 mm
Distance between dipoles / probe extremity	3 mm

3 MEASUREMENT METHOD

All methods used to perform the measurements and calibrations comply with the ANSI C63.19 and IEEE 1309 standards.

3.1 LINEARITY

The linearity was determined using a standard dipole with the probe positioned 10 mm above the dipole. The input power of the dipole was adjusted from -15 to 36 dBm using a 1dB step (to cover the range 2V/m to 1000A/m).

3.2 SENSITIVITY

The sensitivity factors of the three dipoles were determined using the waveguide method outlined in the fore mentioned standards.



3.3 ISOTROPY

The axial isotropy was evaluated by exposing the probe to a reference wave from a standard dipole. The probe was rotated along its main axis from 0 - 360 degrees in 15 degree steps.

3.4 PROBE MODULATION RESPONSE

The modulation factor was determined by illuminating the probe with a reference wave from a standard dipole 10 mm away, applying first a CW signal and then a modulated signal (both at same power level). The modulation factor is the ratio, in linear units, of the CW to modulated signal reading.

4 MEASUREMENT UNCERTAINTY

The guidelines outlined in the IEEE 1528 and IEC/CEI 62209 standards were followed to generate the measurement uncertainty associated with an E-field probe calibration using the waveguide technique. All uncertainties listed below represent an expanded uncertainty expressed at approximately the 95% confidence level using a coverage factor of k=2, traceable to the Internationally Accepted Guides to Measurement Uncertainty.

Uncertainty analysis of the probe calibration in waveguide					
ERROR SOURCES	Uncertainty value (%)	Probability Distribution	Divisor	ci	Standard Uncertainty (%)
Incident or forward power	3.00%	Rectangular	$\sqrt{3}$	1	1.732%
Reflected power	3.00%	Rectangular	$\sqrt{3}$	1	1.732%
Field homogeneity	3.00%	Rectangular	$\sqrt{3}$	1	1.732%
Field probe positioning	5.00%	Rectangular	$\sqrt{3}$	1	2.887%
Field probe linearity	3.00%	Rectangular	$\sqrt{3}$	1	1.732%
Combined standard uncertainty					4.509%
Expanded uncertainty 95 % confidence level k = 2					9.018%

5 CALIBRATION MEASUREMENT RESULTS

Calibration Parameters	
Lab Temperature	21 °C
Lab Humidity	45 %



5.1 SENSITIVITY IN AIR

Normx dipole 1 ($\mu\text{V}/(\text{V}/\text{m})^2$)	Normy dipole 2 ($\mu\text{V}/(\text{V}/\text{m})^2$)	Normz dipole 3 ($\mu\text{V}/(\text{V}/\text{m})^2$)
19.62	14.77	20.37

DCP dipole 1 (mV)	DCP dipole 2 (mV)	DCP dipole 3 (mV)
114	105	119

Calibration curves

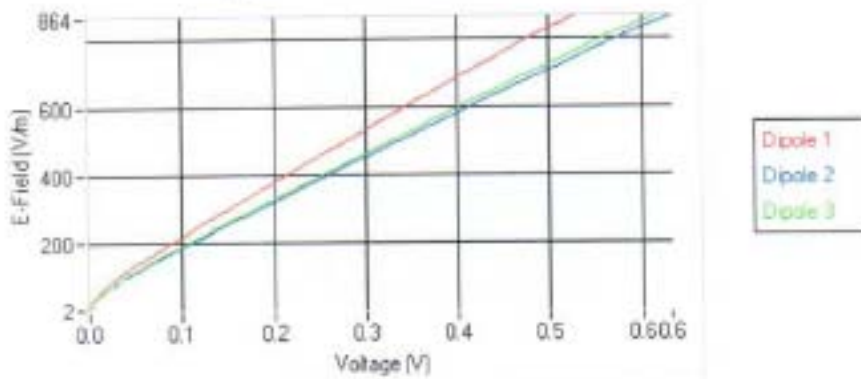

5.2 LINEARITY

Linearity

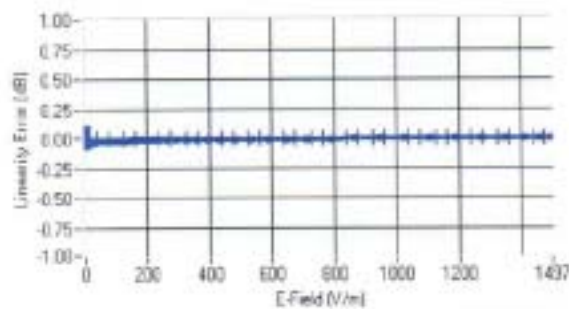

Linearity $\pm 2.03\%$ ($\pm 0.09\text{dB}$)



5.3 ISOTROPY

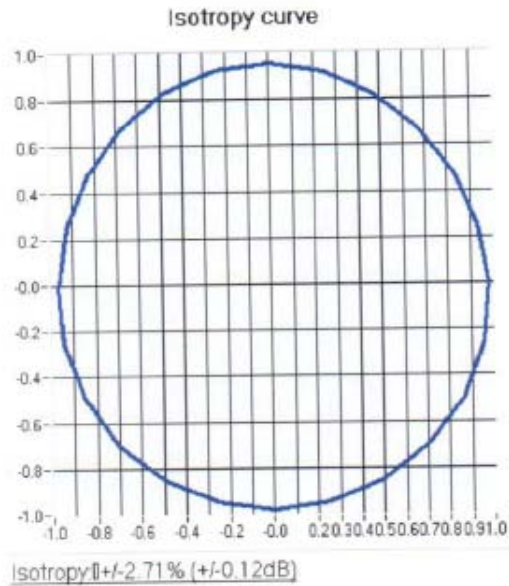



6 LIST OF EQUIPMENT

Equipment Summary Sheet				
Equipment Description	Manufacturer / Model	Identification No.	Current Calibration Date	Next Calibration Date
HAC positioning ruler	Satimo	TABH12 SN 42/09	Validated. No cal required.	Validated. No cal required.
COMOHAC Test Bench	Version 2	NA	Validated. No cal required.	Validated. No cal required.
Network Analyzer	Rhode & Schwarz ZVA	SN100132	02/2010	02/2013
Reference Probe	Satimo	EPH28 SN 08/11	Characterized prior to test. No cal required.	Characterized prior to test. No cal required.
Reference Probe	Satimo	HPH38 SN31/10	Characterized prior to test. No cal required.	Characterized prior to test. No cal required.
Multimeter	Keithley 2000	1188656	11/2010	11/2013
Signal Generator	Agilent E4438C	MY49070581	12/2010	12/2013
Amplifier	Aethercomm	SN 046	Characterized prior to test. No cal required.	Characterized prior to test. No cal required.
Power Meter	HP E4418A	US38261498	11/2010	11/2013
Power Sensor	HP ECP-E26A	US37181460	11/2010	11/2013
Directional Coupler	Narda 4216-20	01386	Characterized prior to test. No cal required.	Characterized prior to test. No cal required.
Waveguide	Mega Industries	069Y7-158-13-712	Validated. No cal required.	Validated. No cal required.
Waveguide Transition	Mega Industries	069Y7-158-13-701	Validated. No cal required.	Validated. No cal required.
Waveguide Termination	Mega Industries	069Y7-158-13-701	Validated. No cal required.	Validated. No cal required.
Temperature / Humidity Sensor	Control Company	11-661-9	3/2010	3/2012



SIEMIC, Inc.

Accessing global markets

Title: FCC HAC RF Emission Test Report for GSM Mobile Phone
Model: S748
To: CFR 20.19 , ANSI C63.19:2007

Serial#: 12050024-HAC-RF-V3
Issue Date: Mar 19th 2012
Page: 59 of 74
www.siemc.com



HAC Reference Dipole Calibration Report

Ref : ACR.158.12.11.SATU.A

SIEMIC TESTING AND CERTIFICATION SERVICES

SUITE 311, BUILDING 1, SECTION 30 ,NO.2 KEFA ROAD,
SCIENCE AND TECHNOLOGY PARK
NAN SHAN DISTRICT, SHENZHEN 518057 , GUANGDONG
,P.R.C.

SATIMO COMOHAC REFERENCE DIPOLE

Calibrated at SATIMO US
2105 Barrett Park Dr. - Kennesaw, GA 30144



06/01/2011

Summary:

This document presents the method and results from an accredited HAC reference dipole calibration performed in SATIMO USA using the COMOHAC test bench. All calibration results are traceable to national metrology institutions.



HAC REFERENCE DIPOLE CALIBRATION REPORT

Ref: ACR.158.12.11.SATUA

	<i>Name</i>	<i>Function</i>	<i>Date</i>	<i>Signature</i>
<i>Prepared by :</i>	Jérôme LUC	Product Manager	6/7/2011	<i>[Signature]</i>
<i>Checked by :</i>	Jérôme LUC	Product Manager	6/7/2011	<i>[Signature]</i>
<i>Approved by :</i>	Kim RUTKOWSKI	Quality Manager	6/7/2011	<i>Kim Rutkowski</i>

	<i>Customer Name</i>
<i>Distribution :</i>	SIEMIC Testing and Certification Services

<i>Issue</i>	<i>Date</i>	<i>Modifications</i>
A	6/7/2011	Initial release



TABLE OF CONTENTS

1 Introduction..... 4

2 Device Under TEst..... 4

3 Product Description 4

 3.1 General Information _____ 4

4 Measurement Method 4

 4.1 Return Loss Requirements _____ 5

 4.2 Reference Dipole Calibration _____ 5

5 Measurement Uncertainty 5

 5.1 Return Loss _____ 5

 5.2 Validation Measurement _____ 5

6 Calibration Measurement Results 6

 6.1 Return Loss _____ 6

 6.2 Validation measurement _____ 6

7 List of Equipment 8



1 INTRODUCTION

This document contains a summary of the requirements set forth by the ANSI C63.19 standard for reference dipoles used for HAC measurement system validations and the measurements that were performed to verify that the product complies with the fore mentioned standards.

2 DEVICE UNDER TEST

Device Under Test	
Device Type	COMOHAC 800-950 MHz REFERENCE DIPOLE
Manufacturer	Satimo
Model	SIDB835
Serial Number	SN 24/11 DHA31
Product Condition (new / used)	new

A yearly calibration interval is recommended.

3 PRODUCT DESCRIPTION

3.1 GENERAL INFORMATION

Satimo's COMOHAC Validation Dipoles are built in accordance to the ANSI C63.19 standard. The product is designed for use with the COMOHAC system only.



Figure 1 – Satimo COMOHAC Validation Dipole

4 MEASUREMENT METHOD

The ANSI C63.19 standard outlines the requirements for reference dipoles to be used for system validation measurements. The following measurements were performed to verify that the product complies with the fore mentioned standard.



4.1 RETURN LOSS REQUIREMENTS

The dipole used for HAC system validation measurements and checks must have a return loss of -10 dB or better. The return loss measurement shall be performed in free space.

4.2 REFERENCE DIPOLE CALIBRATION

The IEEE ANSI C63-19 standard states that the dipole used for validation measurements and checks must be scanned with the E and H field probe, with the dipole 10 mm below the probe. The E and H field strength plots are compared to the simulation results obtained by SATIMO.

5 MEASUREMENT UNCERTAINTY

All uncertainties listed below represent an expanded uncertainty expressed at approximately the 95% confidence level using a coverage factor of k=2, traceable to the Internationally Accepted Guides to Measurement Uncertainty.

5.1 RETURN LOSS

The following uncertainties apply to the return loss measurement:

Frequency band	Expanded Uncertainty on Gain
400-6000MHz	0.1 dB

5.2 VALIDATION MEASUREMENT

The guideline outlined in the IEEE ANSI C63.19 standard was followed to generate the measurement uncertainty for validation measurements.

Uncertainty analysis of the probe calibration in waveguide					
ERROR SOURCES	Uncertainty value (%)	Probability Distribution	Divisor	Uncertainty (dB)	Standard Uncertainty (%)
RF reflections	0.1	R	$\sqrt{3}$	0.06	
Field probe conv. Factor	0.2	R	$\sqrt{3}$	0.12	
Field probe anisotropy	0.25	R	$\sqrt{3}$	0.14	
Positioning accuracy	0.1	R	$\sqrt{3}$	0.06	
Probe cable placement	0.1	R	$\sqrt{3}$	0.06	
System repeatability	0.2	R	$\sqrt{3}$	0.12	
EUT repeatability	0.1	N	1	0.10	
Combined standard uncertainty				0.26	
Expanded uncertainty 95 % confidence level k = 2				0.52	12.71



6 CALIBRATION MEASUREMENT RESULTS

6.1 RETURN LOSS

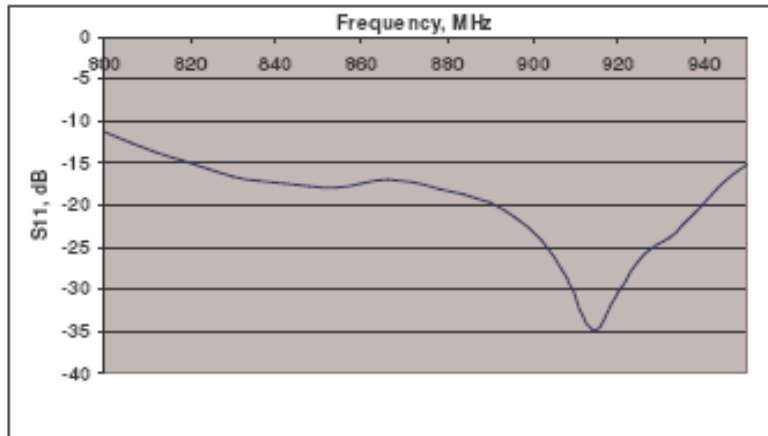

Frequency (MHz)	Worst Case Return Loss (dB)	Requirement (dB)
800-950 MHz	-20.00	-10

6.2 VALIDATION MEASUREMENT

The IEEE ANSI C63.19 standard states that the system validation measurements must be performed using a reference dipole meeting the fore mentioned return loss requirements. The system validations measurement results are then compared to SATIMO's simulated results.

Measurement Condition

Software Version	OpenHAC V2
HAC positioning ruler	SN 42/09 TABH12
E-Field probe	SN 08/11 EPH28
H-Field probe	SN 31/10 HPH38
Distance between dipole and sensor center	10 mm
E-field scan size	X=150mm/Y=20mm
H-field scan size	X=40mm/Y=20mm
Scan resolution	dx=5mm/dy=5mm
Frequency	835 MHz
Input power	20 dBm
Lab Temperature	21 °C
Lab Humidity	45%



Measurement Result

	Measured	Internal Requirement
E field (V/m)	213.27	210.4
H field (A/m)	0.44	0.445

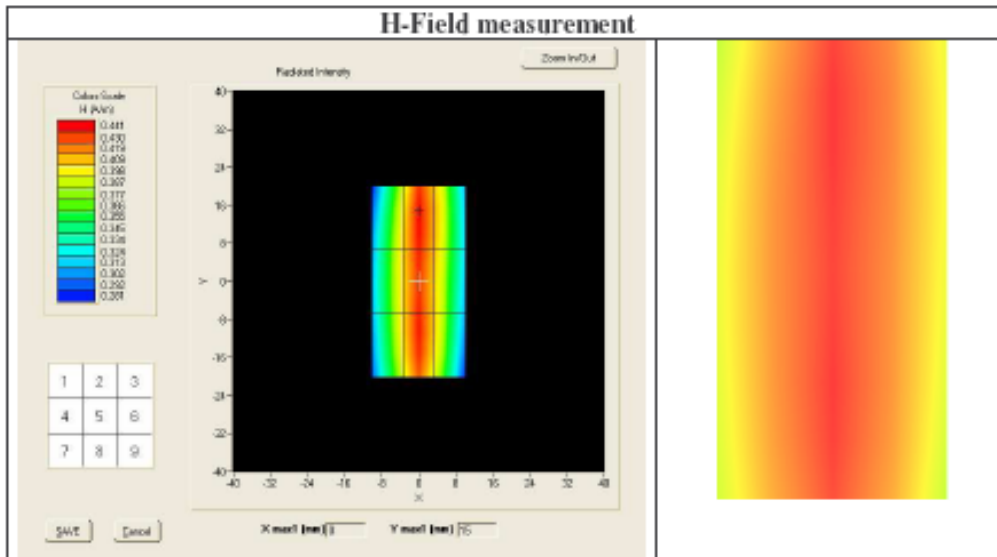
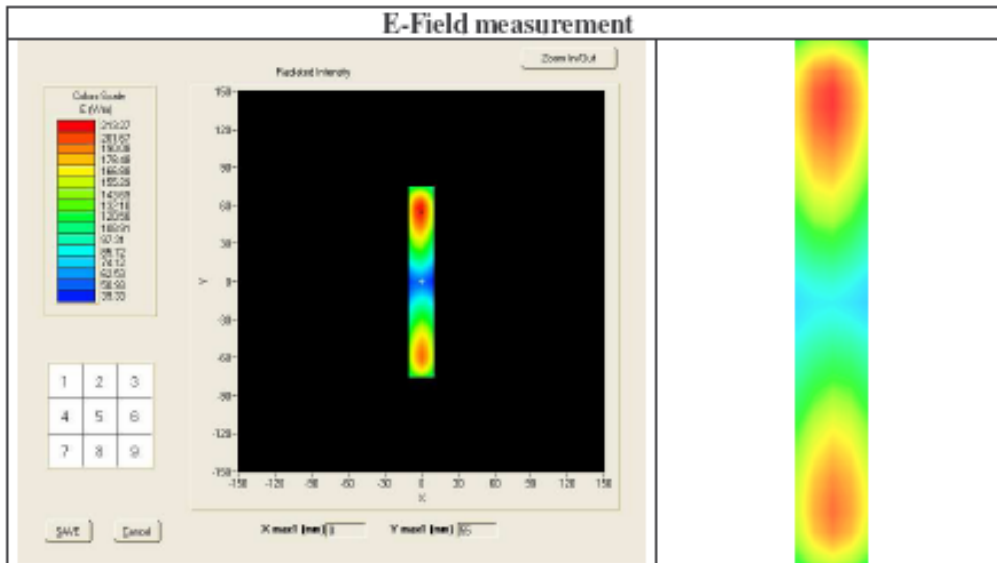



7 LIST OF EQUIPMENT

Equipment Summary Sheet				
Equipment Description	Manufacturer / Model	Identification No.	Current Calibration Date	Next Calibration Date
HAC positioning ruler	Satimo	TABH12 SN 42/09	Validated. No cal required.	Validated. No cal required.
COMOHAC Test Bench	Version 2	NA	Validated. No cal required.	Validated. No cal required.
Network Analyzer	Rhode & Schwarz ZVA	SN100132	02/2010	02/2013
Reference Probe	Satimo	EPH28 SN 08/11	Characterized prior to test. No cal required.	Characterized prior to test. No cal required.
Reference Probe	Satimo	HPH38 SN31/10	Characterized prior to test. No cal required.	Characterized prior to test. No cal required.
Multimeter	Keithley 2000	1188656	11/2010	11/2013
Signal Generator	Agilent E4438C	MY49070581	12/2010	12/2013
Amplifier	Aethercomm	SN 046	Characterized prior to test. No cal required.	Characterized prior to test. No cal required.
Power Meter	HP E4418A	US38261498	11/2010	11/2013
Power Sensor	HP ECP-E26A	US37181460	11/2010	11/2013
Directional Coupler	Narda 4216-20	01386	Characterized prior to test. No cal required.	Characterized prior to test. No cal required.
Temperature and Humidity Sensor	Control Company	11-661-9	3/2010	3/2012



SIEMIC, Inc.

Accessing global markets

Title: FCC HAC RF Emission Test Report for GSM Mobile Phone
Model: S748
To: CFR 20.19 , ANSI C63.19:2007

Serial#: 12050024-HAC-RF-V3
Issue Date: Mar 19th 2012
Page: 67 of 74
www.siemc.com



HAC Reference Dipole Calibration Report

Ref : ACR.158.13.11.SATU.A

SIEMIC TESTING AND CERTIFICATION SERVICES

SUITE 311, BUILDING 1, SECTION 30 ,NO.2 KEFA ROAD,
SCIENCE AND TECHNOLOGY PARK
NAN SHAN DISTRICT, SHENZHEN 518057 , GUANGDONG
,P.R.C.

SATIMO COMOHAC REFERENCE DIPOLE

Calibrated at SATIMO US
2105 Barrett Park Dr. - Kennesaw, GA 30144



06/01/2011

Summary:

This document presents the method and results from an accredited HAC reference dipole calibration performed in SATIMO USA using the COMOHAC test bench. All calibration results are traceable to national metrology institutions.



HAC REFERENCE DIPOLE CALIBRATION REPORT

Ref: ACR.158.13.11.SATUA

	<i>Name</i>	<i>Function</i>	<i>Date</i>	<i>Signature</i>
<i>Prepared by :</i>	Jérôme LUC	Product Manager	6/7/2011	<i>JS</i>
<i>Checked by :</i>	Jérôme LUC	Product Manager	6/7/2011	<i>JS</i>
<i>Approved by :</i>	Kim RUTKOWSKI	Quality Manager	6/7/2011	<i>Kim Rutkowski</i>

	<i>Customer Name</i>
<i>Distribution :</i>	SIEMIC Testing and Certification Services

<i>Issue</i>	<i>Date</i>	<i>Modifications</i>
A	6/7/2011	Initial release



TABLE OF CONTENTS

1 Introduction..... 4

2 Device Under TEst..... 4

3 Product Description 4

 3.1 General Information 4

4 Measurement Method 4

 4.1 Return Loss Requirements 5

 4.2 Reference Dipole Calibration 5

5 Measurement Uncertainty 5

 5.1 Return Loss 5

 5.2 Validation Measurement 5

6 Calibration Measurement Results 6

 6.1 Return Loss 6

 6.2 Validation measurement 6

7 List of Equipment 8



1 INTRODUCTION

This document contains a summary of the requirements set forth by the ANSI C63.19 standard for reference dipoles used for HAC measurement system validations and the measurements that were performed to verify that the product complies with the fore mentioned standards.

2 DEVICE UNDER TEST

Device Under Test	
Device Type	COMOHAC 1700-2000 MHz REFERENCE DIPOLE
Manufacturer	Satimo
Model	SIDB1900
Serial Number	SN 24/11 DHB32
Product Condition (new / used)	new

A yearly calibration interval is recommended.

3 PRODUCT DESCRIPTION

3.1 GENERAL INFORMATION

Satimo's COMOHAC Validation Dipoles are built in accordance to the ANSI C63.19 standard. The product is designed for use with the COMOHAC system only.



Figure 1 – Satimo COMOHAC Validation Dipole

4 MEASUREMENT METHOD

The ANSI C63.19 standard outlines the requirements for reference dipoles to be used for system validation measurements. The following measurements were performed to verify that the product complies with the fore mentioned standard.



4.1 RETURN LOSS REQUIREMENTS

The dipole used for HAC system validation measurements and checks must have a return loss of -10 dB or better. The return loss measurement shall be performed in free space.

4.2 REFERENCE DIPOLE CALIBRATION

The IEEE ANSI C63-19 standard states that the dipole used for validation measurements and checks must be scanned with the E and H field probe, with the dipole 10 mm below the probe. The E and H field strength plots are compared to the simulation results obtained by SATIMO.

5 MEASUREMENT UNCERTAINTY

All uncertainties listed below represent an expanded uncertainty expressed at approximately the 95% confidence level using a coverage factor of k=2, traceable to the Internationally Accepted Guides to Measurement Uncertainty.

5.1 RETURN LOSS

The following uncertainties apply to the return loss measurement:

Frequency band	Expanded Uncertainty on Gain
400-6000MHz	0.1 dB

5.2 VALIDATION MEASUREMENT

The guideline outlined in the IEEE ANSI C63.19 standard was followed to generate the measurement uncertainty for validation measurements.

Uncertainty analysis of the probe calibration in waveguide					
ERROR SOURCES	Uncertainty value (%)	Probability Distribution	Divisor	Uncertainty (dB)	Standard Uncertainty (%)
RF reflections	0.1	R	$\sqrt{3}$	0.06	
Field probe conv. Factor	0.2	R	$\sqrt{3}$	0.12	
Field probe anisotropy	0.25	R	$\sqrt{3}$	0.14	
Positioning accuracy	0.1	R	$\sqrt{3}$	0.06	
Probe cable placement	0.1	R	$\sqrt{3}$	0.06	
System repeatability	0.2	R	$\sqrt{3}$	0.12	
EUT repeatability	0.1	N	1	0.10	
Combined standard uncertainty				0.26	
Expanded uncertainty 95 % confidence level k= 2				0.52	12.71



6 CALIBRATION MEASUREMENT RESULTS

6.1 RETURN LOSS

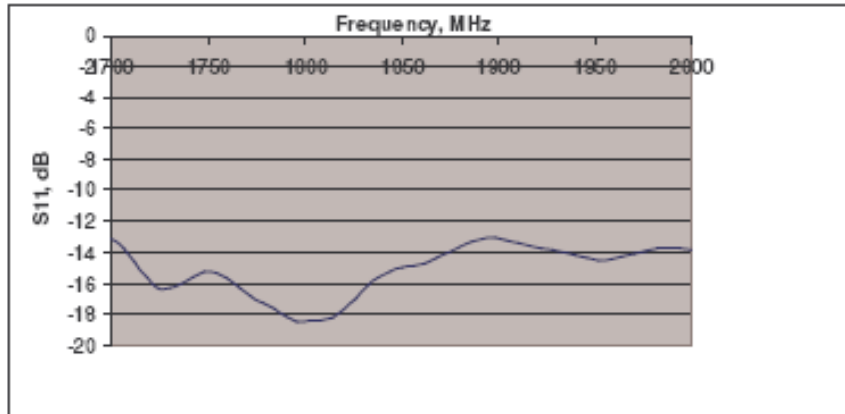

Frequency (MHz)	Worst Case Return Loss (dB)	Requirement (dB)
1700-2000 MHz	-20.00	-10

6.2 VALIDATION MEASUREMENT

The IEEE ANSI C63.19 standard states that the system validation measurements must be performed using a reference dipole meeting the fore mentioned return loss requirements. The system validations measurement results are then compared to SATIMO's simulated results.

Measurement Condition

Software Version	OpenHAC V2
HAC positioning ruler	SN 42/09 TABH12
E-Field probe	SN 08/11 EPH28
H-Field probe	SN 31/10 HPH38
Distance between dipole and sensor center	10 mm
E-field scan size	X= 150mm/Y=20mm
H-field scan size	X=40mm/Y=20mm
Scan resolution	dx=5mm/dy=5mm
Frequency	1900 MHz
Input power	20 dBm
Lab Temperature	21 °C
Lab Humidity	45%

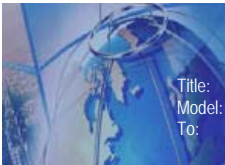

Measurement Result

	Measured	Internal Requirement
E field (V/m)	149.10	153.4
H field (A/m)	0.468	0.445

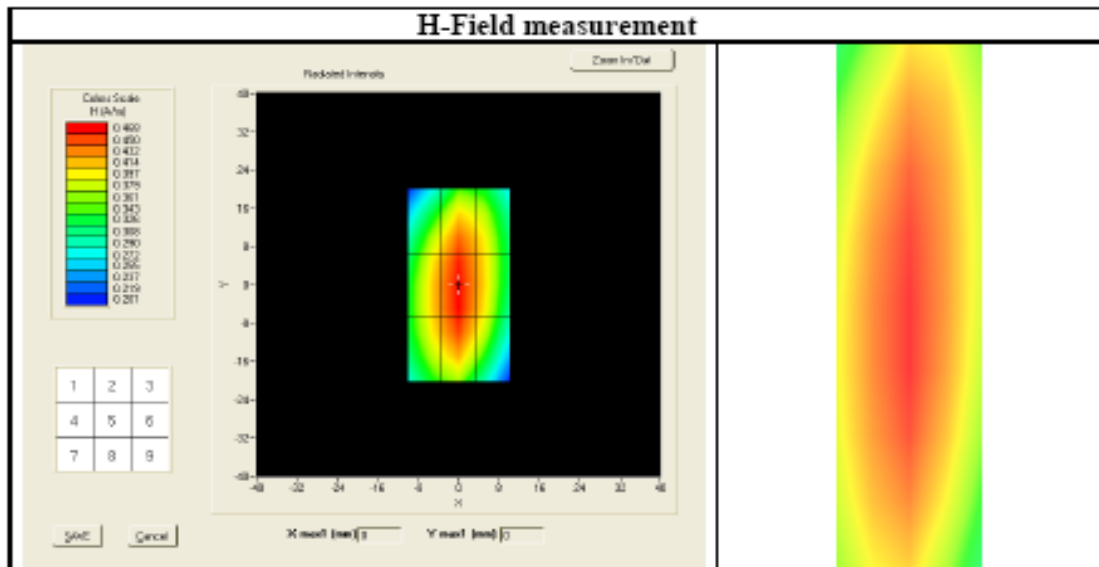
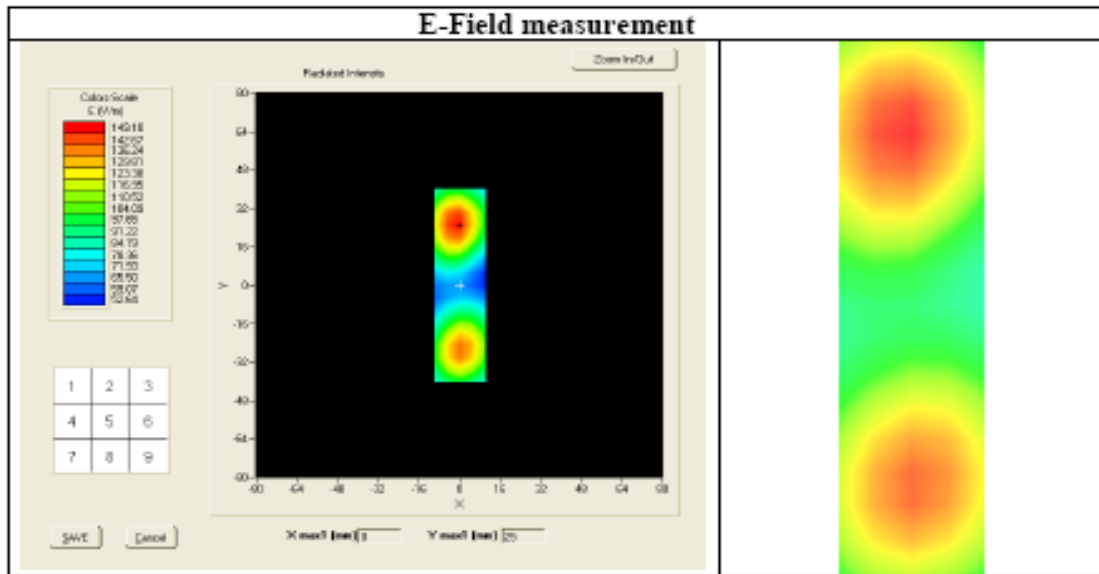



7 LIST OF EQUIPMENT

Equipment Summary Sheet				
Equipment Description	Manufacturer / Model	Identification No.	Current Calibration Date	Next Calibration Date
HAC positioning ruler	Satimo	TABH12 SN 42/09	Validated. No cal required.	Validated. No cal required.
COMOHAC Test Bench	Version 2	NA	Validated. No cal required.	Validated. No cal required.
Network Analyzer	Rhode & Schwarz ZVA	SN100132	02/2010	02/2013
Reference Probe	Satimo	EPH28 SN 08/11	Characterized prior to test. No cal required.	Characterized prior to test. No cal required.
Reference Probe	Satimo	HPH38 SN31/10	Characterized prior to test. No cal required.	Characterized prior to test. No cal required.
Multimeter	Keithley 2000	1188656	11/2010	11/2013
Signal Generator	Agilent E4438C	MY49070581	12/2010	12/2013
Amplifier	Aethercomm	SN 046	Characterized prior to test. No cal required.	Characterized prior to test. No cal required.
Power Meter	HP E4418A	US38261498	11/2010	11/2013
Power Sensor	HP ECP-E26A	US37181460	11/2010	11/2013
Directional Coupler	Narda 4216-20	01386	Characterized prior to test. No cal required.	Characterized prior to test. No cal required.
Temperature and Humidity Sensor	Control Company	11-661-9	3/2010	3/2012