

b- Mobile HK Limited

Qwerty Phone

Main Model: QW125

Serial Model: N/A



July 04, 2014

Report No.: 14050038-FCC-R2
(This report supersedes NONE)



Modifications made to the product : None

This Test Report is Issued Under the Authority of:

		
Wiky Jam Compliance Engineer	Alex Liu Technical Manager	

This test report may be reproduced in full only.
Test result presented in this test report is applicable to the representative sample only.

RF Test Report

To: FCC Part 15.247: 2013, ANSI C63.4: 2009

SIEMIC, INC.
Accessing global markets



Laboratory Introduction

SIEMIC, headquartered in the heart of Silicon Valley, with superior facilities in US and Asia, is one of the leading independent testing and certification facilities providing customers with one-stop shop services for Compliance Testing and Global Certifications.



In addition to [testing](#) and [certification](#), SIEMIC provides initial design reviews and [compliance management](#) through out a project. Our extensive experience with [China](#), [Asia Pacific](#), [North America](#), [European](#), and [international](#) compliance requirements, assures the fastest, most cost effective way to attain regulatory compliance for the [global markets](#).

SIEMIC (Shenzhen - China) Laboratories Accreditations for Conformity Assessment

Country/Region	Scope
USA	EMC , RF/Wireless , Telecom
Canada	EMC, RF/Wireless , Telecom
Taiwan	EMC, RF, Telecom , Safety
Hong Kong	RF/Wireless ,Telecom
Australia	EMC, RF, Telecom , Safety
Korea	EMI, EMS, RF , Telecom, Safety
Japan	EMI, RF/Wireless, Telecom
Singapore	EMC , RF , Telecom
Europe	EMC, RF, Telecom , Safety

This page has been left blank intentionally.

CONTENTS

1 EXECUTIVE SUMMARY & EUT INFORMATION5

2 TECHNICAL DETAILS6

3 MODIFICATION7

4 TEST SUMMARY8

5 MEASUREMENTS, EXAMINATION AND DERIVED RESULTS9

ANNEX A. TEST INSTRUMENT & METHOD62

ANNEX B. EUT AND TEST SETUP PHOTOGRAPHS65

ANNEX C. TEST SETUP AND SUPPORTING EQUIPMENT78

ANNEX D. USER MANUAL / BLOCK DIAGRAM / SCHEMATICS / PART LIST82

ANNEX E. DECLARATION OF SIMILARITY83

1 EXECUTIVE SUMMARY & EUT INFORMATION

The purpose of this test programme was to demonstrate compliance of the b- Mobile HK Limited, Qwerty Phone and model: QW125 against the current Stipulated Standards. The Qwerty Phone has demonstrated compliance with the FCC 15.247: 2013, ANSI C63.4: 2009.

EUT Information

EUT Description	: Qwerty Phone
Main Model	: QW125
Serial Model	: N/A
Antenna Gain	: UMTS-FDD Band V: 1.2 dBi : GSM850: -2 dBi : UMTS-FDD Band II: 1.2 dBi : PCS1900: -1.2 dBi : Bluetooth: 0.3 dBi : WIFI: 0.3 dBi
Input Power	: Battery: : Model: QW125 : Spec: 3.7V 1450mAh : Limited charger voltage: 4.2V : Adapter: : Input: AC 100-240V; 50/60Hz 0.15A : Output: DC 5.0V; 500mA
Classification Per Stipulated Test Standard	: FCC 15.247: 2013, ANSI C63.4: 2009

2 TECHNICAL DETAILS

Purpose	Compliance testing of Qwerty Phone with stipulated standards
Applicant / Client	b- Mobile HK Limited Flat 18; 14/F Block 1; Golden Industrial Building;16-26 Kwai Tak Street; Kwai Chung;New Territories; Hong Kong
Manufacturer	Shenzhen Fortune Ship Technology Co.,Ltd 6th Floor, Kanghesheng Building, Shahe RD West 3009, Xili Town, Nanshan District, Shenzhen
Laboratory performing the tests	SIEMIC (Shenzhen - China) Laboratories Zone A, Floor 1, Building 2, Wan Ye Long Technology Park, South Side of Zhoushi Road, Bao'an District, Shenzhen, Guangdong, China Tel: +86-0755-2601 4629 / 2601 4953 Fax: +86-0755-2601 4953-810 Email: China@siemic.com.cn
Test report reference number	14050038-FCC-R2
Date EUT received	June 18, 2014
Standard applied	FCC 15.247: 2013, ANSI C63.4: 2009
Dates of test (from – to)	July 01 to July 03, 2014
No of Units	#1
Equipment Category	DSS
Trade Name	B mobile
RF Operating Frequency (ies)	GSM850 TX : 824.2 ~ 848.8 MHz; RX : 869.2 ~ 893.8 MHz PCS1900 TX : 1850.2 ~ 1909.8 MHz; RX : 1930.2 ~ 1989.8 MHz UMTS-FDD Band V TX : 826.4 ~ 846.6 MHz; RX : 871.4 ~ 891.6 MHz UMTS-FDD Band II TX :1852.4 ~ 1907.6 MHz; RX : 1932.4 ~ 1987.6 MHz 802.11b/g/n: 2412-2462 MHz Bluetooth: 2402-2480 MHz
Number of Channels	299CH (PCS1900) and 124CH (GSM850) UMTS-FDD Band V : 102CH UMTS-FDD Band II : 277CH Bluetooth: 79CH 802.11b/g/n: 11CH
Modulation	GSM / GPRS: GMSK UMTS-FDD: QPSK 802.11b/g/n: DSSS/OFDM Bluetooth: GFSK& π/4DQPSK&8DPSK
GPRS Multi-slot class	8/10/12
FCC ID	ZSW-QW125



SIEMIC, Inc.

Accessing global markets

Title: RF Test Report for Qwerty Phone
Main Model: QW125
Main Model: N/A
To: FCC 15.247: 2013, ANSI C63.4: 2009

Report No: 14050038-FCC-R2
Issue Date: July 04, 2014
Page: 7 of 83
www.siemec.com
www.siemec.com.cn

3 MODIFICATION

NONE

4 TEST SUMMARY

The product was tested in accordance with the following specifications.
 All testing has been performed according to below product classification:

Spread Spectrum System/Device

Test Results Summary

Test Standard	Description	Product Class	Pass / Fail
§15.247(i), §2.1093	RF Exposure	See Above	Pass
§15.203	Antenna Requirement	See Above	Pass
§15.207(a)	AC Line Conducted Emissions	See Above	Pass
§15.205, §15.209, §15.247(d)	Radiated Emissions	See Above	Pass
§15.247(a)(1)	20 dB Bandwidth	See Above	Pass
§15.247(a)(1)	Channel Separation	See Above	Pass
§15.247(a)(1)(iii)	Time of Occupancy (Dwell Time)	See Above	Pass
§15.247(a)(1)(iii)	Quantity of Hopping Channel	See Above	Pass
§15.247(b)(1)	Peak Output Power	See Above	Pass
§15.247(d)	Band Edge	See Above	Pass

5 MEASUREMENTS, EXAMINATION AND DERIVED RESULTS

5.1 §15.247 (i) and §2.1093 – RF Exposure

Standard Requirement:

According to §15.247 (i) and §1.1307(b)(1), systems operating under the provisions of this section shall be operated in a manner that ensures that the public is not exposed to radio frequency energy level in excess of the Commission’s guidelines.

The 1-g and 10-g SAR test exclusion thresholds for 100 MHz to 6 GHz at *test separation distances* ≤ 50 mm are determined by:

$$[(\text{max. power of channel, including tune-up tolerance, mW}) / (\text{min. test separation distance, mm})] \cdot [\sqrt{f_{\text{GHz}}}] \leq 3.0 \text{ for 1-g SAR and } \leq 7.5 \text{ for 10-g extremity SAR,}^{16} \text{ where}$$

- f_{GHz} is the RF channel transmit frequency in GHz
- Power and distance are rounded to the nearest mW and mm before calculation¹⁷
- The result is rounded to one decimal place for comparison

The test exclusions are applicable only when the minimum *test separation distance* is ≤ 50 mm and for transmission frequencies between 100 MHz and 6 GHz. When the minimum *test separation distance* is < 5 mm, a distance of 5 mm is applied to determine SAR test exclusion.

Routine SAR evaluation refers to that specifically required by § 2.1093, using measurements or computer simulation. When routine SAR evaluation is not required, portable transmitters with output power greater than the applicable low threshold require SAR evaluation to qualify for TCB approval.

Two antennas are available for the EUT (GSM antenna, Bluetooth/WIFI antenna).
 The maximum average output power(turn-up power) in low channel of Bluetooth is 7.282 dBm= 5.35 mW
 The calculation results= $5.35 / 5 * \sqrt{2.402} = 1.66 < 3$

The maximum average output power(turn-up power) in middle channel of Bluetooth is 7.444 dBm=5.55 mW
 The calculation results= $5.55 / 5 * \sqrt{2.441} = 1.73 < 3$

The maximum average output power(turn-up power) in high channel of Bluetooth is 7.525 dBm= 5.66 mW
 The calculation results= $5.66 / 5 * \sqrt{2.480} = 1.78 < 3$

According to KDB 447498, no stand-alone required for Bluetooth antenna, and no simultaneous SAR measurement is required , please refer to SAR report.

Test Result: Pass

5.2 §15.203 – Antenna Requirement

Standard Requirement:

According to § 15.203, an intentional radiator shall be designed to ensure that no antenna other than that furnished by the responsible party shall be used with the device. The use of a permanently attached antenna or of an antenna that uses a unique coupling to the intentional radiator shall be considered sufficient to comply with the provisions of this section. The manufacturer may design the unit so that a broken antenna can be replaced by the user, but the user of a standard antenna jack or electrical connector is prohibited. The structure and application of the EUT were analyzed to determine compliance with section §15.203 of the rules. §15.203 state that the subject device must meet the following criteria:

- a. Antenna must be permanently attached to the unit.
- b. Antenna must use a unique type of connector to attach to the EUT.
- c. Unit must be professionally installed, and installer shall be responsible for verifying that the correct antenna is employed with the unit.

And according to FCC 47 CFR section 15.247 (b), if the transmitting antennas of directional gain greater than 6dBi are used, the power shall be reduced by the amount in dB that the directional gain of the antenna exceeds 6 dBi.

Antenna Connector Construction

The EUT has 2 antennas: a PIFA antenna for WIFI/Bluetooth, the gain is 0.3 dBi for WIFI, 0.3 dBi for Bluetooth.
a PIFA antenna for GSM and UMTS, the gain is 1.2 dBi for UMTS-FDD Band V, -2 dBi for GSM850, 1.2 dBi for UMTS-FDD Band II and -1.2 dBi for PCS1900.

Which in accordance to section 15.203, please refer to the internal photos.

Test Result: Pass

5.3 §15.207 (a) – AC Line Conducted Emissions

Standard Requirement:

Frequency of emission (MHz)	Conducted limit (dBµV)	
	Quasi-peak	Average
0.15–0.5	66 to 56*	56 to 46*
0.5–5	56	46
5–30	60	50

*Decreases with the logarithm of the frequency.

Procedures:

- All possible modes of operation were investigated. Only the 6 worst case emissions measured, using the correct CISPR and Average detectors, are reported. All other emissions were relatively insignificant.
- A "-ve" margin indicates a PASS as it refers to the margin present below the limit line at the particular frequency.
- Conducted Emissions Measurement Uncertainty
All test measurements carried out are traceable to national standards. The uncertainty of the measurement at a confidence level of approximately 95% (in the case where distributions are normal), with a coverage factor of 2, in the range 9kHz – 30MHz (Average & Quasi-peak) is ±3.5dB.
- Environmental Conditions

Temperature	21°C
Relative Humidity	51%
Atmospheric Pressure	1002mbar
- Test date : July 02, 2014
Tested By : Wiky Jam

Test Result: Pass

Test Mode:	Charging & GFSK Transmitting(Worse Case)
-------------------	---

Peak Detector  **Quasi Peak Limit** 
Average Detector  **Average Limit** 

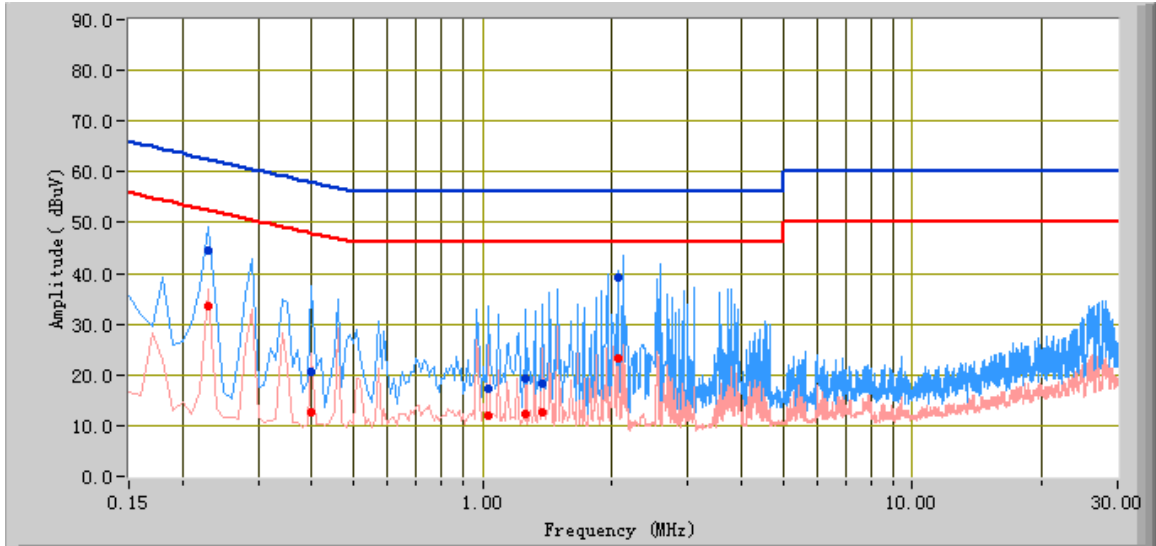

Test Data

Phase Line Plot at 120Vac, 60Hz

Frequency (MHz)	Quasi Peak (dBuV)	Limit (dBuV)	Margin (dB)	Average (dBuV)	Limit (dBuV)	Margin (dB)	Factors (dB)
0.23	44.46	62.45	-17.99	33.38	52.45	-19.07	11.93
2.06	39.07	56.00	-16.93	23.28	46.00	-22.72	10.45
0.40	20.66	57.85	-37.19	12.57	47.85	-35.28	10.98
1.37	18.37	56.00	-37.63	12.62	46.00	-33.38	10.32
1.03	17.11	56.00	-38.89	11.95	46.00	-34.05	10.29
1.26	19.14	56.00	-36.86	12.41	46.00	-33.59	10.31

Test Mode: Charging & GFSK Transmitting (Worse Case)

Peak Detector  **Quasi Peak Limit** 
Average Detector  **Average Limit** 

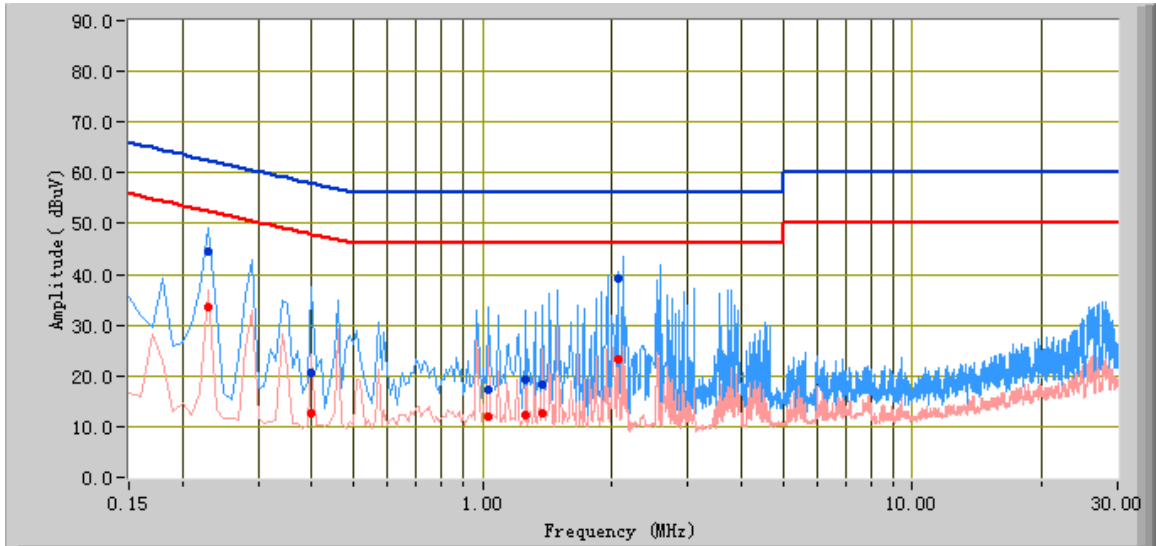

Test Data

Phase Neutral Plot at 120Vac, 60Hz

Frequency (MHz)	Quasi Peak (dBuV)	Limit (dBuV)	Margin (dB)	Average (dBuV)	Limit (dBuV)	Margin (dB)	Factors (dB)
0.23	44.46	62.45	-17.99	33.38	52.45	-19.07	11.93
2.06	39.07	56.00	-16.93	23.28	46.00	-22.72	10.45
0.40	20.66	57.85	-37.19	12.57	47.85	-35.28	10.98
1.37	18.37	56.00	-37.63	12.62	46.00	-33.38	10.32
1.03	17.11	56.00	-38.89	11.95	46.00	-34.05	10.29
1.26	19.14	56.00	-36.86	12.41	46.00	-33.59	10.31

5.4 §15.209, §15.205 & §15.247(d) - Spurious Emissions

1. All possible modes of operation were investigated. Only the 6 worst case emissions measured, using the correct CISPR detectors, are reported. All other emissions were relatively insignificant.
2. A "-ve" margin indicates a PASS as it refers to the margin present below the limit line at the particular frequency.
3. Radiated Emissions Measurement Uncertainty
All test measurements carried out are traceable to national standards. The uncertainty of the measurement at a confidence level of approximately 95% (in the case where distributions are normal), with a coverage factor of 2, in the range 30MHz – 1GHz (3m & 10m) & 1GHz above (3m) is +5.6/-4.5dB.
4. Environmental Conditions

Temperature	21°C
Relative Humidity	51%
Atmospheric Pressure	1002mbar
5. Test date : July 02, 2014
Tested By : Wiky Jam

Standard Requirement:

In any 100 kHz bandwidth outside the frequency band in which the spread spectrum or digitally modulated intentional radiator is operating, the radio frequency power that is produced by the intentional radiator shall be at least 20 dB below that in the 100 kHz bandwidth within the band that contains the highest level of the desired power, based on either an RF conducted or a radiated measurement, provided the transmitter demonstrates compliance with the peak conducted power limits. If the transmitter complies with the conducted power limits based on the use of RMS averaging over a time interval, as permitted under paragraph (b)(3) of this section, the attenuation required under this paragraph shall be 30 dB instead of 20 dB. Attenuation below the general limits specified in §15.209(a) is not required. In addition, radiated emissions which fall in the restricted bands, as defined in §15.205(a), must also comply with the radiated emission limits specified in §15.209(a) (see §15.205(c)).

Procedures:

1. The EUT was switched on and allowed to warm up to its normal operating condition.
2. The test was carried out at the selected frequency points obtained from the EUT characterisation. Maximization of the emissions was carried out by rotating the EUT, changing the antenna polarization, and adjusting the antenna height in the following manner:
 - a. Vertical or horizontal polarisation (whichever gave the higher emission level over a full rotation of the EUT) was chosen.
 - b. The EUT was then rotated to the direction that gave the maximum emission.
 - c. Finally, the antenna height was adjusted to the height that gave the maximum emission.
3. A Quasi-peak measurement was then made for that frequency point for below 1GHz test, PK and AV for above 1GHz emission test.
 - a. The resolution bandwidth and video bandwidth of test receiver/spectrum analyzer is 120 kHz for Quasiy Peak detection at frequency below 1GHz.
 - b. The resolution bandwidth of test receiver/spectrum analyzer is 1MHz and video bandwidth is 3MHz for Peak detection at frequency above 1GHz.
 - c. The resolution bandwidth of test receiver/spectrum analyzer is 1MHz and the video bandwidth for Average detection (AV) as below at frequency above 1GHz.

1 kHz (Duty cycle < 98%)
 10 Hz (Duty cycle > 98%)

4. Steps 2 and 3 were repeated for the next frequency point, until all selected frequency points were measured.

Test Result: Pass

Test Mode:	Charging & GFSK Transmitting(Worse Case)
-------------------	---

Below 1GHz

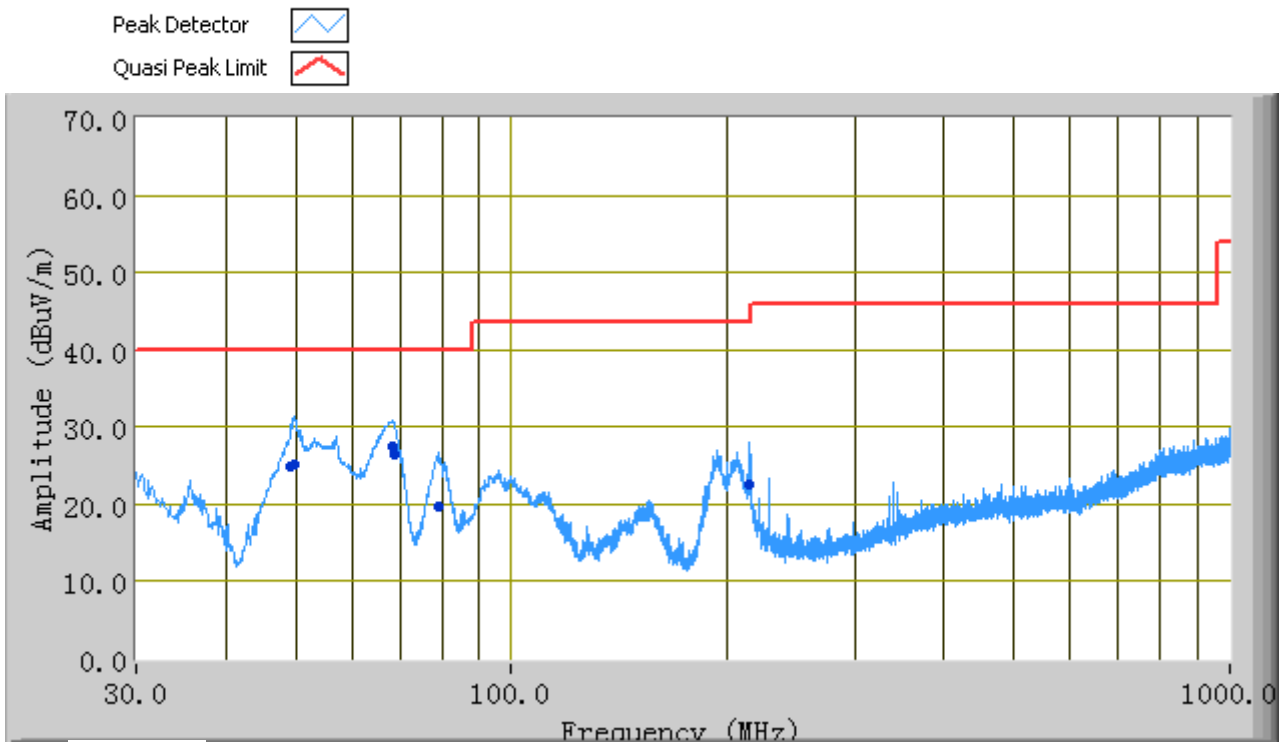

Test Data

Horizontal & Vertical Polarity Plot @3m

Frequency (MHz)	Quasi Peak (dBuV/m)	Azimuth	Polarity(H/V)	Height (cm)	Factors (dB)	Limit (dBuV)	Margin (dB)
49.79	25.17	0.00	V	116.00	-13.83	40.00	-14.83
68.14	27.38	106.00	V	100.00	-13.68	40.00	-12.62
68.81	26.37	126.00	V	103.00	-13.66	40.00	-13.63
49.33	24.98	239.00	V	106.00	-13.60	40.00	-15.02
79.00	19.82	158.00	V	102.00	-13.74	40.00	-20.18
214.13	22.54	231.00	H	213.00	-7.91	43.52	-20.98

Test Mode:	Charging & GFSK Transmitting
-------------------	---

Above 1 GHz

Note: Other Bluetooth modes were verified; only the result of worst case DH5 mode was presented.

Low Channel (2402 MHz)

Frequency (MHz)	S.A. Reading (dBµV)	Detector (PK/AV)	Polarity (H/V)	Ant. Factor (dB/m)	Cable Loss (dB)	Duty cycle Factor (dB)	Pre-Amp. Gain (dB)	Cord. Amp. (dBµV/m)	Limit (dBµV/m)	Margin (dB)
4804	38.83	AV	V	33.83	4.87	-3.61	24	49.92	54	-4.08
4804	38.67	AV	H	33.83	4.87	-3.61	24	49.76	54	-4.24
4804	42.65	PK	V	33.83	4.87	—	24	57.35	74	-16.65
4804	42.49	PK	H	33.83	4.87	—	24	57.19	74	-16.81

Duty cycle factor=20log(Dwell time/100ms)=20log(2.87*23/100)=-3.61

Middle Channel (2441 MHz)

Frequency (MHz)	S.A. Reading (dBµV)	Detector (PK/AV)	Polarity (H/V)	Ant. Factor (dB/m)	Cable Loss (dB)	Duty cycle Factor (dB)	Pre-Amp. Gain (dB)	Cord. Amp. (dBµV/m)	Limit (dBµV/m)	Margin (dB)
4880	38.93	AV	V	33.86	4.87	-3.61	24	50.05	54	-3.95
4880	39.02	AV	H	33.86	4.87	-3.61	24	50.14	54	-3.86
4880	43.13	PK	V	33.86	4.87	—	24	57.86	74	-16.14
4880	42.97	PK	H	33.86	4.87	—	24	57.70	74	-16.30

Duty cycle factor=20log(Dwell time/100ms)=20log(2.87*23/100)=-3.61

High Channel (2480 MHz)

Frequency (MHz)	S.A. Reading (dBµV)	Detector (PK/AV)	Polarity (H/V)	Ant. Factor (dB/m)	Cable Loss (dB)	Duty cycle Factor (dB)	Pre-Amp. Gain (dB)	Cord. Amp. (dBµV/m)	Limit (dBµV/m)	Margin (dB)
4960	39.11	AV	V	33.9	4.87	-3.61	24	50.27	54	-3.73
4960	38.98	AV	H	33.9	4.87	-3.61	24	50.14	54	-3.86
4960	43.22	PK	V	33.9	4.87	—	24	57.99	74	-16.01
4960	43.17	PK	H	33.9	4.87	—	24	57.94	74	-16.06

Duty cycle factor=20log(Dwell time/100ms)=20log(2.87*23/100)=-3.61

5.5 §15.247(a) (1)-Channel Separation

1. **Conducted Measurement**
EUT was set for low, mid, high channel with modulated mode and highest RF output power.
The spectrum analyzer was connected to the antenna terminal.
2. **Environmental Conditions**

Temperature	22°C
Relative Humidity	52%
Atmospheric Pressure	1003mbar
3. **Conducted Emissions Measurement Uncertainty**
All test measurements carried out are traceable to national standards. The uncertainty of the measurement at a confidence level of approximately 95% (in the case where distributions are normal), with a coverage factor of 2, in the range 30MHz – 40GHz is ±1.5dB.
4. **Test date :** July 03, 2014
Tested By : Wiky Jam

Standard Requirement:

According to §15.247(a)(1), Frequency hopping systems shall have hopping channel carrier frequencies separated by a minimum of 25 kHz or two-thirds of the 20dB bandwidth of the hopping channel, whichever is greater. Alternatively, frequency hopping systems operating in the 2400-2483.5 MHz band may have hopping channel carrier frequencies that are separated by 25 kHz or two-thirds of the 20 dB bandwidth of the hopping channel, whichever is greater, provided the systems operate with an output power no greater than 125 mW.

Procedures:

1. Place the EUT on the table and set it in hopping function transmitting mode.
2. Remove the antenna from the EUT and then connect a low loss RF cable from the antenna port to the spectrum analyzer.
3. Set center frequency of spectrum analyzer = middle of hopping channel.
4. Set the spectrum analyzer as Resolution (or IF) Bandwidth (RBW) \geq 1% of the span, Video (or Average) Bandwidth (VBW) \geq RBW, Sweep = auto, Detector function = peak, Trace = max hold.
5. Max hold, mark 2 peaks of hopping channel and record the 2 peaks frequency.

Test Result: Pass

Note:

0: Low Channel

39: Middle Channel

78: High Channel

Test Mode:	GFSK Transmitting
-------------------	--------------------------

Channel	Channel Frequency (MHz)	Channel Separation (MHz)	Limit (KHz)	Result
Low Channel	2402	1.005	824.035	Pass
Adjacency Channel	2403			
Mid Channel	2440	1.005	825.574	Pass
Adjacency Channel	2441			
High Channel	2480	1.005	828.799	Pass
Adjacency Channel	2479			

Please refer to the following plots.

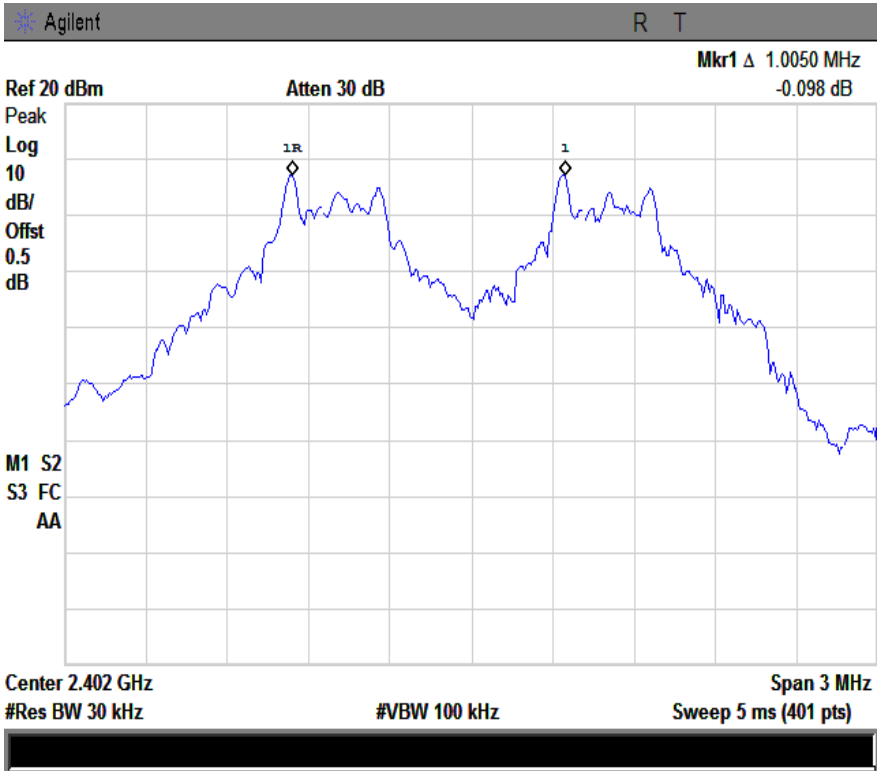

0-1M



SIEMIC, INC.

Accessing global markets

Title: RF Test Report for Qwerty Phone
Main Model: QW125
Main Model: N/A
To: FCC 15.247: 2013, ANSI C63.4: 2009

Report No: 14050038-FCC-R2
Issue Date: July 04, 2014
Page: 19 of 83
www.siemic.com
www.siemic.com.cn

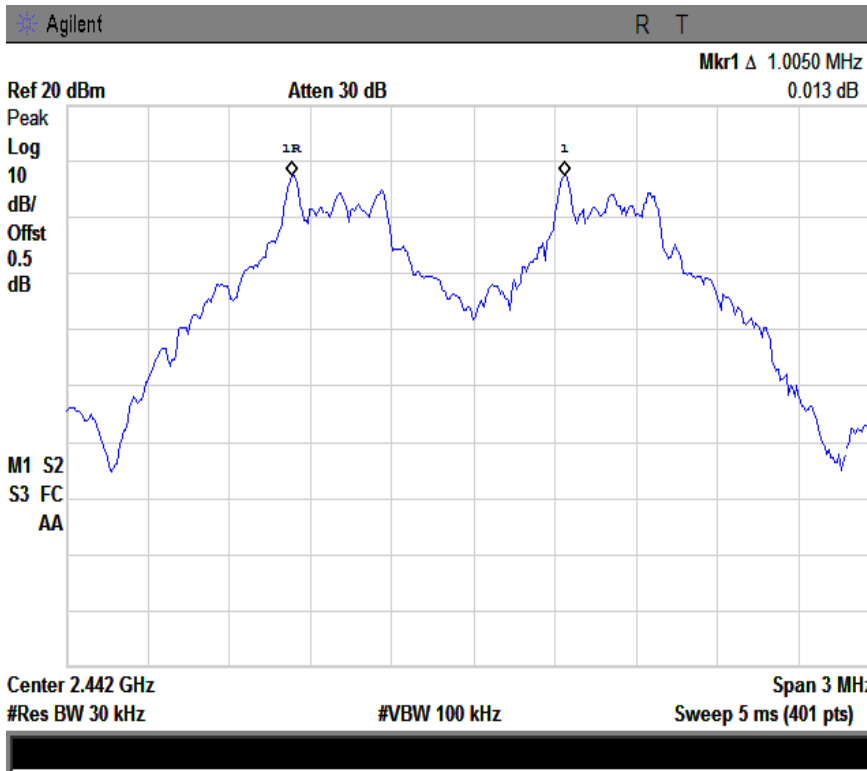

39-1M

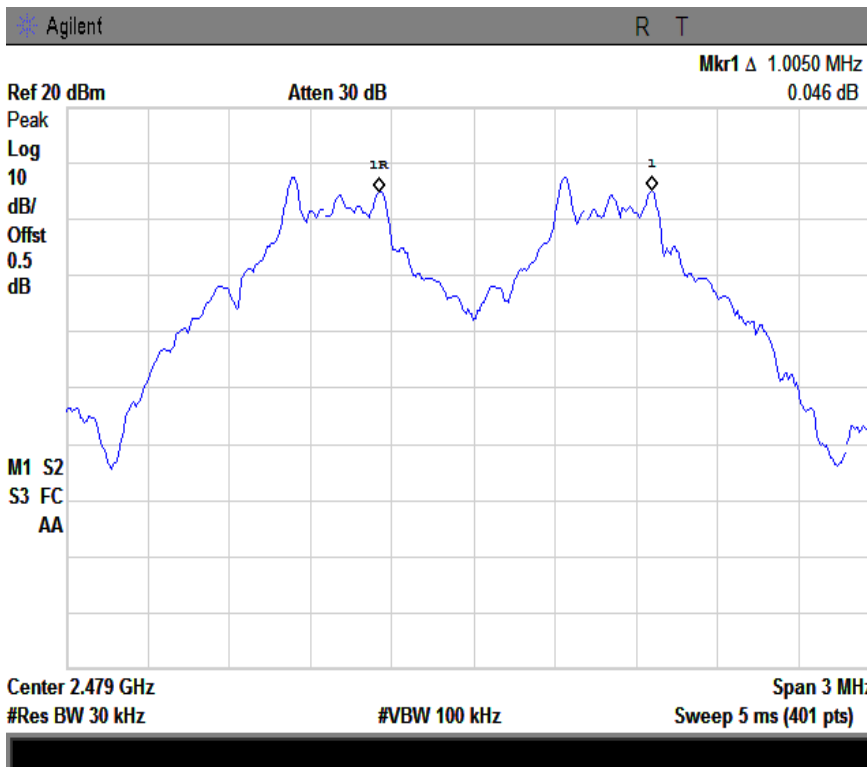

78-1M

Test Mode:	π /4 DQPSK Transmitting
-------------------	---

Channel	Channel Frequency (MHz)	Channel Separation (MHz)	Limit (MHz)	Result
Low Channel	2402	1.005	0.765	Pass
Adjacency Channel	2403			
Mid Channel	2440	1.005	0.761	Pass
Adjacency Channel	2441			
High Channel	2480	1.005	0.750	Pass
Adjacency Channel	2479			

Please refer to the following plots.

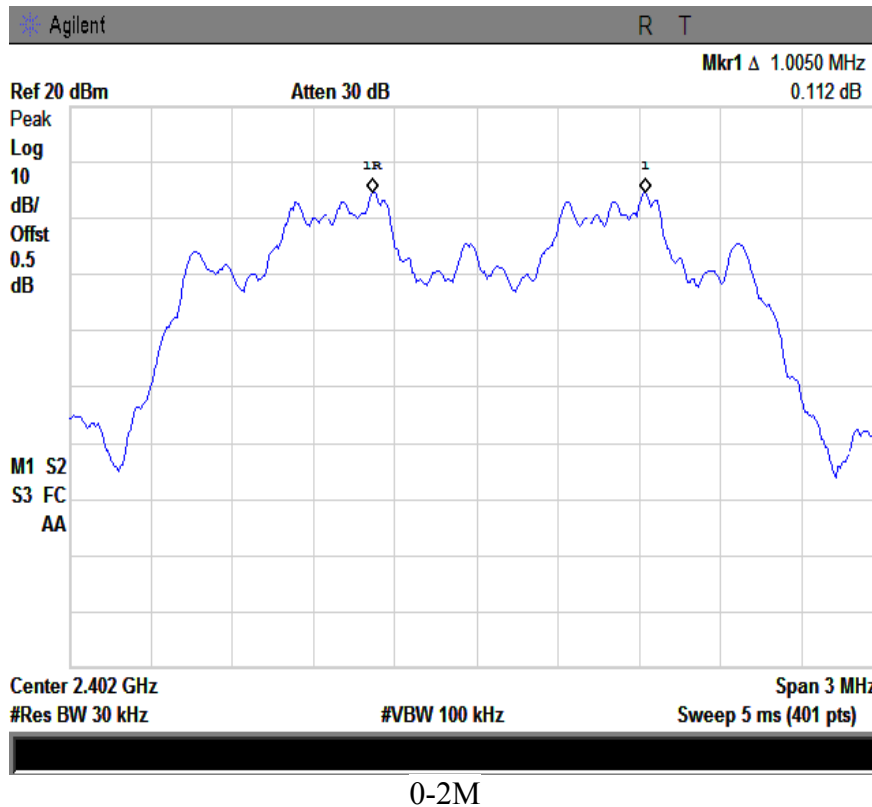



SIEMIC, INC.

Accessing global markets

Title: RF Test Report for Qwerty Phone
Main Model: QW125
Main Model: N/A
To: FCC 15.247: 2013, ANSI C63.4: 2009

Report No: 14050038-FCC-R2
Issue Date: July 04, 2014
Page: 21 of 83
www.siemic.com
www.siemic.com.cn

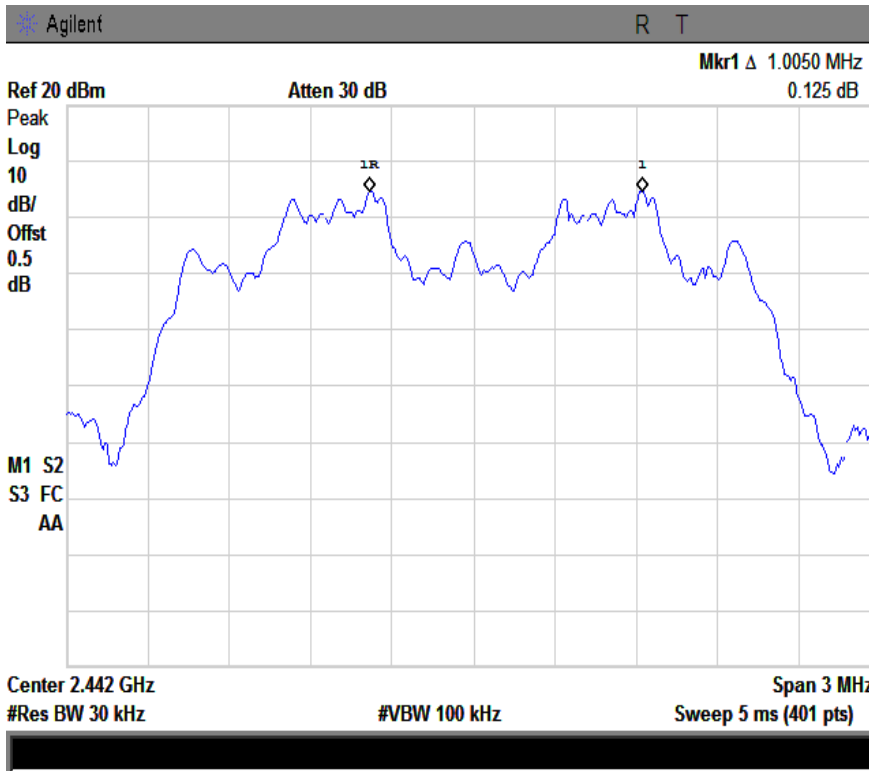

39-2M

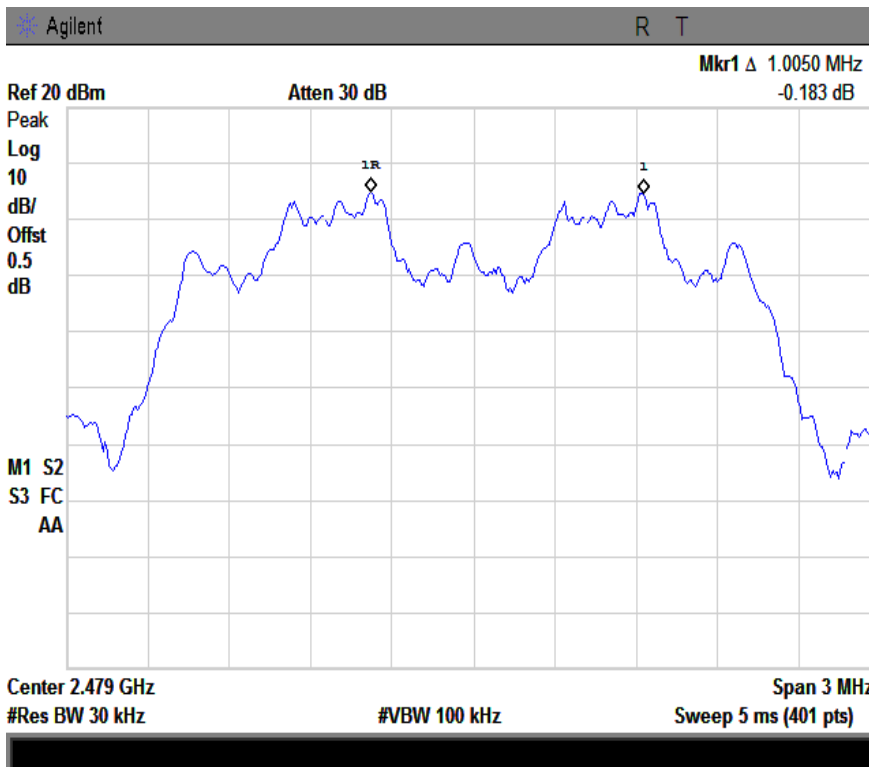

78-2M

Test Mode:	8DPSK Transmitting
-------------------	---------------------------

Channel	Channel Frequency (MHz)	Channel Separation (MHz)	Limit (MHz)	Result
Low Channel	2402	1.005	0.771	Pass
Adjacency Channel	2403			
Mid Channel	2440	1.005	0.775	Pass
Adjacency Channel	2441			
High Channel	2480	1.005	0.780	Pass
Adjacency Channel	2479			

Please refer to the following plots.

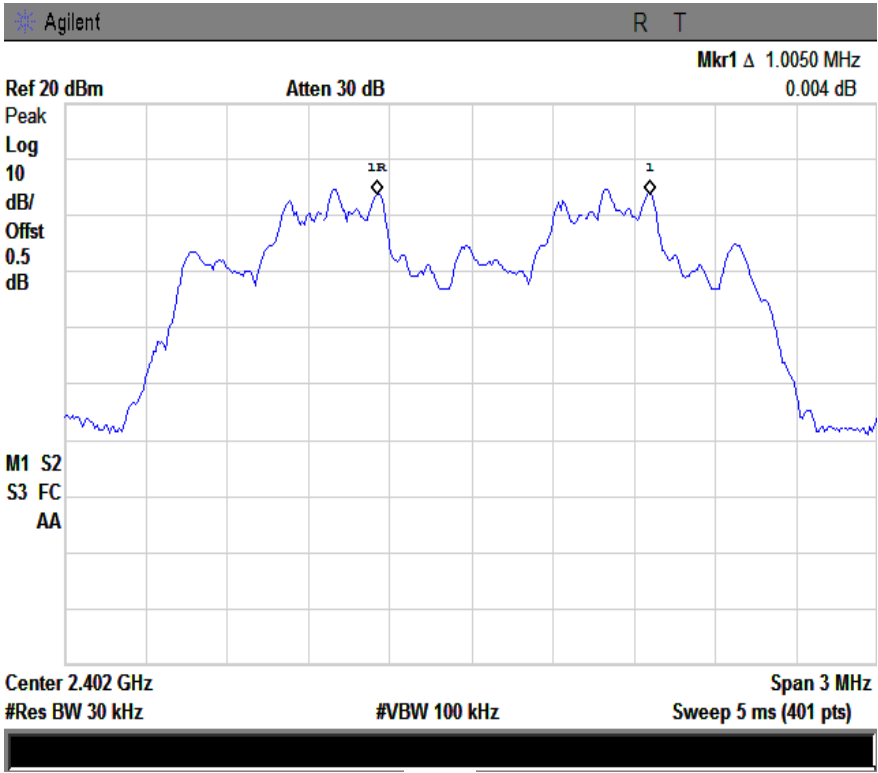

0-3M



SIEMIC, INC.

Accessing global markets

Title: RF Test Report for Qwerty Phone
Main Model: QW125
Main Model: N/A
To: FCC 15.247: 2013, ANSI C63.4: 2009

Report No: 14050038-FCC-R2
Issue Date: July 04, 2014
Page: 23 of 83
www.siemic.com
www.siemic.com.cn

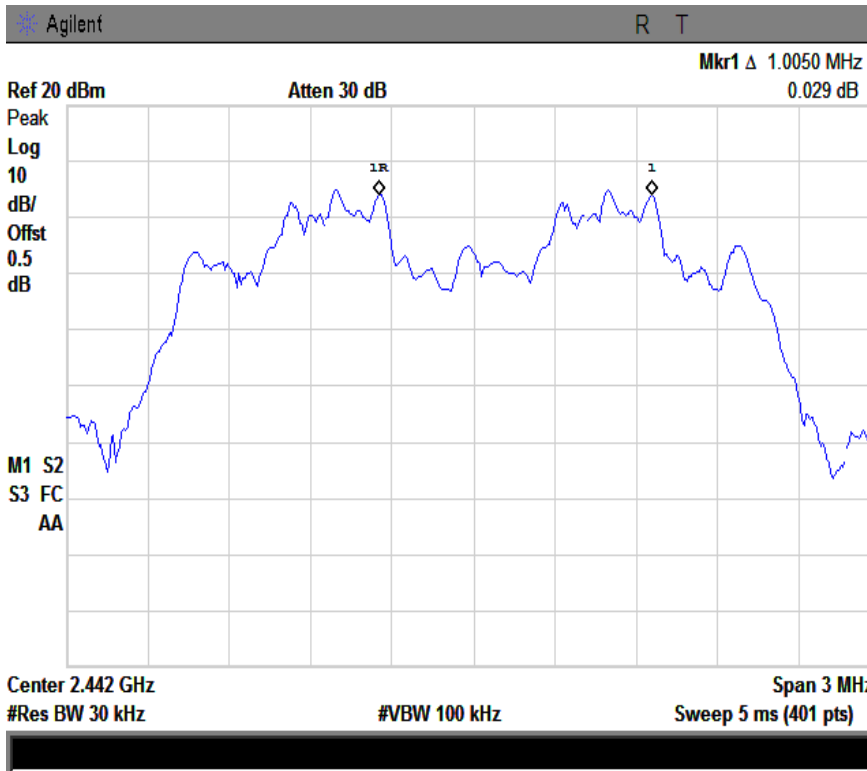

39-3M

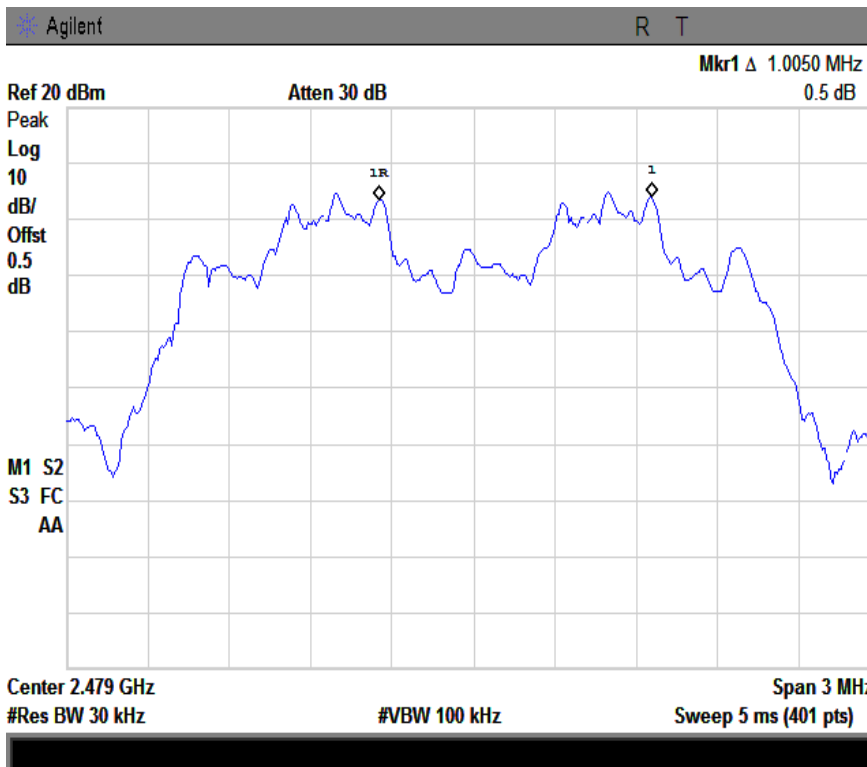

78-3M

§15.247(a) (1) – 20dB Bandwidth

1. Conducted Measurement
EUT was set for low, mid, high channel with modulated mode and highest RF output power.
The spectrum analyzer was connected to the antenna terminal.
2. Environmental Conditions

Temperature	21°C
Relative Humidity	51%
Atmospheric Pressure	1002mbar
3. Conducted Emissions Measurement Uncertainty
All test measurements carried out are traceable to national standards. The uncertainty of the measurement at a confidence level of approximately 95% (in the case where distributions are normal), with a coverage factor of 2, in the range 30MHz – 40GHz is ±1.5dB.
4. Test date : July 02, 2014
Tested By : Wiky Jam

Standard Requirement:

According to §15.247(a)(1), Frequency hopping systems shall have hopping channel carrier frequencies separated by a minimum of 25 kHz or the 20 dB bandwidth of the hopping channel, whichever is greater.

Procedures:

1. Place the EUT on the table and set it in transmitting mode.
2. Remove the antenna from the EUT and then connect a low loss RF cable from the antenna port to the spectrum analyzer.
3. Set the spectrum analyzer as Span = approximately 2 to 3 times the 20 dB bandwidth, centered on a hopping channel, RBW ≥ 1% of the 20 dB bandwidth, VBW ≥ RBW, Sweep = auto, Detector function = peak, Trace = max hold.
4. Set the measured low, middle and high frequency and test 20dB bandwidth with spectrum analyzer.

Test Result: Pass

Test Mode:	GFSK Transmitting
-------------------	--------------------------

Channel	Frequency (MHz)	20 dB Bandwidth (kHz)
Low	2402	824.035
Middle	2441	825.574
High	2480	828.799

Please refer to the following plots.

Note:

0: Low Channel

39: Middle Channel

78: High Channel



SIEMIC, INC.

Accessing global markets

Title: RF Test Report for Qwerty Phone
Main Model: QW125
Main Model: N/A
To: FCC 15.247: 2013, ANSI C63.4: 2009

Report No: 14050038-FCC-R2
Issue Date: July 04, 2014
Page: 25 of 83
www.siemic.com
www.siemic.com.cn

Agilent R T

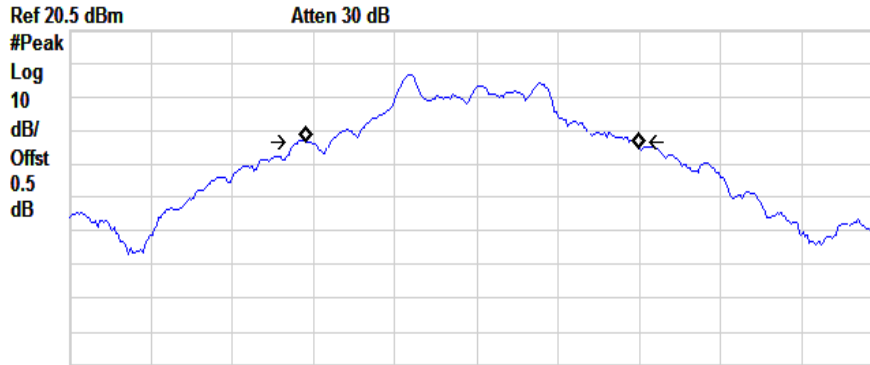

Center 2.402 GHz Span 2 MHz
#Res BW 30 kHz #VBW 100 kHz Sweep 5 ms (401 pts)

Occupied Bandwidth
821.8525 kHz

Occ BW % Pwr 99.00 %
x dB -20.00 dB

Transmit Freq Error -11.534 kHz
x dB Bandwidth 824.035 kHz



0-1M

Agilent R T

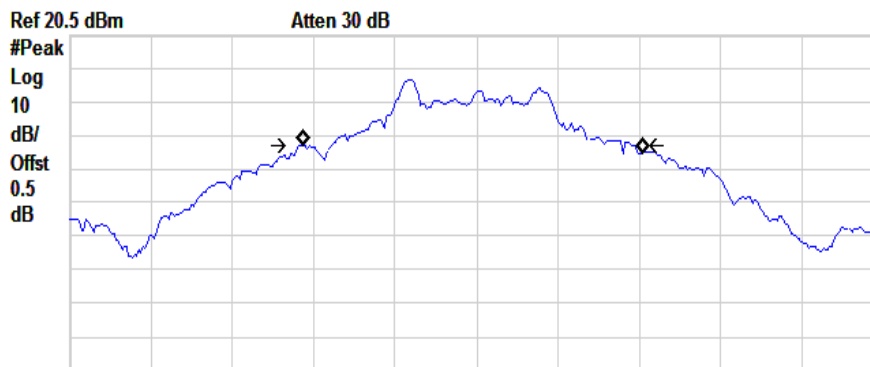

Center 2.441 GHz Span 2 MHz
#Res BW 30 kHz #VBW 100 kHz Sweep 5 ms (401 pts)

Occupied Bandwidth
836.9662 kHz

Occ BW % Pwr 99.00 %
x dB -20.00 dB

Transmit Freq Error -8.562 kHz
x dB Bandwidth 825.574 kHz



39-1M



SIEMIC, INC.

Accessing global markets

Title: RF Test Report for Qwerty Phone
Main Model: QW125
Main Model: N/A
To: FCC 15.247: 2013, ANSI C63.4: 2009

Report No: 14050038-FCC-R2
Issue Date: July 04, 2014
Page: 26 of 83
www.siemic.com
www.siemic.com.cn

Agilent R T

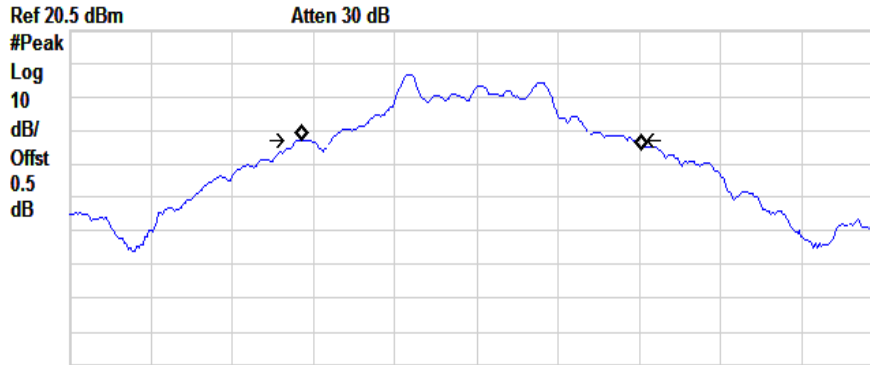

Center 2.48 GHz Span 2 MHz
#Res BW 30 kHz #VBW 100 kHz Sweep 5 ms (401 pts)

Occupied Bandwidth
835.7665 kHz

Occ BW % Pwr 99.00 %
x dB -20.00 dB

Transmit Freq Error -11.203 kHz
x dB Bandwidth 828.799 kHz



78-1M

Test Mode: π /4DQPSK Transmitting

Channel	Frequency (MHz)	20 dB Bandwidth (MHz)
Low	2402	1.149
Middle	2441	1.141
High	2480	1.125

Please refer to the following plots.

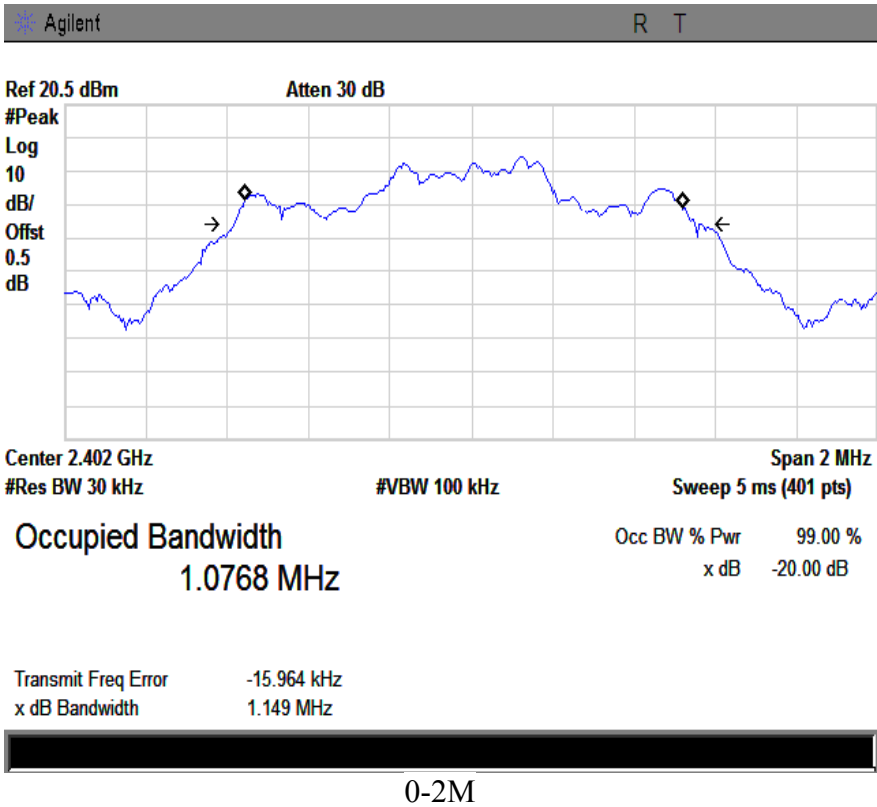



SIEMIC, INC.

Accessing global markets

Title: RF Test Report for Qwerty Phone
Main Model: QW125
Main Model: N/A
To: FCC 15.247: 2013, ANSI C63.4: 2009

Report No: 14050038-FCC-R2
Issue Date: July 04, 2014
Page: 28 of 83
www.siemic.com
www.siemic.com.cn

Agilent R T

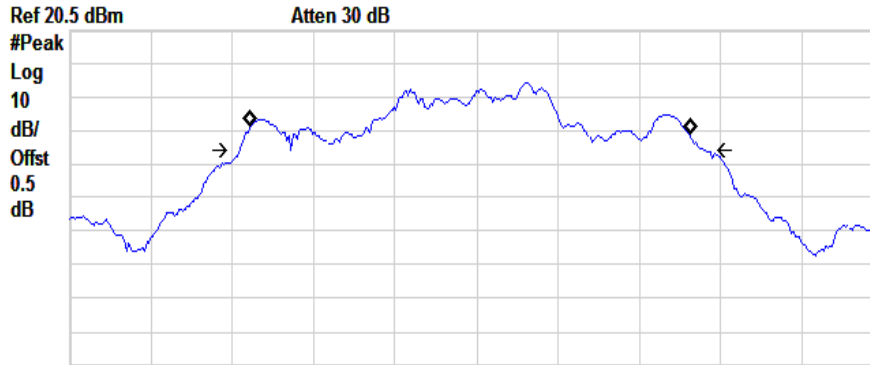

Center 2.441 GHz Span 2 MHz
#Res BW 30 kHz #VBW 100 kHz Sweep 5 ms (401 pts)

Occupied Bandwidth
1.0773 MHz

Occ BW % Pwr 99.00 %
x dB -20.00 dB

Transmit Freq Error -15.339 kHz
x dB Bandwidth 1.141 MHz



39-2M

Agilent R T

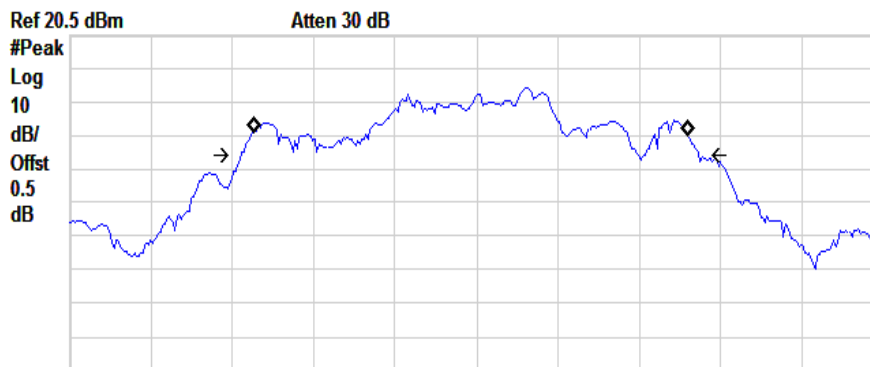

Center 2.48 GHz Span 2 MHz
#Res BW 30 kHz #VBW 100 kHz Sweep 5 ms (401 pts)

Occupied Bandwidth
1.0693 MHz

Occ BW % Pwr 99.00 %
x dB -20.00 dB

Transmit Freq Error -12.485 kHz
x dB Bandwidth 1.125 MHz



78-2M

Test Mode: 8DPSK Transmitting

Channel	Frequency (MHz)	20 dB Bandwidth (MHz)
Low	2402	1.156
Middle	2441	1.163
High	2480	1.170

Please refer to the following plots.

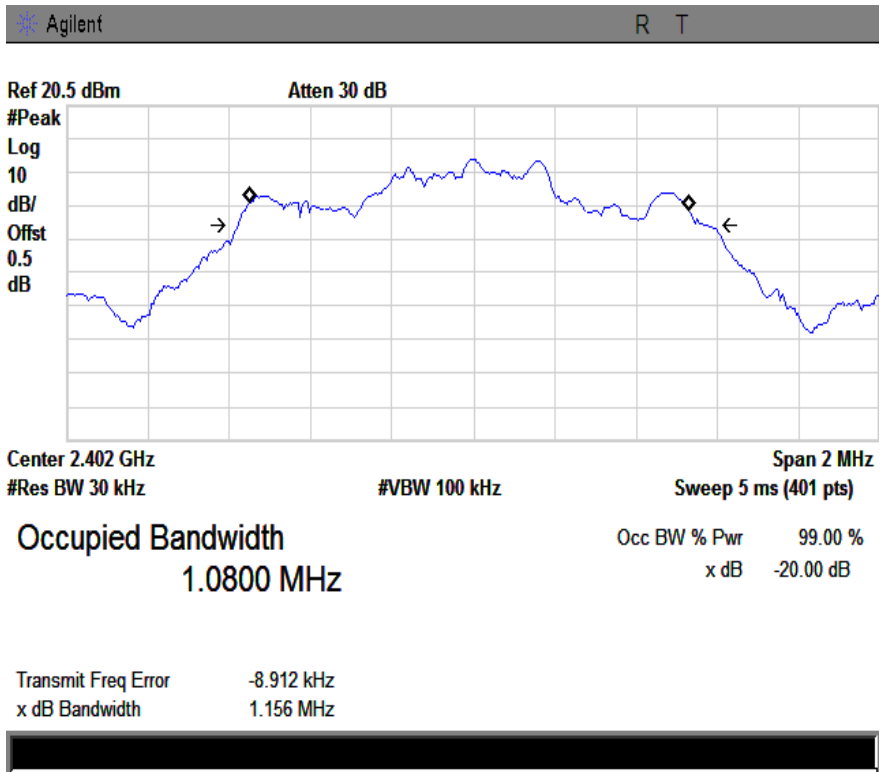

0-3M

Agilent R T

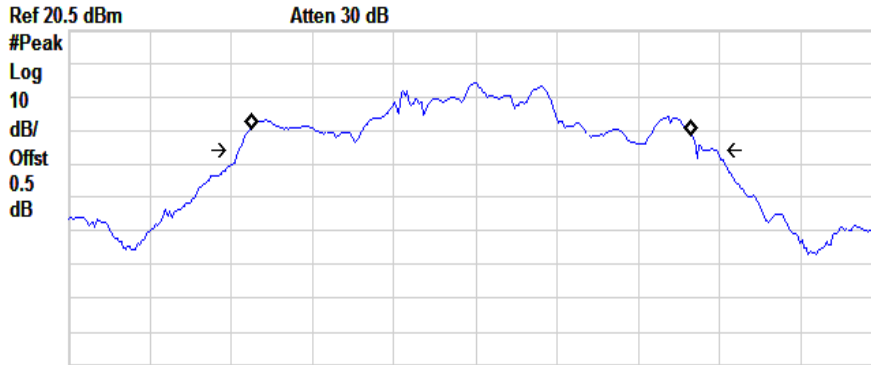

Center 2.441 GHz Span 2 MHz
 #Res BW 30 kHz #VBW 100 kHz Sweep 5 ms (401 pts)

Occupied Bandwidth
1.0795 MHz

Occ BW % Pwr 99.00 %
x dB -20.00 dB

Transmit Freq Error -9.576 kHz
x dB Bandwidth 1.163 MHz



39-3M

Agilent R T

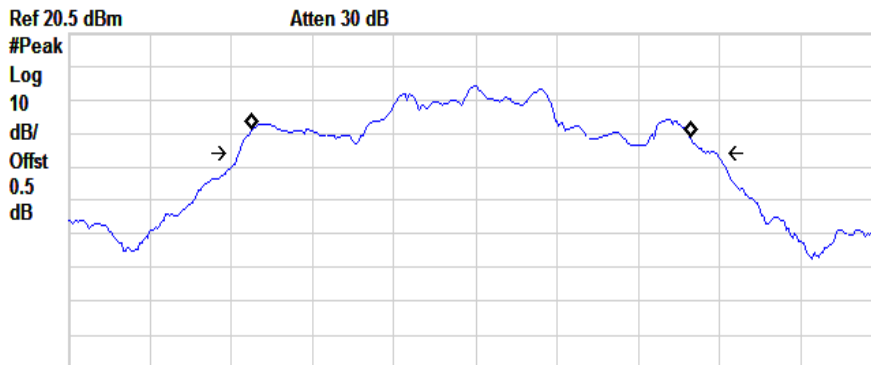

Center 2.48 GHz Span 2 MHz
 #Res BW 30 kHz #VBW 100 kHz Sweep 5 ms (401 pts)

Occupied Bandwidth
1.0781 MHz

Occ BW % Pwr 99.00 %
x dB -20.00 dB

Transmit Freq Error -9.534 kHz
x dB Bandwidth 1.170 MHz



78-3M

5.6 §15.247(a) (1) (iii)-Number of Hopping Channels

1. Conducted Measurement
EUT was set for low, mid, high channel with modulated mode and highest RF output power.
The spectrum analyzer was connected to the antenna terminal.
2. Conducted Emissions Measurement Uncertainty
All test measurements carried out are traceable to national standards. The uncertainty of the measurement at a confidence level of approximately 95% (in the case where distributions are normal), with a coverage factor of 2, in the range 30MHz – 40GHz is ±1.5dB.
3. Environmental Conditions

Temperature	22°C
Relative Humidity	52%
Atmospheric Pressure	1003mbar
4. Test date : July 03, 2014
Tested By : Wiky Jam

Standard Requirement:

According to §15.247(a)(1)(iii), Frequency hopping systems in the 2400–2483.5 MHz band shall use at least 15 channels.

Procedures:

1. Place the EUT on the table and set it in hopping function transmitting mode.
2. Remove the antenna from the EUT and then connect a low loss RF cable from the antenna port to the spectrum analyzer.
3. Set the spectrum analyzer as Start=2400MHz, Stop = 2483.5MHz, Span = the frequency band of operation, RBW ≥1% of the span, VBW ≥ RBW, Sweep = auto, Detector function = peak, Trace = max hold.
4. Count the quantity of peaks to get the number of hopping channels.

Test Result: Pass

Test Mode:	Hopping Mode With GFSK Modulation
-------------------	--

Frequency Range (MHz)	Number of Hopping Channels	Limit
2400-2483.5	79	≥15

Please refer to following tables and plots

Number of Hopping Channels

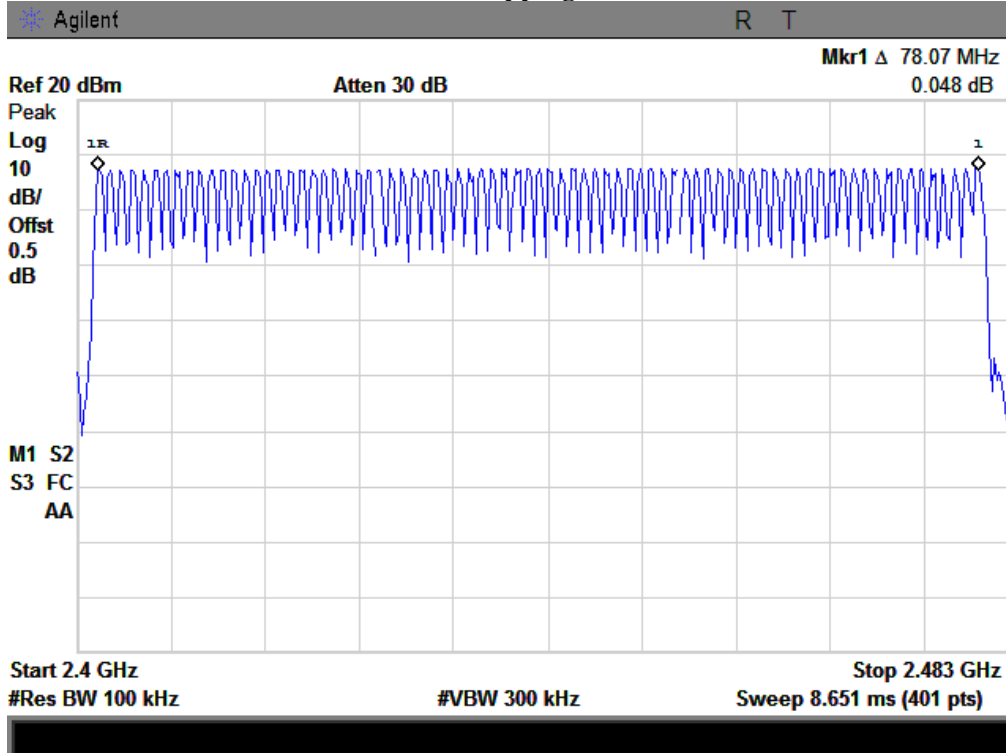

Test Mode: Hopping Mode With $\pi/4$ DQPSK Modulation

Frequency Range (MHz)	Number of Hopping Channels	Limit
2400-2483.5	79	≥ 15

Please refer to following tables and plots

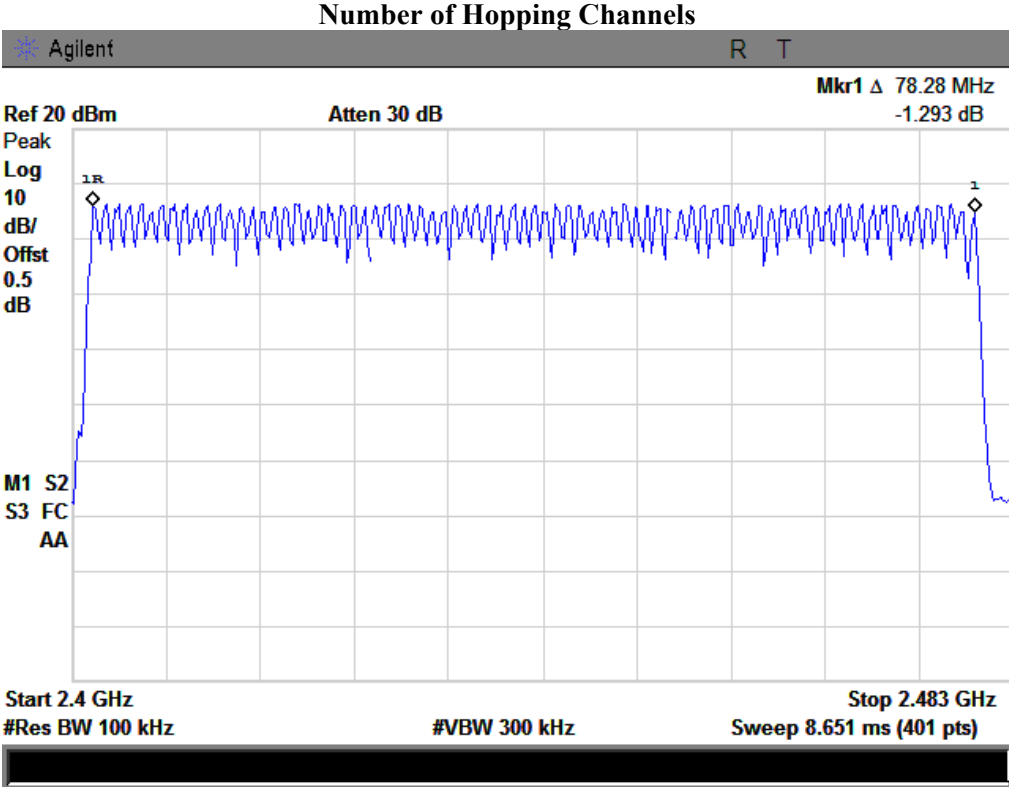

Test Mode:	Hopping Mode With 8DPSK Modulation
-------------------	---

Frequency Range (MHz)	Number of Hopping Channels	Limit
2400-2483.5	79	≥15

Please refer to following tables and plots

Number of Hopping Channels

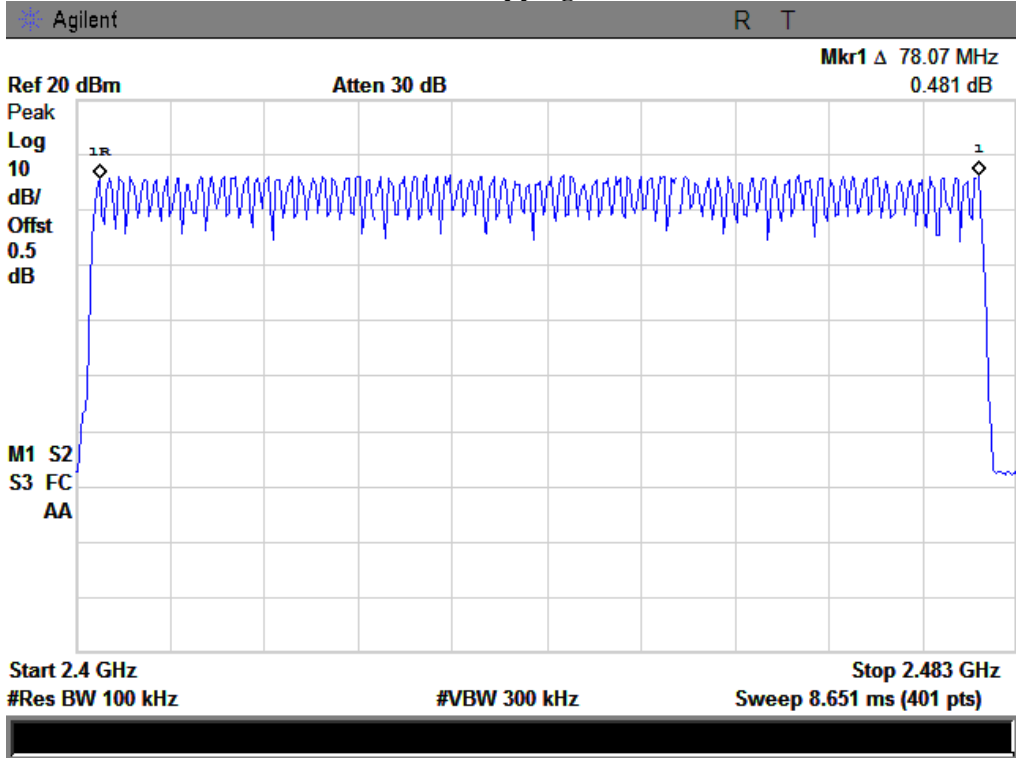

5.7 §15.247(a) (1) (iii) -Time of Occupancy (Dwell Time)

1. Conducted Measurement
EUT was set for low, mid, high channel with modulated mode and highest RF output power.
The spectrum analyzer was connected to the antenna terminal.
2. Conducted Emissions Measurement Uncertainty
All test measurements carried out are traceable to national standards. The uncertainty of the measurement at a confidence level of approximately 95% (in the case where distributions are normal), with a coverage factor of 2, in the range 30MHz – 40GHz is ± 1.5 dB.
3. Environmental Conditions

Temperature	22°C
Relative Humidity	52%
Atmospheric Pressure	1003mbar
4. Test date : July 03, 2014
Tested By : Wiky Jam

Standard Requirement:

According to §15.247(a)(1)(iii), The average time of occupancy on any channel shall not be greater than 0.4 seconds within a period of 0.4 seconds multiplied by the number of hopping channels employed. Frequency hopping systems may avoid or suppress transmissions on a particular hopping frequency provided that a minimum of 15 channels are used.

Procedures:

1. Place the EUT on the table and set it in transmitting mode and switch on frequency hopping function.
2. Remove the antenna from the EUT and then connect a low loss RF cable from the antenna port to the spectrum analyzer.
3. Set the spectrum analyzer as Span = zero span, centered on a hopping channel,
RBW=1MHz, VBW \geq RBW, Sweep = as necessary to capture the entire dwell time per hopping channel, Detector function = peak, Trace = max hold.
4. Calculate the time of occupancy in a period with time occupancy of a burst and quantity of bursts.

Test Result: Pass

Note:

0: Low Channel

39: Middle Channel

78: High Channel

Test Mode: Hopping Mode With GFSK Modulation

Mode	Channel	Pulse Width (ms)	Dwell Time (s)	Limit (s)	Result
DH 5	Low	2.962	0.316	0.4	Pass
	Middle	2.962	0.316	0.4	Pass
	High	2.963	0.316	0.4	Pass
Note: Dwell time=Pulse Time (ms) × (1600 ÷ 6 ÷ 79) × 31.6 Second					

Please refer to the following plots.

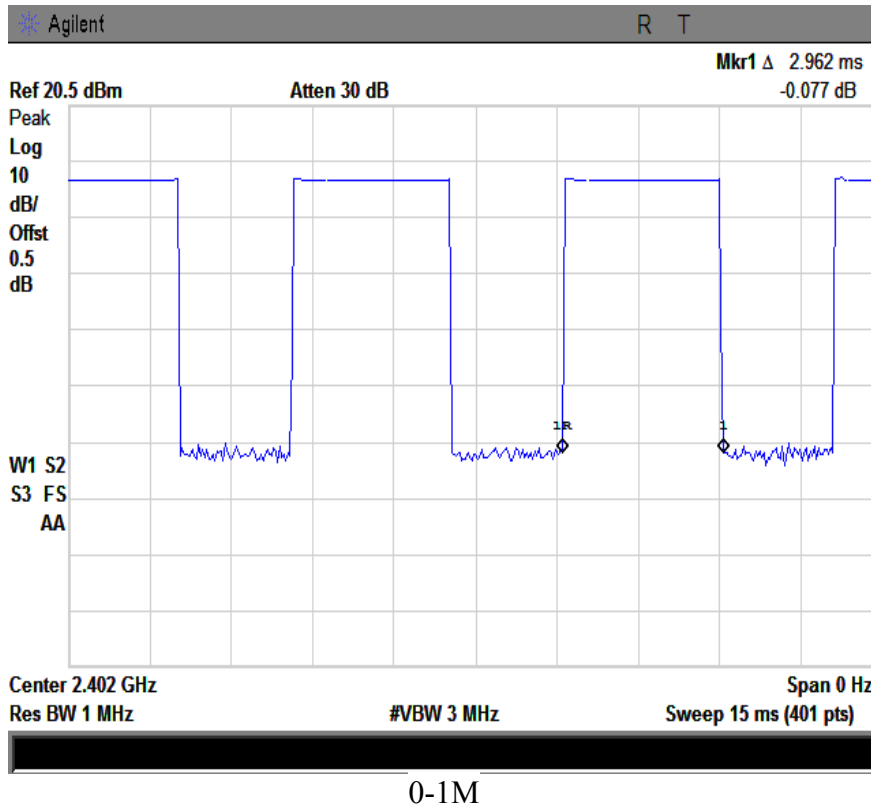



SIEMIC, INC.

Accessing global markets

Title: RF Test Report for Qwerty Phone
Main Model: QW125
Main Model: N/A
To: FCC 15.247: 2013, ANSI C63.4: 2009

Report No: 14050038-FCC-R2
Issue Date: July 04, 2014
Page: 37 of 83
www.siemic.com
www.siemic.com.cn

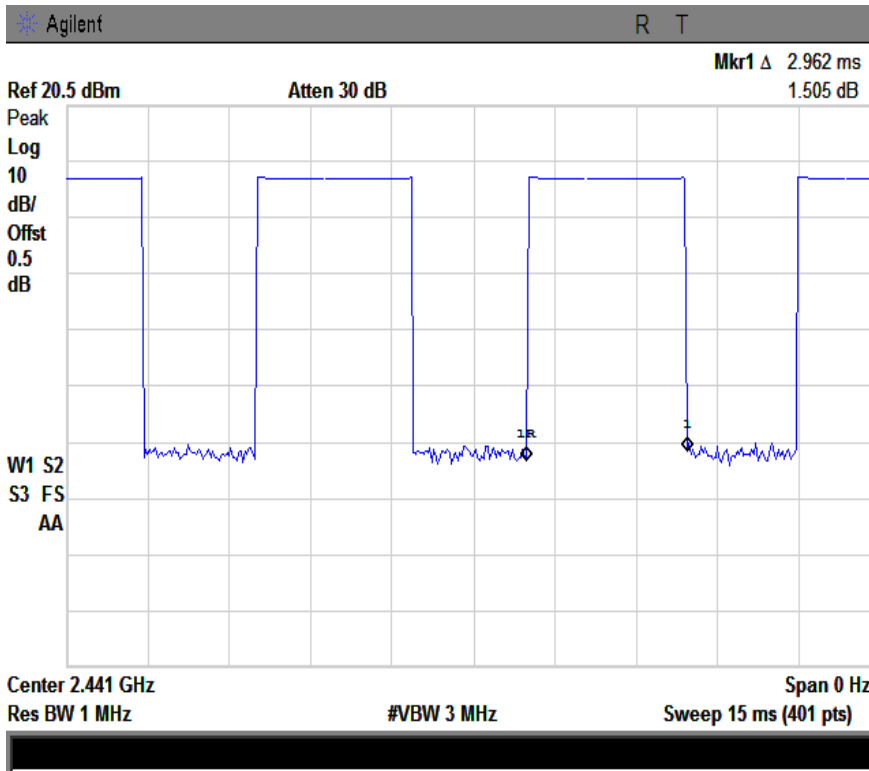

39-1M

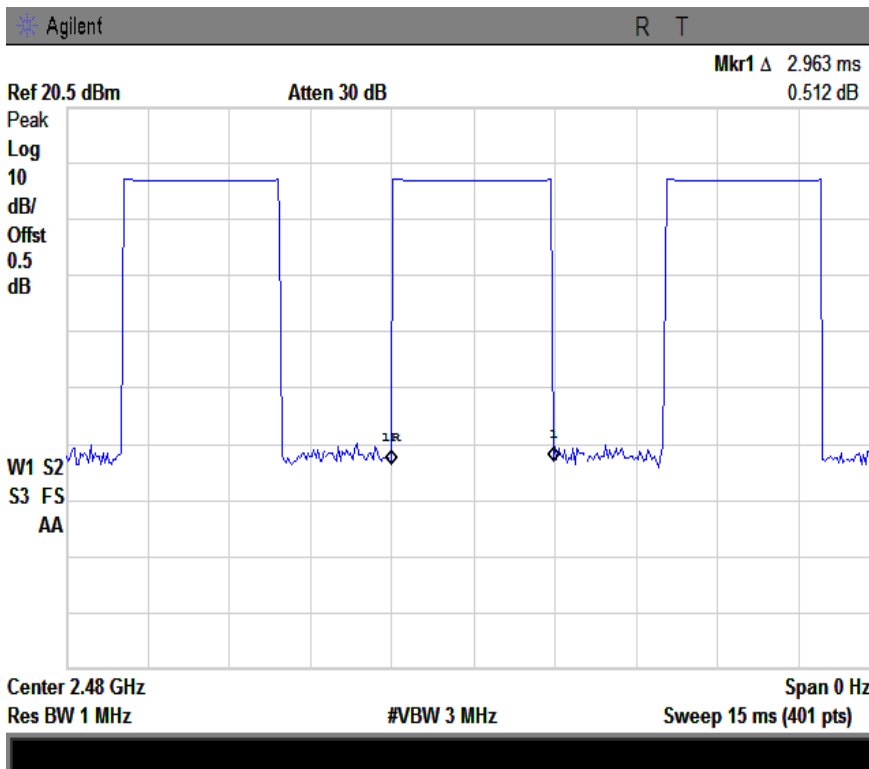

78-1M

Test Mode: Hopping Mode With $\pi/4$ DQPSK Modulation

Mode	Channel	Pulse Width (ms)	Dwell Time (s)	Limit (s)	Result
2DH 5	Low	2.962	0.316	0.4	Pass
	Middle	2.962	0.316	0.4	Pass
	High	2.962	0.316	0.4	Pass
	<i>Note:</i> Dwell time=Pulse Time (ms) \times (1600 \div 6 \div 79) \times 31.6 Second				

Please refer to the following plots.

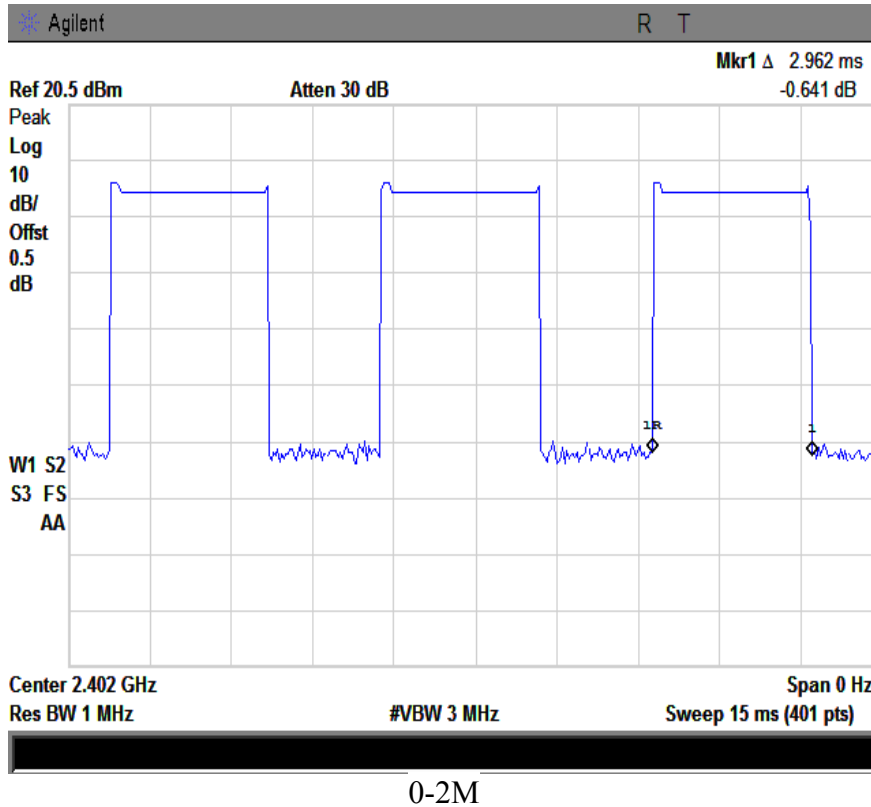



SIEMIC, INC.

Accessing global markets

Title: RF Test Report for Qwerty Phone
Main Model: QW125
Main Model: N/A
To: FCC 15.247: 2013, ANSI C63.4: 2009

Report No: 14050038-FCC-R2
Issue Date: July 04, 2014
Page: 39 of 83
www.siemic.com
www.siemic.com.cn

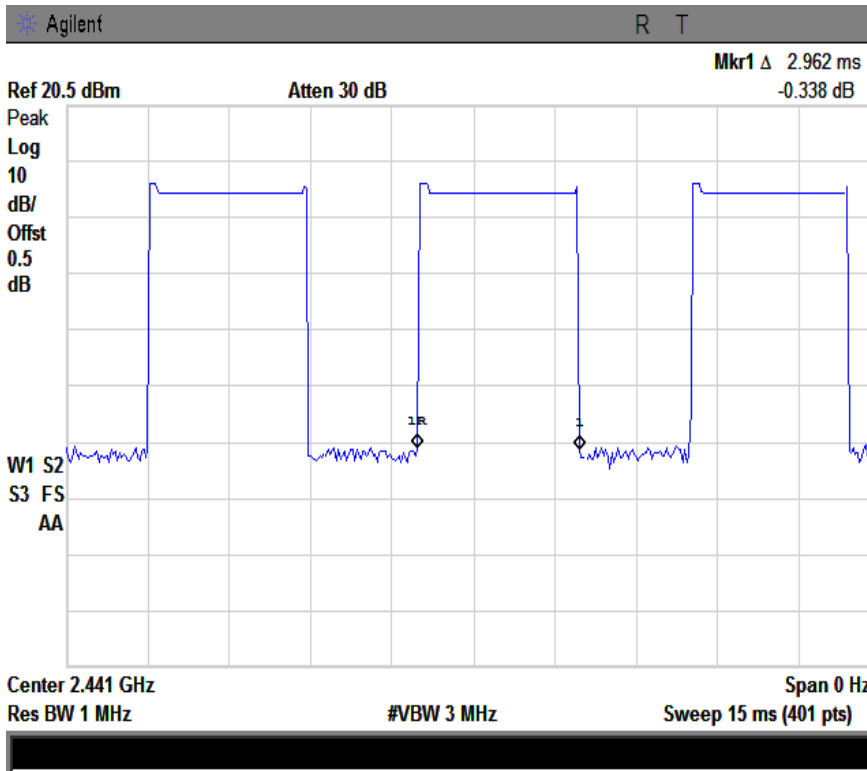

39-2M

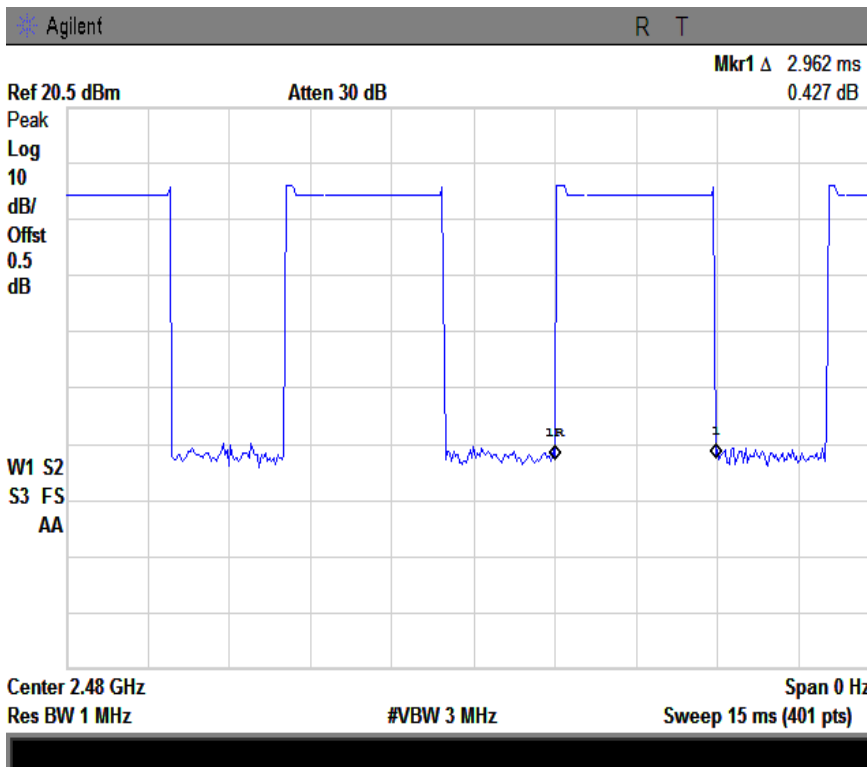

78-2M

Test Mode: Hopping Mode With 8DPSK Modulation

Mode	Channel	Pulse Width (ms)	Dwell Time (s)	Limit (s)	Result
3DH 5	Low	2.962	0.316	0.4	Pass
	Middle	2.962	0.316	0.4	Pass
	High	2.963	0.316	0.4	Pass
Note: Dwell time=Pulse Time (ms) × (1600 ÷ 6 ÷ 79) × 31.6 Second					

Please refer to the following plots.

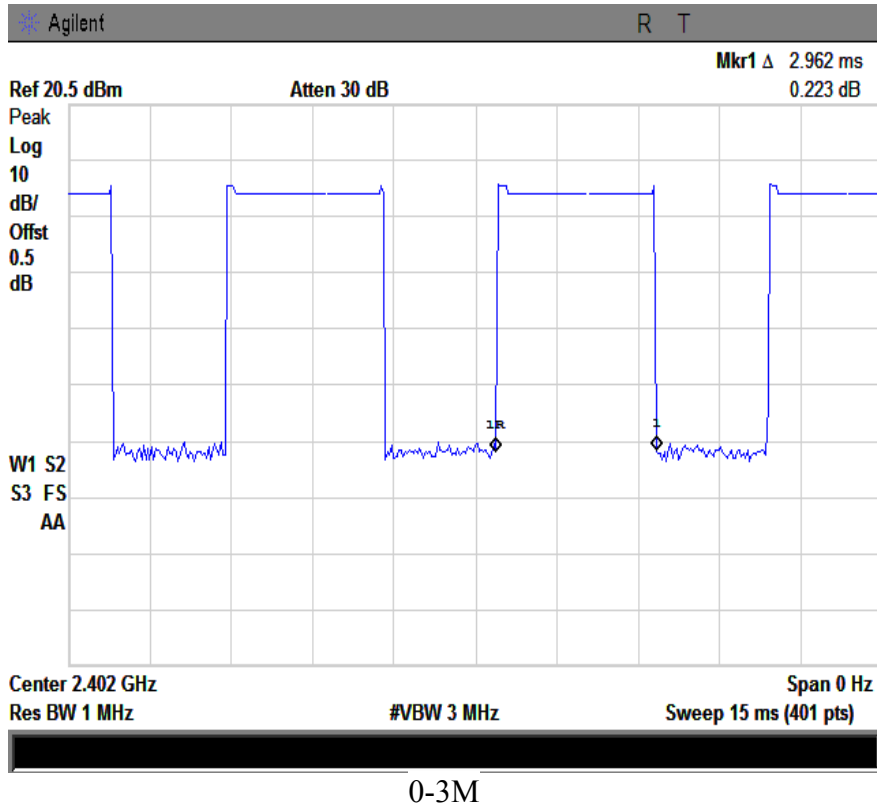



SIEMIC, INC.

Accessing global markets

Title: RF Test Report for Qwerty Phone
Main Model: QW125
Main Model: N/A
To: FCC 15.247: 2013, ANSI C63.4: 2009

Report No: 14050038-FCC-R2
Issue Date: July 04, 2014
Page: 41 of 83
www.sieminc.com
www.sieminc.com.cn

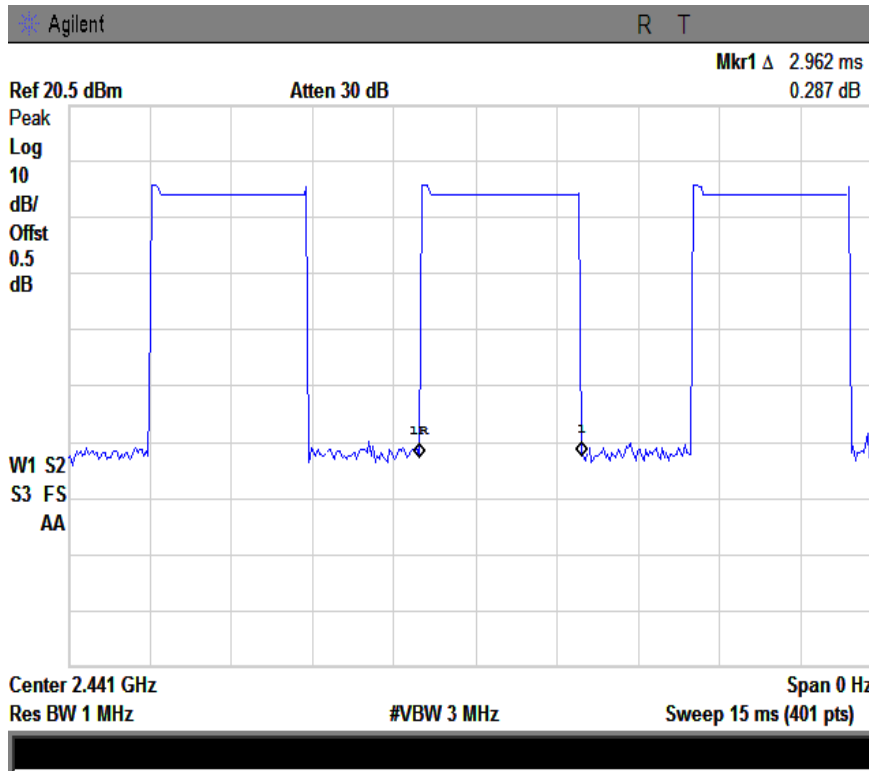

39-3M

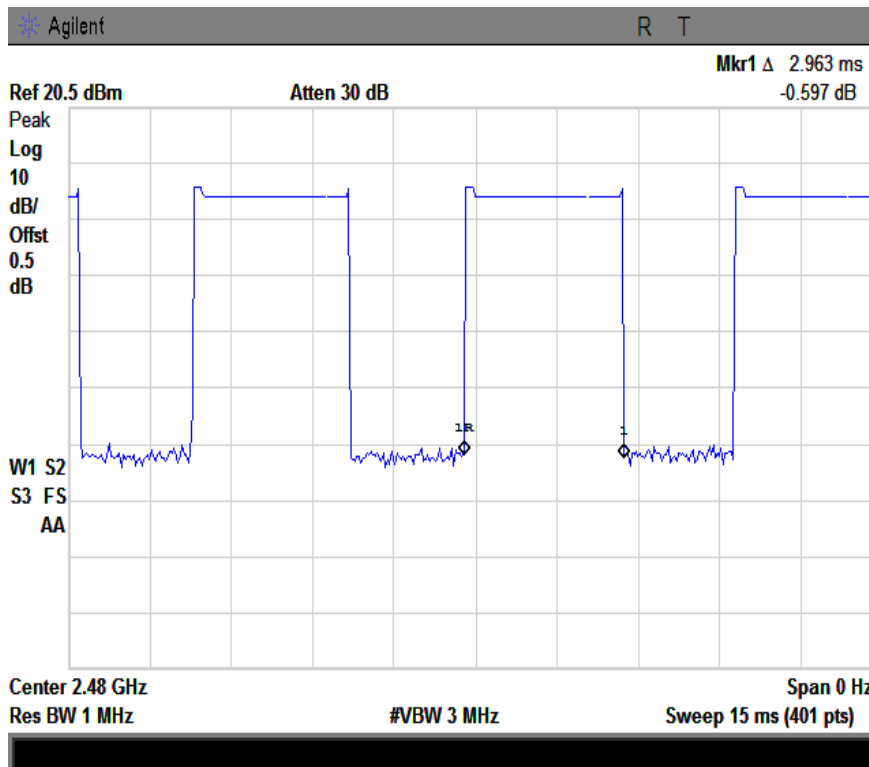

78-3M

5.8 §15.247(b) (1) - Peak Output Power

1. Conducted Measurement
EUT was set for low, mid, high channel with modulated mode and highest RF output power.
The spectrum analyzer was connected to the antenna terminal.
2. Conducted Emissions Measurement Uncertainty
All test measurements carried out are traceable to national standards. The uncertainty of the measurement at a confidence level of approximately 95% (in the case where distributions are normal), with a coverage factor of 2, in the range 30MHz – 40GHz is ±1.5dB.
3. Environmental Conditions

Temperature	22°C
Relative Humidity	52%
Atmospheric Pressure	1003mbar
4. Test date : July 03, 2014
Tested By : Wiky Jam

Standard Requirement:

According to §15.247(b)(2), For frequency hopping systems in the 2400-2483.5 MHz band employing at least 75 non-overlapping hopping channels, and all frequency hopping systems in the 5725-5850MHz band: 1 watt. For all other frequency hopping systems in the 2400-2483.5MHz band: 0.125watts.

Procedures:

1. Place the EUT on the table and set it in transmitting mode.
2. Remove the antenna from the EUT and then connect a low loss RF cable from the antenna port to the spectrum analyzer.
3. Set the spectrum analyzer as Span = approximately 5 times the 20 dB bandwidth, centered on a hopping channel, RBW > the 20 dB bandwidth of the emission being measured, VBW ≥ RBW, Sweep=auto, Detector function=peak, Trace = max hold.
4. Then set the EUT to transmit at low, middle and high channel and measure the conducted output power separately.

Test Result: Pass

Note:

- 0: Low Channel
- 39: Middle Channel
- 78: High Channel

Test Mode: GFSK Transmitting

Channel	Channel frequency (MHz)	Peak output power (dBm)	Power output (mW)	Limit (mW)
Low channel	2402	7.282	5.348	1000
Middle channel	2441	7.444	5.551	1000
High channel	2480	7.525	5.656	1000

Please refer to the following plots.

Note: The data above was tested in conducted mode.

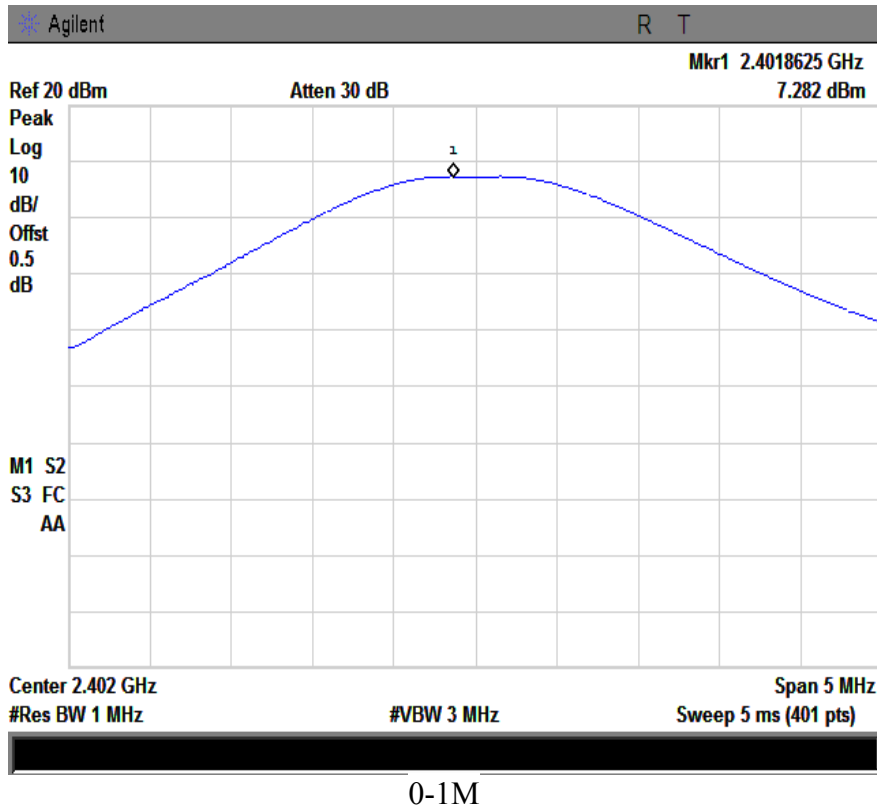

0-1M



SIEMIC, INC.

Accessing global markets

Title: RF Test Report for Qwerty Phone
Main Model: QW125
Main Model: N/A
To: FCC 15.247: 2013, ANSI C63.4: 2009

Report No: 14050038-FCC-R2
Issue Date: July 04, 2014
Page: 44 of 83
www.siemic.com
www.siemic.com.cn

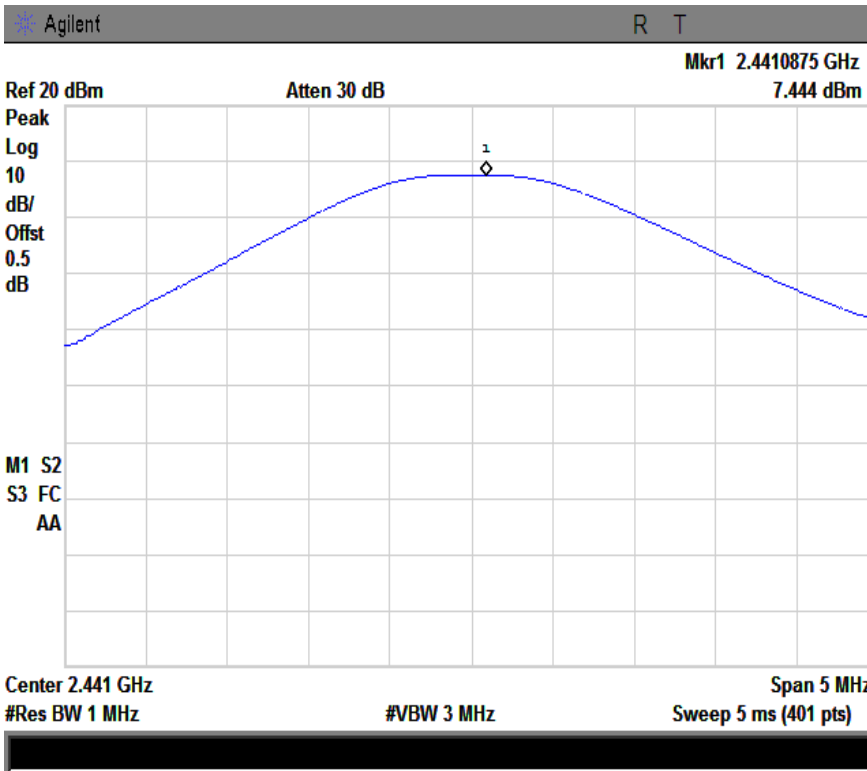

39-1M

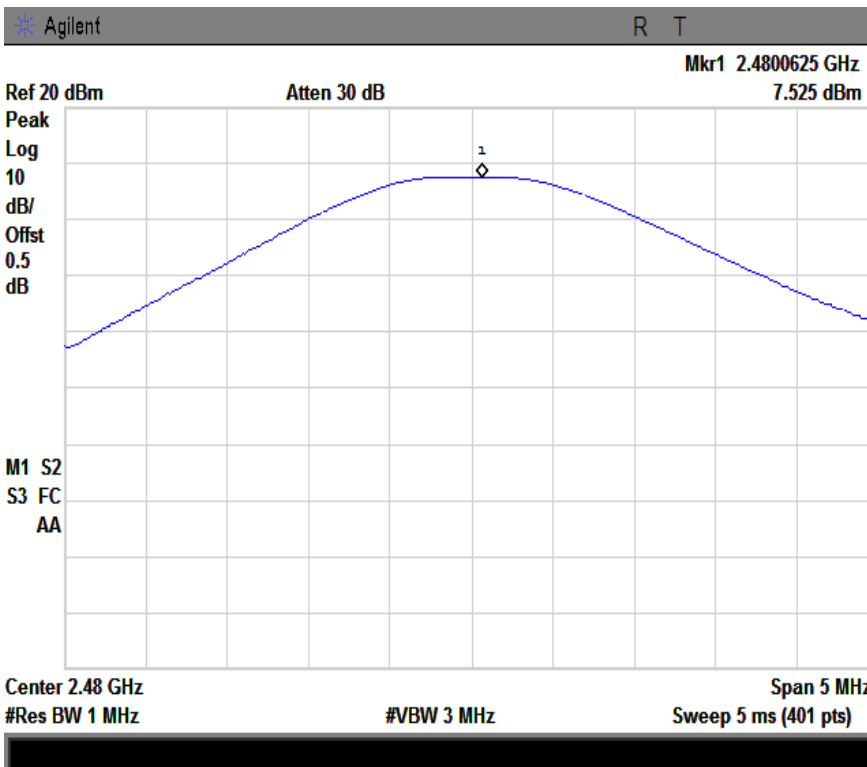

78-1M

Test Mode: π /4DQPSK Transmitting

Channel	Channel frequency (MHz)	Peak output power (dBm)	Power output (mW)	Limit (mW)
Low channel	2402	6.603	4.574	125
Middle channel	2441	6.710	4.688	125
High channel	2480	6.915	4.915	125

Please refer to the following plots.

Note: The data above was tested in conducted mode.

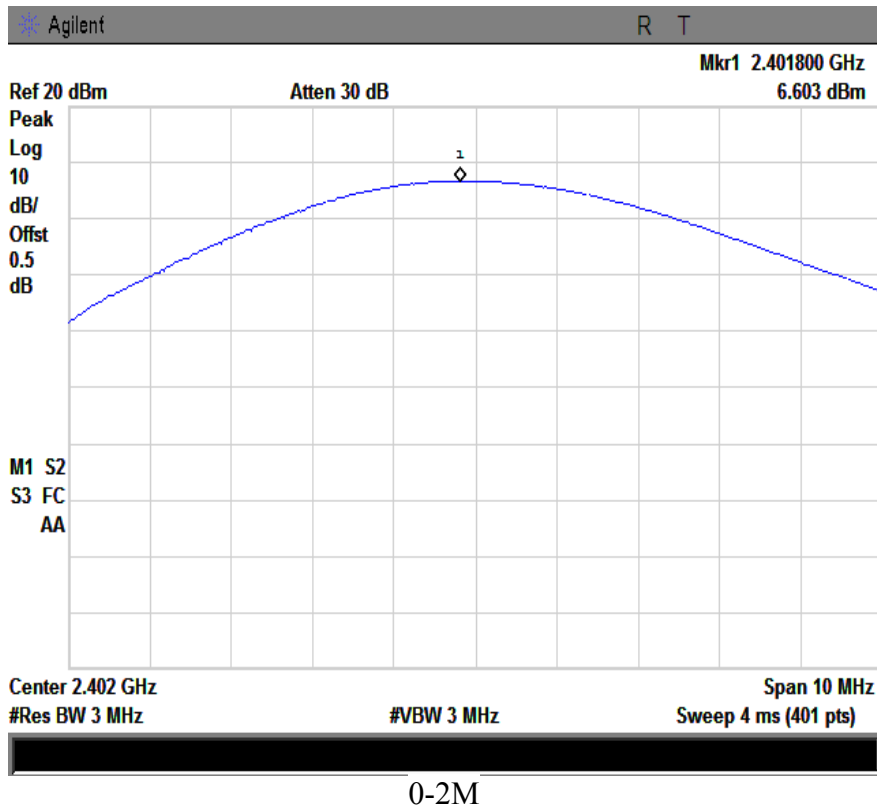



SIEMIC, INC.

Accessing global markets

Title: RF Test Report for Qwerty Phone
Main Model: QW125
Main Model: N/A
To: FCC 15.247: 2013, ANSI C63.4: 2009

Report No: 14050038-FCC-R2
Issue Date: July 04, 2014
Page: 46 of 83
www.sieminc.com
www.sieminc.com.cn

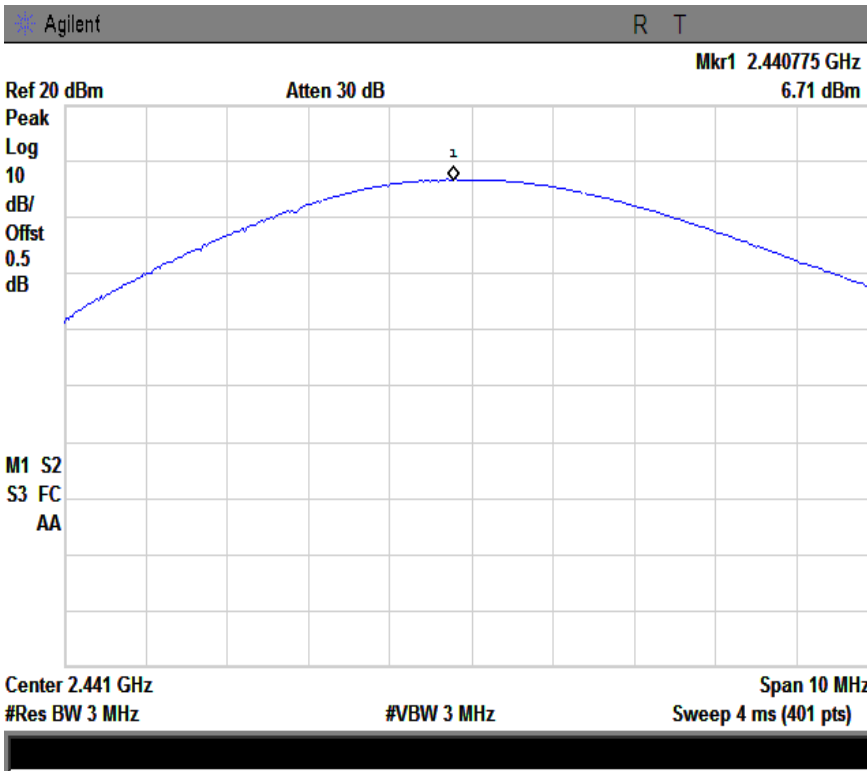

39-2M

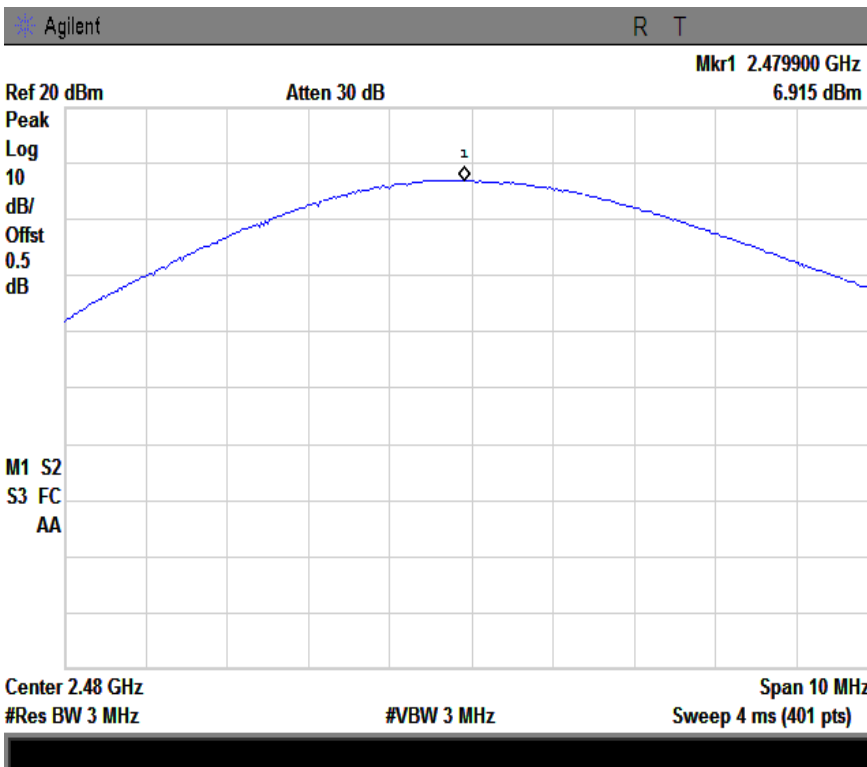

78-2M

Test Mode: 8DPSK Transmitting

Channel	Channel frequency (MHz)	Peak output power (dBm)	Power output (mW)	Limit (mW)
Low channel	2402	6.455	4.421	125
Middle channel	2441	6.504	4.471	125
High channel	2480	6.563	4.532	125

Please refer to the following plots.

Note: The data above was tested in conducted mode.

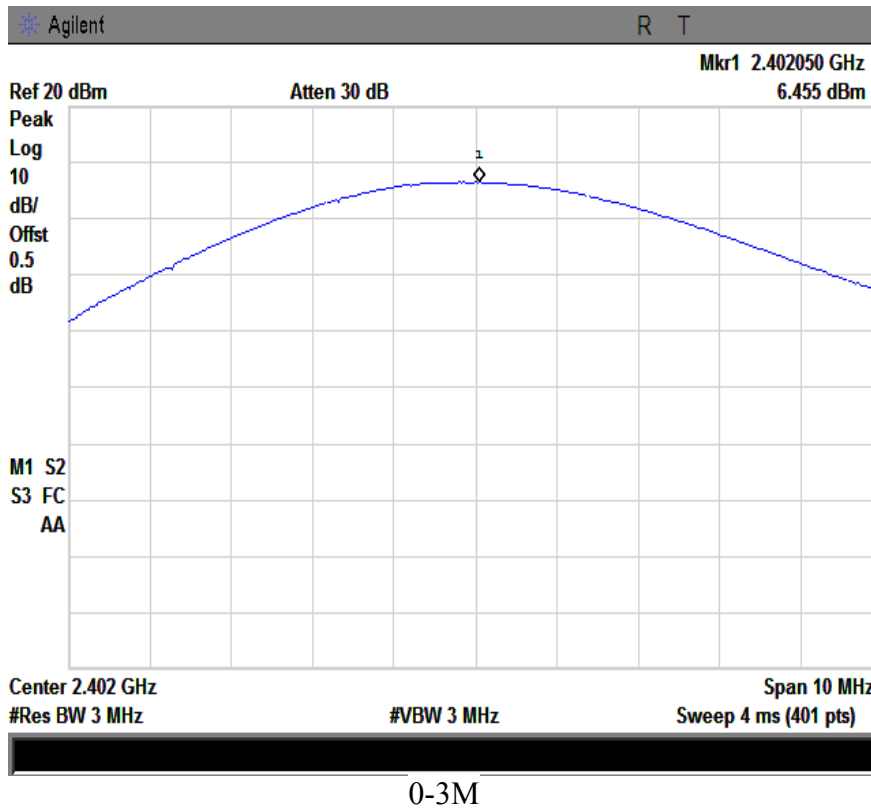



SIEMIC, INC.

Accessing global markets

Title: RF Test Report for Qwerty Phone
Main Model: QW125
Main Model: N/A
To: FCC 15.247: 2013, ANSI C63.4: 2009

Report No: 14050038-FCC-R2
Issue Date: July 04, 2014
Page: 48 of 83
www.sieminc.com
www.sieminc.com.cn

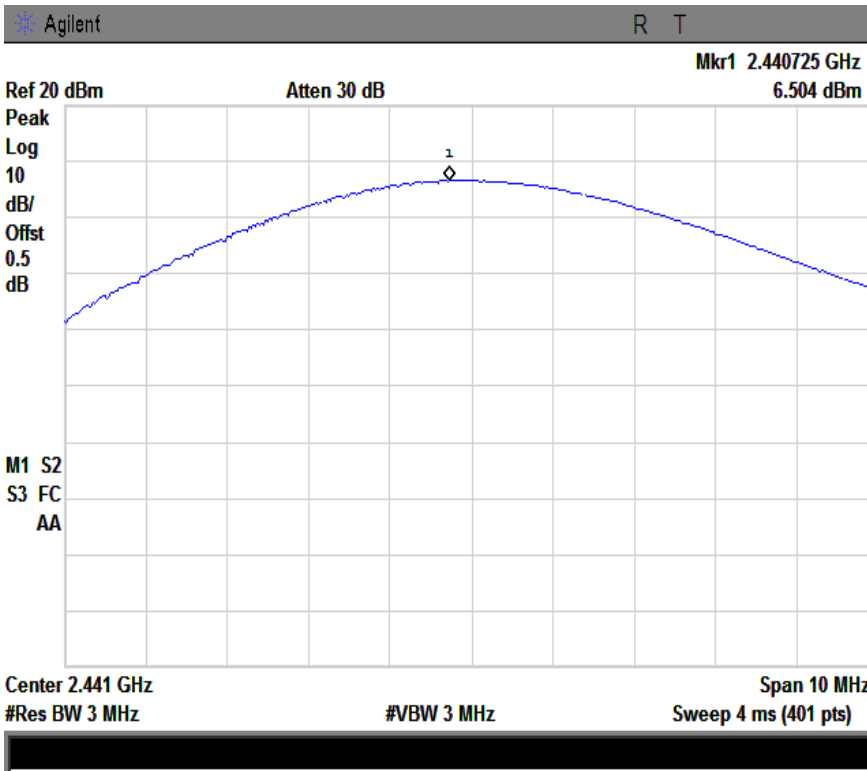

39-3M

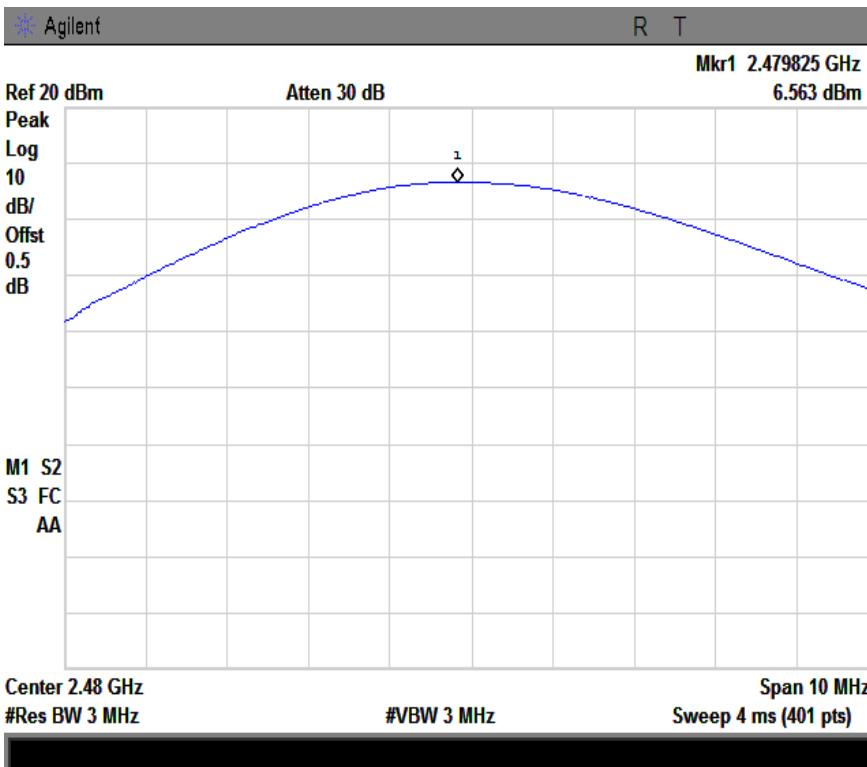

78-3M

5.9 §15.247(d) - Band Edge

Standard Requirement:

In any 100 kHz bandwidth outside the frequency band in which the spread spectrum or digitally modulated intentional radiator is operating, the radio frequency power that is produced by the intentional radiator shall be at least 20 dB below that in the 100 kHz bandwidth within the band that contains the highest level of the desired power, based on either an RF conducted or a radiated measurement, provided the transmitter demonstrates compliance with the peak conducted power limits. If the transmitter complies with the conducted power limits based on the use of RMS averaging over a time interval, as permitted under paragraph (b)(3) of this section, the attenuation required under this paragraph shall be 30 dB instead of 20 dB. Attenuation below the general limits specified in §15.209(a) is not required. In addition, radiated emissions which fall in the restricted bands, as defined in §15.205(a), must also comply with the radiated emission limits specified in §15.209(a) (see §15.205(c)).

Procedures: (Radiated Method Only)

1. Check the calibration of the measuring instrument using either an internal calibrator or a known signal from an external generator.
2. Position the EUT without connection to measurement instrument. Put it on the Rotated table and turn on the EUT and make it operate in transmitting mode. Then set it to Low Channel and High Channel within its operating range, and make sure the instrument is operated in its linear range.
3. First, set both RBW and VBW of spectrum analyzer to 100 kHz with a convenient frequency span including 100kHz bandwidth from band edge, check the emission of EUT, if pass then set Spectrum Analyzer as below:
 - a. The resolution bandwidth and video bandwidth of test receiver/spectrum analyzer is 120 kHz for Quasiy Peak detection at frequency below 1GHz.
 - b. The resolution bandwidth of test receiver/spectrum analyzer is 1MHz and video bandwidth is 3MHz for Peak detection at frequency above 1GHz.
 - c. The resolution bandwidth of test receiver/spectrum analyzer is 1MHz and the video bandwidth for Average detection (AV) as below at frequency above 1GHz.
 1 kHz (Duty cycle < 98%) 10 Hz (Duty cycle > 98%)
4. Measure the highest amplitude appearing on spectral display and set it as a reference level. Plot the graph with marking the highest point and edge frequency.
5. Repeat above procedures until all measured frequencies were complete.

Note:

For Hopping device, should test hopping mode and CW Tx mode separately. For hopping mode, find out the worst points outside the frequency band firstly, then set the worst points as the center frequency, use above average 3 (c) spectrum analyzer set, find out the final worst average value separately.

Test Result: Pass

Test Mode:	GFSK Hopping & Transmitting
-------------------	--

Please refer to the following plots.

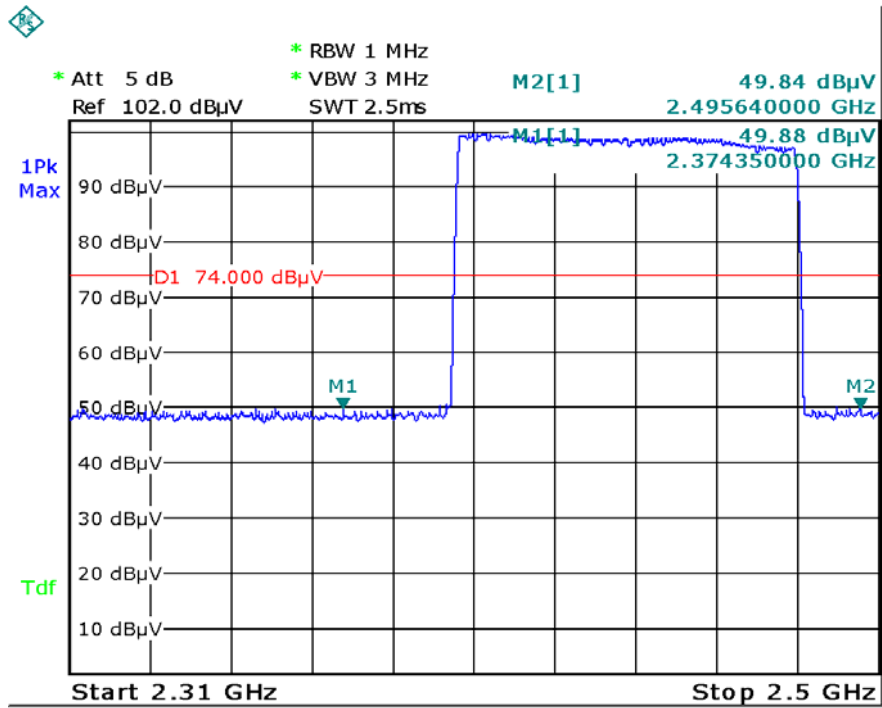

Date: 2.JUL.2014 10:23:27

1M-HOPPING-PK

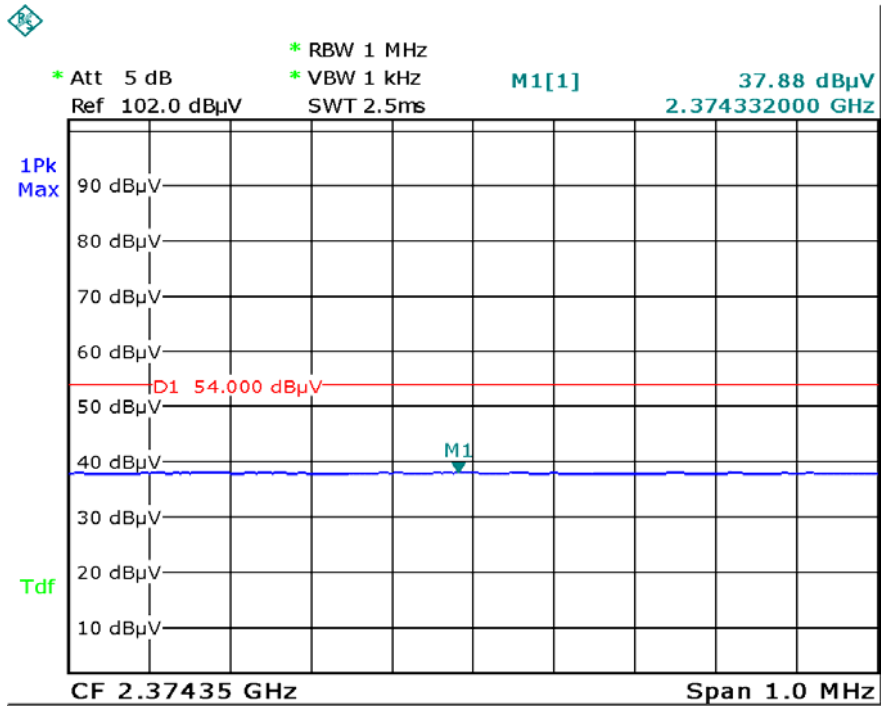

Date: 2.JUL.2014 10:27:04

1M-HOPPING Left Side-AV

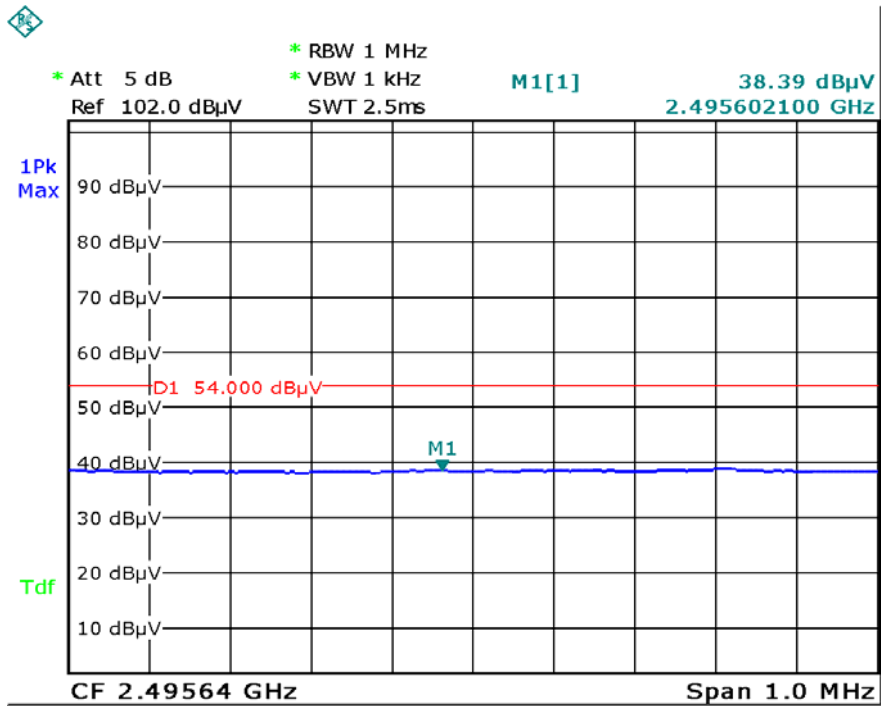

Date: 2.JUL.2014 10:25:51

1M-HOPPING Right Side-AV

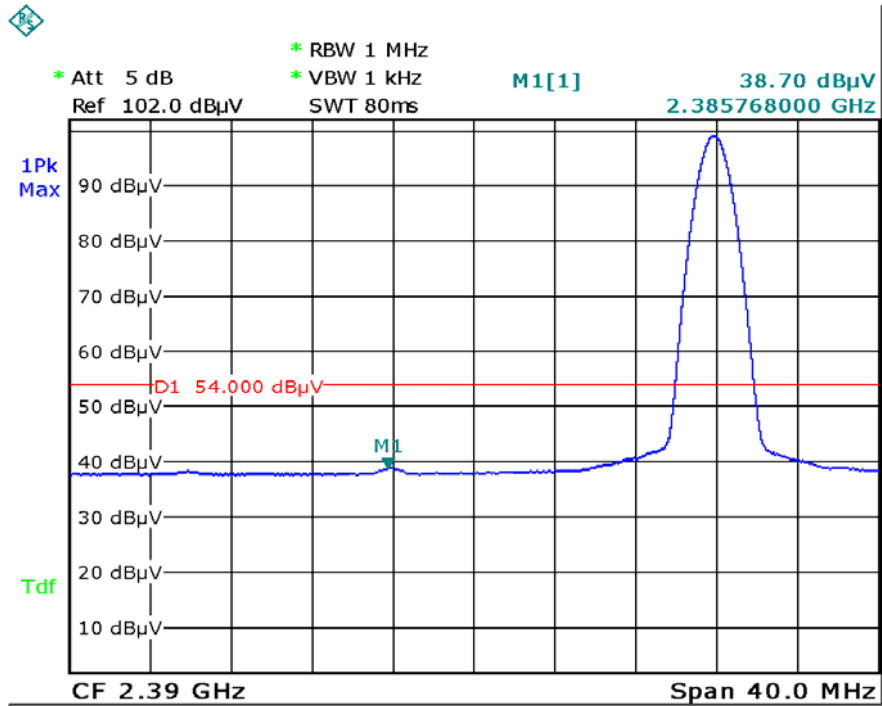

Date: 1.JUL.2014 17:00:07

1M-Left Side-AV

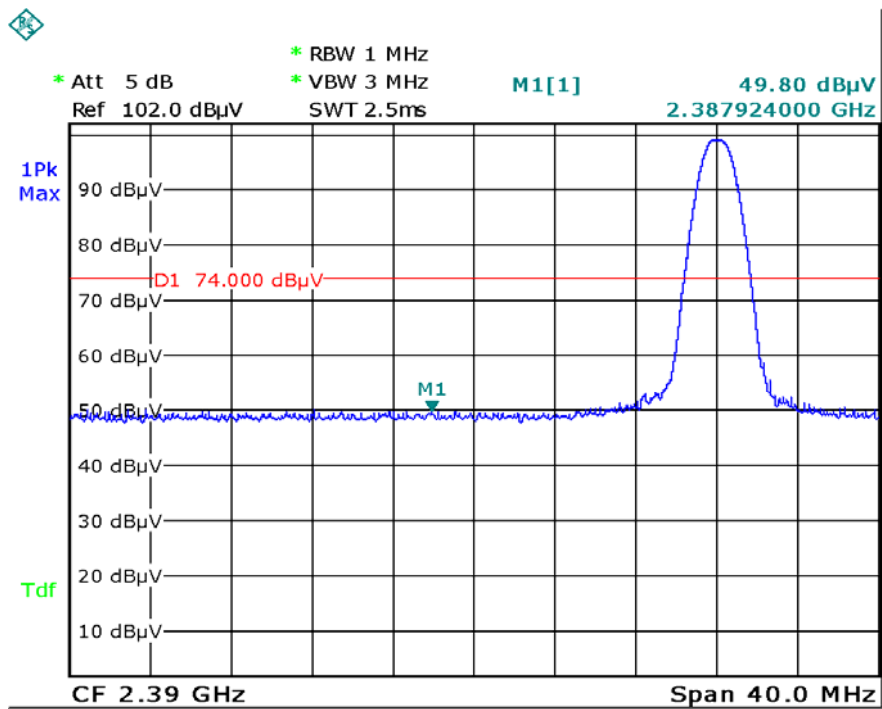

Date: 1.JUL.2014 16:57:21

1M-Left Side-PK

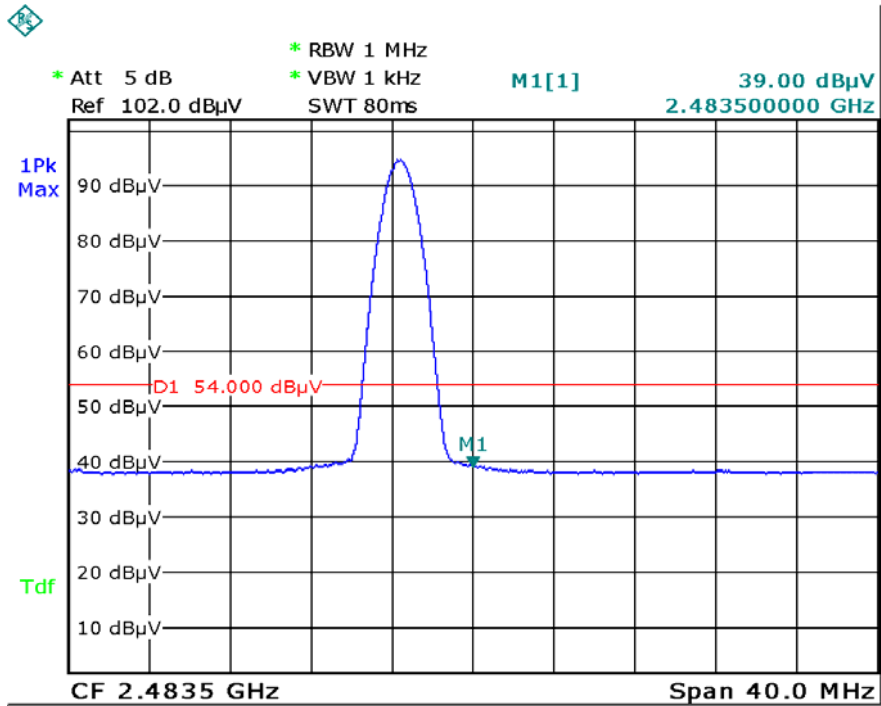

Date: 1.JUL.2014 17:23:40

1M-Right Side-AV

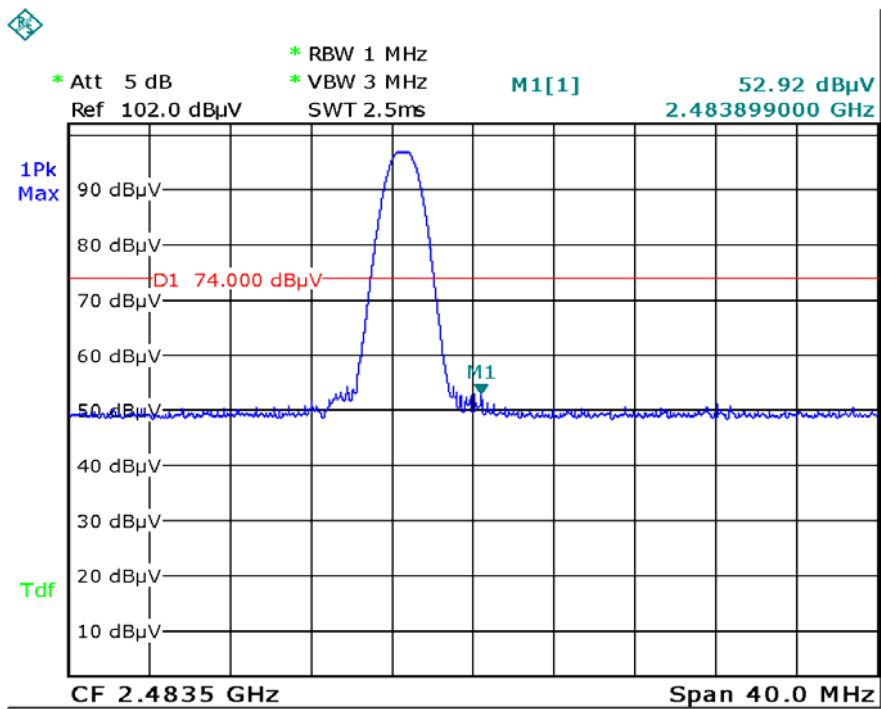

Date: 1.JUL.2014 17:20:28

1M-Right Side-PK

Test Mode:	π /4DQPSK Hopping& Transmitting
-------------------	---

Please refer to the following plots.

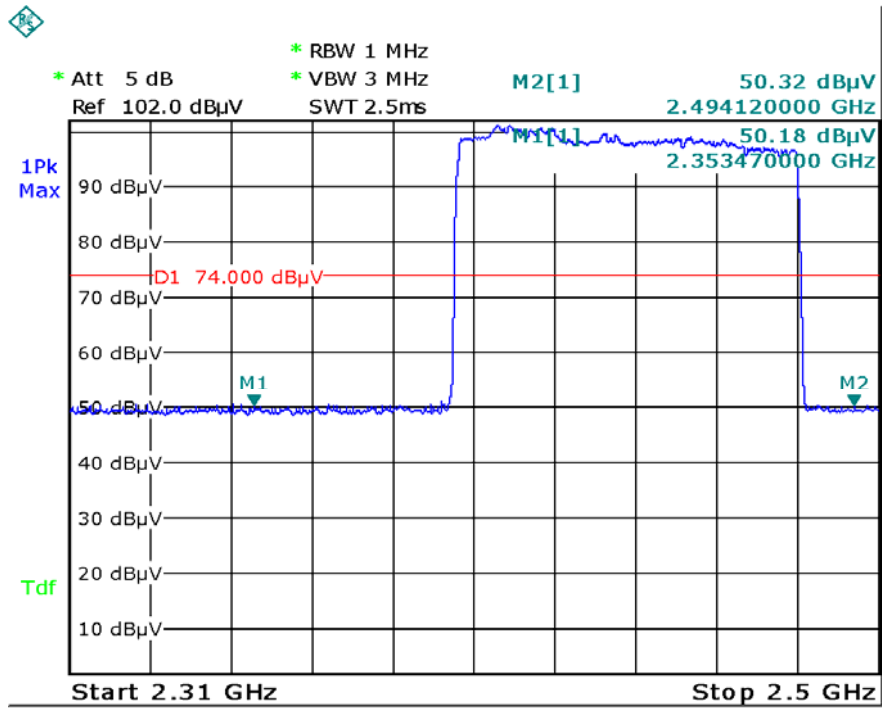

Date: 2.JUL.2014 10:42:56

2M-HOPPING-PK

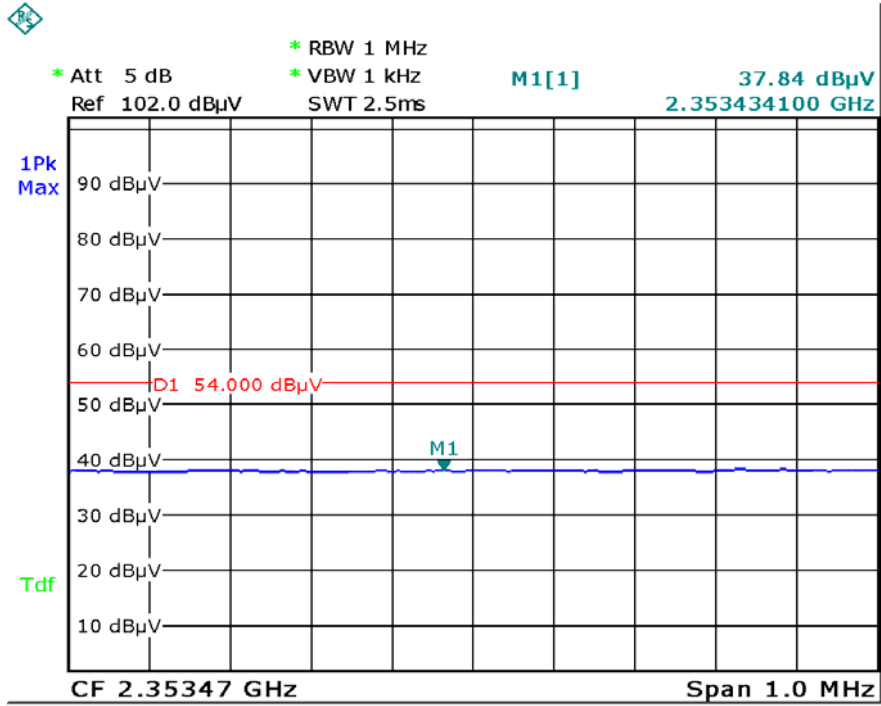

Date: 2.JUL.2014 10:46:15

2M-HOPPING Left Side-AV

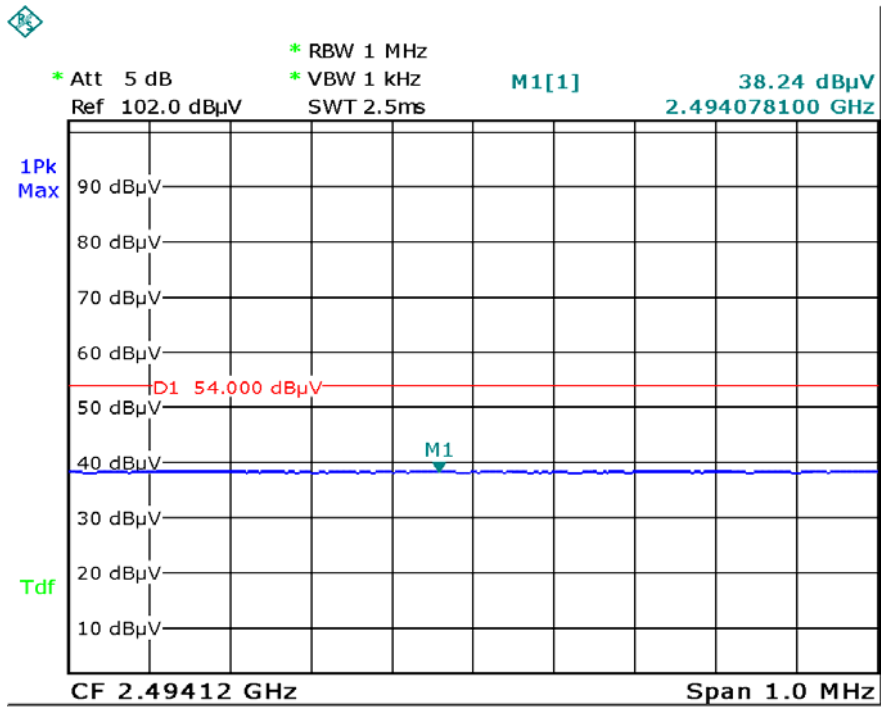

Date: 2.JUL.2014 10:45:20

2M-HOPPING Right Side-AV



SIEMIC, INC.

Accessing global markets

Title: RF Test Report for Qwerty Phone
Main Model: QW125
Main Model: N/A
To: FCC 15.247: 2013, ANSI C63.4: 2009

Report No: 14050038-FCC-R2
Issue Date: July 04, 2014
Page: 56 of 83
www.siemic.com
www.siemic.com.cn

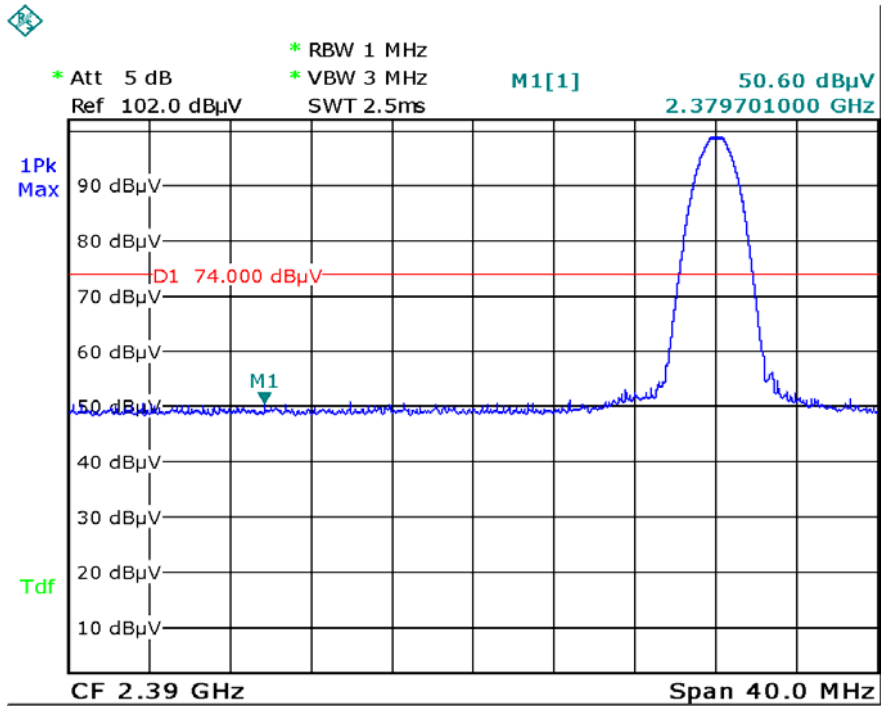

Date: 1.JUL.2014 17:40:25

2M-Left Side-AV

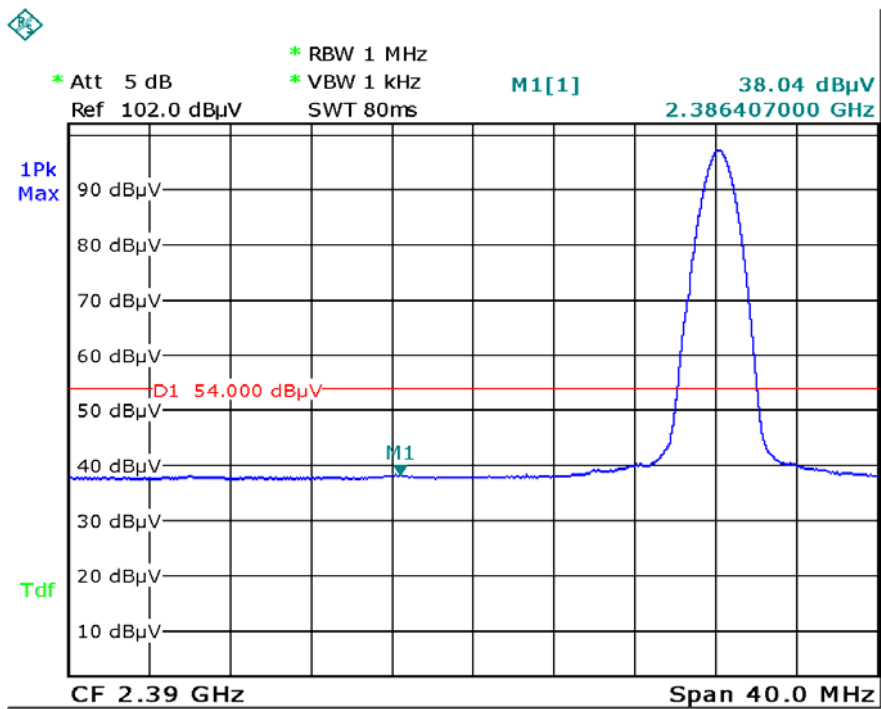

Date: 1.JUL.2014 17:38:14

2M-Left Side-PK

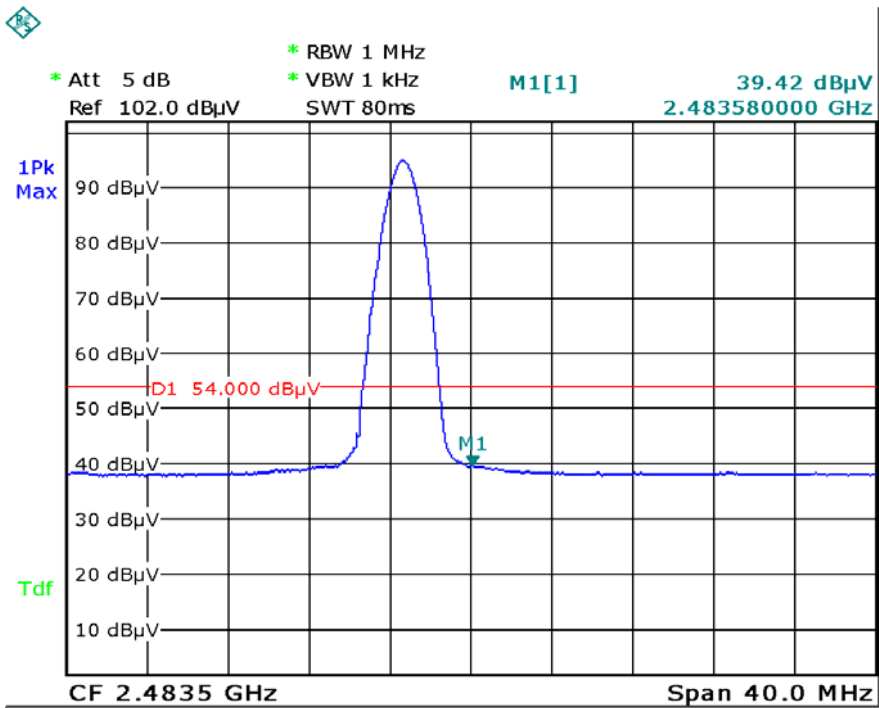

Date: 1.JUL.2014 17:44:40

2M-Right Side-AV

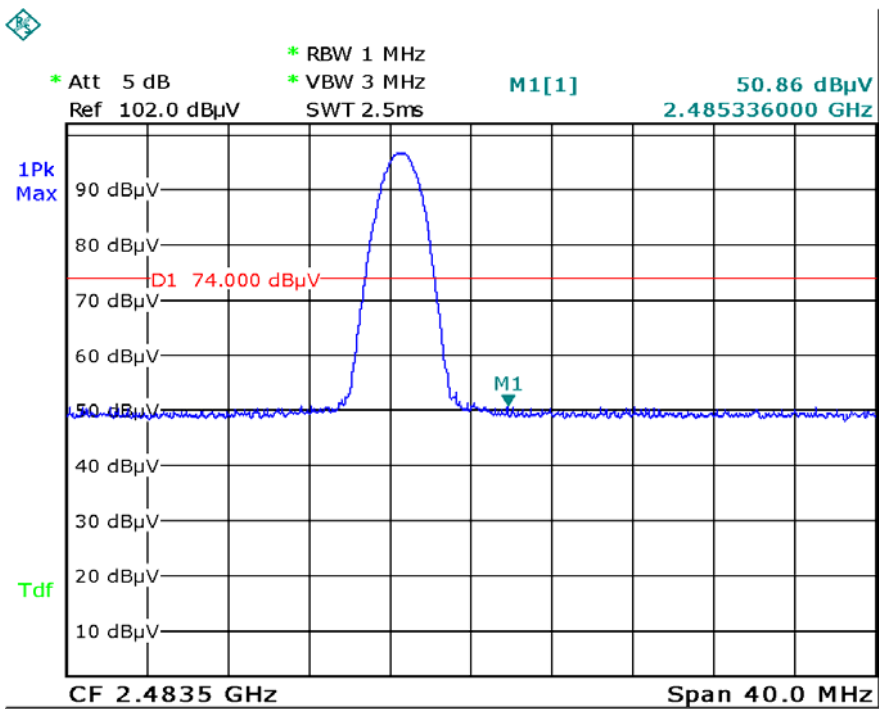

Date: 1.JUL.2014 17:43:48

2M-Right Side-PK

Test Mode: 8DPSK Hopping & Transmitting

Please refer to the following plots.

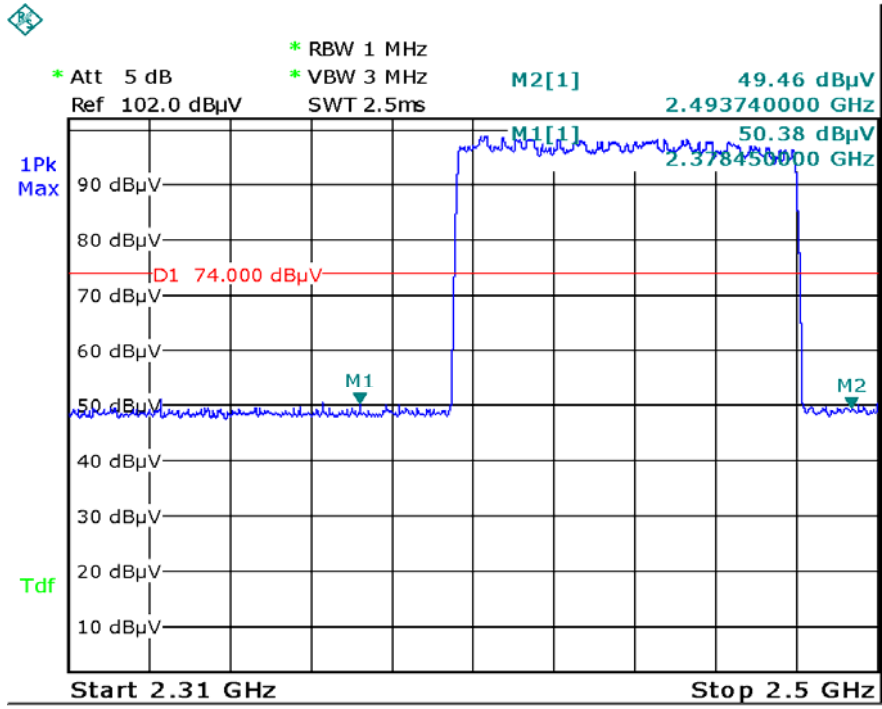

Date: 2.JUL.2014 10:51:55

3M-HOPPING-PK

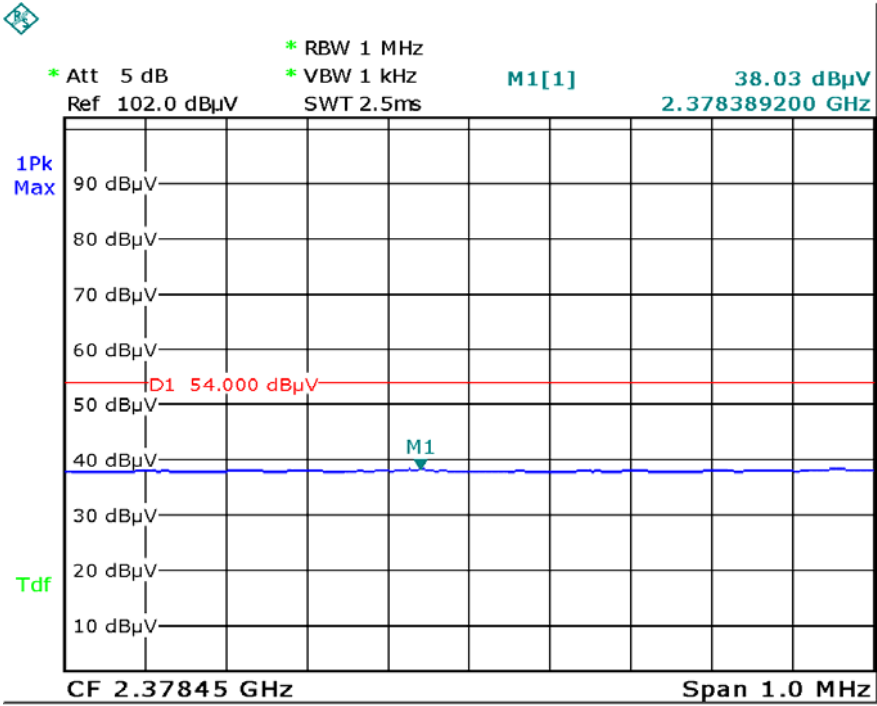

Date: 2.JUL.2014 10:54:45

3M-HOPPING Left Side-AV

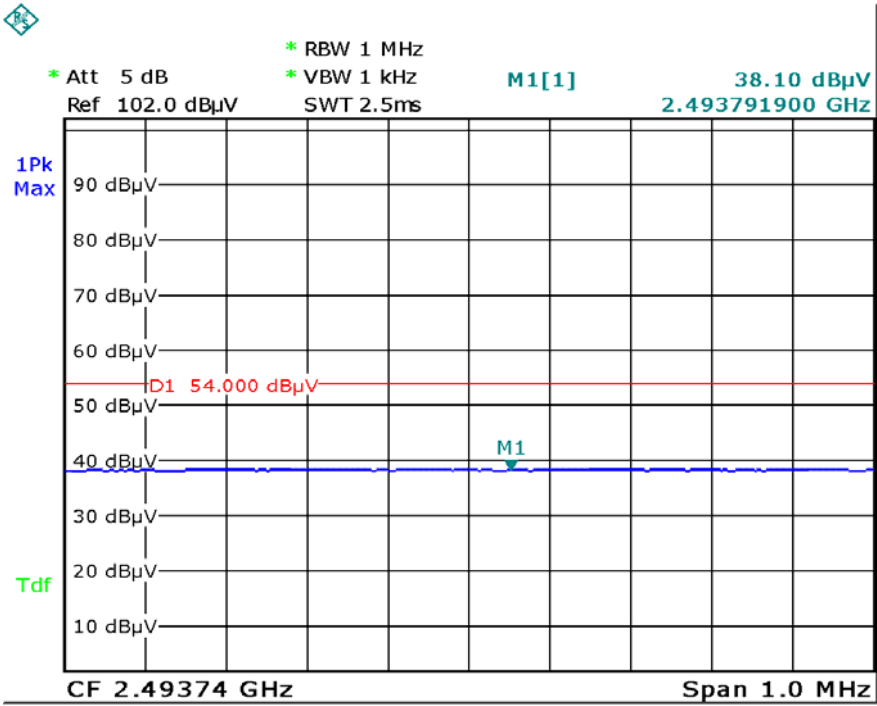

Date: 2.JUL.2014 10:57:20

3M-HOPPING Right Side-AV



SIEMIC, INC.

Accessing global markets

Title: RF Test Report for Qwerty Phone
Main Model: QW125
Main Model: N/A
To: FCC 15.247: 2013, ANSI C63.4: 2009

Report No: 14050038-FCC-R2
Issue Date: July 04, 2014
Page: 60 of 83
www.siemec.com
www.siemec.com.cn

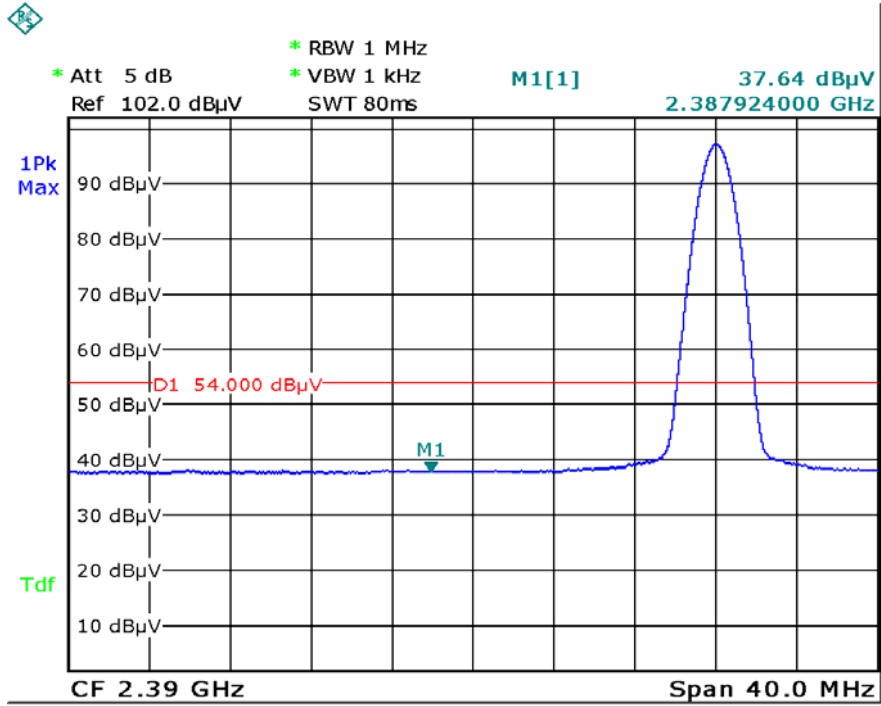

Date: 1.JUL.2014 17:34:06

3M-Left Side-AV

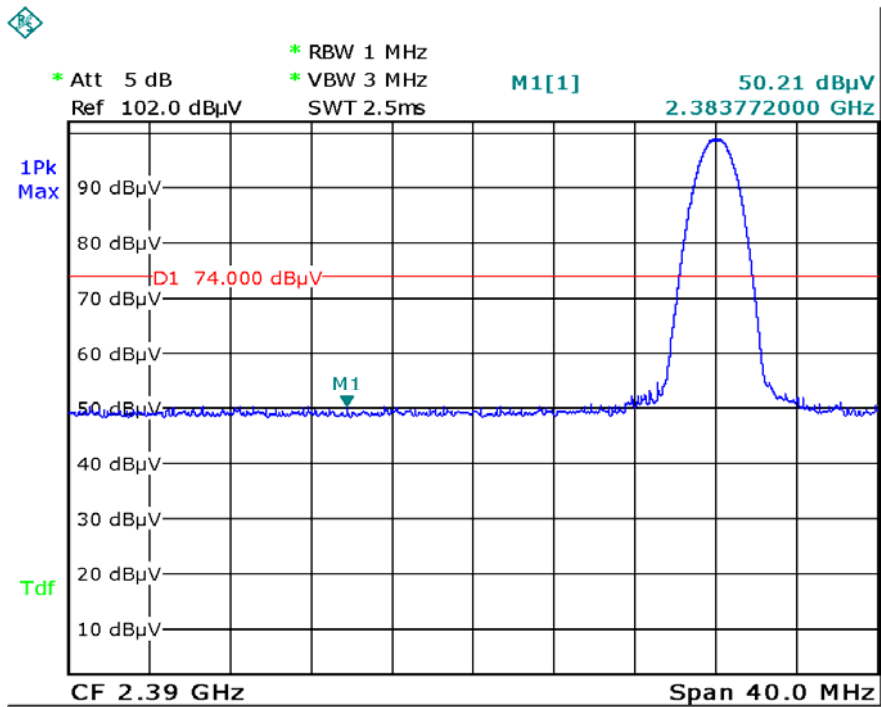

Date: 1.JUL.2014 17:32:39

3M-Left Side-PK

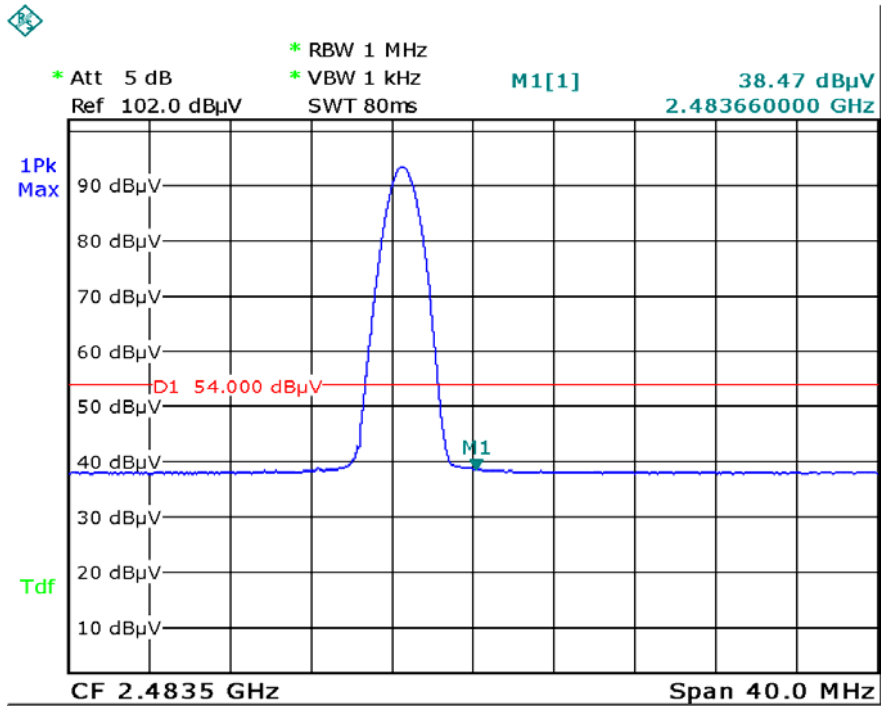

Date: 1.JUL.2014 17:26:45

3M-Right Side-AV

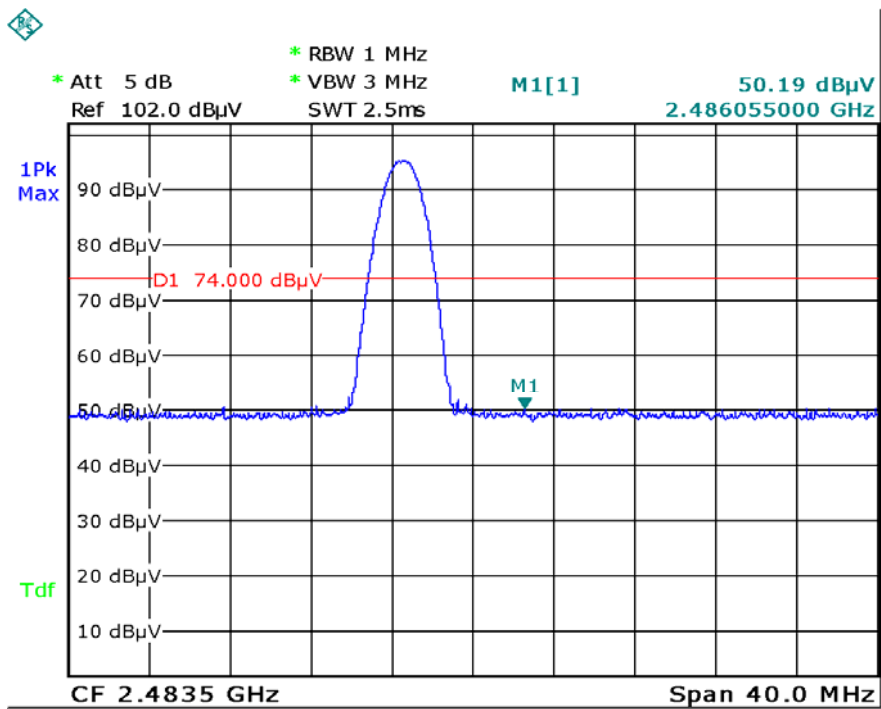

Date: 1.JUL.2014 17:27:45

3M-Right Side-PK

Annex A. TEST INSTRUMENT & METHOD

Annex A.i. TEST INSTRUMENTATION & GENERAL PROCEDURES

Instrument	Model	Serial #	Calibration Date	Calibration Due Date
AC Line Conducted Emissions				
EMI test receiver	ESCS30	8471241027	05/27/2014	05/26/2015
Line Impedance Stabilization Network	LI-125A	191106	11/14/2013	11/13/2014
Line Impedance Stabilization Network	LI-125A	191107	11/14/2013	11/13/2014
LISN	ISN T800	34373	01/11/2014	01/10/2015
Double Ridge Horn Antenna (1 ~18GHz)	AH-118	71283	11/20/2013	11/19/2014
Transient Limiter	LIT-153	531118	09/02/2013	09/01/2014
RF conducted test				
Agilent ESA-E SERIES SPECTRUM ANALYZER	E4407B	MY45108319	09/17/2013	09/16/2014
Power Splitter	1#	1#	09/02/2013	09/01/2014
DC Power Supply	E3640A	MY40004013	09/17/2013	09/16/2014
Wireless Connectivity Test Set	N4010A	GB44440198	03/20/2014	03/19/2015
Radiated Emissions				
EMI test receiver	ESL6	100262	11/23/2013	11/22/2014
Positioning Controller	UC3000	MF780208282	11/19/2013	11/19/2014
OPT 010 AMPLIFIER (0.1-1300MHz)	8447E	2727A02430	09/02/2013	09/01/2014
Microwave Preamplifier (0.5 ~ 18GHz)	PAM-118	443008	09/02/2013	09/01/2014
Bilog Antenna (30MHz~6GHz)	JB6	A110712	09/23/2013	09/22/2014
Double Ridge Horn Antenna (1 ~18GHz)	AH-118	71283	11/20/2013	11/19/2014
Universal Radio Communication Tester	CMU200	121393	09/17/2013	09/16/2014

Annex A.ii. CONDUCTED EMISSIONS TEST DESCRIPTION

Test Set-up

1. The EUT and supporting equipment were set up in accordance with the requirements of the standard on top of a 1.5m x 1m x 0.8m high, non-metallic table, as shown in Annex B.
2. The power supply for the EUT was fed through a 50Ω/50μH EUT LISN, connected to filtered mains.
3. The RF OUT of the EUT LISN was connected to the EMI test receiver via a low-loss coaxial cable.
4. All other supporting equipments were powered separately from another main supply.

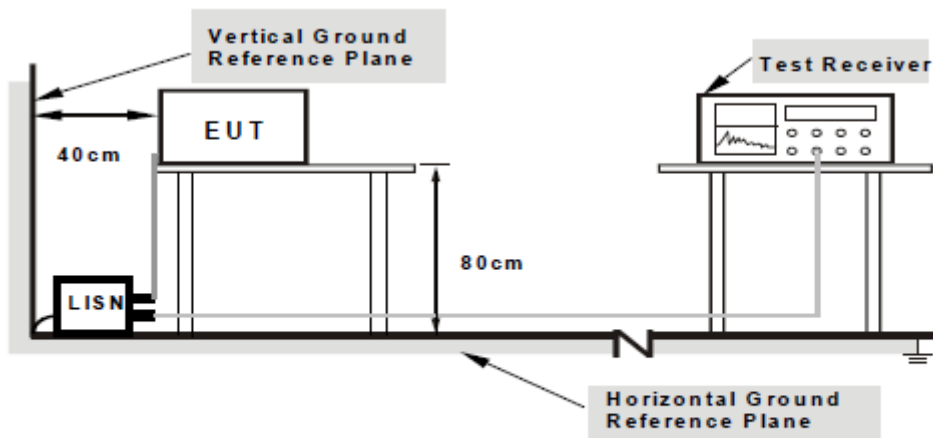

**Note: 1.Support units were connected to second LISN.
 2.Both of LISNs (AMN) are 80cm from EUT and at least 80cm from other units and other metal planes support units.**

For the actual test configuration, please refer to the related item – Photographs of the Test Configuration1.

Test Method

1. The EUT was switched on and allowed to warm up to its normal operating condition.
2. A scan was made on the NEUTRAL line (for AC mains) or Earth line (for DC power) over the required frequency range using an EMI test receiver.
3. High peaks, relative to the limit line, were then selected.
4. The EMI test receiver was then tuned to the selected frequencies and the necessary measurements made with a receiver bandwidth setting of 10 kHz. For FCC tests, only Quasi-peak measurements were made; while for CISPR/EN tests, both Quasi-peak and Average measurements were made.
5. Steps 2 to 4 were then repeated for the LIVE line (for AC mains) or DC line (for DC power).

Description of Conducted Emission Program

This EMC Measurement software run LabView automation software and offers a common user interface for electromagnetic interference (EMI) measurements. This software is a modern and powerful tool for controlling and monitoring EMI test receivers and EMC test systems. It guarantees reliable collection, evaluation, and documentation of measurement results. Basically, this program will run a pre-scan measurement before it proceeds with the final measurement. The pre-scan routine will run the common scan range from 150 kHz to 30 MHz; the program will first start a peak and average scan on selectable measurement time and step size. After the program complete the pre-scan, this program will perform the Quasi Peak and Average measurement, based on the pre-scan peak data reduction result.

Sample Calculation Example

At 20 MHz

limit = $250 \mu\text{V} = 47.96 \text{ dB}\mu\text{V}$

Transducer factor of LISN, pulse limiter & cable loss at 20 MHz = 11.20 dB

Q-P reading obtained directly from EMI Receiver = 40.00 dB μV
(Calibrated for system losses)

Therefore, Q-P margin = $47.96 - 40.00 = 7.96$ i.e. **7.96 dB below limit**

Annex B. EUT AND TEST SETUP PHOTOGRAPHS

Annex B.i. Photograph 1: EUT External Photo



Whole Package - Top View



Adapter – Front View



EUT - Front View



EUT - Rear View



EUT - Top View



EUT - Bottom View



EUT - Left View



EUT - Right View

Annex B.ii. Photograph 2: EUT Internal Photo



Cover Off - Top View 1



Cover Off - Top View 2



Battery - Top View



Battery - Bottom View

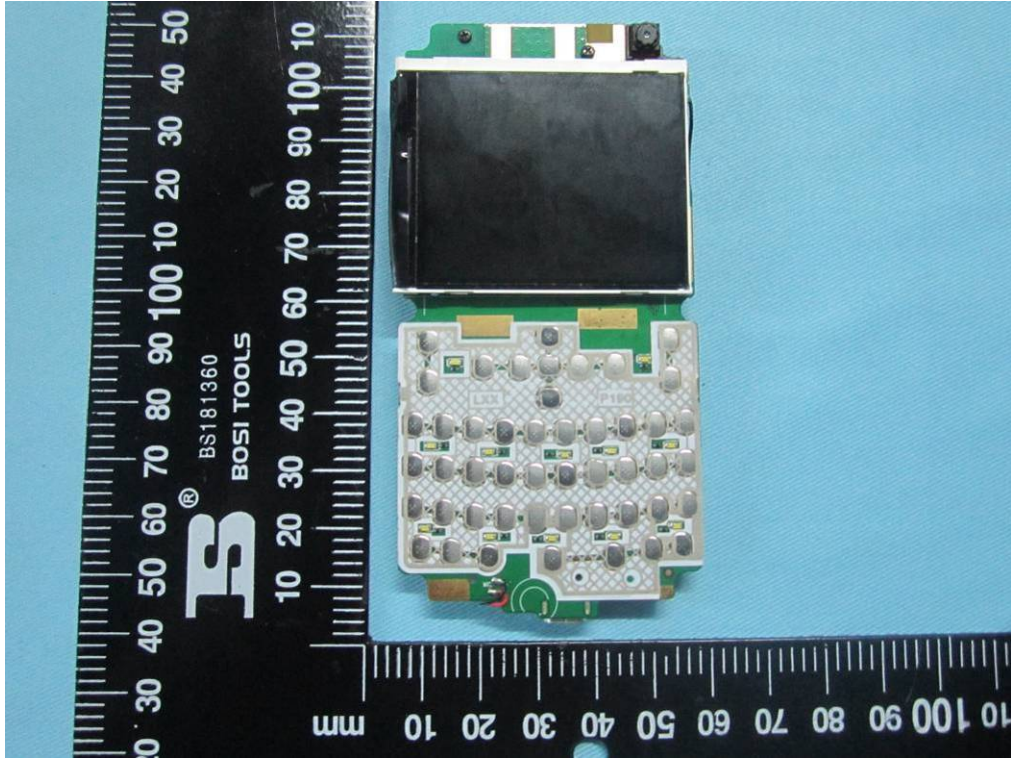

LCD – Front View

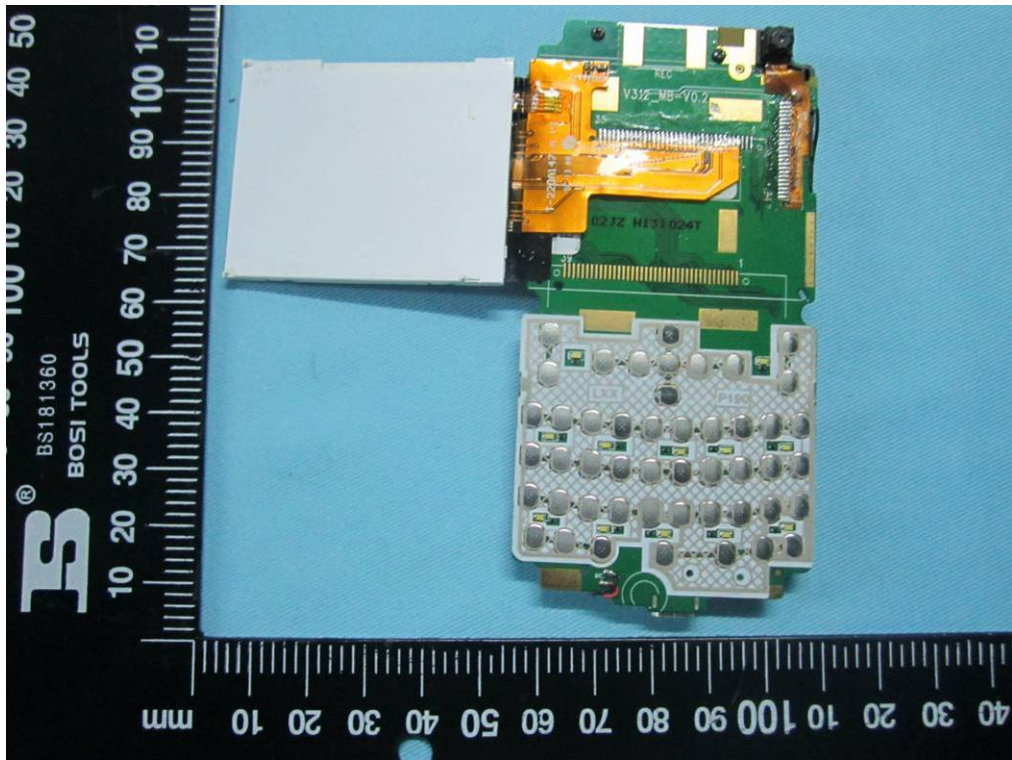

LCD – Rear View

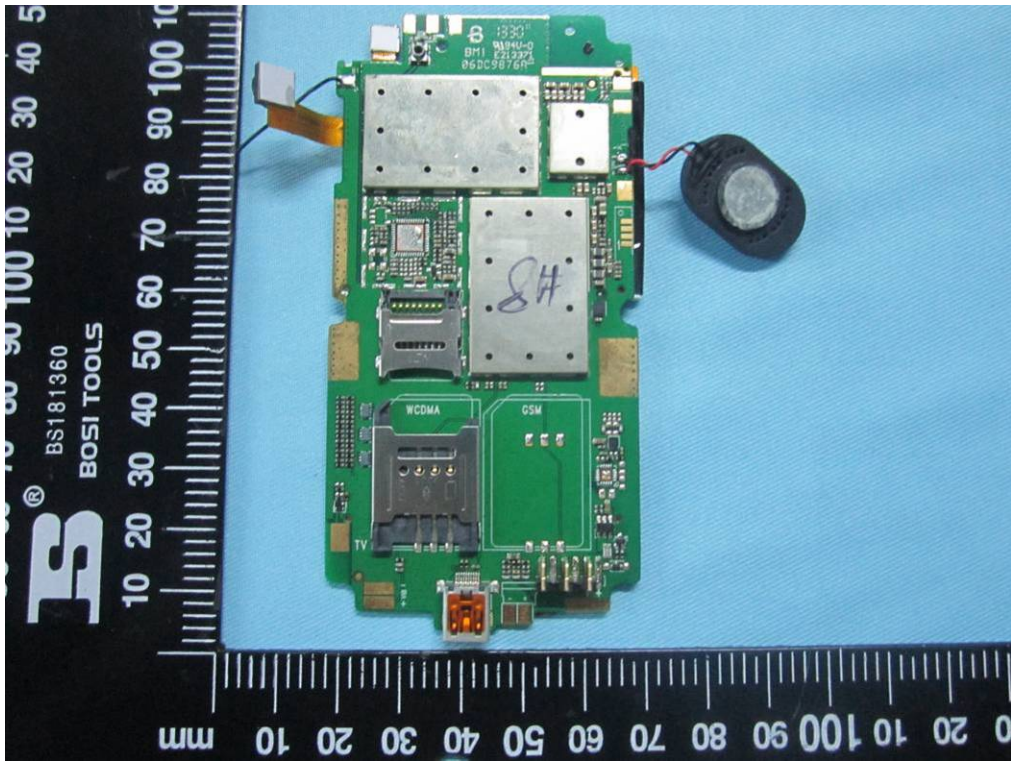

Mainboard With Shielding - Front View

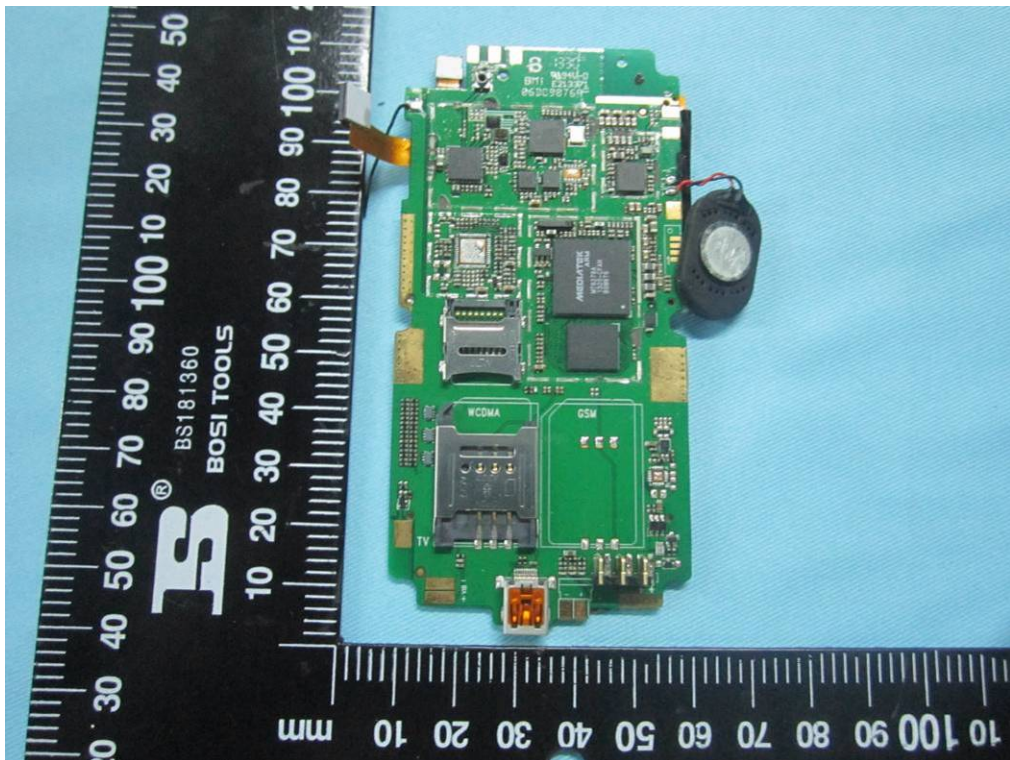

Mainboard Without Shielding - Front View

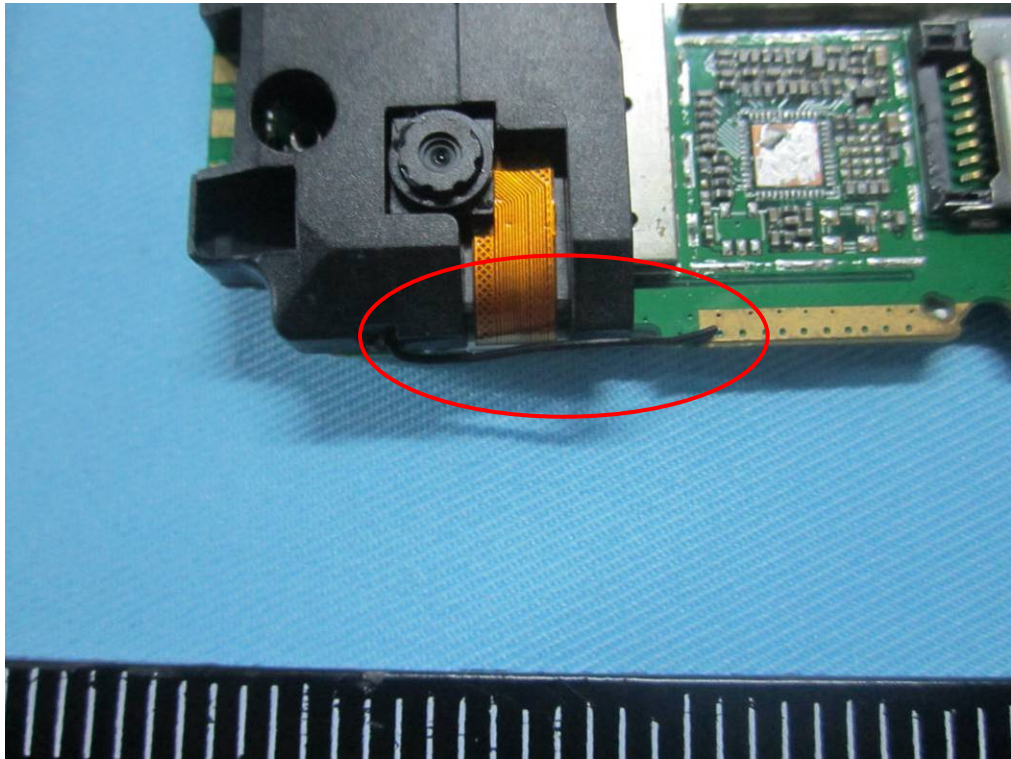

BT Antenna View



WIFI Antenna View



GSM/PCS/UMTS-FDD Antenna

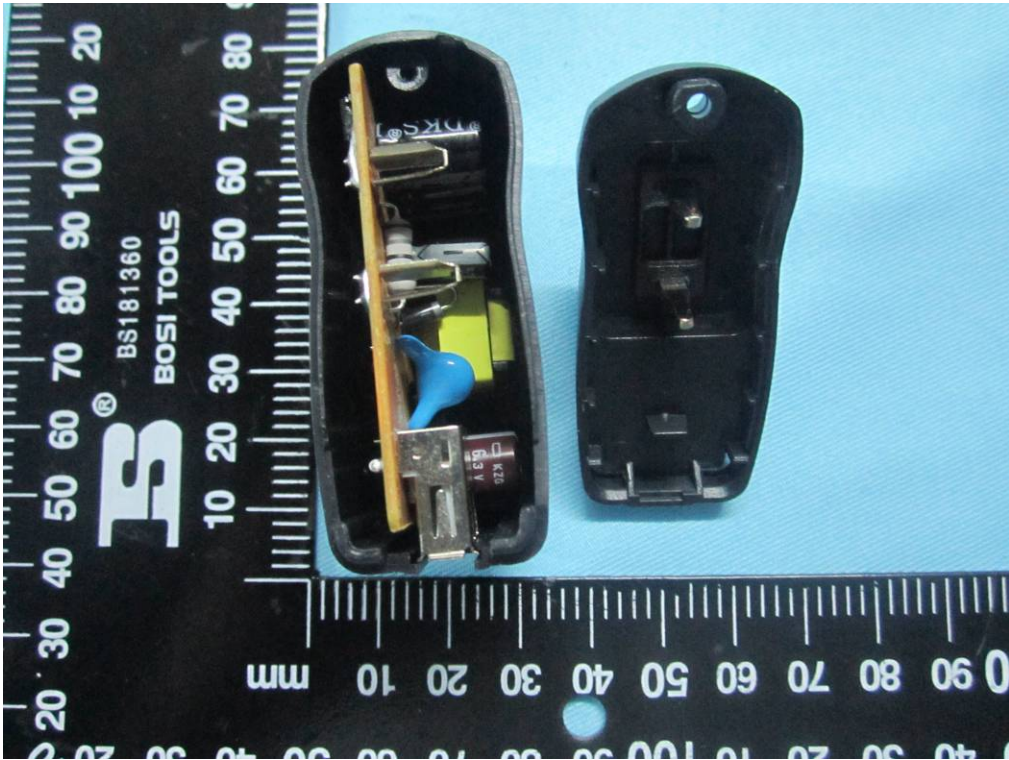

Adapter Cover Off – Front View

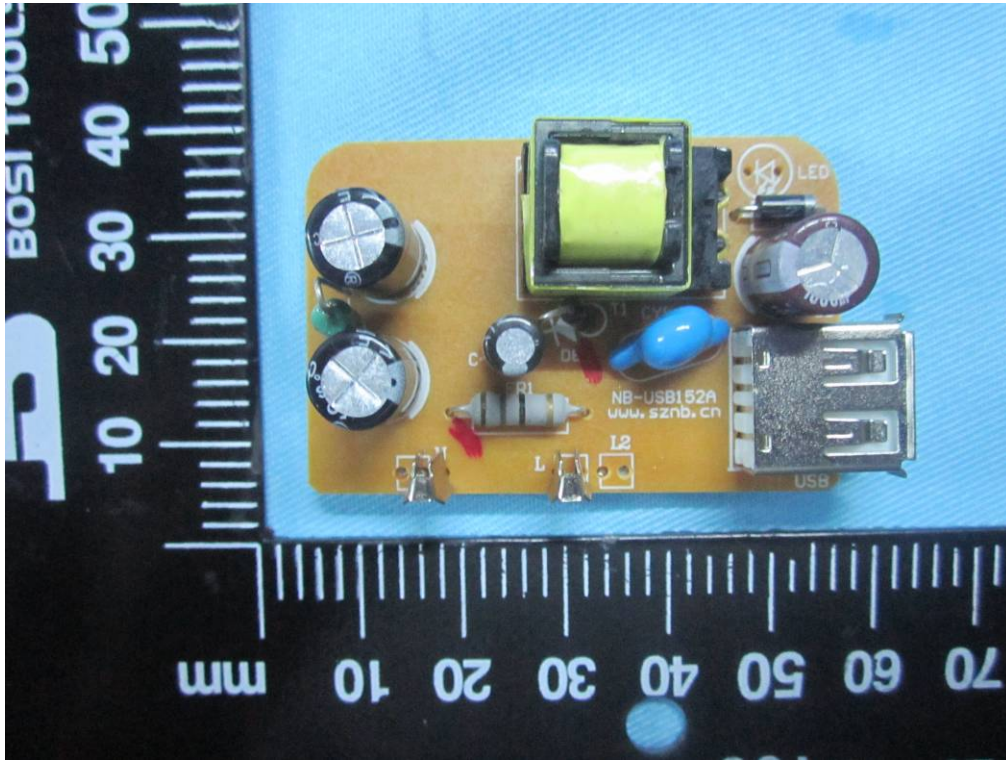

Adapter Mainboard - Front View

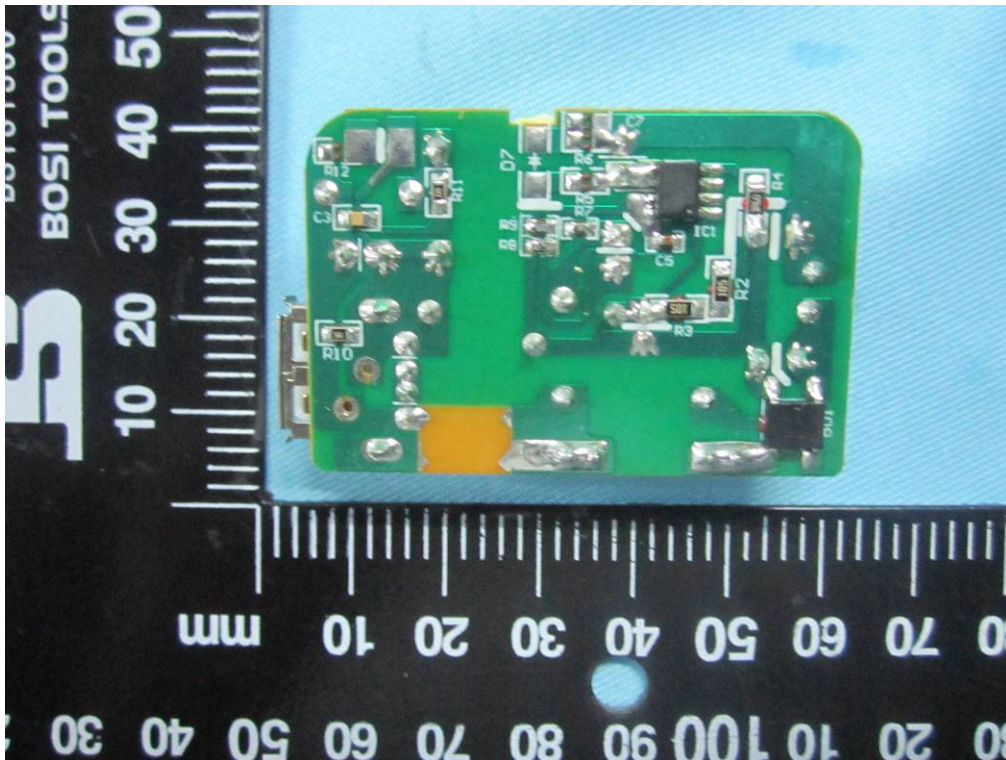

Adapter Mainboard - Rear View

Annex B.iii. Photograph 3: Test Setup Photo



Conducted Emissions Test Setup Front View



Conducted Emissions Test Setup Side View

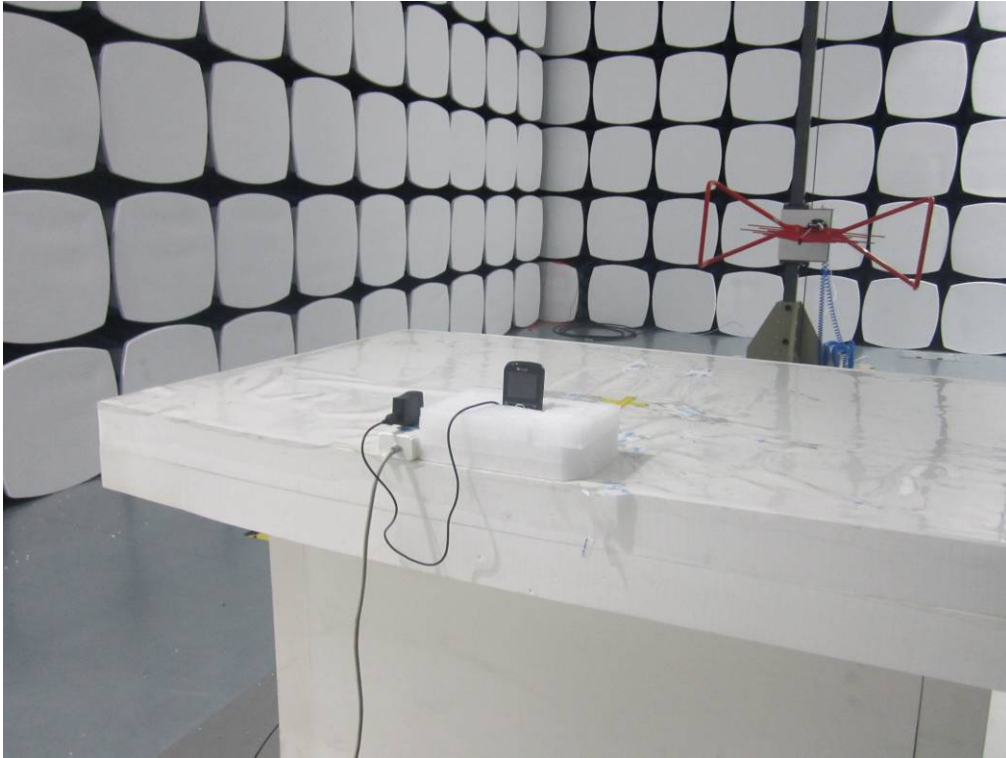

Radiated Spurious Emissions Test Setup Below 1GHz - Front View

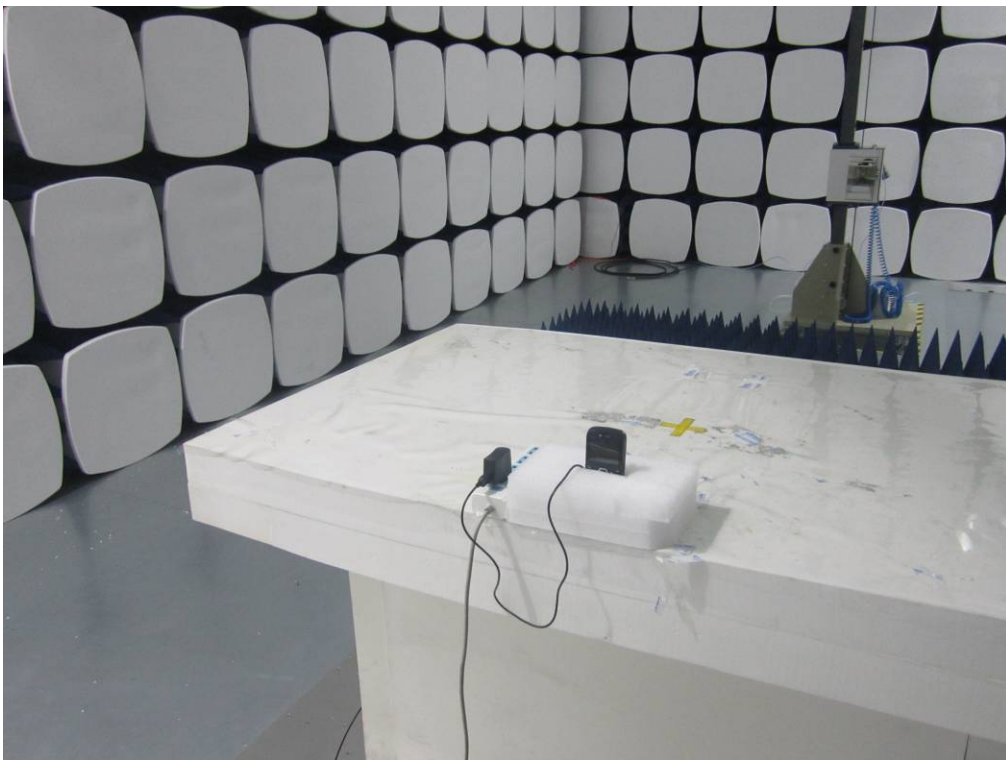

Radiated Spurious Emissions Test Setup Above 1GHz –Front View

Annex C. TEST SETUP AND SUPPORTING EQUIPMENT

EUT TEST CONDITIONS

Annex C. i. SUPPORTING EQUIPMENT DESCRIPTION

The following is a description of supporting equipment and details of cables used with the EUT.

Manufacturer	Equipment Description (Including Brand Name)	Model	Calibration Date	Calibration Due Date
N/A	N/A	N/A	N/A	N/A

Block Configuration Diagram for AC Line Conducted Emissions

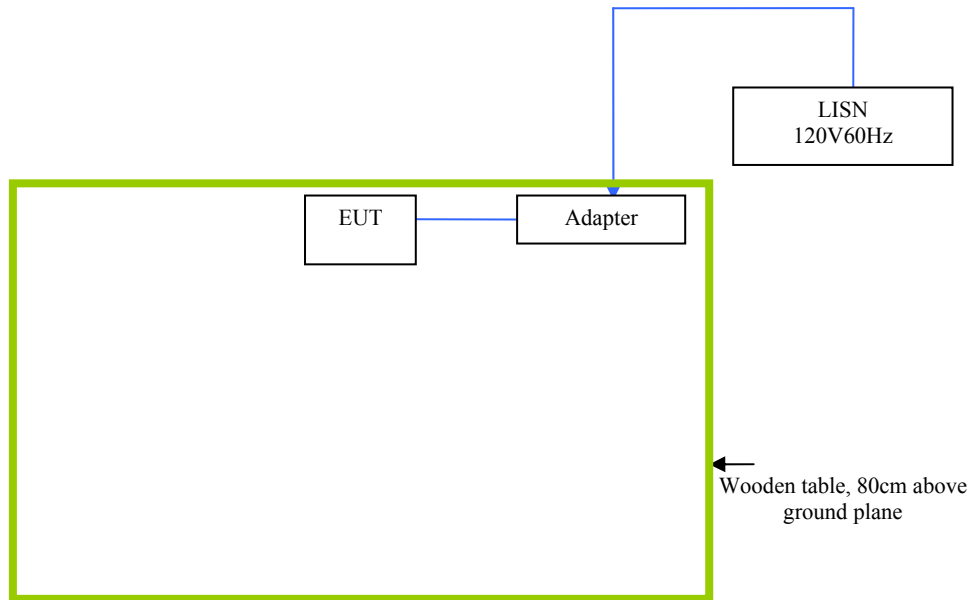

Block Configuration Diagram for Radiated Emissions

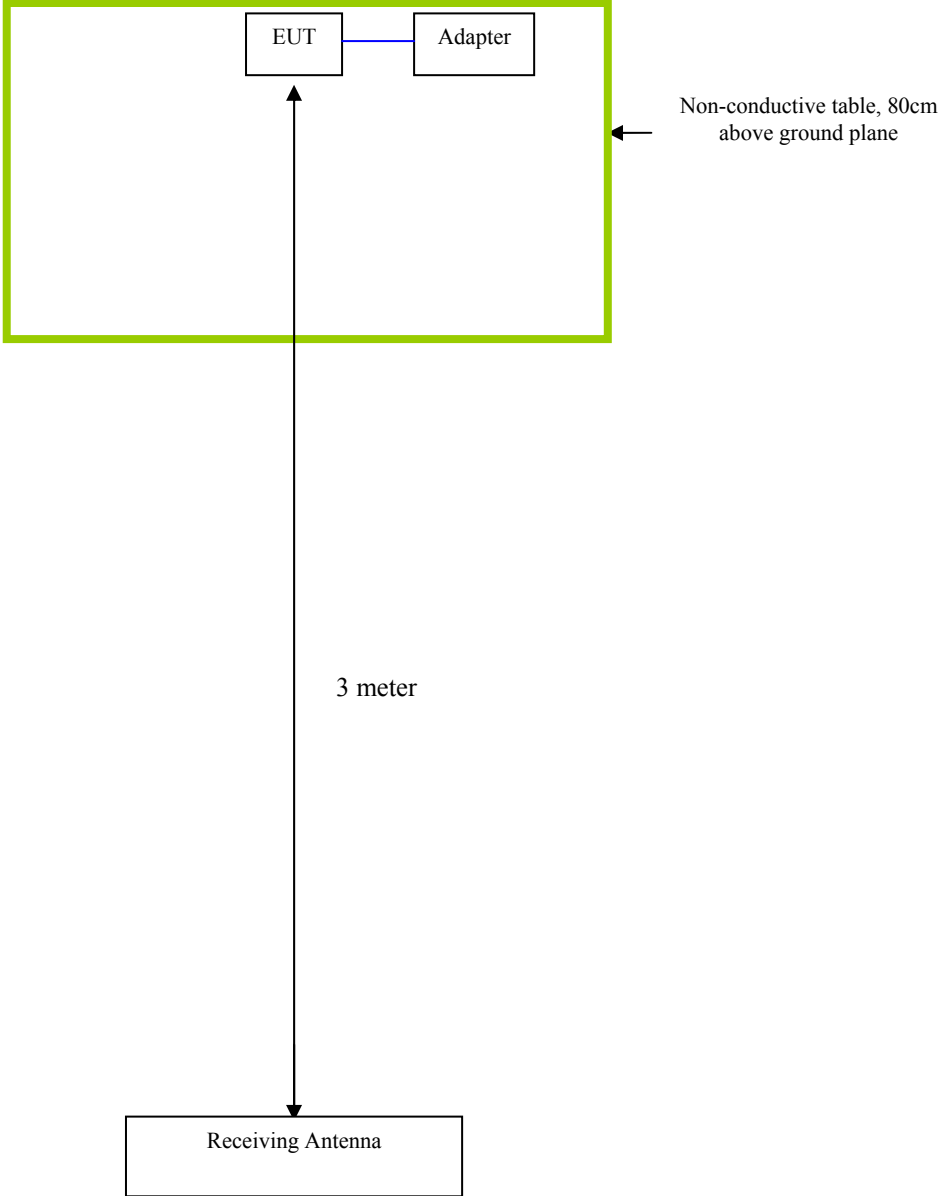

Annex C.ii. EUT OPERATING CONDITIONS

The following is the description of how the EUT is exercised during testing.

Test	Description Of Operation
Emissions Testing	The EUT was continuously transmitting to stimulate the worst case.

Annex D. USER MANUAL / BLOCK DIAGRAM / SCHEMATICS / PART LIST

Please see attachment

Annex E. DECLARATION OF SIMILARITY

N/A