

FCC SAR TEST REPORT

No. 130415

for

B mobile HK Limited

Bmobile

Model Name: QS304

Trade Mark: Bmobile

FCC ID: ZSW-QS304

Issued Date: 2013-04-27

Note:

The test results in this test report relate only to the devices specified in this report. This report shall not be reproduced except in full without the written approval of GCCT.

Test Laboratory:

GCCT, Guangdong Telecommunications Terminal Products Quality Supervision and Testing Center
Technology Road, High-tech Zone, He Yuan City, Guang Dong Province, PR China 517001

Tel:+86(0)762-3607139, Fax:+86(0)762-3603336 Email: ncctmail@126.com. www.ncct.org.cn

TABLE OF CONTENTS

1. General Information	4
1.1 Testing Laboratory	4
1.2 Application Information	4
1.3 Manufacturer Information	4
1.4 EUT Information	5
2. EUT Operational Conditions During Test	6
2.1 General Description of Test Procedures	6
2.2 GSM Test Configuration	6
3. SAR Measurements System Configuration	7
3.1 Measurement System Diagram	7
3.2 System Components	8
3.3 Equivalent Tissues	11
4. Evaluation Procedures	12
4.1 Data Evaluation	12
4.2 SAR Evaluation Procedures	13
4.3 Spatial Peak SAR Evaluation	14
5. Test Laboratory Environment	16
6. Conducted Output Power Measurement	17
7. SAR Measurement Results	18
7.1 Liquid Measurement Results	18
7.2 System Performance Check	19
7.3 Measurement Results	21
8. Measurement Uncertainty	25
9. EUT Photo	26
10. Equipment List & Calibration Status	28
11. Attachments	29
ANNEXE 1 System Performance Check Plots	30
ANNEXE 2 SAR Test Plots	34
ANNEXE 3 EUT Test Positions	62
ANNEXE 4 Probe calibration report	65
ANNEXE 5 Dipole calibration report	77
ANNEXE 6 DAE calibration report	94

GENERAL SUMMARY

Product Name	Bmobile
Model Name	QS304
Applicant	B mobile HK Limited
Manufacturer	PROFIT HARVEST CORPORATION LIMITED
Test laboratory	GCCT, Guangdong Telecommunications Terminal Products Quality Supervision and Testing Center
Reference Standards	<p>OET Bulletin 65 (Edition 97-01) and Supplement C (Edition 01-01): Additional Information for Evaluating Compliance of Mobile and Portable Devices with FCC Limits</p> <p>IEEE Std C95.1, 1999: IEEE Standard for Safety Levels with Respect to Human Exposure to Radio Frequency Electromagnetic Fields, 3 kHz to 300 GHz</p> <p>IEEE 1528-2003: Recommended Practice for Determining the Peak Spatial-Average Specific Absorption Rate (SAR) in the Human Body Due to Wireless Communications Devices: Experimental Techniques</p> <p>FCC KDB 447498 D01 v05: Mobile and Portable Devices RF Exposure Procedures and Equipment Authorization Policies</p> <p>FCC KDB 865664 D01 v01: SAR Measurement Requirements for 100 MHz to 6 GHz</p> <p>IEC 62209-1: 2006: Human exposure to radio frequency fields from hand-held and body-mounted wireless communication devices – Human models, instrumentation, and procedures, Part 1: Procedure to determine the specific absorption rate (SAR) for hand-held devices used in close proximity to the ear (frequency range of 300 MHz to 3 GHz)</p> <p>IEC 62209-2: 2010: Human exposure to radio frequency fields from handheld and body-mounted wireless communication devices - Human models, instrumentation, and procedures, Part 2: Procedure to determine the specific absorption rate (SAR) for mobile wireless communication devices used in close proximity to the human body (frequency range of 30 MHz to 6 GHz)</p>
Test Conclusion	<p>This portable wireless equipment has been measured in all cases requested by the relevant standards. Test results in Chapter 7 of this test report are below limits specified in the relevant standards.</p> <p>General Judgment: Pass</p> <p style="text-align: right;">Date of issue:2013.04.27</p>
Comment:	The test results in this report apply only to the tested sample of the stated device/equipment.

Approved by:

luo jian

Deputy Manager

Reviewed by:

Dong Xiaobo

Deputy Manager

Tested by:

Li Binliang

Test Engineer

1. General Information

1.1 Testing Laboratory

Company	GCCT, Guangdong Telecommunications Terminal Products Quality Supervision and Testing Center
Address	Technology Road, High-tech Zone, He Yuan City, Guang Dong Province, PR China
Country	P. R. China
Contact	Dong Xiaobo
Telephone	+86-762-3607139
Fax	+86-762-3603336
E-mail	dongxiaobo126@126.com
Website	http://www.ncct.org.cn

1.2 Application Information

Company	B mobile HK Limited
Address	Ground floor, 144 Un Chau Street, Sham Shui Po, Hong Kong
Contact	/
Email	/
Telephone	/
Fax	/

1.3 Manufacturer Information

Company	FORTUNE SHIP TECHNOLOGY(HK) LIMITED
Address	ROOM A 11/F, HO LEE COMMERCIAL BUILDING, 38-44 D'AGUILAR STREET, CENTRAL, HONG KONG
Contact	/
Email	/
Telephone	/
Fax	/

1.4 EUT Information

Product Name	Bmobile		
Exposure Category	Uncontrolled Environment / General Population		
Model Number	QS304		
Device Type	Portable Device		
Hardware version	X321-MB-V2.1A		
Software version	/		
Supporting modes	GSM850 (tested) PCS1900 (tested) Bluetooth		
GPRS Class	Class 12		
Max. SAR (1g)	Mode	1g SAR(W/Kg)	
		Head	Body-worn
	GSM850	0.760	0.757
GSM1900	0.433	0.438	
Antenna Type	Internal Antenna		
Accessories	Li-Ion Battery: Model: Bmobile Voltage:3.7V Capacity:800mAh Charger: Earphone		
Comment	The above EUT's information was declared by manufacture.		

2. EUT Operational Conditions During Test

2.1 General Description of Test Procedures

A communication link is set up with a System Simulator (SS) by air link, and a call is established. The Absolute Radio Frequency Channel Number (ARFCN) is allocated to 128, 190 and 251 in the case of GSM850, allocated to 512, 661 and 810 in the case of PCS1900. The EUT is commanded to operate at maximum transmitting power by MT8820C.

When we test, the EUT battery must be fully charged and checked periodically during the test to ascertain uniform power output. The antenna connected to the output of the base station simulator shall be placed at least 50 cm away from the EUT. The signal transmitted by the simulator to the antenna feeding point shall be lower than the output power level of the EUT by at least 30 dB.

2.2 GSM Test Configuration

For the SAR tests for GSM850 and PCS1900, a communication link is set up with a System Simulator (SS) by air link. Using MT8820C the power lever is set to “5” of GSM850, set to “0” of PCS1900. The EUT is commanded to operate at maximum transmitting power. The GPRS class is 12 for this EUT. It has at most 4 timeslots in uplink and at most 4 timeslots in downlink, the maximum total timeslots is 5.

3. SAR Measurements System Configuration

These measurements were performed with the automated near-field scanning system DASY5 from SPEAG. The system is based on a high precision robot, which positions the probes with a positional repeatability of better than ± 0.02 mm. Special E-field probes have been developed for measurements close to material discontinuity, the sensors of which are directly loaded with a Schottky diode and connected via highly resistive lines to the data acquisition unit. The SAR measurements were conducted with the dosimetric probe manufactured by SPEAG, designed in the classical triangular configuration and optimized for dosimetric evaluation. The probe has been calibrated according to the procedure described in with accuracy of better than $\pm 10\%$. The spherical isotropy was evaluated and found to be better than ± 0.3 dB. The phantom used was the SAM Twin Phantom and ELI4 Phantom as described in IEC 62209-1, FCC OET 065 supplement C, IEEE1528 and EN 62209-1.

3.1 Measurement System Diagram

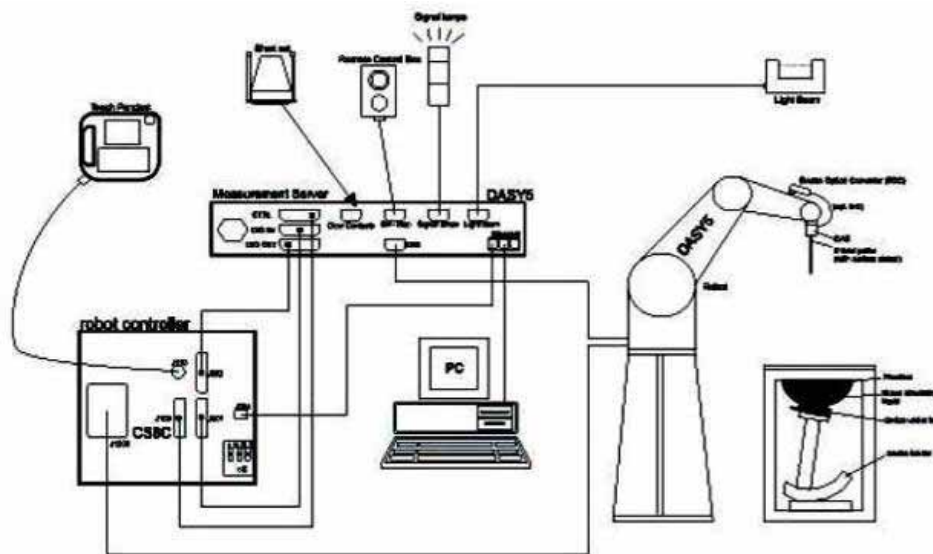

Figure 1 System Diagram

The DASY5 system consists of the following items:

1. A standard high precision 6-axis robot (TX90XL) with Staubli CS8c robot controllers.
2. DASY5 Measurement Server.
3. Data Acquisition Electronics.
4. A dosimetric probe, i.e., an isotropic E-field probe optimized and calibrated for usage in tissue simulating liquid. The probe is equipped with an optical surface detector system.
5. Light Beam Unit.

6. The SAM phantom enabling testing left-hand right-hand and the ELI4 phantom for body usage.
7. The Position device for handheld EUT.
8. Tissue simulating liquid mixed according to the given recipes.
9. System validation dipoles to validate the proper functioning of the system.
10. A computer operating Windows XP.

3.2 System Components

The mobile phone under test operating at the maximum power level is placed in the phone holder, under the phantom, which is filled with head simulating liquid. The E-Field probe measures the electric field inside the phantom. The DASY5 software computes the results to give a SAR value in a 1g or 10 g mass.

3.2.1 TX90XL

The TX90XL robot has six axes. The six axes are controlled by the Staubli CS8c robot controllers. It offers the features important for our application:

- High precision (repeatability 0.02mm)
- High reliability (industrial design)
- Low maintenance costs (virtually maintenance free due to direct drive gears; no belt drives)
- Jerk-free straight movements (brushless synchrony motors; no stepper motors)
- Low ELF

3.2.2 DASY5 Measurement Server

The DASY5 measurement server is based on a PC/104 CPU board with a 400MHz Intel ULV Celeron, 128MB chip disk and 128MB RAM. The necessary circuits for communication with either the DAE4 electronics box as well as the 16 bit AD converter system for optical detection and digital I/O interface are contained on the DASY5 I/O board, which is directly connected to the PC/104 bus of the CPU board.



Figure 2 TX90XL



Figure 3 Measurement Server

3.2.3 Probe

For the measurements the specific dosimetric E-Field Probe ES3DV3 and EX3DV4 with following specifications is used.

Frequency: 10 MHz to 3 GHz; Linearity: ± 0.2 dB

Directivity: ± 0.3 dB in HSL (rotation around probe axis)

± 0.5 dB in tissue material (rotation normal to probe axis)

Dynamic Range: 10 μ W/g to > 100 mW/g; Linearity: ± 0.2 dB

Tip Diameter: 5 mm; Distance between probe tip and sensor center: 2.5 mm

Probe linearity: ± 0.3 dB

Calibration range: 835 to 2500 MHz for head & body simulating liquid

3.2.4 Device holder

The DASY device holder is designed to cope with the different positions given in the standard.

It has two scales for device rotation (with respect to the body axis) and device inclination (with respect to the line between the ear reference points). The rotation centers for both scales are the ear reference point (ERP). Thus the device needs no repositioning when changing the angles. The DASY device holder is constructed of low-loss POM material having the following dielectric parameters: relative permittivity =3 and loss tangent =0.02. The amount of dielectric material has been reduced in the closest vicinity of the device, since measurements have suggested that the influence of the clamp on the test results could thus be lowered.



Figure 4 Probe



Figure 5 Device Holder

3.2.5 Phantom

The SAM Twin Phantom and the ELI4 Phantom are constructed of a fiberglass shell integrated in a wooden table. The shape of the shell is in compliance with the specification set in IEEE P1528 and CENELEC EN62209-1. The SAM Twin phantom

enables the dosimetric evaluation of left and right hand phone usage and the ELI4 phantom enables the dosimetric evaluation of body mounted usage. A cover prevents the evaporation of the liquid. Reference markings on the Phantom allow the complete setup of all predefined phantom positions and measurement grids by manually teaching three points in the robot.

Shell thickness: 2 mm +/-0.2 mm

Filling Volume: Approx. 25 liters

Dimensions (H x L x W): 850 x 1000 x 500 mm

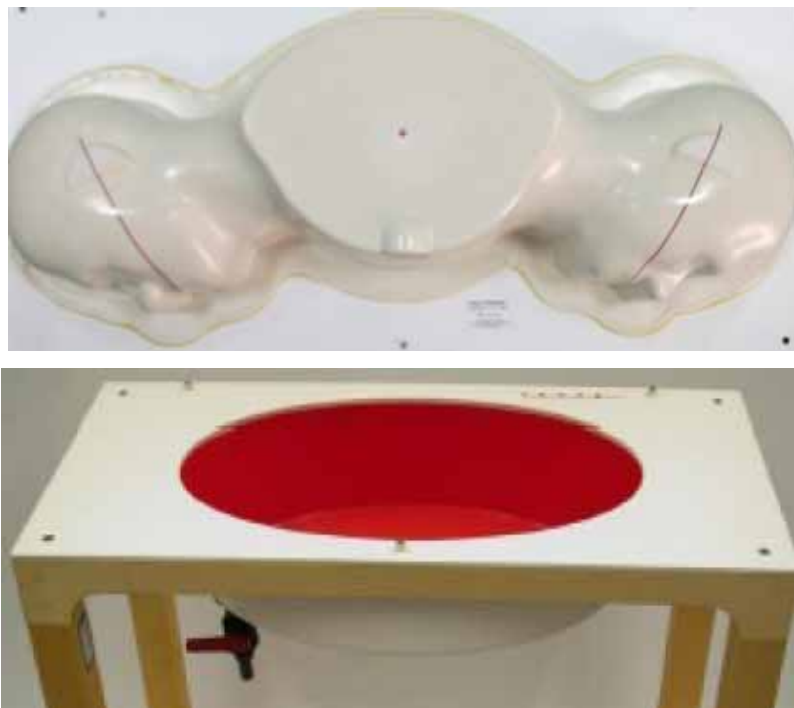

Figure 6 SAM Twin Phantom and ELI Phantom

3.2.6 Data Acquisition Electronics

DAE4 consist of a highly sensitive electrometer-grade preamplifier with auto-zeroing, a channel and gain-switching multiplexer, a fast 16 bit AD-converter and a command decoder with a control logic unit. Transmission to the measurement server is accomplished through an optical downlink for data and status information, as well as an optical uplink for commands and the clock. The mechanical probe mounting device includes two different sensor systems for frontal and sideways probe contacts. They are used for mechanical surface detection and probe collision detection.

Input impedance: 200M Ω m, symmetrical and floating.

Common mode rejection: > 80 dB.

3.2.7 Validation dipoles

SPEAG has a full range of dipoles corresponding to the frequencies defines by the standards: 835, 900, 1800, 1900, 2000, 2450MHz

Maximum input Power: 100W

Connectors: SMA

Dimensions: (depends on the dipole frequency)



Figure 7 DAE4



Figure 8 Validation Dipoles

3.3 Equivalent Tissues

The relative permittivity and conductivity of the tissue material should be within $\pm 5\%$ of the values given in the table below recommended by the FCC OET 65 supplement C.

Target Frequency	Head		Body	
(MHz)	ϵ_r	σ (S/m)	ϵ_r	σ (S/m)
150	52.3	0.76	61.9	0.80
300	45.3	0.87	58.2	0.92
450	43.5	0.87	56.7	0.94
835	41.5	0.90	55.2	0.97
900	41.5	0.97	55.0	1.05
915	41.5	0.98	55.0	1.06
1450	40.5	1.20	54.0	1.30
1610	40.3	1.29	53.8	1.40
1800-2000	40.0	1.40	53.3	1.52
2450	39.2	1.80	52.7	1.95
3000	38.5	2.40	52.0	2.73
5800	35.3	5.27	48.2	6.00

(ϵ_r = relative permittivity, σ = conductivity and $\rho = 1000 \text{ kg/m}^3$)

4. Evaluation Procedures

4.1 Data Evaluation

The DASY5 software automatically executes the following procedures to calculate the field units from the microvolt readings at the probe connector. The parameters used in the evaluation are stored in the configuration modules of the software:

Probe parameters: - Sensitivity $Norm_i$, ai_0 , ai_1 , ai_2
 - Conversion factor $ConvFi$
 - Diode compression point $dcpi$

Device parameters: - Frequency f
 - Crest factor cf

Media parameters: - Conductivity σ
 - Density ρ

These parameters must be set correctly in the software. They can be found in the component documents or be imported into the software from the configuration files issued for the DASY5 components. In the scan visualization and export modes, the parameters stored in the corresponding document files are used.

The first step of the evaluation is a linearization of the filtered input signal to account for the compression characteristics of the detector diode. The compensation depends on the input signal, the diode type and the DC-transmission factor from the diode to the evaluation electronics. If the exciting field is pulsed, the crest factor of the signal must be known to correctly compensate for peak power. The formula for each channel can be given as:

$$V_i = U_i + U_i^2 \cdot \frac{cf}{dcpi}$$

with V_i = Compensated signal of channel i ($i = x, y, z$)

U_i = Input signal of channel i ($i = x, y, z$)

cf = Crest factor of exciting field (DASY5 parameter)

$dcpi$ = Diode compression point (DASY5 parameter)

From the compensated input signals the primary field data for each channel can be evaluated:

$$\text{E-field probes: } E_i = \sqrt{\frac{V_i}{Norm_i \cdot ConvF}}$$

$$\text{H-field probes: } H_i = \sqrt{V_i} \cdot \frac{a_{i0} + a_{i1}f + a_{i2}f^2}{f}$$

With V_i = Compensated signal of channel i ($i = x, y, z$)

$Norm_i$ = Sensor sensitivity of channel i ($i = x, y, z$)

$ConvF$ = Sensitivity enhancement in solution

a_{ij} = Sensor sensitivity factors for H-field probes

f = Carrier frequency (GHz)

E_i = Electric field strength of channel i in V/m

H_i = Magnetic field strength of channel i in A/m

The RSS value of the field components give the total field strength:

$$E_{tot} = \sqrt{E_x^2 + E_y^2 + E_z^2}$$

The primary field data are used to calculate the derived field units.

$$SAR = E_{tot}^2 \cdot \frac{\sigma}{\rho \cdot 1000}$$

With SAR = local specific absorption rate in mW/g

E_{tot} = total field strength in V/m

σ = conductivity in [mho/m] or [Siemens/m]

ρ = equivalent tissue density in g/cm³

Note that the density is normally set to 1 (or 1.06), to account for actual brain density rather than the density of the simulation liquid. The power flow density is calculated assuming the excitation field as a free space field.

$$P_{pwe} = \frac{E_{tot}^2}{3770} \quad \text{Or} \quad P_{pwe} = H_{tot}^2 \cdot 37.7$$

With P_{pwe} = Equivalent power density of a plane wave in mW/cm²

E_{tot} = total electric field strength in V/m

H_{tot} = total magnetic field strength in A/m

4.2 SAR Evaluation Procedures

The procedure for assessing the peak spatial-average SAR value consists of the following steps:

• Power Reference Measurement

The reference and drift jobs are useful jobs for monitoring the power drift of the device under test in the batch process. Both jobs measure the field at a specified reference position, at a selectable distance from the phantom surface. The reference position can be either the selected section's grid reference point or a

user point in this section. The reference job projects the selected point onto the phantom surface, orients the probe perpendicularly to the surface, and approaches the surface using the selected detection method.

- **Area Scan**

The area scan is used as a fast scan in two dimensions to find the area of high field values, before doing a finer measurement around the hot spot. The sophisticated interpolation routines implemented in DASY5 software can find the maximum locations even in relatively coarse grids. The scan area is defined by an editable grid. This grid is anchored at the grid reference point of the selected section in the phantom. When the area scan's property sheet is brought-up, grid was at to 15 mm by 15 mm and can be edited by a user.

- **Zoom Scan**

Zoom scans are used to assess the peak spatial SAR values within a cubic averaging volume containing 1 g and 10 g of simulated tissue. The default zoom scan measures 7 x 7 x 7 points within a cube whose base faces are centered around the maximum found in a preceding area scan job within the same procedure. If the preceding Area Scan job indicates more than one maximum, the number of Zoom Scans has to be enlarged accordingly (The default number inserted is 1).

- **Power Drift Measurement**

The drift job measures the field at the same location as the most recent reference job within the same procedure, and with the same settings. The drift measurement gives the field difference in dB from the reading conducted within the last reference measurement. Several drift measurements are possible for one reference measurement. This allows a user to monitor the power drift of the device under test within a batch process. In the properties of the Drift job, the user can specify a limit for the drift and have DASY5 software stop the measurements if this limit is exceeded.

4.3 Spatial Peak SAR Evaluation

The procedure for spatial peak SAR evaluation has been implemented according to the IEC62209-1 standard. It can be conducted for 1 g and 10 g. The DASY5 system allows evaluations that combine measured data and robot positions, such as:

- maximum search
- extrapolation

boundary correction

Peak search for averaged SAR

During a maximum search, global and local maximum searches are automatically performed in 2-D after each Area Scan measurement with at least 6 measurement points. It is based on the evaluation of the local SAR gradient calculated by the Quadratic Shepard's method. The algorithm will find the global maximum and all local maxima within -2 dB of the global maxima for all SAR distributions.

Extrapolation

Extrapolation routines are used to obtain SAR values between the lowest measurement points and the inner phantom surface. The extrapolation distance is determined by the surface detection distance and the probe sensor offset. Several measurements at different distances are necessary for the extrapolation.

Extrapolation routines require at least 10 measurement points in 3-D space. They are used in the Cube Scan to obtain SAR values between the lowest measurement points and the inner phantom surface. The routine uses the modified Quadratic Shepard's method for extrapolation. For a grid using 7x7x7 measurement points with 5mm resolution amounting to 343 measurement points, the uncertainty of the extrapolation routines is less than 1% for 1 g and 10 g cubes.

Boundary effect

For measurements in the immediate vicinity of a phantom surface, the field coupling effects between the probe and the boundary influence the probe characteristics. Boundary effect errors of different dosimetric probe types have been analyzed by measurements and using a numerical probe model. As expected, both methods showed an enhanced sensitivity in the immediate vicinity of the boundary. The effect strongly depends on the probe dimensions and disappears with increasing distance from the boundary. The sensitivity can be approximately given as:

$$S \approx S_o + S_b \exp\left(-\frac{z}{a}\right) \cos\left(\pi \frac{z}{\lambda}\right)$$

Since the decay of the boundary effect dominates for small probes ($a \ll \lambda$), the cos-term can be omitted. Factors S_b (parameter Alpha in the DASY5 software) and a (parameter Delta in the DASY5 software) are assessed during probe calibration and used for numerical compensation of the boundary effect. Several simulations and measurements have confirmed that the compensation is valid for different field and

boundary configurations.

This simple compensation procedure can largely reduce the probe uncertainty near boundaries. It works well as long as:

- the boundary curvature is small

- the probe axis is angled less than 30° to the boundary normal

- the distance between probe and boundary is larger than 25% of the probe diameter

- the probe is symmetric (all sensors have the same offset from the probe tip)

Since all of these requirements are fulfilled in a DASY5 system, the correction of the probe boundary effect in the vicinity of the phantom surface is performed in a fully automated manner via the measurement data extraction during post processing.

5. Test Laboratory Environment

Temperature	Min. = 20°C, Max. = 25 °C
Relative humidity	Min. = 30%, Max. = 70%
Ground system resistance	< 0.5 Ω
Ambient noise is checked and found very low and in compliance with requirement of standards. Reflection of surrounding objects is minimized and in compliance with requirement of standards.	

6. Conducted Output Power Measurement

The following procedures had been used to prepare the EUT for the SAR test. To setup the desire channel frequency and the maximum output power. A Radio Communication Tester MT8820C was used to program the EUT.

GSM 850		Power (dBm)			Average power (dBm)			
		Channel	Channel	Channel				
		128	190	251	Channel	Channel	Channel	
		128	190	251				
GSM		31.55	31.58	31.59				
GPRS	1TXslot	31.42	31.49	31.47	-9.03	22.39	22.46	22.44
	2TXslots	30.94	30.92	30.96	-6.02	24.92	24.90	24.94
	3TXslots	29.39	29.39	29.43	-4.26	25.13	25.13	25.17
	4TXslots	28.39	28.38	28.44	-3.01	25.38	25.37	25.43
GSM 1900		Power (dBm)			Average power (dBm)			
		Channel	Channel	Channel				
		512	661	810	Channel	Channel	Channel	
		512	661	810				
GSM		29.40	28.82	28.34				
GPRS	1TXslot	28.89	28.36	27.87	-9.03	19.86	19.33	18.84
	2TXslots	27.15	26.61	26.16	-6.02	21.13	20.59	20.14
	3TXslots	27.08	27.00	26.59	-4.26	22.82	22.74	22.33
	4TXslots	25.94	25.44	24.95	-3.01	22.93	22.43	21.94

Note:

1) Division Factors

To average the power, the division factor is as follows:

1TX-slot = 1 transmit time slot out of 8 time slots

=>Conducted power divided by (8/1) => -9.03 dB

2 TX-slots = 2 transmit time slots out of 8 time slots

=> Conducted power divided by (8/2) => -6.02 dB

3TX-slots = 3 transmit time slots out of 8 time slots

=> Conducted power divided by (8/3) => -4.26 dB

4 TX-slots = 4 transmit time slots out of 8 time slots

=> Conducted power divided by (8/4) => -3.01 dB

2) Average power

The maximum power are marks in bold. According to the conducted power as above, the 850MHz body measurements are performed with 4Txslots for GPRS, and the 1900MHz body measurements are performed with 4Txslots and 3Txslots for GPRS.

7. SAR Measurement Results

7.1 Liquid Measurement Results

The simulating liquids should be checked at the beginning of a series of SAR measurements to determine if the dielectric parameters are within the tolerances of the specified target values.

Freq. [MHz]	Date	Liquid Type	Liquid Temp. [°C]	Ambient Temp. [°C]	Relative Humidity	Para.	Target Value	Measured Value	Deviation [%]	Limit [%]
835	Apr 26, 2013	Head	21.5	21	57%	ϵ_r	41.5	40.43	-2.58	± 5
						σ	0.90	0.86	-4.44	± 5
835	Apr 26, 2013	Body	21.5	21	57%	ϵ_r	55.2	53.73	-2.66	± 5
						σ	0.97	0.94	-3.09	± 5
1900	Apr 27, 2013	Head	21.5	21	57%	ϵ_r	40	39.75	-0.63	± 5
						σ	1.40	1.45	3.57	± 5
1900	Apr 27, 2013	Body	21.5	21	57%	ϵ_r	53.3	50.72	-4.84	± 5
						σ	1.52	1.58	3.95	± 5

7.2 System Performance Check

System Performance Check Measurement conditions

- The measurements were performed in the flat section of the SAM twin phantom filled with head and body simulating liquid of the following parameters.
- The DASY5 system with an E-field probe was used for the measurements.
- The dipole was mounted on the small tripod so that the dipole feed point was positioned below the center marking of the flat phantom section and the dipole was oriented parallel to the body axis (the long side of the phantom). The standard measuring distance was 15 mm (below 1 GHz) and 10 mm (above 1 GHz) from dipole center to the simulating liquid surface.
- The coarse grid with a grid spacing of 10mm was aligned with the dipole.
- Special 5x5x7 fine cube was chosen for cube integration (dx= 8 mm, dy= 8 mm, dz= 5 mm).
- Distance between probe sensors and phantom surface was set to 2.5 mm.

The depth of Liquid must above 15cm



System Performance Check Results

Freq. [MHz]	Date	Liquid Type	Liquid Temp. [°C]	Amb. Temp. [°C]	Input Power (mW)	Measured SAR_1g (W/Kg)	250mW Target SAR_1g (W/Kg)	Dev. [%]	Limit [%]
900	Apr 26, 2013	Head	21.5	21	250	2.58	2.68	-3.73	±10
	Apr 26, 2013	Body	21.5	21	250	2.72	2.81	-3.20	±10
1900	Apr 27, 2013	Head	21.5	21	250	9.42	9.89	-4.75	±10
	Apr 27, 2013	Body	21.5	21	250	10.1	10.3	-1.94	±10

7.3 Measurement Results

Band	Test configuration		Mode	Ch#.	Freq. [MHz]	Power (dBm)		1g SAR (W/Kg)		Power Drift (dB)
						Tune-up limit	Measured	Measured	Scaled	
GSM 850	Head	Left Cheek	voice	251	848.8	32	31.59	0.691	0.760	-0.14
	Head	Left Cheek	voice	190	836.6	32	31.58	0.523	0.576	-0.03
	Head	Left Cheek	voice	128	824.2	32	31.55	0.413	0.458	0.02
	Head	Left Tilted	voice	251	848.8	32	31.59	0.488	0.536	0.01
	Head	Right Cheek	voice	251	848.8	32	31.59	0.673	0.740	0.11
	Head	Right Tilted	voice	251	848.8	32	31.59	0.477	0.524	0.07
	Body	Back (Head-set)	voice	251	848.8	32	31.59	0.398	0.438	-0.04
	Body	Front (Head-set)	voice	251	848.8	32	31.59	0.200	0.220	0.07
	Body	Back	GPRS 4 slots	251	848.8	29	28.44	0.665	0.757	0.02
	Body	Back	GPRS 4 slots	190	836.6	29	28.38	0.481	0.555	0.01
	Body	Back	GPRS 4 slots	128	824.2	29	28.39	0.363	0.418	-0.00
	Body	Front	GPRS 4 slots	251	848.8	29	28.44	0.341	0.388	-0.03
GSM 1900	Head	Left Cheek	voice	512	1850.2	30	29.40	0.223	0.256	0.01
	Head	Left Tilted	voice	512	1850.2	30	29.40	0.265	0.304	-0.02
	Head	Right Cheek	voice	512	1850.2	30	29.40	0.297	0.341	0.18
	Head	Right Tilted	voice	810	1909.8	30	28.34	0.295	0.433	-0.02
	Head	Right Tilted	voice	661	1880	30	28.82	0.291	0.382	0.01
	Head	Right Tilted	voice	512	1850.2	30	29.40	0.298	0.342	0.11
	Body	Back (Head-set)	voice	512	1850.2	30	29.40	0.176	0.202	0.16
	Body	Front (Head-set)	voice	512	1850.2	30	29.40	0.083	0.095	0.19

Band	Test configuration		Mode	Ch#.	Freq. [MHz]	Power (dBm)		1g SAR (W/Kg)		Power Drift (dB)
						Tune-up limit	Measured	Measured	Scaled	
	Body	Back	GPRS 3 slots	810	1909.8	28	26.59	0.316	0.438	0.06
	Body	Back	GPRS 3 slots	661	1880	28	27.00	0.304	0.383	0.07
	Body	Back	GPRS 4 slots	512	1850.2	26	25.94	0.311	0.315	-0.08
	Body	Front	GPRS 4 slots	512	1850.2	26	25.94	0.144	0.146	0.10

Note:

- 1) The body SAR was tested with separation distance 15mm.

SAR consideration for unlicensed transmitters:

The EUT supports Bluetooth function, the output power of Bluetooth and the antenna layout are as follow:

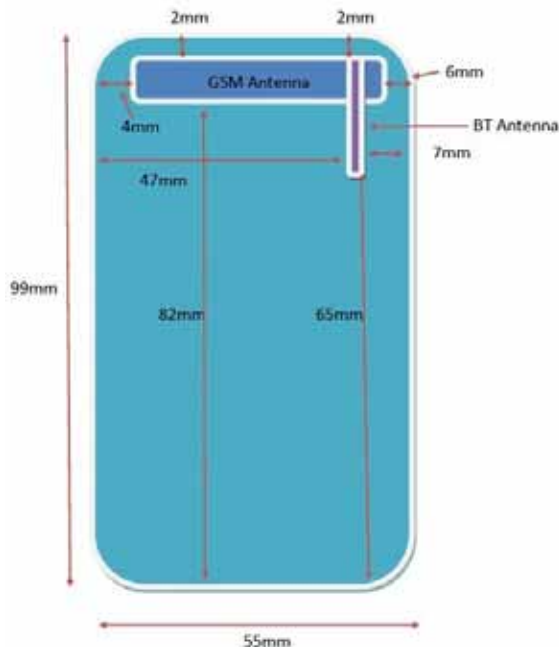

Bluetooth:

	Conducted power (dBm)		
	GFSK	Pi/4DQPSK	8QPSK
Lowest	5.74	4.16	4.18
Middle	5.83	3.83	3.36
Highest	3.86	2.37	2.40
Tune-up limit	6.0	5.0	5.0

According to KDB 447498 section 4.3.1, the 1-g SAR test exclusion thresholds at test separation distances ≤ 50 mm are determined by:

$$[(\text{max. power of channel, including tune-up tolerance, mW}) / (\text{min. test separation distance, mm})] \cdot [\sqrt{f(\text{GHz})}] \leq 3.0.$$

1) Bluetooth maximum tune-up limit power is 6.0dBm=4.0mW.

For the head SAR, use 5mm as the conservative minimum test separation distance,
 $[(\text{max. power of channel, including tune-up tolerance, mW}) / (\text{min. test separation distance, mm})] \cdot [\sqrt{f(\text{GHz})}] = 1.25 \leq 3.0;$

For the body SAR, use 15mm as the conservative minimum test separation distance, $[(\text{max. power of channel, including tune-up tolerance, mW})/(\text{min. test separation distance, mm})] \cdot [\sqrt{f(\text{GHz})}] = 0.42 \leq 3.0$.

So Bluetooth standalone SAR measurements are not required for both head and body.

2) According to KDB 447498 section 4.3.2.2, when standalone SAR test exclusion applies, the standalone SAR must be estimated according to following formula: $(\text{max. power of channel, including tune-up tolerance, mW})/(\text{min. test separation distance, mm}) \cdot [\sqrt{f(\text{GHz})}/x] \text{ W/kg}$ for test separation distances $\leq 50 \text{ mm}$; where $x = 7.5$ for 1-g SAR.

So the estimated Bluetooth head SAR is 0.167 W/kg and the body SAR is 0.056 W/kg.

Simultaneous SAR Consideration:

The simultaneous SAR scenarios are as follow.

No.	Simultaneous Configuration	Max. Standalone SAR (W/kg)				Sum. SAR (W/kg)
		Cellular Head	Cellular Body	BT Head	BT Body	
1	Cellular head + BT head	0.760		0.167		0.927
2	Cellular body + BT body		0.757		0.056	0.813

The maximum evaluation SAR of the simultaneous scenarios is 0.927 W/kg that less than 1.6 W/kg, so the simultaneous SAR measurement is not required.

8. Measurement Uncertainty

Uncertainty Component	Sec.	Tol (+-%)	Prob. Dist.	Div.	Ci (1g)	Ci (10g)	1g U _i (+-%)	10g U _i (+-%)	V _i
Measurement System									
Probe calibration	E.2.1	6.55	N	1.0	1.0	1.0	6.55	6.55	∞
Axial Isotropy	E.2.2	0.5	R	$\sqrt{3}$	1.0	1.0	0.29	0.29	∞
Hemispherical Isotropy	E.2.2	2.6	R	$\sqrt{3}$	1.0	1.0	1.5	1.5	∞
Boundary effect	E.2.3	0.8	R	$\sqrt{3}$	1.0	1.0	0.46	0.46	∞
Linearity	E.2.4	0.6	R	$\sqrt{3}$	1.0	1.0	0.35	0.35	∞
System detection limits	E.2.5	0.25	R	$\sqrt{3}$	1.0	1.0	0.14	0.14	∞
Readout Electronics	E.2.6	0.35	N	1	1.0	1.0	0.35	0.35	∞
Reponse Time	E.2.7	0	R	$\sqrt{3}$	1.0	1.0	0	0	∞
Integration Time	E.2.8	2.6	R	$\sqrt{3}$	1.0	1.0	1.5	1.5	∞
RF ambient Conditions-Noise	E.6.1	0	R	$\sqrt{3}$	1.0	1.0	0	0	∞
RF ambient Conditions-Reflections	E.6.1	3.0	R	$\sqrt{3}$	1.0	1.0	1.7	1.7	∞
Probe positioner Mechanical Tolerance	E.6.2	1.5	R	$\sqrt{3}$	1.0	1.0	0.87	0.87	∞
Probe positioning with respect to Phantom Shell	E.6.3	2.9	R	$\sqrt{3}$	1.0	1.0	1.67	1.67	∞
Extrapolation, interpolation and integration Algorithms for Max. SAR	E.5	1.0	R	$\sqrt{3}$	1.0	1.0	0.58	0.58	∞
Test sample Related									
Test Sample Positioning	E.4.2	4.6	N	1.0	1.0	1.0	4.6	4.6	N-1
Device Holder Uncertainty	E.4.1	5.2	N	1.0	1.0	1.0	5.2	5.2	N-1
Output Power Variation - SAR drift measurement	6.6.2	5	R	$\sqrt{3}$	1.0	1.0	2.89	2.89	∞
Phantom and Tissue Parameters									
Phantom Uncertainty (Shape and thickness tolerances)	E.3.1	4.0	R	$\sqrt{3}$	1.0	1.0	2.31	2.31	∞
Liquid conductivity - deviation from target value	E.3.2	5.0	R	$\sqrt{3}$	0.64	0.43	1.85	1.24	∞
Liquid conductivity - measurement uncertainty	E.3.3	2.5	N	1.0	0.64	0.43	1.60	1.08	M
Liquid permittivity - deviation from target value	E.3.2	5.0	R	$\sqrt{3}$	0.6	0.49	1.73	1.42	∞
Liquid permittivity - measurement uncertainty	E.3.3	2.5	N	1.0	0.6	0.49	1.5	1.23	M
Combined Standard Uncertainty			RSS				11.3	11.0	
Expanded Uncertainty (95% Confidence interval)			K				23	22	

9. EUT Photo



Mobile Phone



Mobile Phone



Mobile Phone



Mobile Phone

10. Equipment List & Calibration Status

Name of Equipment	Manufacturer	Type/Model	Serial Number	Last Cal. Date	Calibration Due
PC	HP	d7900eC	CZC9312JJ4	N/A	N/A
E-field Probe	SPEAG	ES3DV3	SN 3221	2012-9-27	2013-9-26
DAE	SPEAG	DAE4-SD 000 D04 BJ	SN 893	2012-9-27	2013-9-26
Device Holder	Stäubli	N/A	N/A	N/A	N/A
SAM Phantom	SPEAG	SAM Twin Phantom	TP-1545/TP-1548	N/A	N/A
6 Axis Robot	Stäubli	Robot TX90XL	F09/5B9UA1/A/01	N/A	N/A
Dipole 900MHz	SPEAG	D900V2	1d073	2012-9-28	2013-9-27
Dipole 1900MHz	SPEAG	D1900V2	5d070	2012-10-1	2013-9-30
Wireless Communication Test Set	Anritsu	MT8820C	6201060976	2012-8-27	2013-8-26
Signal Generator	Agilent	5183A	MY49060563	2012-8-27	2013-8-26
Power Meter	Agilent	E4419B	MY45104719	2012-8-27	2013-8-26
Power Sensor	Agilent	N8481H	MY48100148	2012-8-27	2013-8-26
Directional couplers	Agilent	778D	MY48220223	N/A	N/A
Power amplifier	mini-circuits	ZHL-42W	QA0940002	N/A	N/A
Power supply	Topward	3303d	796708	2012-8-27	2013-8-26
Network Analyzer	Agilent	E5071C	MY46108263	2012-8-27	2013-8-26
Liquid Calibration Kit	Agilent	85070E	N/A	N/A	N/A

11. Attachments

Exhibit	Content
1	System Performance Check Plots
2	SAR Test Plots
3	EUT Test Positions
4	Probe calibration report
5	Dipole calibration report
6	DAE calibration report

ANNEXE 1 System Performance Check Plots

Test Laboratory: GCCT

Test Date: Apr.26, 2013

System 900 MHz dipole (Head)

DUT: Dipole 900 MHz D900V2; Type: D900V2; Serial: D900V2

Communication System: CW; Communication System Band: D900 (900.0 MHz);

Frequency: 900 MHz; Communication System PAR: 0 dB

Medium parameters used: $f = 900$ MHz; $\sigma = 0.922$ mho/m; $\epsilon_r = 39.626$; $\rho = 1000$ kg/m³

Phantom section: Flat Section

Measurement Standard: DASY5 (IEEE/IEC/ANSI C63.19-2007)

DASY5 Configuration:

- Probe: ES3DV3 - SN3221; ConvF(6.17, 6.17, 6.17); Calibrated: 9/27/2012;
- Sensor-Surface: 4mm (Mechanical Surface Detection)
- Electronics: DAE4 Sn893; Calibrated: 9/27/2012
- Phantom: SAM_2with CRP v4.0; Type: QD000P40CC; Serial: TP:1548
- Measurement SW: DASY52, Version 52.8 (2); SEMCAD X Version 14.6.6 (6824)

900Head/System/Area Scan (21x161x1): Interpolated grid: dx=1.000 mm, dy=1.000 mm

Reference Value = 56.821 V/m; Power Drift = -0.15 dB

Maximum value of SAR (interpolated) = 2.85 W/kg

900Head/System/Zoom Scan (5x5x7)/Cube 0: Measurement grid: dx=8mm, dy=8mm, dz=5mm

Reference Value = 56.821 V/m; Power Drift = -0.15 dB

Peak SAR (extrapolated) = 3.801 mW/g

SAR(1 g) = 2.58 mW/g; SAR(10 g) = 1.68 mW/g

Maximum value of SAR (measured) = 2.80 W/kg

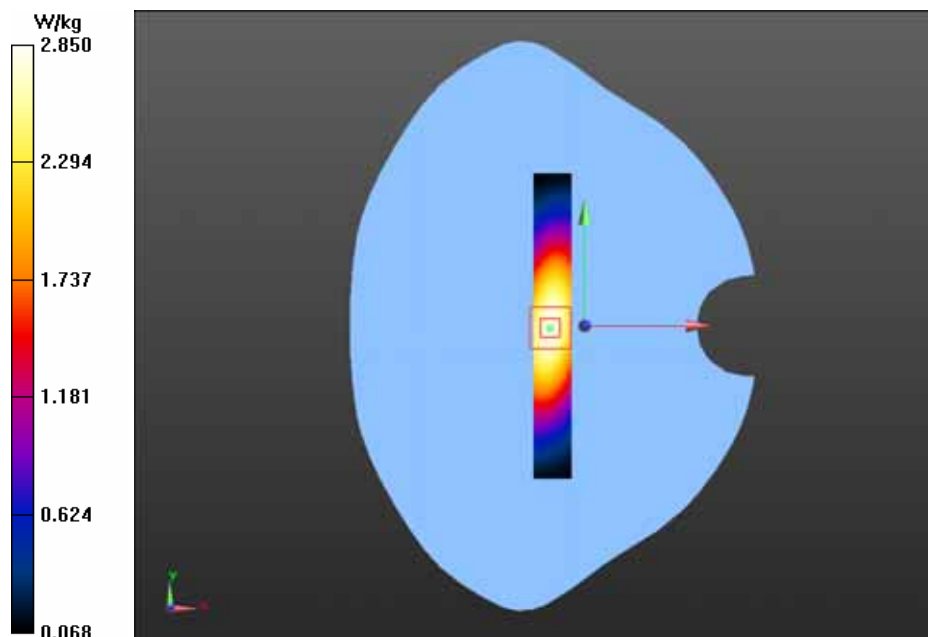

Test Laboratory: GCCT

Test Date: Apr.26, 2013

System 900 MHz dipole (Body)

DUT: Dipole 900 MHz D900V2; Type: D900V2; Serial: D900V2

Communication System: CW; Communication System Band: D900 (900.0 MHz);

Frequency: 900 MHz; Communication System PAR: 0 dB

Medium parameters used: $f = 900$ MHz; $\sigma = 1.002$ mho/m; $\epsilon_r = 53.123$; $\rho = 1000$ kg/m³

Phantom section: Flat Section

Measurement Standard: DASY5 (IEEE/IEC/ANSI C63.19-2007)

DASY5 Configuration:

- Probe: ES3DV3 - SN3221; ConvF(6.17, 6.17, 6.17); Calibrated: 9/27/2012;
- Sensor-Surface: 4mm (Mechanical Surface Detection)
- Electronics: DAE4 Sn893; Calibrated: 9/27/2012
- Phantom: SAM_2with CRP v4.0; Type: QD000P40CC; Serial: TP:1548
- Measurement SW: DASY52, Version 52.8 (2); SEMCAD X Version 14.6.6 (6824)

900Body/System/Area Scan (21x161x1): Interpolated grid: dx=1.000 mm, dy=1.000 mm

Reference Value = 87.272 V/m; Power Drift = -0.16 dB

Maximum value of SAR (interpolated) = 3.07 W/kg

900Body/System/Zoom Scan (5x5x7)/Cube 0: Measurement grid: dx=8mm, dy=8mm, dz=5mm

Reference Value = 87.272 V/m; Power Drift = -0.16 dB

Peak SAR (extrapolated) = 4.048 mW/g

SAR(1 g) = 2.72 mW/g; SAR(10 g) = 1.77 mW/g

Maximum value of SAR (measured) = 2.95 W/kg

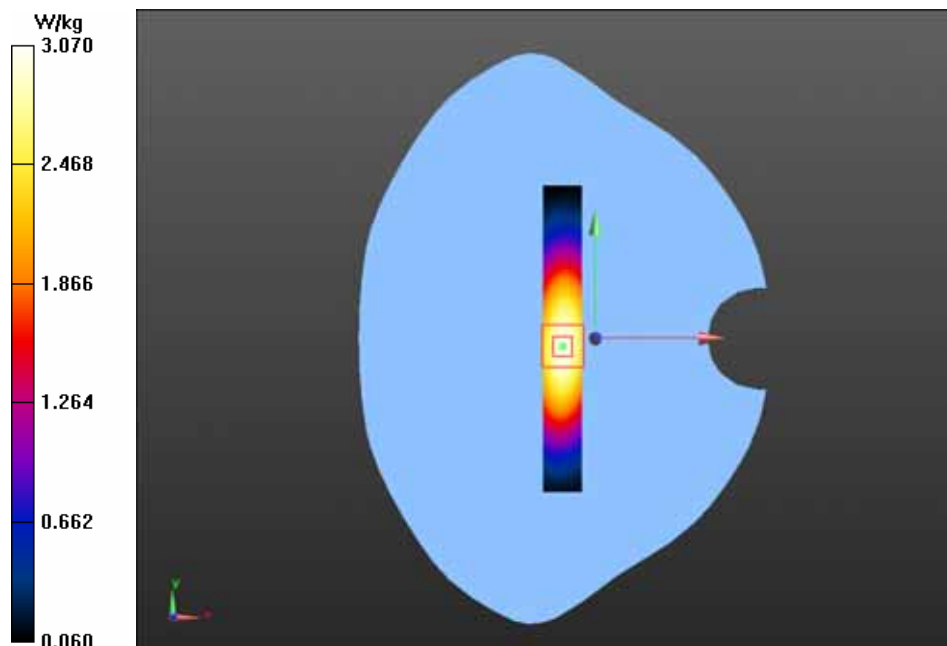

Test Laboratory: GCCT

Test Date: Apr.27, 2013

System 1900 MHz dipole (Head)

DUT: Dipole 1900 MHz D1900V2; Type: D1900V2

Communication System: CW; Communication System Band: D1900 (1900.0 MHz);

Frequency: 1900 MHz; Communication System PAR: 0 dB

Medium parameters used: $f = 1900$ MHz; $\sigma = 1.45$ mho/m; $\epsilon_r = 39.75$; $\rho = 1000$ kg/m³

Phantom section: Flat Section

Measurement Standard: DASY5 (IEEE/IEC/ANSI C63.19-2007)

DASY5 Configuration:

- Probe: ES3DV3 - SN3221; ConvF(5.39, 5.39, 5.39); Calibrated: 9/27/2012;
- Sensor-Surface: 4mm (Mechanical Surface Detection)
- Electronics: DAE4 Sn893; Calibrated: 9/27/2012
- Phantom: SAM_1 with CRP v4.0; Type: QD000P40CC; Serial: TP:1586
- Measurement SW: DASY52, Version 52.8 (2); SEMCAD X Version 14.6.6 (6824)

1900Head/System/Area Scan (21x91x1): Interpolated grid: dx=1.000 mm, dy=1.000 mm

Reference Value = 87.272 V/m; Power Drift = -0.16 dB

Maximum value of SAR (interpolated) = 10.8 W/kg

1900Head/System/Zoom Scan (5x5x7)/Cube 0: Measurement grid: dx=8mm, dy=8mm, dz=5mm

Reference Value = 87.272 V/m; Power Drift = -0.16 dB

Peak SAR (extrapolated) = 17.216 mW/g

SAR(1 g) = 9.42 mW/g; SAR(10 g) = 4.93 mW/g

Maximum value of SAR (measured) = 10.6 W/kg

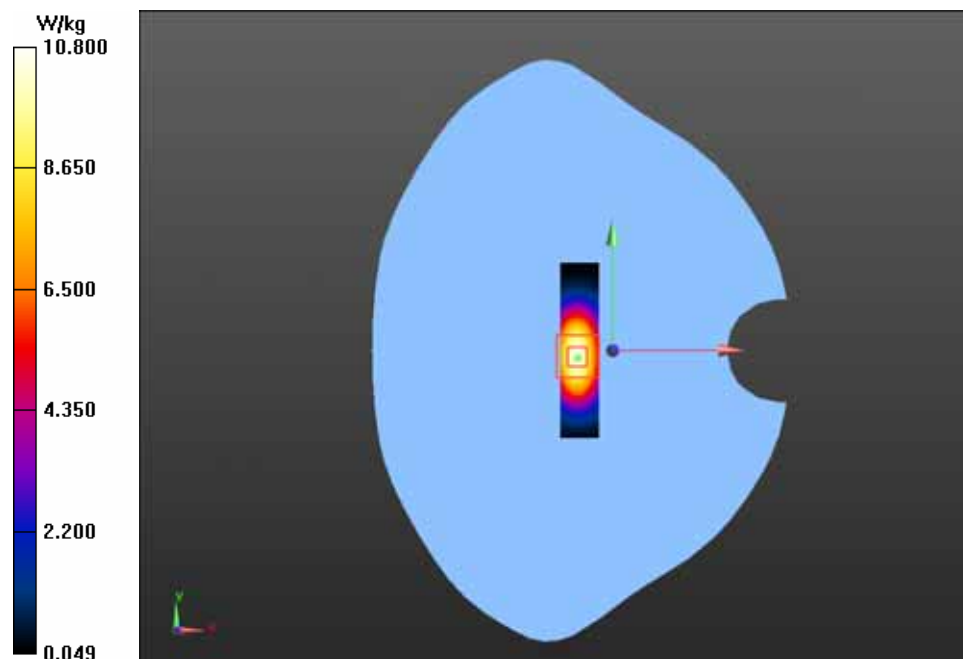

Test Laboratory: GCCT

Test Date: Apr.27, 2013

System 1900 MHz dipole (Body)

DUT: Dipole 1900 MHz D1900V2; Type: D1900V2

Communication System: CW; Communication System Band: D1900 (1900.0 MHz);
Frequency: 1900 MHz; Communication System PAR: 0 dB

Medium parameters used: $f = 1900$ MHz; $\sigma = 1.578$ mho/m; $\epsilon_r = 50.718$; $\rho = 1000$ kg/m³

Phantom section: Flat Section

Measurement Standard: DASY5 (IEEE/IEC/ANSI C63.19-2007)

DASY5 Configuration:

- Probe: ES3DV3 - SN3221; ConvF(4.87, 4.87, 4.87); Calibrated: 9/27/2012;
- Sensor-Surface: 4mm (Mechanical Surface Detection)
- Electronics: DAE4 Sn893; Calibrated: 9/27/2012
- Phantom: SAM_1 with CRP v4.0; Type: QD000P40CC; Serial: TP:1586
- Measurement SW: DASY52, Version 52.8 (2); SEMCAD X Version 14.6.6 (6824)

1900Body/System/Area Scan (21x91x1): Interpolated grid: dx=1.000 mm, dy=1.000 mm

Reference Value = 87.272 V/m; Power Drift = -0.16 dB

Maximum value of SAR (interpolated) = 11.6 W/kg

1900Body/System/Zoom Scan (5x5x7)/Cube 0: Measurement grid: dx=8mm, dy=8mm, dz=5mm

Reference Value = 87.272 V/m; Power Drift = -0.16 dB

Peak SAR (extrapolated) = 17.958 mW/g

SAR(1 g) = 10.1 mW/g; SAR(10 g) = 5.34 mW/g

Maximum value of SAR (measured) = 11.4 W/kg

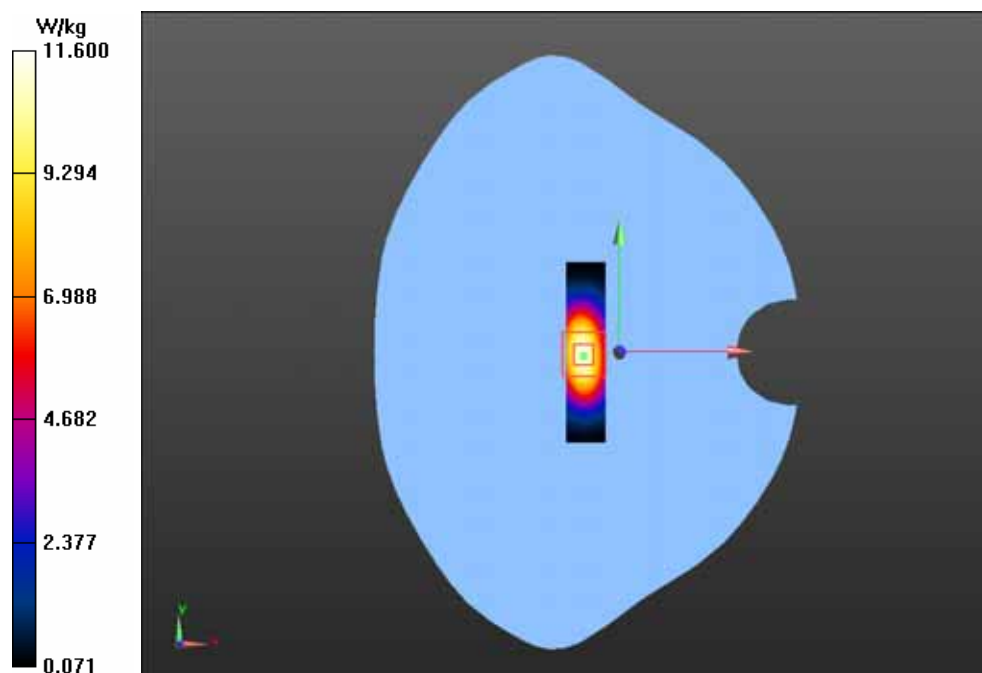

ANNEXE 2 SAR Test Plots

Test Laboratory: GCCT

Test Date: Apr.26, 2013

GSM850 LEFT/CHEEK-High

DUT: Bmobile; Type: QS304

Communication System: Generic GSM; Communication System Band: GSM 850 (824.0 - 849.0 MHz); Frequency: 848.8 MHz; Communication System PAR: 9.191 dB
Medium parameters used (interpolated): $f = 848.8$ MHz; $\sigma = 0.872$ mho/m; $\epsilon_r = 40.245$; $\rho = 1000$ kg/m³

Phantom section: Left Section

Measurement Standard: DASY5 (IEEE/IEC/ANSI C63.19-2007)

DASY5 Configuration:

- Probe: ES3DV3 - SN3221; ConvF(6.2, 6.2, 6.2); Calibrated: 9/27/2012;
- Sensor-Surface: 4mm (Mechanical Surface Detection)
- Electronics: DAE4 Sn893; Calibrated: 9/27/2012
- Phantom: SAM_2with CRP v4.0; Type: QD000P40CC; Serial: TP:1548
- Measurement SW: DASY52, Version 52.8 (2); SEMCAD X Version 14.6.6 (6824)

GSM850 LEFT/CHEEK-High/Area Scan (41x71x1): Interpolated grid: dx=1.500 mm, dy=1.500 mm

Reference Value = 23.767 V/m; Power Drift = -0.14 dB

Maximum value of SAR (interpolated) = 0.734 W/kg

GSM850 LEFT/CHEEK-High/Zoom Scan (5x5x7)/Cube 0: Measurement grid:

dx=8mm, dy=8mm, dz=5mm

Reference Value = 23.767 V/m; Power Drift = -0.14 dB

Peak SAR (extrapolated) = 0.867 mW/g

SAR(1 g) = 0.691 mW/g; SAR(10 g) = 0.501 mW/g

Maximum value of SAR (measured) = 0.729 W/kg

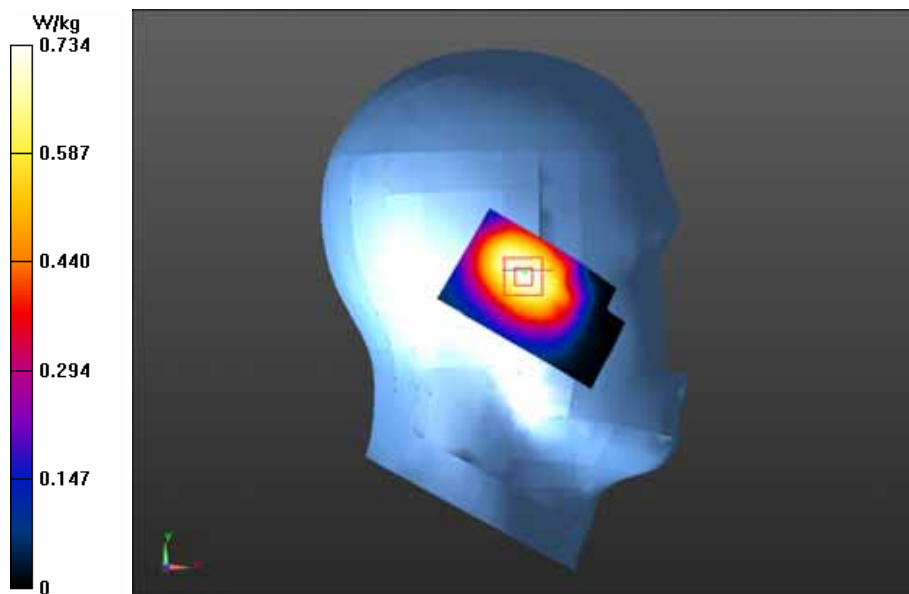

Test Laboratory: GCCT

Test Date: Apr.26, 2013

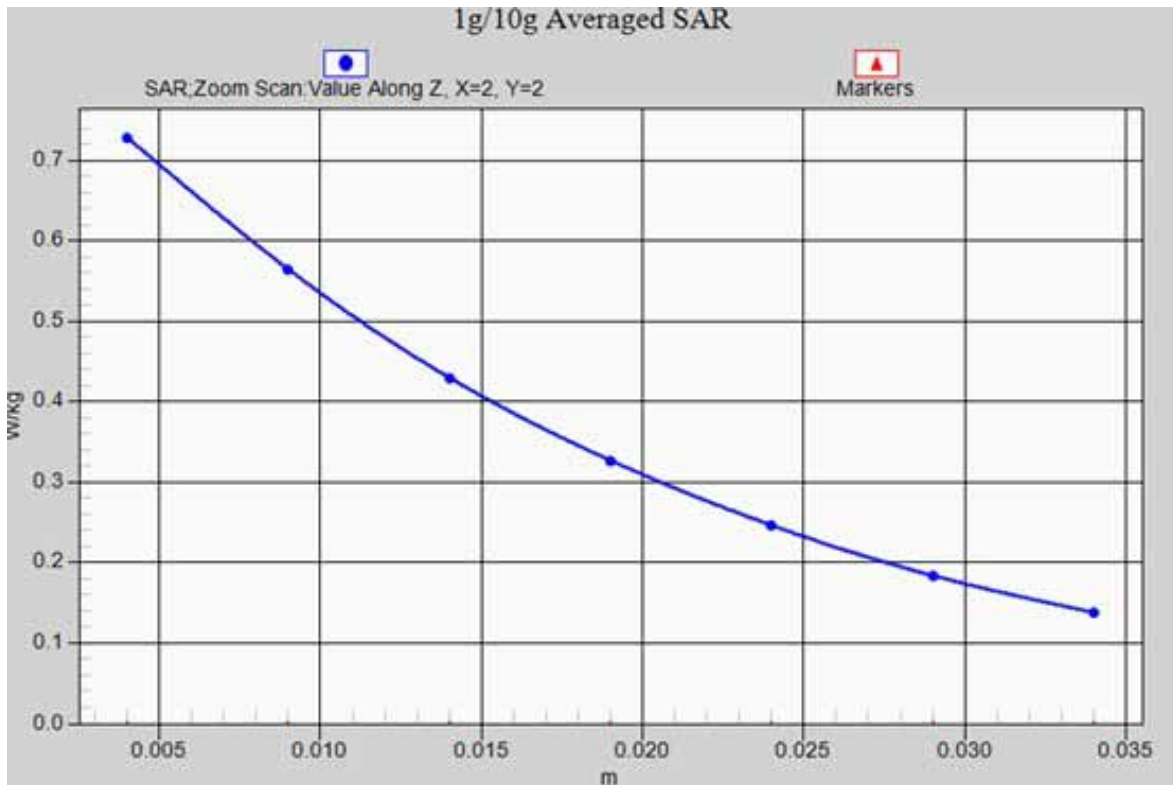

GSM850 LEFT/CHEEK-High_ z-axis scan

Test Laboratory: GCCT

Test Date: Apr.26, 2013

GSM850 LEFT/CHEEK-Mid

DUT: Bmobile; Type: QS304

Communication System: Generic GSM; Communication System Band: GSM 850 (824.0 - 849.0 MHz); Frequency: 836.6 MHz; Communication System PAR: 9.191 dB
Medium parameters used (interpolated): $f = 836.6$ MHz; $\sigma = 0.861$ mho/m; $\epsilon_r = 40.411$; $\rho = 1000$ kg/m³

Phantom section: Left Section

Measurement Standard: DASY5 (IEEE/IEC/ANSI C63.19-2007)

DASY5 Configuration:

- Probe: ES3DV3 - SN3221; ConvF(6.2, 6.2, 6.2); Calibrated: 9/27/2012;
- Sensor-Surface: 4mm (Mechanical Surface Detection)
- Electronics: DAE4 Sn893; Calibrated: 9/27/2012
- Phantom: SAM_2with CRP v4.0; Type: QD000P40CC; Serial: TP:1548
- Measurement SW: DASY52, Version 52.8 (2); SEMCAD X Version 14.6.6 (6824)

GSM850 LEFT/CHEEK-Mid/Area Scan (41x71x1): Interpolated grid: dx=1.500 mm, dy=1.500 mm

Reference Value = 20.719 V/m; Power Drift = -0.03 dB

Maximum value of SAR (interpolated) = 0.556 W/kg

GSM850 LEFT/CHEEK-Mid/Zoom Scan (5x5x7)/Cube 0: Measurement grid:

dx=8mm, dy=8mm, dz=5mm

Reference Value = 20.719 V/m; Power Drift = -0.03 dB

Peak SAR (extrapolated) = 0.658 mW/g

SAR(1 g) = 0.523 mW/g; SAR(10 g) = 0.380 mW/g

Maximum value of SAR (measured) = 0.550 W/kg

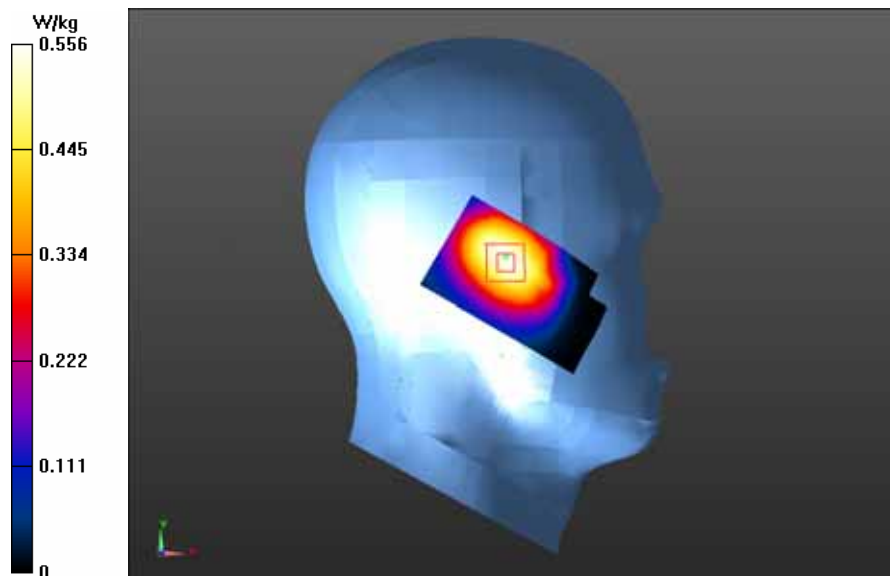

Test Laboratory: GCCT

Test Date: Apr.26, 2013

GSM850 LEFT/CHEEK-Low

DUT: Bmobile; Type: QS304

Communication System: Generic GSM; Communication System Band: GSM 850 (824.0 - 849.0 MHz); Frequency: 824.2 MHz; Communication System PAR: 9.191 dB
Medium parameters used (interpolated): $f = 824.2$ MHz; $\sigma = 0.849$ mho/m; $\epsilon_r = 40.573$; $\rho = 1000$ kg/m³

Phantom section: Left Section

Measurement Standard: DASY5 (IEEE/IEC/ANSI C63.19-2007)

DASY5 Configuration:

- Probe: ES3DV3 - SN3221; ConvF(6.2, 6.2, 6.2); Calibrated: 9/27/2012;
- Sensor-Surface: 4mm (Mechanical Surface Detection)
- Electronics: DAE4 Sn893; Calibrated: 9/27/2012
- Phantom: SAM_2with CRP v4.0; Type: QD000P40CC; Serial: TP:1548
- Measurement SW: DASY52, Version 52.8 (2); SEMCAD X Version 14.6.6 (6824)

GSM850 LEFT/CHEEK-Low/Area Scan (41x71x1): Interpolated grid: dx=1.500 mm, dy=1.500 mm

Reference Value = 18.593 V/m; Power Drift = 0.02 dB

Maximum value of SAR (interpolated) = 0.436 W/kg

GSM850 LEFT/CHEEK-Low/Zoom Scan (5x5x7)/Cube 0: Measurement grid:

dx=8mm, dy=8mm, dz=5mm

Reference Value = 18.593 V/m; Power Drift = 0.02 dB

Peak SAR (extrapolated) = 0.516 mW/g

SAR(1 g) = 0.413 mW/g; SAR(10 g) = 0.301 mW/g

Maximum value of SAR (measured) = 0.433 W/kg

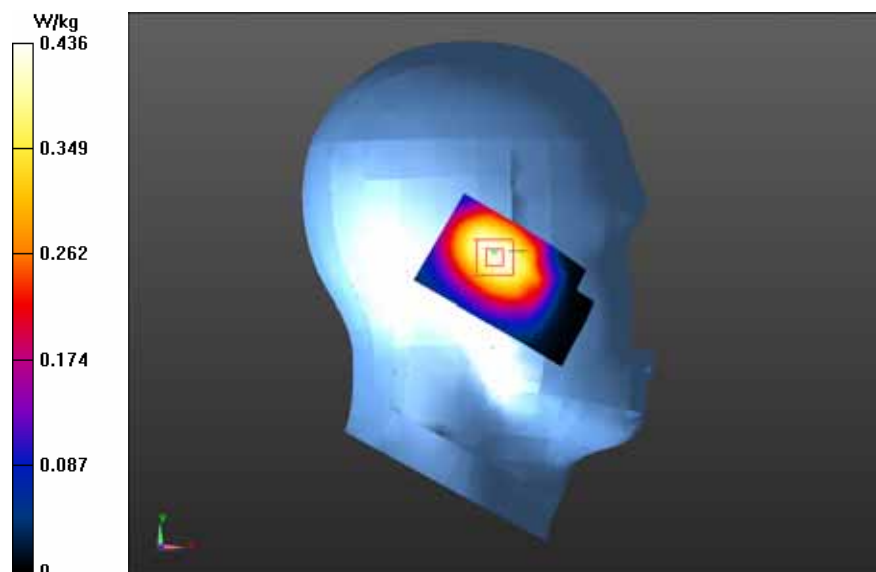

Test Laboratory: GCCT

Test Date: Apr.26, 2013

GSM850 LEFT/TILT-High

DUT: Bmobile; Type: QS304

Communication System: Generic GSM; Communication System Band: GSM 850 (824.0 - 849.0 MHz); Frequency: 848.8 MHz; Communication System PAR: 9.191 dB
Medium parameters used (interpolated): $f = 848.8$ MHz; $\sigma = 0.872$ mho/m; $\epsilon_r = 40.245$; $\rho = 1000$ kg/m³

Phantom section: Left Section

Measurement Standard: DASY5 (IEEE/IEC/ANSI C63.19-2007)

DASY5 Configuration:

- Probe: ES3DV3 - SN3221; ConvF(6.2, 6.2, 6.2); Calibrated: 9/27/2012;
- Sensor-Surface: 4mm (Mechanical Surface Detection)
- Electronics: DAE4 Sn893; Calibrated: 9/27/2012
- Phantom: SAM_2with CRP v4.0; Type: QD000P40CC; Serial: TP:1548
- Measurement SW: DASY52, Version 52.8 (2); SEMCAD X Version 14.6.6 (6824)

GSM850 LEFT/TILT-High/Area Scan (41x71x1): Interpolated grid: dx=1.500 mm, dy=1.500 mm

Reference Value = 22.726 V/m; Power Drift = 0.01 dB

Maximum value of SAR (interpolated) = 0.553 W/kg

GSM850 LEFT/TILT-High/Zoom Scan (5x5x7)/Cube 0: Measurement grid: dx=8mm, dy=8mm, dz=5mm

Reference Value = 22.726 V/m; Power Drift = 0.01 dB

Peak SAR (extrapolated) = 0.657 mW/g

SAR(1 g) = 0.488 mW/g; SAR(10 g) = 0.357 mW/g

Maximum value of SAR (measured) = 0.507 W/kg

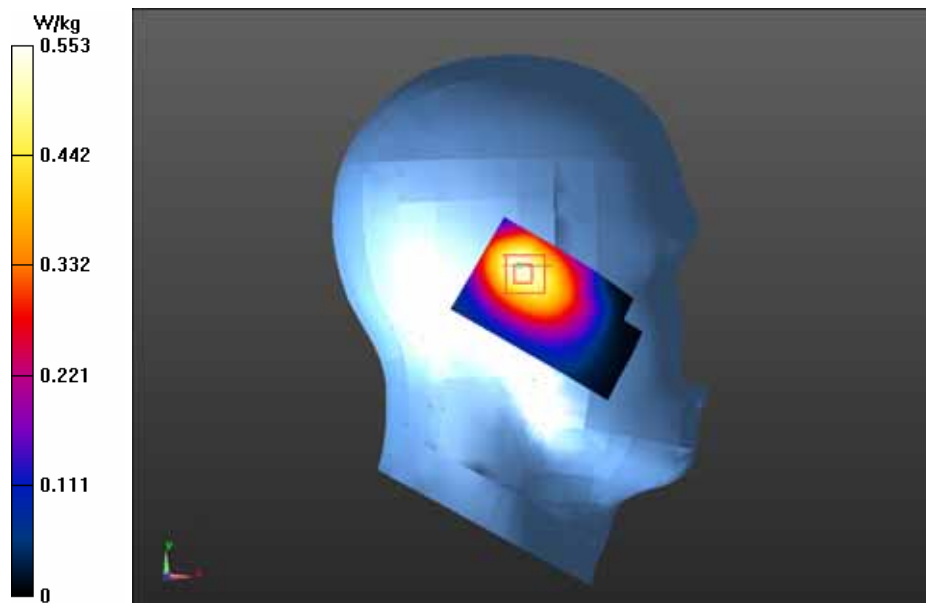

Test Laboratory: GCCT

Test Date: Apr.26, 2013

GSM850 RIGHT/CHEEK-High

DUT: Bmobile; Type: QS304

Communication System: Generic GSM; Communication System Band: GSM 850 (824.0 - 849.0 MHz); Frequency: 848.8 MHz; Communication System PAR: 9.191 dB
Medium parameters used (interpolated): $f = 848.8$ MHz; $\sigma = 0.872$ mho/m; $\epsilon_r = 40.245$; $\rho = 1000$ kg/m³

Phantom section: Right Section

Measurement Standard: DASY5 (IEEE/IEC/ANSI C63.19-2007)

DASY5 Configuration:

- Probe: ES3DV3 - SN3221; ConvF(6.2, 6.2, 6.2); Calibrated: 9/27/2012;
- Sensor-Surface: 4mm (Mechanical Surface Detection)
- Electronics: DAE4 Sn893; Calibrated: 9/27/2012
- Phantom: SAM_2with CRP v4.0; Type: QD000P40CC; Serial: TP:1548
- Measurement SW: DASY52, Version 52.8 (2); SEMCAD X Version 14.6.6 (6824)

GSM850 RIGHT/CHEEK-High/Area Scan (41x71x1): Interpolated grid: dx=1.500 mm, dy=1.500 mm

Reference Value = 24.949 V/m; Power Drift = 0.11 dB

Maximum value of SAR (interpolated) = 0.713 W/kg

GSM850 RIGHT/CHEEK-High/Zoom Scan (5x5x7)/Cube 0: Measurement grid: dx=8mm, dy=8mm, dz=5mm

Reference Value = 24.949 V/m; Power Drift = 0.11 dB

Peak SAR (extrapolated) = 0.837 mW/g

SAR(1 g) = 0.673 mW/g; SAR(10 g) = 0.489 mW/g

Maximum value of SAR (measured) = 0.707 W/kg

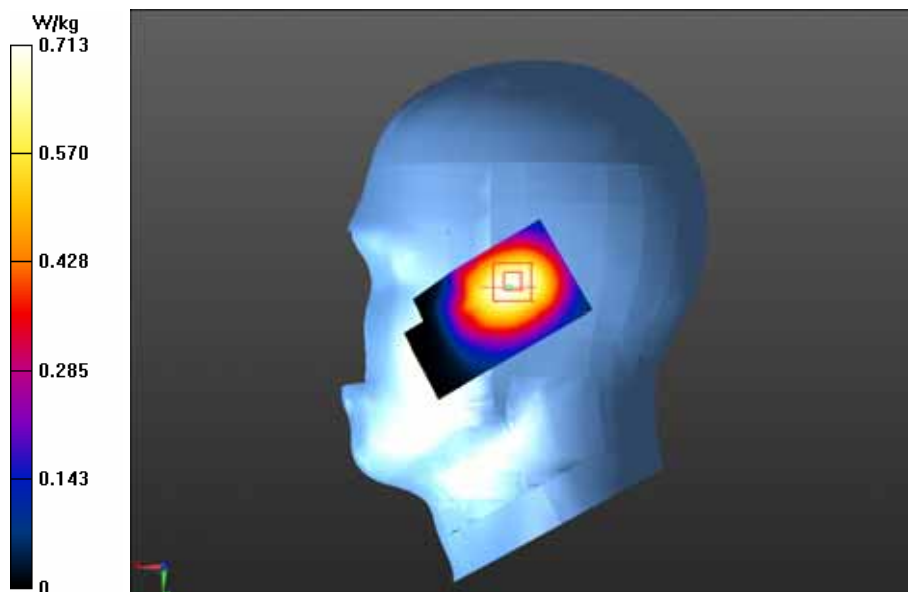

Test Laboratory: GCCT

Test Date: Apr.26, 2013

GSM850 RIGHT/TILT-High

DUT: Bmobile; Type: QS304

Communication System: Generic GSM; Communication System Band: GSM 850 (824.0 - 849.0 MHz); Frequency: 848.8 MHz; Communication System PAR: 9.191 dB
Medium parameters used (interpolated): $f = 848.8$ MHz; $\sigma = 0.872$ mho/m; $\epsilon_r = 40.245$; $\rho = 1000$ kg/m³

Phantom section: Right Section

Measurement Standard: DASY5 (IEEE/IEC/ANSI C63.19-2007)

DASY5 Configuration:

- Probe: ES3DV3 - SN3221; ConvF(6.2, 6.2, 6.2); Calibrated: 9/27/2012;
- Sensor-Surface: 4mm (Mechanical Surface Detection)
- Electronics: DAE4 Sn893; Calibrated: 9/27/2012
- Phantom: SAM_2with CRP v4.0; Type: QD000P40CC; Serial: TP:1548
- Measurement SW: DASY52, Version 52.8 (2); SEMCAD X Version 14.6.6 (6824)

GSM850 RIGHT/TILT-High/Area Scan (41x71x1): Interpolated grid: dx=1.500 mm, dy=1.500 mm

Reference Value = 23.624 V/m; Power Drift = 0.07 dB

Maximum value of SAR (interpolated) = 0.526 W/kg

GSM850 RIGHT/TILT-High/Zoom Scan (5x5x7)/Cube 0: Measurement grid:

dx=8mm, dy=8mm, dz=5mm

Reference Value = 23.624 V/m; Power Drift = 0.07 dB

Peak SAR (extrapolated) = 0.608 mW/g

SAR(1 g) = 0.477 mW/g; SAR(10 g) = 0.346 mW/g

Maximum value of SAR (measured) = 0.501 W/kg

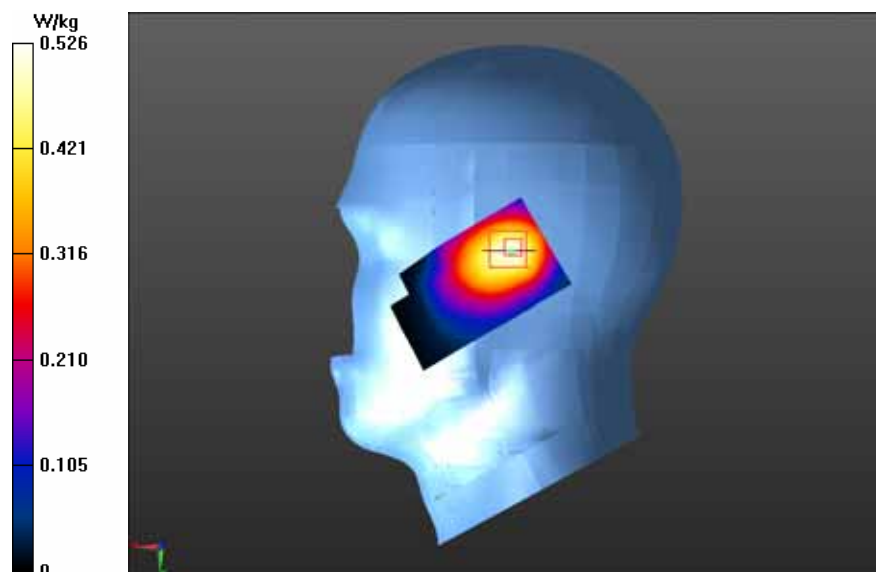

Test Laboratory: GCCT

Test Date: Apr.26, 2013

GSM850 Back side-High with headset

DUT: Bmobile; Type: QS304

Communication System: Generic GSM; Communication System Band: GSM 850 (824.0 - 849.0 MHz); Frequency: 848.8 MHz; Communication System PAR: 9.191 dB
Medium parameters used (interpolated): $f = 848.8$ MHz; $\sigma = 0.951$ mho/m; $\epsilon_r = 53.603$; $\rho = 1000$ kg/m³

Phantom section: Flat Section

Measurement Standard: DASY5 (IEEE/IEC/ANSI C63.19-2007)

DASY5 Configuration:

- Probe: ES3DV3 - SN3221; ConvF(6.23, 6.23, 6.23); Calibrated: 9/27/2012;
- Sensor-Surface: 4mm (Mechanical Surface Detection)
- Electronics: DAE4 Sn893; Calibrated: 9/27/2012
- Phantom: SAM_2with CRP v4.0; Type: QD000P40CC; Serial: TP:1548
- Measurement SW: DASY52, Version 52.8 (2); SEMCAD X Version 14.6.6 (6824)

GSM850 Back side-High with headset/Area Scan (41x71x1): Interpolated grid:

$dx=1.500$ mm, $dy=1.500$ mm

Reference Value = 13.901 V/m; Power Drift = -0.04 dB

Maximum value of SAR (interpolated) = 0.435 W/kg

GSM850 Back side-High with headset/Zoom Scan (5x5x7)/Cube 0: Measurement

grid: $dx=8$ mm, $dy=8$ mm, $dz=5$ mm

Reference Value = 13.901 V/m; Power Drift = -0.04 dB

Peak SAR (extrapolated) = 0.523 mW/g

SAR(1 g) = 0.398 mW/g; SAR(10 g) = 0.288 mW/g

Maximum value of SAR (measured) = 0.421 W/kg

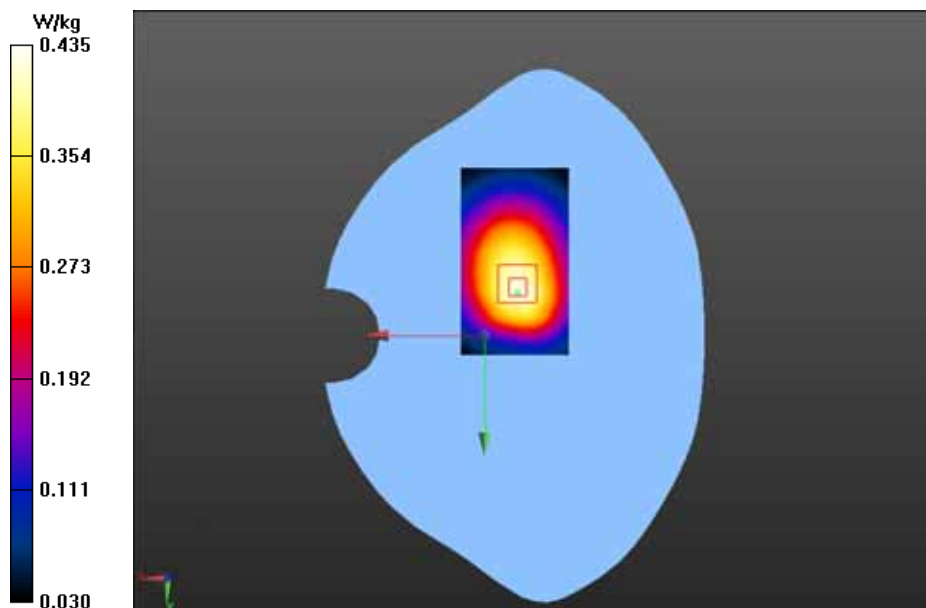

Test Laboratory: GCCT

Test Date: Apr.26, 2013

GSM850 Front side-High with headset

DUT: Bmobile; Type: QS304

Communication System: Generic GSM; Communication System Band: GSM 850 (824.0 - 849.0 MHz); Frequency: 848.8 MHz; Communication System PAR: 9.191 dB
Medium parameters used (interpolated): $f = 848.8$ MHz; $\sigma = 0.951$ mho/m; $\epsilon_r = 53.603$; $\rho = 1000$ kg/m³

Phantom section: Flat Section

Measurement Standard: DASY5 (IEEE/IEC/ANSI C63.19-2007)

DASY5 Configuration:

- Probe: ES3DV3 - SN3221; ConvF(6.23, 6.23, 6.23); Calibrated: 9/27/2012;
- Sensor-Surface: 4mm (Mechanical Surface Detection)
- Electronics: DAE4 Sn893; Calibrated: 9/27/2012
- Phantom: SAM_2with CRP v4.0; Type: QD000P40CC; Serial: TP:1548
- Measurement SW: DASY52, Version 52.8 (2); SEMCAD X Version 14.6.6 (6824)

GSM850 Front side-High with headset/Area Scan (41x71x1): Interpolated grid:

$dx=1.500$ mm, $dy=1.500$ mm

Reference Value = 11.196 V/m; Power Drift = 0.07 dB

Maximum value of SAR (interpolated) = 0.211 W/kg

GSM850 Front side-High with headset/Zoom Scan (5x5x7)/Cube 0: Measurement

grid: $dx=8$ mm, $dy=8$ mm, $dz=5$ mm

Reference Value = 11.196 V/m; Power Drift = 0.07 dB

Peak SAR (extrapolated) = 0.254 mW/g

SAR(1 g) = 0.200 mW/g; SAR(10 g) = 0.147 mW/g

Maximum value of SAR (measured) = 0.212 W/kg

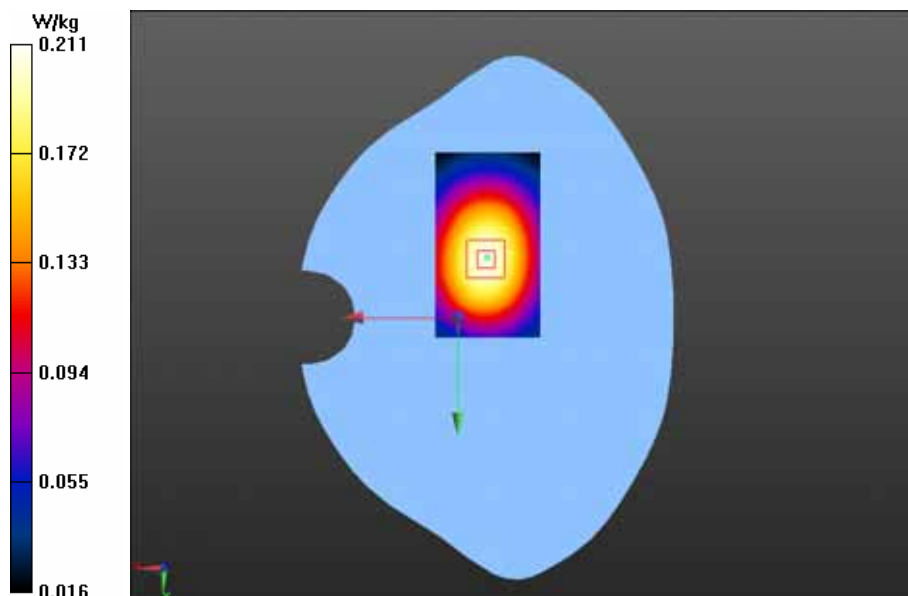

Test Laboratory: GCCT

Test Date: Apr.26, 2013

GPRS850/Back side-High

DUT: Bmobile; Type: QS304

Communication System: GPRS(4slots); Communication System Band: GSM850;
Frequency: 848.8 MHz; Communication System PAR: 3.181 dB

Medium parameters used (interpolated): $f = 848.8$ MHz; $\sigma = 0.951$ mho/m; $\epsilon_r = 53.603$; $\rho = 1000$ kg/m³

Phantom section: Flat Section

Measurement Standard: DASY5 (IEEE/IEC/ANSI C63.19-2007)

DASY5 Configuration:

- Probe: ES3DV3 - SN3221; ConvF(6.23, 6.23, 6.23); Calibrated: 9/27/2012;
- Sensor-Surface: 4mm (Mechanical Surface Detection)
- Electronics: DAE4 Sn893; Calibrated: 9/27/2012
- Phantom: SAM_2with CRP v4.0; Type: QD000P40CC; Serial: TP:1548
- Measurement SW: DASY52, Version 52.8 (2); SEMCAD X Version 14.6.6 (6824)

GPRS850/Back side-High/Area Scan (41x71x1): Interpolated grid: dx=1.500 mm, dy=1.500 mm

Reference Value = 17.573 V/m; Power Drift = 0.02 dB

Maximum value of SAR (interpolated) = 0.728 W/kg

GPRS850/Back side-High/Zoom Scan (5x5x7)/Cube 0: Measurement grid:

dx=8mm, dy=8mm, dz=5mm

Reference Value = 17.573 V/m; Power Drift = 0.02 dB

Peak SAR (extrapolated) = 0.861 mW/g

SAR(1 g) = 0.665 mW/g; SAR(10 g) = 0.483 mW/g

Maximum value of SAR (measured) = 0.699 W/kg

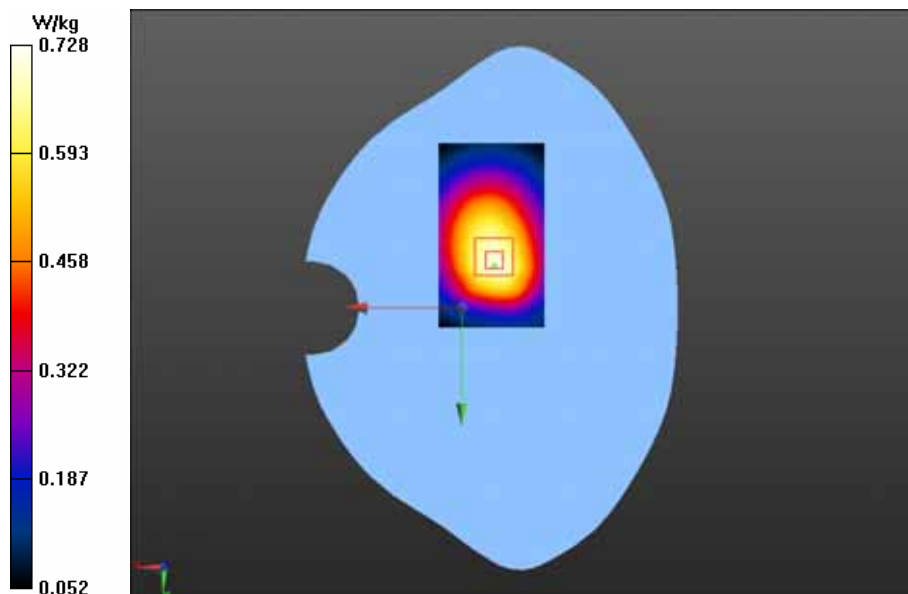

Test Laboratory: GCCT

Test Date: Apr.26, 2013

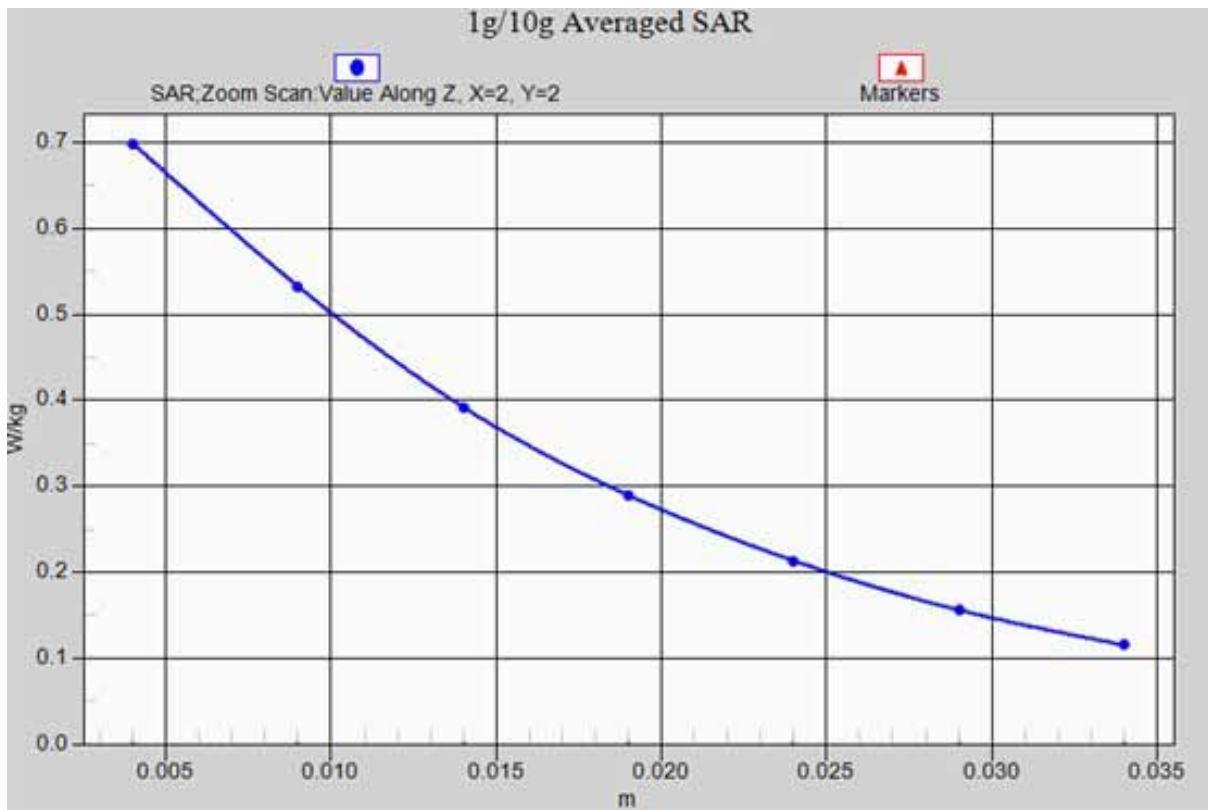

GPRS850/Back side-High_ z-axis scan

Test Laboratory: GCCT

Test Date: Apr.26, 2013

GPRS850/Back side-Mid

DUT: Bmobile; Type: QS304

Communication System: GPRS(4slots); Communication System Band: GSM850;
Frequency: 836.6 MHz; Communication System PAR: 3.181 dB

Medium parameters used (interpolated): $f = 836.6$ MHz; $\sigma = 0.939$ mho/m; $\epsilon_r = 53.719$; $\rho = 1000$ kg/m³

Phantom section: Flat Section

Measurement Standard: DASY5 (IEEE/IEC/ANSI C63.19-2007)

DASY5 Configuration:

- Probe: ES3DV3 - SN3221; ConvF(6.23, 6.23, 6.23); Calibrated: 9/27/2012;
- Sensor-Surface: 4mm (Mechanical Surface Detection)
- Electronics: DAE4 Sn893; Calibrated: 9/27/2012
- Phantom: SAM_2with CRP v4.0; Type: QD000P40CC; Serial: TP:1548
- Measurement SW: DASY52, Version 52.8 (2); SEMCAD X Version 14.6.6 (6824)

GPRS850/Back side-Mid/Area Scan (41x71x1): Interpolated grid: dx=1.500 mm, dy=1.500 mm

Reference Value = 15.065 V/m; Power Drift = 0.01 dB

Maximum value of SAR (interpolated) = 0.529 W/kg

GPRS850/Back side-Mid/Zoom Scan (5x5x7)/Cube 0: Measurement grid: dx=8mm, dy=8mm, dz=5mm

Reference Value = 15.065 V/m; Power Drift = 0.01 dB

Peak SAR (extrapolated) = 0.628 mW/g

SAR(1 g) = 0.481 mW/g; SAR(10 g) = 0.349 mW/g

Maximum value of SAR (measured) = 0.511 W/kg

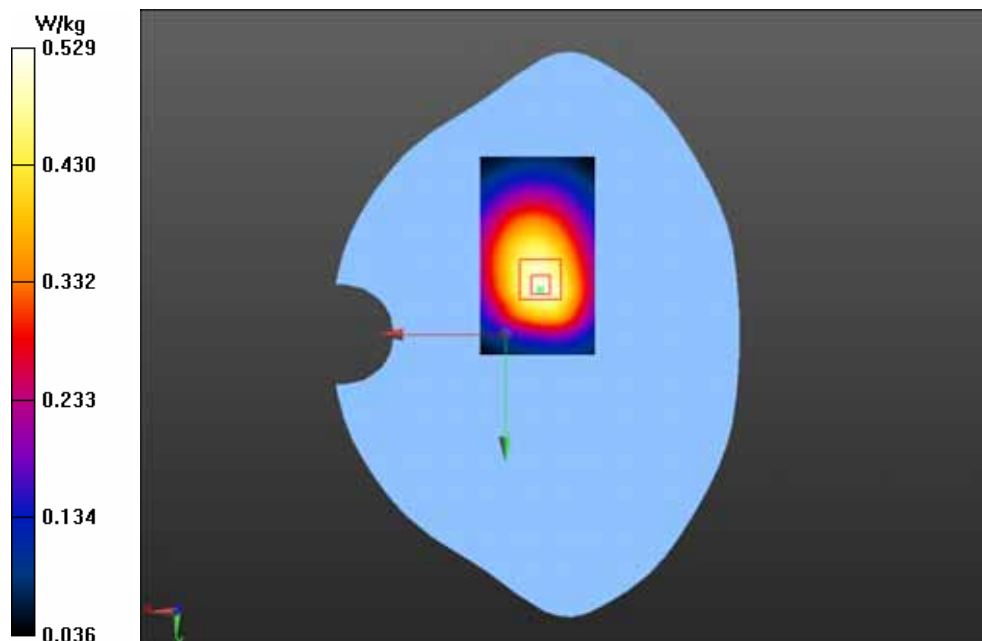

Test Laboratory: GCCT

Test Date: Apr.26, 2013

GPRS850/Back side-Low

DUT: Bmobile; Type: QS304

Communication System: GPRS(4slots); Communication System Band: GSM850;
Frequency: 824.2 MHz; Communication System PAR: 3.181 dB

Medium parameters used (interpolated): $f = 824.2$ MHz; $\sigma = 0.927$ mho/m; $\epsilon_r = 53.832$; $\rho = 1000$ kg/m³

Phantom section: Flat Section

Measurement Standard: DASY5 (IEEE/IEC/ANSI C63.19-2007)

DASY5 Configuration:

- Probe: ES3DV3 - SN3221; ConvF(6.23, 6.23, 6.23); Calibrated: 9/27/2012;
- Sensor-Surface: 4mm (Mechanical Surface Detection)
- Electronics: DAE4 Sn893; Calibrated: 9/27/2012
- Phantom: SAM_2with CRP v4.0; Type: QD000P40CC; Serial: TP:1548
- Measurement SW: DASY52, Version 52.8 (2); SEMCAD X Version 14.6.6 (6824)

GPRS850/Back side-Low/Area Scan (41x71x1): Interpolated grid: dx=1.500 mm, dy=1.500 mm

Reference Value = 13.284 V/m; Power Drift = -0.00 dB

Maximum value of SAR (interpolated) = 0.397 W/kg

GPRS850/Back side-Low/Zoom Scan (5x5x7)/Cube 0: Measurement grid:

dx=8mm, dy=8mm, dz=5mm

Reference Value = 13.284 V/m; Power Drift = -0.00 dB

Peak SAR (extrapolated) = 0.473 mW/g

SAR(1 g) = 0.363 mW/g; SAR(10 g) = 0.265 mW/g

Maximum value of SAR (measured) = 0.384 W/kg

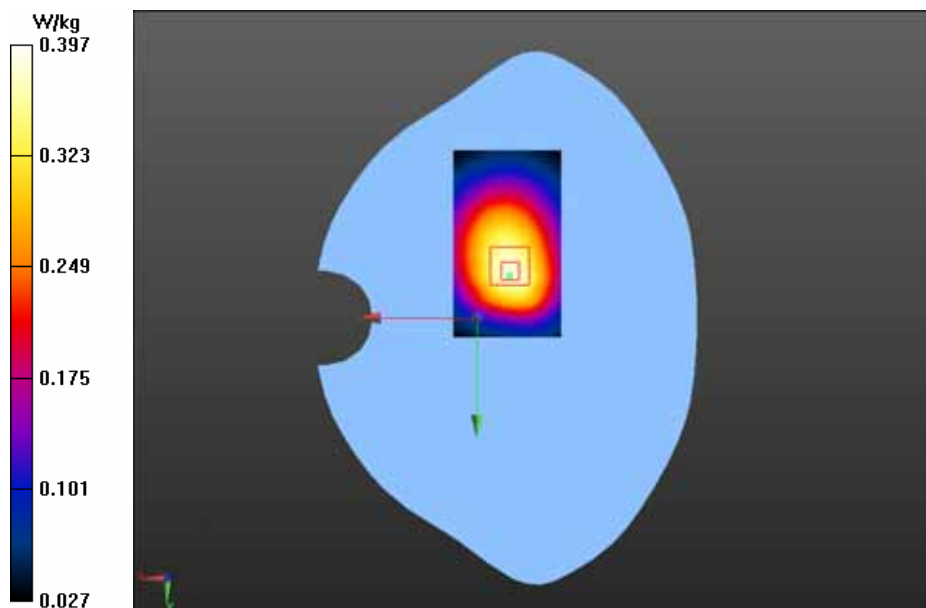

Test Laboratory: GCCT

Test Date: Apr.26, 2013

GPRS850/Front side-High

DUT: Bmobile; Type: QS304

Communication System: GPRS(4slots); Communication System Band: GSM850;
Frequency: 848.8 MHz; Communication System PAR: 3.181 dB

Medium parameters used (interpolated): $f = 848.8$ MHz; $\sigma = 0.951$ mho/m; $\epsilon_r = 53.603$; $\rho = 1000$ kg/m³

Phantom section: Flat Section

Measurement Standard: DASY5 (IEEE/IEC/ANSI C63.19-2007)

DASY5 Configuration:

- Probe: ES3DV3 - SN3221; ConvF(6.23, 6.23, 6.23); Calibrated: 9/27/2012;
- Sensor-Surface: 4mm (Mechanical Surface Detection)
- Electronics: DAE4 Sn893; Calibrated: 9/27/2012
- Phantom: SAM_2with CRP v4.0; Type: QD000P40CC; Serial: TP:1548
- Measurement SW: DASY52, Version 52.8 (2); SEMCAD X Version 14.6.6 (6824)

GPRS850/Front side-High/Area Scan (41x71x1): Interpolated grid: dx=1.500 mm, dy=1.500 mm

Reference Value = 14.698 V/m; Power Drift = -0.03 dB

Maximum value of SAR (interpolated) = 0.358 W/kg

GPRS850/Front side-High/Zoom Scan (5x5x7)/Cube 0: Measurement grid:

dx=8mm, dy=8mm, dz=5mm

Reference Value = 14.698 V/m; Power Drift = -0.03 dB

Peak SAR (extrapolated) = 0.433 mW/g

SAR(1 g) = 0.341 mW/g; SAR(10 g) = 0.250 mW/g

Maximum value of SAR (measured) = 0.362 W/kg

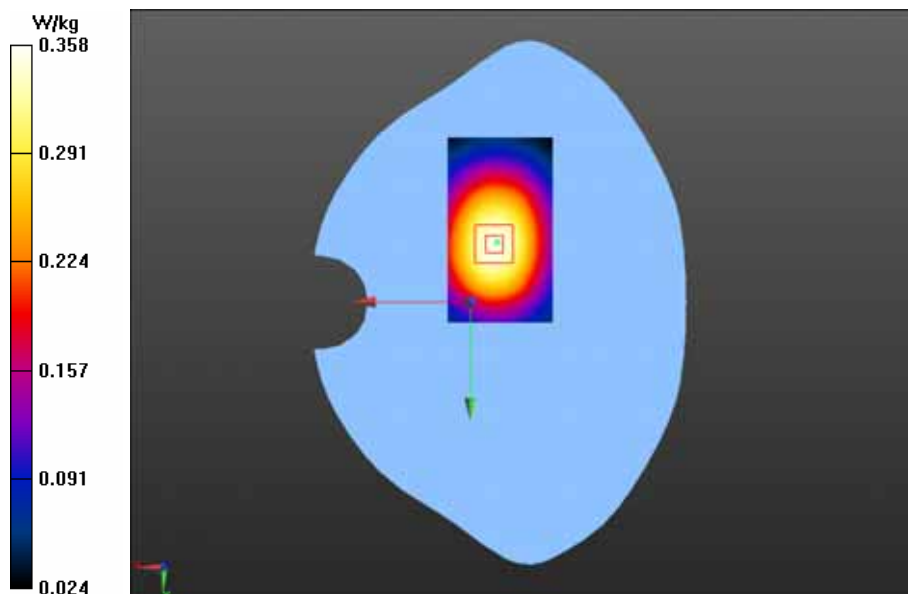

Test Laboratory: GCCT

Test Date: Apr.27, 2013

PCS1900 LEFT/CHEEK-Low

DUT: Bmobile; Type: QS304

Communication System: Generic GSM; Communication System Band: PCS 1900 (1850.0 - 1910.0 MHz); Frequency: 1850.2 MHz; Communication System PAR: 9.191 dB. Medium parameters used: $f = 1850.2$ MHz; $\sigma = 1.42$ mho/m; $\epsilon_r = 39.87$; $\rho = 1000$ kg/m³

Phantom section: Left Section

Measurement Standard: DASY5 (IEEE/IEC/ANSI C63.19-2007)

DASY5 Configuration:

- Probe: ES3DV3 - SN3221; ConvF(5.39, 5.39, 5.39); Calibrated: 9/27/2012;
- Sensor-Surface: 4mm (Mechanical Surface Detection)
- Electronics: DAE4 Sn893; Calibrated: 9/27/2012
- Phantom: SAM_1 with CRP v4.0; Type: QD000P40CC; Serial: TP:1586
- Measurement SW: DASY52, Version 52.8 (2); SEMCAD X Version 14.6.6 (6824)

PCS1900 LEFT/CHEEK-Low/Area Scan (41x71x1): Interpolated grid: dx=1.500 mm, dy=1.500 mm

Reference Value = 11.185 V/m; Power Drift = 0.01 dB

Maximum value of SAR (interpolated) = 0.300 W/kg

PCS1900 LEFT/CHEEK-Low/Zoom Scan (5x5x7)/Cube 0: Measurement grid:

dx=8mm, dy=8mm, dz=5mm

Reference Value = 11.185 V/m; Power Drift = 0.01 dB

Peak SAR (extrapolated) = 0.311 mW/g

SAR(1 g) = 0.223 mW/g; SAR(10 g) = 0.145 mW/g

Maximum value of SAR (measured) = 0.237 W/kg

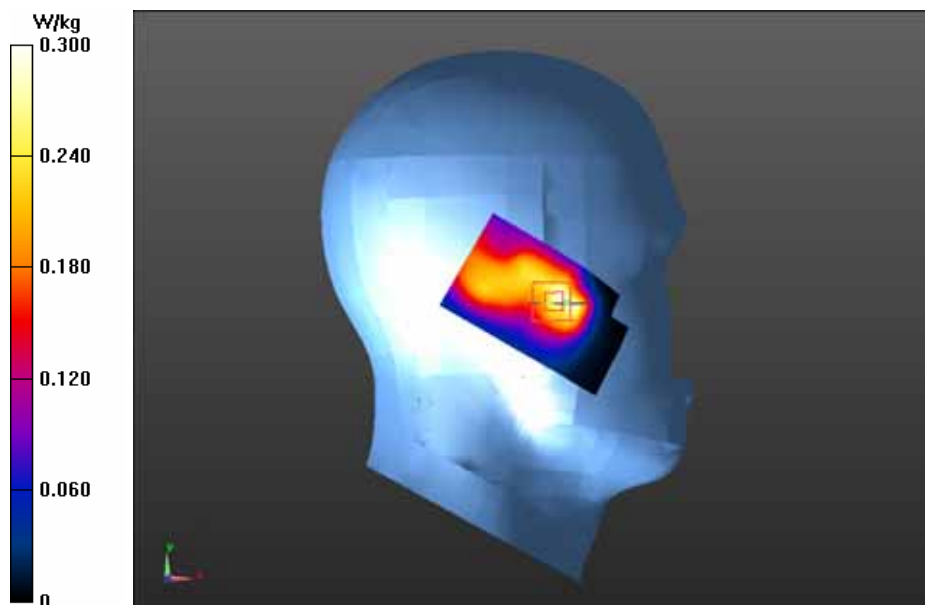

Test Laboratory: GCCT

Test Date: Apr.27, 2013

PCS1900 LEFT/TILT-Low

DUT: Bmobile; Type: QS304

Communication System: Generic GSM; Communication System Band: PCS 1900 (1850.0 - 1910.0 MHz); Frequency: 1850.2 MHz; Communication System PAR: 9.191 dB. Medium parameters used: $f = 1850.2$ MHz; $\sigma = 1.42$ mho/m; $\epsilon_r = 39.87$; $\rho = 1000$ kg/m³

Phantom section: Left Section

Measurement Standard: DASY5 (IEEE/IEC/ANSI C63.19-2007)

DASY5 Configuration:

- Probe: ES3DV3 - SN3221; ConvF(5.39, 5.39, 5.39); Calibrated: 9/27/2012;
- Sensor-Surface: 4mm (Mechanical Surface Detection)
- Electronics: DAE4 Sn893; Calibrated: 9/27/2012
- Phantom: SAM_1 with CRP v4.0; Type: QD000P40CC; Serial: TP:1586
- Measurement SW: DASY52, Version 52.8 (2); SEMCAD X Version 14.6.6 (6824)

PCS1900 LEFT/TILT-Low/Area Scan (41x71x1): Interpolated grid: dx=1.500 mm, dy=1.500 mm

Reference Value = 13.130 V/m; Power Drift = -0.02 dB

Maximum value of SAR (interpolated) = 0.286 W/kg

PCS1900 LEFT/TILT-Low/Zoom Scan (5x5x7)/Cube 0: Measurement grid:

dx=8mm, dy=8mm, dz=5mm

Reference Value = 13.130 V/m; Power Drift = -0.02 dB

Peak SAR (extrapolated) = 0.463 mW/g

SAR(1 g) = 0.265 mW/g; SAR(10 g) = 0.149 mW/g

Maximum value of SAR (measured) = 0.286 W/kg

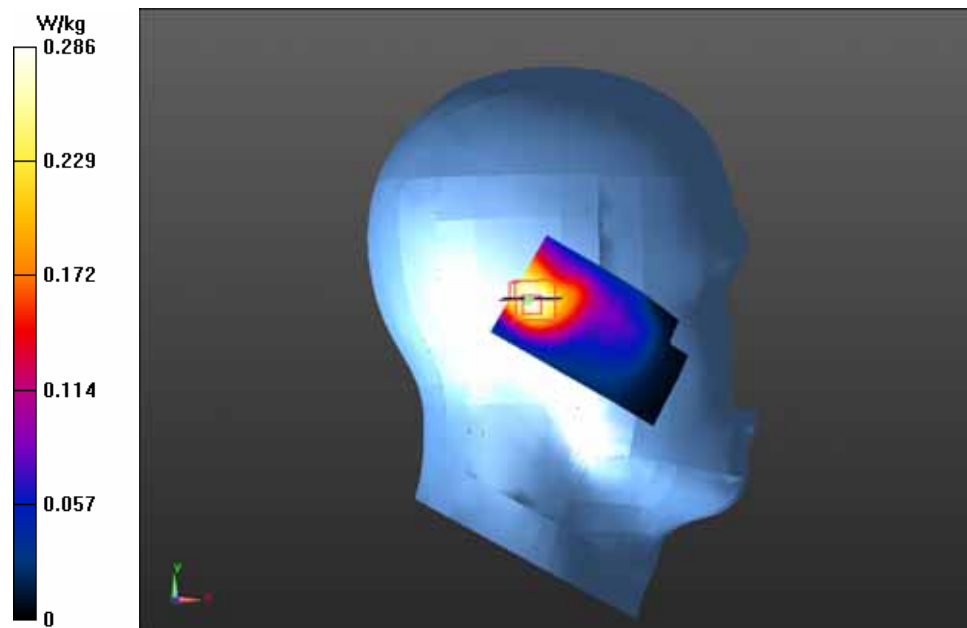

Test Laboratory: GCCT

Test Date: Apr.27, 2013

PCS1900 RIGHT/CHEEK-Low

DUT: Bmobile; Type: QS304

Communication System: Generic GSM; Communication System Band: PCS 1900 (1850.0 - 1910.0 MHz); Frequency: 1850.2 MHz; Communication System PAR: 9.191 dB. Medium parameters used: $f = 1850.2$ MHz; $\sigma = 1.42$ mho/m; $\epsilon_r = 39.87$; $\rho = 1000$ kg/m³

Phantom section: Right Section

Measurement Standard: DASYS (IEEE/IEC/ANSI C63.19-2007)

DASY5 Configuration:

- Probe: ES3DV3 - SN3221; ConvF(5.39, 5.39, 5.39); Calibrated: 9/27/2012;
- Sensor-Surface: 4mm (Mechanical Surface Detection)
- Electronics: DAE4 Sn893; Calibrated: 9/27/2012
- Phantom: SAM_1 with CRP v4.0; Type: QD000P40CC; Serial: TP:1586
- Measurement SW: DASYS2, Version 52.8 (2); SEMCAD X Version 14.6.6 (6824)

PCS1900 RIGHT/CHEEK-Low/Area Scan (41x71x1): Interpolated grid: dx=1.500 mm, dy=1.500 mm

Reference Value = 8.483 V/m; Power Drift = 0.18 dB

Maximum value of SAR (interpolated) = 0.335 W/kg

PCS1900 RIGHT/CHEEK-Low/Zoom Scan (5x5x7)/Cube 0: Measurement grid: dx=8mm, dy=8mm, dz=5mm

Reference Value = 8.483 V/m; Power Drift = 0.18 dB

Peak SAR (extrapolated) = 0.541 mW/g

SAR(1 g) = 0.297 mW/g; SAR(10 g) = 0.155 mW/g

Maximum value of SAR (measured) = 0.315 W/kg

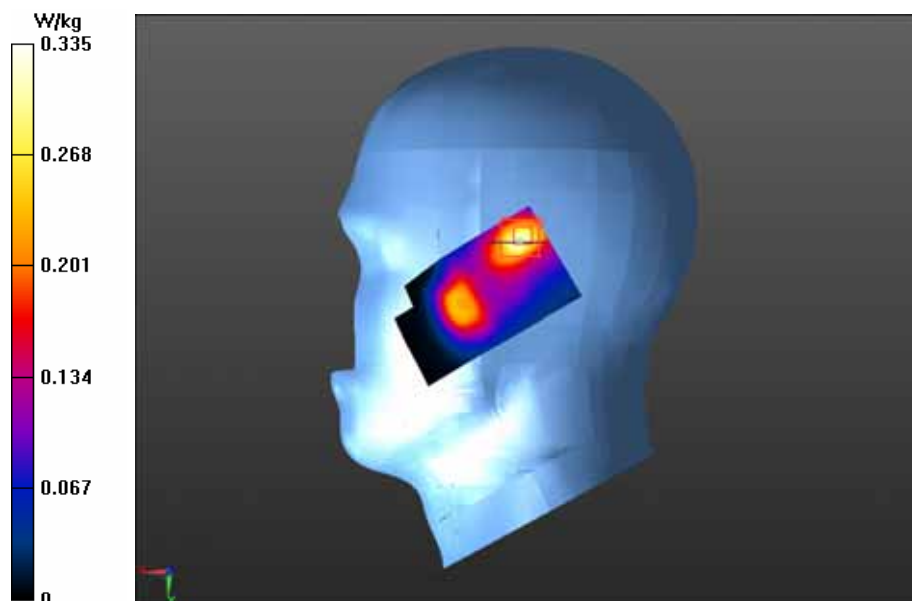

Test Laboratory: GCCT

Test Date: Apr.27, 2013

PCS1900 RIGHT/TILT-High

DUT: Bmobile; Type: QS304

Communication System: Generic GSM; Communication System Band: PCS 1900 (1850.0 - 1910.0 MHz); Frequency: 1909.8 MHz; Communication System PAR: 9.191 dB. Medium parameters used: $f = 1909.8$ MHz; $\sigma = 1.48$ mho/m; $\epsilon_r = 39.6$; $\rho = 1000$ kg/m³

Phantom section: Right Section

Measurement Standard: DASY5 (IEEE/IEC/ANSI C63.19-2007)

DASY5 Configuration:

- Probe: ES3DV3 - SN3221; ConvF(5.39, 5.39, 5.39); Calibrated: 9/27/2012;
- Sensor-Surface: 4mm (Mechanical Surface Detection)
- Electronics: DAE4 Sn893; Calibrated: 9/27/2012
- Phantom: SAM_1 with CRP v4.0; Type: QD000P40CC; Serial: TP:1586
- Measurement SW: DASY52, Version 52.8 (2); SEMCAD X Version 14.6.6 (6824)

PCS1900 RIGHT/TILT-High/Area Scan (41x71x1): Interpolated grid: dx=1.500 mm, dy=1.500 mm

Reference Value = 10.165 V/m; Power Drift = -0.02 dB

Maximum value of SAR (interpolated) = 0.339 W/kg

PCS1900 RIGHT/TILT-High/Zoom Scan (5x5x7)/Cube 0: Measurement grid:

dx=8mm, dy=8mm, dz=5mm

Reference Value = 10.165 V/m; Power Drift = -0.02 dB

Peak SAR (extrapolated) = 0.556 mW/g

SAR(1 g) = 0.295 mW/g; SAR(10 g) = 0.155 mW/g

Maximum value of SAR (measured) = 0.312 W/kg

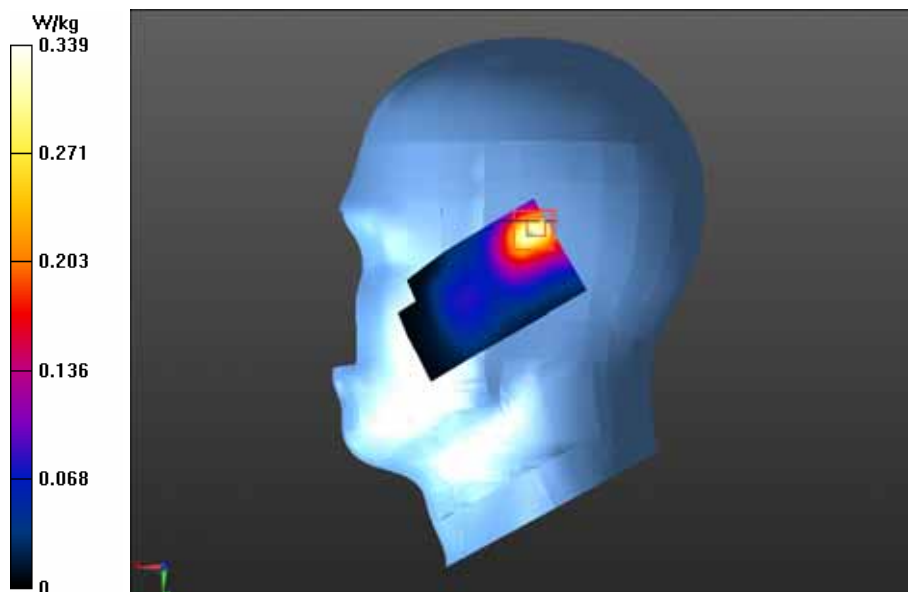

Test Laboratory: GCCT

Test Date: Apr.27, 2013

PCS1900 RIGHT/TILT-Mid

DUT: Bmobile; Type: QS304

Communication System: Generic GSM; Communication System Band: PCS 1900 (1850.0 - 1910.0 MHz); Frequency: 1880 MHz; Communication System PAR: 9.191 dB. Medium parameters used: $f = 1880$ MHz; $\sigma = 1.45$ mho/m; $\epsilon_r = 39.74$; $\rho = 1000$ kg/m³

Phantom section: Right Section

Measurement Standard: DASY5 (IEEE/IEC/ANSI C63.19-2007)

DASY5 Configuration:

- Probe: ES3DV3 - SN3221; ConvF(5.39, 5.39, 5.39); Calibrated: 9/27/2012;
- Sensor-Surface: 4mm (Mechanical Surface Detection)
- Electronics: DAE4 Sn893; Calibrated: 9/27/2012
- Phantom: SAM_1 with CRP v4.0; Type: QD000P40CC; Serial: TP:1586
- Measurement SW: DASY52, Version 52.8 (2); SEMCAD X Version 14.6.6 (6824)

PCS1900 RIGHT/TILT-Mid/Area Scan (41x71x1): Interpolated grid: dx=1.500 mm, dy=1.500 mm

Reference Value = 10.432 V/m; Power Drift = 0.01 dB

Maximum value of SAR (interpolated) = 0.333 W/kg

PCS1900 RIGHT/TILT-Mid/Zoom Scan (5x5x7)/Cube 0: Measurement grid:

dx=8mm, dy=8mm, dz=5mm

Reference Value = 10.432 V/m; Power Drift = 0.01 dB

Peak SAR (extrapolated) = 0.540 mW/g

SAR(1 g) = 0.291 mW/g; SAR(10 g) = 0.154 mW/g

Maximum value of SAR (measured) = 0.309 W/kg

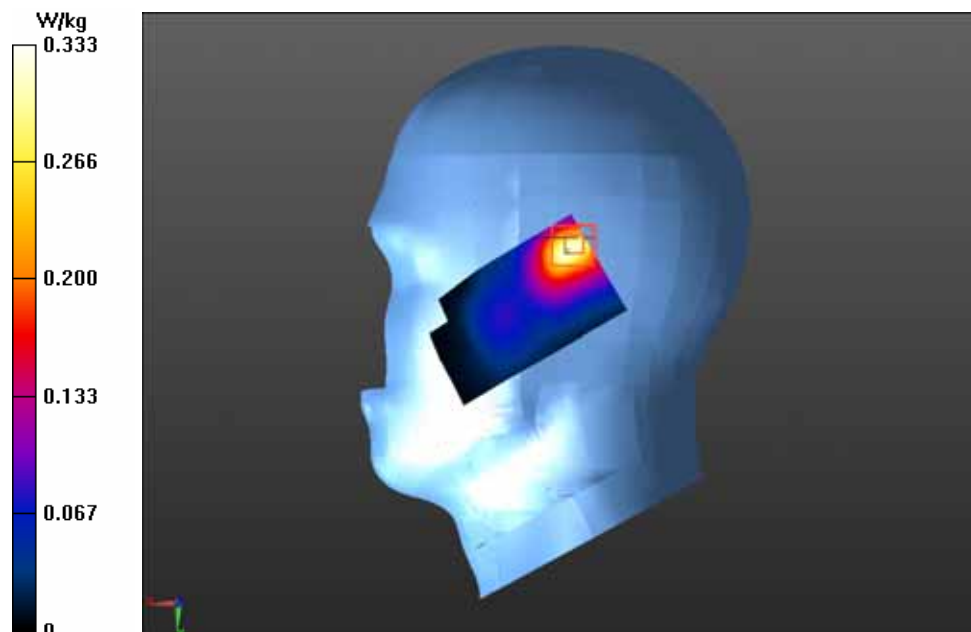

Test Laboratory: GCCT

Test Date: Apr.27, 2013

PCS1900 RIGHT/TILT-Low

DUT: Bmobile; Type: QS304

Communication System: Generic GSM; Communication System Band: PCS 1900 (1850.0 - 1910.0 MHz); Frequency: 1850.2 MHz; Communication System PAR: 9.191 dB. Medium parameters used: $f = 1850.2$ MHz; $\sigma = 1.42$ mho/m; $\epsilon_r = 39.87$; $\rho = 1000$ kg/m³

Phantom section: Right Section

Measurement Standard: DASY5 (IEEE/IEC/ANSI C63.19-2007)

DASY5 Configuration:

- Probe: ES3DV3 - SN3221; ConvF(5.39, 5.39, 5.39); Calibrated: 9/27/2012;
- Sensor-Surface: 4mm (Mechanical Surface Detection)
- Electronics: DAE4 Sn893; Calibrated: 9/27/2012
- Phantom: SAM_1 with CRP v4.0; Type: QD000P40CC; Serial: TP:1586
- Measurement SW: DASY52, Version 52.8 (2); SEMCAD X Version 14.6.6 (6824)

PCS1900 RIGHT/TILT-Low/Area Scan (41x71x1): Interpolated grid: dx=1.500 mm, dy=1.500 mm

Reference Value = 10.709 V/m; Power Drift = 0.11 dB

Maximum value of SAR (interpolated) = 0.339 W/kg

PCS1900 RIGHT/TILT-Low/Zoom Scan (5x5x7)/Cube 0: Measurement grid:

dx=8mm, dy=8mm, dz=5mm

Reference Value = 10.709 V/m; Power Drift = 0.11 dB

Peak SAR (extrapolated) = 0.544 mW/g

SAR(1 g) = 0.298 mW/g; SAR(10 g) = 0.159 mW/g

Maximum value of SAR (measured) = 0.313 W/kg

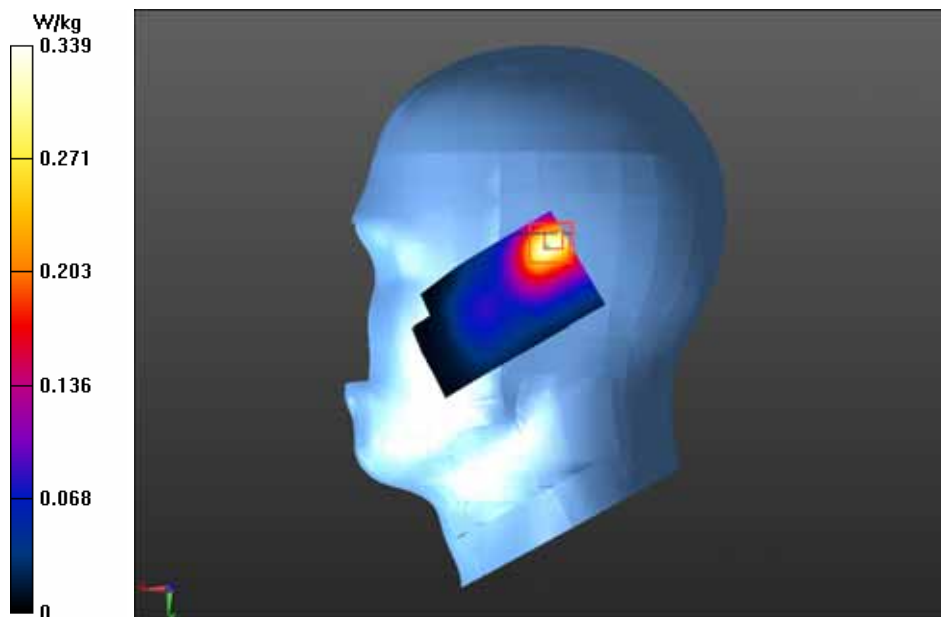

Test Laboratory: GCCT

Test Date: Apr.27, 2013

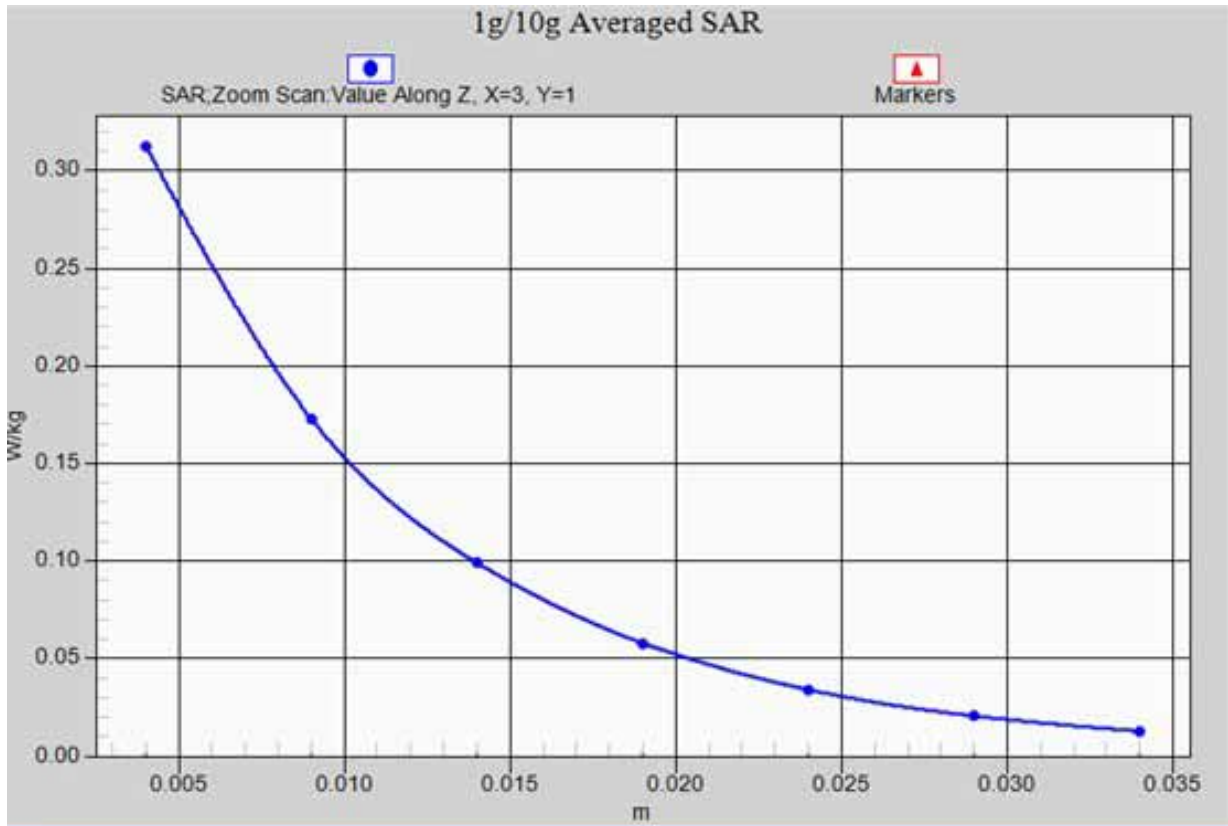

PCS1900 RIGHT/TILT-Low_ z-axis scan

Test Laboratory: GCCT

Test Date: Apr.27, 2013

GSM1900 Back side-Low with headset

DUT: Bmobile; Type: QS304

Communication System: Generic GSM; Communication System Band: PCS 1900 (1850.0 - 1910.0 MHz); Frequency: 1850.2 MHz; Communication System PAR: 9.191 dB. Medium parameters used (interpolated): $f = 1850.2$ MHz; $\sigma = 1.525$ mho/m; $\epsilon_r = 50.831$; $\rho = 1000$ kg/m³

Phantom section: Flat Section

Measurement Standard: DASY5 (IEEE/IEC/ANSI C63.19-2007)

DASY5 Configuration:

- Probe: ES3DV3 - SN3221; ConvF(4.87, 4.87, 4.87); Calibrated: 9/27/2012;
- Sensor-Surface: 4mm (Mechanical Surface Detection)
- Electronics: DAE4 Sn893; Calibrated: 9/27/2012
- Phantom: SAM_1 with CRP v4.0; Type: QD000P40CC; Serial: TP:1586
- Measurement SW: DASY52, Version 52.8 (2); SEMCAD X Version 14.6.6 (6824)

GSM1900 Back side-Low with headset/Area Scan (41x71x1): Interpolated grid:

$dx=1.500$ mm, $dy=1.500$ mm

Reference Value = 8.635 V/m; Power Drift = 0.16 dB

Maximum value of SAR (interpolated) = 0.191 W/kg

GSM1900 Back side-Low with headset/Zoom Scan (5x5x7)/Cube 0:

Measurement grid: $dx=8$ mm, $dy=8$ mm, $dz=5$ mm

Reference Value = 8.635 V/m; Power Drift = 0.16 dB

Peak SAR (extrapolated) = 0.264 mW/g

SAR(1 g) = 0.176 mW/g; SAR(10 g) = 0.113 mW/g

Maximum value of SAR (measured) = 0.189 W/kg

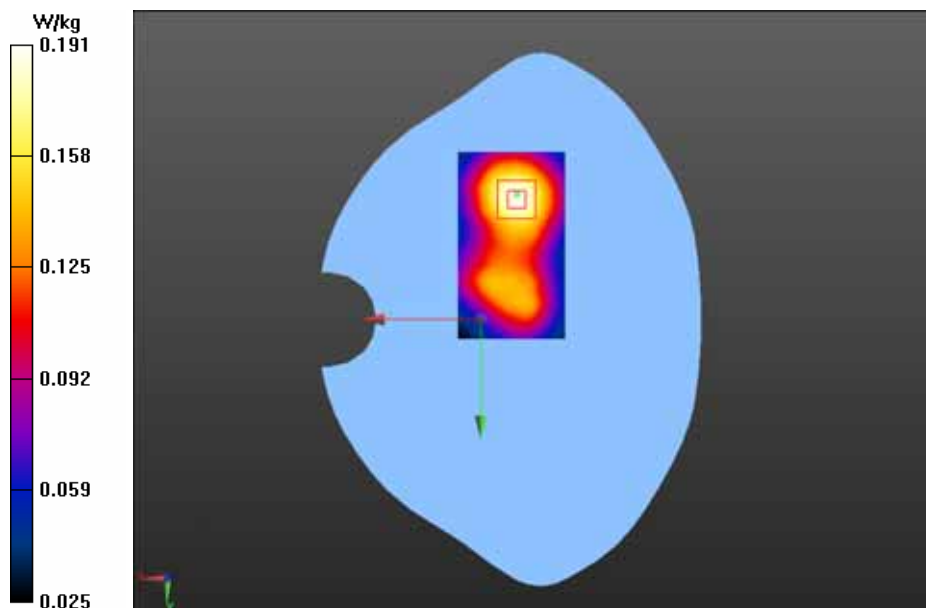

Test Laboratory: GCCT

Test Date: Apr.27, 2013

GSM1900 Front side-Low with headset

DUT: Bmobile; Type: QS304

Communication System: Generic GSM; Communication System Band: PCS 1900 (1850.0 - 1910.0 MHz); Frequency: 1850.2 MHz; Communication System PAR: 9.191 dB

Medium parameters used (interpolated): $f = 1850.2$ MHz; $\sigma = 1.525$ mho/m; $\epsilon_r = 50.831$; $\rho = 1000$ kg/m³

Phantom section: Flat Section

Measurement Standard: DASY5 (IEEE/IEC/ANSI C63.19-2007)

DASY5 Configuration:

- Probe: ES3DV3 - SN3221; ConvF(4.87, 4.87, 4.87); Calibrated: 9/27/2012;
- Sensor-Surface: 4mm (Mechanical Surface Detection)
- Electronics: DAE4 Sn893; Calibrated: 9/27/2012
- Phantom: SAM_1 with CRP v4.0; Type: QD000P40CC; Serial: TP:1586
- Measurement SW: DASY52, Version 52.8 (2); SEMCAD X Version 14.6.6 (6824)

GSM1900 Front side-Low with headset/Area Scan (41x71x1): Interpolated grid:

$dx=1.500$ mm, $dy=1.500$ mm

Reference Value = 6.326 V/m; Power Drift = 0.19 dB

Maximum value of SAR (interpolated) = 0.0879 W/kg

GSM1900 Front side-Low with headset/Zoom Scan (5x5x7)/Cube 0:

Measurement grid: $dx=8$ mm, $dy=8$ mm, $dz=5$ mm

Reference Value = 6.326 V/m; Power Drift = 0.19 dB

Peak SAR (extrapolated) = 0.126 mW/g

SAR(1 g) = 0.083 mW/g; SAR(10 g) = 0.053 mW/g

Maximum value of SAR (measured) = 0.0886 W/kg

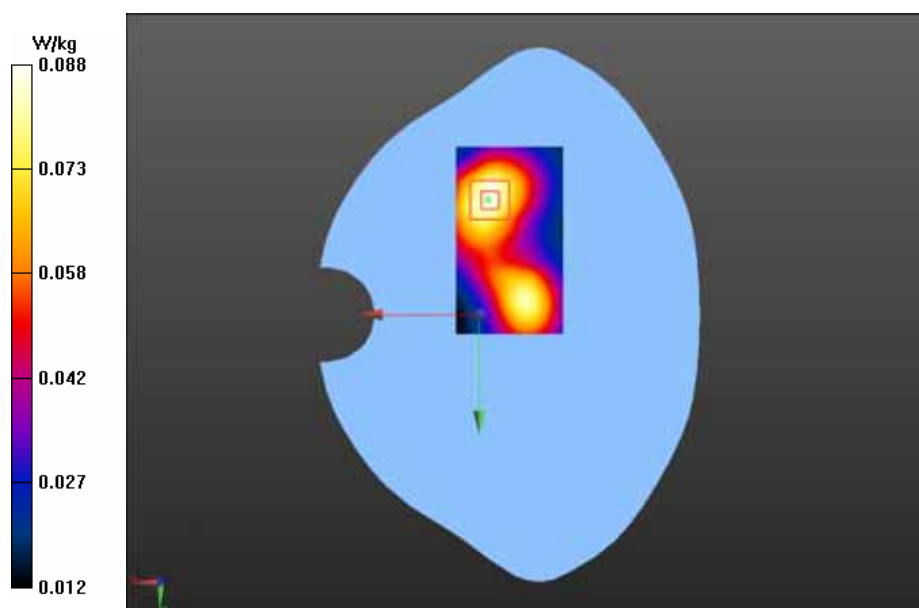

Test Laboratory: GCCT

Test Date: Apr.27, 2013

GPRS1900/Back side-High

DUT: Bmobile; Type: QS304

Communication System: GPRS(3slots); Communication System Band: PCS 1900;
Frequency: 1909.8 MHz; Communication System PAR: 4.44 dB
Medium parameters used: $f = 1910$ MHz; $\sigma = 1.588$ mho/m; $\epsilon_r = 50.69$; $\rho = 1000$ kg/m³

Phantom section: Flat Section

Measurement Standard: DASY5 (IEEE/IEC/ANSI C63.19-2007)

DASY5 Configuration:

- Probe: ES3DV3 - SN3221; ConvF(4.87, 4.87, 4.87); Calibrated: 9/27/2012;
- Sensor-Surface: 4mm (Mechanical Surface Detection)
- Electronics: DAE4 Sn893; Calibrated: 9/27/2012
- Phantom: SAM_1 with CRP v4.0; Type: QD000P40CC; Serial: TP:1586
- Measurement SW: DASY52, Version 52.8 (2); SEMCAD X Version 14.6.6 (6824)

GPRS1900/Back side-High/Area Scan (41x71x1): Interpolated grid: dx=1.500 mm, dy=1.500 mm

Reference Value = 11.807 V/m; Power Drift = 0.06 dB

Maximum value of SAR (interpolated) = 0.346 W/kg

GPRS1900/Back side-High/Zoom Scan (5x5x7)/Cube 0: Measurement grid:

dx=8mm, dy=8mm, dz=5mm

Reference Value = 11.807 V/m; Power Drift = 0.06 dB

Peak SAR (extrapolated) = 0.480 mW/g

SAR(1 g) = 0.316 mW/g; SAR(10 g) = 0.201 mW/g

Maximum value of SAR (measured) = 0.340 W/kg

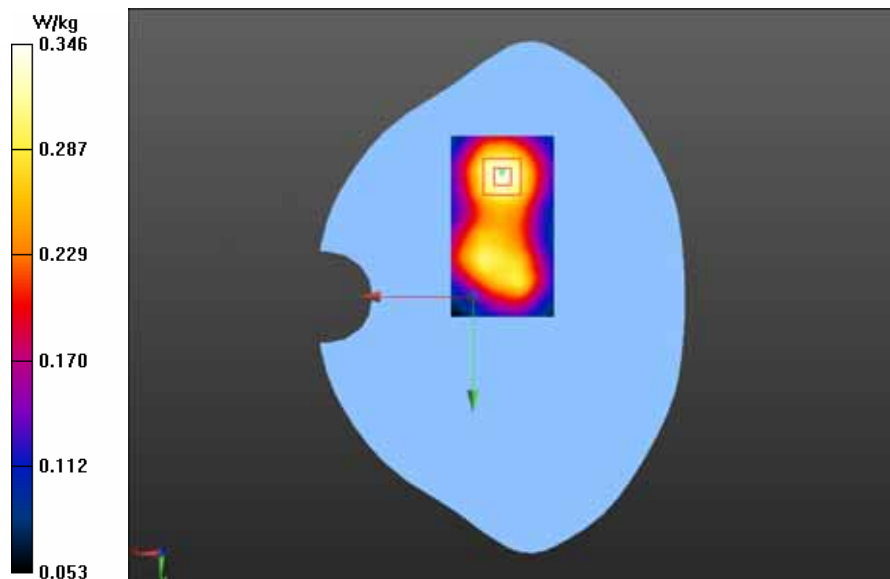

Test Laboratory: GCCT

Test Date: Apr.27, 2013

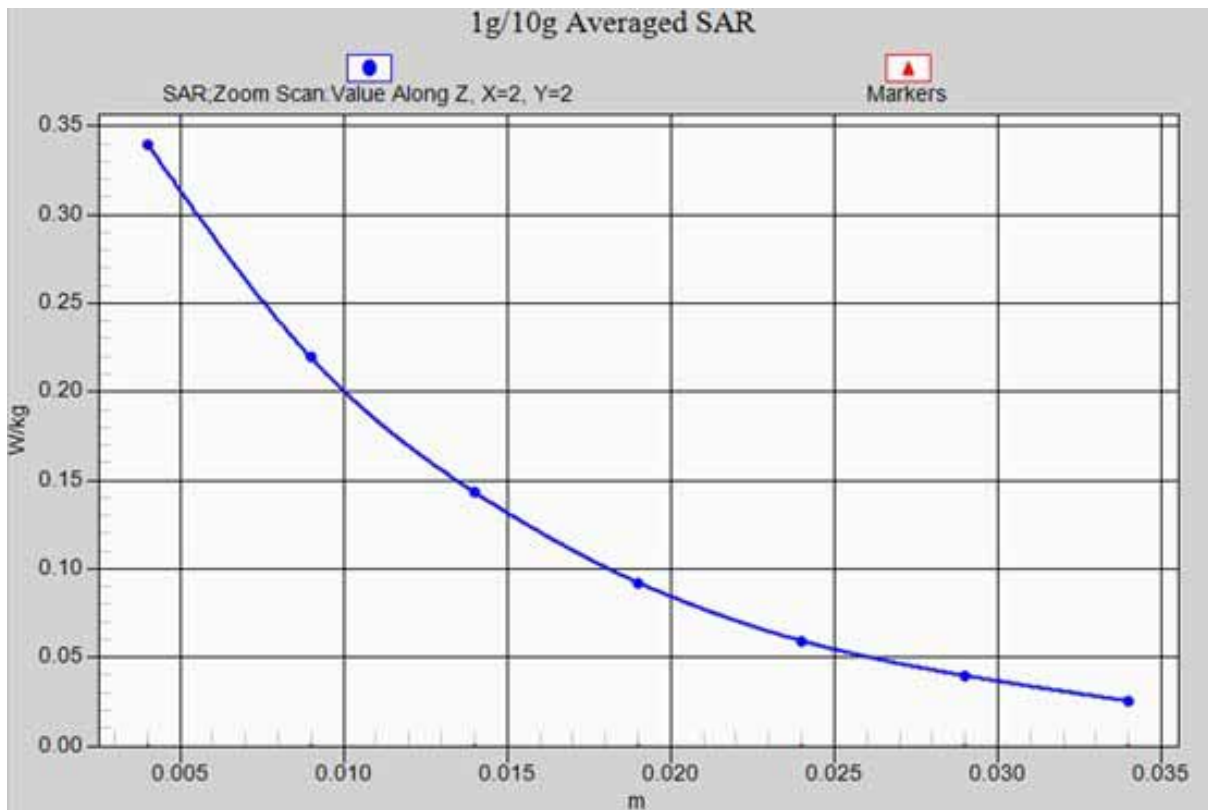

GPRS1900/Back side-High_ z-axis scan

Test Laboratory: GCCT

Test Date: Apr.27, 2013

GPRS1900/Back side-Mid

DUT: Bmobile; Type: QS304

Communication System: GPRS(3slots); Communication System Band: PCS 1900;
Frequency: 1880 MHz; Communication System PAR: 4.44 dB

Medium parameters used: $f = 1880$ MHz; $\sigma = 1.557$ mho/m; $\epsilon_r = 50.765$; $\rho = 1000$ kg/m³

Phantom section: Flat Section

Measurement Standard: DASY5 (IEEE/IEC/ANSI C63.19-2007)

DASY5 Configuration:

- Probe: ES3DV3 - SN3221; ConvF(4.87, 4.87, 4.87); Calibrated: 9/27/2012;
- Sensor-Surface: 4mm (Mechanical Surface Detection)
- Electronics: DAE4 Sn893; Calibrated: 9/27/2012
- Phantom: SAM_1 with CRP v4.0; Type: QD000P40CC; Serial: TP:1586
- Measurement SW: DASY52, Version 52.8 (2); SEMCAD X Version 14.6.6 (6824)

GPRS1900/Back side-Mid/Area Scan (41x71x1): Interpolated grid: dx=1.500 mm, dy=1.500 mm

Reference Value = 11.295 V/m; Power Drift = 0.07 dB

Maximum value of SAR (interpolated) = 0.326 W/kg

GPRS1900/Back side-Mid/Zoom Scan (5x5x7)/Cube 0: Measurement grid:

dx=8mm, dy=8mm, dz=5mm

Reference Value = 11.295 V/m; Power Drift = 0.07 dB

Peak SAR (extrapolated) = 0.462 mW/g

SAR(1 g) = 0.304 mW/g; SAR(10 g) = 0.194 mW/g

Maximum value of SAR (measured) = 0.328 W/kg

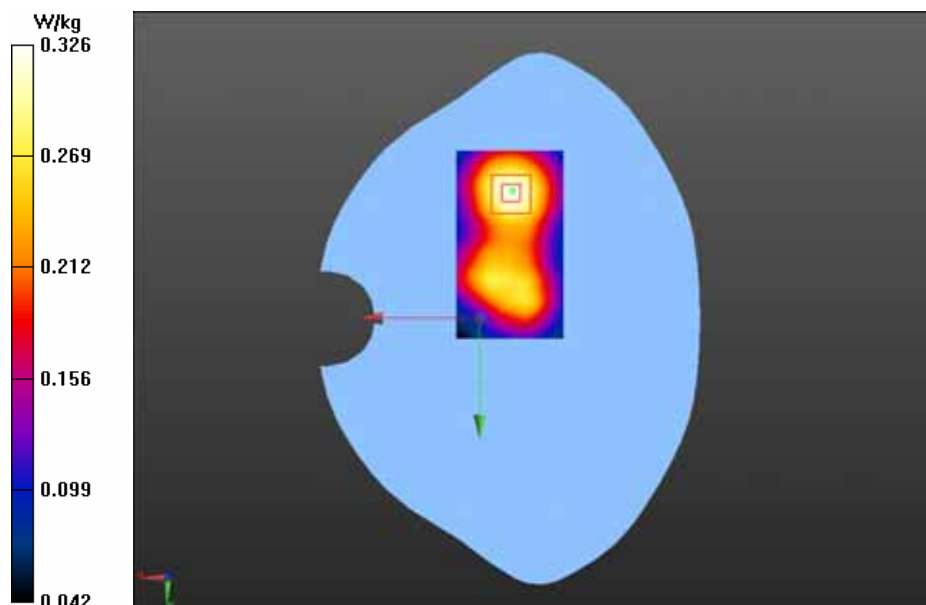

Test Laboratory: GCCT

Test Date: Apr.27, 2013

GPRS1900/Back side-Low

DUT: Bmobile; Type: QS304

Communication System: GPRS(4slots); Communication System Band: PCS1900;
Frequency: 1850.2 MHz; Communication System PAR: 3.181 dB

Medium parameters used (interpolated): $f = 1850.2$ MHz; $\sigma = 1.525$ mho/m; $\epsilon_r = 50.831$; $\rho = 1000$ kg/m³

Phantom section: Flat Section

Measurement Standard: DASY5 (IEEE/IEC/ANSI C63.19-2007)

DASY5 Configuration:

- Probe: ES3DV3 - SN3221; ConvF(4.87, 4.87, 4.87); Calibrated: 9/27/2012;
- Sensor-Surface: 4mm (Mechanical Surface Detection)
- Electronics: DAE4 Sn893; Calibrated: 9/27/2012
- Phantom: SAM_1 with CRP v4.0; Type: QD000P40CC; Serial: TP:1586
- Measurement SW: DASY52, Version 52.8 (2); SEMCAD X Version 14.6.6 (6824)

GPRS1900/Back side-Low/Area Scan (41x71x1): Interpolated grid: dx=1.500 mm, dy=1.500 mm

Reference Value = 11.145 V/m; Power Drift = -0.08 dB

Maximum value of SAR (interpolated) = 0.340 W/kg

GPRS1900/Back side-Low/Zoom Scan (5x5x7)/Cube 0: Measurement grid:

dx=8mm, dy=8mm, dz=5mm

Reference Value = 11.145 V/m; Power Drift = -0.08 dB

Peak SAR (extrapolated) = 0.464 mW/g

SAR(1 g) = 0.311 mW/g; SAR(10 g) = 0.199 mW/g

Maximum value of SAR (measured) = 0.333 W/kg

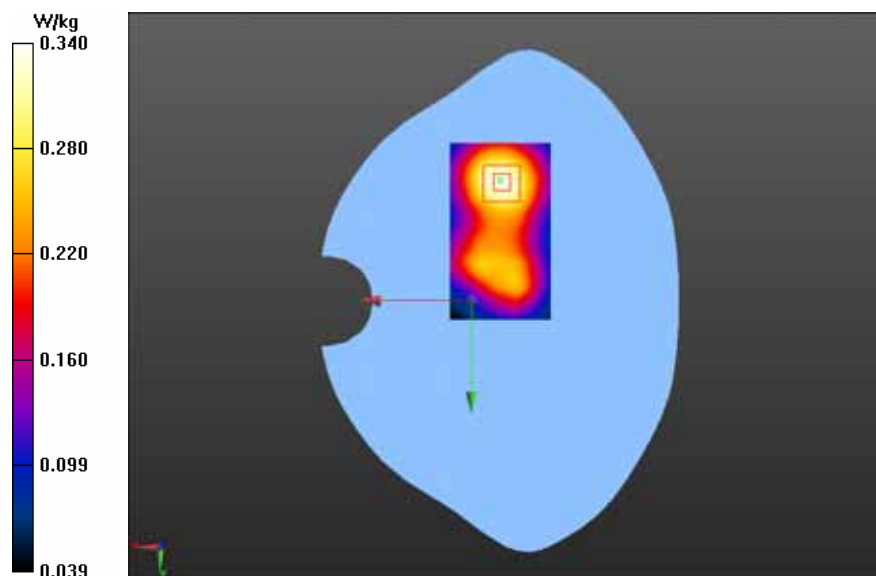

Test Laboratory: GCCT

Test Date: Apr.27, 2013

GPRS1900/Front side-Low

DUT: Bmobile; Type: QS304

Communication System: GPRS(4slots); Communication System Band: PCS1900;
Frequency: 1850.2 MHz; Communication System PAR: 3.181 dB

Medium parameters used (interpolated): $f = 1850.2$ MHz; $\sigma = 1.525$ mho/m; $\epsilon_r = 50.831$; $\rho = 1000$ kg/m³

Phantom section: Flat Section

Measurement Standard: DASY5 (IEEE/IEC/ANSI C63.19-2007)

DASY5 Configuration:

- Probe: ES3DV3 - SN3221; ConvF(4.87, 4.87, 4.87); Calibrated: 9/27/2012;
- Sensor-Surface: 4mm (Mechanical Surface Detection)
- Electronics: DAE4 Sn893; Calibrated: 9/27/2012
- Phantom: SAM_1 with CRP v4.0; Type: QD000P40CC; Serial: TP:1586
- Measurement SW: DASY52, Version 52.8 (2); SEMCAD X Version 14.6.6 (6824)

GPRS1900/Front side-Low/Area Scan (41x71x1): Interpolated grid: dx=1.500 mm, dy=1.500 mm

Reference Value = 8.157 V/m; Power Drift = 0.10 dB

Maximum value of SAR (interpolated) = 0.160 W/kg

GPRS1900/Front side-Low/Zoom Scan (5x5x7)/Cube 0: Measurement grid:

dx=8mm, dy=8mm, dz=5mm

Reference Value = 8.157 V/m; Power Drift = 0.10 dB

Peak SAR (extrapolated) = 0.218 mW/g

SAR(1 g) = 0.144 mW/g; SAR(10 g) = 0.092 mW/g

Maximum value of SAR (measured) = 0.154 W/kg

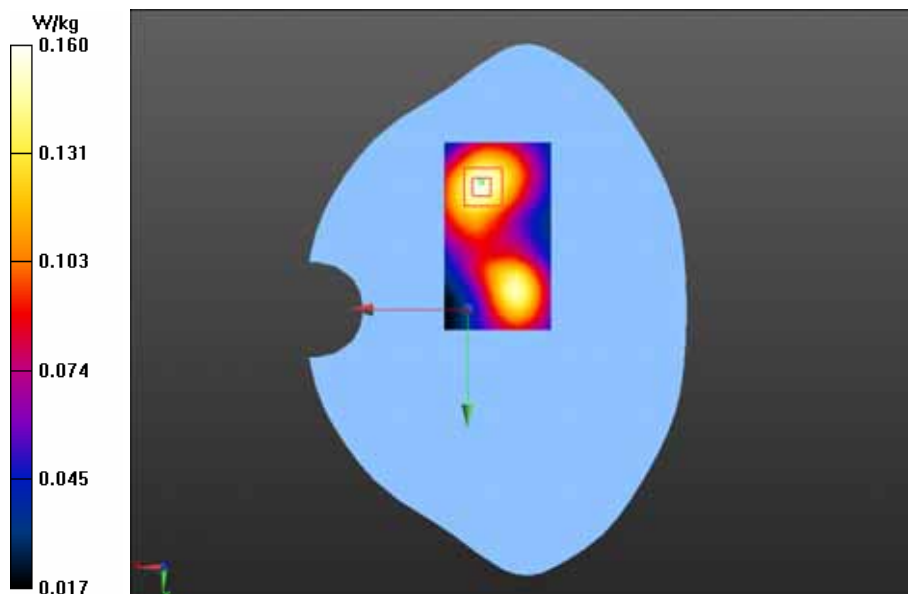

ANNEXE 3 EUT Test Positions

Test Position:

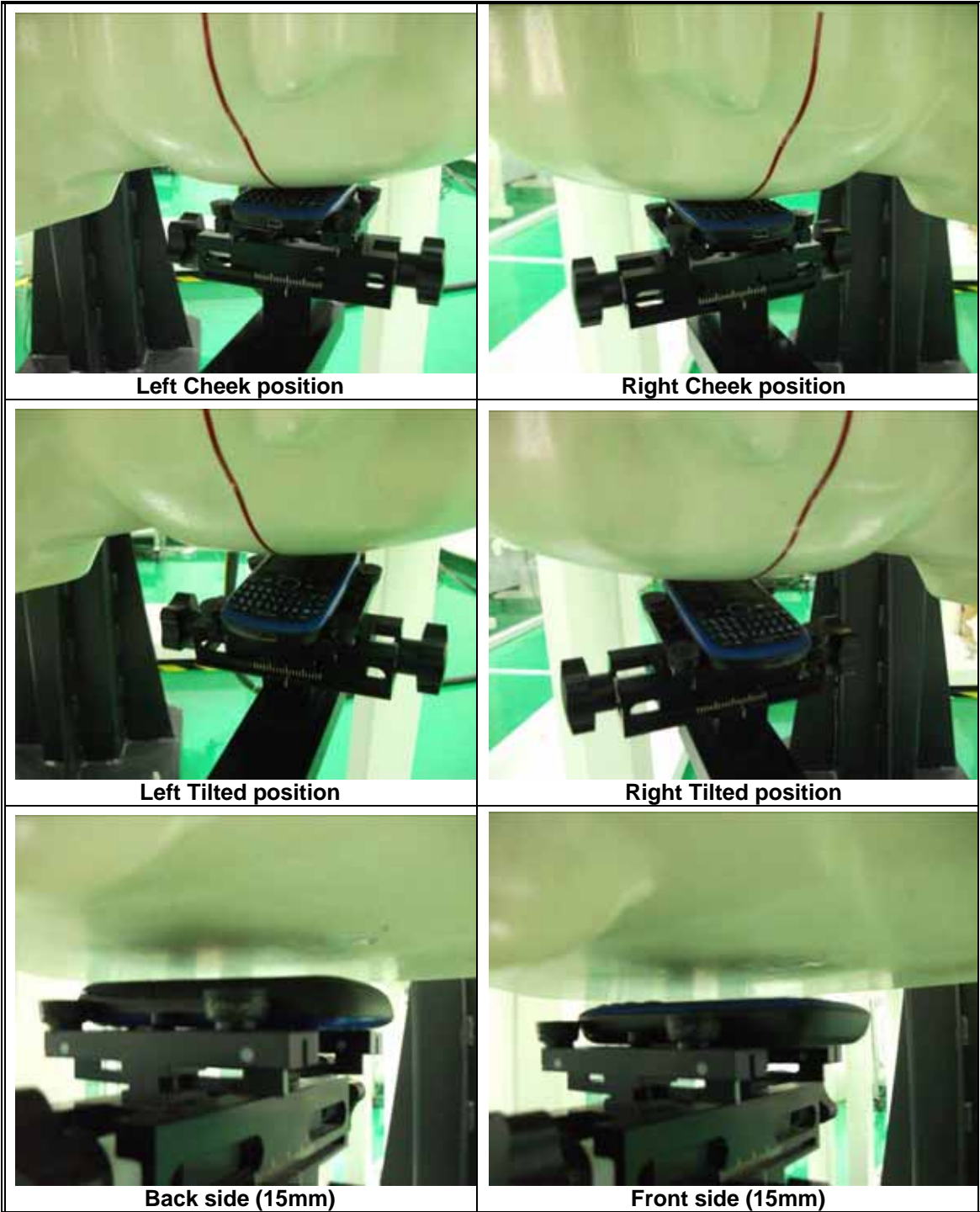

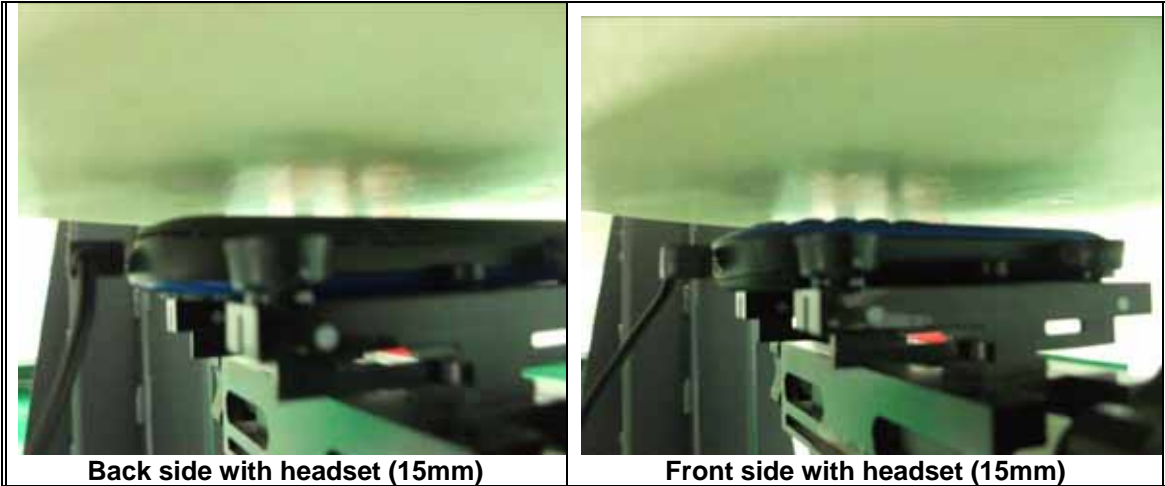

ANNEXE 4 Probe calibration report

**Calibration Laboratory of
Schmid & Partner
Engineering AG**
Zeughausstrasse 43, 8004 Zurich, Switzerland



S Schweizerischer Kalibrierdienst
C Service suisse d'étalonnage
S Servizio svizzero di taratura
Swiss Calibration Service

Accredited by the Swiss Accreditation Service (SAS)
The Swiss Accreditation Service is one of the signatories to the EA
Multilateral Agreement for the recognition of calibration certificates

Accreditation No.: **SCS 108**

Client **GCCT (Auden)**

Certificate No: **ES3-3221_Sep12**

CALIBRATION CERTIFICATE

Object: **ES3DV3 - SN:3221**

Calibration procedure(s): **QA CAL-01.v8, QA CAL-23.v4, QA CAL-25.v4
Calibration procedure for dosimetric E-field probes**

Calibration date: **September 27, 2012**

This calibration certificate documents the traceability to national standards, which realize the physical units of measurements (SI).
The measurements and the uncertainties with confidence probability are given on the following pages and are part of the certificate.

All calibrations have been conducted in the closed laboratory facility: environment temperature (22 ± 3)°C and humidity < 70%.

Calibration Equipment used (M&TE critical for calibration)

Primary Standards	ID	Cal Date (Certificate No.)	Scheduled Calibration
Power meter E4419B	GB41293874	29-Mar-12 (No. 217-01508)	Apr-13
Power sensor E4412A	MY41498087	29-Mar-12 (No. 217-01508)	Apr-13
Reference 3 dB Attenuator	SN: S5054 (3c)	27-Mar-12 (No. 217-01531)	Apr-13
Reference 20 dB Attenuator	SN: S5086 (20b)	27-Mar-12 (No. 217-01529)	Apr-13
Reference 30 dB Attenuator	SN: S5129 (30b)	27-Mar-12 (No. 217-01532)	Apr-13
Reference Probe ES3DV2	SN: 3013	29-Dec-11 (No. ES3-3013_Dec11)	Dec-12
DAE4	SN: 660	20-Jun-12 (No. DAE4-660_Jun12)	Jun-13
Secondary Standards	ID	Check Date (in house)	Scheduled Check
RF generator HP 8648C	US3642U01700	4-Aug-99 (in house check Apr-11)	In house check: Apr-13
Network Analyzer HP 8753E	US37390585	18-Oct-01 (in house check Oct-11)	In house check: Oct-12

	Name	Function	Signature
Calibrated by:	Jeton Kasrati	Laboratory Technician	
Approved by:	Katja Pokovic	Technical Manager	

Issued: October 1, 2012

This calibration certificate shall not be reproduced except in full without written approval of the laboratory.

Calibration Laboratory of
Schmid & Partner
Engineering AG
Zeughausstrasse 43, 8004 Zurich, Switzerland



S Schweizerischer Kalibrierdienst
C Service suisse d'étalonnage
S Servizio svizzero di taratura
Swiss Calibration Service

Accredited by the Swiss Accreditation Service (SAS)
The Swiss Accreditation Service is one of the signatories to the EA
Multilateral Agreement for the recognition of calibration certificates

Accreditation No.: **SCS 108**

Glossary:

TSL	tissue simulating liquid
NORM _{x,y,z}	sensitivity in free space
ConvF	sensitivity in TSL / NORM _{x,y,z}
DCP	diode compression point
CF	crest factor (1/duty_cycle) of the RF signal
A, B, C	modulation dependent linearization parameters
Polarization φ	φ rotation around probe axis
Polarization ϑ	ϑ rotation around an axis that is in the plane normal to probe axis (at measurement center), i.e., $\vartheta = 0$ is normal to probe axis

Calibration is Performed According to the Following Standards:

- IEEE Std 1528-2003, "IEEE Recommended Practice for Determining the Peak Spatial-Averaged Specific Absorption Rate (SAR) in the Human Head from Wireless Communications Devices: Measurement Techniques", December 2003
- IEC 62209-1, "Procedure to measure the Specific Absorption Rate (SAR) for hand-held devices used in close proximity to the ear (frequency range of 300 MHz to 3 GHz)", February 2005

Methods Applied and Interpretation of Parameters:

- NORM_{x,y,z}**: Assessed for E-field polarization $\vartheta = 0$ ($f \leq 900$ MHz in TEM-cell; $f > 1800$ MHz: R22 waveguide). NORM_{x,y,z} are only intermediate values, i.e., the uncertainties of NORM_{x,y,z} does not affect the E²-field uncertainty inside TSL (see below ConvF).
- NORM(f)_{x,y,z}** = NORM_{x,y,z} * frequency_response (see Frequency Response Chart). This linearization is implemented in DASY4 software versions later than 4.2. The uncertainty of the frequency response is included in the stated uncertainty of ConvF.
- DCP_{x,y,z}**: DCP are numerical linearization parameters assessed based on the data of power sweep with CW signal (no uncertainty required). DCP does not depend on frequency nor media.
- PAR**: PAR is the Peak to Average Ratio that is not calibrated but determined based on the signal characteristics
- A_{x,y,z}; B_{x,y,z}; C_{x,y,z}; VR_{x,y,z}; A, B, C** are numerical linearization parameters assessed based on the data of power sweep for specific modulation signal. The parameters do not depend on frequency nor media. VR is the maximum calibration range expressed in RMS voltage across the diode.
- ConvF and Boundary Effect Parameters**: Assessed in flat phantom using E-field (or Temperature Transfer Standard for $f \leq 800$ MHz) and inside waveguide using analytical field distributions based on power measurements for $f > 800$ MHz. The same setups are used for assessment of the parameters applied for boundary compensation (alpha, depth) of which typical uncertainty values are given. These parameters are used in DASY4 software to improve probe accuracy close to the boundary. The sensitivity in TSL corresponds to NORM_{x,y,z} * ConvF whereby the uncertainty corresponds to that given for ConvF. A frequency dependent ConvF is used in DASY version 4.4 and higher which allows extending the validity from ± 50 MHz to ± 100 MHz.
- Spherical isotropy (3D deviation from isotropy)**: in a field of low gradients realized using a flat phantom exposed by a patch antenna.
- Sensor Offset**: The sensor offset corresponds to the offset of virtual measurement center from the probe tip (on probe axis). No tolerance required.

ES3DV3 – SN:3221

September 27, 2012

Probe ES3DV3

SN:3221

Manufactured:	September 1, 2009
Repaired:	September 11, 2012
Calibrated:	September 27, 2012

Calibrated for DASY/EASY Systems
(Note: non-compatible with DASY2 system!)

ES3DV3- SN:3221

September 27, 2012

DASY/EASY - Parameters of Probe: ES3DV3 - SN:3221

Basic Calibration Parameters

	Sensor X	Sensor Y	Sensor Z	Unc (k=2)
Norm ($\mu\text{V}/(\text{V/m})^2$) ^A	1.11	1.38	1.06	$\pm 10.1\%$
DCP (mV) ^B	103.6	100.4	103.1	

Modulation Calibration Parameters

UID	Communication System Name	PAR		A dB	B dB	C dB	VR mV	Unc ^E (k=2)
0	CW	0.00	X	0.00	0.00	1.00	144.5	$\pm 3.5\%$
			Y	0.00	0.00	1.00	122.0	
			Z	0.00	0.00	1.00	143.2	

The reported uncertainty of measurement is stated as the standard uncertainty of measurement multiplied by the coverage factor k=2, which for a normal distribution corresponds to a coverage probability of approximately 95%.

^A The uncertainties of NormX,Y,Z do not affect the E²-field uncertainty inside TSL (see Pages 5 and 6).

^B Numerical linearization parameter: uncertainty not required.

^E Uncertainty is determined using the max. deviation from linear response applying rectangular distribution and is expressed for the square of the field value.

ES3DV3- SN:3221

September 27, 2012

DASY/EASY - Parameters of Probe: ES3DV3 - SN:3221

Calibration Parameter Determined in Head Tissue Simulating Media

f (MHz) ^C	Relative Permittivity ^F	Conductivity (S/m) ^F	ConvF X	ConvF Y	ConvF Z	Alpha	Depth (mm)	Unct. (k=2)
835	41.5	0.90	6.20	6.20	6.20	0.25	2.17	± 12.0 %
900	41.5	0.97	6.17	6.17	6.17	0.27	1.99	± 12.0 %
1750	40.1	1.37	5.60	5.60	5.60	0.80	1.16	± 12.0 %
1900	40.0	1.40	5.39	5.39	5.39	0.62	1.40	± 12.0 %
2000	40.0	1.40	5.34	5.34	5.34	0.76	1.22	± 12.0 %
2450	39.2	1.80	4.68	4.68	4.68	0.80	1.24	± 12.0 %

^C Frequency validity of ± 100 MHz only applies for DASY v4.4 and higher (see Page 2), else it is restricted to ± 50 MHz. The uncertainty is the RSS of the ConvF uncertainty at calibration frequency and the uncertainty for the indicated frequency band.

^F At frequencies below 3 GHz, the validity of tissue parameters (ϵ and σ) can be relaxed to ± 10% if liquid compensation formula is applied to measured SAR values. At frequencies above 3 GHz, the validity of tissue parameters (ϵ and σ) is restricted to ± 5%. The uncertainty is the RSS of the ConvF uncertainty for indicated target tissue parameters.

ES3DV3– SN:3221

September 27, 2012

DASY/EASY - Parameters of Probe: ES3DV3 - SN:3221

Calibration Parameter Determined in Body Tissue Simulating Media

f (MHz) ^c	Relative Permittivity ^f	Conductivity (S/m) ^f	ConvF X	ConvF Y	ConvF Z	Alpha	Depth (mm)	Unct. (k=2)
835	55.2	0.97	6.23	6.23	6.23	0.37	1.80	± 12.0 %
900	55.0	1.05	6.17	6.17	6.17	0.80	1.16	± 12.0 %
1750	53.4	1.49	5.17	5.17	5.17	0.59	1.46	± 12.0 %
1900	53.3	1.52	4.87	4.87	4.87	0.46	1.73	± 12.0 %
2000	53.3	1.52	4.89	4.89	4.89	0.64	1.49	± 12.0 %
2450	52.7	1.95	4.31	4.31	4.31	0.68	1.16	± 12.0 %

^c Frequency validity of ± 100 MHz only applies for DASY v4.4 and higher (see Page 2), else it is restricted to ± 50 MHz. The uncertainty is the RSS of the ConvF uncertainty at calibration frequency and the uncertainty for the indicated frequency band.

^f At frequencies below 3 GHz, the validity of tissue parameters (ϵ and σ) can be relaxed to ± 10% if liquid compensation formula is applied to measured SAR values. At frequencies above 3 GHz, the validity of tissue parameters (ϵ and σ) is restricted to ± 5%. The uncertainty is the RSS of the ConvF uncertainty for indicated target tissue parameters.

ES3DV3-SN:3221

September 27, 2012

Frequency Response of E-Field (TEM-Cell:ifi110 EXX, Waveguide: R22)

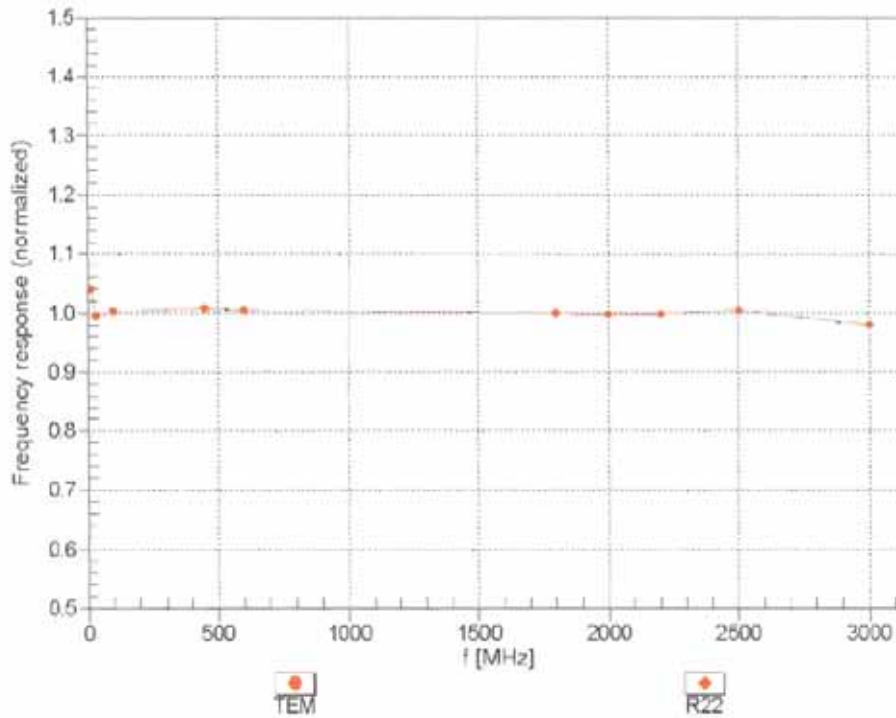

Uncertainty of Frequency Response of E-field: $\pm 6.3\%$ (k=2)

ES3DV3- SN:3221

September 27, 2012

Receiving Pattern (ϕ), $\theta = 0^\circ$

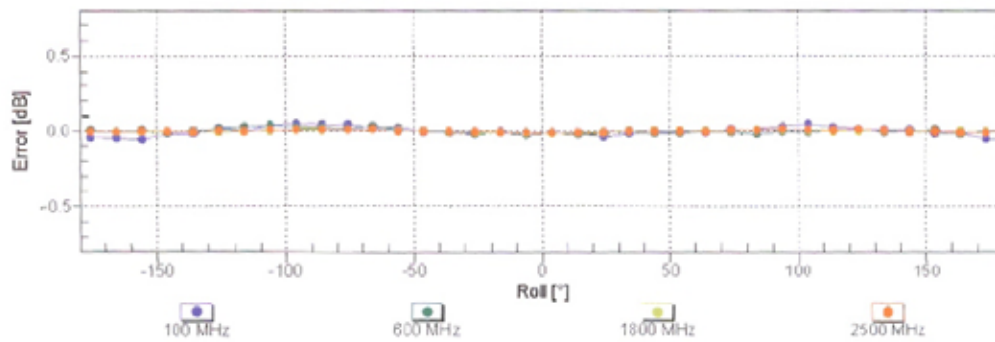
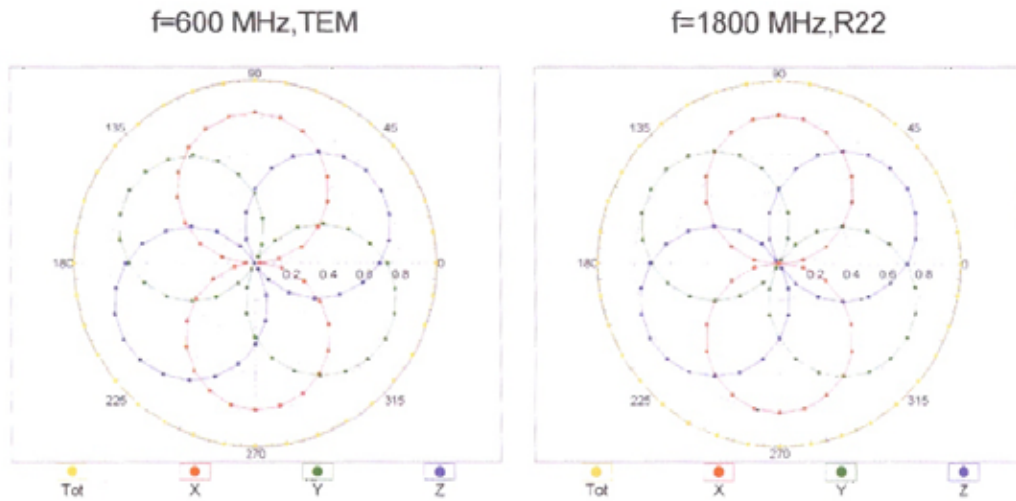

Uncertainty of Axial Isotropy Assessment: $\pm 0.5\%$ ($k=2$)

ES30V3- SN:3221

September 27, 2012

Dynamic Range $f(\text{SAR}_{\text{head}})$ (TEM cell, $f = 900 \text{ MHz}$)

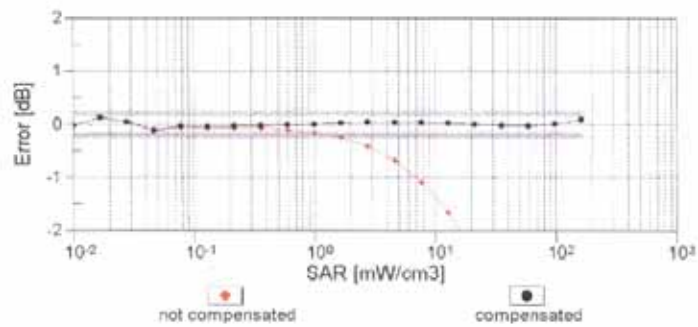
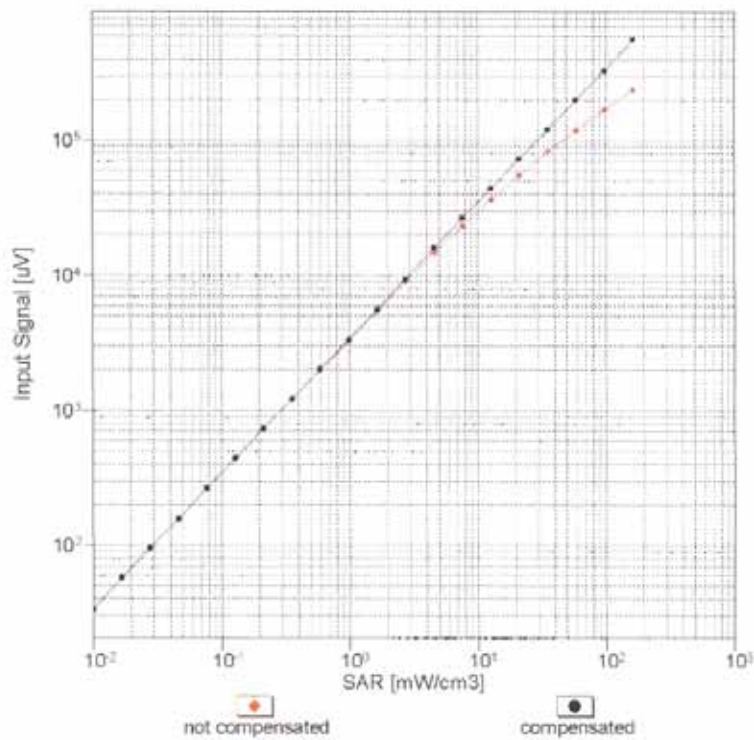

Uncertainty of Linearity Assessment: $\pm 0.6\%$ ($k=2$)

ES3DV3-SN:3221

September 27, 2012

Conversion Factor Assessment

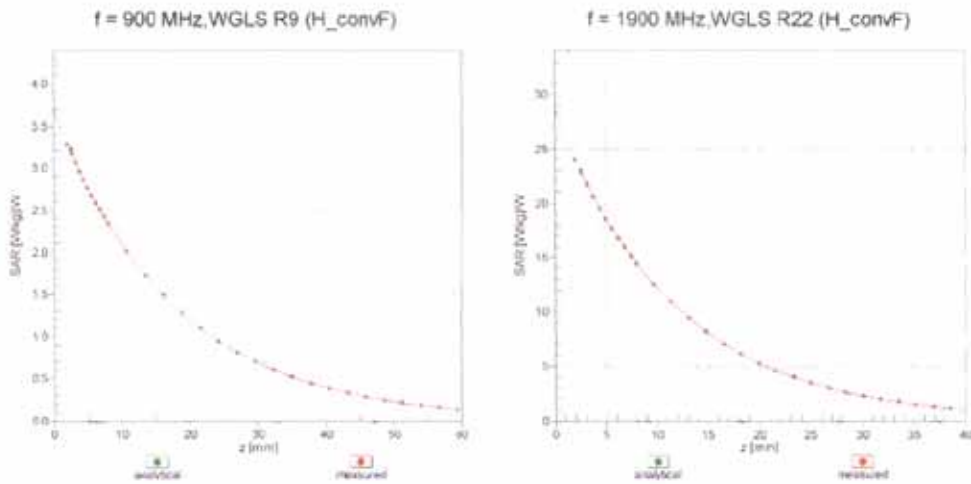

Deviation from Isotropy in Liquid

Error (ϕ, θ), f = 900 MHz

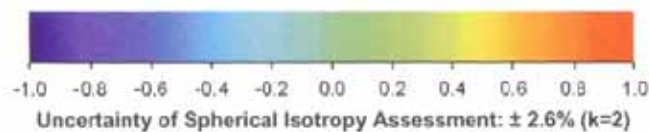
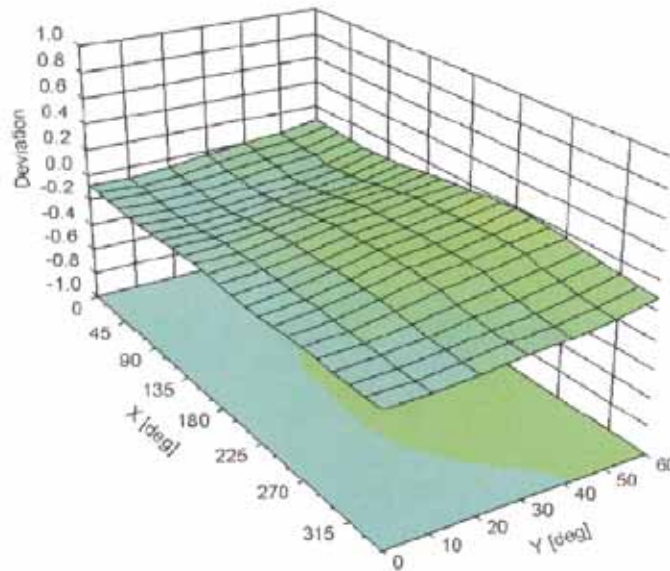

ES3DV3- SN:3221

September 27, 2012

DASY/EASY - Parameters of Probe: ES3DV3 - SN:3221

Other Probe Parameters

Sensor Arrangement	Triangular
Connector Angle (°)	34
Mechanical Surface Detection Mode	enabled
Optical Surface Detection Mode	disabled
Probe Overall Length	337 mm
Probe Body Diameter	10 mm
Tip Length	10 mm
Tip Diameter	4 mm
Probe Tip to Sensor X Calibration Point	2 mm
Probe Tip to Sensor Y Calibration Point	2 mm
Probe Tip to Sensor Z Calibration Point	2 mm
Recommended Measurement Distance from Surface	3 mm

ANNEXE 5 Dipole calibration report

Calibration Laboratory of
Schmid & Partner
Engineering AG
Zeughausstrasse 43, 8004 Zurich, Switzerland



S Schweizerischer Kalibrierdienst
C Service suisse d'étalonnage
S Servizio svizzero di taratura
S Swiss Calibration Service

Accredited by the Swiss Accreditation Service (SAS)
The Swiss Accreditation Service is one of the signatories to the EA
Multilateral Agreement for the recognition of calibration certificates

Accreditation No.: **SCS 108**

Client **GCCT (Auden)**

Certificate No: **D900V2-1d073_Sep12**

CALIBRATION CERTIFICATE

Object **D900V2 - SN: 1d073**

Calibration procedure(s) **QA CAL-05.v8
Calibration procedure for dipole validation kits above 700 MHz**

Calibration date: **September 28, 2012**

This calibration certificate documents the traceability to national standards, which realize the physical units of measurements (SI).
The measurements and the uncertainties with confidence probability are given on the following pages and are part of the certificate.

All calibrations have been conducted in the closed laboratory facility: environment temperature (22 ± 3)°C and humidity < 70%.

Calibration Equipment used (M&TE critical for calibration)

Primary Standards	ID #	Cal Date (Certificate No.)	Scheduled Calibration
Power meter EPM-442A	GB37480704	05-Oct-11 (No. 217-01451)	Oct-12
Power sensor HP 8481A	US37292783	05-Oct-11 (No. 217-01451)	Oct-12
Reference 20 dB Attenuator	SN: 5058 (20k)	27-Mar-12 (No. 217-01530)	Apr-13
Type-N mismatch combination	SN: 5047.2 / 06327	27-Mar-12 (No. 217-01533)	Apr-13
Reference Probe ES30V3	SN: 3205	30-Dec-11 (No. ESS-3205_Dec11)	Dec-12
DAE4	SN: 601	27-Jun-12 (No. DAE4-601_Jun12)	Jun-13
Secondary Standards	ID #	Check Date (in house)	Scheduled Check
Power sensor HP 8481A	MY41092317	18-Oct-02 (in house check Oct-11)	In house check: Oct-13
RF generator R&S SMT-05	100005	04-Aug-99 (in house check Oct-11)	In house check: Oct-13
Network Analyzer HP 8753E	US37390585 S4205	18-Oct-01 (in house check Oct-11)	In house check: Oct-12

Calibrated by: **Israe El-Naouq** (Name) / **Laboratory Technician** (Function) / *Israe El-Naouq* (Signature)

Approved by: **Katja Pokovic** (Name) / **Technical Manager** (Function) / *Katja Pokovic* (Signature)

Issued: September 28, 2012

This calibration certificate shall not be reproduced except in full without written approval of the laboratory.

**Calibration Laboratory of
Schmid & Partner
Engineering AG**
Zeughausstrasse 43, 8004 Zurich, Switzerland



S Schweizerischer Kalibrierdienst
C Service suisse d'étalonnage
S Servizio svizzero di taratura
S Swiss Calibration Service

Accredited by the Swiss Accreditation Service (SAS)

The Swiss Accreditation Service is one of the signatories to the EA
Multilateral Agreement for the recognition of calibration certificates

Accreditation No.: **SCS 108**

Glossary:

TSL	tissue simulating liquid
ConvF	sensitivity in TSL / NORM x,y,z
N/A	not applicable or not measured

Calibration is Performed According to the Following Standards:

- IEEE Std 1528-2003, "IEEE Recommended Practice for Determining the Peak Spatial-Averaged Specific Absorption Rate (SAR) in the Human Head from Wireless Communications Devices: Measurement Techniques", December 2003
- IEC 62209-1, "Procedure to measure the Specific Absorption Rate (SAR) for hand-held devices used in close proximity to the ear (frequency range of 300 MHz to 3 GHz)", February 2005
- Federal Communications Commission Office of Engineering & Technology (FCC OET), "Evaluating Compliance with FCC Guidelines for Human Exposure to Radiofrequency Electromagnetic Fields; Additional Information for Evaluating Compliance of Mobile and Portable Devices with FCC Limits for Human Exposure to Radiofrequency Emissions", Supplement C (Edition 01-01) to Bulletin 65

Additional Documentation:

- DASY4/5 System Handbook

Methods Applied and Interpretation of Parameters:

- Measurement Conditions:** Further details are available from the Validation Report at the end of the certificate. All figures stated in the certificate are valid at the frequency indicated.
- Antenna Parameters with TSL:** The dipole is mounted with the spacer to position its feed point exactly below the center marking of the flat phantom section, with the arms oriented parallel to the body axis.
- Feed Point Impedance and Return Loss:** These parameters are measured with the dipole positioned under the liquid filled phantom. The impedance stated is transformed from the measurement at the SMA connector to the feed point. The Return Loss ensures low reflected power. No uncertainty required.
- Electrical Delay:** One-way delay between the SMA connector and the antenna feed point. No uncertainty required.
- SAR measured:** SAR measured at the stated antenna input power.
- SAR normalized:** SAR as measured, normalized to an input power of 1 W at the antenna connector.
- SAR for nominal TSL parameters:** The measured TSL parameters are used to calculate the nominal SAR result.

The reported uncertainty of measurement is stated as the standard uncertainty of measurement multiplied by the coverage factor $k=2$, which for a normal distribution corresponds to a coverage probability of approximately 95%.

Measurement Conditions

DASY system configuration, as far as not given on page 1.

DASY Version	DASY5	V52.8.2
Extrapolation	Advanced Extrapolation	
Phantom	Modular Flat Phantom	
Distance Dipole Center - TSL	15 mm	with Spacer
Zoom Scan Resolution	dx, dy, dz = 5 mm	
Frequency	900 MHz \pm 1 MHz	

Head TSL parameters

The following parameters and calculations were applied.

	Temperature	Permittivity	Conductivity
Nominal Head TSL parameters	22.0 °C	41.5	0.97 mho/m
Measured Head TSL parameters	(22.0 \pm 0.2) °C	40.3 \pm 6 %	0.96 mho/m \pm 6 %
Head TSL temperature change during test	< 0.5 °C	----	----

SAR result with Head TSL

SAR averaged over 1 cm ³ (1 g) of Head TSL	Condition	
SAR measured	250 mW input power	2.68 mW / g
SAR for nominal Head TSL parameters	normalized to 1W	10.7 mW / g \pm 17.0 % (k=2)

SAR averaged over 10 cm ³ (10 g) of Head TSL	condition	
SAR measured	250 mW input power	1.72 mW / g
SAR for nominal Head TSL parameters	normalized to 1W	6.89 mW / g \pm 16.5 % (k=2)

Body TSL parameters

The following parameters and calculations were applied.

	Temperature	Permittivity	Conductivity
Nominal Body TSL parameters	22.0 °C	55.0	1.05 mho/m
Measured Body TSL parameters	(22.0 \pm 0.2) °C	52.7 \pm 6 %	1.06 mho/m \pm 6 %
Body TSL temperature change during test	< 0.5 °C	----	----

SAR result with Body TSL

SAR averaged over 1 cm ³ (1 g) of Body TSL	Condition	
SAR measured	250 mW input power	2.81 mW / g
SAR for nominal Body TSL parameters	normalized to 1W	11.1 mW / g \pm 17.0 % (k=2)

SAR averaged over 10 cm ³ (10 g) of Body TSL	condition	
SAR measured	250 mW input power	1.80 mW / g
SAR for nominal Body TSL parameters	normalized to 1W	7.12 mW / g \pm 16.5 % (k=2)

Appendix

Antenna Parameters with Head TSL

Impedance, transformed to feed point	49.5 Ω - 7.6 j Ω
Return Loss	- 22.3 dB

Antenna Parameters with Body TSL

Impedance, transformed to feed point	46.6 Ω - 8.9 j Ω
Return Loss	- 20.2 dB

General Antenna Parameters and Design

Electrical Delay (one direction)	1.407 ns
----------------------------------	----------

After long term use with 100W radiated power, only a slight warming of the dipole near the feedpoint can be measured.

The dipole is made of standard semirigid coaxial cable. The center conductor of the feeding line is directly connected to the second arm of the dipole. The antenna is therefore short-circuited for DC-signals. On some of the dipoles, small end caps are added to the dipole arms in order to improve matching when loaded according to the position as explained in the "Measurement Conditions" paragraph. The SAR data are not affected by this change. The overall dipole length is still according to the Standard.

No excessive force must be applied to the dipole arms, because they might bend or the soldered connections near the feedpoint may be damaged.

Additional EUT Data

Manufactured by	SPEAG
Manufactured on	January 29, 2008

DASY5 Validation Report for Head TSL

Date: 28.09.2012

Test Laboratory: SPEAG, Zurich, Switzerland

DUT: Dipole 900 MHz; Type: D900V2; Serial: D900V2 - SN: 1d073

Communication System: CW; Frequency: 900 MHz

Medium parameters used: $f = 900$ MHz; $\sigma = 0.96$ mho/m; $\epsilon_r = 40.3$; $\rho = 1000$ kg/m³

Phantom section: Flat Section

Measurement Standard: DASY5 (IEEE/IEC/ANSI C63.19-2007)

DASY52 Configuration:

- Probe: ES3DV3 - SN3205; ConvF(5.97, 5.97, 5.97); Calibrated: 30.12.2011;
- Sensor-Surface: 3mm (Mechanical Surface Detection)
- Electronics: DAE4 Sn601; Calibrated: 27.06.2012
- Phantom: Flat Phantom 4.9L; Type: QD000P49AA; Serial: 1001
- DASY52 52.8.2(969); SEMCAD X 14.6.6(6824)

Dipole Calibration for Head Tissue/Pin=250 mW, d=15mm/Zoom Scan (7x7x7)/Cube 0:

Measurement grid: dx=5mm, dy=5mm, dz=5mm

Reference Value = 57.155 V/m; Power Drift = 0.01 dB

Peak SAR (extrapolated) = 4.031 mW/g

SAR(1 g) = 2.68 mW/g; SAR(10 g) = 1.72 mW/g

Maximum value of SAR (measured) = 3.11 W/kg

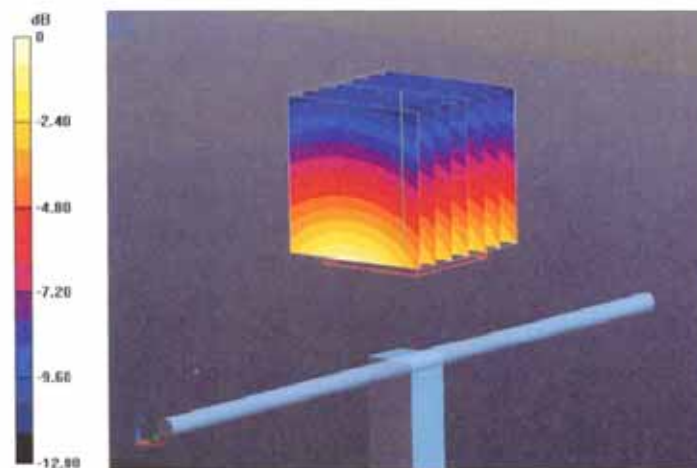

0 dB = 3.11 W/kg = 9.86 dB W/kg

Impedance Measurement Plot for Head TSL

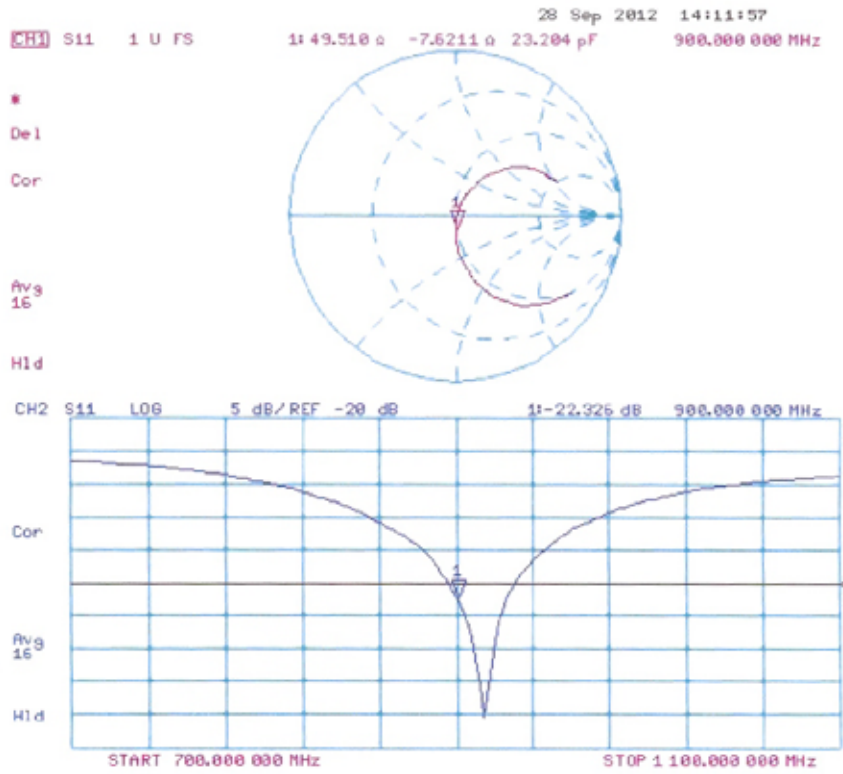

DASY5 Validation Report for Body TSL

Date: 28.09.2012

Test Laboratory: SPEAG, Zurich, Switzerland

DUT: Dipole 900 MHz; Type: D900V2; Serial: D900V2 - SN: 1d073

Communication System: CW; Frequency: 900 MHz

Medium parameters used: $f = 900$ MHz; $\sigma = 1.06$ mho/m; $\epsilon_r = 52.7$; $\rho = 1000$ kg/m³

Phantom section: Flat Section

Measurement Standard: DASY5 (IEEE/IEC/ANSI C63.19-2007)

DASY52 Configuration:

- Probe: ES3DV3 - SN3205; ConvF(5.94, 5.94, 5.94); Calibrated: 30.12.2011;
- Sensor-Surface: 3mm (Mechanical Surface Detection)
- Electronics: DAE4 Sn601; Calibrated: 27.06.2012
- Phantom: Flat Phantom 4.9L; Type: QD000P49AA; Serial: 1001
- DASY52 52.8.2(969); SEMCAD X 14.6.6(6824)

Dipole Calibration for Body Tissue/Pin=250 mW, d=15mm/Zoom Scan (7x7x7)/Cube 0:

Measurement grid: dx=5mm, dy=5mm, dz=5mm

Reference Value = 57.155 V/m; Power Drift = 0.01 dB

Peak SAR (extrapolated) = 4.294 mW/g

SAR(1 g) = 2.81 mW/g; SAR(10 g) = 1.8 mW/g

Maximum value of SAR (measured) = 3.29 W/kg

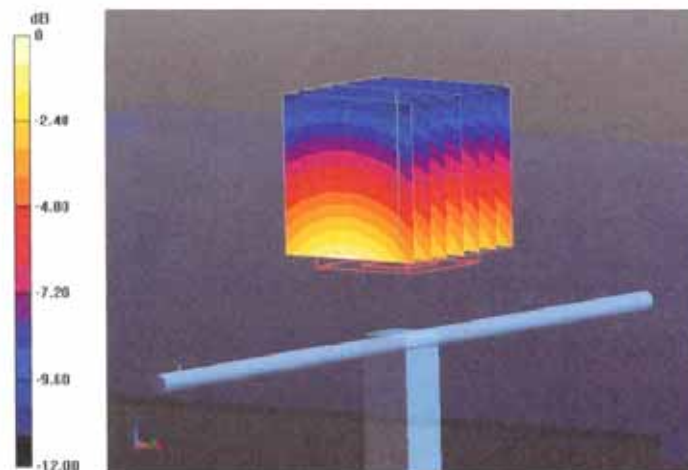

0 dB = 3.29 W/kg = 10.34 dB W/kg

Impedance Measurement Plot for Body TSL

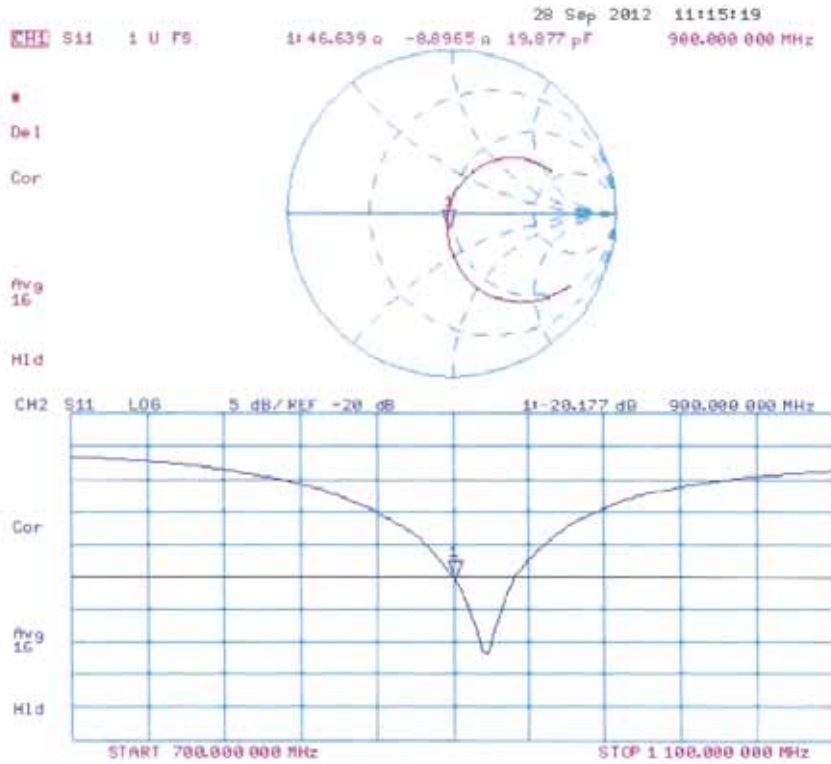

Calibration Laboratory of
Schmid & Partner
Engineering AG
Zeughausstrasse 43, 8004 Zurich, Switzerland



S Schweizerischer Kalibrierdienst
S Service suisse d'étalonnage
S Servizio svizzero di taratura
S Swiss Calibration Service

Accredited by the Swiss Accreditation Service (SAS)
The Swiss Accreditation Service is one of the signatories to the EA
Multilateral Agreement for the recognition of calibration certificates

Accreditation No.: **SCS 108**

Client **GCCT (Auden)**

Certificate No: **D1900V2-5d070_Oct12**

CALIBRATION CERTIFICATE

Object **D1900V2 - SN: 5d070**

Calibration procedure(s) **QA CAL-05.v8
Calibration procedure for dipole validation kits above 700 MHz**

Calibration date: **October 01, 2012**

This calibration certificate documents the traceability to national standards, which realize the physical units of measurements (SI).
The measurements and the uncertainties with confidence probability are given on the following pages and are part of the certificate.

All calibrations have been conducted in the closed laboratory facility: environment temperature $(22 \pm 3)^\circ\text{C}$ and humidity $< 70\%$.

Calibration Equipment used (M&TE critical for calibration)

Primary Standards	ID #	Cal Date (Certificate No.)	Scheduled Calibration
Power meter EPM-442A	GB37480704	05-Oct-11 (No. 217-01451)	Oct-12
Power sensor HP B481A	US37292783	05-Oct-11 (No. 217-01451)	Oct-12
Reference 20 dB Attenuator	SN: 5058 (20k)	27-Mar-12 (No. 217-01530)	Apr-13
Type-N mismatch combination	SN: 5047.2 / 06327	27-Mar-12 (No. 217-01533)	Apr-13
Reference Probe ES3DV3	SN: 3205	30-Dec-11 (No. ES3-3205_Dec11)	Dec-12
DAE4	SN: 801	27-Jun-12 (No. DAE4-601_Jun12)	Jun-13
Secondary Standards	ID #	Check Date (in house)	Scheduled Check
Power sensor HP B481A	MY41092317	18-Oct-02 (in house check Oct-11)	In house check: Oct-13
RF generator R&S SMT-06	100005	04-Aug-99 (in house check Oct-11)	In house check: Oct-13
Network Analyzer HP B753E	US37390585 S4206	18-Oct-01 (in house check Oct-11)	In house check: Oct-12

Calibrated by:	Name Israe El-Naouq	Function Laboratory Technician	Signature
Approved by:	Katja Pokovic	Technical Manager	

Issued: October 2, 2012

This calibration certificate shall not be reproduced except in full without written approval of the laboratory.

**Calibration Laboratory of
Schmid & Partner
Engineering AG**
Zeughausstrasse 43, 8004 Zurich, Switzerland



S Schweizerischer Kalibrierdienst
C Service suisse d'étalonnage
S Servizio svizzero di taratura
S Swiss Calibration Service

Accredited by the Swiss Accreditation Service (SAS)

Accreditation No.: **SCS 108**

The Swiss Accreditation Service is one of the signatories to the EA
Multilateral Agreement for the recognition of calibration certificates

Glossary:

TSL	tissue simulating liquid
ConvF	sensitivity in TSL / NORM x,y,z
N/A	not applicable or not measured

Calibration is Performed According to the Following Standards:

- IEEE Std 1528-2003, "IEEE Recommended Practice for Determining the Peak Spatial-Averaged Specific Absorption Rate (SAR) in the Human Head from Wireless Communications Devices: Measurement Techniques", December 2003
- IEC 62209-1, "Procedure to measure the Specific Absorption Rate (SAR) for hand-held devices used in close proximity to the ear (frequency range of 300 MHz to 3 GHz)", February 2005
- Federal Communications Commission Office of Engineering & Technology (FCC OET), "Evaluating Compliance with FCC Guidelines for Human Exposure to Radiofrequency Electromagnetic Fields; Additional Information for Evaluating Compliance of Mobile and Portable Devices with FCC Limits for Human Exposure to Radiofrequency Emissions", Supplement C (Edition 01-01) to Bulletin 65

Additional Documentation:

- DASY4/5 System Handbook

Methods Applied and Interpretation of Parameters:

- Measurement Conditions:* Further details are available from the Validation Report at the end of the certificate. All figures stated in the certificate are valid at the frequency indicated.
- Antenna Parameters with TSL:* The dipole is mounted with the spacer to position its feed point exactly below the center marking of the flat phantom section, with the arms oriented parallel to the body axis.
- Feed Point Impedance and Return Loss:* These parameters are measured with the dipole positioned under the liquid filled phantom. The impedance stated is transformed from the measurement at the SMA connector to the feed point. The Return Loss ensures low reflected power. No uncertainty required.
- Electrical Delay:* One-way delay between the SMA connector and the antenna feed point. No uncertainty required.
- SAR measured:* SAR measured at the stated antenna input power.
- SAR normalized:* SAR as measured, normalized to an input power of 1 W at the antenna connector.
- SAR for nominal TSL parameters:* The measured TSL parameters are used to calculate the nominal SAR result.

The reported uncertainty of measurement is stated as the standard uncertainty of measurement multiplied by the coverage factor $k=2$, which for a normal distribution corresponds to a coverage probability of approximately 95%.

Measurement Conditions

DASY system configuration, as far as not given on page 1.

DASY Version	DASY5	V52.8.2
Extrapolation	Advanced Extrapolation	
Phantom	Modular Flat Phantom	
Distance Dipole Center - TSL	10 mm	with Spacer
Zoom Scan Resolution	dx, dy, dz = 5 mm	
Frequency	1900 MHz \pm 1 MHz	

Head TSL parameters

The following parameters and calculations were applied.

	Temperature	Permittivity	Conductivity
Nominal Head TSL parameters	22.0 °C	40.0	1.40 mho/m
Measured Head TSL parameters	(22.0 \pm 0.2) °C	40.6 \pm 6 %	1.37 mho/m \pm 6 %
Head TSL temperature change during test	< 0.5 °C	----	----

SAR result with Head TSL

SAR averaged over 1 cm ³ (1 g) of Head TSL	Condition	
SAR measured	250 mW input power	9.89 mW / g
SAR for nominal Head TSL parameters	normalized to 1W	40.2 mW / g \pm 17.0 % (k=2)

SAR averaged over 10 cm ³ (10 g) of Head TSL	condition	
SAR measured	250 mW input power	5.22 mW / g
SAR for nominal Head TSL parameters	normalized to 1W	21.1 mW / g \pm 16.5 % (k=2)

Body TSL parameters

The following parameters and calculations were applied.

	Temperature	Permittivity	Conductivity
Nominal Body TSL parameters	22.0 °C	53.3	1.52 mho/m
Measured Body TSL parameters	(22.0 \pm 0.2) °C	52.5 \pm 6 %	1.54 mho/m \pm 6 %
Body TSL temperature change during test	< 0.5 °C	----	----

SAR result with Body TSL

SAR averaged over 1 cm ³ (1 g) of Body TSL	Condition	
SAR measured	250 mW input power	10.3 mW / g
SAR for nominal Body TSL parameters	normalized to 1W	40.7 mW / g \pm 17.0 % (k=2)

SAR averaged over 10 cm ³ (10 g) of Body TSL	condition	
SAR measured	250 mW input power	5.47 mW / g
SAR for nominal Body TSL parameters	normalized to 1W	21.7 mW / g \pm 16.5 % (k=2)

Appendix

Antenna Parameters with Head TSL

Impedance, transformed to feed point	52.7 Ω + 4.7 j Ω
Return Loss	- 25.5 dB

Antenna Parameters with Body TSL

Impedance, transformed to feed point	48.5 Ω + 5.8 j Ω
Return Loss	- 24.4 dB

General Antenna Parameters and Design

Electrical Delay (one direction)	1.196 ns
----------------------------------	----------

After long term use with 100W radiated power, only a slight warming of the dipole near the feedpoint can be measured.

The dipole is made of standard semirigid coaxial cable. The center conductor of the feeding line is directly connected to the second arm of the dipole. The antenna is therefore short-circuited for DC-signals. On some of the dipoles, small end caps are added to the dipole arms in order to improve matching when loaded according to the position as explained in the "Measurement Conditions" paragraph. The SAR data are not affected by this change. The overall dipole length is still according to the Standard.

No excessive force must be applied to the dipole arms, because they might bend or the soldered connections near the feedpoint may be damaged.

Additional EUT Data

Manufactured by	SPEAG
Manufactured on	January 24, 2006

DASY5 Validation Report for Head TSL

Date: 01.10.2012

Test Laboratory: SPEAG, Zurich, Switzerland

DUT: Dipole 1900 MHz; Type: D1900V2; Serial: D1900V2 - SN: 5d070

Communication System: CW; Frequency: 1900 MHz

Medium parameters used: $f = 1900$ MHz; $\sigma = 1.37$ mho/m; $\epsilon_r = 40.6$; $\rho = 1000$ kg/m³

Phantom section: Flat Section

Measurement Standard: DASY5 (IEEE/IEC/ANSI C63.19-2007)

DASY52 Configuration:

- Probe: ES3DV3 - SN3205; ConvF(5.01, 5.01, 5.01); Calibrated: 30.12.2011;
- Sensor-Surface: 3mm (Mechanical Surface Detection)
- Electronics: DAE4 Sn601; Calibrated: 27.06.2012
- Phantom: Flat Phantom 5.0 (front); Type: QD000P50AA; Serial: 1001
- DASY52 52.8.2(969); SEMCAD X 14.6.6(6824)

Dipole Calibration for Head Tissue/Pin=250 mW, d=10mm/Zoom Scan (7x7x7)/Cube 0:

Measurement grid: dx=5mm, dy=5mm, dz=5mm

Reference Value = 95.678 V/m; Power Drift = 0.07 dB

Peak SAR (extrapolated) = 17.559 mW/g

SAR(1 g) = 9.89 mW/g; SAR(10 g) = 5.22 mW/g

Maximum value of SAR (measured) = 12.2 W/kg

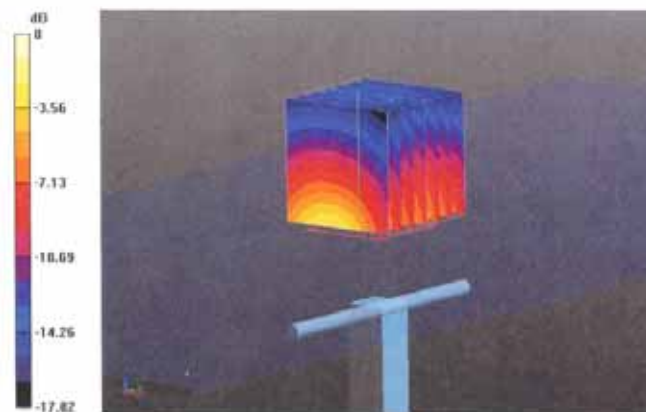

0 dB = 12.2 W/kg = 21.73 dB W/kg

Impedance Measurement Plot for Head TSL

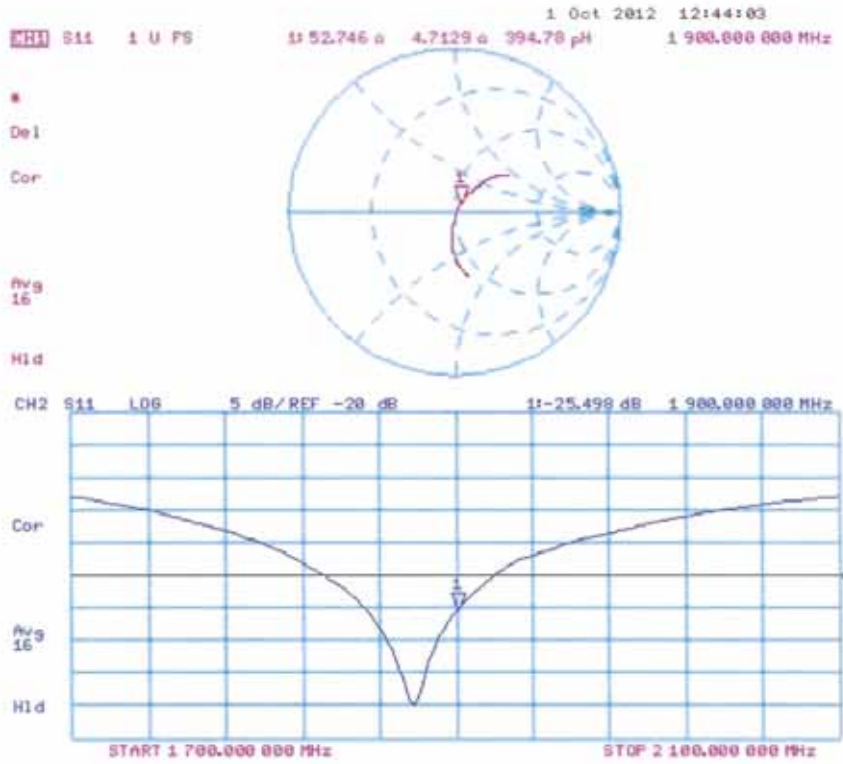

DASY5 Validation Report for Body TSL

Date: 01.10.2012

Test Laboratory: SPEAG, Zurich, Switzerland

DUT: Dipole 1900 MHz; Type: D1900V2; Serial: D1900V2 - SN: 5d070

Communication System: CW; Frequency: 1900 MHz

Medium parameters used: $f = 1900$ MHz; $\sigma = 1.54$ mho/m; $\epsilon_r = 52.5$; $\rho = 1000$ kg/m³

Phantom section: Flat Section

Measurement Standard: DASY5 (IEEE/IEC/ANSI C63.19-2007)

DASY52 Configuration:

- Probe: ES3DV3 - SN3205; ConvF(4.62, 4.62, 4.62); Calibrated: 30.12.2011;
- Sensor-Surface: 3mm (Mechanical Surface Detection)
- Electronics: DAE4 Sn601; Calibrated: 27.06.2012
- Phantom: Flat Phantom 5.0 (back); Type: QD000P50AA; Serial: 1002
- DASY52 52.8.2(969); SEMCAD X 14.6.6(6824)

Dipole Calibration for Body Tissue/Pin=250 mW, d=10mm/Zoom Scan (7x7x7)/Cube 0:

Measurement grid: dx=5mm, dy=5mm, dz=5mm

Reference Value = 95.678 V/m; Power Drift = -0.00 dB

Peak SAR (extrapolated) = 18.097 mW/g

SAR(1 g) = 10.3 mW/g; SAR(10 g) = 5.47 mW/g

Maximum value of SAR (measured) = 13.0 W/kg

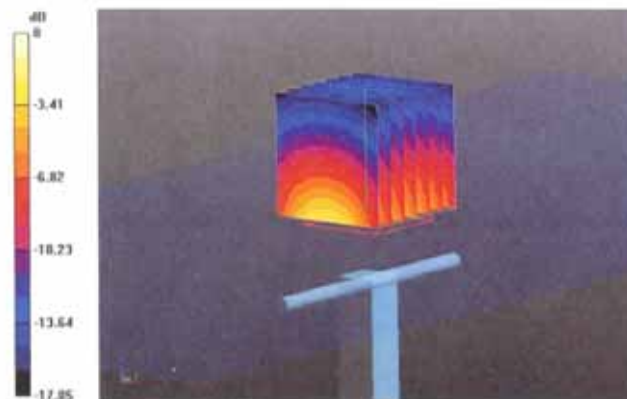

0 dB = 13.0 W/kg = 22.28 dB W/kg

Impedance Measurement Plot for Body TSL

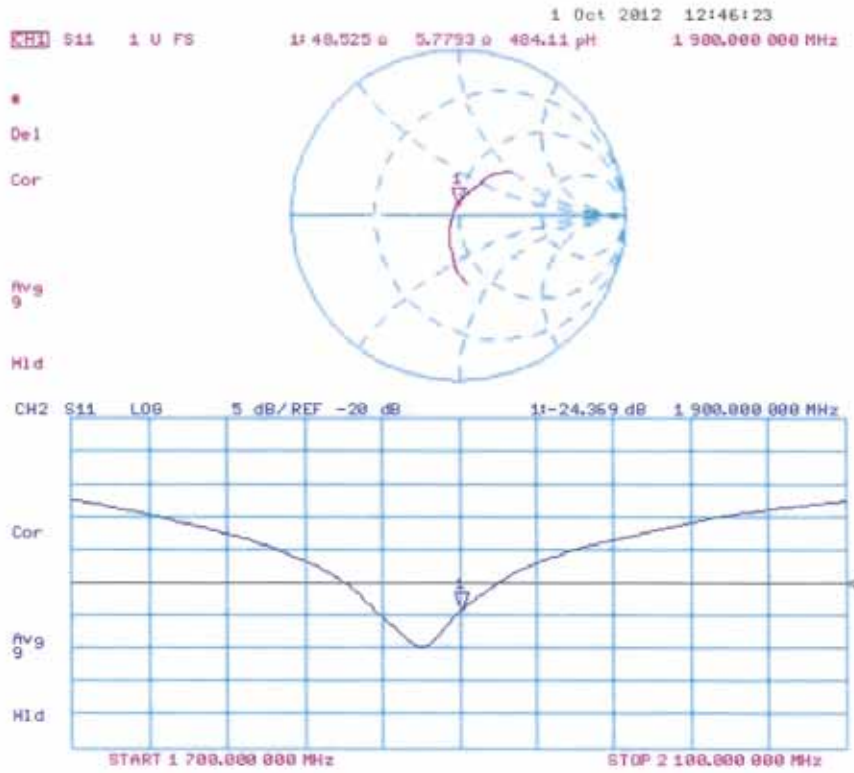

ANNEXE 6 DAE calibration report

**Calibration Laboratory of
Schmid & Partner
Engineering AG**
Zeughausstrasse 43, 8004 Zurich, Switzerland



S Schweizerischer Kalibrierdienst
S Service suisse d'étalonnage
C Servizio svizzero di taratura
S Swiss Calibration Service

Accredited by the Swiss Accreditation Service (SAS)

Accreditation No.: **SCS 108**

The Swiss Accreditation Service is one of the signatories to the EA
Multilateral Agreement for the recognition of calibration certificates

Client **GCCT (Auden)**

Certificate No: **DAE4-893_Sep12**

CALIBRATION CERTIFICATE

Object: **DAE4 - SD 000 D04 BJ - SN: 893**

Calibration procedure(s): **QA CAL-06.v25
Calibration procedure for the data acquisition electronics (DAE)**

Calibration date: **September 27, 2012**

This calibration certificate documents the traceability to national standards, which realize the physical units of measurements (SI).
The measurements and the uncertainties with confidence probability are given on the following pages and are part of the certificate.

All calibrations have been conducted in the closed laboratory facility: environment temperature (22 ± 3)°C and humidity < 70%.

Calibration Equipment used (M&TE critical for calibration)

Primary Standards	ID #	Cal Date (Certificate No.)	Scheduled Calibration
Keithley Multimeter Type 2001	SN: 0810278	28-Sep-11 (No.11450)	Sep-12
Secondary Standards	ID #	Check Date (in house)	Scheduled Check
Calibrator Box V2.1	SE UWS 053 AA 1001	05-Jan-12 (in house check)	In house check: Jan-13

	Name	Function	Signature
Calibrated by:	Eric Hainfeld	Technician	
Approved by:	Fin Bomholt	R&D Director	

Issued: September 27, 2012

This calibration certificate shall not be reproduced except in full without written approval of the laboratory.

**Calibration Laboratory of
Schmid & Partner
Engineering AG**
Zeughausstrasse 43, 8004 Zurich, Switzerland



S Schweizerischer Kalibrierdienst
C Service suisse d'étalonnage
S Servizio svizzero di taratura
S Swiss Calibration Service

Accredited by the Swiss Accreditation Service (SAS)
The Swiss Accreditation Service is one of the signatories to the EA
Multilateral Agreement for the recognition of calibration certificates

Accreditation No.: **SCS 108**

Glossary

DAE data acquisition electronics
Connector angle information used in DASY system to align probe sensor X to the robot coordinate system.

Methods Applied and Interpretation of Parameters

- *DC Voltage Measurement*: Calibration Factor assessed for use in DASY system by comparison with a calibrated instrument traceable to national standards. The figure given corresponds to the full scale range of the voltmeter in the respective range.
- *Connector angle*: The angle of the connector is assessed measuring the angle mechanically by a tool inserted. Uncertainty is not required.
- The following parameters as documented in the Appendix contain technical information as a result from the performance test and require no uncertainty.
 - *DC Voltage Measurement Linearity*: Verification of the Linearity at +10% and -10% of the nominal calibration voltage. Influence of offset voltage is included in this measurement.
 - *Common mode sensitivity*: Influence of a positive or negative common mode voltage on the differential measurement.
 - *Channel separation*: Influence of a voltage on the neighbor channels not subject to an input voltage.
 - *AD Converter Values with inputs shorted*: Values on the internal AD converter corresponding to zero input voltage
 - *Input Offset Measurement*: Output voltage and statistical results over a large number of zero voltage measurements.
 - *Input Offset Current*: Typical value for information; Maximum channel input offset current, not considering the input resistance.
 - *Input resistance*: Typical value for information: DAE input resistance at the connector, during internal auto-zeroing and during measurement.
 - *Low Battery Alarm Voltage*: Typical value for information. Below this voltage, a battery alarm signal is generated.
 - *Power consumption*: Typical value for information. Supply currents in various operating modes.

DC Voltage Measurement

A/D - Converter Resolution nominal

High Range: 1LSB = 6.1 μ V, full range = -100...+300 mV

Low Range: 1LSB = 61nV, full range = -1.....+3mV

DASY measurement parameters: Auto Zero Time: 3 sec; Measuring time: 3 sec

Calibration Factors	X	Y	Z
High Range	406.225 \pm 0.1% (k=2)	406.084 \pm 0.1% (k=2)	405.117 \pm 0.1% (k=2)
Low Range	4.01000 \pm 0.7% (k=2)	4.02161 \pm 0.7% (k=2)	3.98512 \pm 0.7% (k=2)

Connector Angle

Connector Angle to be used in DASY system	174.5 \pm 1 $^{\circ}$
---	--------------------------

Appendix

1. DC Voltage Linearity

High Range	Reading (μV)	Difference (μV)	Error (%)
Channel X + Input	199995.97	-2.11	-0.00
Channel X + Input	20003.49	2.31	0.01
Channel X - Input	-19996.34	3.89	-0.02
Channel Y + Input	199996.46	-1.92	-0.00
Channel Y + Input	19999.56	-1.41	-0.01
Channel Y - Input	-20000.29	0.07	-0.00
Channel Z + Input	199997.57	-0.73	-0.00
Channel Z + Input	19998.79	-2.14	-0.01
Channel Z - Input	-20001.40	-1.01	0.01

Low Range	Reading (μV)	Difference (μV)	Error (%)
Channel X + Input	2003.38	2.07	0.10
Channel X + Input	202.34	0.57	0.28
Channel X - Input	-197.99	0.01	-0.01
Channel Y + Input	2002.03	0.81	0.04
Channel Y + Input	200.97	-0.69	-0.34
Channel Y - Input	-198.23	0.01	-0.01
Channel Z + Input	2002.07	0.82	0.04
Channel Z + Input	201.75	0.14	0.07
Channel Z - Input	-200.05	-1.79	0.90

2. Common mode sensitivity

DASY measurement parameters: Auto Zero Time: 3 sec; Measuring time: 3 sec

	Common mode Input Voltage (mV)	High Range Average Reading (μV)	Low Range Average Reading (μV)
Channel X	200	17.36	15.93
	- 200	-15.52	-16.86
Channel Y	200	7.39	6.92
	- 200	-8.23	-8.65
Channel Z	200	5.62	5.64
	- 200	-8.03	-8.06

3. Channel separation

DASY measurement parameters: Auto Zero Time: 3 sec; Measuring time: 3 sec

	Input Voltage (mV)	Channel X (μV)	Channel Y (μV)	Channel Z (μV)
Channel X	200	-	3.18	-3.22
Channel Y	200	8.71	-	3.65
Channel Z	200	9.66	6.68	-

4. AD-Converter Values with inputs shorted

DASY measurement parameters: Auto Zero Time: 3 sec; Measuring time: 3 sec

	High Range (LSB)	Low Range (LSB)
Channel X	16472	14639
Channel Y	16065	13652
Channel Z	15699	15904

5. Input Offset Measurement

DASY measurement parameters: Auto Zero Time: 3 sec; Measuring time: 3 sec

Input 10M Ω

	Average (μ V)	min. Offset (μ V)	max. Offset (μ V)	Std. Deviation (μ V)
Channel X	0.78	-1.09	2.36	0.66
Channel Y	-0.06	-2.31	2.02	0.70
Channel Z	-0.52	-2.78	1.43	0.74

6. Input Offset Current

Nominal input circuitry offset current on all channels: <25/A

7. Input Resistance (Typical values for information)

	Zeroing (kOhm)	Measuring (MOhm)
Channel X	200	200
Channel Y	200	200
Channel Z	200	200

8. Low Battery Alarm Voltage (Typical values for information)

Typical values	Alarm Level (VDC)
Supply (+ Vcc)	+7.9
Supply (- Vcc)	-7.6

9. Power Consumption (Typical values for information)

Typical values	Switched off (mA)	Stand by (mA)	Transmitting (mA)
Supply (+ Vcc)	+0.01	+6	+14
Supply (- Vcc)	-0.01	-8	-9