

b mobile HK Limited

GSM Mobile Phone



Model: LQ310
Serial Model: QS302

May 18th 2012
Report No.: 12050036-FCC-H
(This report supersedes NONE)

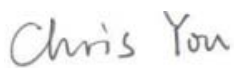

Modifications made to the product : None

This Test Report is Issued Under the Authority of:

		
Chris You Test Engineer	Alex Liu Technical Manager	

This test report may be reproduced in full only.
All Test Data Presented in this report is only applicable to presented Test sample.

SAR Test Report

To: C95.1, IEEE 1528, OET Bulletin 65 Suppl. C, IEC 62209-2, RSS 102 and Safety Code 6

SIEMIC, INC.
Accessing global markets



Laboratory Introduction

SIEMIC, headquartered in the heart of Silicon Valley, with superior facilities in US and Asia, is one of the leading independent testing and certification facilities providing customers with one-stop shop services for Compliance Testing and Global Certifications.



In addition to [testing](#) and [certification](#), SIEMIC provides initial design reviews and [compliance management](#) through out a project. Our extensive experience with [China](#), [Asia Pacific](#), [North America](#), [European](#), and [international](#) compliance requirements, assures the fastest, most cost effective way to attain regulatory compliance for the [global markets](#).

Accreditations for Conformity Assessment

Country/Region	Accreditation Body	Scope
USA	FCC, A2LA	EMC , RF/Wireless , Telecom
Canada	IC, A2LA, NIST	EMC, RF/Wireless , Telecom
Taiwan	BSMI , NCC , NIST	EMC, RF, Telecom , Safety
Hong Kong	OFTA , NIST	RF/Wireless , Telecom
Australia	NATA, NIST	EMC, RF, Telecom , Safety
Korea	KCC/RRA, NIST	EMI, EMS, RF , Telecom, Safety
Japan	VCCI, JATE, TELEC, RFT	EMI, RF/Wireless, Telecom
Mexico	NOM, COFETEL, Caniety	Safety, EMC , RF/Wireless, Telecom
Europe	A2LA, NIST	EMC, RF, Telecom , Safety

Accreditations for Product Certifications

Country	Accreditation Body	Scope
USA	FCC TCB, NIST	EMC , RF , Telecom
Canada	IC FCB , NIST	EMC , RF , Telecom
Singapore	iDA, NIST	EMC , RF , Telecom
EU	NB, NIST	EMC,RF,Safety,Telecom

This page has been left blank intentionally.

CONTENTS

1 EXECUTIVE SUMMARY & EUT INFORMATION.....6

2 TECHNICAL DETAILS.....7

3 INTRODUCTION8

4 SAR MEASUREMENT SETUP9

5 ANSI/IEEE C95.1 – 1999 RF EXPOSURE LIMIT20

6 SYSTEM AND LIQUID VALIDATION21

7 UNCERTAINTY ASSESSMENT.....29

8 OUTPUT POWER VERIFICATION.....31

9 SAR TEST RESULTS33

10 SAR MEASUREMENT REFERENCES.....36

ANNEX A. TEST INSTRUMENT & METHOD81

ANNEX B CALIBRATION REPORTS83

ANNEX C SAR SYSTEM PHOTOGRAPHS.....122

ANNEX D SETUP PHOTOGRAPHS123

This page has been left blank intentionally.

1 Executive Summary & EUT information

The purpose of this test programmed was to demonstrate compliance of the b mobile HK Limited. Model: LQ310 against the current Stipulated Standards. The GSM Mobile Phone have demonstrated compliance with the C95.1, IEEE 1528, OET Bulletin 65 Supplement C , IEC62209-2, RSS-102 Issue 4 and Safety Code 6. The test has demonstrated that this unit complies with stipulated standards.

EUT Information

EUT Description	: GSM Mobile Phone
Model No	: LQ310, QS302
Input Power	: 3.6V-4.2VDC
Maximum Output Power to Antenna	GSM850(Class 4) : 1.986W (32.98dBm) GPRS850(Multi-slot Class 12) : 0.948W (29.77dBm) GSM1900 (Class 1) : 0.834W (29.21dBm) GPRS1900 (Multi-slot Class 12) : 0.400W (26.02dBm)
Max. SAR Level(s) Measured	0.999W/Kg 1g Head Tissue (Cellular Band) 1.182W/Kg 1g Body Tissue (Cellular Band) 0.455W/Kg 1g Head Tissue (PCS Band) 0.366W/Kg 1g Body Tissue (PCS Band)
Classification Per Stipulated Test Standard	: Mobile Device , Class B
Co-located TX Antenna Separation distances	: WWAN can transmit simultaneously with Bluetooth : 0.2cm - WWAN antenna-to-Bluetooth antenna
Antenna Type(s)	: Internal Antenna

Note: The difference between LQ310 and QS302 is appearance and model No. So we select LQ310 to performed SAR testing. Please refer to product Declaration letter

2 TECHNICAL DETAILS

Purpose	Compliance testing of GSM Mobile Phone model LQ310 with stipulated standard
Applicant / Client	b mobile HK Limited G/F. 144 UN CHAU STREET, SHAM SHUI PO, KOWLOON HONG KONG, CHINA
Manufacturer	Shenzhen Fortune Ship Technology Co.,Ltd 6001 36th Avenue West
Laboratory performing the tests	SIEMIC Laboratories Suite 311, Building 1, Section 30, No.2 Kefa Road, Science and Technology Park Nan Shan District, Shenzhen 518057, Guangdong, P.R.C Tel: +(86) 0755-26014629 VIP Line:950-4038-0435
Test report reference number	12050036-FCC-H
Date EUT received	April 18 th 2012
Standard applied	See Page 9
Dates of test (from – to)	May 14th 2012 ~ May 15th 2012
No of Units:	1
Equipment Category:	PCE
Trade Name:	B mobile
Model Name:	LQ310, QS302
RF Operating Frequency (ies)	GSM850 : 824.2 ~ 848.8 MHz(TX) / 869.2 ~ 893.8 MHz(RX) GSM1900 : 1850.2 ~ 1909.8 MHz(TX) / 1930.2 ~ 1989.8 MHz(RX) BT:2402~ 2480MHz(TX/RX)
Modulation:	GSM / GPRS : GMSK Bluetooth: GFSK
FCC ID	ZSW-QS302-LQ310
IC ID:	N/A

3 INTRODUCTION

Introduction

This measurement report shows compliance of the EUT with FCC OET Bulletin 65 Supplement C (Edition 01-01), IEC62209-2 & RSS 102 Issue 4.0.

The test procedures, as described in ANSI C95.1 – 1999 Standard for Safety Levels with Respect to Human Exposure to Radio Frequency Electromagnetic Fields, 3 kHz to 300 GHz [2], and ANSI C95.3 – 2002 Recommended Practice for the Measurement of Potentially Hazardous Electromagnetic Fields [3], were employed.

SAR Definition

Specific Absorption Rate is defined as the time derivative (rate) of the incremental energy (dW) absorbed by (dissipated in) an incremental mass (dm) contained in a volume element (dV) of a given density (ρ).

$$SAR = \frac{d}{dt} \left(\frac{dW}{dm} \right) = \frac{d}{dt} \left(\frac{dW}{\rho dV} \right)$$

SAR is expressed in units of watts per kilogram (W/kg). SAR can be related to the electric field at a point by

$$SAR = \frac{\sigma |E|^2}{\rho}$$

where:

- σ = conductivity of the tissue (S/m)
- ρ = mass density of the tissue (kg/m³)
- E = rms electric field strength (V/m)

4 SAR Measurement Setup

Dosimetric Assessment System

These measurements were performed with the automated near-field scanning system OPENSAR from SATIMO. The system is based on a high precision robot (working range: 850 mm), which positions the probes with a positional repeatability of better than ± 0.02 mm. Special E- and H-field probes have been developed for measurements close to material discontinuity, the sensors of which are directly loaded with a Schottky diode and connected via highly resistive lines to the data acquisition unit.

The SAR measurements were conducted with dosimetric probe (manufactured by SATIMO), designed in the classical triangular configuration and optimized for dosimetric evaluation. The probe has been calibrated according to the procedure described in SAR standard with accuracy of better than $\pm 10\%$. The spherical isotropy was evaluated with the procedure described in SAR standard and found to be better than ± 0.25 dB. The phantom used was the SAM Phantom as described in FCC supplement C, IEEE P1528 and CENELEC EN62209-1.

Measurement System Diagram

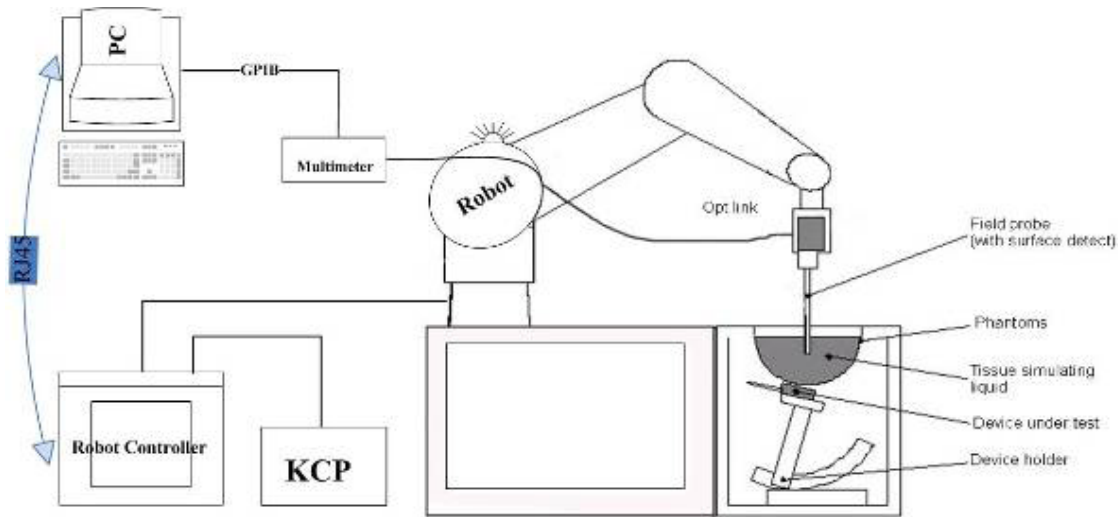

The OPENSAR system for performing compliance tests consist of the following items:

1. A standard high precision 6-axis robot (KUKA) with controller and software.
2. KUKA Control Panel (KCP).
3. A dosimetric probe, i.e., an isotropic E-field probe optimized and calibrated for usage in tissue simulating liquid. The probe is equipped with an optical surface detector system.
4. The functions of the PC plug-in card are to perform the time critical task such as signal filtering, surveillance of the robot operation fast movement interrupts.

5. A computer operating Windows XP.
6. OPENSAR software.
7. Remote control with teaches pendant and additional circuitry for robot safety such as warning lamps, etc.
8. The SAM phantom enabling testing left-hand right-hand and body usage.
9. The Position device for handheld EUT.
10. Tissue simulating liquid mixed according to the given recipes (see Application Note).
11. System validation dipoles to validate the proper functioning of the system.

EP100 Probe



Construction Symmetrical design with triangular Core. Built-in shielding against static charges Calibration in air from 100 MHz to 2.5 GHz. In brain and muscle simulating tissue at frequencies from 800 to 6000 MHz (accuracy of 8%) .

Frequency 100 MHz to 6 GHz;

Linearity ; 0.25 dB (100 MHz to 6 GHz) ,

Directivity : 0.25 dB in brain tissue (rotation around probe axis) 0.5 dB in brain tissue (rotation normal probe axis)

Dynamic : 0.001W/kg to > 100W/kg;

Range Linearity: 0.25 dB

Surface : 0.2 mm repeatability in air and liquids

Dimensions Overall length: 330 mm

Tip length: 16 mm

Body diameter: 8 mm

Tip diameter: 2.6 mm

Distance from probe tip to dipole centers: <1.5 mm

Application General dosimetric up to 6 GHz

Compliance tests of mobile phones

Fast automatic scanning in arbitrary phantoms

The SAR measurements were conducted with the dosimetric probe designed in the classical triangular configuration and optimized for dosimetric evaluation. The probe is constructed using the thick film technique, with printed resistive lines on ceramic substrates.

It is connected to the KRC box on the robot arm and provides an automatic detection of the phantom surface. The 3D file of the phantom is include in OpenSAR software. The Video Positioning System allow the system to take the automatic reference and to move the probe safely and accurately on the phantom.

E-Field Probe Calibration Process

Probe calibration is realized, in compliance with CENELEC EN50361; CEI/IEC 62209 and IEEE 1528 std, with CALISAR, SATIMO proprietary calibration system. The calibration is performed with the technique using reference waveguide.

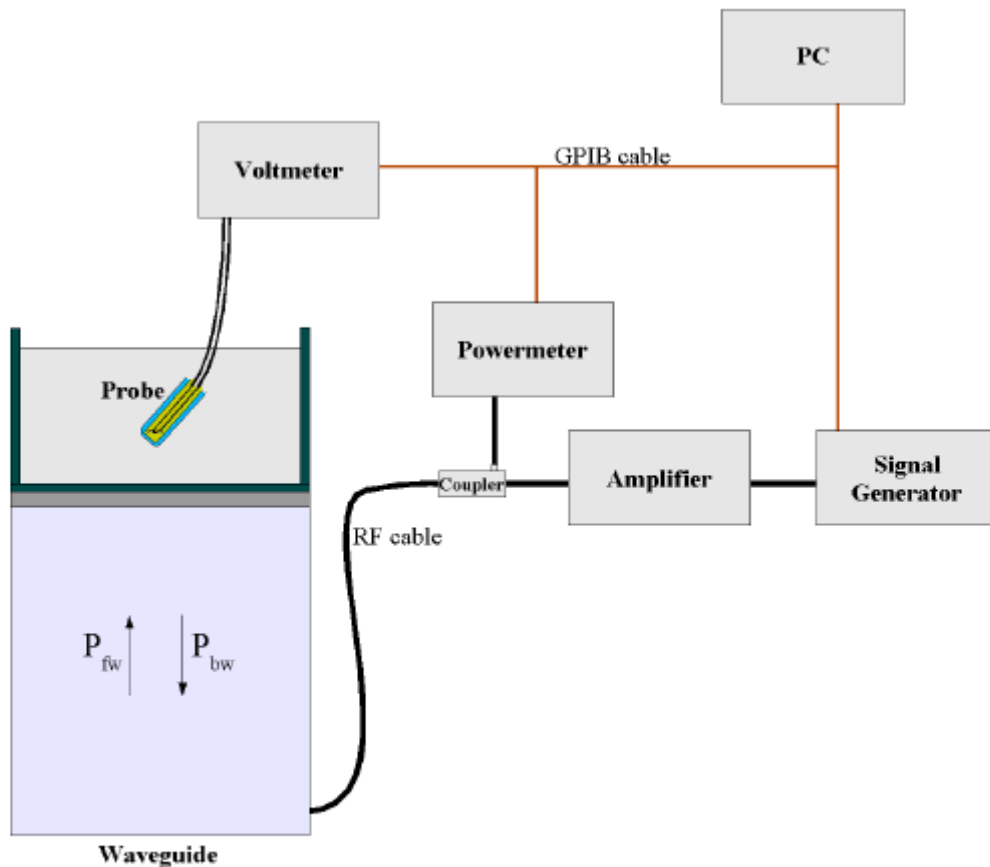

$$SAR = \frac{4 (P_{fw} - P_{bw})}{ab\delta} \cos^2 \left(\pi \frac{y}{a} \right) e^{-(2z/\delta)}$$

Where :

- P_{fw} = Forward Power
- P_{bw} = Backward Power
- a and b = Waveguide dimensions
- δ = Skin depth

Keithley configuration:

Rate = Medium; Filter =ON; RDGS=10; FILTER TYPE =MOVING AVERAGE; RANGE AUTO

After each calibration, a SAR measurement is performed on a validation dipole and compared with a NPL calibrated probe, to verify it.

Each probe is calibrated according to a dosimetric assessment procedure described in SAR standard with accuracy better than +/- 10%. The spherical isotropy was evaluated with the procedure described in SAR standard and found to be better than +/-0.25dB. The sensitivity parameters (NormX, NormY, NormZ), the diode compression parameter (DCP) and the conversion factor (ConvF) of the probe are tested. The free space E-field from probe outputs is determined in a test chamber. This is performed in a TEM cell for frequencies bellow 0.8 GHz, and in a waveguide above 0.8 GHz for free space. For the free space calibration, the probe is placed in the volumetric center of the cavity and at the proper orientation with the field. E-field correlation calibration is performed in a flat phantom filled with the appropriate simulated brain tissue.

SAM Phantom

The SAM Phantom SAM29 is constructed of a fiberglass shell integrated in a wooden table. The shape of the shell is in compliance with the specification set in IEEE P1528 and CENELEC EN62209-1, IEC62209-2.

The phantom enables the dosimetric evaluation of left and right hand phone usage as well as body mounted usage at the flat phantom region.

A cover prevents the evaporation of the liquid.

Reference markings on the Phantom allow the complete setup of all predefined phantom positions and measurement grids by manually teaching three points in the robot.

Shell Thickness: 2 0.2 mm

Filling Volume: Approx. 25 liters

Dimensions (H x L x W): 810 x 1000 x 500 mm

Liquid is filled to at least 15mm from the bottom of Phantom.



Device Holder

In combination with the Generic Twin Phantom V3.0, the Mounting Device enables the rotation of the mounted transmitter in spherical coordinates whereby the rotation points is the ear opening. The devices can be easily, accurately, and repeatedly positioned according to the FCC and CENELEC specifications. The device holder can be locked at different phantom locations (left head, right head, flat phantom).



Note: A simulating human hand is not used due to the complex anatomical and geometrical structure of the hand that may produced infinite number of configurations [10]. To produce the worst-case condition (the hand absorbs antenna output power), the hand is omitted during the tests.

Data Evaluation

The OPENSAR software automatically executes the following procedure to calculate the field units from the microvolt readings at the probe connector. The parameters used in the valuation are stored in the configuration modules of the software:

Probe Parameters	- Sensitivity	Norm _i
	- Conversion factor	ConvFi
	- Diode compression point Dcpi	
Device Parameter	- Frequency	f
	- Crest factor	cf
Media Parametrs	- Conductivity	σ
	- Density	ρ

These parameters must be set correctly in the software. They can either be found in the component documents or be imported into the software from the configuration files issued for the OPENSAR components.

The first step of the evaluation is a linearization of the filtered input signal to account for the compression characteristics of the detector diode. The compensation depends on the input signal, the diode type and the DC-transmission factor from the diode to the evaluation electronics. If the exciting field is pulsed, the crest factor of the signal must be known to correctly compensate for peak power. The formula for each channel can be given as

$$V_i = U_i + U_i^2 \cdot \frac{cf}{dcp_i}$$

Where V_i = Compensated signal of channel i ($i = x, y, z$)
 U_i = Input signal of channel i ($i = x, y, z$)
 cf = Crest factor of exciting field (DASY parameter)
 dcp_i = Diode compression point (DASY parameter)

From the compensated input signals the primary field data for each channel can be evaluated:

E-field probes:
$$E_i = \sqrt{\frac{V_i}{Norm_i \cdot ConvF}}$$

H-field probes:
$$H_i = \sqrt{V_i} \cdot \frac{a_{i10} + a_{i11}f + a_{i12}f^2}{f}$$

- Where V_i = Compensated signal of channel i ($i = x, y, z$)
 $Norm_i$ = Sensor sensitivity of channel i ($i = x, y, z$)
 $\mu V/(V/m)^2$ for E field Probes
 $ConvF$ = Sensitivity enhancement in solution
 a_{ij} = Sensor sensitivity factors for H -field probes

- f = Carrier frequency (GHz)
 E_i = Electric field strength of channel i in V/m
 H_i = Magnetic field strength of channel i in A/m

The RSS value of the field components gives the total field strength (Hermitian magnitude):

$$E_{tot} = \sqrt{E_x^2 + E_y^2 + E_z^2}$$

The primary field data are used to calculate the derived field units.

$$SAR = E_{tot}^2 \cdot \frac{\sigma}{\rho \cdot 1000}$$

- where SAR = local specific absorption rate in mW/g
 E_{tot} = total field strength in V/m
 σ = conductivity in [mho/m] or [siemens/m]
 ρ = equivalent tissue density in g/cm³

Note that the density is normally set to 1 (or 1.06), to account for actual brain density rather than the density of the simulation liquid.

The power flow density is calculated assuming the excitation field as a free space field.

$$P_{pwe} = \frac{E_{tot}^2}{3770} \quad \text{or} \quad P_{pwe} = H_{tot}^2 \cdot 37.7$$

- where P_{pwe} = Equivalent power density of a plane wave in mW/cm²
 E_{tot} = total electric field strength in V/m
 H_{tot} = total magnetic field strength in A/m

SAR Evaluation – Peak Spatial - Average

The procedure for assessing the peak spatial-average SAR value consists of the following steps

- **Power Reference Measurement**

The reference and drift jobs are useful jobs for monitoring the power drift of the device under test in the batch process. Both jobs measure the field at a specified reference position, at a selectable distance from the phantom surface. The reference position can be either the selected section's grid reference point or a user point in this section. The reference job projects the selected point onto the phantom surface, orients the probe perpendicularly to the surface, and approaches the surface using the selected detection method.

- **Area Scan**

The area scan is used as a fast scan in two dimensions to find the area of high field values, before doing a finer measurement around the hot spot. The sophisticated interpolation routines implemented in OPENSAR software can find the maximum locations even in relatively coarse grids. The scan area is defined by an editable grid. This grid is anchored at the grid reference point of the selected section in the phantom. When the area scan's property sheet is brought-up, grid was at to 15 mm by 15 mm and can be edited by a user.

- **Zoom Scan**

Zoom scans are used to assess the peak spatial SAR values within a cubic averaging volume containing 1 g and 10 g of simulated tissue. The default zoom scan measures 5 x 5 x 7 points within a cube whose base faces are centered around the maximum found in a preceding area scan job within the same procedure. If the preceding Area Scan job indicates more than one maximum, the number of Zoom Scans has to be enlarged accordingly (The default number inserted is 1).

- **Power Drift measurement**

The drift job measures the field at the same location as the most recent reference job within the same procedure, and with the same settings. The drift measurement gives the field difference in dB from the reading conducted within the last reference measurement. Several drift measurements are possible for one reference measurement. This allows a user to monitor the power drift of the device under test within a batch process. In the properties of the Drift job, the user can specify a limit for the drift and have OPENSAR software stop the measurements if this limit is exceeded.

SAR Evaluation – Peak SAR

The procedure for spatial peak SAR evaluation has been implemented according to the IEEE1529 standard. It can be conducted for 1 g and 10 g. The OPENSAR system allows evaluations that combine measured data and robot positions, such as:

- maximum search
- extrapolation
- boundary correction
- peak search for averaged SAR

During a maximum search, global and local maximum searches are automatically performed in 2-D after each Area Scan measurement with at least 6 measurement points. It is based on the evaluation of the local SAR gradient calculated by the Quadratic Shepard's method. The algorithm will find the global maximum and all local maxima within -2 dB of the global maxima for all SAR distributions.

Extrapolation

Extrapolation routines are used to obtain SAR values between the lowest measurement points and the inner phantom surface. The extrapolation distance is determined by the surface detection distance and the probe sensor offset. Several measurements at different distances are necessary for the extrapolation. They are used in the Cube Scan to obtain SAR values between the lowest measurement points and the inner phantom surface. The routine uses the fourth order least square polynomial method for extrapolation. For a grid using 5x5x7 measurement points with 5mm resolution amounting to 343 measurement points, the uncertainty of the extrapolation routines is less than 1% for 1 g and 10 g cubes.

Definition of Reference Points

Ear Reference Point

Figure 6.2 shows the front, back and side views of the SAM Phantom. The point "M" is the reference point for the center of the mouth, "LE" is the left ear reference point (ERP), and "RE" is the right ERP. The ERPs are 15mm posterior to the entrance to the ear canal (EEC) along the B-M line (Back-Mouth), as shown in Figure 6.1. The plane passing through the two ear canals and M is defined as the Reference Plane. The line N-F (Neck-Front) is perpendicular to the reference plane and passing through the RE (or LE) is called the Reference Pivoting Line (see Figure 6.1). Line B-M is perpendicular to the N-F line. Both N-F and B-M lines are marked on the external phantom shell to facilitate handset positioning [5].

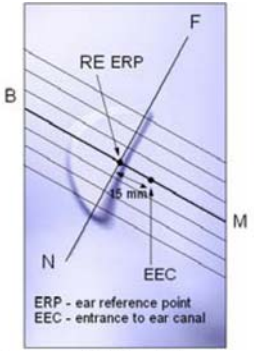

Figure 6.1 Close-up side view of ERP's



Figure 6.2 Front, back and side view of SAM

Device Reference Points

Two imaginary lines on the device need to be established: the vertical centerline and the horizontal line. The test device is placed in a normal operating position with the "test device reference point" located along the "vertical centerline" on the front of the device aligned to the "ear reference point" (See Fig. 6.3). The "test device reference point" is then located at the same level as the center of the ear reference point. The test device is positioned so that the "vertical centerline" is bisecting the front surface of the device at its top and bottom edges, positioning the "ear reference point" on the outer surface of both the left and right head phantoms on the ear reference point [5].

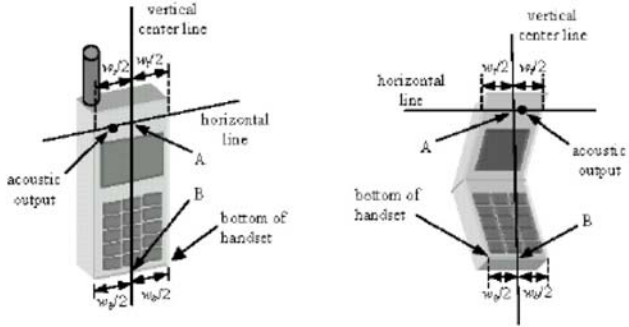

Figure 6.3 Handset Vertical Center & Horizontal Line Reference Points

Test Configuration – Positioning for Cheek / Touch

1. Position the device close to the surface of the phantom such that point A is on the (virtual) extension of the line passing through points RE and LE on the phantom (see Figure below), such that the plane defined by the vertical center line and the horizontal line of the device is approximately parallel to the sagittal plane of the phantom



Figure 7.1 Front, Side and Top View of Cheek/Touch Position

2. Translate the device towards the phantom along the line passing through RE and LE until the device touches the ear.
3. While maintaining the device in this plane, rotate it around the LE-RE line until the vertical centerline is in the plane normal to MB-NF including the line MB (called the reference plane).
4. Rotate the device around the vertical centerline until the device (horizontal line) is symmetrical with respect to the line NF.
5. While maintaining the vertical centerline in the reference plane, keeping point A on the line passing through RE and LE and maintaining the device contact with the ear, rotate the device about the line NF until any point on the device is in contact with a phantom point below the ear (cheek). See Figure below.

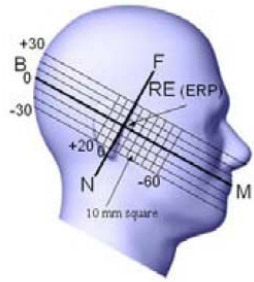

Figure 7.2 Side view w/ relevant markings

Test Configuration – Positioning for Ear / 15° Tilt

With the test device aligned in the Cheek/Touch Position”:

1. While maintaining the orientation of the device, retracted the device parallel to the reference plane far enough to enable a rotation of the device by 15 degrees.
2. Rotate the device around the horizontal line by 15 degrees.
3. While maintaining the orientation of the device, move the device parallel to the reference plane until any part of the device touches the head. (In this position, point A is located on the line RE-LE). The tilted position is obtained when the contact is on the pinna. If the contact is at any location other than the pinna, the angle of the device shall be reduced. The tilted position is obtained when any part of the device is in contact with the ear as well as a second part of the device is in contact with the head (see Figure below).

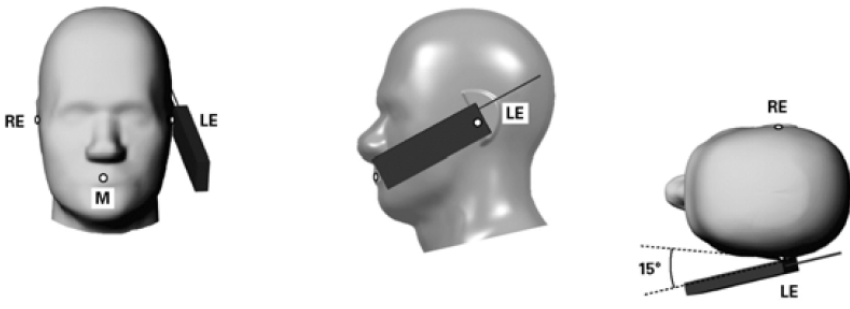
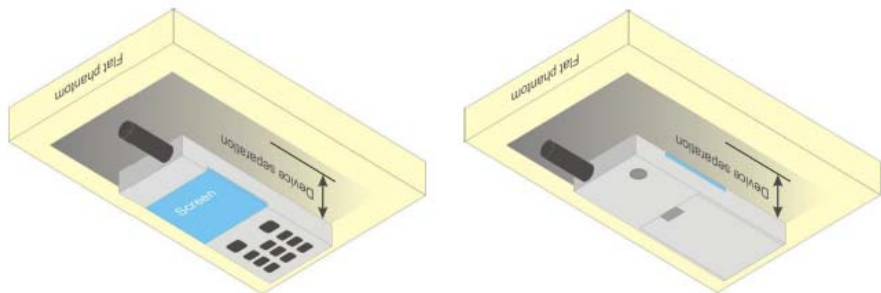

Figure 7.3 Front, Side and Top View of Ear/15° Tilt Position

Test Position – Body Worn Configurations

Body Worn Position

- (a) To position the device parallel to the phantom surface with either keypad up or down.
- (b) To adjust the device parallel to the flat phantom.
- (c) To adjust the distance between the device surface and the flat phantom to 1.5 cm or holster surface and the flat phantom to 0 cm.



5 ANSI/IEEE C95.1 – 1999 RF Exposure Limit

In order for users to be aware of the body-worn operating requirements for meeting RF exposure compliance, operating instructions and cautions statements are included in the user's manual.

Uncontrolled Environment

Uncontrolled Environments are defined as locations where there is the exposure of individuals who have no knowledge or control of their exposure. The general population/uncontrolled exposure limits are applicable to situations in which the general public may be exposed or in which persons who are exposed as a consequence of their employment may not be made fully aware of the potential for exposure or cannot exercise control over their exposure. Members of the general public would come under this category when exposure is not employment-related; for example, in the case of a wireless transmitter that exposes persons in its vicinity.

Controlled Environment

Controlled Environments are defined as locations where there is exposure that may be incurred by persons who are aware of the potential for exposure, (i.e. as a result of employment or occupation). In general, occupational/controlled exposure limits are applicable to situations in which persons are exposed as a consequence of their employment, who have been made fully aware of the potential for exposure and can exercise control over their exposure. This exposure category is also applicable when the exposure is of a transient nature due to incidental passage through a location where the exposure levels may be higher than the general population/uncontrolled limits, but the exposed person is fully aware of the potential for exposure and can exercise control over his or her exposure by leaving the area or by some other appropriate means.

Table 8.1 Human Exposure Limits

	UNCONTROLLED ENVIRONMENT General Population (W/kg) or (mW/g)	CONTROLLED ENVIROMENT Professional Population (W/kg) or (mW/g)
SPATIAL PEAK SAR ¹ Brain	1.60	8.00
SPATIAL AVERAGE SAR ² Whole Body	0.08	0.40
SPATIAL PEAK SAR ³ Hands, Feet, Ankles, Wrists	4.00	20.00

¹ The Spatial Peak value of the SAR averaged over any 1 gram of tissue (defined as a tissue volume in the shape of a cube) and over the appropriate averaging time.

² The Spatial Average value of the SAR averaged over the whole body.

³ The Spatial Peak value of the SAR averaged over any 10 grams of tissue (defined as a tissue volume in the shape of a cube) and over the appropriate averaging time.

6 SYSTEM AND LIQUID VALIDATION

System Validation

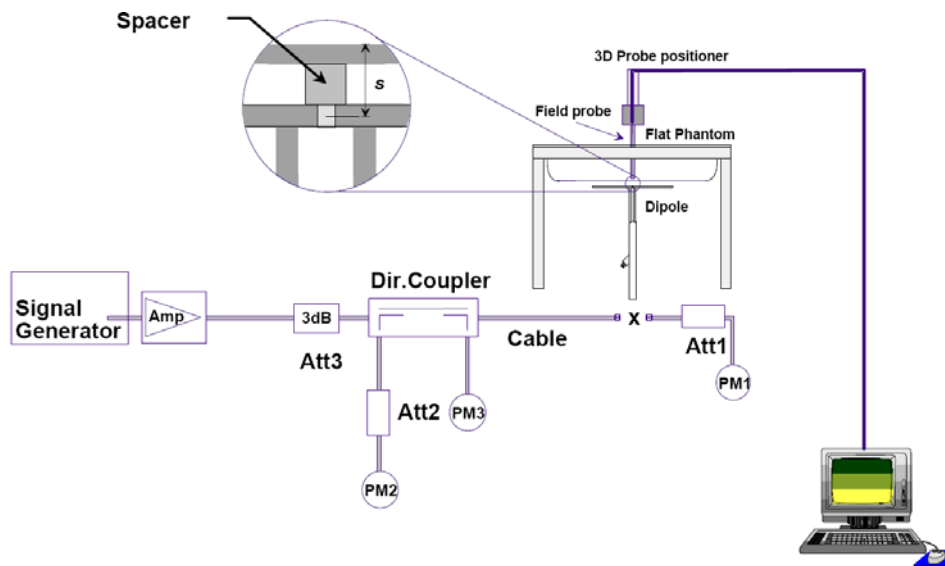

Fig 8.1 System Setup for System Evaluation

The system performance check verifies that the system operates within its specifications. System and operator errors can be detected and corrected. It is recommended that the system performance check be performed prior to any usage of the system in order to guarantee reproducible results. The system performance check uses normal SAR measurements in a simplified setup with a well characterized source. This setup was selected to give a high sensitivity to all parameters that might fail or vary over time. The system check does not intend to replace the calibration of the components, but indicates situations where the system uncertainty is exceeded due to drift or failure.

In the simplified setup for system evaluation, the DUT is replaced by a calibrated dipole and the power source is replaced by a continuous wave that comes from a signal generator. The calibrated dipole must be placed beneath the flat phantom section of the SAM twin phantom with the correct distance holder. The distance holder should touch the phantom surface with a light pressure at the reference marking and be oriented parallel to the long side of the phantom. The equipment setup is shown below:

1. Signal Generator
2. Amplifier
3. Directional Coupler
4. Power Meter
5. Calibrated Dipole

The output power on dipole port must be calibrated to 30 dBm (1000 mW) before dipole is connected.

Numerical reference SAR values (W/kg) for reference dipole and flat phantom

Frequency (MHz)	1 g SAR	10 g SAR	Local SAR at surface (above feed-point)	Local SAR at surface (y = 2 cm offset from feed-point) ^a
300	3.0	2.0	4.4	2.1
450	4.9	3.3	7.2	3.2
835	9.5	6.2	4.1	4.9
900	10.8	6.9	16.4	5.4
1450	29.0	16.0	50.2	6.5
1800	38.1	19.8	69.5	6.8
1900	39.7	20.5	72.1	6.6
2000	41.1	21.1	74.6	6.5
2450	52.4	24.0	104.2	7.7
3000	63.8	25.7	140.2	9.5

Target and measurement SAR after Normalized

Measurement Date	Frequency (MHz)	Liquid Type (head/body)	Target SAR1g (W/kg)	Measured SAR1g (W/kg)	Deviation (%)
May 14 th ,2012	835	head	9.5	9.4	-1.0
May 14 th ,2012	835	body	9.5	9.6	1.0
May 15 th ,2012	1900	head	39.7	39.3	-1.0
May 15 th ,2012	1900	body	39.7	39.8	0.25

Liquid Validation

The dielectric parameters were checked prior to assessment using the HP85070C dielectric probe kit. The dielectric parameters measured are reported in each correspondent section.

IEEE SCC-34/SC-2 P1528 recommended Tissue Dielectric Parameters

The head tissue dielectric parameters recommended by the IEEE SCC-34/SC-2 in P1528 have been incorporated in the following table. These head parameters are derived from planar layer models simulating the highest expected SAR for the dielectric properties and tissue thickness variations in a human head. Other head and body tissue parameters that have not been specified in P1528 are derived from the tissue dielectric parameters computed from the 4-Cole-Cole equations and extrapolated according to the head parameters specified in P1528

Target Frequency	Head		Body	
MHz	ϵ_r	σ (S/m)	ϵ_r	σ (S/m)
150	52.3	0.76	61.9	0.80
300	45.3	0.87	58.2	0.92
450	43.5	0.87	56.7	0.94
835	41.5	0.90	55.2	0.97
900	41.5	0.97	55.0	1.05
915	41.5	0.98	55.0	1.06
1450	40.5	1.20	54.0	1.30
1610	40.3	1.29	53.8	1.40
1800-2000	40.0	1.40	53.3	1.52
2450	39.2	1.80	52.7	1.95
3000	38.5	2.40	52.0	2.73
5800	35.3	5.27	48.2	6.00

Note: ϵ_r = relative permittivity, σ = conductivity and $\rho = 1000 \text{ kg/m}^3$

Liquid Confirmation Result:

Temperature: <u>22</u> °C			Relative humidity: <u>53</u> %			
Freq(MHz)			Target	Measured	Deviation (%)	Limit (%)
835	Head	Permittivity	41.5	41.68	0.43	5
		Conductivity	0.90	0.92	2.2	5
835	Body	Permittivity	55.2	55.46	0.47	5
		Conductivity	0.97	0.98	1.0	5
824.2	Head	Permittivity	41.5	41.66	0.38	5
		Conductivity	0.90	0.92	2.2	5
824.2	Body	Permittivity	55.2	55.35	0.27	5
		Conductivity	0.97	0.98	1.0	5
836.4	Head	Permittivity	41.5	41.76	0.62	5
		Conductivity	0.90	0.92	2.2	5
836.4	Body	Permittivity	55.2	55.56	0.65	5
		Conductivity	0.97	0.98	1.0	5
848.8	Head	Permittivity	41.5	41.85	0.84	5
		Conductivity	0.90	0.92	2.2	5
848.8	Body	Permittivity	55.2	55.55	0.63	5
		Conductivity	0.97	0.98	1.0	5

Note: The liquid validation was performed at May 14th, 2012.

Temperature: <u>22</u> °C			Relative humidity: <u>53</u> %			
Freq(MHz)			Target	Measured	Deviation (%)	Limit (%)
1900	Head	Permittivity	40.00	40.59	1.47	5
		Conductivity	1.4	1.42	1.42	5
1900	Body	Permittivity	53.3	53.90	1.12	5
		Conductivity	1.52	1.54	1.31	5
1850.2	Head	Permittivity	40.00	40.68	1.7	5
		Conductivity	1.4	1.39	-0.7	5
1850.2	Body	Permittivity	53.3	53.70	0.75	5
		Conductivity	1.52	1.50	1.31	5

Note: The liquid validation was performed at May 15th, 2012

System Validation Plots

Product Description: GSM Mobile Phone

Model: LQ310

Test Date: May 14th 2012

Medium(liquid type)	HSL_850
Frequency (MHz)	835.000000
Relative permittivity (real part)	41.68
Conductivity (S/m)	0.92
Input power	10mW
Crest factor	1.0
Conversion Factor	8.78
Variation (%)	-0.530000
SAR 10g (W/Kg)	0.063
SAR 1g (W/Kg)	0.094

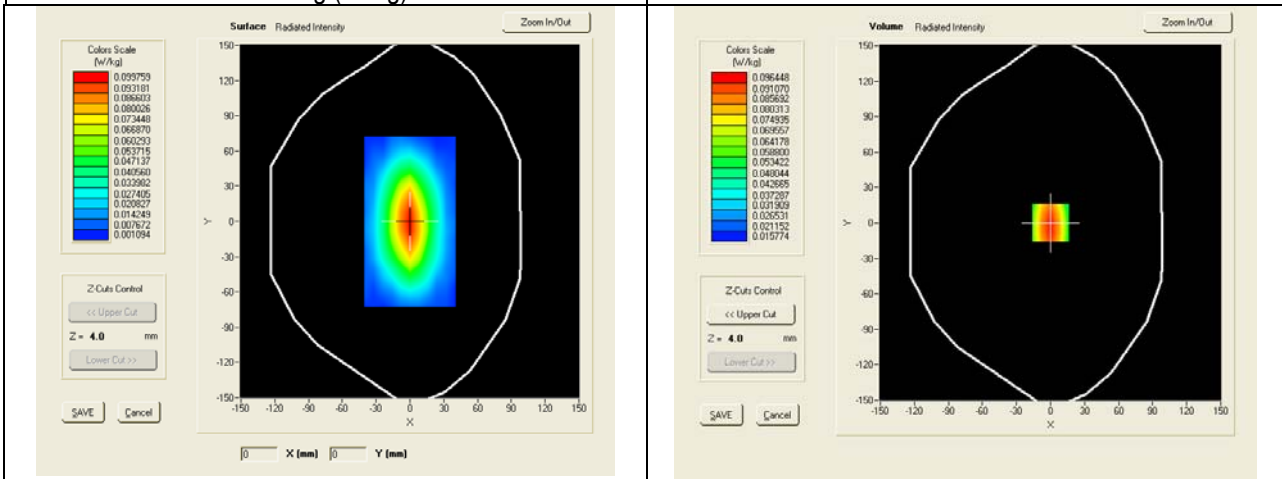

SAR, Z Axis Scan (X = 0, Y = 0)

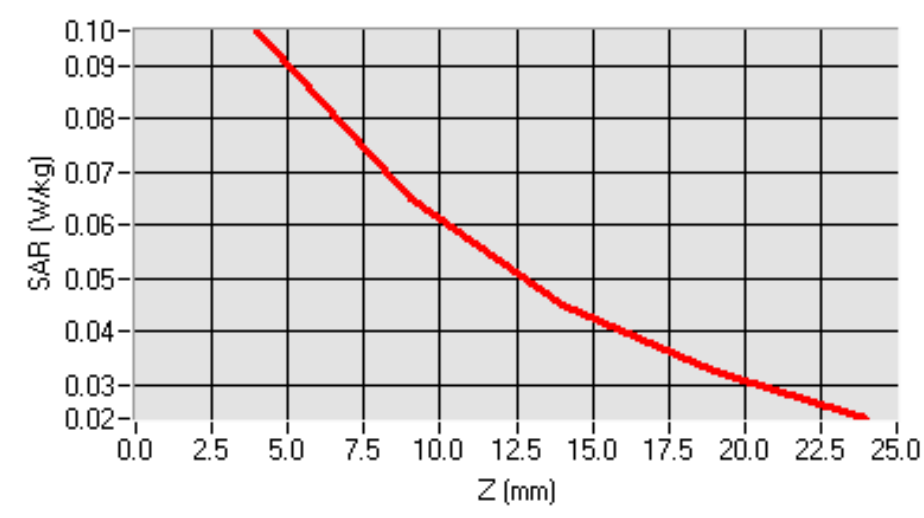

Product Description: GSM Mobile Phone
 Model: LQ310
 Test Date: May 14th 2012

Medium(liquid type)	MSL_850
Frequency (MHz)	835.000000
Relative permittivity (real part)	55.46
Conductivity (S/m)	0.99
Input power	10mW
Crest factor	1.0
Conversion Factor	9.07
Variation (%)	-0.110000
SAR 10g (W/Kg)	0.065
SAR 1g (W/Kg)	0.096

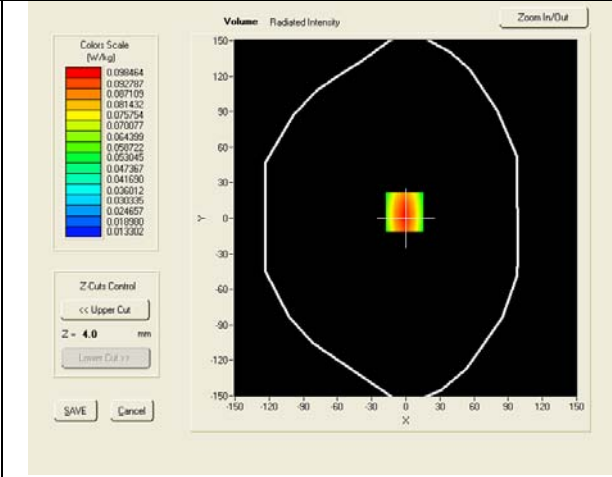
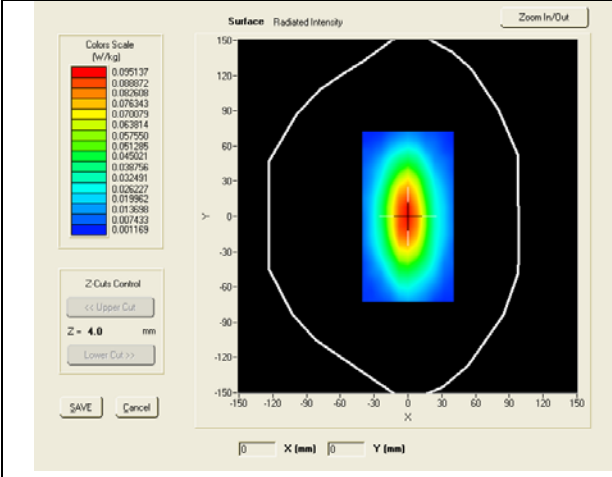

SAR, Z Axis Scan (X = -1, Y = 5)

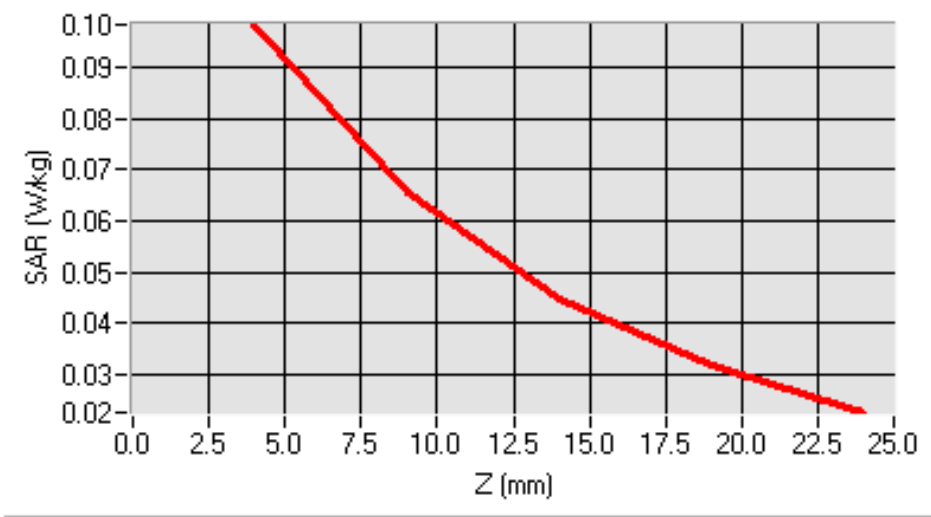

Product Description: GSM Mobile Phone
 Model: LQ310
 Test Date: May 15th 2012

Medium(liquid type)	HSL_1900
Frequency (MHz)	1900.000
Relative permittivity (real part)	40.59
Conductivity (S/m)	1.42
Input power	10mW
Crest factor	1.0
Conversion Factor	9.09
Variation (%)	0.0800000
SAR 10g (W/Kg)	0.204
SAR 1g (W/Kg)	0.393

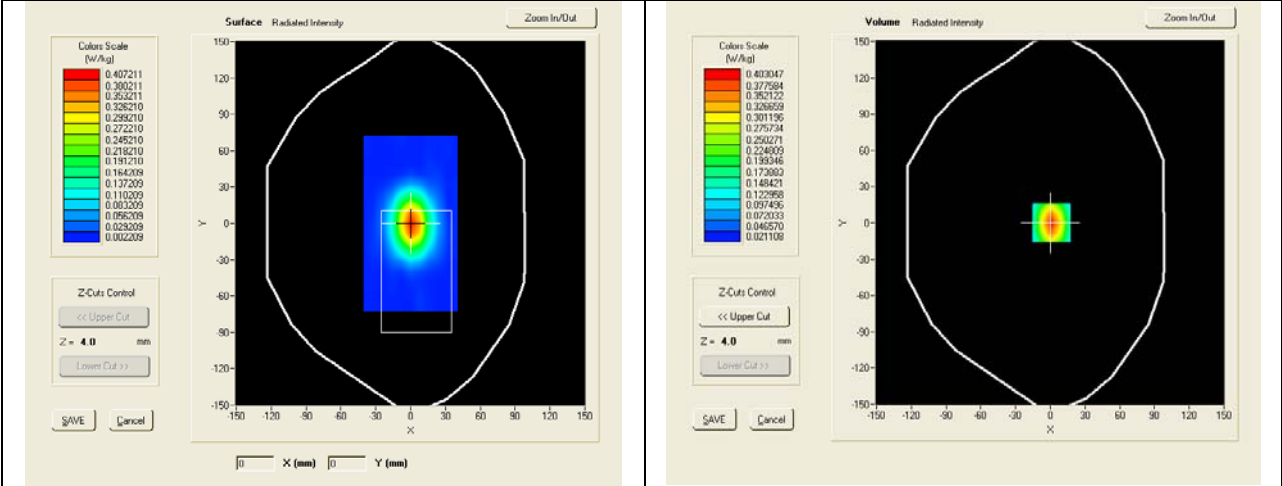

SAR, Z Axis Scan (X = 1, Y = 0)

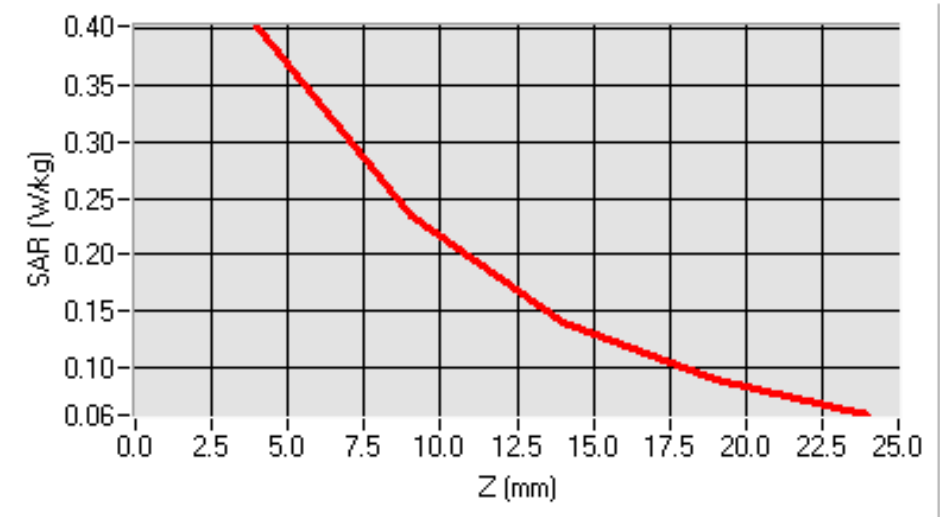

Product Description: GSM Mobile Phone
Model: LQ310
Test Date: May 15th 2012

Medium(liquid type)	MSL_1900
Frequency (MHz)	1900.000
Relative permittivity (real part)	53.90
Conductivity (S/m)	1.54
Input power	10mW
Crest factor	1.0
Conversion Factor	9.32
Variation (%)	0.020000
SAR 10g (W/Kg)	0.208
SAR 1g (W/Kg)	0.398

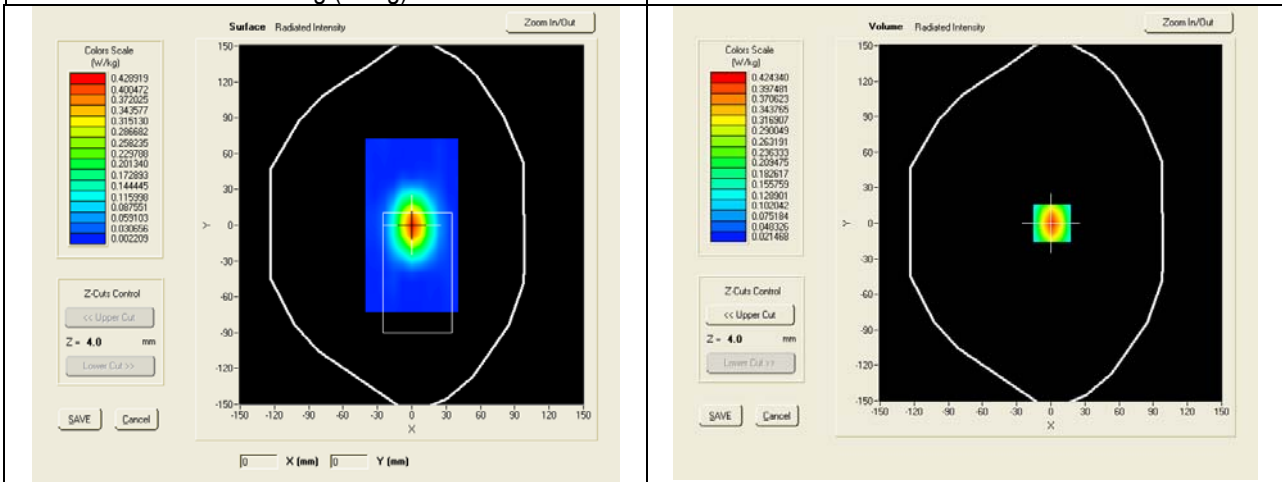

SAR, Z Axis Scan (X = 1, Y = 0)

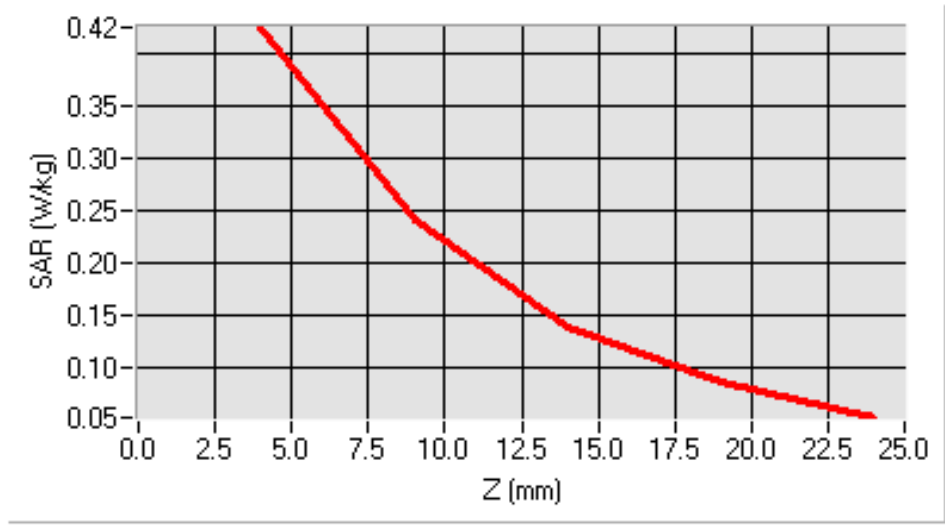

7 UNCERTAINTY ASSESSMENT

The component of uncertainty may generally be categorized according to the methods used to evaluate them. The evaluation of uncertainty by the statistical analysis of a series of observations is termed a Type A evaluation of uncertainty. The evaluation of uncertainty by means other than the statistical analysis of a series of observation is termed a Type B evaluation of uncertainty. Each component of uncertainty, however evaluated, is represented by an estimated standard deviation, termed standard uncertainty, which is determined by the positive square root of the estimated variance

A Type A evaluation of standard uncertainty may be based on any valid statistical method for treating data. This includes calculating the standard deviation of the mean of a series of independent observations; using the method of least squares to fit a curve to the data in order to estimate the parameter of the curve and their standard deviations; or carrying out an analysis of variance in order to identify and quantify random effects in certain kinds of measurement.

A type B evaluation of standard uncertainty is typically based on scientific judgment using all of the relevant information available. These may include previous measurement data, experience and specification, data provided in calibration reports and uncertainties assigned to reference data taken from handbooks. Broadly speaking, the uncertainty is either obtained from an outdoor source or obtained from an assumed distribution, such as the normal distribution, rectangular or triangular distributions indicated in Table below :

Uncertainty Distribution	Normal	Rectangle	Triangular	U Shape
Multi-plying Factor ^(a)	1/ κ ^(b)	1 / $\sqrt{3}$	1 / $\sqrt{6}$	1 / $\sqrt{2}$

(a) standard uncertainty is determined as the product of the multiplying factor and the estimated range of variations in the measured quantity
 (b) κ is the coverage factor

Standard Uncertainty for Assumed Distribution

The combined standard uncertainty of the measurement result represents the estimated standard deviation of the result. It is obtained by combining the individual standard uncertainties of both Type A and Type B -sum-by taking the positive square root of the estimated variances.

Expanded uncertainty is a measure of uncertainty that defines an interval about the measurement result within which the measured value is confidently believed to lie. It is obtained by multiplying the combined standard uncertainty by a coverage factor. Typically, the coverage factor ranges from 2 to 3. Using a coverage factor allows the true value of a measured quantity to be specified with a defined probability within the specified uncertainty range. For purpose of this document, a coverage factor two is used, which corresponds to confidence interval of about 95 %.

The COMOSAR Uncertainty Budget is show in below table:

Uncertainty Budget of COMOSAR for frequency range 300 MHz to 3 GHz

Uncertainty Component	Tolerances %	Probability Distribution	Divisor	Ci (1g)	Ci (10g)	Uncertainty 1g(%)	Uncertainty 10g(%)
Measurement System Related							
Probe Calibration	5.831	N	1	1	1	5.831	5.831
Axial Isotropy	3	R	$\sqrt{3}$	$\sqrt{1-Cp}$	$\sqrt{1-Cp}$	1.22474	1.22474
Hemispherical Isotropy	4	R	$\sqrt{3}$	\sqrt{Cp}	\sqrt{Cp}	1.63299	1.63299
Boundary Effect	1	R	$\sqrt{3}$	1	1	0.57735	0.57735
Linearity	5	R	$\sqrt{3}$	1	1	2.88675	2.88675
System Detection Limits	1	R	$\sqrt{3}$	1	1	0.57735	0.57735
Readout Electronics	0.5	N	1	1	1	0.5	0.5
Response Time	0.2	R	$\sqrt{3}$	1	1	0.11547	0.11547
Integration Time	2	R	$\sqrt{3}$	1	1	1.1547	1.1547
RF Ambient Conditions	3	R	$\sqrt{3}$	1	1	1.73205	1.73205
Probe Positioner Mechanical Tolerances	2	R	$\sqrt{3}$	1	1	1.1547	1.1547
Probe Positioning with respect to Phantom Shell	1	R	$\sqrt{3}$	1	1	0.57735	0.57735
Extrapolation, Interpolation and integration Algorithms for Max. SAR Evaluation.	1.5	R	$\sqrt{3}$	1	1	0.86603	0.86603
Test Sample Related							
Test Sample Positioning	1.5	N	1	1	1	1.5	1.5
Device Holder Uncertainty	5	N	1	1	1	5	5
Output Power Variation – SAR Drift measurement	3	R	$\sqrt{3}$	1	1	1.73205	1.73205
Phantom and Tissue Parameters Related							
Phantom Uncertainty (Shape and thickness Tolerances)	4	R	$\sqrt{3}$	1	1	2.3094	2.394
Liquid Conductivity – deviation from target value	5	R	$\sqrt{3}$	0.64	0.43	1.84752	1.2413
Liquid Conductivity – Measurement Uncertainty	2.5	N	1	0.64	0.43	1.6	1.075
Liquid Permittivity – deviation from target value	3	R	$\sqrt{3}$	0.6	0.49	1.03923	0.8487
Liquid Permittivity – Measurement Uncertainty	2.5	N	1	0.6	0.49	1.5	1.225
Combined Standard Uncertainty						9.95325 %	9.75085 %
Expanded Standard Uncertainty (K=2, confidence 95%)						19.9056 %	19.5017 %

8 OUTPUT POWER VERIFICATION

Test Condition:

1. Conducted Measurement
 EUT was set for low, mid, high channel with modulated mode and highest RF output power.
 The base station simulator was connected to the antenna terminal.
2. Conducted Emissions Measurement Uncertainty
 All test measurements carried out are traceable to national standards. The uncertainty of the measurement at a confidence level of approximately 95% (in the case where distributions are normal), with a coverage factor of 2, in the range 30MHz – 40GHz is ±1.5dB.
3. Environmental Conditions

Temperature	23°C
Relative Humidity	53%
Atmospheric Pressure	1019mbar
4. Test Date : May 14th 2012
 Tested By : Chris You

Test Procedures:

Mobile phone radio output power measurement

1. The transmitter output port was connected to base station emulator.
2. Establish communication link between emulator and EUT and set EUT to operate at maximum output power all the time.
3. Select lowest, middle, and highest channels for each band and different possible test mode.
4. Measure the conducted peak burst power and conducted average burst power from EUT antenna port.

Other radio output power measurement

The output power was measured using power meter at low, mid, and hi channels.

Test Configuration:

EUT supports GSM mode and GPRS multi-slot class 8/10/12. The measurement was made under GSM voice call mode, and each possible different uplink configuration, including 1 UL slot, 2 UL slots and 4UL slots.

Source-based Time Averaged Burst Power Calculation:

For TDMA, the following duty cycle factor was used to calculate the source-based time average power

Number of Time slot	1	2	3	4
Duty Cycle	1:8	1:4	1:2.66	1:2
Duty cycle factor	-9.03 dB	-6.02 dB	-4.26 dB	-3.01 dB
Crest Factor	8	4	2.66	2

Remark: *Time slot duty cycle factor = 10 * log (1 / Time Slot Duty Cycle)*
Source based time averaged power = Maximum burst averaged power (1 Uplink) – 9.03 dB
Source based time averaged power = Maximum burst averaged power (2 Uplink) – 6.02 dB
Source based time averaged power = Maximum burst averaged power (4 Uplink) – 3.01 dB

Test Result:

GSM:

Burst Average Power (dBm);								
Band	GSM850				GSM1900			
Channel	128	190	251	Tune up Power tolerant	512	661	810	Tune up Power tolerant
Frequency (MHz)	824.2	836.6	848.8	/	1850.2	1880	1909.8	/
GSM Voice (1 uplink),GMSK	32.98	32.54	32.97	33±2	29.21	28.26	28.09	30±2
GPRS Multi-Slot Class 8 (1 uplink),GMSK	32.98	32.40	32.88	33±2	29.20	28.25	28.02	30±2
GPRS Multi-Slot Class 10 (2 uplink),GMSK	32.22	31.60	32.24	31±2	28.26	27.82	27.20	28±2
GPRS Multi-Slot Class 12 (4 uplink),GMSK	29.77	29.25	29.75	29±2	26.02	25.64	25.18	26±2
Remark : GPRS, CS1 coding scheme. Multi-Slot Class 8 , Support Max 4 downlink, 1 uplink , 5 working link Multi-Slot Class 10 , Support Max 4 downlink, 2 uplink , 5 working link Multi-Slot Class 12 , Support Max 4 downlink, 4 uplink , 5 working link								

Source Based time Average Power (dBm)								
Band	GSM850				GSM1900			
Channel	128	190	251	Time Average factor	512	661	810	Time Average factor
Frequency (MHz)	824.2	836.6	848.8	/	1850.2	1880	1909.8	/
GSM Voice (1 uplink),GMSK	23.95	23.51	23.94	-9.03	20.18	19.23	19.06	-9.03
GPRS Multi-Slot Class 8 (1 uplink),GMSK	23.95	23.37	23.85	-9.03	20.17	19.22	18.99	-9.03
GPRS Multi-Slot Class 10 (2 uplink),GMSK	26.20	25.58	26.22	-6.02	22.24	21.80	21.18	-6.02
GPRS Multi-Slot Class 12 (4 uplink),GMSK	26.76	26.24	26.74	-3.01	23.01	22.63	22.17	-3.01
Remark : Time average factor = 1 uplink , 10*log(1/8)=-9.03dB , 2 uplink , 10*log(2/8)=-6.02dB , 4 uplink , 10*log(4/8)=-3.01dB Source based time average power = Burst Average power + Time Average factor								

Bluetooth Measurement Result

Channel number	Frequency (MHz)	Peak Output Power(dBm)	Peak Output Power(mW)
1	2402	3.51	2.24
6	2441	3.95	1.98
11	2480	2.23	1.67

9 SAR TEST RESULTS

Test Condition:

1. SAR Measurement
The distance between the EUT and the antenna of the emulator is more than 50 cm and the output power radiated from the emulator antenna is at least 30 dB less than the output power of EUT.
2. Measurement Uncertainty: See page 26 for detail
3. Environmental Conditions
Temperature 23°C
Relative Humidity 53%
Atmospheric Pressure 1019mbar
4. Test Date : May 14th 2012~ May 15th 2012
Tested By : Chris You

Test Procedures:

1. Establish communication link between EUT and base station emulation by air link.
2. Consider the SAR test reduction per FCC KDB guide line. For GSM/GPRS/EGPRS, set EUT into highest output power channel with test mode which has the maximum source-based time-averaged burst power listed in power table. If the source-based time-average output power for each data mode of EGPRS is lower than that in normal GPRS mode, then testing under EGPRS mode is not necessary.
3. Place the EUT in the selected test position. (Cheek, tilt or flat)
4. Perform SAR testing at highest output power channel under the selected test mode. If the measured 1-g SAR is ≤ 0.8 W/kg, then testing for the other channel will not be performed.

SAR measurement system will proceed the following basic steps:

1. Initial power reference measurement
2. Area Scan
3. Zoom Scan
4. Power drift measurement

Test Configuration:

1. EUT was tested under GSM voice call mode for head SAR. Testing on GPRS was performed under 4 uplink slots mode body SAR because this mode has greater source-based time averaged power than other uplink slot mode.

SAR Summary Test Result:
GSM850

Date of Measured : May 14th 2012			Body-Worn Separation Distance:1.5cm					
Position	Channel	Mode	SAR 1g(W/kg)	Limit (W/kg)	Power Drift (%)	Maximum Turn-up Power(dBm)	measured output power (dBm)	Scaled Maximum SAR(W/kg)
Right Head Cheek	Low	GSM voice	0.622	1.6	0.91	35	32.98	0.99
	Mid	GSM voice	0.847	1.6	1.10	35	32.54	1.49
	High	GSM voice	0.644	1.6	1.21	35	32.97	1.03
Right Head Tilt	Low	GSM voice	0.999	1.6	1.12	35	32.98	1.59
	Mid	GSM voice	0.594	1.6	0.12	35	32.54	1.05
	High	GSM voice	0.430	1.6	2.02	35	32.97	0.69
Left Head Cheek	Low	GSM voice	0.691	1.6	1.33	35	32.98	1.10
	Mid	GSM voice	0.859	1.6	0.10	35	32.54	1.51
	High	GSM voice	0.670	1.6	3.10	35	32.97	1.07
Left Head Tilt	Low	GSM voice	0.998	1.6	0.72	35	32.98	1.59
	Mid	GSM voice	0.624	1.6	0.88	35	32.54	1.10
	High	GSM voice	0.453	1.6	0.42	35	32.97	0.72
Body-worn LCD up	Low	GPRS Class 12	0.773	1.6	0.15	31	29.77	1.03
Body-worn LCD down	Low	GPRS Class 12	1.182	1.6	1.90	31	29.77	1.57
	Mid	GPRS Class 12	0.771	1.6	1.39	31	29.25	1.15
	High	GPRS Class 12	0.615	1.6	1.22	31	29.75	0.82

GSM1900:

Date of Measured : May 15th 2012			Body-Worn Separation Distance:1.5cm					
Position	Channel	Mode	SAR 1g(W/kg)	Limit (W/kg)	Power Drift (%)	Maximum Turn-up Power(dBm)	measured output power (dBm)	Scaled Maximum SAR(W/kg)
Right Head Cheek	Low	GSM voice	0.438	1.6	0.16	32	29.21	0.83
Right Head Tilt	Low	GSM voice	0.455	1.6	1.20	32	29.21	0.86
Left Head Cheek	Low	GSM voice	0.321	1.6	0.28	32	29.21	0.61
Left Head Tilt	Low	GSM voice	0.345	1.6	0.21	32	29.21	0.66
Body-worn LCD up	Low	GPRS Class 12	0.203	1.6	0.87	28	26.02	0.32
Body-worn LCD down	Low	GPRS Class 12	0.366	1.6	1.10	28	26.02	0.58

KDB648474 & Simultaneous SAR Evaluation.

Antenna Separation Information:

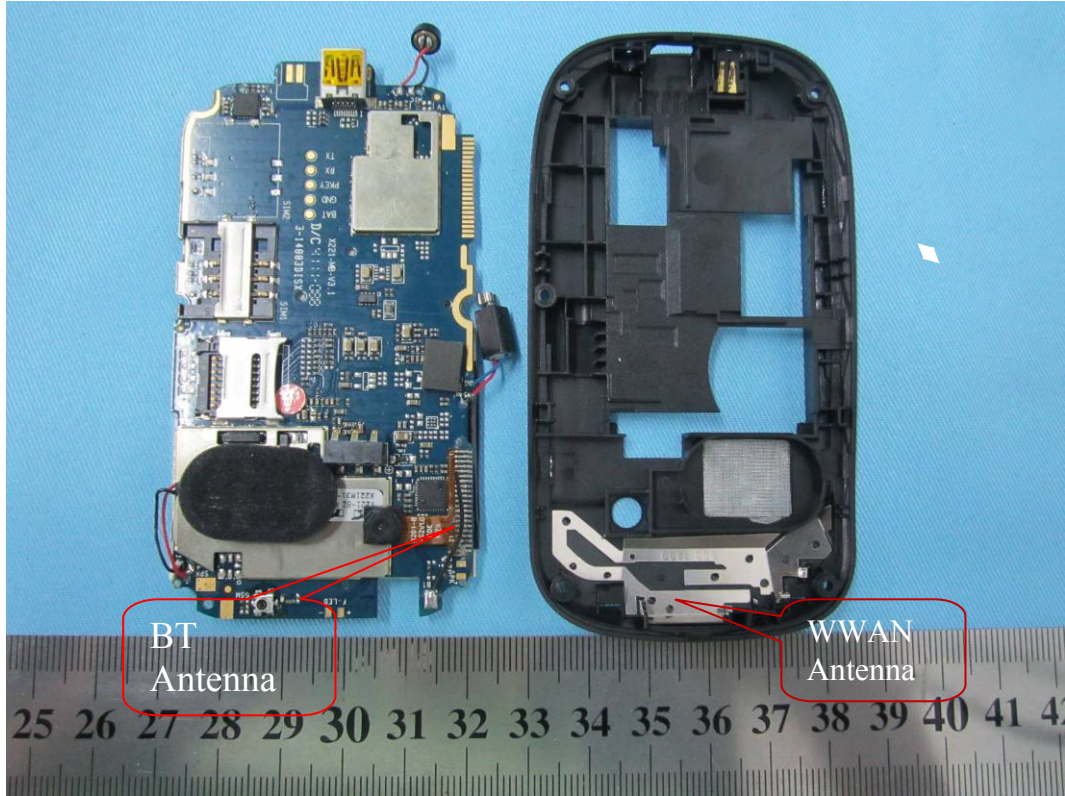

Test Case	TX Ant1	TX Ant2	The shortest distance between Ant & Ant2 (mm)
1	WWAN	BT	2mm

Antenna Pair	Justification	Simultaneous SAR required?
BT / WWAN	BT and WWAN Antenna separation is 0.2cm>2.5cm, the maximum output power is 2.24mW< Pref(12 mW). And the maximum 1-g SAR value is 1.182W/kg<1.2W/kg, so no stand-alone required for BT	No

10 SAR MEASUREMENT REFERENCES

References

1. FCC 47 CFR Part 2 "Frequency Allocations and Radio Treaty Matters; General Rules and Regulations"
2. IEEE Std. C95.1-1991, "IEEE Standard for Safety Levels with Respect to Human Exposure to Radio Frequency Electromagnetic Fields, 3kHz to 300GHz", 1991
3. IEEE Std. 1528-2003, "Recommended Practice for Determining the Peak Spatial-Average Specific Absorption Rate(SAR) in the Human Head from Wireless Communication Devices: Measurement Techniques", December 2003
4. FCC OET Bulletin 65(Edition 97-01) Supplement C(Edition 01-01), "Evaluation Compliance with FCC Guidelines for Human Exposure to Radiofrequency Electromagnetic Fields", June 2001
5. IEC 62209-2, "Human exposure to radio frequency fields from hand-held and body-mounted wireless communication devices—Human models, instrumentation, and procedures – Part 2: Procedure to determine the specific absorption rate(SAR) for wireless communication devices used in close proximity to the human body(frequency range of 30MHz to 6GHz)", March 2010
6. FCC KDB 447498 D01 v04, "Mobile and Portable Device RF Exposure Procedures and Equipment Authorization Policies", November 2009
7. FCC KDB 648474 D01 v01r05, "SAR Evaluation Considerations for Handsets with Multiple Transmitters and Antennas", September 2008
8. FCC KDB 941225 D04 v01, "Evaluation SAR for GSM/(E)GPRS Dual Transfer Mode", January 27 2010
9. FCC KDB 941225 D03 v01, "Evaluation SAR Test Reduction Procedures for GSM/GPRS/EDGE", December 2008

SAR measurement Plots

Test mode: GSM850, low channel (Right Head Cheek)
 Product Description: GSM Mobile Phone
 Model: LQ310
 Test Date: May 14th 2012

Medium(liquid type)	HSL_850
Frequency (MHz)	824.20000
Relative permittivity (real part)	41.66
Conductivity (S/m)	0.92
Crest factor	8.0
Conversion Factor	8.78
Area Scan	dx=8mm dy=8mm
Zoom Scan	5x5x7, dx=8mm dy=8mm dz=5mm
Variation (%)	0.910000
SAR 10g (W/Kg)	0.460
SAR 1g (W/Kg)	0.622
SURFACE SAR	VOLUME SAR

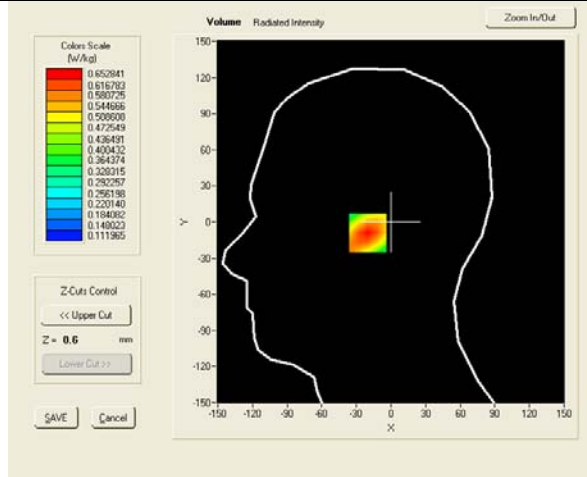
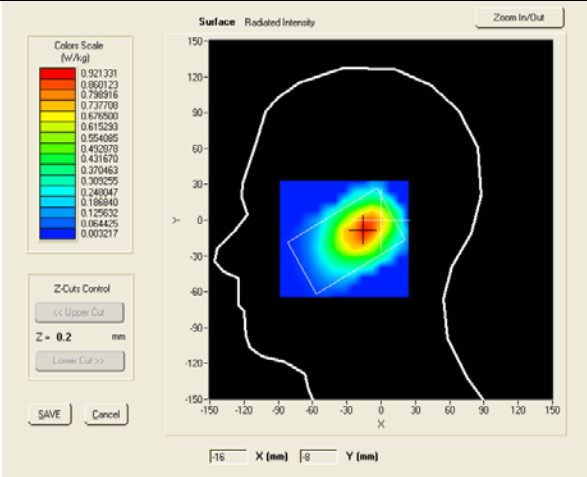

SAR, Z Axis Scan (X = -16, Y = -9)

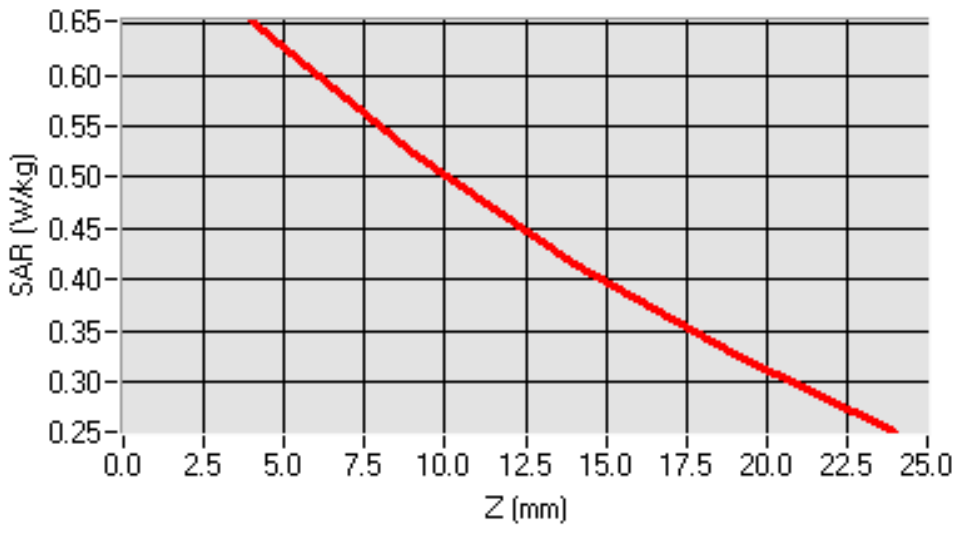

3D screen shot

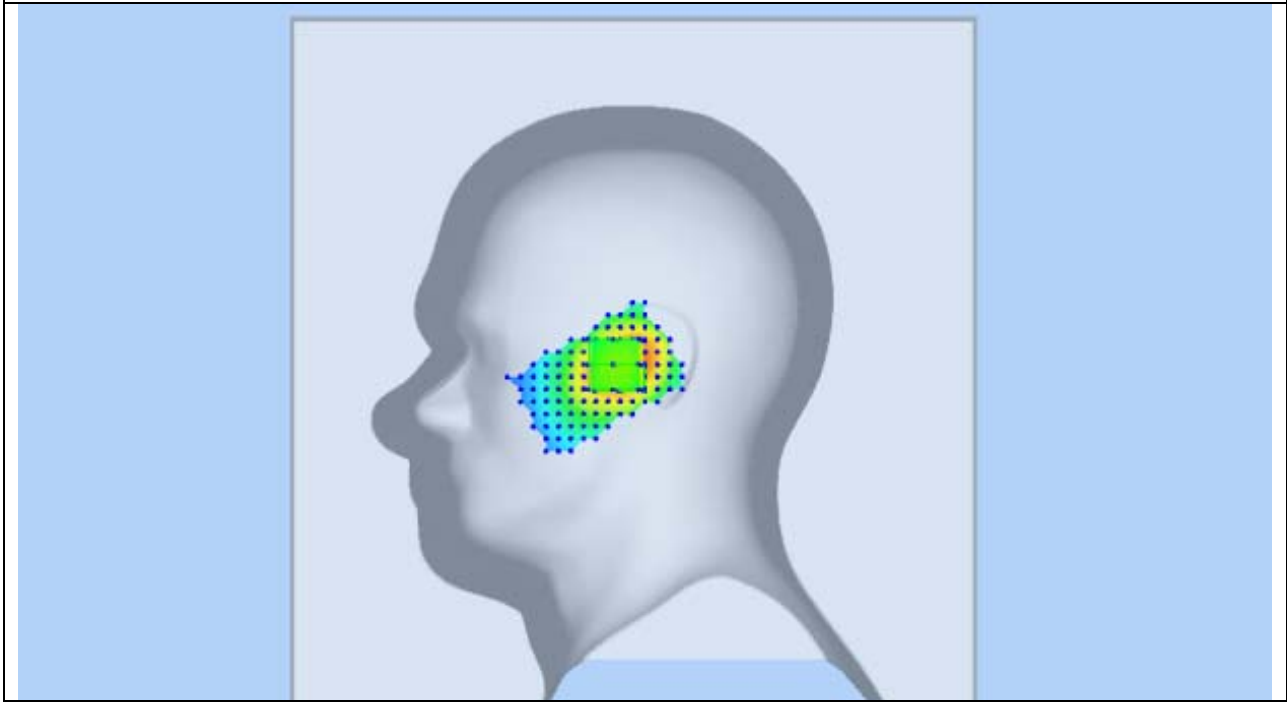

Test mode: GSM850, middle channel (Right Head Cheek)
 Product Description: GSM Mobile Phone
 Model: LQ310
 Test Date: May 14th 2012

Medium(liquid type)	HSL_850
Frequency (MHz)	836.40000
Relative permittivity (real part)	41.76
Conductivity (S/m)	0.92
Crest factor	8.0
Conversion Factor	8.78
Area Scan	dx=8mm dy=8mm
Zoom Scan	5x5x7,dx=8mm dy=8mm dz=5mm
Variation (%)	1.10000
SAR 10g (W/Kg)	0.630
SAR 1g (W/Kg)	0.847

SURFACE SAR

VOLUME SAR

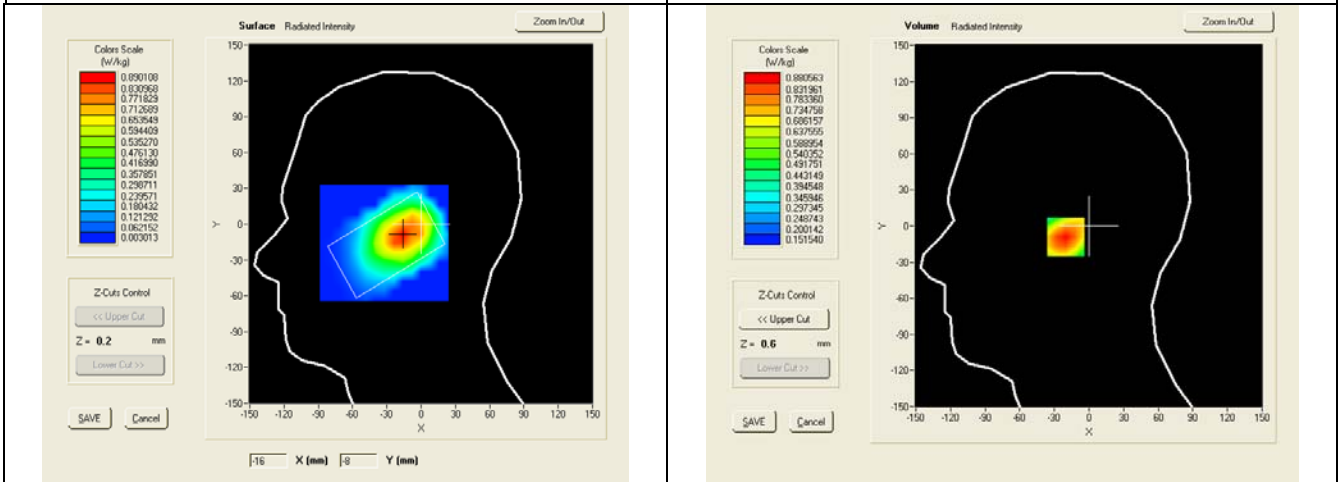

SAR, Z Axis Scan (X = -16, Y = -9)

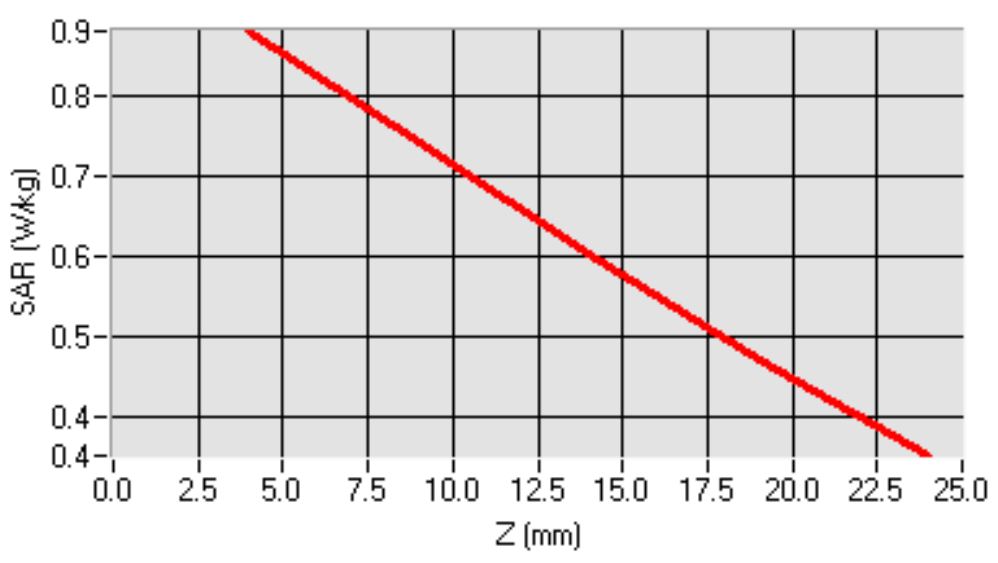



SIEMIC, Inc.

Accessing global markets

Title: RF Test Report of GSM Mobile Phone

Model : LQ310

To C95.1, IEEE 1528, OET Bulletin 65 Supplement C, IEC62209-2 & RSS-102
Issue 4 and Safety Code 6

Serial# 12050036-FCC-H

Issue Date May 18th 2012

Page 40 of 127

www.siemic.com

3D screen shot

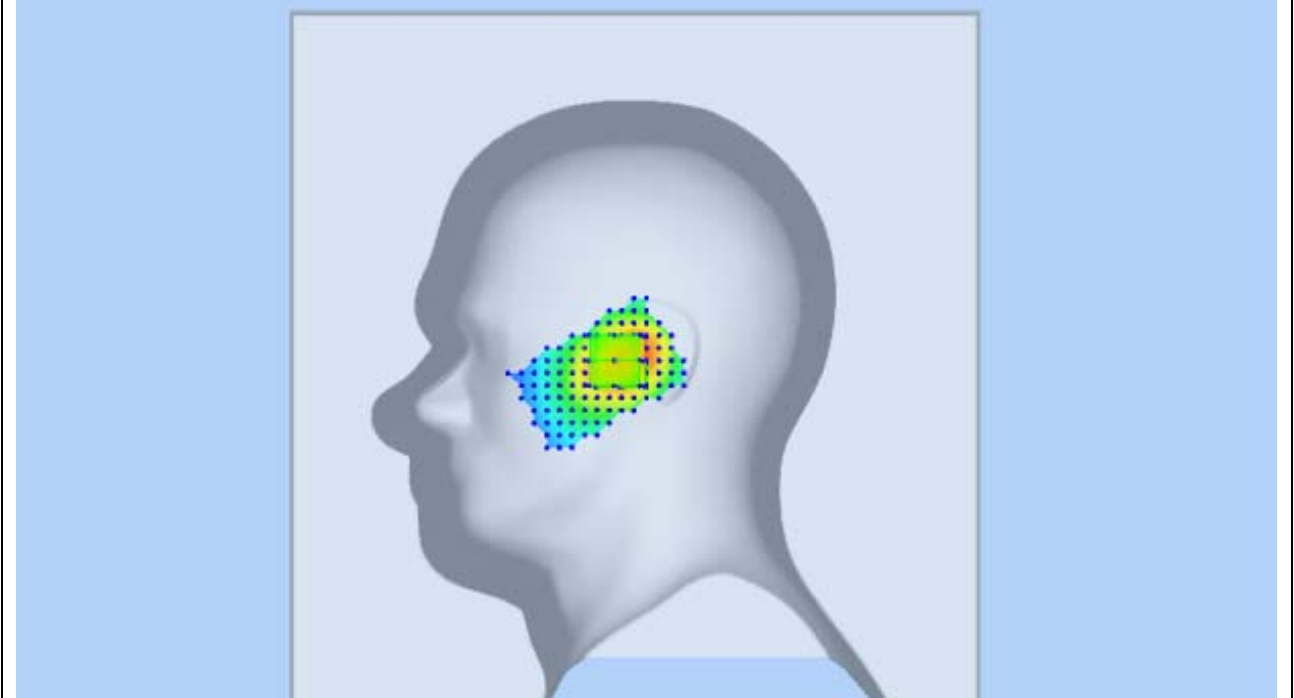

Test mode: GSM850, high channel (Right Head Cheek)
 Product Description: GSM Mobile Phone
 Model: LQ310
 Test Date: May 14th 2012

Medium(liquid type)	HSL_850
Frequency (MHz)	848.80000
Relative permittivity (real part)	41.85
Conductivity (S/m)	0.92
Crest factor	8.0
Conversion Factor	8.78
Area Scan	dx=8mm dy=8mm
Zoom Scan	5x5x7, dx=8mm dy=8mm dz=5mm
Variation (%)	1.210000
SAR 10g (W/Kg)	0.471
SAR 1g (W/Kg)	0.644

SURFACE SAR

VOLUME SAR

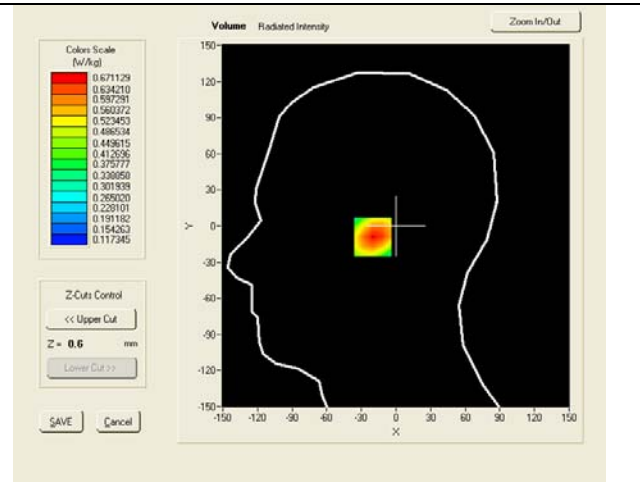
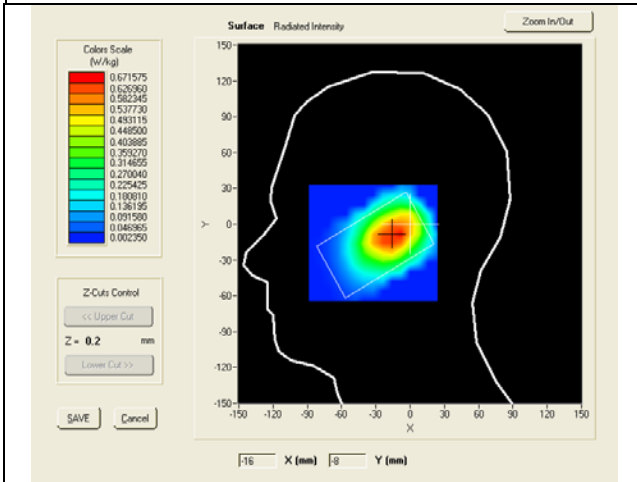

SAR, Z Axis Scan (X = -16, Y = -9)

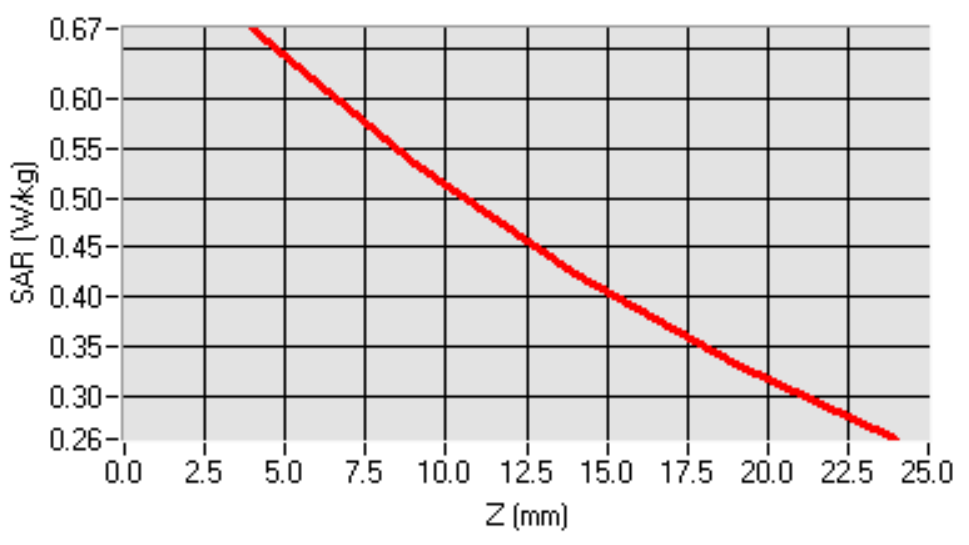

3D screen shot

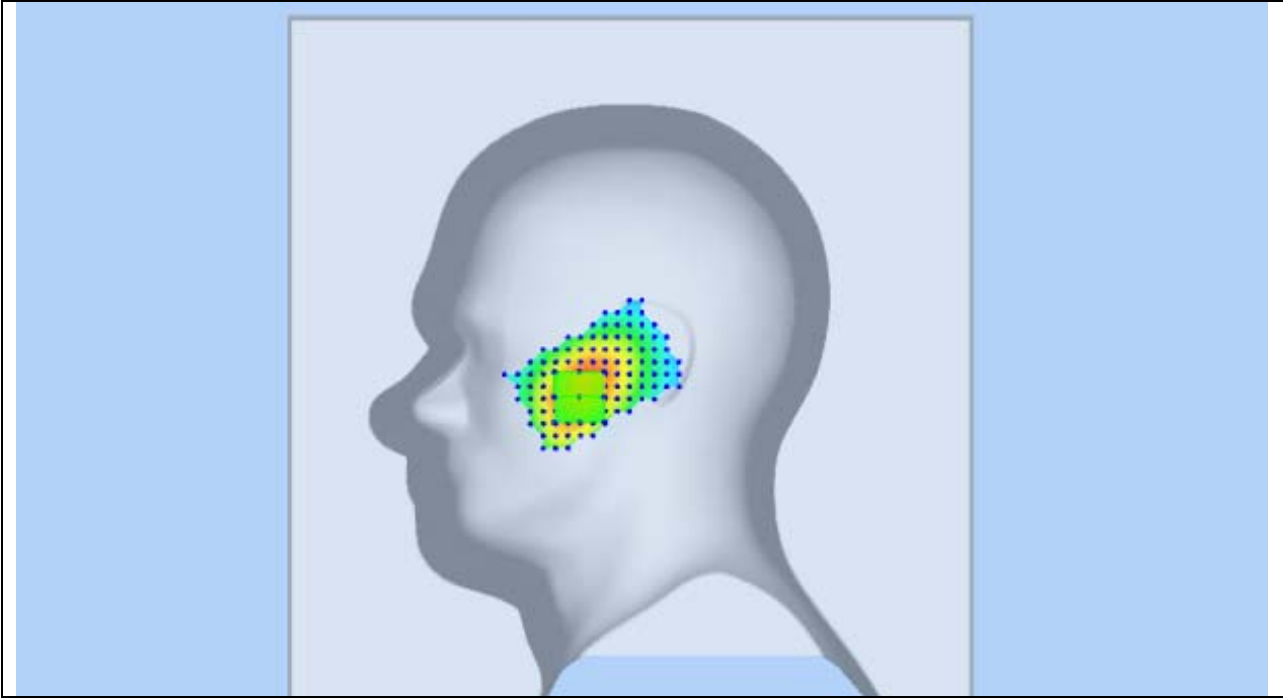

Test mode: GSM850, low channel (Right Head Tilt)
 Product Description: GSM Mobile Phone
 Model: LQ310
 Test Date: May 14th 2012

Medium(liquid type)	HSL_850
Frequency (MHz)	824.20000
Relative permittivity (real part)	41.66
Conductivity (S/m)	0.92
Crest factor	8.0
Conversion Factor	8.78
Area Scan	dx=8mm dy=8mm
Zoom Scan	5x5x7,dx=8mm dy=8mm dz=5mm
Variation (%)	1.120000
SAR 10g (W/Kg)	0.744
SAR 1g (W/Kg)	0.999
SURFACE SAR	VOLUME SAR

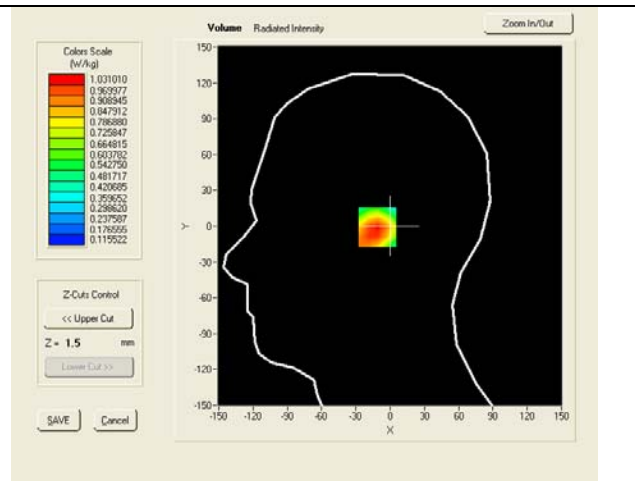
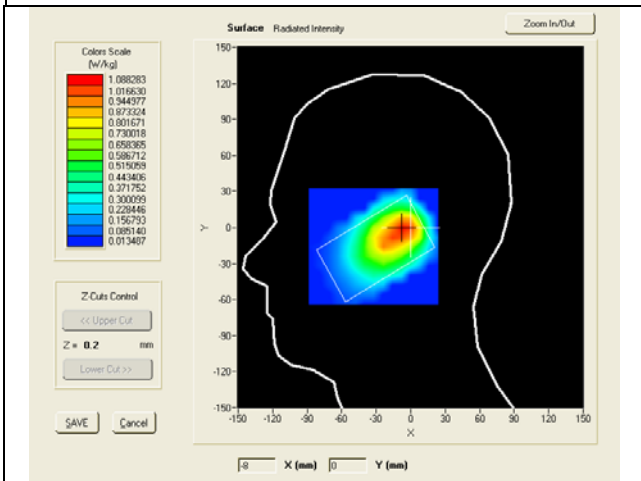

SAR, Z Axis Scan (X = -7, Y = -1)

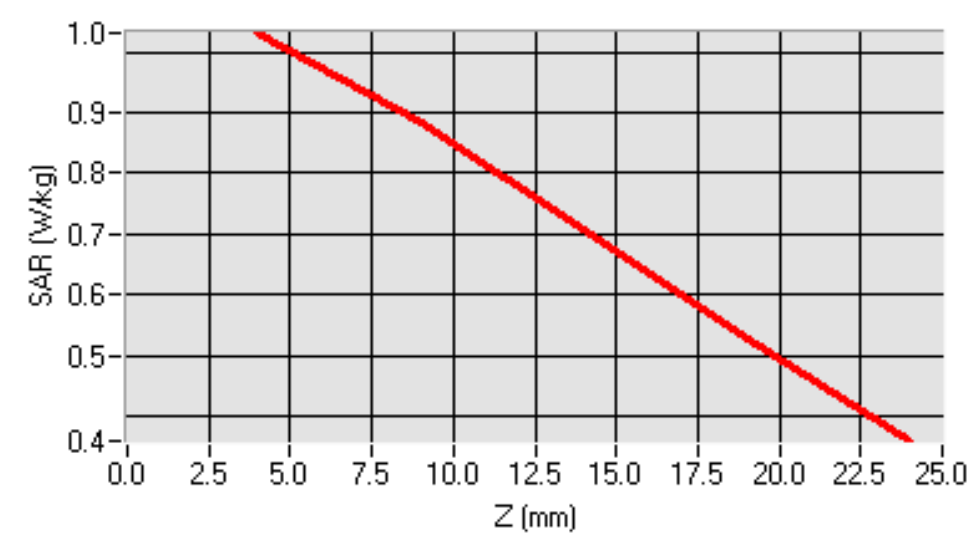



SIEMIC, Inc.

Accessing global markets

Title: RF Test Report of GSM Mobile Phone

Model : LQ310

To C95.1, IEEE 1528, OET Bulletin 65 Supplement C, IEC62209-2 & RSS-102
Issue 4 and Safety Code 6

Serial# 12050036-FCC-H

Issue Date May 18th 2012

Page 44 of 127

www.siemic.com

3D screen shot

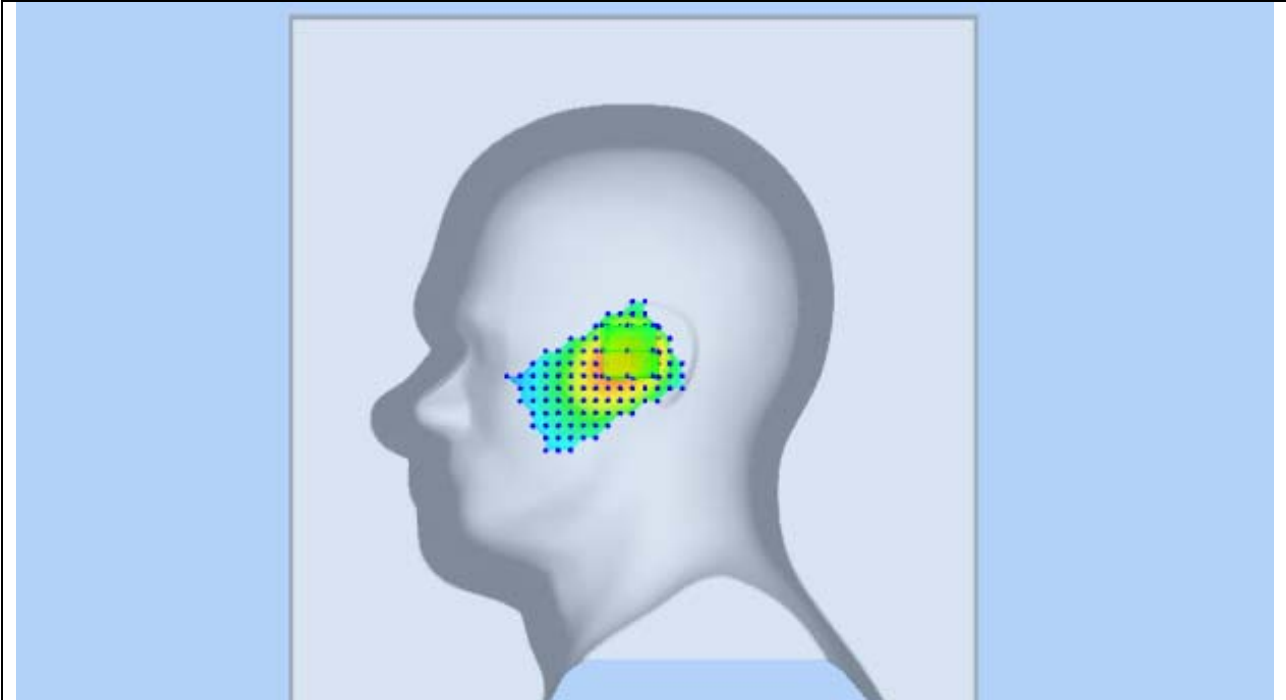

Test mode: GSM850, middle channel (Right Head Tilt)
 Product Description: GSM Mobile Phone
 Model: LQ310
 Test Date: May 14th 2012

Medium(liquid type)	HSL_850
Frequency (MHz)	836.40000
Relative permittivity (real part)	41.76
Conductivity (S/m)	0.92
Crest factor	8.0
Conversion Factor	8.78
Area Scan	dx=8mm dy=8mm
Zoom Scan	5x5x7, dx=8mm dy=8mm dz=5mm
Variation (%)	0.120000
SAR 10g (W/Kg)	0.404
SAR 1g (W/Kg)	0.594

SURFACE SAR

VOLUME SAR

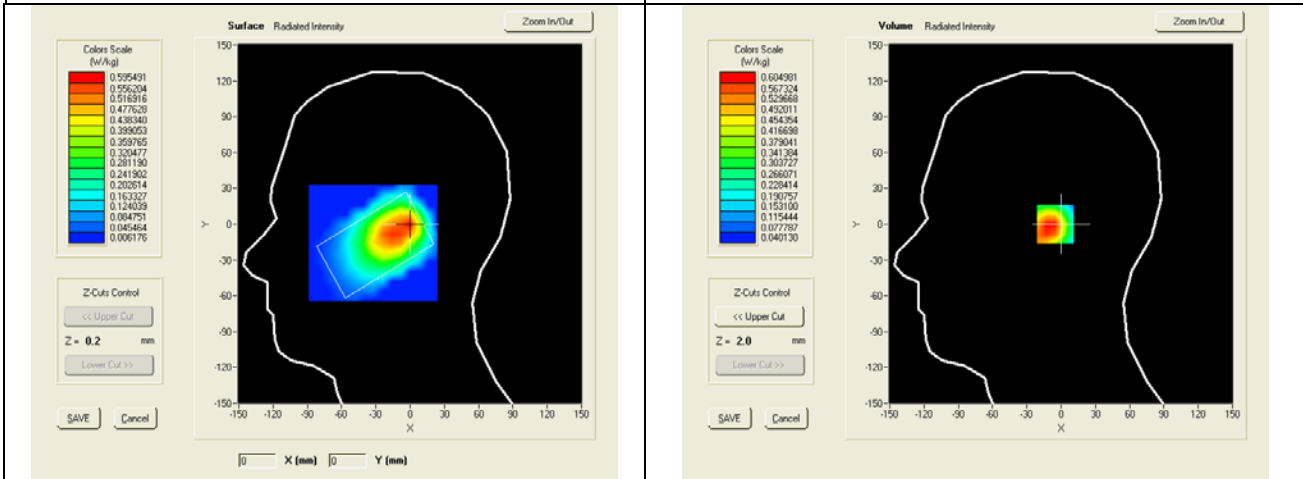

SAR, Z Axis Scan (X = -1, Y = 0)

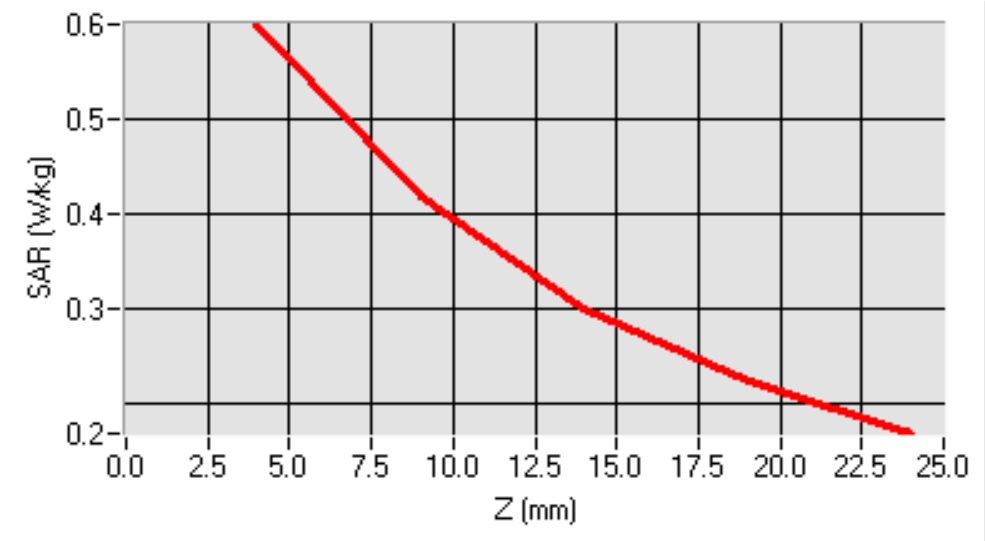

3D screen shot

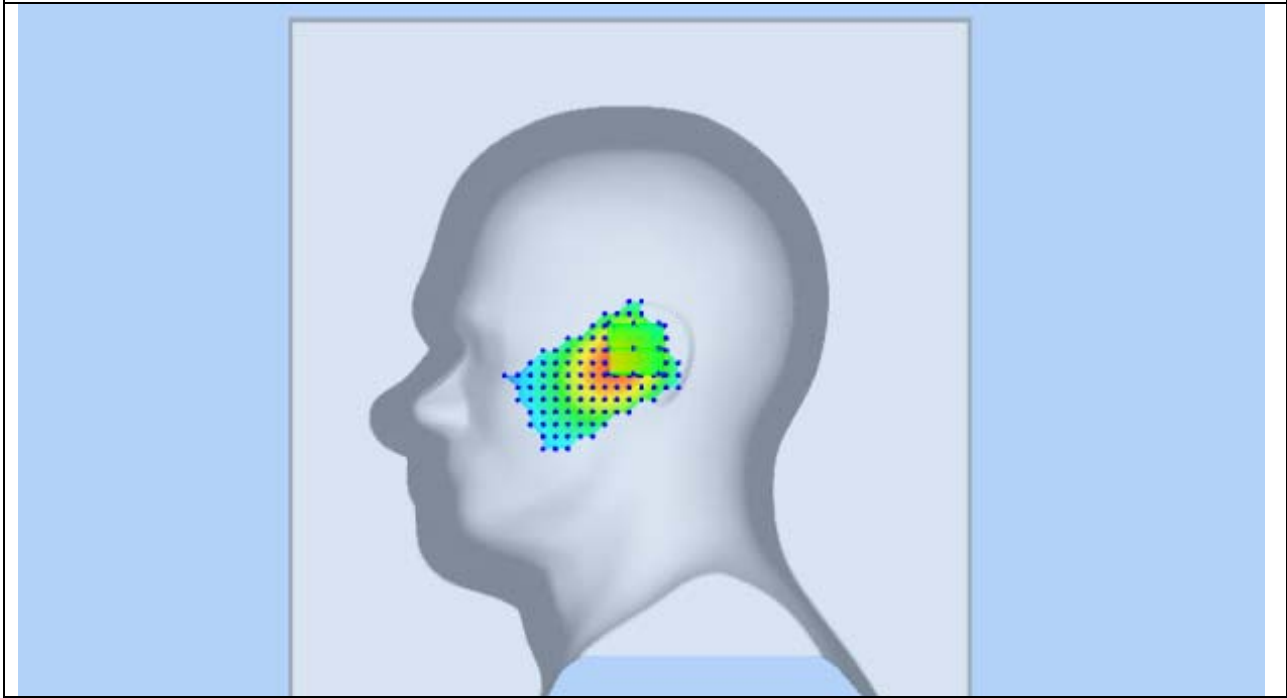

Test mode: GSM850, high channel (Right Head Tilt)
 Product Description: GSM Mobile Phone
 Model: LQ310
 Test Date: May 14th 2012

Medium(liquid type)	HSL_850
Frequency (MHz)	848.80000
Relative permittivity (real part)	41.85
Conductivity (S/m)	0.92
Crest factor	8.0
Conversion Factor	8.78
Area Scan	dx=8mm dy=8mm
Zoom Scan	5x5x7, dx=8mm dy=8mm dz=5mm
Variation (%)	2.020000
SAR 10g (W/Kg)	0.323
SAR 1g (W/Kg)	0.430

SURFACE SAR

VOLUME SAR

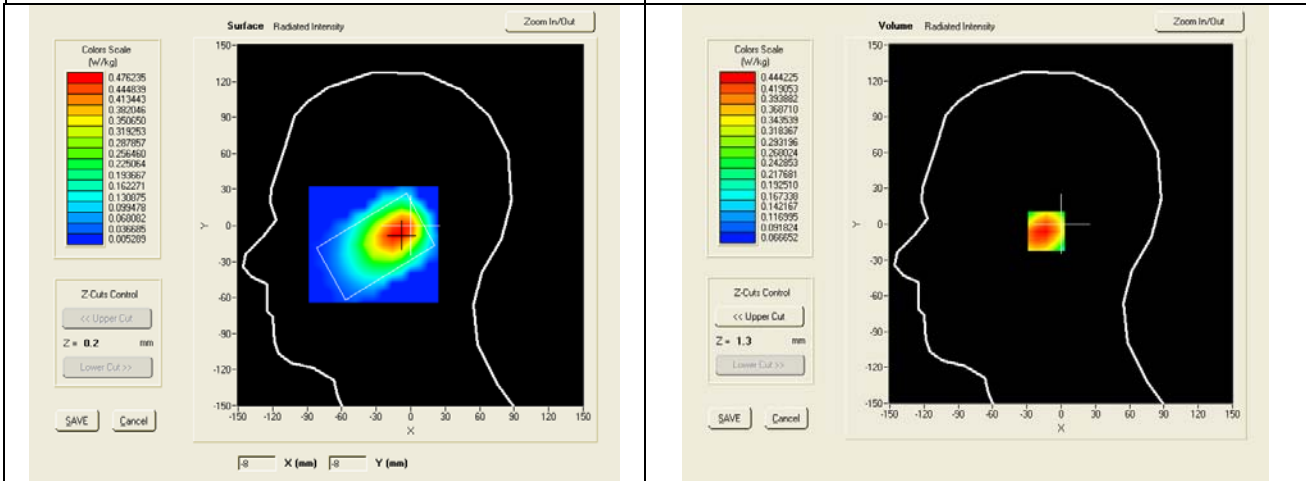

SAR, Z Axis Scan (X = -9, Y = -6)

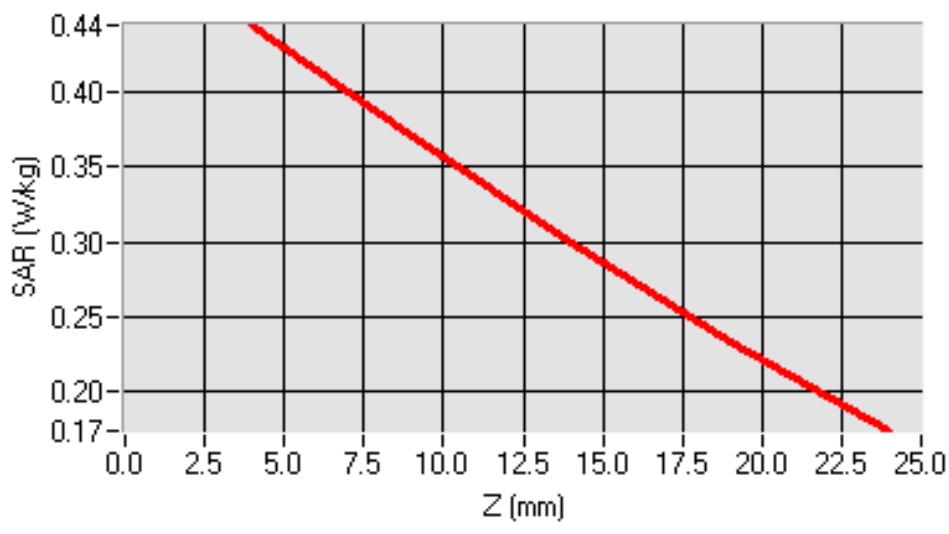

3D screen shot

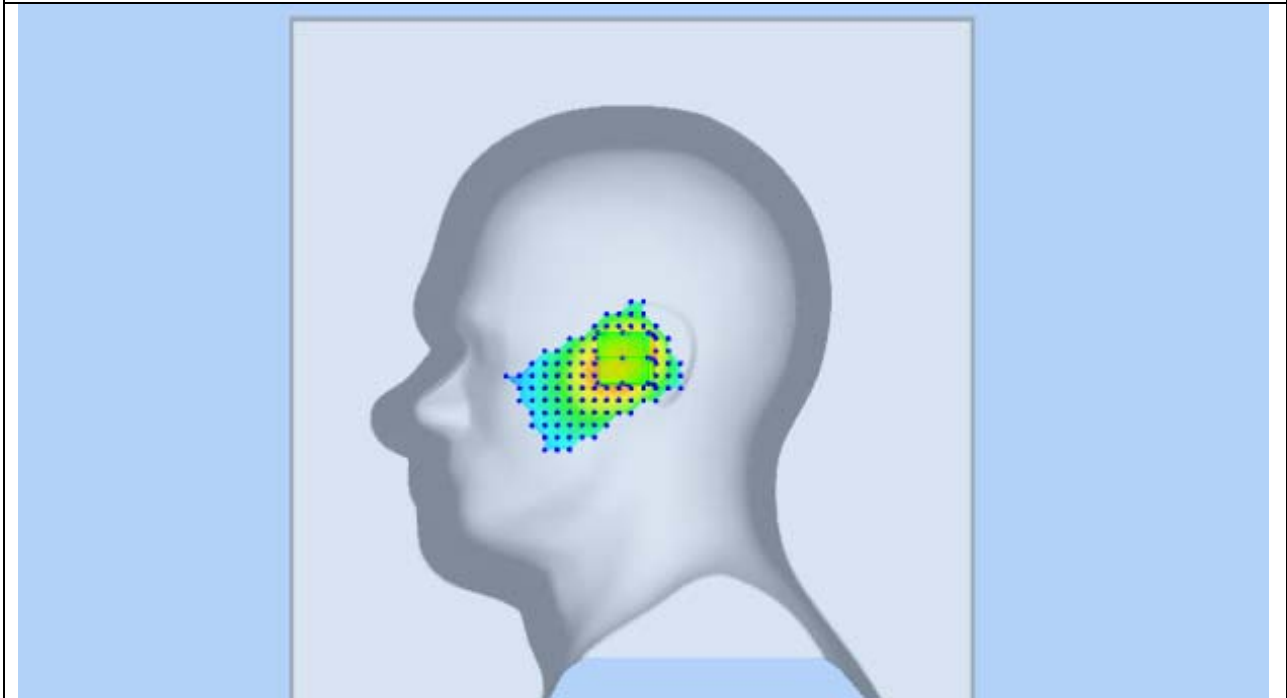

Test mode: GSM850, low channel (Left Head Cheek)
 Product Description: GSM Mobile Phone
 Model: LQ310
 Test Date: May 14th 2012

Medium(liquid type)	HSL_850
Frequency (MHz)	824.20000
Relative permittivity (real part)	41.66
Conductivity (S/m)	0.92
Crest factor	8.0
Conversion Factor	8.78
Area Scan	dx=8mm dy=8mm
Zoom Scan	5x5x7, dx=8mm dy=8mm dz=5mm
Variation (%)	1.330000
SAR 10g (W/Kg)	0.498
SAR 1g (W/Kg)	0.691

SURFACE SAR

VOLUME SAR

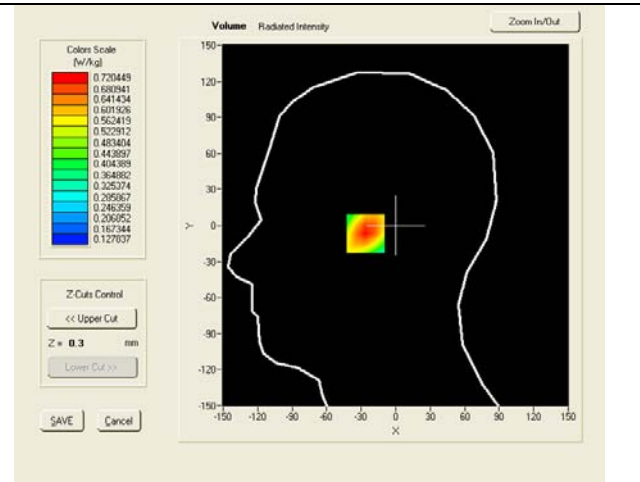
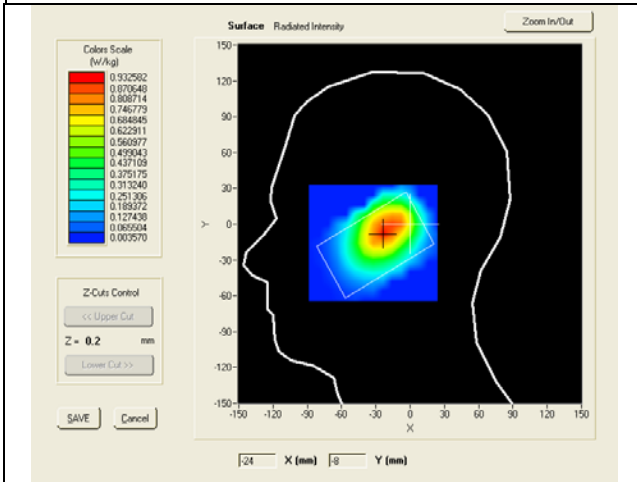

SAR, Z Axis Scan (X = -23, Y = -7)

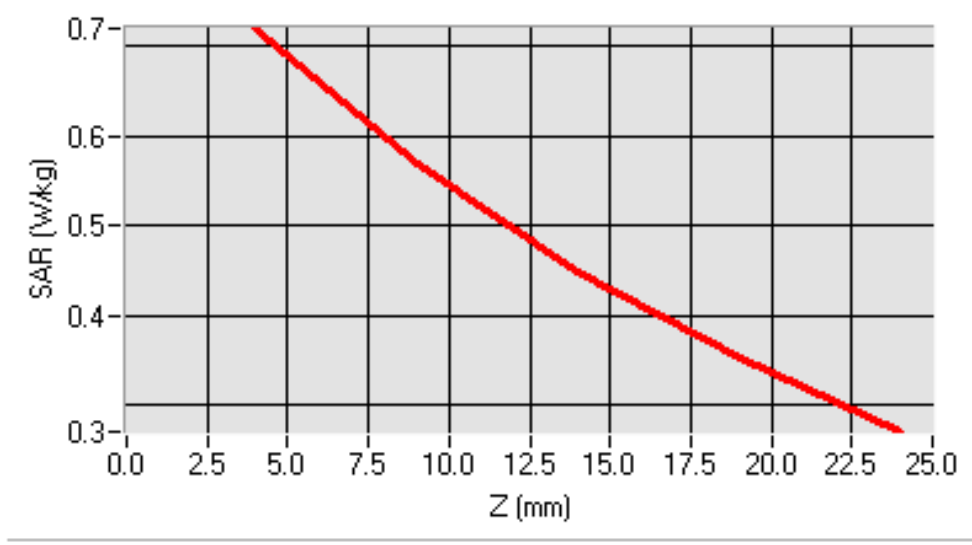



SIEMIC, Inc.

Accessing global markets

Title: RF Test Report of GSM Mobile Phone

Model : LQ310

To C95.1, IEEE 1528, OET Bulletin 65 Supplement C, IEC62209-2 & RSS-102
Issue 4 and Safety Code 6

Serial# 12050036-FCC-H

Issue Date May 18th 2012

Page 50 of 127

www.sieminc.com

3D screen shot

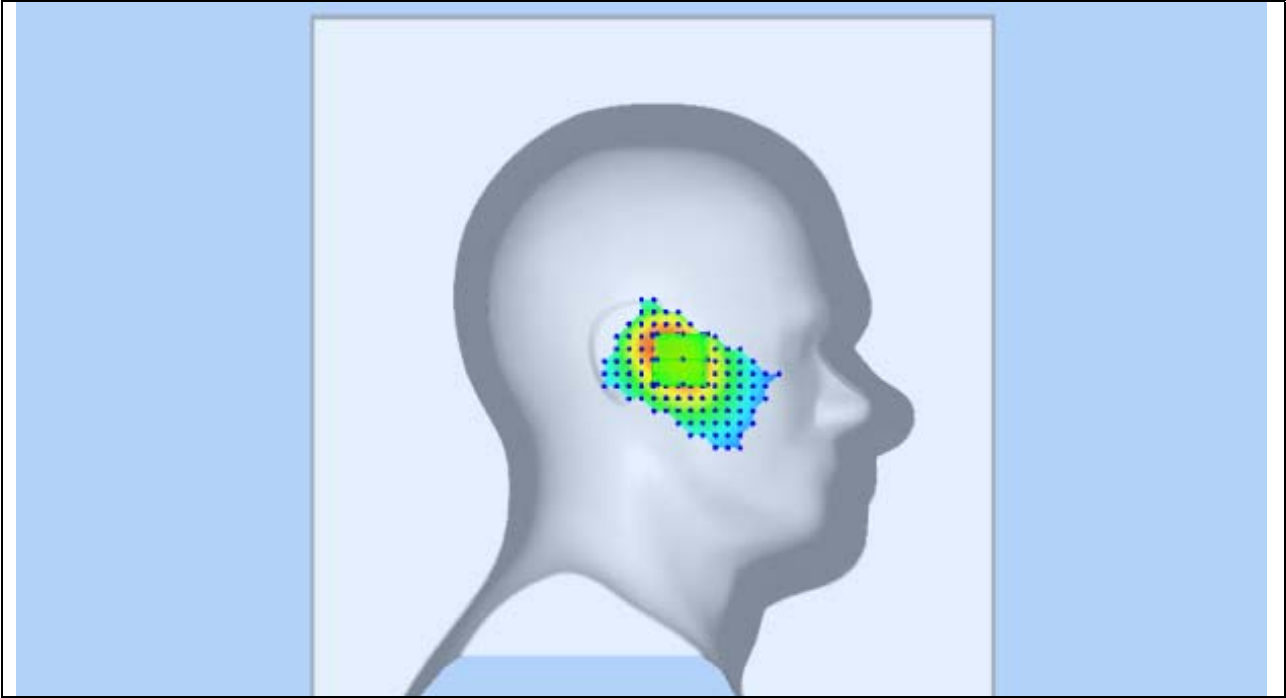

Test mode: GSM850, middle channel (Left Head Cheek)
 Product Description: GSM Mobile Phone
 Model: LQ310
 Test Date: May 14th 2012

Medium(liquid type)	HSL_850
Frequency (MHz)	836.40000
Relative permittivity (real part)	41.76
Conductivity (S/m)	0.92
Crest factor	8.0
Conversion Factor	8.78
Area Scan	dx=8mm dy=8mm
Zoom Scan	5x5x7, dx=8mm dy=8mm dz=5mm
Variation (%)	0.10000
SAR 10g (W/Kg)	0.642
SAR 1g (W/Kg)	0.859

SURFACE SAR

VOLUME SAR

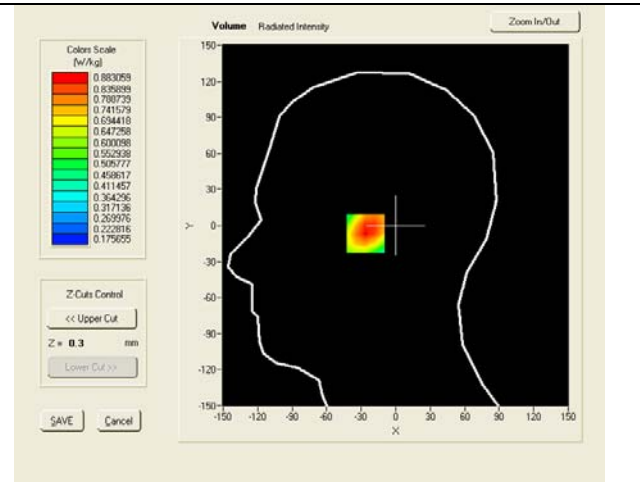
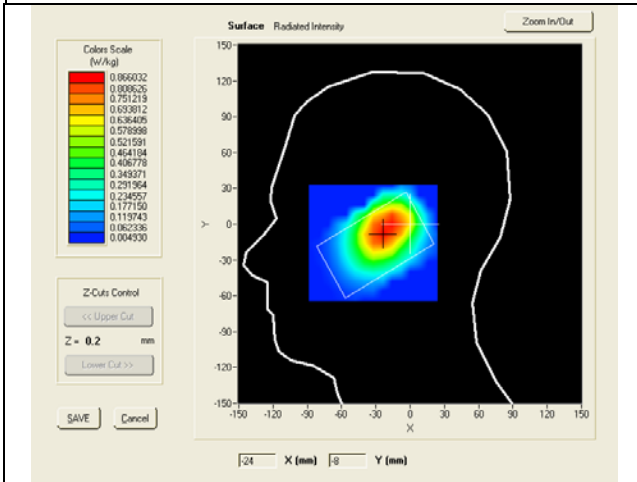

SAR, Z Axis Scan (X = -23, Y = -7)

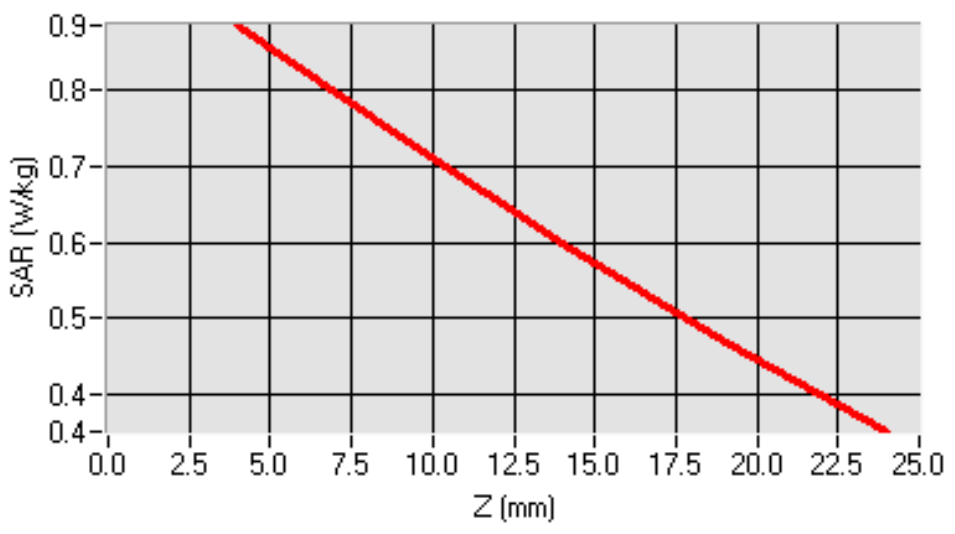



SIEMIC, Inc.

Accessing global markets

Title: RF Test Report of GSM Mobile Phone

Model : LQ310

To C95.1, IEEE 1528, OET Bulletin 65 Supplement C, IEC62209-2 & RSS-102
Issue 4 and Safety Code 6

Serial# 12050036-FCC-H

Issue Date May 18th 2012

Page 52 of 127

www.siemic.com

3D screen shot

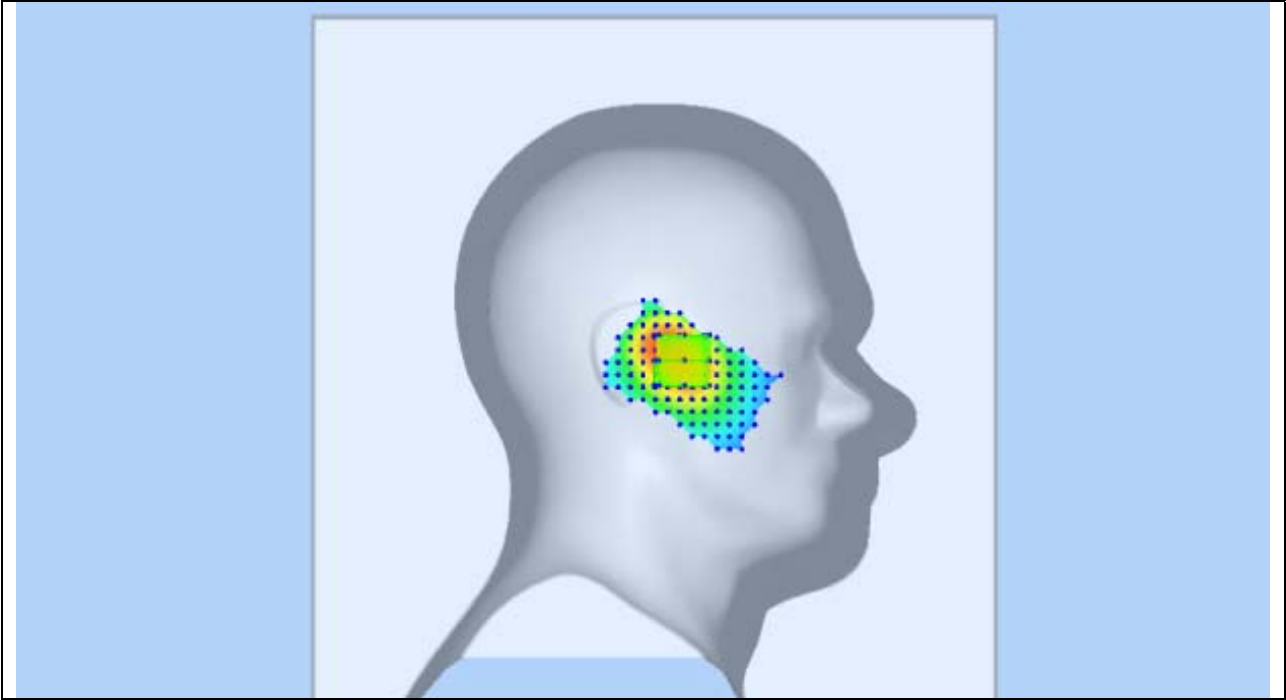

Test mode: GSM850, high channel (Left Head Cheek)
 Product Description: GSM Mobile Phone
 Model: LQ310
 Test Date: May 14th 2012

Medium(liquid type)	HSL_850
Frequency (MHz)	848.80000
Relative permittivity (real part)	41.85
Conductivity (S/m)	0.92
Crest factor	8.0
Conversion Factor	8.78
Area Scan	dx=8mm dy=8mm
Zoom Scan	5x5x7,dx=8mm dy=8mm dz=5mm
Variation (%)	3.10000
SAR 10g (W/Kg)	0.493
SAR 1g (W/Kg)	0.670

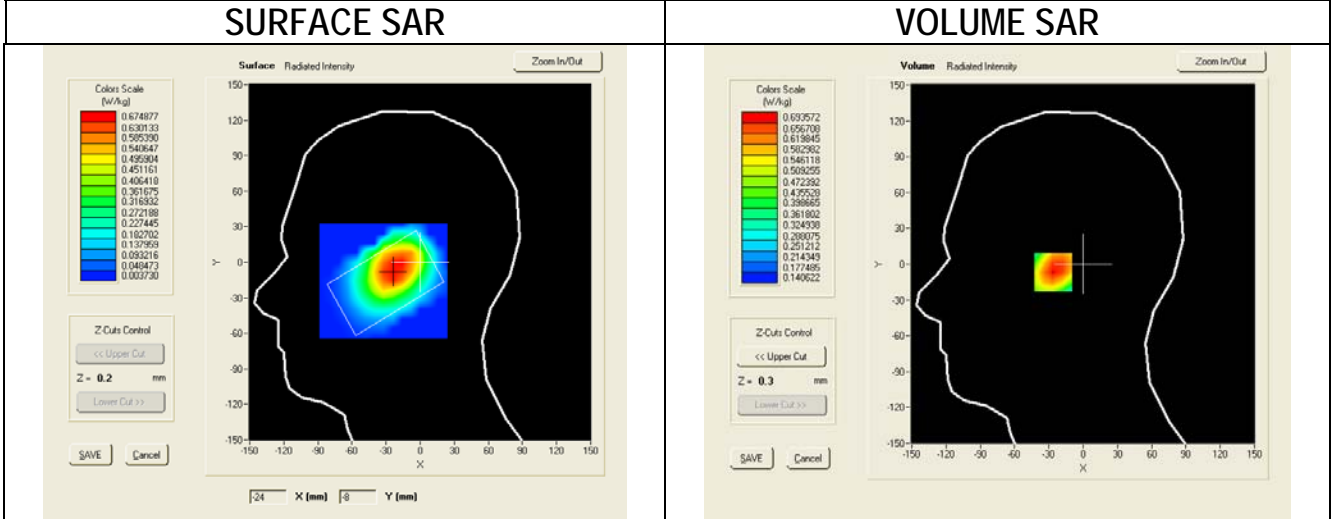

SAR, Z Axis Scan (X = -23, Y = -7)

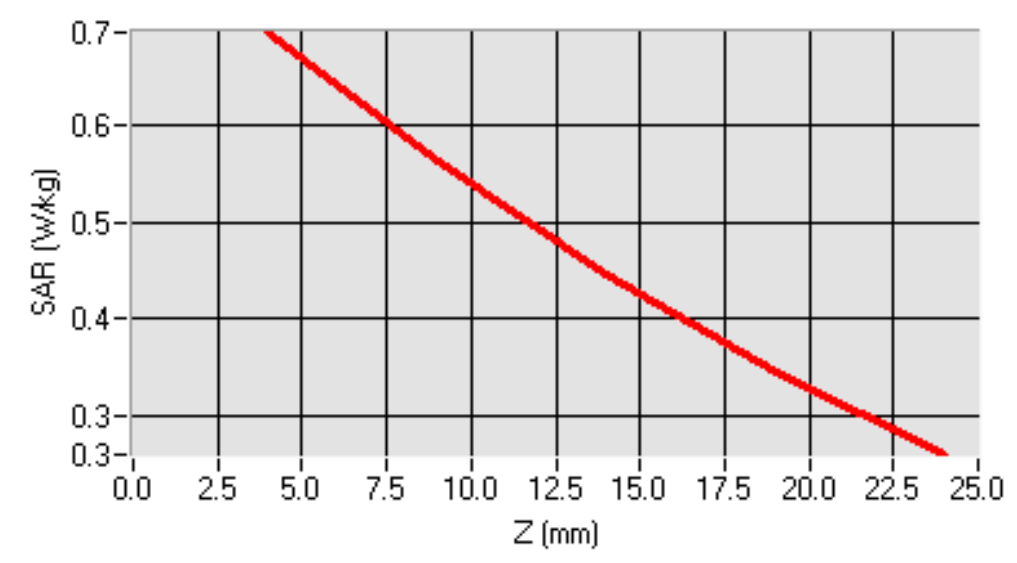

3D screen shot

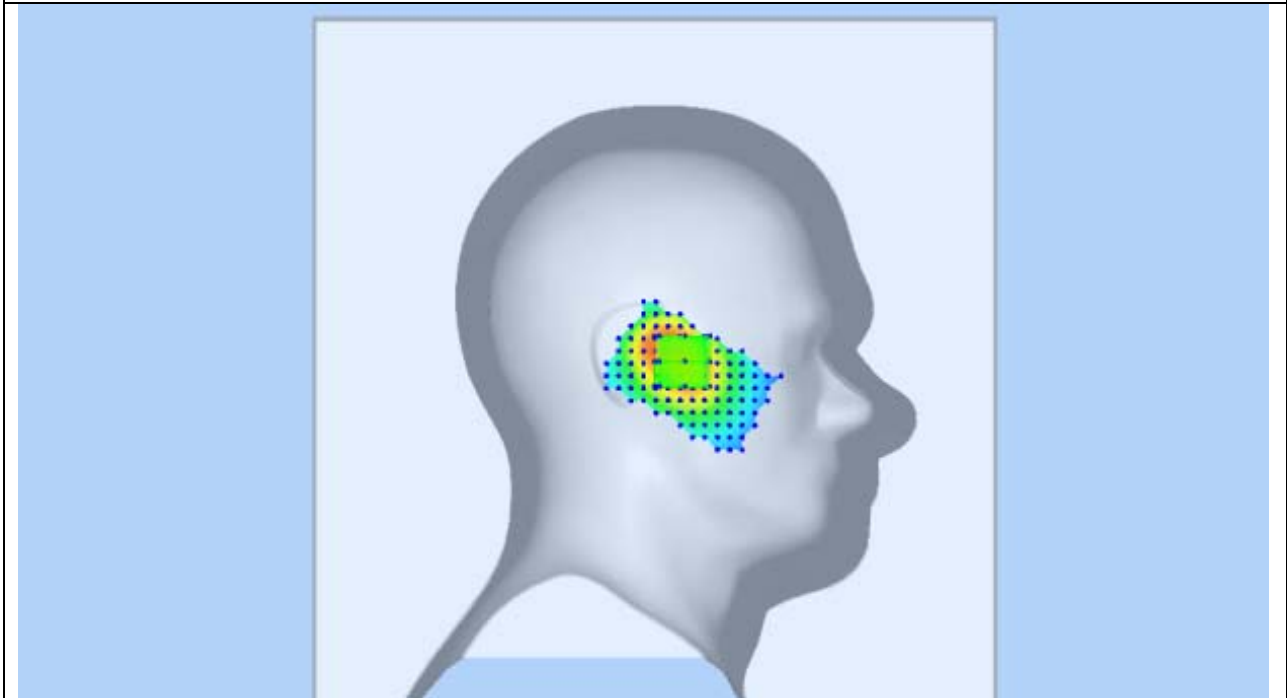

Test mode: GSM850, low channel (Left Head Tilt)
 Product Description: GSM Mobile Phone
 Model: LQ310
 Test Date: May 14th 2012

Medium(liquid type)	HSL_850
Frequency (MHz)	824.20000
Relative permittivity (real part)	41.66
Conductivity (S/m)	0.92
Crest factor	8.0
Conversion Factor	8.78
Area Scan	dx=8mm dy=8mm
Zoom Scan	5x5x7,dx=8mm dy=8mm dz=5mm
Variation (%)	0.720000
SAR 10g (W/Kg)	0.756
SAR 1g (W/Kg)	0.998
SURFACE SAR	VOLUME SAR

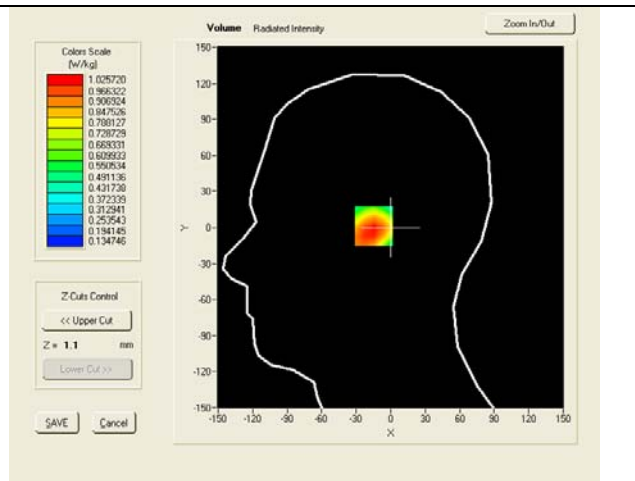
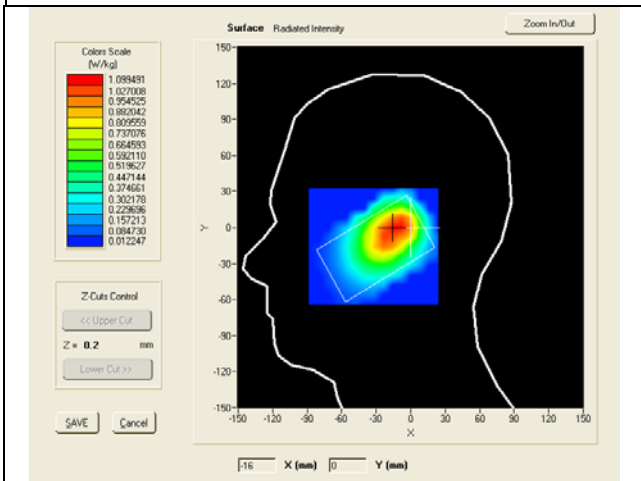

SAR, Z Axis Scan (X = -11, Y = 1)

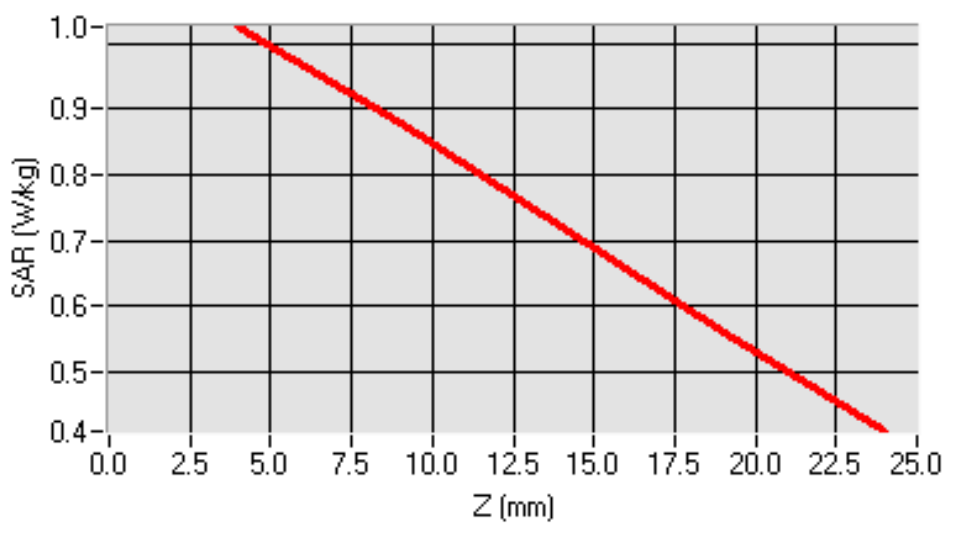



SIEMIC, Inc.

Accessing global markets

Title: RF Test Report of GSM Mobile Phone

Model : LQ310

To C95.1, IEEE 1528, OET Bulletin 65 Supplement C, IEC62209-2 & RSS-102
Issue 4 and Safety Code 6

Serial# 12050036-FCC-H

Issue Date May 18th 2012

Page 56 of 127

www.siemic.com

3D screen shot

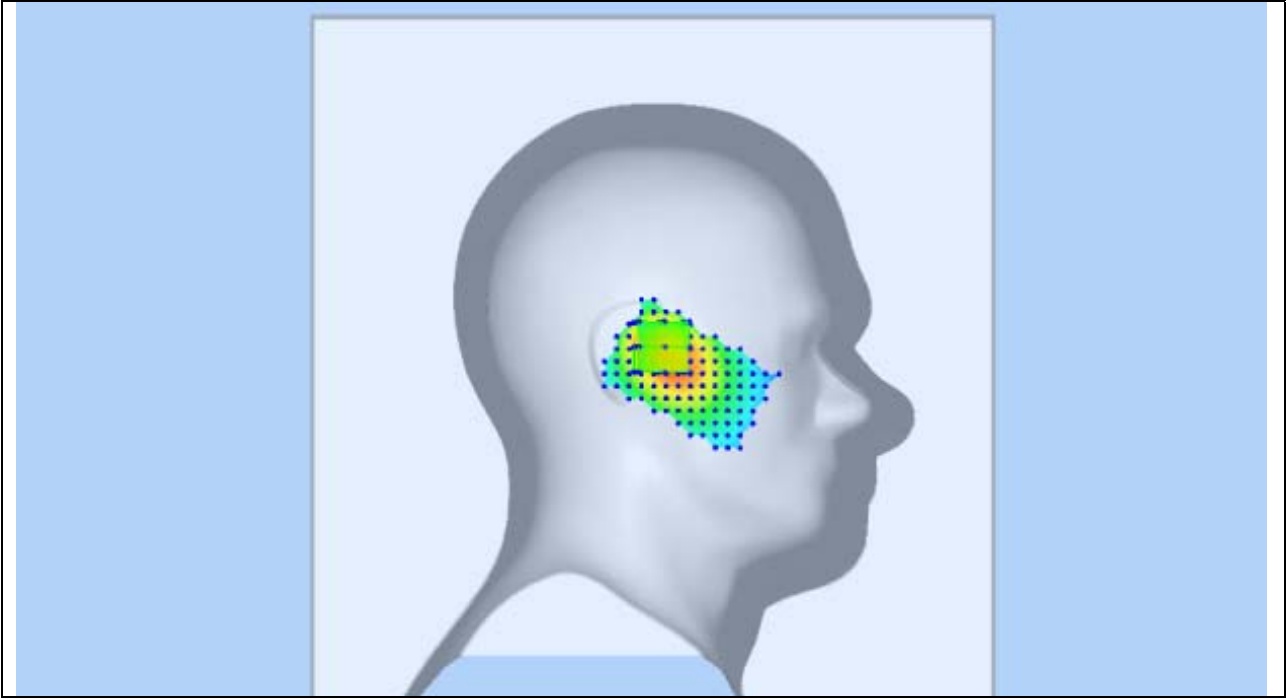

Test mode: GSM850, middle channel (Left Head Tilt)
 Product Description: GSM Mobile Phone
 Model: LQ310
 Test Date: May 14th 2012

Medium(liquid type)	HSL_850
Frequency (MHz)	836.40000
Relative permittivity (real part)	41.76
Conductivity (S/m)	0.92
Crest factor	8.0
Conversion Factor	8.78
Area Scan	dx=8mm dy=8mm
Zoom Scan	5x5x7,dx=8mm dy=8mm dz=5mm
Variation (%)	0.880000
SAR 10g (W/Kg)	0.434
SAR 1g (W/Kg)	0.624

SURFACE SAR

VOLUME SAR

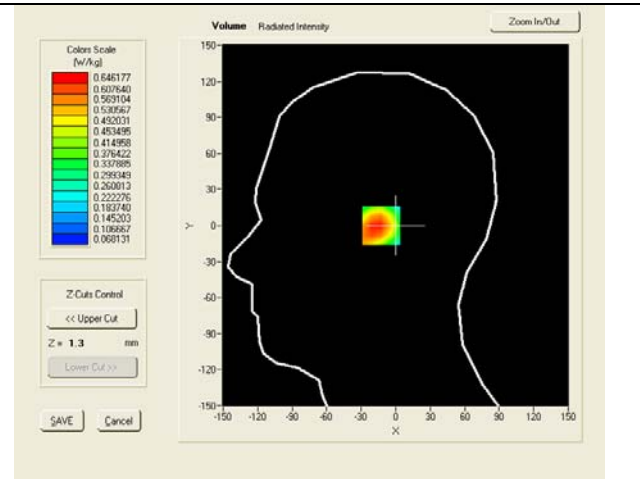
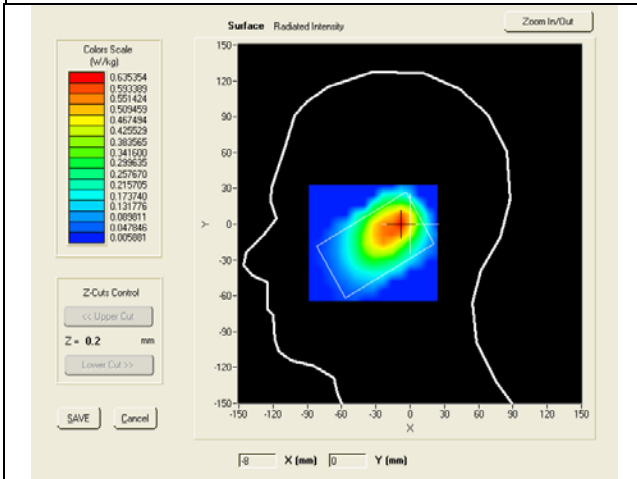

SAR, Z Axis Scan (X = -9, Y = 0)

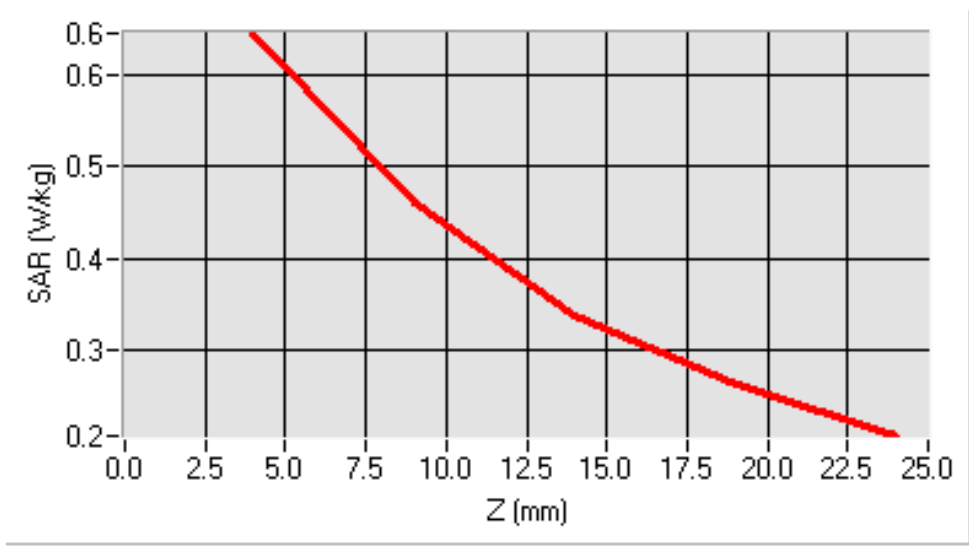

3D screen shot

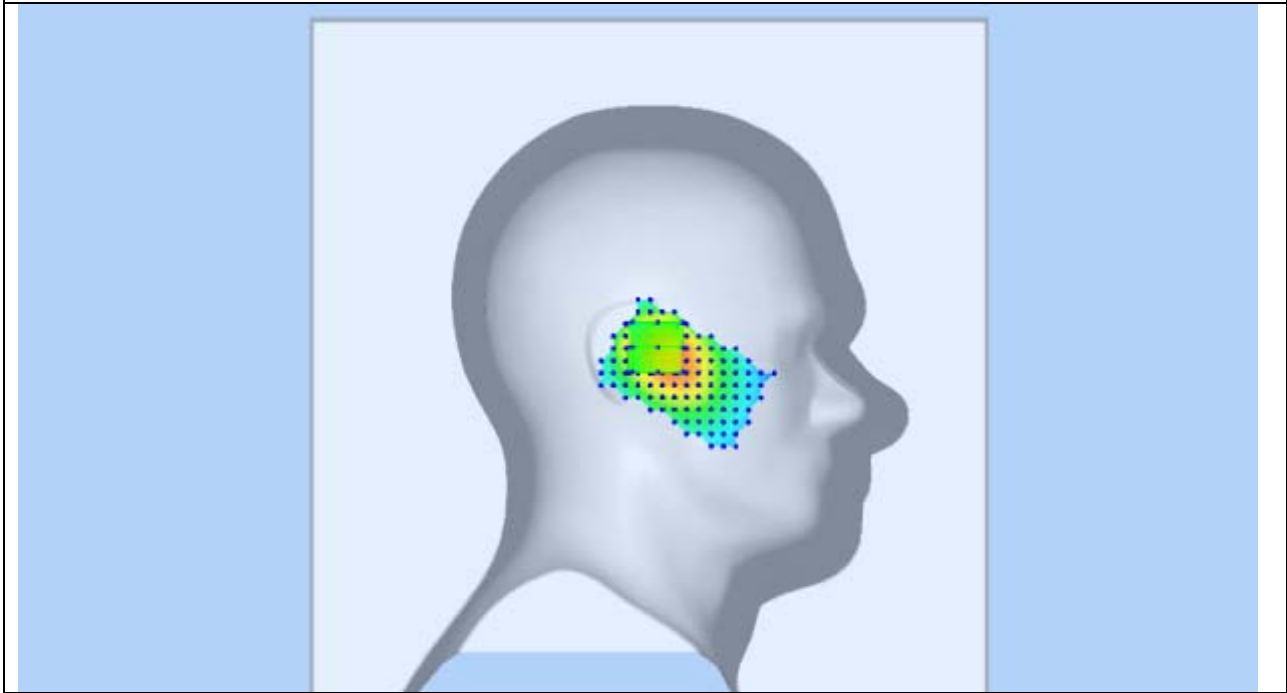

Test mode: GSM850, high channel (Left Head Tilt)
 Product Description: GSM Mobile Phone
 Model: LQ310
 Test Date: May 14th 2012

Medium(liquid type)	HSL_850
Frequency (MHz)	848.80000
Relative permittivity (real part)	41.85
Conductivity (S/m)	0.92
Crest factor	8.0
Conversion Factor	8.78
Area Scan	dx=8mm dy=8mm
Zoom Scan	5x5x7, dx=8mm dy=8mm dz=5mm
Variation (%)	0.420000
SAR 10g (W/Kg)	0.347
SAR 1g (W/Kg)	0.453
SURFACE SAR	VOLUME SAR

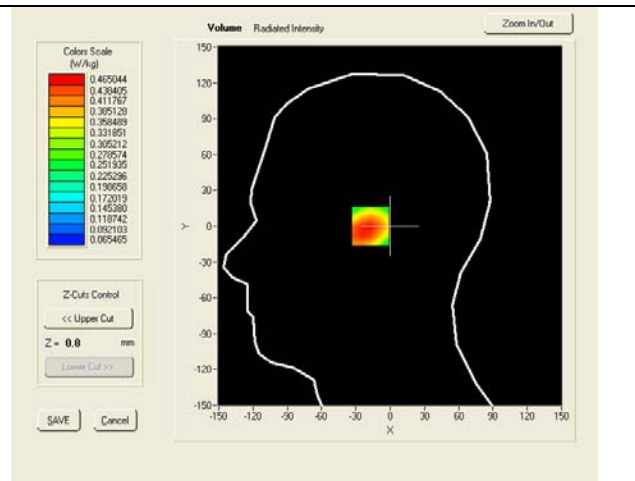
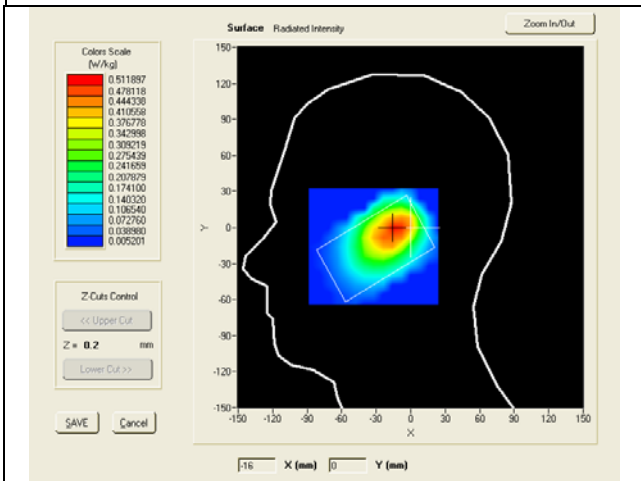

SAR, Z Axis Scan (X = -14, Y = 0)

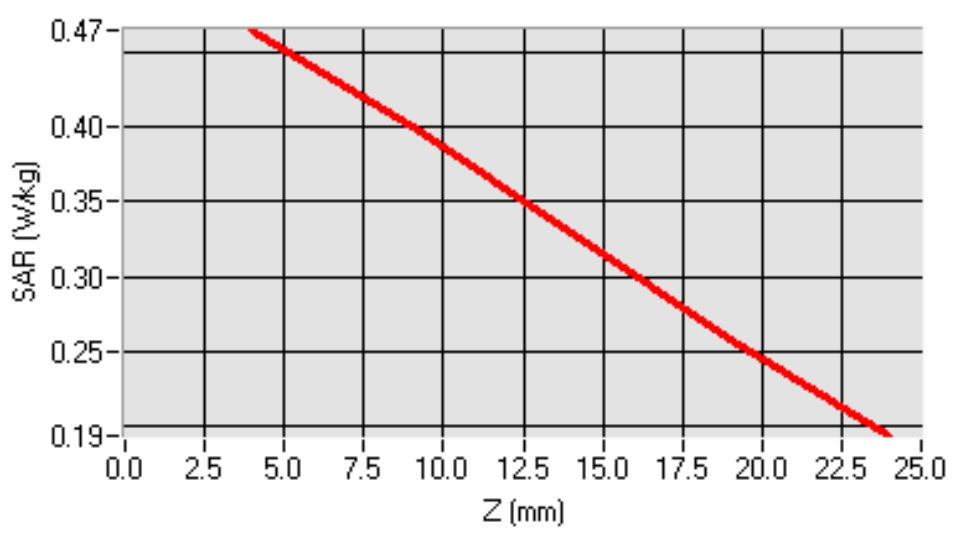



SIEMIC, Inc.

Accessing global markets

Title: RF Test Report of GSM Mobile Phone

Model : LQ310

To C95.1, IEEE 1528, OET Bulletin 65 Supplement C, IEC62209-2 & RSS-102
Issue 4 and Safety Code 6

Serial# 12050036-FCC-H

Issue Date May 18th 2012

Page 60 of 127

www.siemic.com

3D screen shot

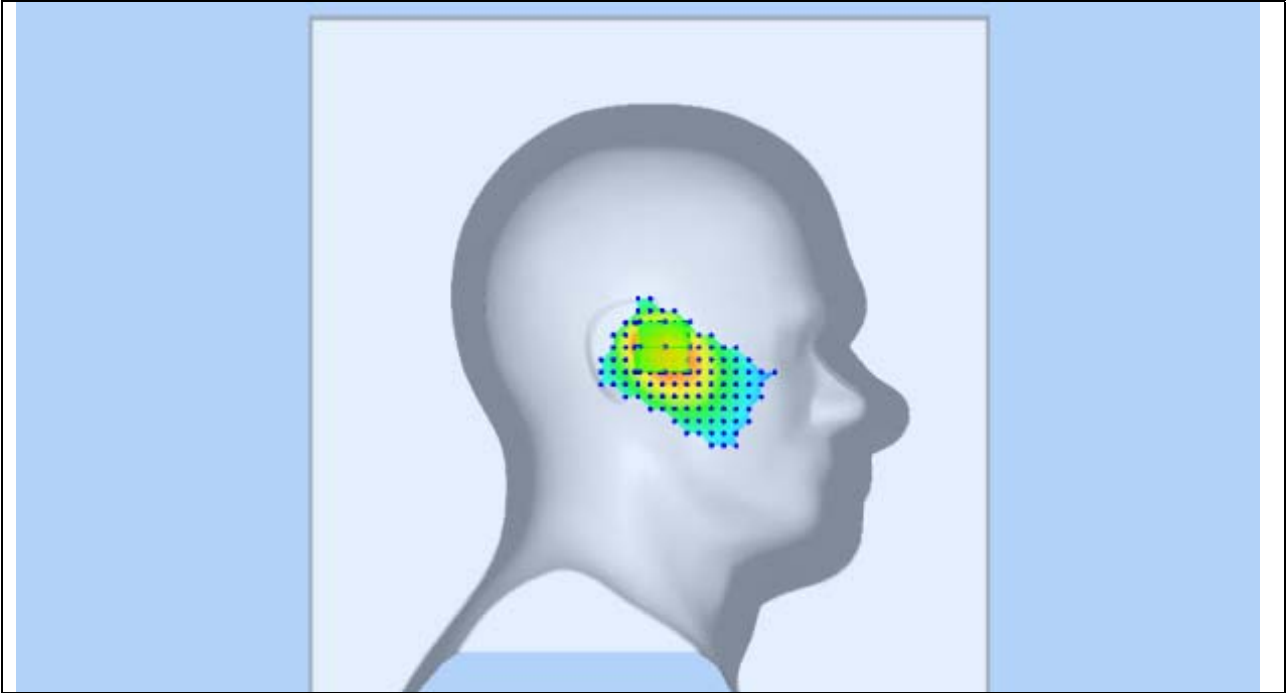

Test mode: GPRS850, low channel (Body-LCD UP)
 Product Description: GSM Mobile Phone
 Model: LQ310
 Test Date: May 14th 2012

Medium(liquid type)	MSL_850
Frequency (MHz)	824.20000
Relative permittivity (real part)	55.35
Conductivity (S/m)	0.98
Crest factor	2.0
Conversion Factor	9.07
Area Scan	dx=8mm dy=8mm
Zoom Scan	5x5x7, dx=8mm dy=8mm dz=5mm
Variation (%)	0.15000
SAR 10g (W/Kg)	0.571
SAR 1g (W/Kg)	0.773

SURFACE SAR

VOLUME SAR

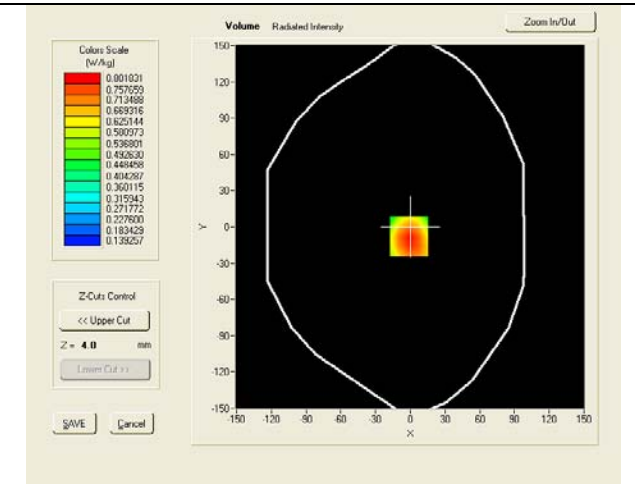
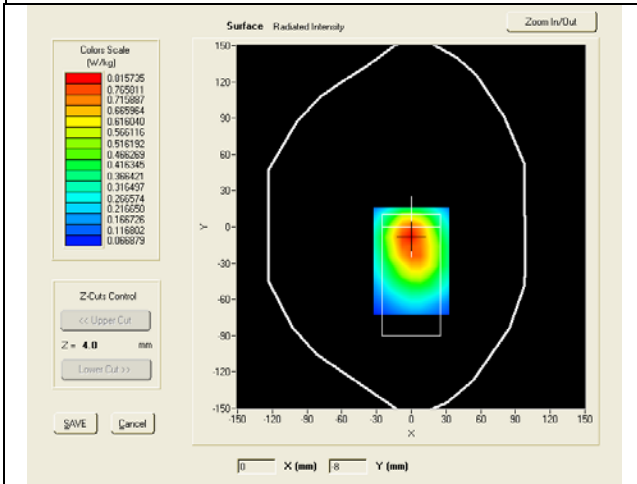

SAR, Z Axis Scan (X = -1, Y = -8)

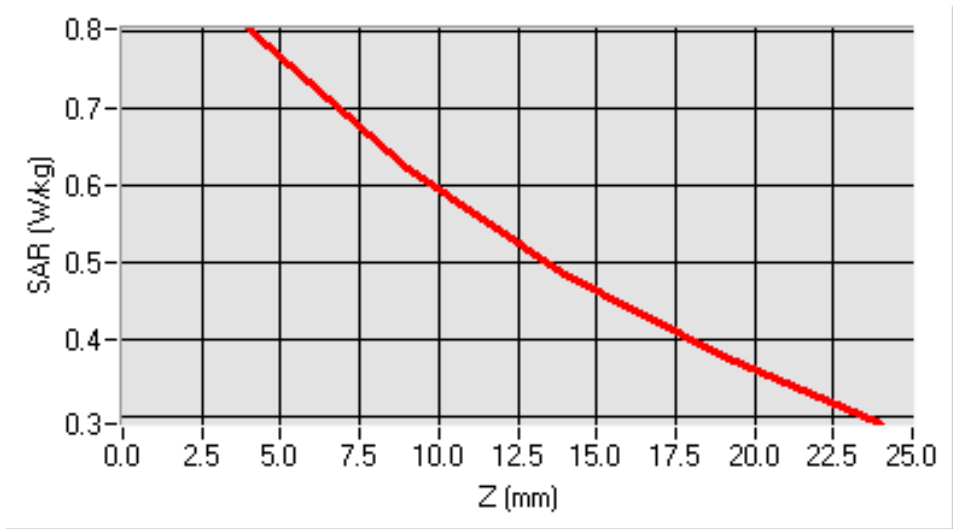

3D screen shot

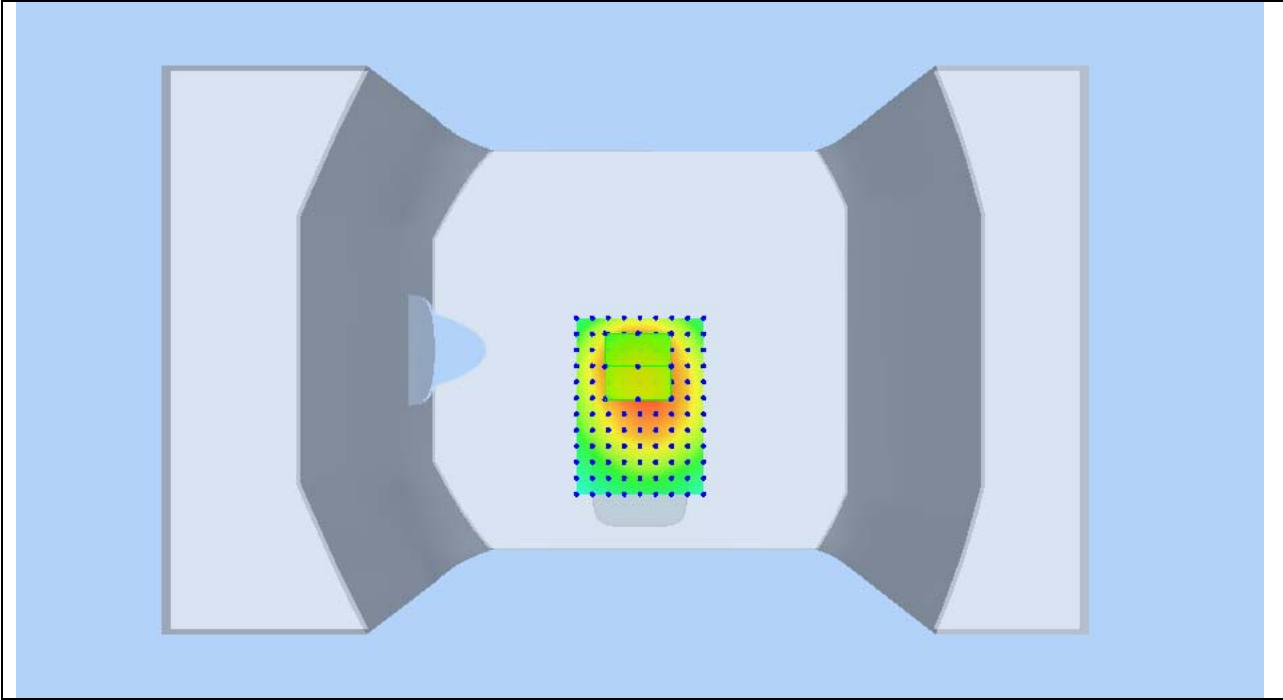

Test mode: GPRS850, low channel (Body-LCD DOWN)
 Product Description: GSM Mobile Phone
 Model: LQ310
 Test Date: May 14th 2012

Medium(liquid type)	MSL_850
Frequency (MHz)	824.20000
Relative permittivity (real part)	55.35
Conductivity (S/m)	0.98
Crest factor	2.0
Conversion Factor	9.07
Area Scan	dx=8mm dy=8mm
Zoom Scan	5x5x7,dx=8mm dy=8mm dz=5mm
Variation (%)	1.90000
SAR 10g (W/Kg)	0.803
SAR 1g (W/Kg)	1.182

SURFACE SAR

VOLUME SAR

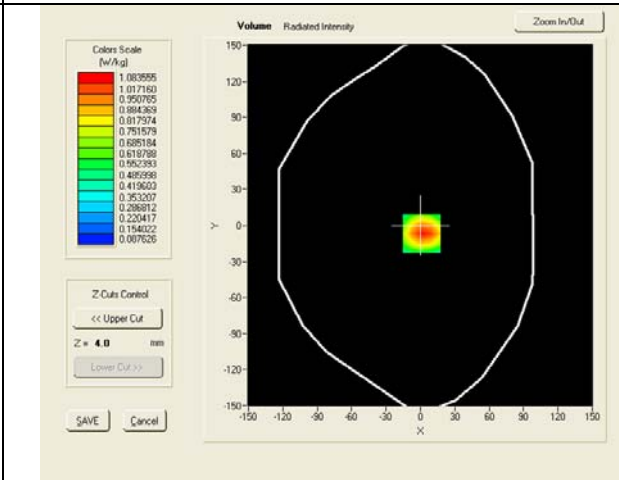
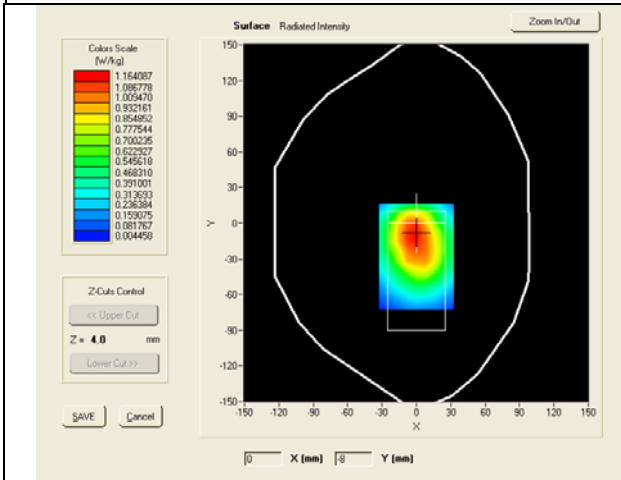

SAR, Z Axis Scan (X = 7, Y = -6)

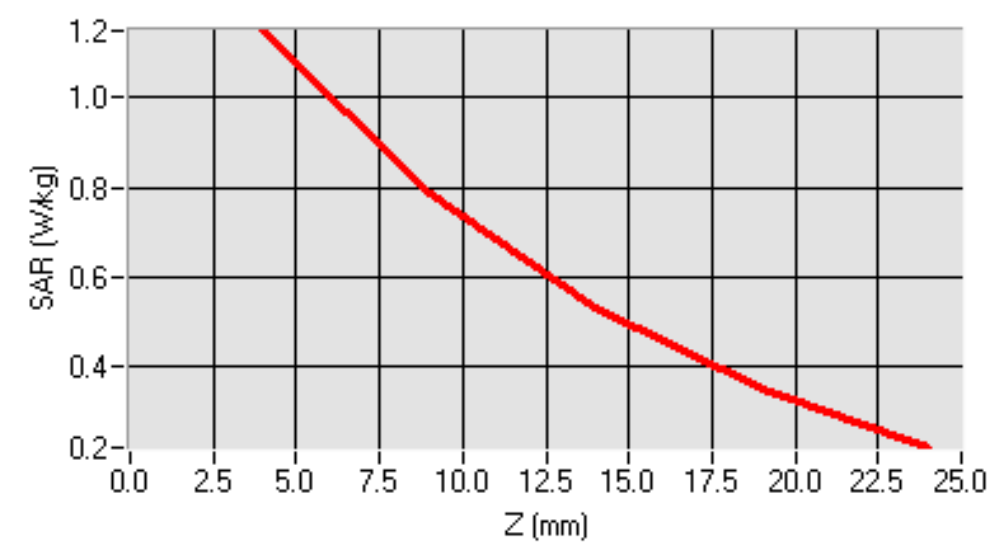

3D screen shot

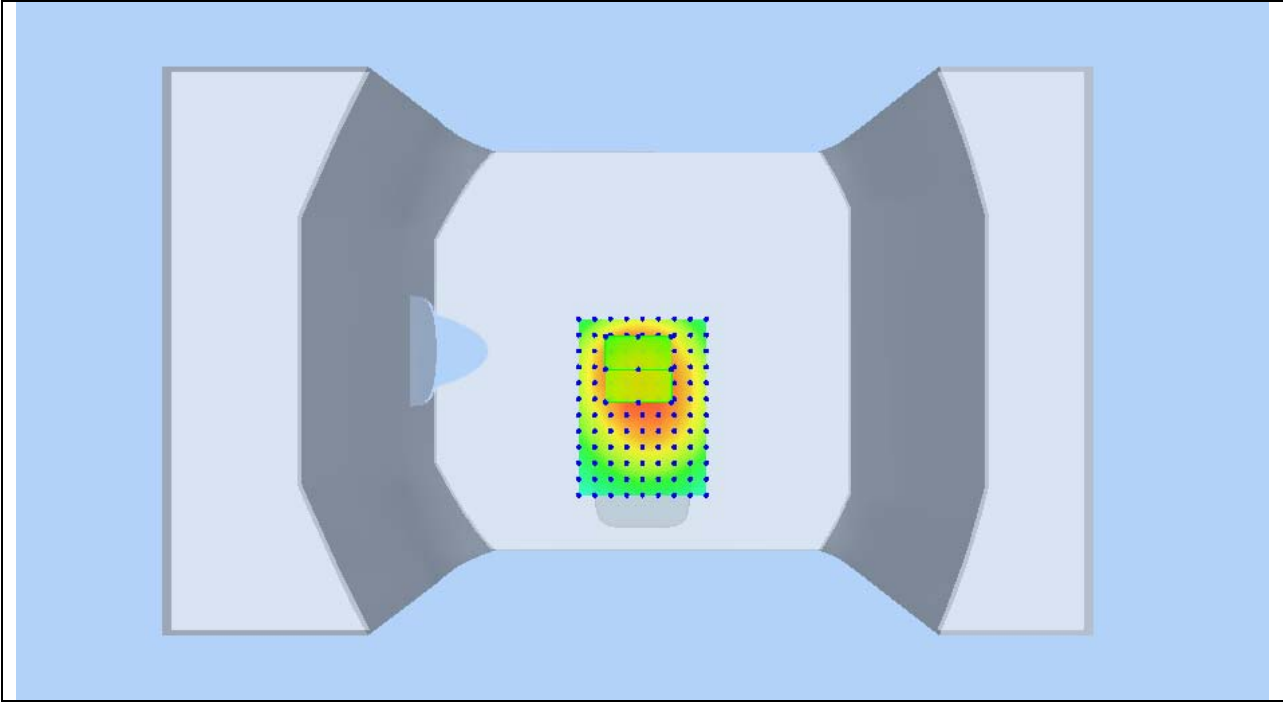

Test mode: GPRS850, middle channel (Body-LCD DOWN)
 Product Description: GSM Mobile Phone
 Model: LQ310
 Test Date: May 14th 2012

Medium(liquid type)	MSL_850
Frequency (MHz)	836.40000
Relative permittivity (real part)	55.56
Conductivity (S/m)	0.98
Crest factor	2.0
Conversion Factor	9.07
Area Scan	dx=8mm dy=8mm
Zoom Scan	5x5x7,dx=8mm dy=8mm dz=5mm
Variation (%)	1.390000
SAR 10g (W/Kg)	0.574
SAR 1g (W/Kg)	0.771

SURFACE SAR

VOLUME SAR

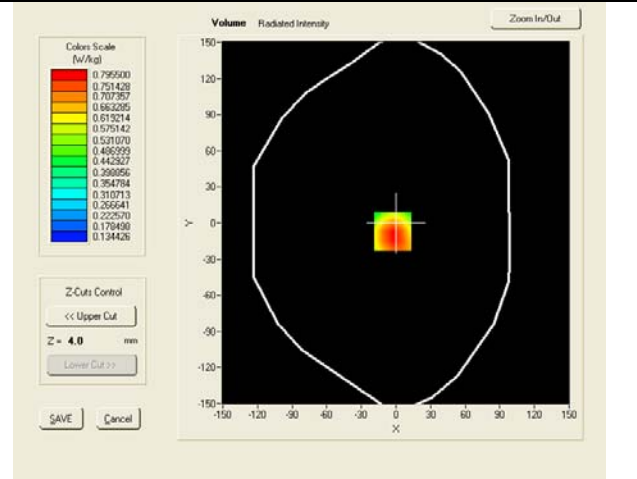
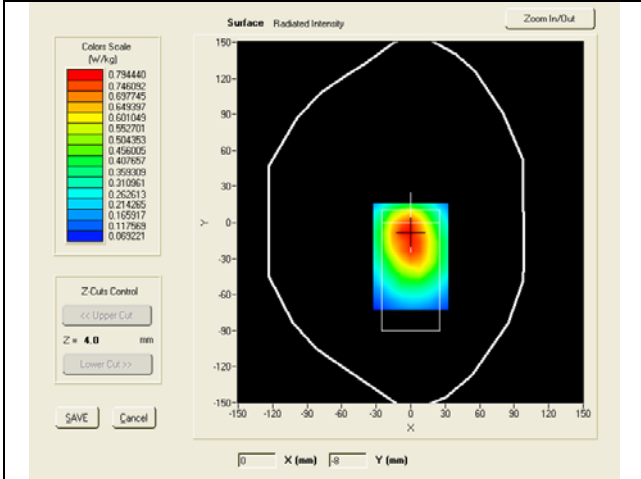

SAR, Z Axis Scan (X = -3, Y = -7)

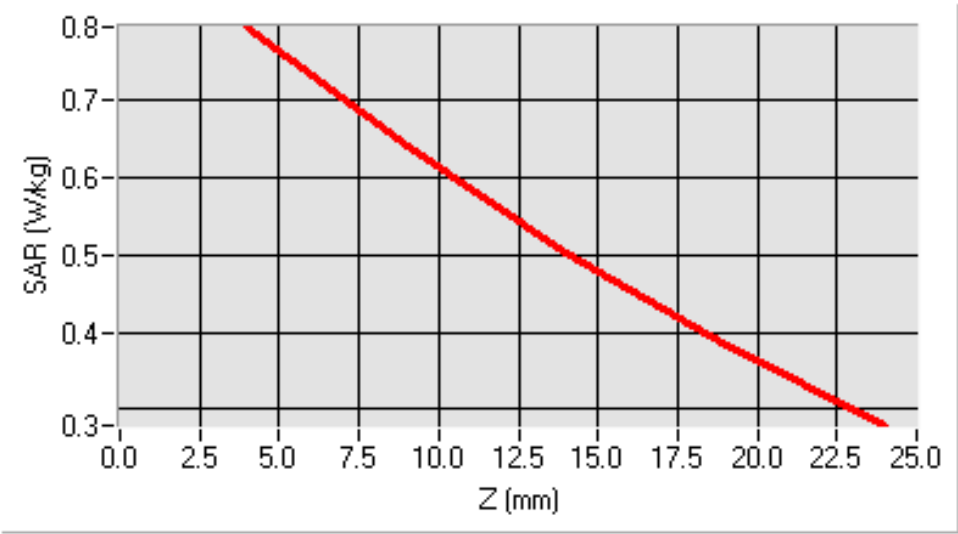



SIEMIC, Inc.

Accessing global markets

Title: RF Test Report of GSM Mobile Phone

Model : LQ310

To C95.1, IEEE 1528, OET Bulletin 65 Supplement C, IEC62209-2 & RSS-102
Issue 4 and Safety Code 6

Serial# 12050036-FCC-H

Issue Date May 18th 2012

Page 66 of 127

www.siemic.com

3D screen shot

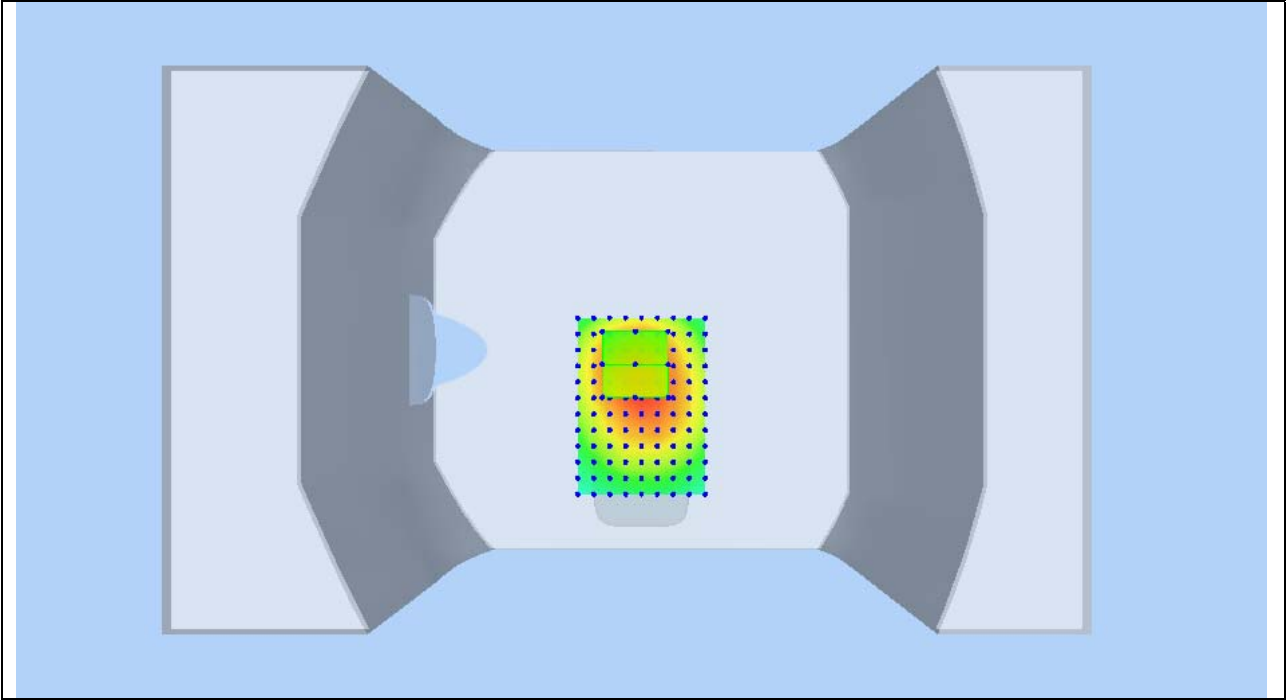

Test mode: GPRS850, High channel (Body-LCD DOWN)
 Product Description: GSM Mobile Phone
 Model: LQ310
 Test Date: May 14th 2012

Medium(liquid type)	MSL_850
Frequency (MHz)	848.80000
Relative permittivity (real part)	55.55
Conductivity (S/m)	0.98
Crest factor	2.0
Conversion Factor	9.07
Area Scan	dx=8mm dy=8mm
Zoom Scan	5x5x7,dx=8mm dy=8mm dz=5mm
Variation (%)	1.220000
SAR 10g (W/Kg)	0.467
SAR 1g (W/Kg)	0.615

SURFACE SAR

VOLUME SAR

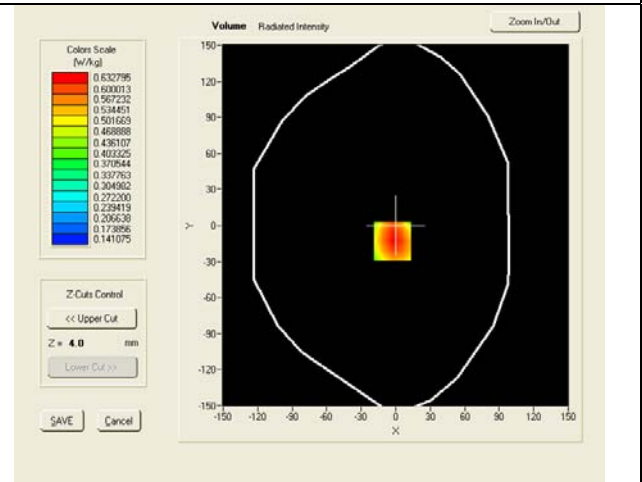
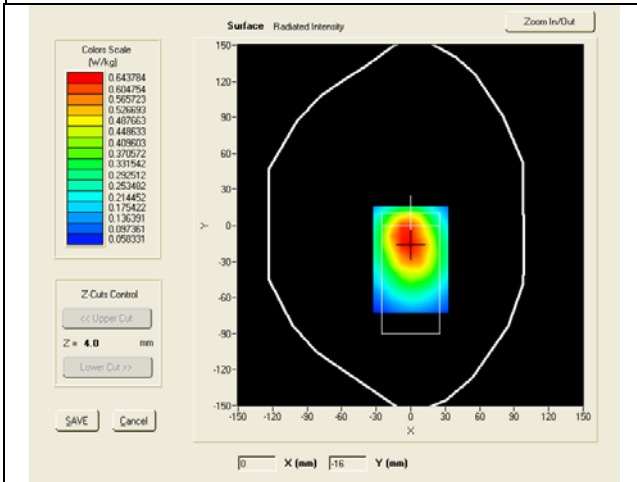

SAR, Z Axis Scan (X = -3, Y = -13)

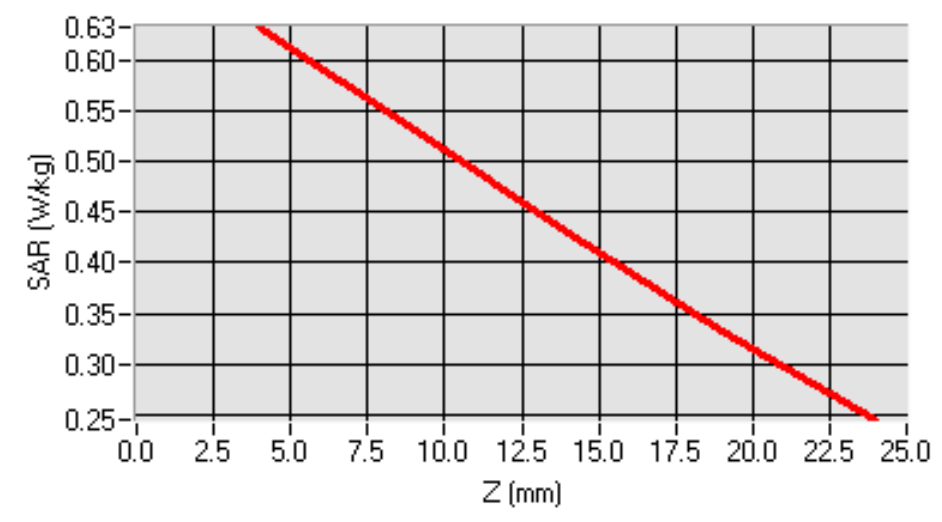



SIEMIC, Inc.

Accessing global markets

Title: RF Test Report of GSM Mobile Phone

Model : LQ310

To C95.1, IEEE 1528, OET Bulletin 65 Supplement C, IEC62209-2 & RSS-102
Issue 4 and Safety Code 6

Serial# 12050036-FCC-H

Issue Date May 18th 2012

Page 68 of 127

www.siemic.com

3D screen shot

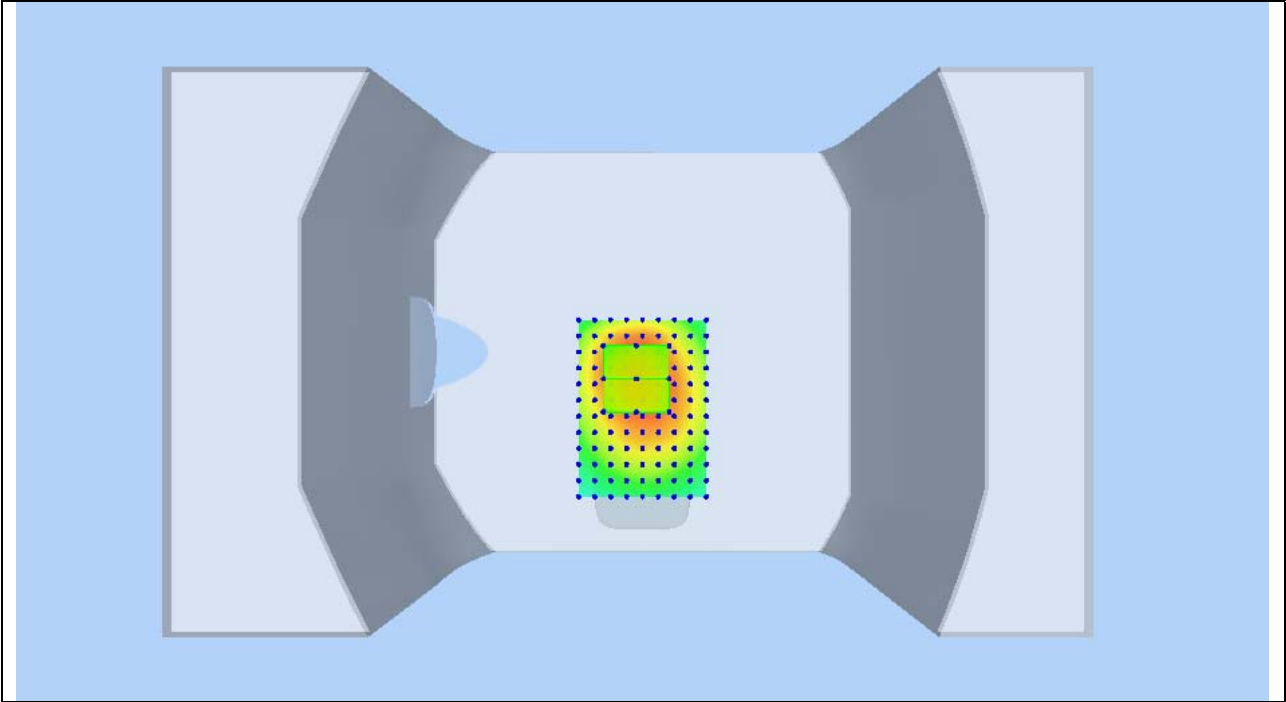

Test mode: GSM1900, Low channel (Right Head Cheek)
 Product Description: GSM Mobile Phone
 Model: LQ310
 Test Date: May 15th 2012

Medium(liquid type)	HSL_1900
Frequency (MHz)	1850.20000
Relative permittivity (real part)	40.68
Conductivity (S/m)	1.39
Crest factor	8.0
Conversion Factor	9.09
Area Scan	dx=8mm dy=8mm
Zoom Scan	5x5x7,dx=8mm dy=8mm dz=5mm
Variation (%)	0.160000
SAR 10g (W/Kg)	0.241
SAR 1g (W/Kg)	0.438

SURFACE SAR

VOLUME SAR

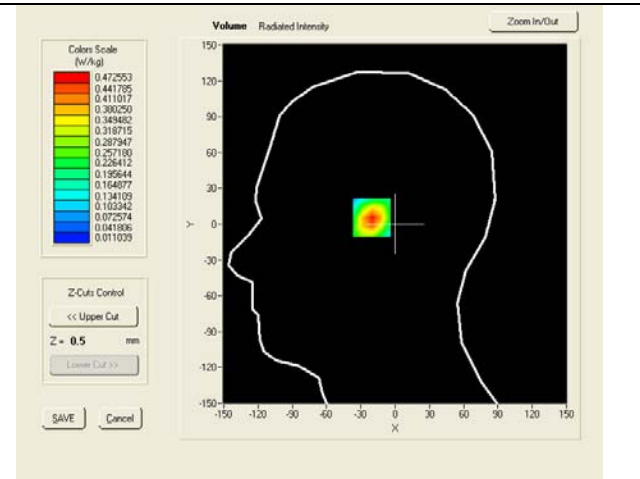
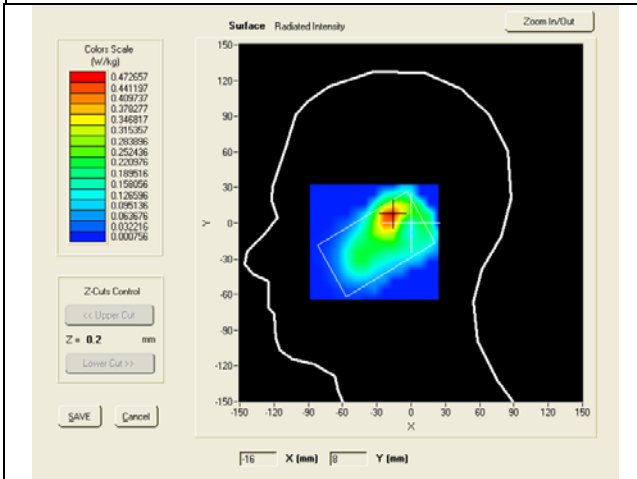

SAR, Z Axis Scan (X = -18, Y = 6)

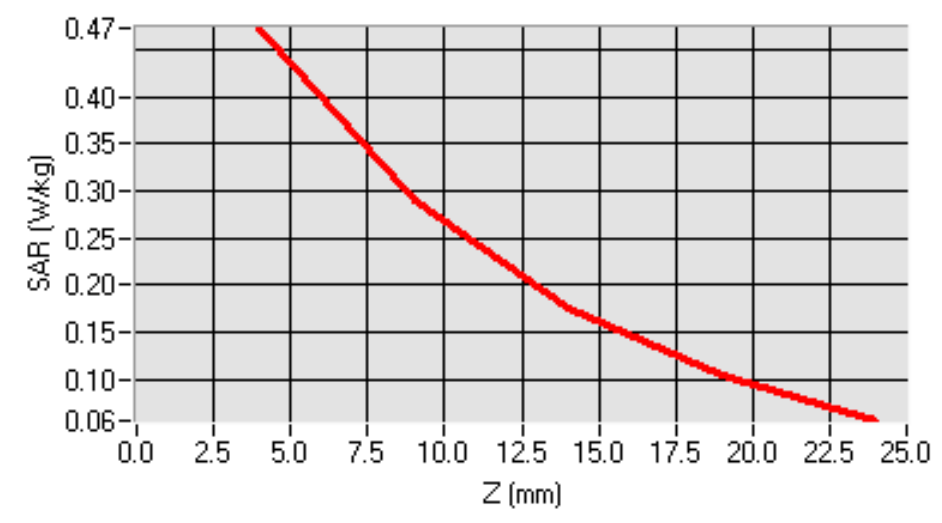



SIEMIC, Inc.

Accessing global markets

Title: RF Test Report of GSM Mobile Phone
Model : LQ310
To : C95.1, IEEE 1528, OET Bulletin 65 Supplement C, IEC62209-2 & RSS-102
Issue 4 and Safety Code 6

Serial# 12050036-FCC-H
Issue Date May 18th 2012
Page 70 of 127
www.siemic.com

3D screen shot

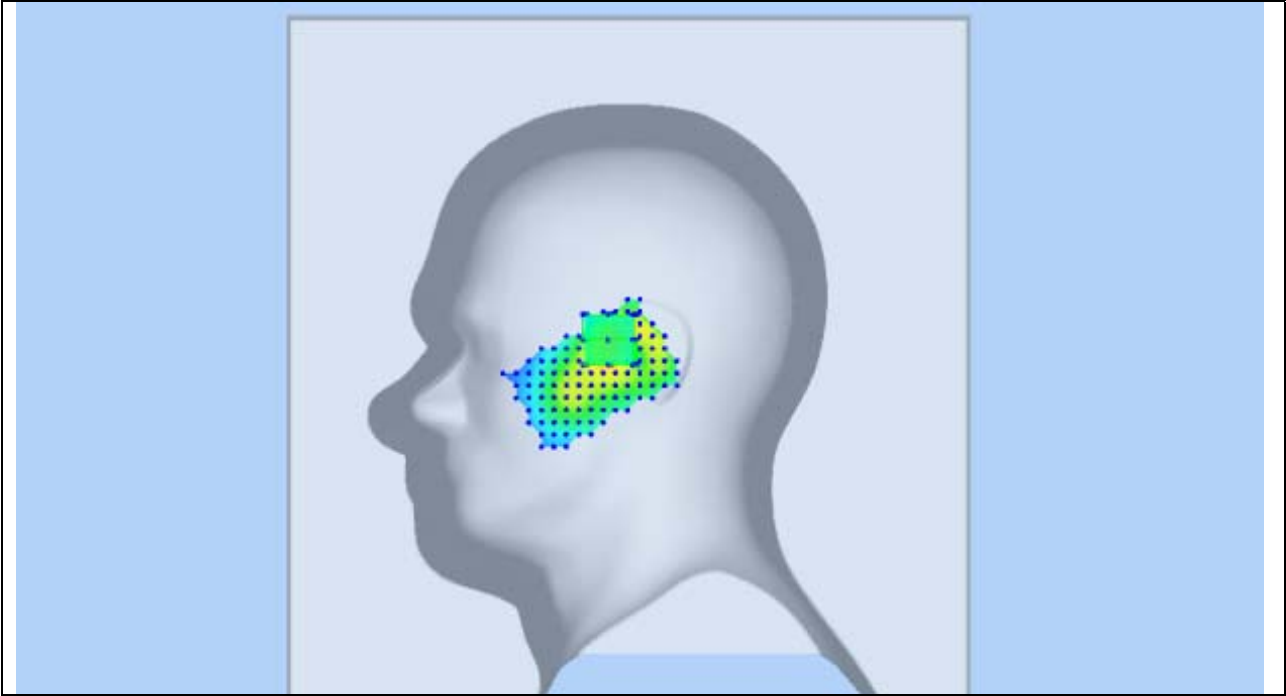

Test mode: GSM1900, Low channel (Right Head Tilt)
 Product Description: GSM Mobile Phone
 Model: LQ310
 Test Date: May 15th 2012

Medium(liquid type)	HSL_1900
Frequency (MHz)	1850.20000
Relative permittivity (real part)	40.68
Conductivity (S/m)	1.39
Crest factor	8.0
Conversion Factor	9.09
Area Scan	dx=8mm dy=8mm
Zoom Scan	5x5x7, dx=8mm dy=8mm dz=5mm
Variation (%)	1.20000
SAR 10g (W/Kg)	0.254
SAR 1g (W/Kg)	0.455
SURFACE SAR	VOLUME SAR

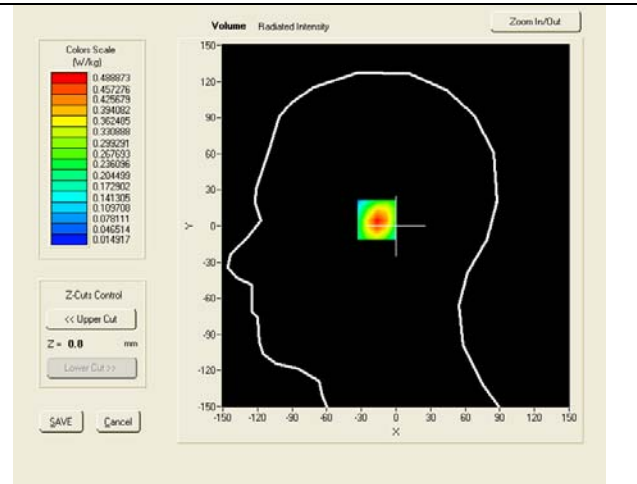
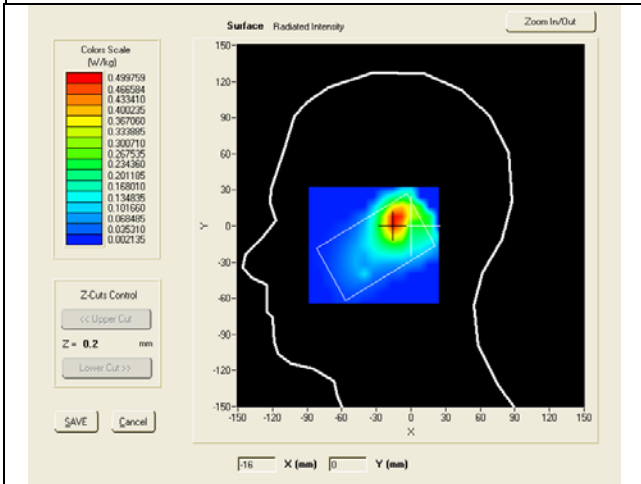

SAR, Z Axis Scan (X = -14, Y = 5)

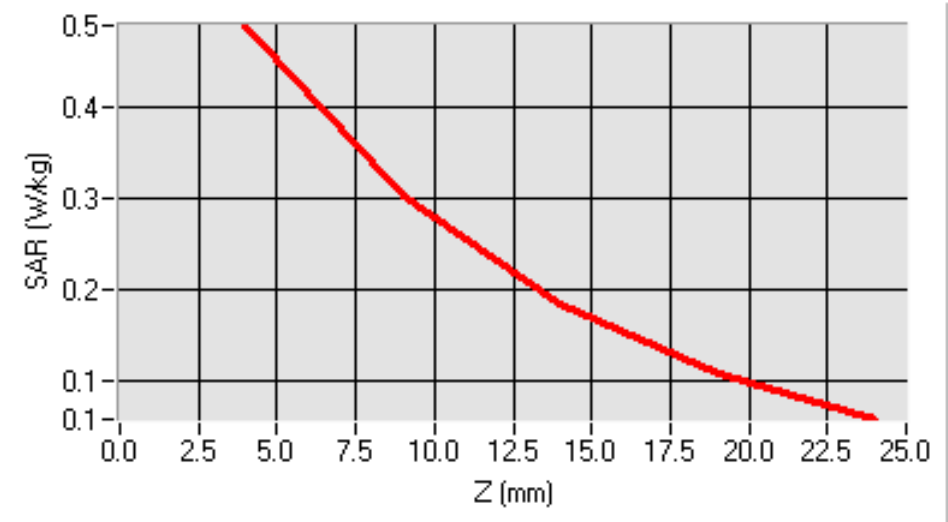



SIEMIC, Inc.

Accessing global markets

Title: RF Test Report of GSM Mobile Phone

Model : LQ310

To C95.1, IEEE 1528, OET Bulletin 65 Supplement C, IEC62209-2 & RSS-102
Issue 4 and Safety Code 6

Serial# 12050036-FCC-H

Issue Date May 18th 2012

Page 72 of 127

www.siemic.com

3D screen shot

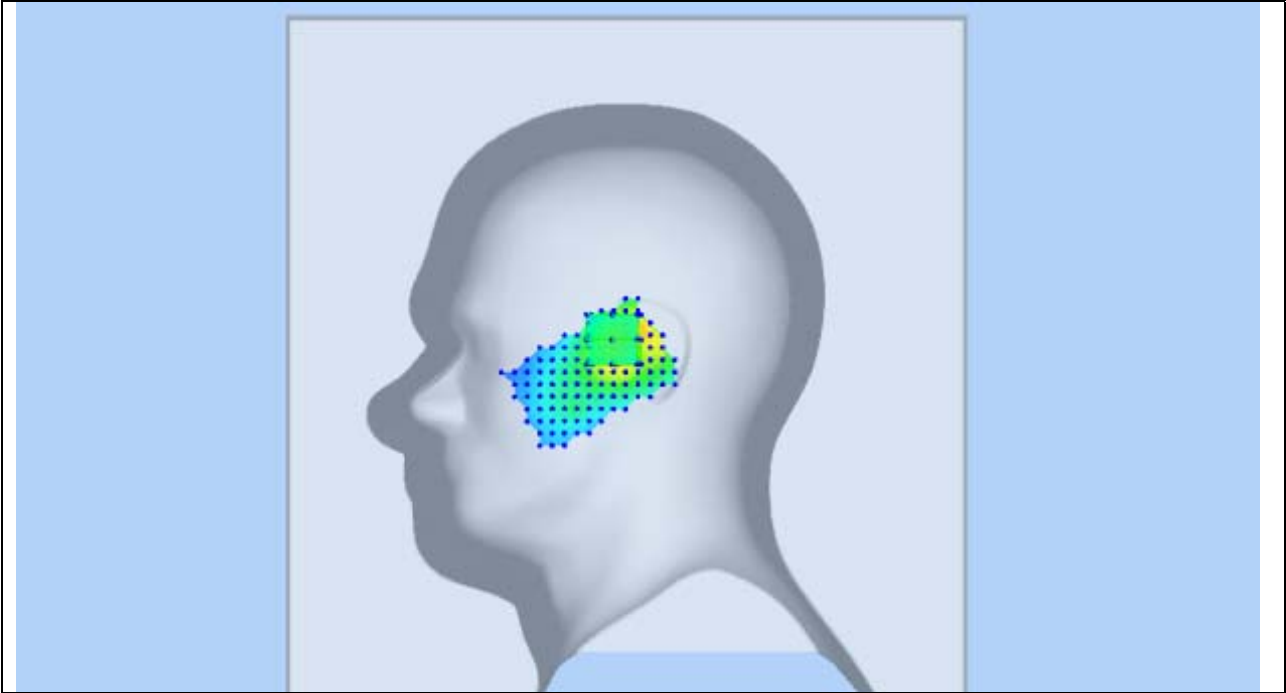

Test mode: GSM1900, Low channel (left Head Cheek)
 Product Description: GSM Mobile Phone
 Model: LQ310
 Test Date: May 15th 2012

Medium(liquid type)	HSL_1900
Frequency (MHz)	1850.20000
Relative permittivity (real part)	40.68
Conductivity (S/m)	1.39
Crest factor	8.0
Conversion Factor	9.09
Area Scan	dx=8mm dy=8mm
Zoom Scan	5x5x7,dx=8mm dy=8mm dz=5mm
Variation (%)	0.280000
SAR 10g (W/Kg)	0.196
SAR 1g (W/Kg)	0.321

SURFACE SAR

VOLUME SAR

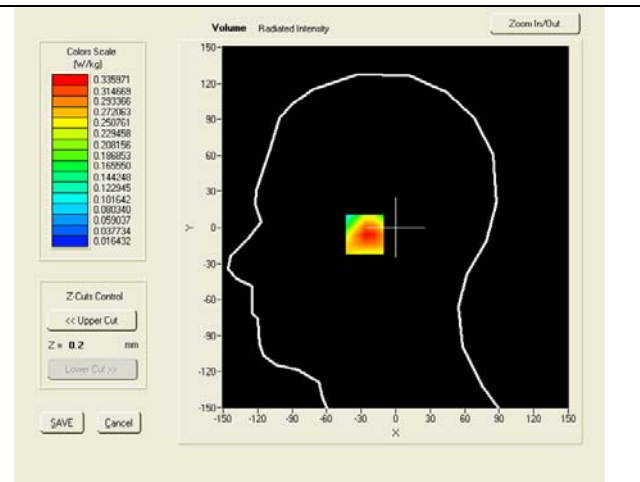
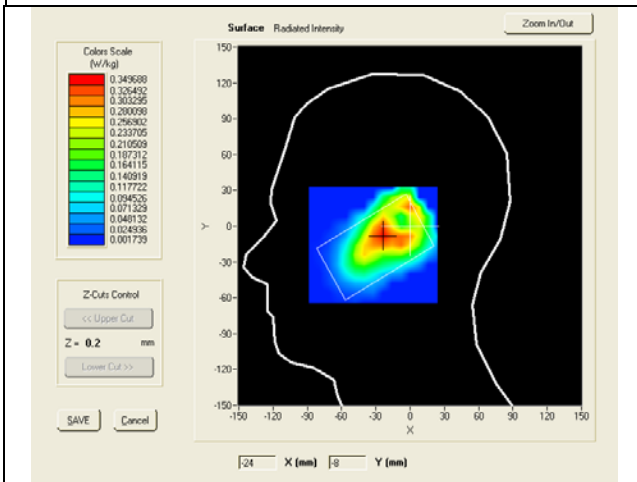

SAR, Z Axis Scan (X = -24, Y = -6)

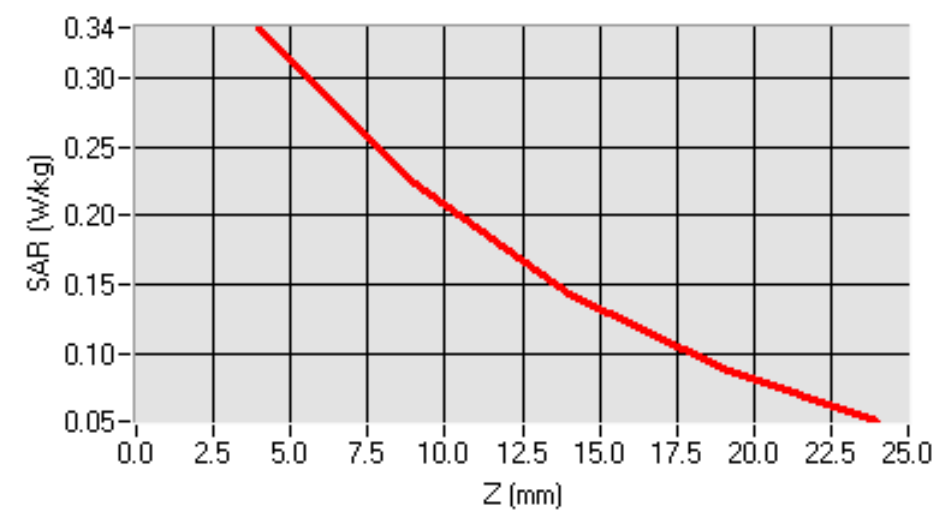

3D screen shot

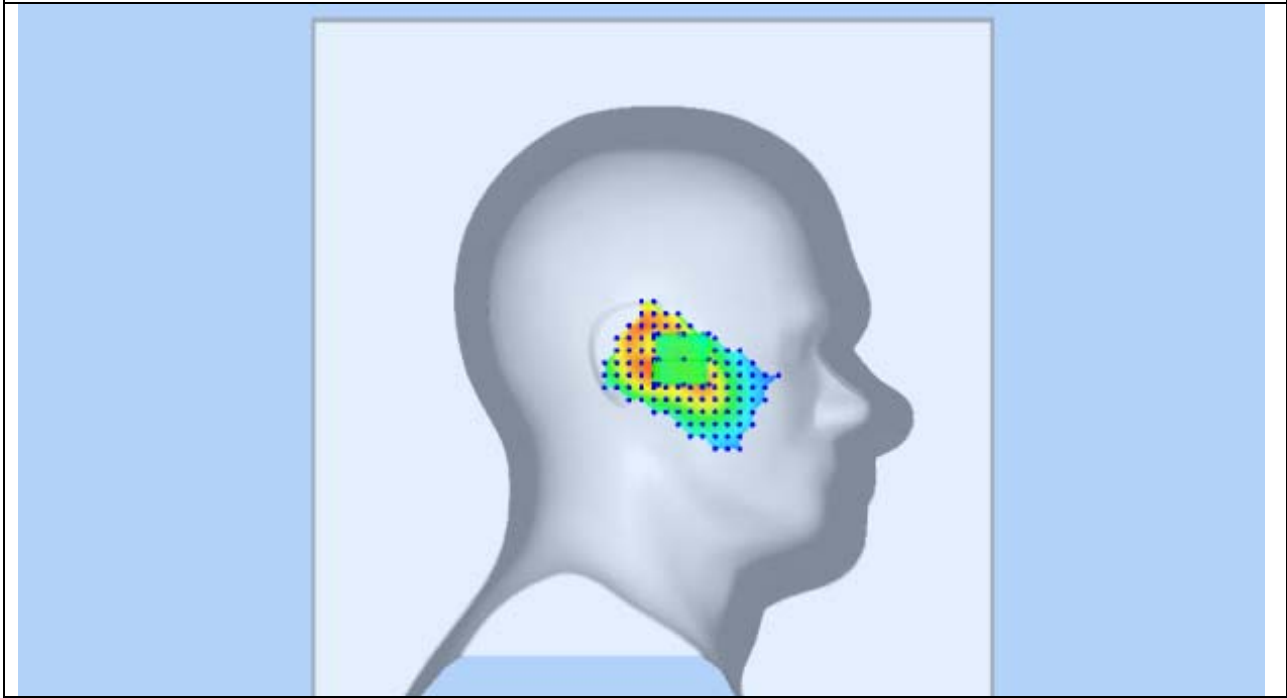

Test mode: GSM1900, Low channel (Left Head Tilt)
 Product Description: GSM Mobile Phone
 Model: LQ310
 Test Date: May 15th 2012

Medium(liquid type)	HSL_1900
Frequency (MHz)	1850.20000
Relative permittivity (real part)	40.68
Conductivity (S/m)	1.39
Crest factor	8.0
Conversion Factor	9.09
Area Scan	dx=8mm dy=8mm
Zoom Scan	5x5x7,dx=8mm dy=8mm dz=5mm
Variation (%)	0.210000
SAR 10g (W/Kg)	0.197
SAR 1g (W/Kg)	0.345

SURFACE SAR

VOLUME SAR

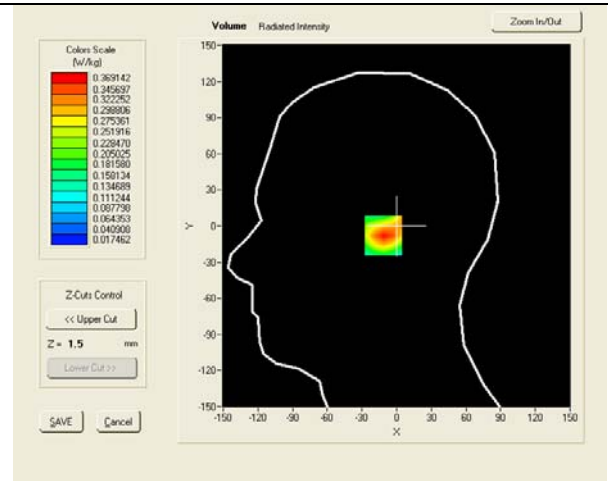
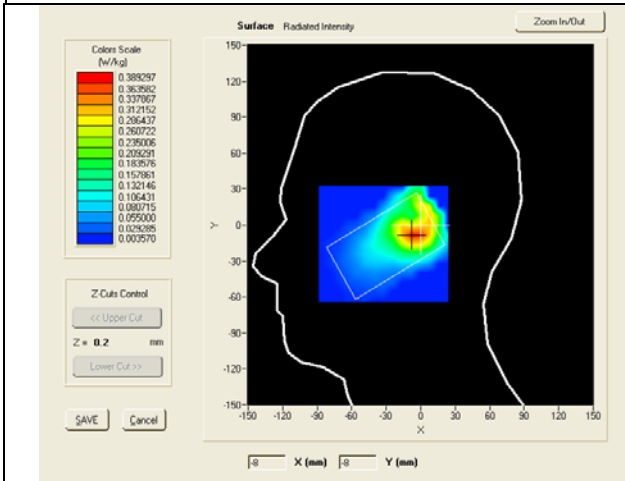

SAR, Z Axis Scan (X = -7, Y = -8)

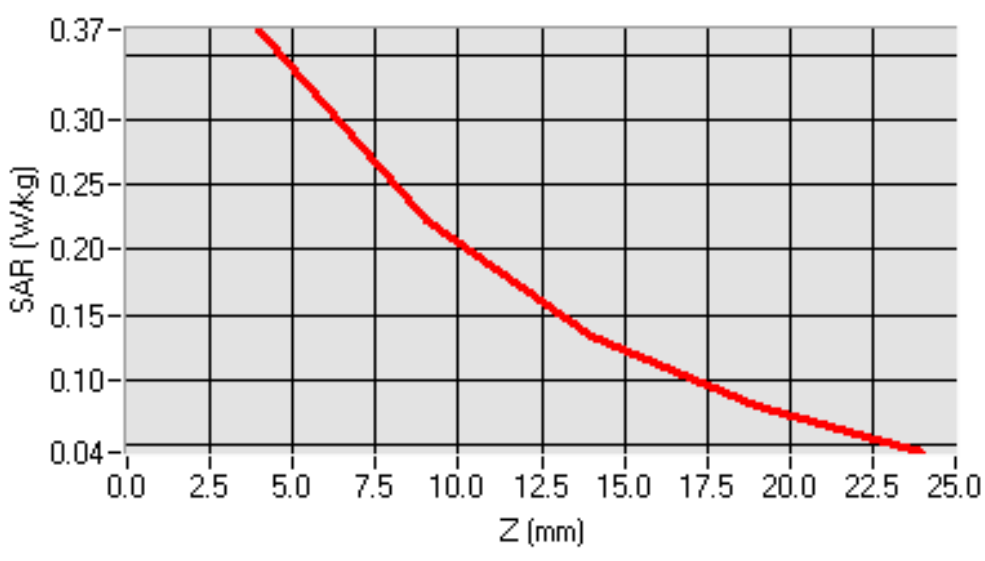

3D screen shot

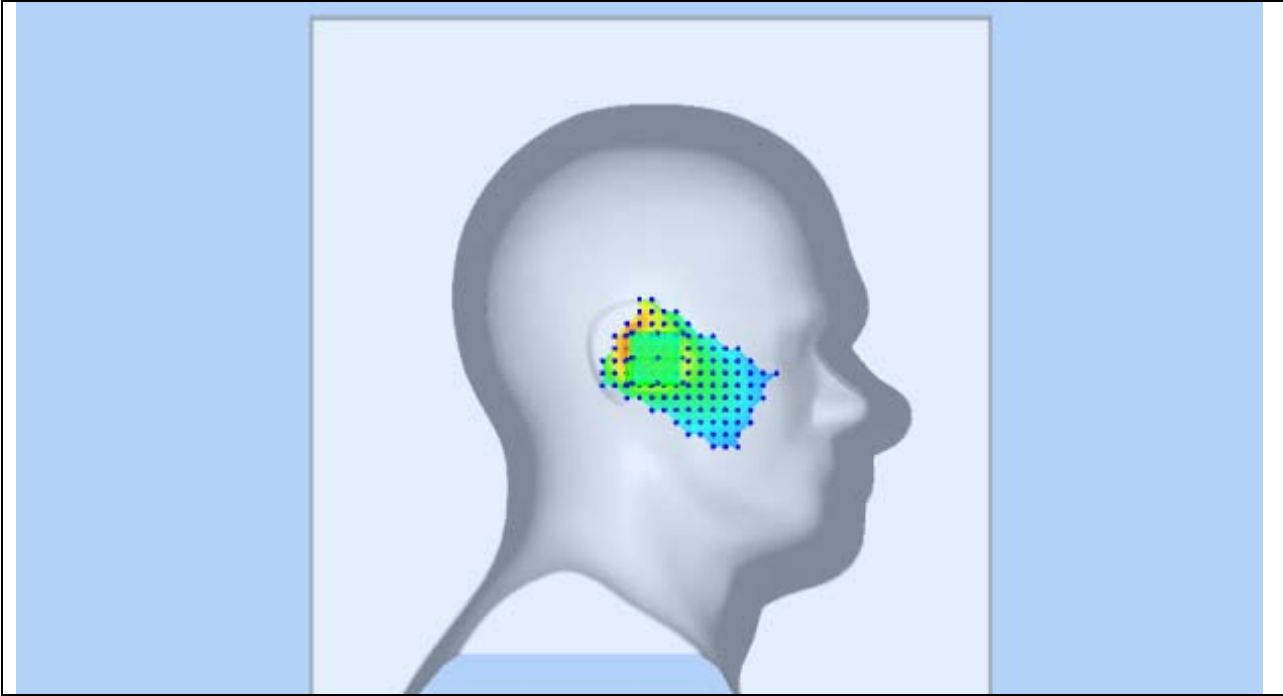

Test mode: GPRS1900, low channel (Body LCD-UP)
 Product Description: GSM Mobile Phone
 Model: LQ310
 Test Date: May 15th 2012

Medium(liquid type)	MSL_1900
Frequency (MHz)	1850.20000
Relative permittivity (real part)	53.70
Conductivity (S/m)	1.50
Crest factor	2.0
Conversion Factor	9.32
Area Scan	dx=8mm dy=8mm
Zoom Scan	5x5x7,dx=8mm dy=8mm dz=5mm
Variation (%)	0.87000
SAR 10g (W/Kg)	0.115
SAR 1g (W/Kg)	0.203

SURFACE SAR

VOLUME SAR

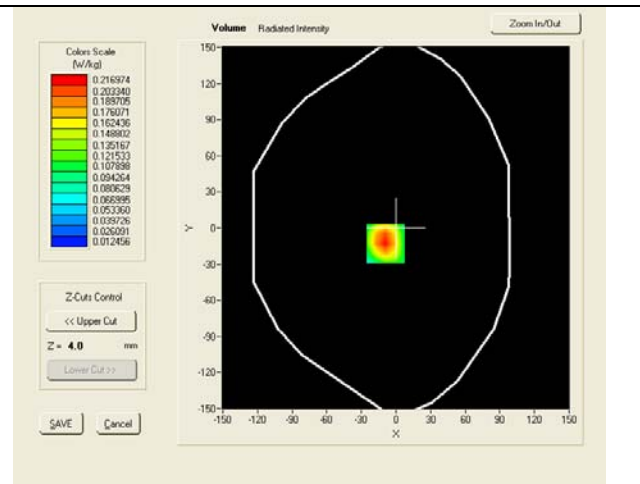
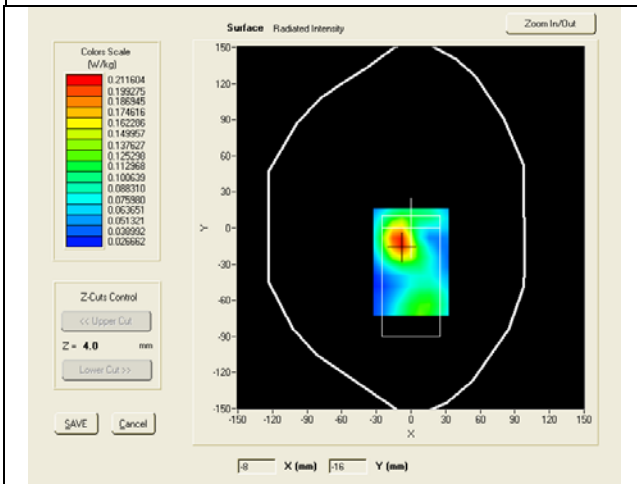

SAR, Z Axis Scan (X = -9, Y = -13)

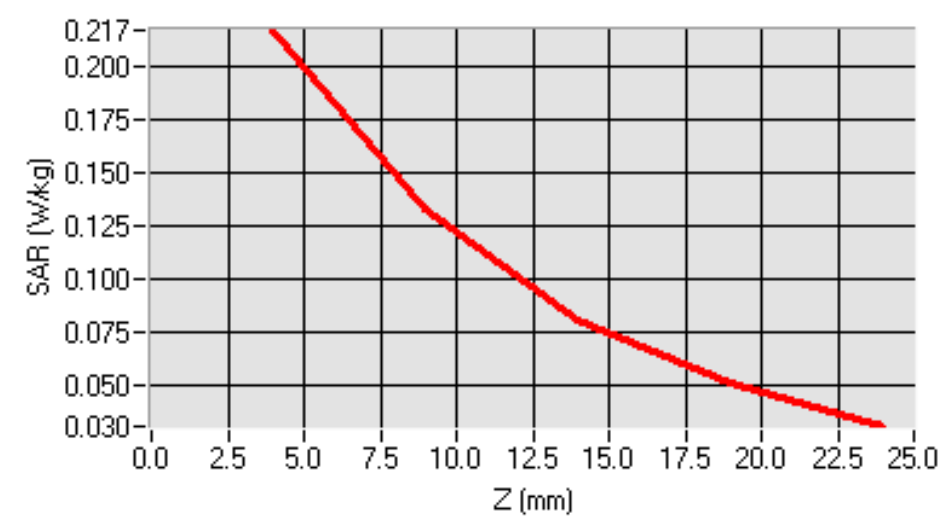

3D screen shot

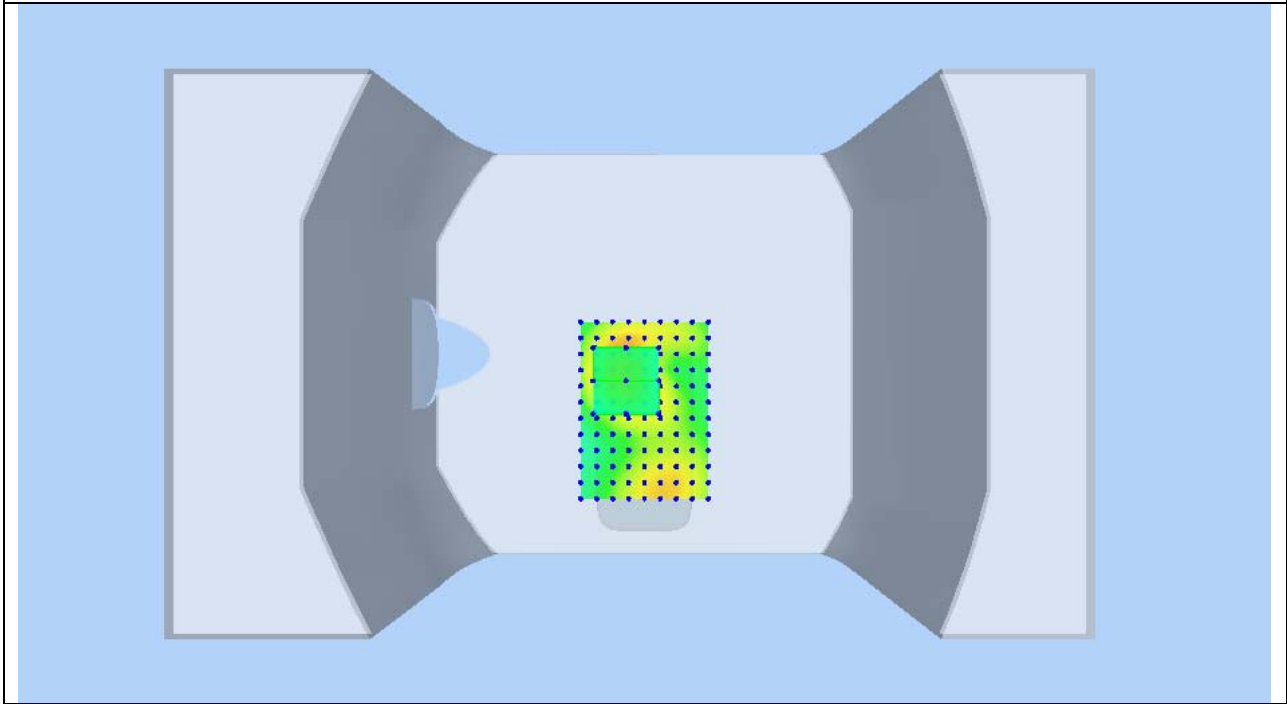

Test mode: GPRS1900, low channel (Body LCD-DOWN)
 Product Description: GSM Mobile Phone
 Model: LQ310
 Test Date: May 15th 2012

Medium(liquid type)	MSL_1900
Frequency (MHz)	1850.20000
Relative permittivity (real part)	53.70
Conductivity (S/m)	1.50
Crest factor	2.0
Conversion Factor	9.32
Area Scan	dx=8mm dy=8mm
Zoom Scan	5x5x7,dx=8mm dy=8mm dz=5mm
Variation (%)	1.10000
SAR 10g (W/Kg)	0.209
SAR 1g (W/Kg)	0.366
SURFACE SAR	VOLUME SAR

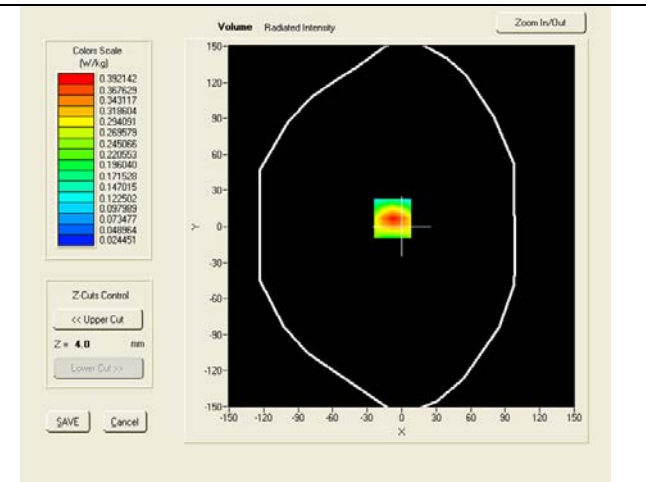
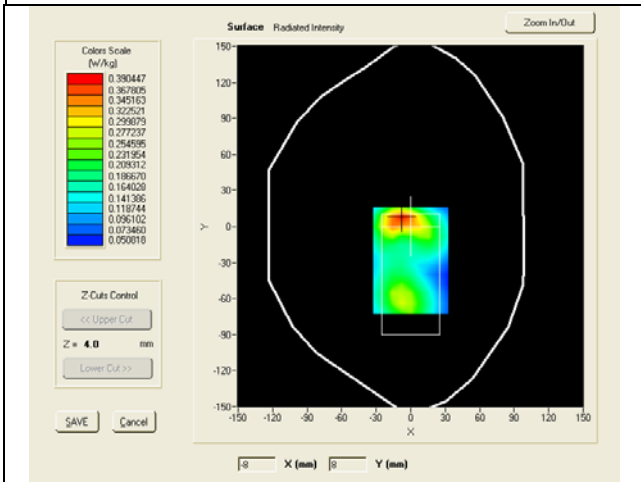

SAR, Z Axis Scan (X = -8, Y = 7)

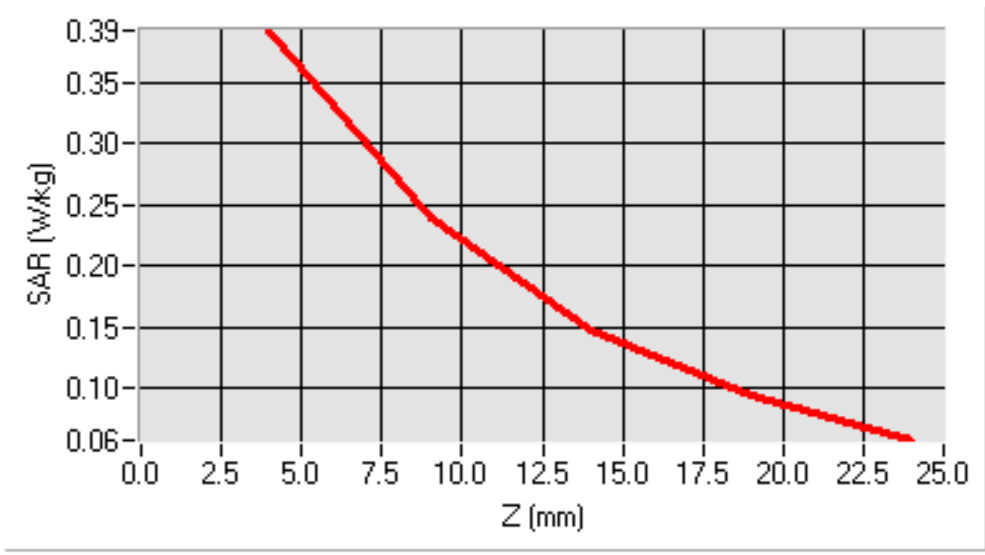

3D screen shot

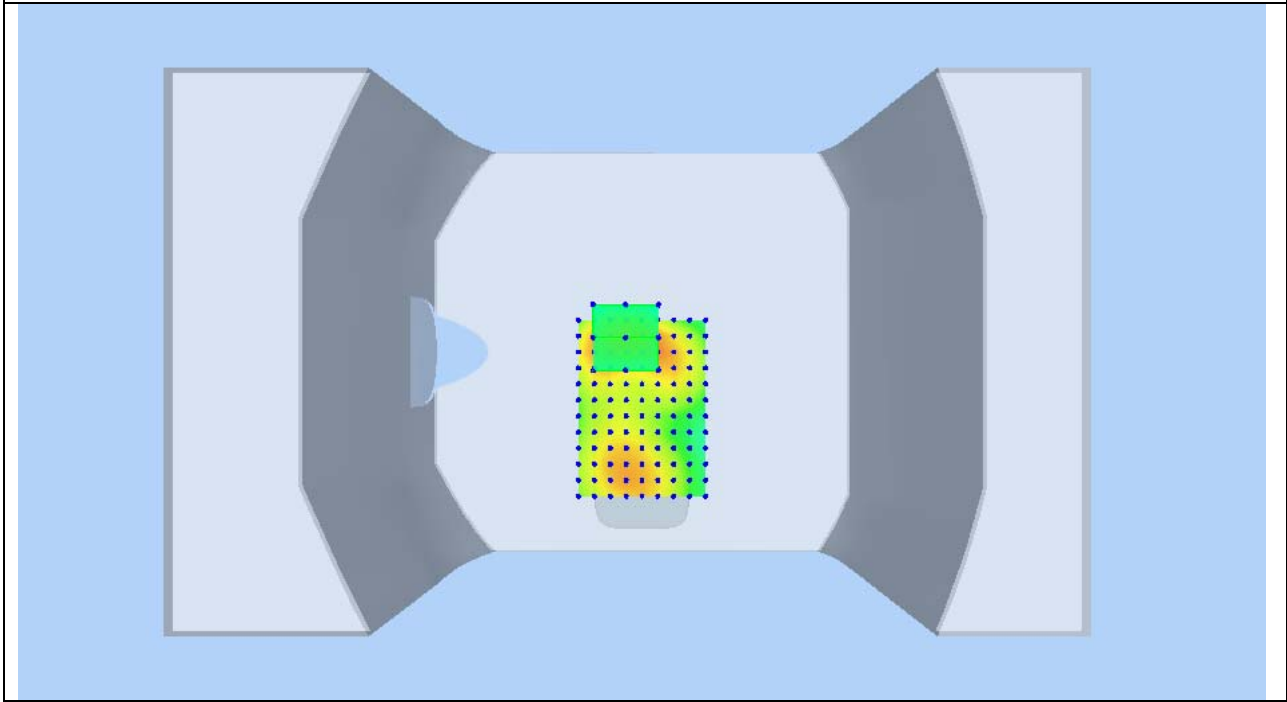

Annex A. TEST INSTRUMENT & METHOD

Annex A.i. TEST INSTRUMENTATION & GENERAL PROCEDURES					
Name of Equipment	Manufacturer	Type/Model	Serial Number	Calibration Date	Calibration Due
P C	Compaq	PV 3.06GHz	375052-AA1	N/A	N/A
Signal Generator	Agilent	8665B-008	3744A10293	05/17/2011	05/17/2012
MultiMeter	Keithley	MiltiMeter 2000	1259033	06/21/2011	06/21/2012
S-Parameter Network Analyzer	Agilent	8753ES	US39173518	08/04/2011	08/04/2012
Wireless Communication Test Set	R & S	CMU200	111078	07/22/2011	07/22/2012
Power Meter	HP	437B	3038A03648	05/17/2011	05/17/2012
E-field PROBE	SATIMO	SSE2	SN 26/11 EPG122	10/03/2011	10/03/2012
DIPOLE 835	SATIMO	DIPOLE 835MHz	SN 18/11 DIPC 150	06/01/2011	06/01/2012
DIPOLE 900	SATIMO	DIPOLE 900MHz	SN 18/11 DIPC 151	06/01/2011	06/01/2012
DIPOLE 1800	SATIMO	DIPOLE 1800MHz	SN 18/11 DIPC 152	06/01/2011	06/01/2012
DIPOLE 1900	SATIMO	DIPOLE 1900MHz	SN 18/11 DIPC 153	06/01/2011	06/01/2012
DIPOLE 2000	SATIMO	DIPOLE 2000MHz	SN 18/11 DIPC 154	06/01/2011	06/01/2012
DIPOLE 2450	SATIMO	DIPOLE 2450MHz	SN 18/11 DIPJ 155	06/01/2011	06/01/2012
DIPOLE 3500	SATIMO	DIPOLE 3500MHz	SN 18/11 DIPC 156	06/01/2011	06/01/2012
WaveGuide 5/6 GHz	SATIMO	Wave Guide 5/6GHz	SN 31/10 DIPWGA13	06/01/2011	06/01/2012
COMOHAC E-Field Probe	SATIMO	EPH30	SN 24/11 EPH30	06/01/2011	06/01/2012
COMOHAC H-Field Probe	SATIMO	HPH42	SN 43/10 HPH42	06/01/2011	06/01/2012
COMOSAR Open Coaxial Probe	SATIMO	OCP43	SN 24/11 OCPG43	06/01/2011	06/01/2012
T-Coil Probe	SATIMO	TCP21	SN 24/11 TCP21	06/01/2011	06/01/2012
Communication Antenna	SATIMO	ANTA3	SN 20/11 ANTA 3	06/20/2011	06/20/2012
Laptop POSITIONING DEVICE	SATIMO	LSH15	SN 24/11 LSH15	N/A	N/A
Mobile Phone POSITIONING DEVICE	SATIMO	MSH73	SN 24/11 MSH73	N/A	N/A
COMOHAC Broadband Dipole 800-950	SATIMO	COMOHAC Broadband Dipole 800-950MHz	SN 24/11 DHA31	06/01/2011	06/01/2012
COMOHAC Broadband Dipole 1700-2000	SATIMO	COMOHAC Broadband Dipole 1700-2000MHz	SN 24/11 DHB32	06/01/2011	06/01/2012
COMOHAC TELEPHONE MAGNETIC FIELD SIMULATOR	SATIMO	TMFS12		06/01/2011	06/01/2012
DUMMY PROBE	ANTENNESSA		DP41	N/A	N/A

SAM PHANTOM	SATIMO	SAM87	SN 24/11 SAM87	N/A	N/A
Elliptic Phantom	SATIMO	ELLI20	SN 20/11ELLI20	N/A	N/A
PHANTOM TABLE	SATIMO	N/A	N/A	N/A	N/A
6 AXIS ROBOT	KUKA	KR5	949272	N/A	N/A
High Power Solid State Amplifier (80MHz~1000MHz)	Instruments for Industry	CMC150	M631-0408	N/A	N/A
Medium Power Solid State Amplifier (0.8~4.2GHz)	Instruments for Industry	S41-25	M629-0408	N/A	N/A
Wave Tube Amplifier 4-8 GHz at 20Watt	Hughes Aircraft Company	1277H02F000	81	N/A	N/A

Annex B CALIBRATION REPORTS