

# b mobile HK Limited

## b mobile

Main Model: K103

Serial Model: N/A

February 24, 2012



Report No.: 12050011-FCC-E1-V2

(This report supersedes NONE)



Modifications made to the product : None

This Test Report is Issued Under the Authority of:

		
<b>Deon Dai</b> Compliance Engineer	<b>Alex Liu</b> Technical Manager	

This test report may be reproduced in full only.  
Test result presented in this test report is applicable to the representative sample only.

# EMC Test Report

To: FCC Part 15 Subpart B Class B: 2011

**SIEMIC, INC.**  
Assessing global markets



## Laboratory Introduction

SIEMIC, headquartered in the heart of Silicon Valley, with superior facilities in US and Asia, is one of the leading independent testing and certification facilities providing customers with one-stop shop services for Compliance Testing and Global Certifications.



In addition to [testing](#) and [certification](#), SIEMIC provides initial design reviews and [compliance management](#) through out a project. Our extensive experience with [China](#), [Asia Pacific](#), [North America](#), [European](#), and [international](#) compliance requirements, assures the fastest, most cost effective way to attain regulatory compliance for the [global markets](#).

### Accreditations for Conformity Assessment

Country/Region	Accreditation Body	Scope
USA	FCC, A2LA	EMC , RF/Wireless , Telecom
Canada	IC, A2LA, NIST	EMC, RF/Wireless , Telecom
Taiwan	BSMI , NCC , NIST	EMC, RF, Telecom , Safety
Hong Kong	OFTA , NIST	RF/Wireless ,Telecom
Australia	NATA, NIST	EMC, RF, Telecom , Safety
Korea	KCC/RRA, NIST	EMI, EMS, RF , Telecom, Safety
Japan	VCCI, JATE, TELEC, RFT	EMI, RF/Wireless, Telecom
Mexico	NOM, COFETEL, Caniety	Safety, EMC , RF/Wireless, Telecom
Europe	A2LA, NIST	EMC, RF, Telecom , Safety

### Accreditations for Product Certifications

Country/Region	Accreditation Body	Scope
USA	FCC TCB, NIST	EMC , RF , Telecom
Canada	IC FCB , NIST	EMC , RF , Telecom
Singapore	iDA, NIST	EMC , RF , Telecom
EU	NB	EMC & R&TTE Directive
Japan	MIC, (RCB 208)	RF , Telecom
Hong Kong	OFTA (US002)	RF , Telecom



**SIEMIC, INC.**

Accessing global markets

Title: EMC Test Report for b mobile  
Main Model: K103  
Serial Model: N/A  
To: FCC Part 15 Subpart B Class B: 2011

Report No: 12050011-FCC-E1-V2  
Issue Date: February 24, 2012  
Page: 3 of 26  
[www.siemic.com.cn](http://www.siemic.com.cn)

This page has been left blank intentionally.

# CONTENTS

<b>1</b>	<b>EXECUTIVE SUMMARY &amp; EUT INFORMATION .....</b>	<b>5</b>
<b>2</b>	<b>TECHNICAL DETAILS .....</b>	<b>6</b>
<b>3</b>	<b>MODIFICATION.....</b>	<b>7</b>
<b>4</b>	<b>TEST SUMMARY.....</b>	<b>8</b>
<b>5</b>	<b>MEASUREMENTS, EXAMINATION AND DERIVED RESULTS .....</b>	<b>9</b>
	<b>ANNEX A. TEST INSTRUMENT &amp; METHOD .....</b>	<b>15</b>
	<b>ANNEX B. EUT AND TEST SETUP PHOTOGRAPHS .....</b>	<b>20</b>
	<b>ANNEX C. TEST SETUP AND SUPPORTING EQUIPMENT.....</b>	<b>21</b>
	<b>ANNEX D. USER MANUAL / BLOCK DIAGRAM / SCHEMATICS / PART LIST .....</b>	<b>25</b>
	<b>ANNEX E. DECLARATION OF SIMILARITY .....</b>	<b>26</b>

# **1 EXECUTIVE SUMMARY & EUT INFORMATION**

The purpose of this test programme was to demonstrate compliance of the b mobile HK Limited, b mobile and model: K103 against the current Stipulated Standards. The b mobile has demonstrated compliance with the FCC Part 15 Subpart B Class B: 2011.

## **EUT Information**

**EUT Description** : b mobile

**Main Model** : K103

**Serial Model** : N/A

**Input Power** : **B mobile AC Adapter**  
**Input: AC 100-240V 200mA 50/60Hz**  
**Output: DC 5.0V 500mA**  
**Lithium-ion Battery:**  
**Model: B mobile 3.7 V**

**Classification Per Stipulated Test Standard** : **Class B Emission Product Per FCC Part 15 Subpart B Class B: 2011**



**SIEMIC, INC.**

Accessing global markets

Title: EMC Test Report for b mobile  
Main Model: K103  
Serial Model: N/A  
To: FCC Part 15 Subpart B Class B: 2011

Report No: 12050011-FCC-E1-V2  
Issue Date: February 24, 2012  
Page: 6 of 26  
www.siemic.com.cn

## 2 TECHNICAL DETAILS

<b>Purpose</b>	<b>Compliance testing of b mobile with stipulated standard</b>
<b>Applicant / Client</b>	<b>b mobile HK Limited G/F. 144 UN CHAU STREET, SHAM SHUI PO, KOWLOON HONG KONG, CHINA</b>
<b>Manufacturer</b>	<b>Shenzhen Fortune Ship Technology Co., Ltd 401 Zone A~B, TCL Electronics, No.33 Nanhai Avenue, Nanshan District, Shenzhen City</b>
<b>Laboratory performing the tests</b>	<b>SIEMIC Nanjing (China) Laboratories NO.2-1, Longcang Dadao, Yuhua Economic Development Zone, Nanjing, China Tel: +86(25)86730128/86730129 Fax: +86(25)86730127 Email: info@siemic.com</b>
<b>Test report reference number</b>	<b>12050011-FCC-E1-V2</b>
<b>Date EUT received</b>	<b>February 10, 2012</b>
<b>Standard applied</b>	<b>FCC Part 15 Subpart B Class B: 2011</b>
<b>Dates of test</b>	<b>February 17, 2012</b>
<b>No of Units</b>	<b>#1</b>
<b>Equipment Category</b>	<b>Class B Emission Product</b>
<b>Trade Name</b>	<b>B mobile</b>
<b>RF Operating Frequency (ies)</b>	<b>GSM850 TX : 824.2 ~ 848.8 MHz; RX : 869.2 ~ 893.8 MHz PCS1900 TX : 1850.2 ~ 1909.8 MHz; RX : 1930.2 ~ 1989.8 MHz</b>
<b>Number of Channels</b>	<b>300CH (PCS1900) and 125CH (GSM850)</b>
<b>Modulation</b>	<b>GSM: GMSK</b>
<b>FCC ID</b>	<b>ZSW-K103-S225</b>



**SIEMIC, INC.**

Accessing global markets

Title: EMC Test Report for b mobile  
Main Model: K103  
Serial Model: N/A  
To: FCC Part 15 Subpart B Class B: 2011

Report No: 12050011-FCC-E1-V2  
Issue Date: February 24, 2012  
Page: 7 of 26  
[www.siemic.com.cn](http://www.siemic.com.cn)

## **3 MODIFICATION**

**NONE**

## **4 TEST SUMMARY**

The product was tested in accordance with the following specifications.  
All testing has been performed according to below product classification:

### **Class B Emission Product**

#### **Test Results Summary**

Emissions			
Test Standard	Description	Product Class	Pass / Fail
FCC Part 15 Subpart B Class B: 2011	AC Line Conducted Emissions	See Above	Pass
FCC Part 15 Subpart B Class B: 2011	Radiated Emissions	See Above	Pass

All measurement uncertainty is not taken into consideration for all presented test result.



# **5 MEASUREMENTS, EXAMINATION AND DERIVED RESULTS**

## **5.1 AC Line Conducted Emissions Test Result**

*Note:*

1. All possible modes of operation were investigated. Only the 6 worst case emissions measured, using the correct CISPR and Average detectors, are reported. All other emissions were relatively insignificant.
2. A "-ve" margin indicates a PASS as it refers to the margin present below the limit line at the particular frequency.
3. Conducted Emissions Measurement Uncertainty  
All test measurements carried out are traceable to national standards. The uncertainty of the measurement at a confidence level of approximately 95% (in the case where distributions are normal), with a coverage factor of 2, in the range 9 kHz – 30 MHz (Average & Quasi-peak) is  $\pm 3.86\text{dB}$ .
4. Environmental Conditions  

Temperature	16°C
Relative Humidity	50%
Atmospheric Pressure	1009mbar
5. Test date : February 17, 2012  
Tested By : Deon Dai

**Test Result: Pass**

<b>Test Mode:</b>	<b>Charging &amp; Downloading</b>
-------------------	-----------------------------------

**Peak Detector**       **Quasi Peak Limit**        
**Average Detector**       **Average Limit**      

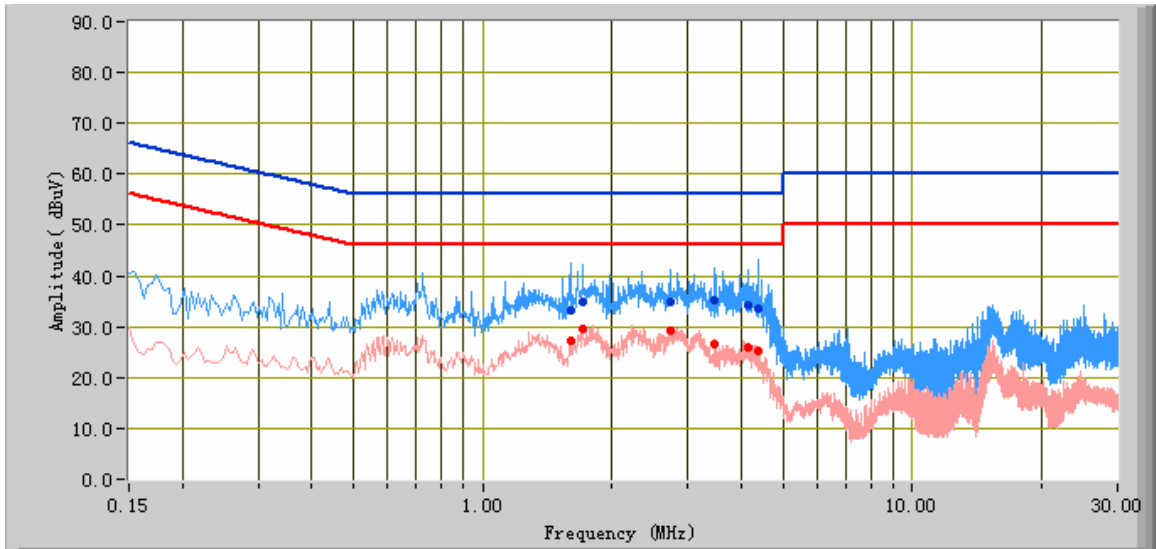

**Test Data**

**Phase Line Plot at 120Vac, 60Hz**

Frequency (MHz)	Quasi Peak (dBµV)	Limit (dBµV)	Margin (dB)	Average (dBµV)	Limit (dBµV)	Margin (dB)	Factors (dB)
4.37	33.48	56.00	-22.52	25.19	46.00	-20.81	10.44
1.60	33.11	56.00	-22.89	27.32	46.00	-18.68	10.18
1.71	35.03	56.00	-20.97	29.40	46.00	-16.60	10.19
3.47	35.17	56.00	-20.83	26.58	46.00	-19.42	10.35
2.72	34.72	56.00	-21.28	29.10	46.00	-16.90	10.20
4.15	34.14	56.00	-21.86	25.92	46.00	-20.08	10.48

<b>Test Mode:</b>	<b>Charging &amp; Downloading</b>
-------------------	-----------------------------------

**Peak Detector**      **Quasi Peak Limit**        
**Average Detector**      **Average Limit**

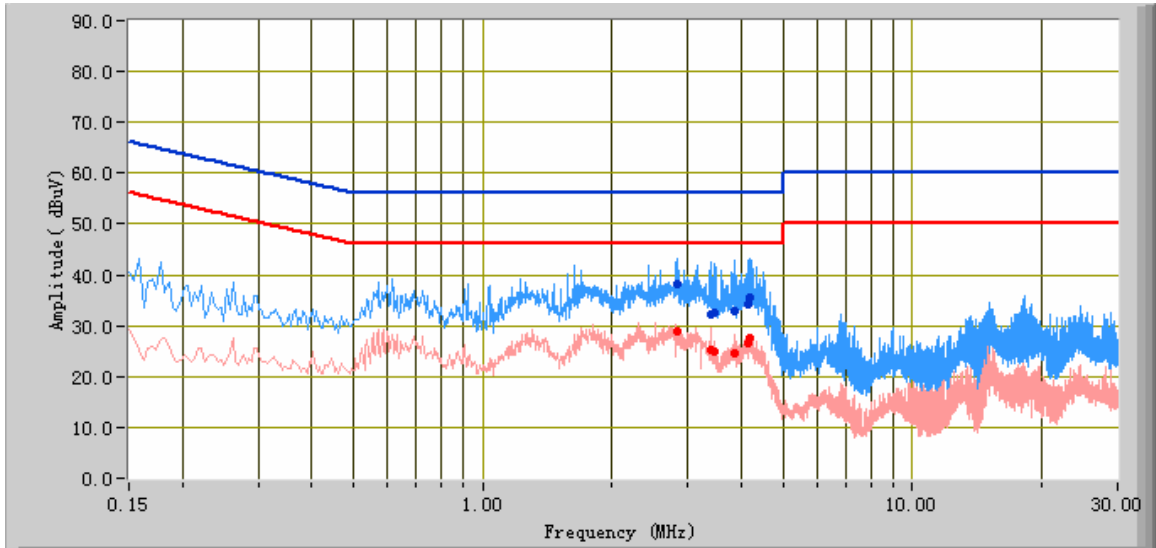

**Test Data**

**Phase Neutral Plot at 120Vac, 60Hz**

Frequency (MHz)	Quasi Peak (dBµV)	Limit (dBµV)	Margin (dB)	Average (dBµV)	Limit (dBµV)	Margin (dB)	Factors (dB)
4.19	35.59	56.00	-20.41	27.46	46.00	-18.54	10.47
2.83	38.27	56.00	-17.73	28.92	46.00	-17.08	10.20
4.15	34.34	56.00	-21.66	26.48	46.00	-19.52	10.48
3.86	32.84	56.00	-23.16	24.62	46.00	-21.38	10.47
3.39	32.25	56.00	-23.75	25.29	46.00	-20.71	10.32
3.47	32.58	56.00	-23.42	24.78	46.00	-21.22	10.35

## **5.2 Radiated Emissions Test Result**

*Note:*



1. All possible modes of operation were investigated. Only the 6 worst case emissions measured, using the correct CISPR detectors, are reported. All other emissions were relatively insignificant.
2. A "-ve" margin indicates a PASS as it refers to the margin present below the limit line at the particular frequency.
3. Radiated Emissions Measurement Uncertainty  
All test measurements carried out are traceable to national standards. The uncertainty of the measurement at a confidence level of approximately 95% (in the case where distributions are normal), with a coverage factor of 2, in the range 30MHz – 1GHz & 1GHz above ( 3m & 10m) is +5.6/-4.5dB.
4. Environmental Conditions  

Temperature	16°C
Relative Humidity	50%
Atmospheric Pressure	1009mbar
5. Test date : February 17, 2012  
Tested By : Deon Dai

**Test Result: Pass**

<b>Test Mode:</b>	<b>Charging &amp; Downloading</b>
-------------------	-----------------------------------

### Below 1GHz

Peak Detector   
 Quasi Peak Limit 

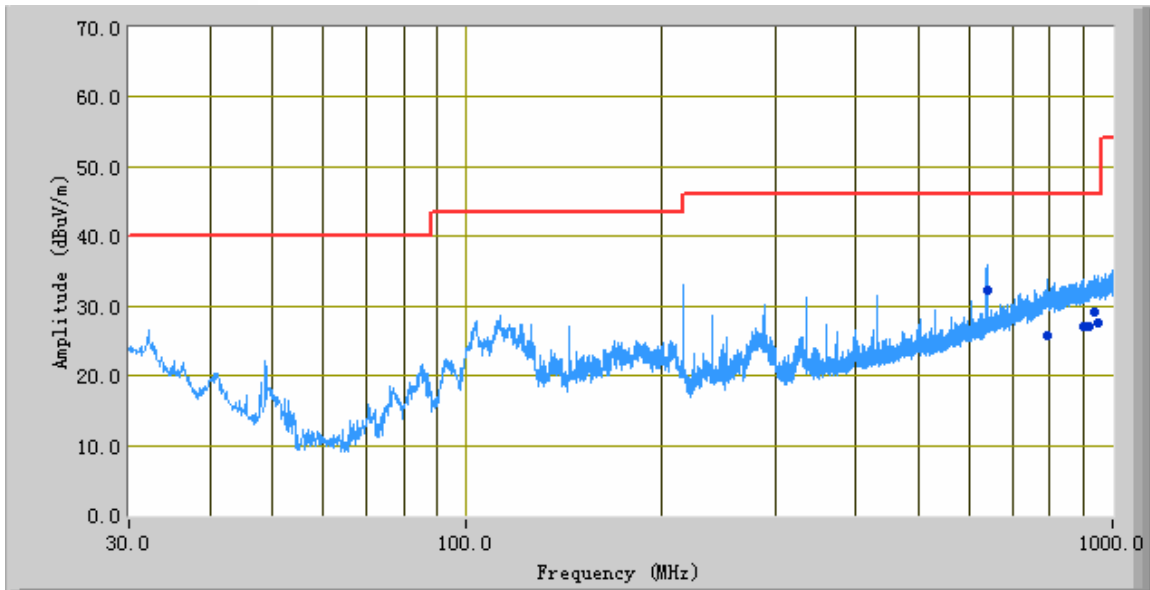



#### Test Data

#### Vertical Polarity Plot @3m

Frequency (MHz)	Quasi Peak (dBµV/m)	Azimuth	Polarity (H/V)	Height (cm)	Factors (dB)	Limit (dBµV/m)	Margin (dB)
640.09	32.98	96.00	V	177.00	-21.11	46.00	-13.02
937.96	29.07	179.00	V	153.00	-15.57	46.00	-16.93
950.88	27.59	349.00	V	267.00	-15.40	46.00	-18.41
899.56	26.97	352.00	V	379.00	-15.16	46.00	-19.03
792.74	25.85	21.00	V	174.00	-17.37	46.00	-20.15
920.26	27.00	31.00	V	147.00	-15.27	46.00	-19.00

<b>Test Mode:</b>	<b>Charging &amp; Downloading</b>
-------------------	-----------------------------------

Peak Detector   
 Quasi Peak Limit 

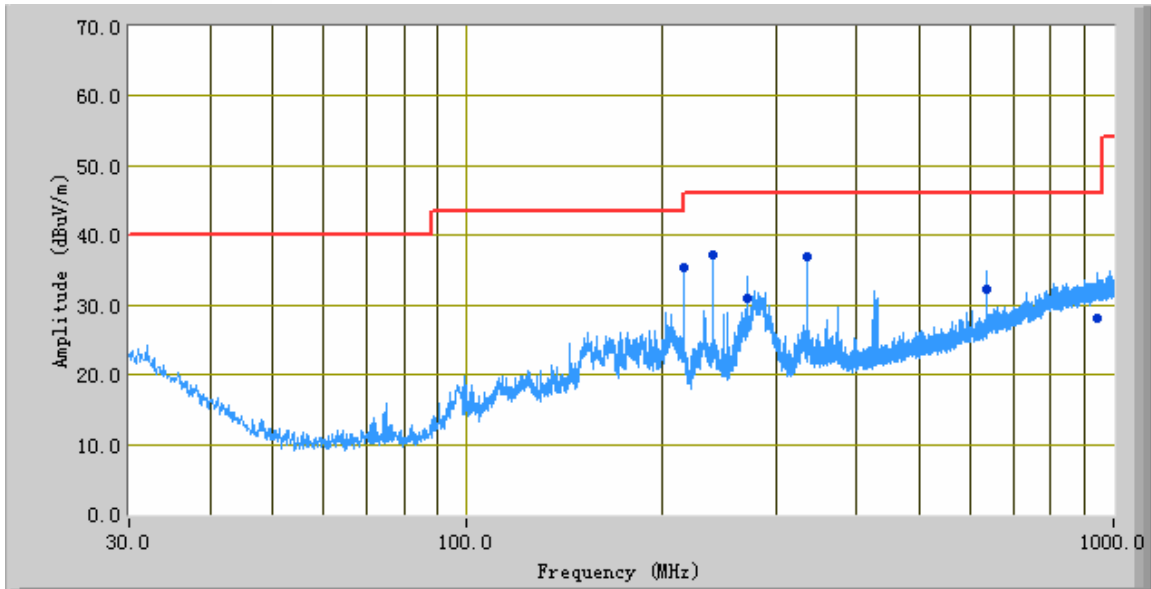

**Test Data**

**Horizontal Polarity Plot @3m**

Frequency (MHz)	Quasi Peak (dBµV/m)	Azimuth	Polarity (H/V)	Height (cm)	Factors (dB)	Limit (dBµV/m)	Margin (dB)
240.00	37.22	117.00	H	115.00	-31.52	46.00	-8.78
336.00	36.96	270.00	H	100.00	-29.09	46.00	-9.04
216.43	35.37	76.00	H	119.00	-32.09	46.00	-10.63
635.03	32.33	242.00	H	109.00	-20.67	46.00	-13.67
945.24	28.13	295.00	H	233.00	-15.05	46.00	-17.87
270.94	30.95	47.00	H	100.00	-30.17	46.00	-15.05

*Note: The data above 1 GHz which below 20 dB to the limit was not recorded.*

**Annex A. TEST INSTRUMENT & METHOD**

**Annex A.i. TEST INSTRUMENTATION & GENERAL PROCEDURES**

Instrument	Model	Calibration Date	Calibration Due Date
<b>AC Line Conducted Emissions</b>			
R&S EMI Test Receiver	ESPI3	05/25/2011	05/25/2012
Com-Power LISN	LI-115	05/25/2011	05/25/2012
A-INFOMW Antenna(1 ~18GHz)	JXTXLB-10180	06/02/2011	06/02/2012
Universal Radio Communication Tester	CMU200	05/22/2011	05/22/2012
<b>Radiated Emissions</b>			
Hp Spectrum Analyzer	8563E	04/10/2011	04/10/2012
R&S EMI Receiver	ESPI3	05/18/2011	05/18/2012
Antenna (30MHz~2GHz)	JB1	05/25/2011	05/25/2012
ETS-Lindgren Antenna(1 ~18GHz)	3115	06/02/2011	06/02/2012
A-INFOMW Antenna(1 ~18GHz)	JXTXLB-10180	06/02/2011	06/02/2012
Horn Antenna (18~40GHz)	AH-840	07/23/2011	07/23/2013
Microwave Pre-Amp (18~40GHz)	PA-840	Every 2000 Hours	
Hp Agilent Pre-Amplifier	8447F	05/25/2011	05/25/2012
MITEQ Pre-Amplifier(1 ~ 18GHz)	AMF-7D-00101800-30-10P	05/25/2011	05/25/2012
Universal Radio Communication Tester	CMU200	05/22/2011	05/22/2012
Chamber	3m	04/13/2011	04/13/2012

## **Annex A.ii. AC LINE CONDUCTED EMISSIONS TEST DESCRIPTION**

### **Test Set-up**

1. The EUT and supporting equipment were set up in accordance with the requirements of the standard on top of a 1.5m x 1m x 0.8m high, non-metallic table, as shown in Annex B.
2. The power supply for the EUT was fed through a 50Ω/50μH EUT LISN, connected to filtered mains.
3. The RF OUT of the EUT LISN was connected to the EMI test receiver via a low-loss coaxial cable.
4. All other supporting equipments were powered separately from another main supply.

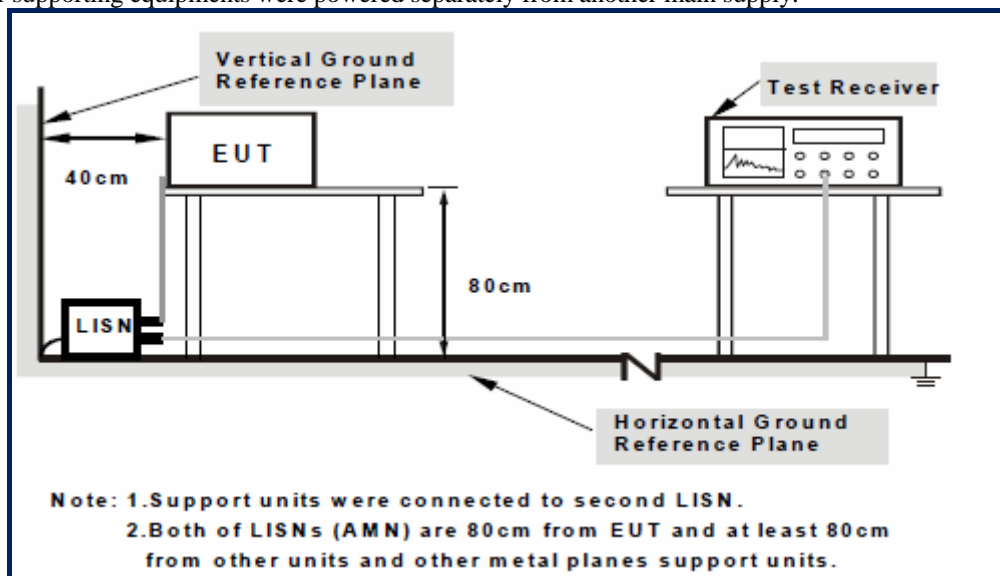

For the actual test configuration, please refer to the related item – Photographs of the Test Configuration1

### **Test Method**

1. The EUT was switched on and allowed to warm up to its normal operating condition.
2. A scan was made on the NEUTRAL line (for AC mains) or Earth line (for DC power) over the required frequency range using an EMI test receiver.
3. High peaks, relative to the limit line, were then selected.
4. The EMI test receiver was then tuned to the selected frequencies and the necessary measurements made with a receiver bandwidth setting of 10 kHz. For FCC tests, only Quasi-peak measurements were made; while for CISPR/EN tests, both Quasi-peak and Average measurements were made.
5. Steps 2 to 4 were then repeated for the LIVE line (for AC mains) or DC line (for DC power).

### **Description of Conducted Emission Program**

This EMC Measurement software run LabView automation software and offers a common user interface for electromagnetic interference (EMI) measurements. This software is a modern and powerful tool for controlling and monitoring EMI test receivers and EMC test systems. It guarantees reliable collection, evaluation, and documentation of measurement results. Basically, this program will run a pre-scan measurement before it proceeds with the final measurement. The pre-scan routine will run the common scan range from 150 kHz to 30 MHz; the program will first start a peak and average scan on selectable measurement time and step size. After the program complete the pre-scan, this program will perform the Quasi Peak and Average measurement, based on the pre-scan peak data reduction result.





**SIEMIC, INC.**

Accessing global markets

Title: EMC Test Report for b mobile  
Main Model: K103  
Serial Model: N/A  
To: FCC Part 15 Subpart B Class B: 2011

Report No: 12050011-FCC-E1-V2  
Issue Date: February 24, 2012  
Page: 17 of 26  
[www.siemic.com.cn](http://www.siemic.com.cn)

## Sample Calculation Example

At 20 MHz

limit =  $250 \mu\text{V} = 47.96 \text{ dB}\mu\text{V}$

Transducer factor of LISN, pulse limiter & cable loss at 20 MHz = 11.20 dB

Q-P reading obtained directly from EMI Receiver = 40.00 dB $\mu\text{V}$   
(Calibrated for system losses)

Therefore, Q-P margin =  $47.96 - 40.00 = 7.96$  i.e. **7.96 dB below limit**

**Annex A.iii. RADIATED EMISSIONS TEST DESCRIPTION**

**EUT Characterisation**

EUT characterisation, over the frequency range from 30MHz to 10<sup>th</sup> Harmonic, was done in order to minimise radiated emissions testing time while still maintaining high confidence in the test results.

The EUT was placed in the chamber, at a height of about 0.8m on a turntable. Its radiated emissions frequency profile was observed, using a spectrum analyzer /receiver with the appropriate broadband antenna placed 3m away from the EUT. Radiated emissions from the EUT were maximised by rotating the turntable manually, changing the antenna polarisation and manipulating the EUT cables while observing the frequency profile on the spectrum analyzer / receiver. Frequency points at which maximum emissions occurred, clock frequencies and operating frequencies were then noted for the formal radiated emissions test at the Open Area Test Site (OATS) or EMC chamber.

**Test Set-up**

1. The EUT and supporting equipment were set up in accordance with the requirements of the standard on top of a 1.5m X 1.0m X 0.8m high, non-metallic table.
2. The filtered power supply for the EUT and supporting equipment were tapped from the appropriate power sockets located on the turntable.
3. The relevant broadband antenna was set at the required test distance away from the EUT and supporting equipment boundary.

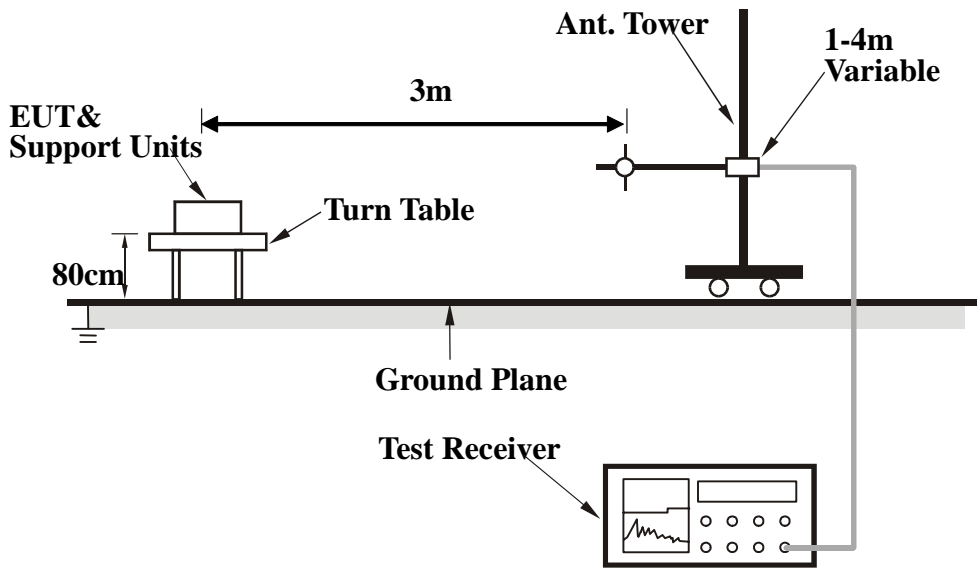

For the actual test configuration, please refer to the related item – Photographs of the Test Configuration2

**Test Method**

The following procedure was performed to determine the maximum emission axis of EUT:

1. With the receiving antenna is H polarization, rotate the EUT in turns with three orthogonal axes to determine the axis of maximum emission.
2. With the receiving antenna is V polarization, rotate the EUT in turns with three orthogonal axes to determine the axis of maximum emission.
3. Compare the results derived from above two steps. So, the axis of maximum emission from EUT was determined and the configuration was used to perform the final measurement.

**Final Radiated Emission Measurement**

1. Setup the configuration according to figure 1. Turn on EUT and make sure that it is in normal function.
2. For emission frequencies measured below 1 GHz, a pre-scan is performed in a shielded chamber to determine the accurate frequencies of higher emissions will be checked on a open test site. As the same purpose, for emission frequencies measured above 1 GHz, a pre-scan also be performed with a 1 meter measuring distance before final test.
3. For emission frequencies measured below and above 1 GHz, set the spectrum analyzer on a 100 kHz and 1 MHz resolution bandwidth respectively for each frequency measured in step 2.
4. The search antenna is to be raised and lowered over a range from 1 to 4 meters in horizontally polarized orientation. Position the highness when the highest value is indicated on spectrum analyzer, then change the orientation of EUT on test table over a range from 0° to 360° with a speed as slow as possible, and keep the azimuth that highest emission is indicated on the spectrum analyzer. Vary the antenna position again and record the highest value as a final reading.
5. Repeat step 4 until all frequencies need to be measured were complete.
6. Repeat step 5 with search antenna in vertical polarized orientations.

During the radiated emission test, the Spectrum Analyzer was set with the following configurations:

Frequency Band (MHz)	Function	Resolution bandwidth	Video Bandwidth
30 to 1000	Peak	100 kHz	100 kHz
Above 1000	Peak	1 MHz	1 MHz
	Average	1 MHz	10 Hz

**Sample Calculation Example**

The field strength is calculated by adding the Antenna Factor and Cable Factor, and subtracting the Amplifier Gain (if any) from the measured reading. For the limit is employed average value, therefore the peak value can be transferred to average value by subtracting the duty factor. The basic equation with a sample calculation is as follows:

$$\text{Peak} = \text{Reading} + \text{Corrected Factor}$$

where

$$\text{Corr. Factor} = \text{Antenna Factor} + \text{Cable Factor} - \text{Amplifier Gain (if any)}$$

And the average value is

$$\text{Average} = \text{Peak Value} + \text{Duty Factor or}$$

$$\text{Set RBW} = 1\text{MHz}, \text{VBW} = 10\text{Hz.}$$

Note:

If the measured frequencies are fall in the restricted frequency band, the limit employed must be quasi peak value when frequencies are below or equal to 1 GHz. And the measuring instrument is set to quasi peak detector function.



**SIEMIC, INC.**

Accessing global markets

Title: EMC Test Report for b mobile  
Main Model: K103  
Serial Model: N/A  
To: FCC Part 15 Subpart B Class B: 2011

Report No: 12050011-FCC-E1-V2  
Issue Date: February 24, 2012  
Page: 20 of 26  
[www.siemic.com.cn](http://www.siemic.com.cn)

## **Annex B. EUT AND TEST SETUP PHOTOGRAPHS**

**Please see attachment**

**Annex C. TEST SETUP AND SUPPORTING EQUIPMENT**

**EUT TEST CONDITIONS**

**Annex C. i. SUPPORTING EQUIPMENT DESCRIPTION**

The following is a description of supporting equipment and details of cables used with the EUT.

<b>Equipment Description (Including Brand Name)</b>	<b>Model &amp; Serial Number</b>	<b>Cable Description (List Length, Type &amp; Purpose)</b>
Gateway Laptop	MS2288 & LXWHF02013951C3CA92200	N/A

### Block Configuration Diagram for Conducted Emissions

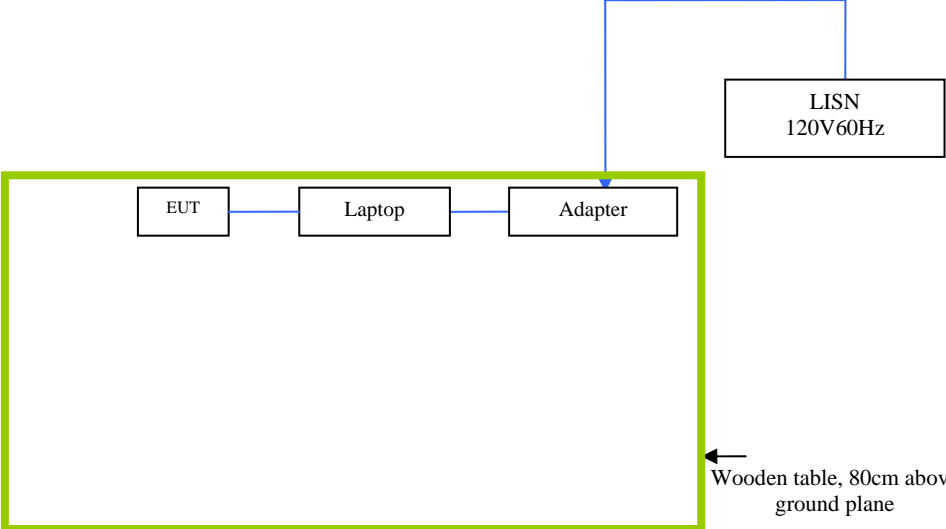

### Block Configuration Diagram for Radiated Emissions

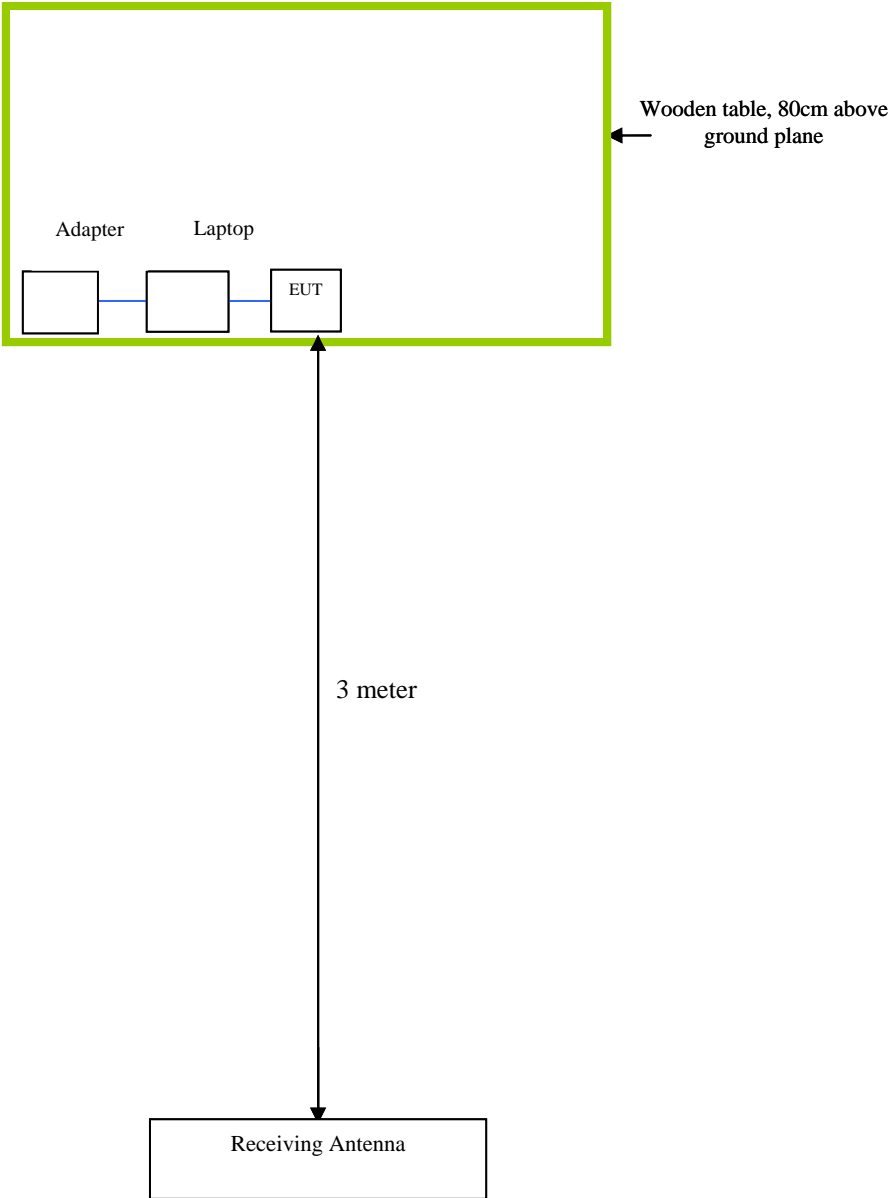



**SIEMIC, INC.**

Accessing global markets

Title: EMC Test Report for b mobile  
Main Model: K103  
Serial Model: N/A  
To: FCC Part 15 Subpart B Class B: 2011

Report No: 12050011-FCC-E1-V2  
Issue Date: February 24, 2012  
Page: 24 of 26  
www.siemic.com.cn

### **Annex C.ii. EUT OPERATING CONDITIONS**

The following is the description of how the EUT is exercised during testing.

<b>Test</b>	<b>Description Of Operation</b>
Emissions Testing	Charging & Downloading





**SIEMIC, INC.**

Accessing global markets

Title: EMC Test Report for b mobile  
Main Model: K103  
Serial Model: N/A  
To: FCC Part 15 Subpart B Class B: 2011

Report No: 12050011-FCC-E1-V2  
Issue Date: February 24, 2012  
Page: 25 of 26  
[www.siemic.com.cn](http://www.siemic.com.cn)

## **Annex D. USER MANUAL / BLOCK DIAGRAM / SCHEMATICS / PART LIST**

**Please see attachment**



**SIEMIC, INC.**

Accessing global markets

Title: EMC Test Report for b mobile  
Main Model: K103  
Serial Model: N/A  
To: FCC Part 15 Subpart B Class B: 2011

Report No: 12050011-FCC-E1-V2  
Issue Date: February 24, 2012  
Page: 26 of 26  
[www.siemic.com.cn](http://www.siemic.com.cn)

## **Annex E. DECLARATION OF SIMILARITY**

**Please see attachment**