



# RF TEST REPORT



Report No.: 14050063-FCC-R1

Supersede Report No.: N/A

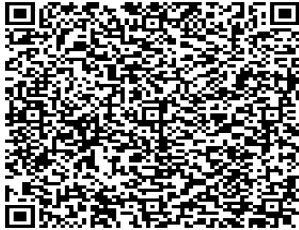
Applicant	B mobile HK Limited	
Product Name	Mobile phone	
Model No.	AX512	
Test Standard	FCC Part 22(H) & FCC Part 24(E): 2013; ANSI/TIA C63-D: 2010	
Test Date	November 06 to November 10, 2014	
Issue Date	November 11, 2014	
Test Result	<input checked="" type="checkbox"/> Pass <input type="checkbox"/> Fail	
Equipment complied with the specification	<input checked="" type="checkbox"/>	
Equipment did not comply with the specification	<input type="checkbox"/>	
		
David Huang Test Engineer	Alex Liu Checked By	
<b>This test report may be reproduced in full only</b> <b>Test result presented in this test report is applicable to the tested sample only</b>		

Issued by:

**SIEMIC (SHENZHEN-CHINA) LABORATORIES**

Zone A, Floor 1, Building 2 Wan Ye Long Technology Park

South Side of Zhoushi Road, Bao' an District, Shenzhen, Guangdong China 518108

Phone: +86 0755 2601 4629801 Email: [China@siemic.com.cn](mailto:China@siemic.com.cn)

## Laboratories Introduction

SIEMIC, headquartered in the heart of Silicon Valley, with superior facilities in US and Asia, is one of the leading independent testing and certification facilities providing customers with one-stop shop services for Compliance Testing and Global Certifications.



In addition to testing and certification, SIEMIC provides initial design reviews and compliance management throughout a project. Our extensive experience with China, Asia Pacific, North America, European, and International compliance requirements, assures the fastest, most cost effective way to attain regulatory compliance for the global markets.

### Accreditations for Conformity Assessment

Country/Region	Scope
USA	EMC, RF/Wireless, SAR, Telecom
Canada	EMC, RF/Wireless, SAR, Telecom
Taiwan	EMC, RF, Telecom, SAR, Safety
Hong Kong	RF/Wireless, SAR, Telecom
Australia	EMC, RF, Telecom, SAR, Safety
Korea	EMI, EMS, RF, SAR, Telecom, Safety
Japan	EMI, RF/Wireless, SAR, Telecom
Singapore	EMC, RF, SAR, Telecom
Europe	EMC, RF, SAR, Telecom, Safety

Test Report	14050063-FCC-R1
Page	3 of 53

This page has been left blank intentionally.

# CONTENTS

<b>1. REPORT REVISION HISTORY .....</b>	<b>5</b>
<b>2. CUSTOMER INFORMATION .....</b>	<b>5</b>
<b>3. TEST SITE INFORMATION.....</b>	<b>5</b>
<b>4. EQUIPMENT UNDER TEST (EUT) INFORMATION .....</b>	<b>6</b>
<b>5. TEST SUMMARY .....</b>	<b>8</b>
<b>6. MEASUREMENTS, EXAMINATION AND DERIVED RESULTS .....</b>	<b>9</b>
6.1 RF EXPOSURE (SAR).....	9
6.2 RF OUTPUT POWER .....	10
6.3 PEAK-AVERAGE RATIO .....	18
6.4 MODULATION CHARACTERISTIC.....	20
6.5 OCCUPIED BANDWIDTH.....	21
6.6 SPURIOUS EMISSIONS AT ANTENNA TERMINALS .....	25
6.7 SPURIOUS RADIATED EMISSIONS .....	30
6.8 BAND EDGE.....	35
6.9 FREQUENCY STABILITY .....	39
<b>ANNEX A. TEST INSTRUMENT.....</b>	<b>43</b>
<b>ANNEX B. EUT AND TEST SETUP PHOTOGRAPHS.....</b>	<b>44</b>
<b>ANNEX C. TEST SETUP AND SUPPORTING EQUIPMENT.....</b>	<b>49</b>
<b>ANNEX C.II. EUT OPERATING CONKITIONS.....</b>	<b>51</b>
<b>ANNEX D. USER MANUAL / BLOCK DIAGRAM / SCHEMATICS / PARTLIST .....</b>	<b>52</b>
<b>ANNEX E. DECLARATION OF SIMILARITY.....</b>	<b>53</b>

## 1. Report Revision History

Report No.	Report Version	Description	Issue Date
14050063-FCC-R1	NONE	Original	November 11, 2014

## 2. Customer information

Applicant Name	B mobile HK Limited
Applicant Add	Flat 18; 14/F Block 1; Golden Industrial Building; 16-26 Kwai Tak Street; Kwai Chung; New Territories ; HONG KONG , CHINA
Manufacturer	B mobile HK Limited
Manufacturer Add	Flat 18; 14/F Block 1; Golden Industrial Building; 16-26 Kwai Tak Street; Kwai Chung; New Territories ; HONG KONG , CHINA

## 3. Test site information

Lab performing tests	SIEMIC (Shenzhen-China) LABORATORIES
Lab Address	Zone A, Floor 1, Building 2 Wan Ye Long Technology Park South Side of Zhoushi Road, Bao' an District, Shenzhen, Guangdong China 518108
FCC Test Site No.	718246
IC Test Site No.	4842E-1
Test Software	LabView of SIEMIC version 2.0

## 4. Equipment under Test (EUT) Information

Description of EUT:	Mobile phone
Main Model:	AX512
Serial Model:	N/A
Date EUT received:	October 27, 2014
Test Date(s):	November 06 to November 10, 2014
Equipment Category :	PCE
Antenna Gain:	GSM850: -1.87 dBi PCS1900:-0.75 dBi UMTS-FDD Band II / UMTS-FDD Band V: -0.62 Bluetooth: 0.7 dBi WIFI: 0.7 dBi
Type of Modulation:	GSM / GPRS: GMSK EGPRS: GMSK, 8PSK UMTS-FDD: QPSK 802.11b/g/n: DSSS, OFDM Bluetooth: GFSK, $\pi$ /4DQPSK, 8DPSK
RF Operating Frequency (ies):	GSM850 TX: 824.2 ~ 848.8 MHz; RX: 869.2 ~ 893.8 MHz PCS1900 TX: 1850.2 ~ 1909.8 MHz; RX: 1930.2 ~ 1989.8 MHz UMTS-FDD Band V TX: 826.4 ~ 846.6 MHz; RX: 871.4 ~ 891.6 MHz UMTS-FDD Band II TX:1852.4 ~ 1907.6 MHz; RX: 1932.4 ~ 1987.6 MHz WIFI:802.11b/g/n(20M): 2412-2462 MHz Bluetooth: 2402-2480 MHz
Maximum Conducted AV Power to Antenna:	GSM850: 33.09dBm PCS1900: 29.97 dBm UMTS-FDD BandV : 22.99 dBm UMTS-FDD BandII : 22.06 dBm

ERP/EIRP: GSM850: 28.03 dBm / ERP  
 PCS1900:25.60 dBm / EIRP  
 UMTS-FDD BandV : 19.74 dBm / ERP  
 UMTS-FDD BandII : 19.58 dBm / EIRP

Number of Channels: GSM 850: 124CH  
 PCS1900: 299CH  
 WIFI :802.11b/g/n(20M): 11CH  
 Bluetooth: 79CH

Port: Power Port, Earphone Port, USB Port

Input Power: Battery:  
 Model: BH-P4B  
 Spec: 3.7V 1300mAh  
 Limited charger voltage: 4.2V  
 Adapter:  
 Model: AX512  
 Input: AC 100-240V; 50/60Hz 0.15A  
 Output: DC 5.0V; 500mA

Trade Name : Bmobile

GPRS/EGPRS Multi-slot class 8/10/12

FCC ID: ZSW-AX512

## 5. Test Summary

The product was tested in accordance with the following specifications.

All testing has been performed according to below product classification:

FCC Rules	Description of Test	Result
§ 1.1307, § 2.1093	RF Exposure (SAR)	Compliance
§2.1046;§ 22.913 (a); § 24.232 (c)	RF Output Power	Compliance
§ 24.232 (d)	Peak-Average Ratio	Compliance
§ 2.1047	Modulation Characteristics	Compliance
§ 2.1049; § 22.905 § 22.917; § 24.238	99% & -26 dB Occupied Bandwidth	Compliance
§ 2.1051,§ 22.917 (a); § 24.238 (a)	Spurious Emissions at Antenna Terminal	Compliance
§ 2.1053§ 22.917 (a); § 24.238 (a)	Field Strength of Spurious Radiation	Compliance
§ 22.917 (a); § 24.238 (a)	Out of band emission, Band Edge	Compliance
§ 2.1055 § 22.355; § 24.235	Frequency stability vs. temperature Frequency stability vs. voltage	Compliance

Note: Testing was performed by configuring EUT to maximum output power status, the declared output power class for different

### Measurement Uncertainty

Emissions		
Test Item	Description	Uncertainty
Band Edge and Radiated Spurious Emissions	Confidence level of approximately 95% (in the case where distributions are normal), with a coverage factor of 2 (for EUTs < 0.5m X 0.5m X 0.5m)	+5.6dB/-4.5dB



## **6. MEASUREMENTS, EXAMINATION AND DERIVED RESULTS**

### **6.1 RF Exposure (SAR)**

Test Result: Pass

The EUT is a portable device, thus requires SAR evaluation;

Please refer to RF Exposure Evaluation Report: 14050063-FCC-H.

## 6.2 RF Output Power

Temperature	26°C
Relative Humidity	56%
Atmospheric Pressure	1007mbar
Test date :	November 07, 2014
Tested By :	David Huang

### Requirement(s):

Spec	Item	Requirement	Applicable
§22.913 (a)	a)	ERP:38.45dBm	<input checked="" type="checkbox"/>
§24.232 (c)	b)	EIRP:33dBm	<input checked="" type="checkbox"/>

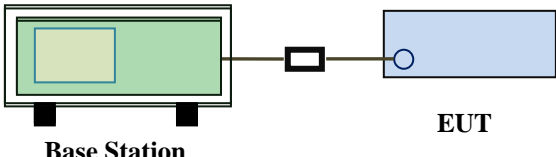
Test Setup	 <p>The diagram illustrates the test setup. On the left, a green rectangular box labeled 'Base Station' is shown. A line connects it to a small black square, which in turn connects to a blue rectangular box labeled 'EUT' (Equipment Under Test).</p>
------------	---

Test Procedure	<p>For Conducted Power:</p> <ul style="list-style-type: none"> <li>- The transmitter output port was connected to base station.</li> <li>- Set EUT at maximum power through base station.</li> <li>- Select lowest, middle, and highest channels for each band and different test mode.</li> </ul> <p>For ERP/EIRP:</p> <ul style="list-style-type: none"> <li>- The transmitter was placed on a wooden turntable, and it was transmitting into a non-radiating load which was also placed on the turntable.</li> <li>- The measurement antenna was placed at a distance of 3 meters from the EUT. During the tests, the antenna height and polarization as well as EUT azimuth were varied in order to identify the maximum level of emissions from the EUT. The test was performed by placing the EUT on 3-orthogonal axis.</li> <li>- The frequency range up to tenth harmonic of the fundamental frequency was investigated.</li> <li>- Remove the EUT and replace it with substitution antenna. A signal generator was connected to the substitution antenna by a non-</li> </ul>
----------------	--

Test Report	14050063-FCC-R1
Page	11 of 53

	<p>radiating cable. The absolute levels of the spurious emissions were measured by the substitution.</p> <ul style="list-style-type: none"> <li>- Spurious emissions in dB = 10 log (TX power in Watts/0.001) – the absolute level</li> <li>- Spurious attenuation limit in dB = 43 + 10 Log10 (power out in Watts).</li> </ul>
Remark	
Result	<input checked="" type="checkbox"/> Pass <input type="checkbox"/> Fail

Test Data     Yes                       N/A  
 Test Plot      Yes (See below)             N/A

## Conducted Power

### GSM Mode:

Burst Average Power (dBm);								
Band	GSM850				GSM1900			
Channel	128	190	251	Tune up Power tolerant	512	661	810	Tune up Power tolerant
Frequency (MHz)	824.2	836.6	848.8	/	1850.2	1880	1909.8	/
GSM Voice (1 uplink),GMSK	33.08	<b>33.09</b>	33.04	33±1	29.75	29.77	<b>29.97</b>	29±1
GPRS Multi-Slot Class 8 (1 uplink),GMSK	33.07	33.08	33.02	33±1	29.73	29.76	29.95	29±1
GPRS Multi-Slot Class 10 (2 uplink) GMSK	32.64	32.63	32.57	32±1	29.22	29.22	29.40	29±1
GPRS Multi-Slot Class 12 (4 uplink) GMSK (4 uplink),GMSK	30.28	30.26	30.21	29.3±1	26.58	26.68	26.93	26±1
EGPRS Multi-Slot Class 8 (1 uplink) GMSK MCS1	33.02	32.98	32.92	33±1	29.73	29.75	29.85	29±1
EGPRS Multi-Slot Class 10 (2 uplink) GMSK MCS1	32.48	32.45	32.38	32±1	29.15	29.15	29.36	29±1
EGPRS Multi-Slot Class 12 (4 uplink) GMSK MCS1	30.14	30.09	30.04	29.3±1	26.56	26.63	26.88	26±1
EGPRS Multi-Slot Class 8 (1 uplink) 8PSK MCS5	27.54	27.48	26.98	27±1	25.21	25.07	24.95	25±1
EGPRS Multi-Slot Class 10 (2 uplink) 8PSK MCS5	26.54	26.48	25.83	26±1	24.41	24.23	24.04	24±1
EGPRS Multi-Slot Class 12 (4 uplink) 8PSK MCS5	23.37	23.25	22.73	23±1	21.47	21.32	21.11	21±1

Test Report	14050063-FCC-R1
Page	13 of 53

Remark :

GPRS, CS1 coding scheme.

EGPRS, MCS1 coding scheme.

EGPRS, MCS5 coding scheme.

Multi-Slot Class 8 , Support Max 4 downlink, 1 uplink , 5 working link

Multi-Slot Class 10 , Support Max 4 downlink, 2 uplink , 5 working link

Multi-Slot Class 12 , Support Max 4 downlink, 4 uplink , 5 working link

**Note: Since GSM mode has higher power, so the test items below were not performed to GPRS mode.**

## UMTS Mode:

### UMTS-FDD Band V

Band/ Time Slot configuration	Channel	Frequency	Average power (dBm)
RMC 12.2kbps	4132	826.4	<b>22.99</b>
	4175	835	22.99
	4233	846.6	22.89
HSDPA Subtest1	4132	826.4	22.97
	4175	835	22.98
	4233	846.6	22.87
HSDPA Subtest2	4132	826.4	22.96
	4175	835	22.97
	4233	846.6	22.86
HSDPA Subtest3	4132	826.4	22.95
	4175	835	22.95
	4233	846.6	22.85
HSDPA Subtest4	4132	826.4	22.95
	4175	835	22.96
	4233	846.6	22.84
HSUPA Subtest1	4132	826.4	22.97
	4175	835	22.95
	4233	846.6	22.83
HSUPA Subtest2	4132	826.4	22.95
	4175	835	22.95
	4233	846.6	22.82
HSUPA Subtest3	4132	826.4	22.94
	4175	835	22.96
	4233	846.6	22.84
HSUPA Subtest4	4132	826.4	22.91
	4175	835	22.93
	4233	846.6	22.83
HSUPA Subtest5	4132	826.4	22.95
	4175	835	22.92
	4233	846.6	22.83

## UMTS-FDD Band II

Band/ Time Slot configuration	Channel	Frequency	Average power (dBm)
RMC 12.2kbps	9262	1852.4	<b>22.06</b>
	9400	1880	21.80
	9538	1907.6	21.67
HSDPA Subtest1	9262	1852.4	22.05
	9400	1880	21.78
	9538	1907.6	21.65
HSDPA Subtest2	9262	1852.4	22.03
	9400	1880	21.76
	9538	1907.6	21.66
HSDPA Subtest3	9262	1852.4	22.05
	9400	1880	21.77
	9538	1907.6	21.67
HSDPA Subtest4	9262	1852.4	22.03
	9400	1880	21.76
	9538	1907.6	21.65
HSUPA Subtest1	9262	1852.4	22.01
	9400	1880	21.74
	9538	1907.6	21.63
HSUPA Subtest2	9262	1852.4	22.05
	9400	1880	21.75
	9538	1907.6	21.64
HSUPA Subtest3	9262	1852.4	22.06
	9400	1880	21.72
	9538	1907.6	21.63
HSUPA Subtest4	9262	1852.4	22.02
	9400	1880	21.75
	9538	1907.6	21.64
HSUPA Subtest5	9262	1852.4	22.05
	9400	1880	21.74
	9538	1907.6	21.63

## ERP & EIRP

### ERP for Cellular Band (Part 22H)

Frequency (MHz)	Substituted level (dBm)	Antenna Polarization	Antenna Gain correction (dBi)	Cable Loss (dB)	Absolute Level (dBm)	Limit (dBm)
824.2	21.76	V	6.8	0.53	<b>28.03</b>	38.45
824.2	20.82	H	6.8	0.53	27.09	38.45
836.6	21.63	V	6.8	0.53	27.90	38.45
836.6	20.74	H	6.8	0.53	27.01	38.45
848.8	21.61	V	6.9	0.53	27.98	38.45
848.8	20.79	H	6.9	0.53	27.16	38.45

### EIRP for PCS Band (Part 24E)

Frequency (MHz)	Substituted level (dBm)	Antenna Polarization	Antenna Gain correction (dBi)	Cable Loss (dB)	Absolute Level (dBm)	Limit (dBm)
1850.2	18.53	V	7.88	0.85	25.56	33
1850.2	17.65	H	7.88	0.85	24.68	33
1880	18.47	V	7.88	0.85	25.50	33
1880	17.55	H	7.88	0.85	24.58	33
1909.8	18.59	V	7.86	0.85	<b>25.60</b>	33
1909.8	17.58	H	7.86	0.85	24.59	33



### ERP for UMTS-FDD Band V (Part 22H)

Frequency (MHz)	Substituted level (dBm)	Antenna Polarization	Antenna Gain correction (dBi)	Cable Loss (dB)	Absolute Level (dBm)	Limit (dBm)
826.4	13.44	V	6.8	0.53	19.71	38.45
826.4	12.73	H	6.8	0.53	19.00	38.45
835	13.35	V	6.8	0.53	19.62	38.45
835	12.82	H	6.8	0.53	19.09	38.45
846.6	13.37	V	6.9	0.53	<b>19.74</b>	38.45
846.6	13.01	H	6.9	0.53	19.38	38.45

### EIRP for UMTS-FDD Band II (Part 24E)

Frequency (MHz)	Substituted level (dBm)	Antenna Polarization	Antenna Gain correction (dBi)	Cable Loss (dB)	Absolute Level (dBm)	Limit (dBm)
1852.4	12.55	V	7.88	0.85	<b>19.58</b>	33
1852.4	12.17	H	7.88	0.85	19.20	33
1880	12.46	V	7.88	0.85	19.49	33
1880	12.06	H	7.88	0.85	19.09	33
1907.6	12.51	V	7.86	0.85	19.52	33
1907.6	12.01	H	7.86	0.85	19.02	33

### 6.3 Peak-Average Ratio

Temperature	26oC
Relative Humidity	56%
Atmospheric Pressure	1007mbar
Test date :	November 07, 2014
Tested By :	David Huang

Requirement(s):

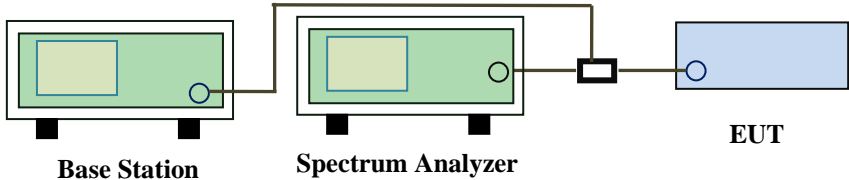
Spec	Item	Requirement	Applicable
§24.232(d)	a)	The peak-to-average ratio (PAR) of the transmission may not exceed 13 dB.	<input checked="" type="checkbox"/>
Test Setup	 <p style="text-align: center;"> <span>Base Station</span>      <span>Spectrum Analyzer</span>      <span>EUT</span> </p>		
Test Procedure	<p><b>According with KDB 971168</b></p> <ol style="list-style-type: none"> <li>1. The signal analyzer' s CCDF measurement profile is enabled</li> <li>2. Frequency = carrier center frequency</li> <li>3. Measurement BW &gt; Emission bandwidth of signal</li> <li>4. The signal analyzer was set to collect one million samples to generate the CCDF curve</li> <li>5. The measurement interval was set depending on the type of signal analyzed. For continuous signals (&gt;98% duty cycle), the measurement interval was set to 1ms. For burst transmissions, the spectrum analyzer is set to use an internal “ RF Burst” trigger that is synced with an incoming pulse and the measurement interval is set to less than the duration of the “ on time” of one burst to ensure that energy is only captured during a time in which the transmitter is operating at maximum power</li> </ol>		
Remark			
Result	<input checked="" type="checkbox"/> Pass <input type="checkbox"/> Fail		

Test Data     Yes       N/A  
 Test Plot     Yes (See below)       N/A

WCDMA1900

Frequency (MHz)	Conducted power(dBm)		Peak-Average Ratio(PAR)
	Peak	Average	
1852.4	25.74	21.63	4.11
1880.0	25.65	21.56	4.09
1907.6	25.69	21.68	4.01

PCS1900

Frequency (MHz)	Conducted power(dBm)		Peak-Average Ratio(PAR)
	Peak	Average	
1850.2	29.79	29.72	0.07
1880.0	29.78	29.75	0.03
1909.8	29.76	29.71	0.05

Test Report	14050063-FCC-R1
Page	20 of 53

---

## 6.4 Modulation Characteristic

According to FCC § 2.1047(d), Part 22H & 24E there is no specific requirement for digital modulation, therefore modulation characteristic is not presented.

## 6.5 Occupied Bandwidth

Temperature	25°C
Relative Humidity	55%
Atmospheric Pressure	1006mbar
Test date :	November 06, 2014
Tested By :	David Huang

### Requirement(s):

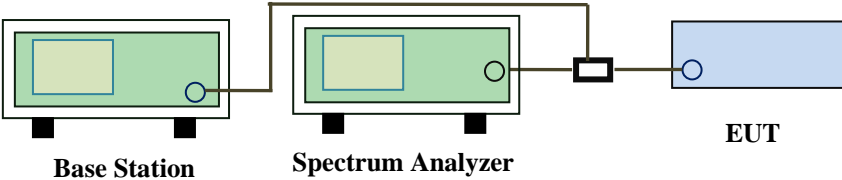
Spec	Item	Requirement	Applicable
§2.1049, §22.917, §22.905 §24.238	a)	99% Occupied Bandwidth(kHz)	<input checked="" type="checkbox"/>
	b)	26 dB Bandwidth(kHz)	<input checked="" type="checkbox"/>
Test Setup	 <p style="text-align: center;">Base Station      Spectrum Analyzer      EUT</p>		
Test Procedure	<ul style="list-style-type: none"> <li>- The EUT was connected to Spectrum Analyzer and Base Station via power divider.</li> <li>- The 99% and 26 dB occupied bandwidth (BW) of the middle channel for the highest RF powers.</li> </ul>		
Remark			
Result	<input checked="" type="checkbox"/> Pass <input type="checkbox"/> Fail		

Test Data     Yes       N/A

Test Plot     Yes (See below)       N/A

### Cellular Band (Part 22H) result

Channel	Frequency (MHz)	99% Occupied Bandwidth (kHz)	26 dB Bandwidth (kHz)
128	824.2	245.6945	320.440
190	836.6	246.9846	319.579
251	848.8	243.6463	321.025

### PCS Band (Part 24E) result

Channel	Frequency (MHz)	99% Occupied Bandwidth (kHz)	26 dB Bandwidth (kHz)
512	1850.2	246.2790	320.367
661	1880.0	246.1996	319.572
810	1909.8	245.0480	323.085

### UMTS-FDD BandV (Part 22H)

Channel	Frequency (MHz)	99% Occupied Bandwidth (MHz)	26 dB Bandwidth (MHz)
4132	826.4	4.1636	4.693
4175	835.0	4.1433	4.696
4233	846.6	4.1546	4.696

### UMTS-FDD BandII (Part 24E)

Channel	Frequency (MHz)	99% Occupied Bandwidth (MHz)	26 dB Bandwidth (MHz)
9262	1852.4	4.1653	4.691
9400	1880.0	4.1600	4.712
9538	1907.6	4.1700	4.689

### Test Plots

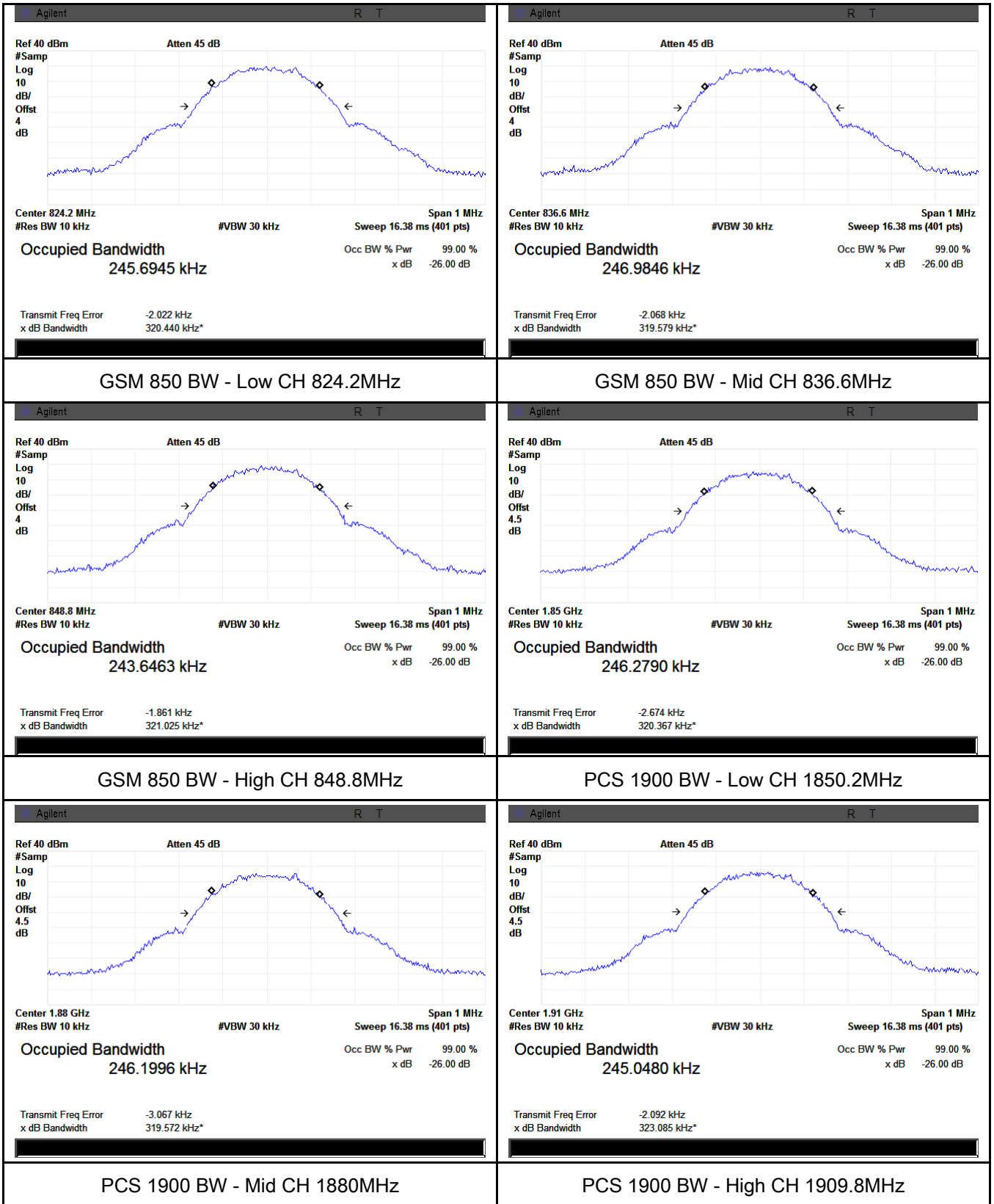

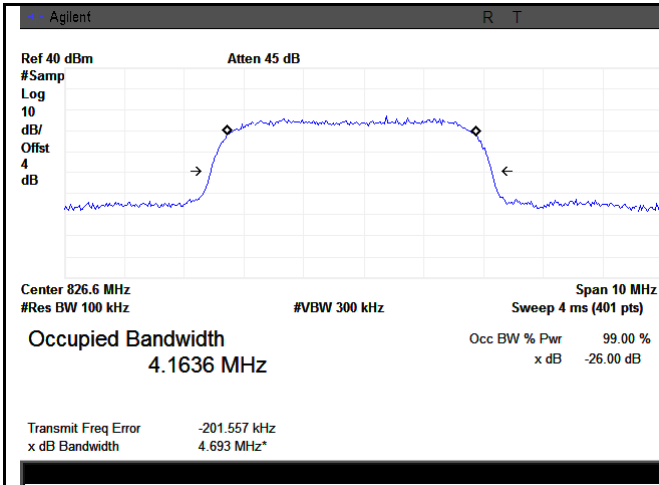

Band V BW - Low CH 826.6 MHz

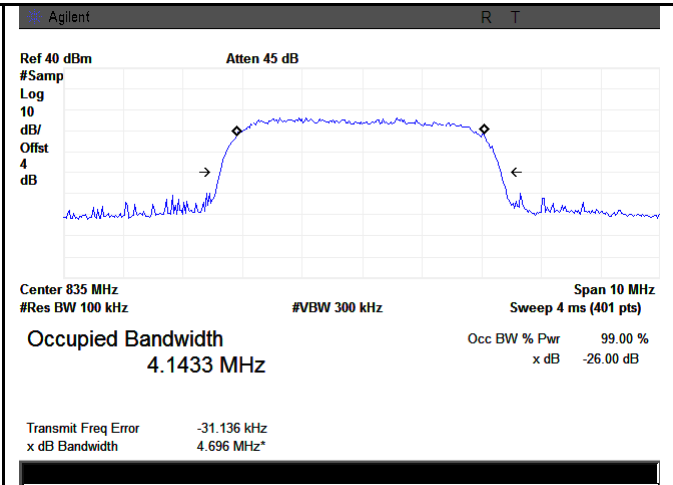

Band V BW - Mid CH 835.0 MHz

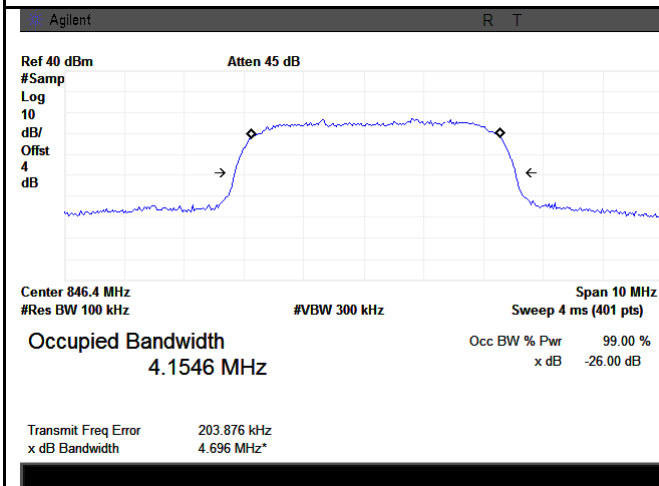

Band V BW - High CH 846.4 MHz

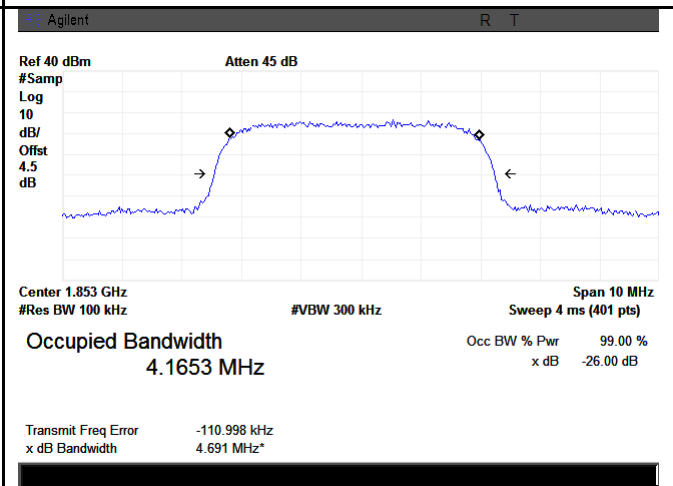

Band II BW - Low CH 1852.4MHz

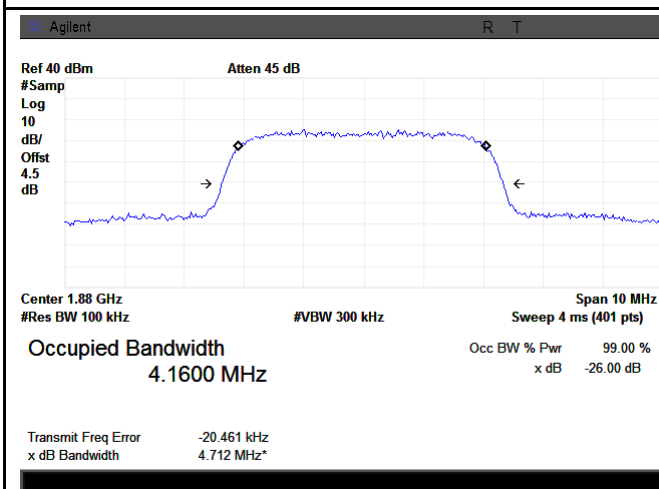

Band II BW - Mid CH 1880MHz

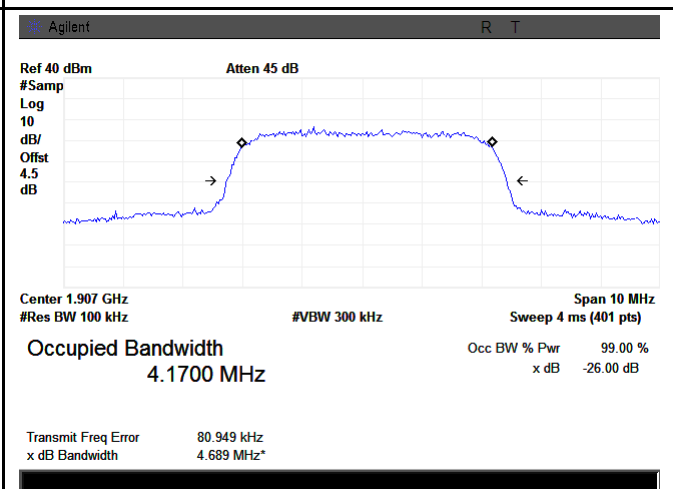

Band II BW - High CH 1907.6MHz



## 6.6 Spurious Emissions at Antenna Terminals

Temperature	26°C
Relative Humidity	56%
Atmospheric Pressure	1007mbar
Test date :	November 07, 2014
Tested By :	David Huang

### Requirement(s):

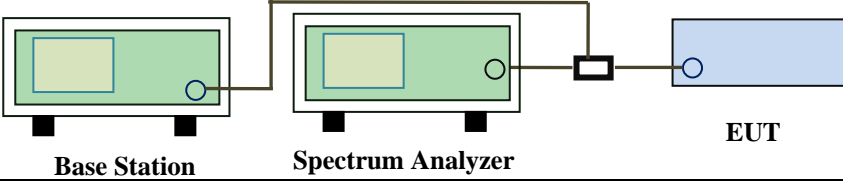
Spec	Item	Requirement	Applicable
§2.1051, §22.917(a)& §24.238(a)	a)	The power of any emission outside of the authorized operating frequency ranges must be lower than the transmitter power (P) by a factor of at least $43 + 10 \log (P)$ dB	<input checked="" type="checkbox"/>
Test Setup	 <p style="text-align: center;">Base Station      Spectrum Analyzer      EUT</p>		
Test Procedure	<ul style="list-style-type: none"> <li>- The EUT was connected to Spectrum Analyzer and Base Station via power divider.</li> <li>- The Band Edges of low and high channels for the highest RF powers were measured.</li> <li>- Setting RBW as roughly BW/100.</li> </ul>		
Remark			
Result	<input checked="" type="checkbox"/> Pass <input type="checkbox"/> Fail		

Test Data     Yes       N/A  
 Test Plot     Yes (See below)       N/A

**Test Plots**

**Cellular Band (Part 22H) result**

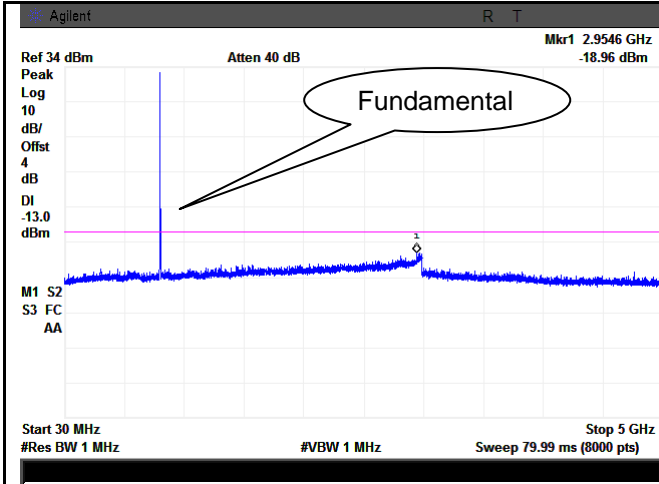

GSM 850 - Low Channel-1

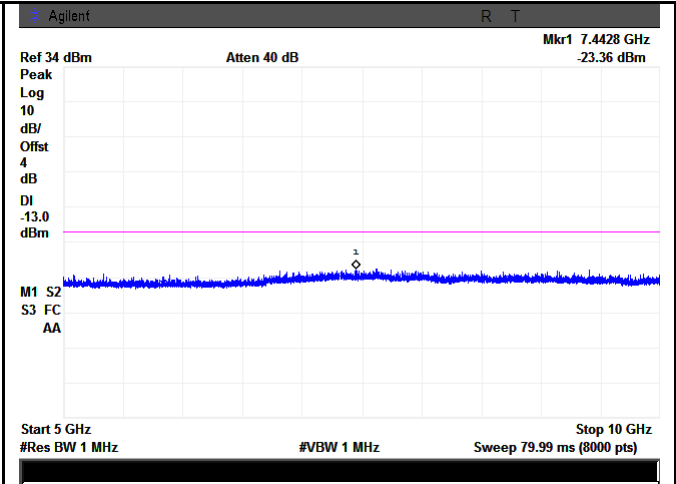

GSM 850 - Low Channel-2

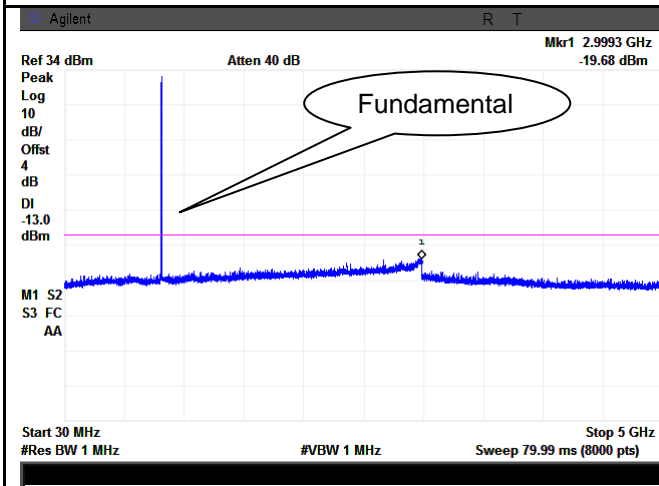

GSM 850 Middle Channel-1

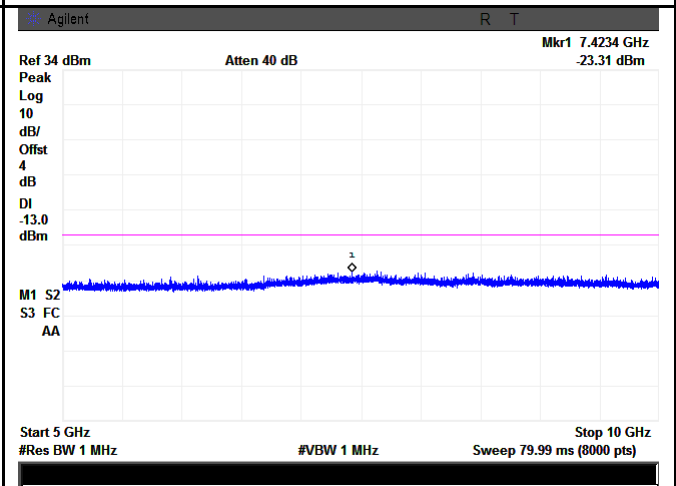

GSM 85 Middle Channel-2

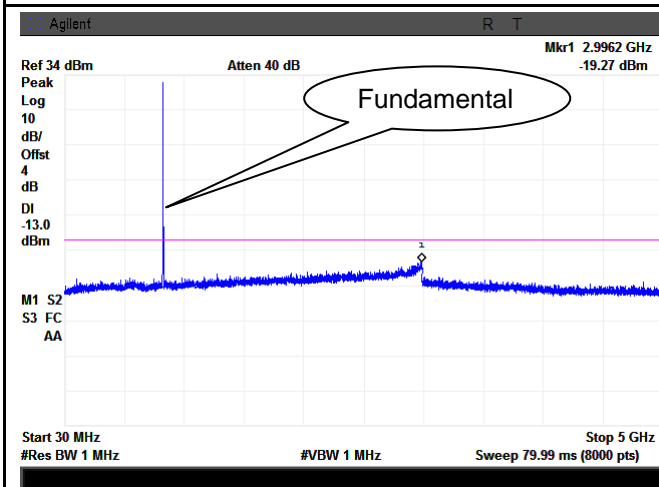

GSM 850 - High Channel-1

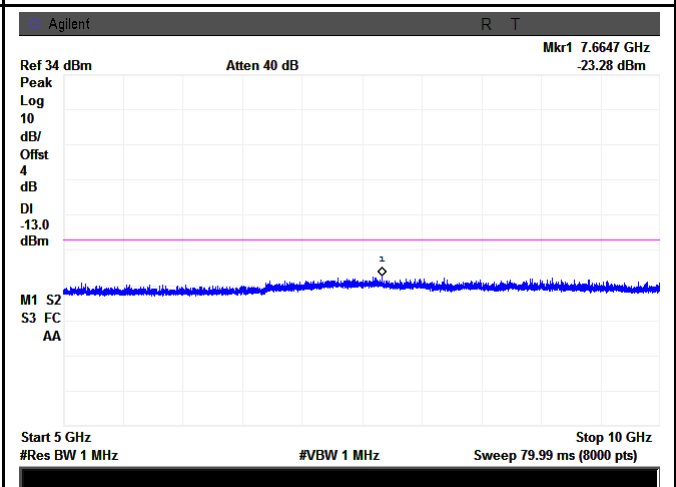

GSM 850 - High Channel-2

**PCS Band (Part24E) result**

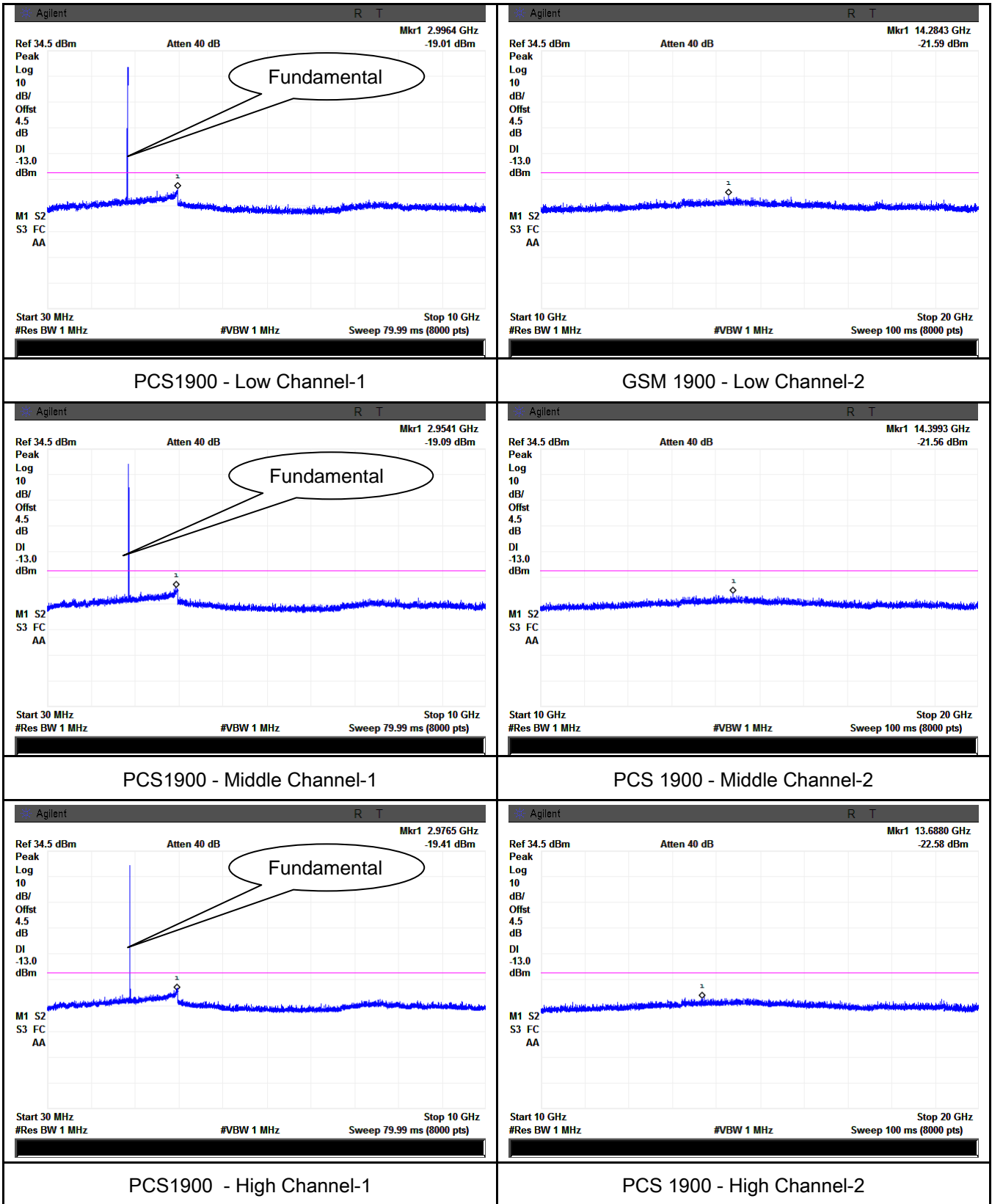

**UMTS-FDD BandV (Part 22H)**

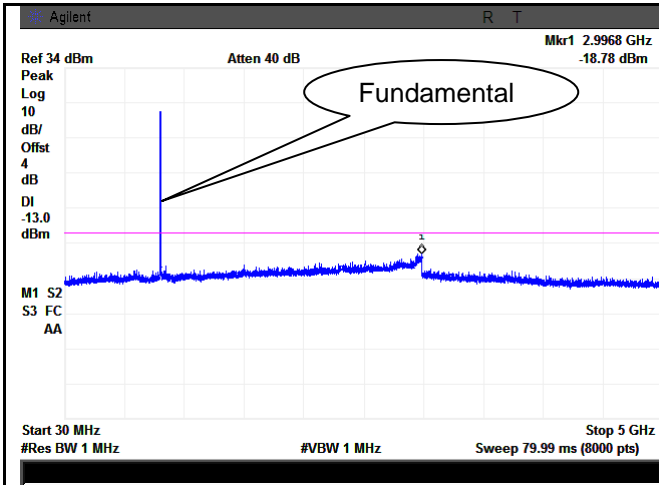

Band V - Low Channel-1

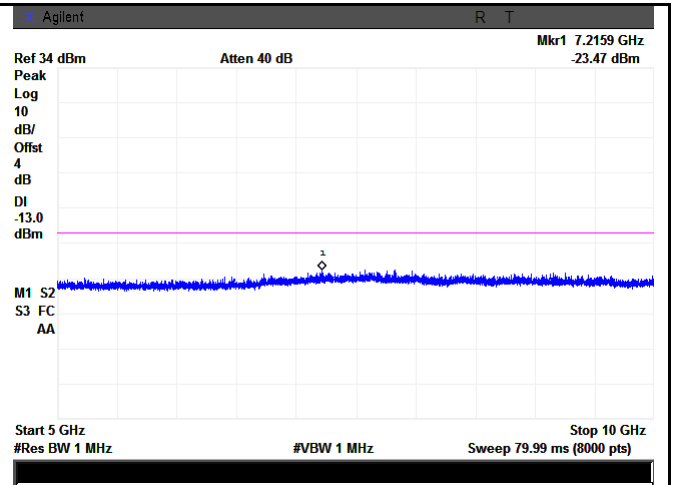

Band V - Low Channel-2

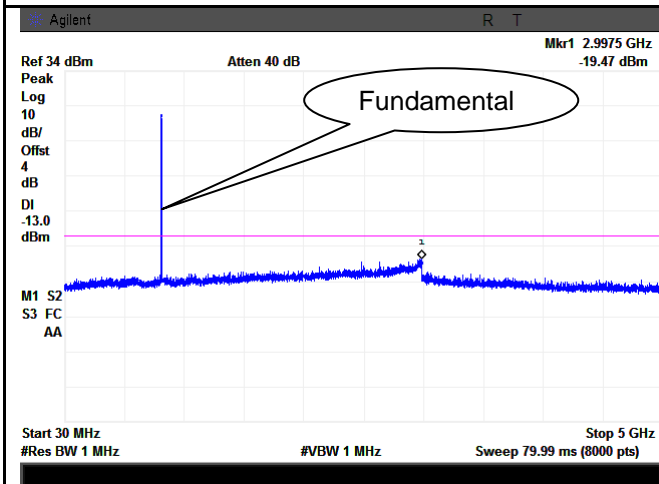

Band V - Middle Channel-1

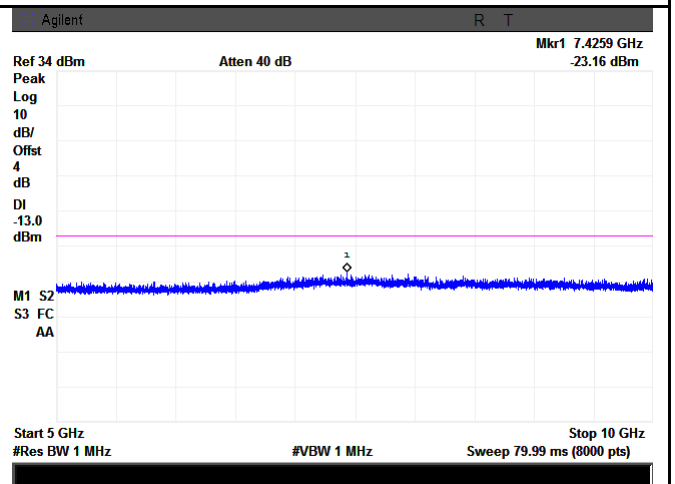

Band V - Middle Channel-2

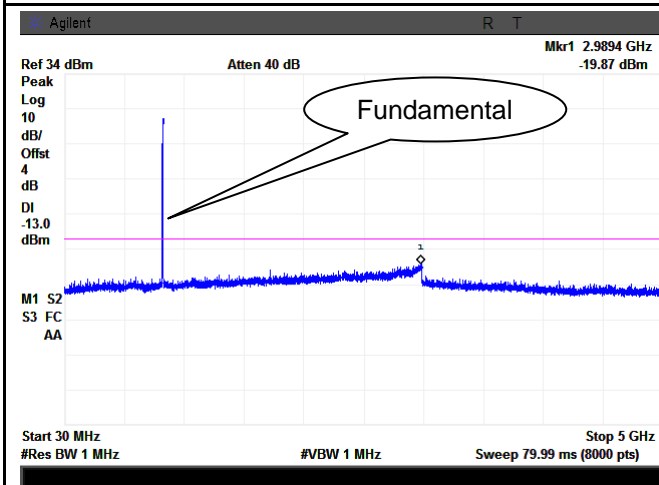

Band V - High Channel-1

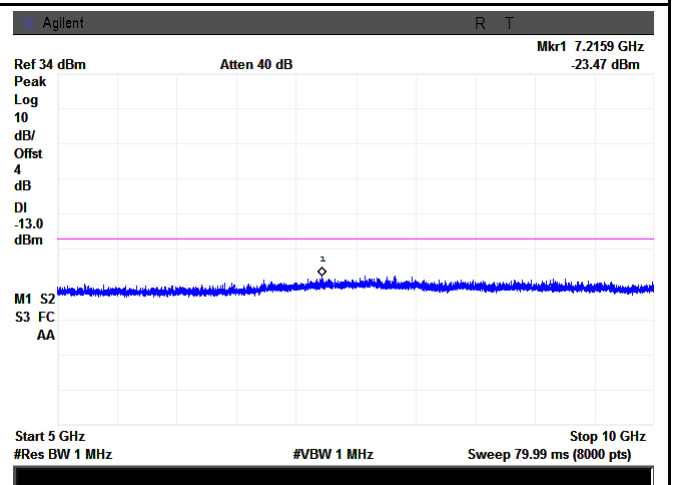

Band V - High Channel-2

**UMTS-FDD BandII (Part 24E)**

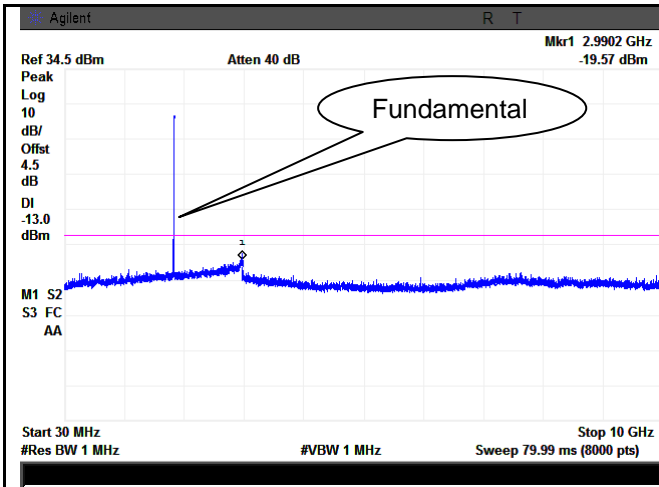

Band II - Low Channel-1

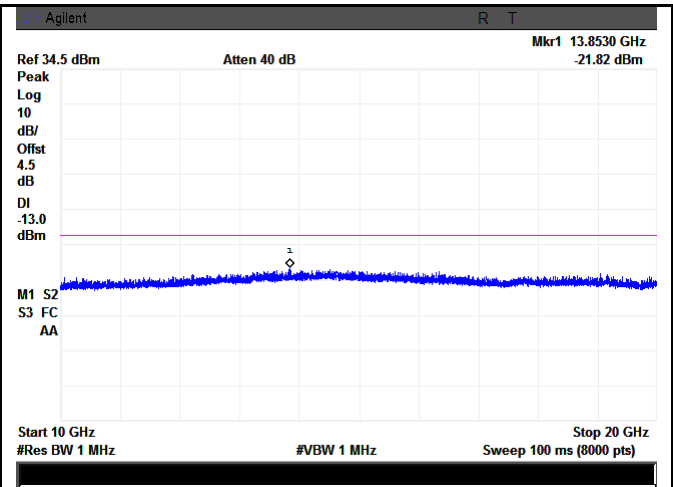

Band II - Low Channel-2

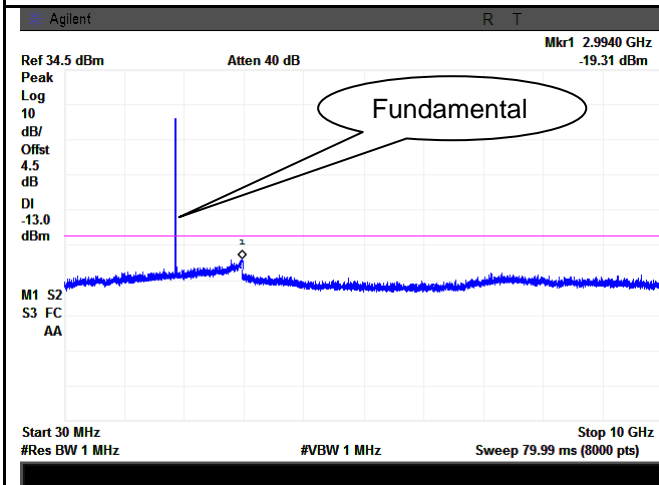

Band II - Middle Channel-1

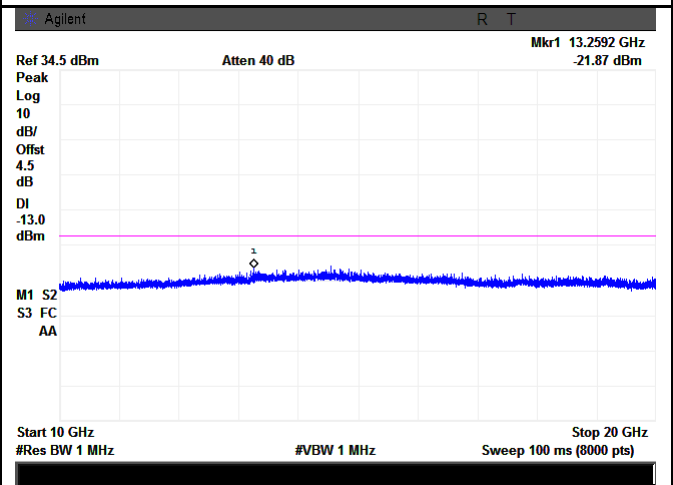

Band II - Middle Channel-2

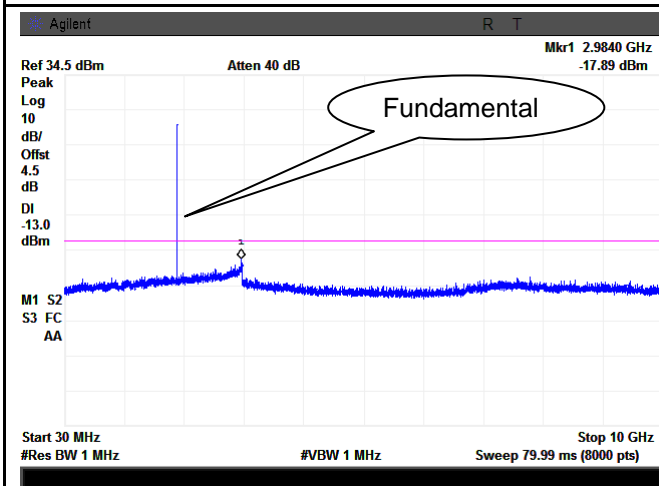

Band II - High Channel-1

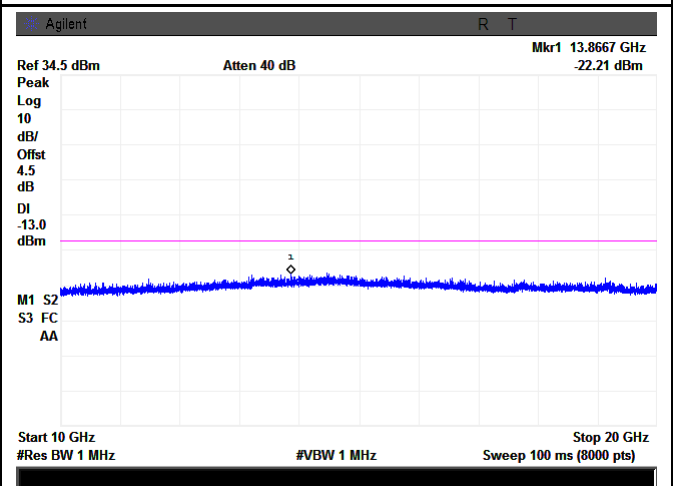

Band II - High Channel-2

## 6.7 Spurious Radiated Emissions

Temperature	25°C
Relative Humidity	55%
Atmospheric Pressure	1006mbar
Test date :	November 06, 2014
Tested By :	David Huang

### Requirement(s):

Spec	Item	Requirement	Applicable
§2.1053, §22.917 & §24.238	a)	The power of any emission outside of the authorized operating frequency ranges must be attenuated below the transmitter power (P) by a factor of at least $43 + 10 \log (P)$ dB. The spectrum is scanned from 30 MHz up to a frequency including its 10th harmonic.	<input checked="" type="checkbox"/>
Test setup			
Test Procedure	<ul style="list-style-type: none"> <li>- Equipment was setup in a semi-anechoic chamber. For measurements above 1 GHz an average measurement was taken with a 10Hz video bandwidth. The EUT was tested at low, mid and high with the highest output power. An emission was scan up to 10th harmonic of the operating frequency.</li> <li>- Sample Calculation: EUT Field Strength = Raw Amplitude (dBµV/m) – Amplifier Gain (dB) + Antenna Factor (dB) + Cable Loss (dB) + Filter Attenuation (dB, if used)</li> </ul>		
Remark			
Result	<input checked="" type="checkbox"/> Pass <input type="checkbox"/> Fail		

Test Data     Yes       N/A

Test Plot     Yes (See below)       N/A

## Cellular Band (Part 22H) result

### Low channel

Frequency (MHz)	Substituted level (dBm)	Polarity (H/V)	Antenna Gain Correction (dB)	Cable Loss (dB)	Corrected Reading (dBm)	Limit (dBm)	Margin (dB)
1648.4	-43.59	V	7.95	0.78	-36.42	-13	-23.42
1648.4	-45.02	H	7.95	0.78	-37.85	-13	-24.85
302.5	-54.41	V	5.7	0.24	-48.95	-13	-35.95
552.7	-50.82	H	6.6	0.39	-44.61	-13	-31.61

### Middle channel

Frequency (MHz)	Substituted level (dBm)	Polarity (H/V)	Antenna Gain Correction (dB)	Cable Loss (dB)	Corrected Reading (dBm)	Limit (dBm)	Margin (dB)
1673.2	-43.62	V	7.95	0.78	-36.45	-13	-23.45
1673.2	-45.11	H	7.95	0.78	-37.94	-13	-24.94
303.2	-54.38	V	6	0.24	-48.62	-13	-35.62
551.5	-51.01	H	6.5	0.39	-44.9	-13	-31.90

### High channel

Frequency (MHz)	Substituted level (dBm)	Polarity (H/V)	Antenna Gain Correction (dB)	Cable Loss (dB)	Corrected Reading (dBm)	Limit (dBm)	Margin (dB)
1697.6	-43.72	V	7.95	0.78	-36.55	-13	-23.55
1697.6	-45.19	H	7.95	0.78	-38.02	-13	-25.02
302.1	-55.13	V	5.7	0.24	-49.67	-13	-36.67
550.9	-50.44	H	6.6	0.39	-44.23	-13	-31.23

## PCS Band (Part24E) result

### Low channel

Frequency (MHz)	Substituted level (dBm)	Polarity (H/V)	Antenna Gain Correction (dB)	Cable Loss (dB)	Corrected Reading (dBm)	Limit (dBm)	Margin (dB)
3700.4	-47.41	V	10.25	2.73	-39.89	-13	-26.89
3700.4	-47.82	H	10.25	2.73	-40.30	-13	-27.30
302.9	-55.46	V	6	0.24	-49.70	-13	-36.70
551.8	-51.29	H	6.60	0.39	-45.08	-13	-32.08

### Middle channel

Frequency (MHz)	Substituted level (dBm)	Polarity (H/V)	Antenna Gain Correction (dB)	Cable Loss (dB)	Corrected Reading (dBm)	Limit (dBm)	Margin (dB)
3760	-47.76	V	10.25	2.73	-40.24	-13	-27.24
3760	-47.55	H	10.25	2.73	-40.03	-13	-27.03
303.5	-55.37	V	5.70	0.24	-49.91	-13	-36.91
551.5	-50.82	H	6.60	0.39	-44.61	-13	-31.61

### High channel

Frequency (MHz)	Substituted level (dBm)	Polarity (H/V)	Antenna Gain Correction (dB)	Cable Loss (dB)	Corrected Reading (dBm)	Limit (dBm)	Margin (dB)
3819.6	-47.26	V	10.36	2.73	-39.63	-13	-26.63
3819.6	-47.71	H	10.36	2.73	-40.08	-13	-27.08
303.3	-55.22	V	5.70	0.24	-49.76	-13	-36.76
551.3	-51.72	H	6.60	0.39	-45.51	-13	-32.51



### UMTS-FDD Band V (Part 22H)

#### Low channel

Frequency (MHz)	Substituted level (dBm)	Polarity (H/V)	Antenna Gain Correction (dB)	Cable Loss (dB)	Corrected Reading (dBm)	Limit (dBm)	Margin (dB)
1652.8	-43.88	V	7.95	0.78	-36.71	-13	-23.71
1652.8	-46.72	H	7.95	0.78	-39.55	-13	-26.55
303.7	-56.16	V	5.70	0.24	-50.70	-13	-37.70
551.6	-50.73	H	6.50	0.39	-44.62	-13	-31.62

#### Middle channel

Frequency (MHz)	Substituted level (dBm)	Polarity (H/V)	Antenna Gain Correction (dB)	Cable Loss (dB)	Corrected Reading (dBm)	Limit (dBm)	Margin (dB)
1670	-43.73	V	7.95	0.78	-36.56	-13	-23.56
1670	-46.79	H	7.95	0.78	-39.62	-13	-26.62
302.9	-55.29	V	5.70	0.24	-49.83	-13	-36.83
550.8	-50.64	H	6.60	0.39	-44.43	-13	-31.43

#### High channel

Frequency (MHz)	Substituted level (dBm)	Polarity (H/V)	Antenna Gain Correction (dB)	Cable Loss (dB)	Corrected Reading (dBm)	Limit (dBm)	Margin (dB)
1693.2	-43.68	V	7.95	0.78	-36.51	-13	-23.51
1693.2	-46.55	H	7.95	0.78	-39.38	-13	-26.38
303.4	-55.27	V	5.70	0.24	-49.81	-13	-36.81
552.6	-51.09	H	6.60	0.39	-44.88	-13	-31.88

### UMTS-FDD BandII (Part 24E)

#### Low channel

Frequency (MHz)	Substituted level (dBm)	Polarity (H/V)	Antenna Gain Correction (dB)	Cable Loss (dB)	Corrected Reading (dBm)	Limit (dBm)	Margin (dB)
3704.8	-46.73	V	10.25	2.73	-39.21	-13	-26.21
3704.8	-47.25	H	10.25	2.73	-39.73	-13	-26.73
302.8	-56.19	V	5.70	0.24	-50.73	-13	-37.73
551.3	-51.22	H	6.60	0.38	-45	-13	-32

#### Middle channel

Frequency (MHz)	Substituted level (dBm)	Polarity (H/V)	Antenna Gain Correction (dB)	Cable Loss (dB)	Corrected Reading (dBm)	Limit (dBm)	Margin (dB)
3760	-46.69	V	10.25	2.73	-39.17	-13	-26.17
3760	-47.11	H	10.25	2.73	-39.59	-13	-26.59
303.4	-55.82	V	5.70	0.24	-50.36	-13	-37.36
551.7	-51.26	H	6.60	0.39	-45.05	-13	-32.05

#### High channel

Frequency (MHz)	Substituted level (dBm)	Polarity (H/V)	Antenna Gain Correction (dB)	Cable Loss (dB)	Corrected Reading (dBm)	Limit (dBm)	Margin (dB)
3815.2	-46.62	V	10.36	2.73	-38.99	-13	-25.99
3815.2	-47.08	H	10.36	2.73	-39.45	-13	-26.45
302.6	-56.13	V	5.70	0.24	-50.67	-13	-37.67
553.6	-50.83	H	6.60	0.39	-44.62	-13	-31.62

## 6.8 Band Edge

Temperature	22°C
Relative Humidity	50%
Atmospheric Pressure	1011mbar
Test date :	November 10, 2014
Tested By :	David Huang

### Requirement(s):

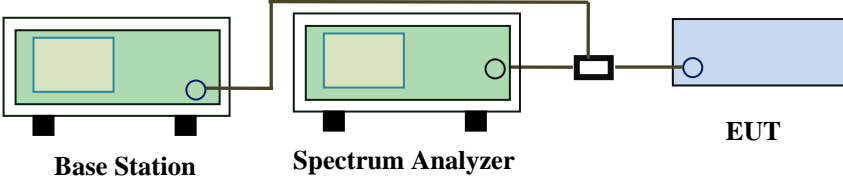
Spec	Item	Requirement	Applicable
§22.917(a) & §24.238(a)	a)	The power of any emission outside of the authorized operating frequency ranges must be lower than the transmitter power (P) by a factor of at least $43 + 10 \log (P)$ dB.	<input checked="" type="checkbox"/>
Test setup	 <p>The diagram shows a Base Station (green box) connected to a Spectrum Analyzer (green box) and an EUT (blue box) via a power divider. The Base Station and Spectrum Analyzer are connected to each other, and the Spectrum Analyzer is connected to the power divider, which then splits the signal to the EUT.</p>		
Procedure	<ul style="list-style-type: none"> <li>- The EUT was connected to Spectrum Analyzer and Base Station via power divider.</li> <li>- The Band Edges of low and high channels for the highest RF powers were measured. Setting RBW as roughly BW/100.</li> </ul>		
Remark			
Result	<input checked="" type="checkbox"/> Pass <input type="checkbox"/> Fail		

Test Data  Yes       N/A

Test Plot  Yes (See below)       N/A

### Cellular Band (Part 22H) result

Frequency (MHz)	Emission (dBm)	Limit (dBm)
823.9775	-13.48	-13
849.0200	-14.36	-13

### PCS Band (Part24E) result

Frequency (MHz)	Emission (dBm)	Limit (dBm)
1850.0000	-15.82	-13
1910.0200	-15.96	-13

### UMTS-FDD Band V (Part 22H)

Frequency (MHz)	Emission (dBm)	Limit (dBm)
823.9775	-23.83	-13
849.0200	-23.76	-13

### UMTS-FDD Band II (Part 24E)

Frequency (MHz)	Emission (dBm)	Limit (dBm)
1850.0000	-28.11	-13
1910.0200	-29.44	-13

**Test Plots**

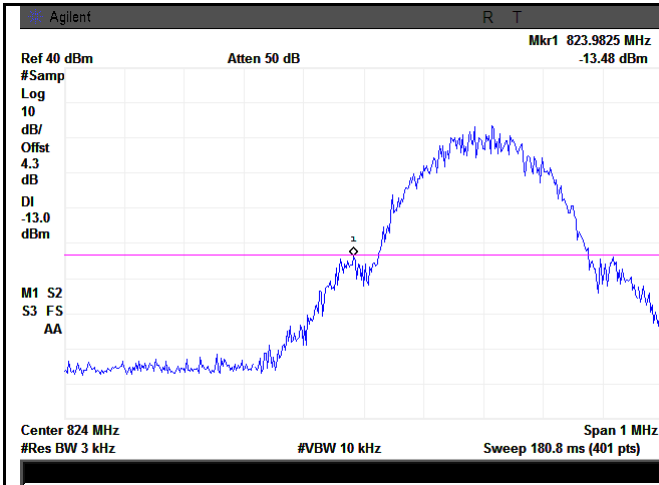

Cellular Band - Low Channel

Note: Offset=Cable loss (4.0) + 10log  
 (3.20/3)=4.0+0.3=4.3 dB

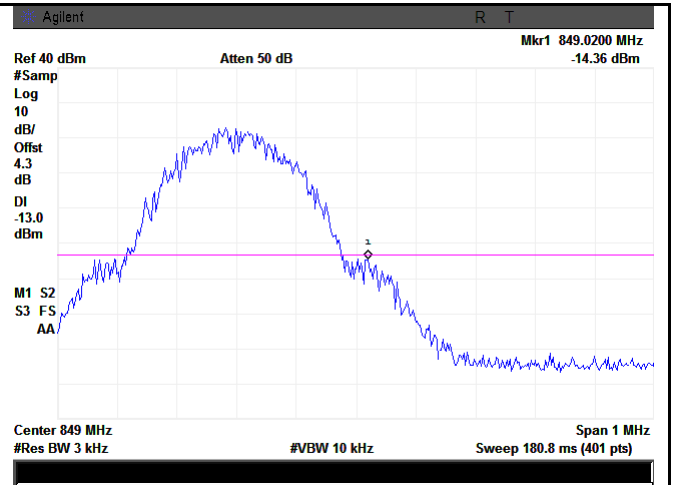

Cellular Band - High Channel

Note: Offset=Cable loss (4.0) + 10log  
 (3.21/3)=4.0+0.3=4.3 dB

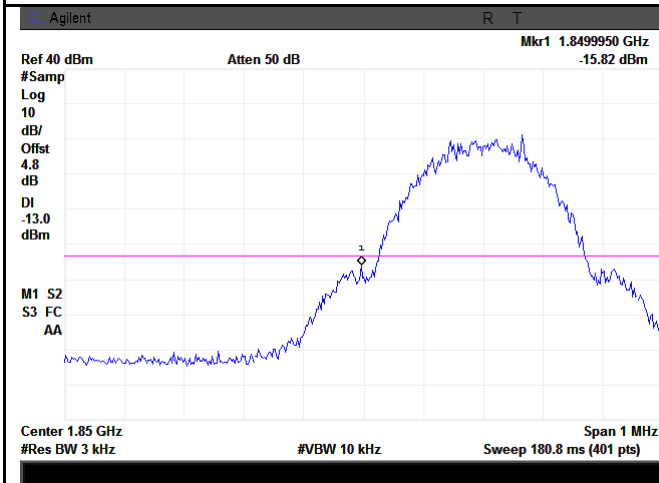

PCS Band - Low Channel

Note: Offset=Cable loss (4.5) + 10log  
 (3.20/3)=4.5+0.3=4.8 dB

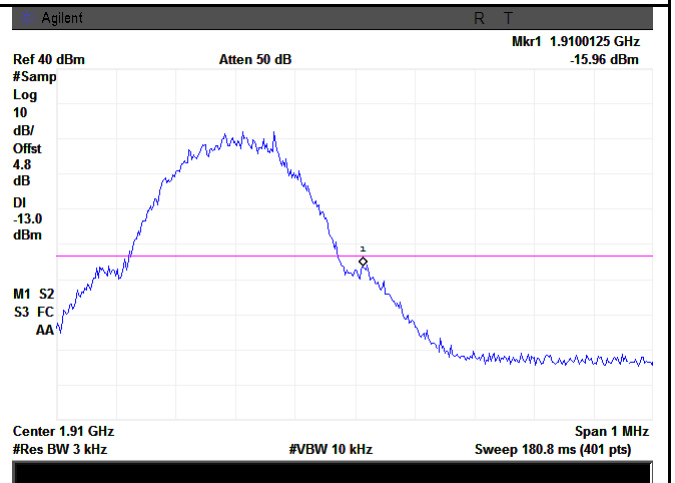

PCS Band - High Channel

Note: Offset=Cable loss (4.5) + 10log  
 (3.23/3)=4.5+0.3=4.8 dB

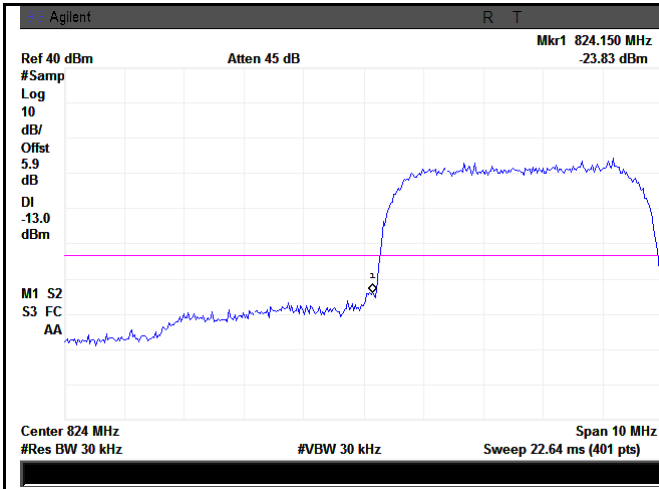

UMTS-FDD Band V - Low Channel

Note: Offset=Cable loss (4.0) + 10log  
 (46.93/30)=4.0+1.9=5.9 dB

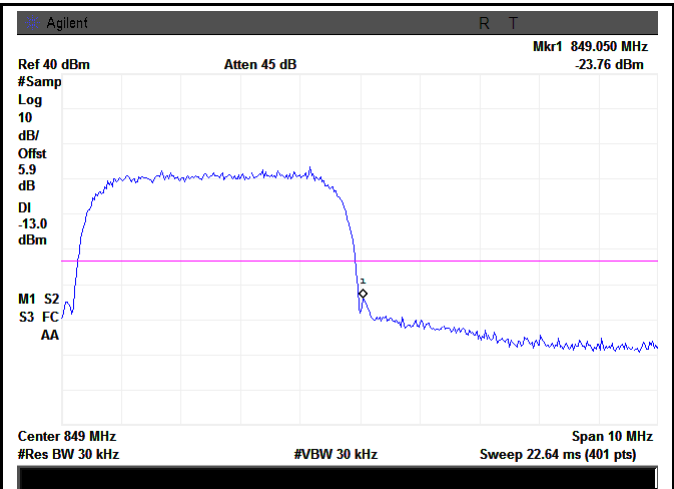

UMTS-FDD Band V - High Channel

Note: Offset=Cable loss (4.0) + 10log  
 (46.96/30)=4.0+1.9=5.9 dB

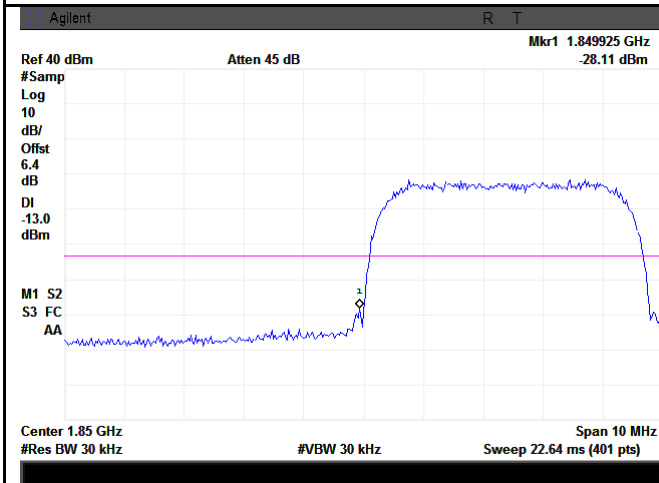

UMTS-FDD Band II - Low Channel

Note: Offset=Cable loss (4.5) + 10log  
 (46.91/30)=4.5+1.9=6.4 dB

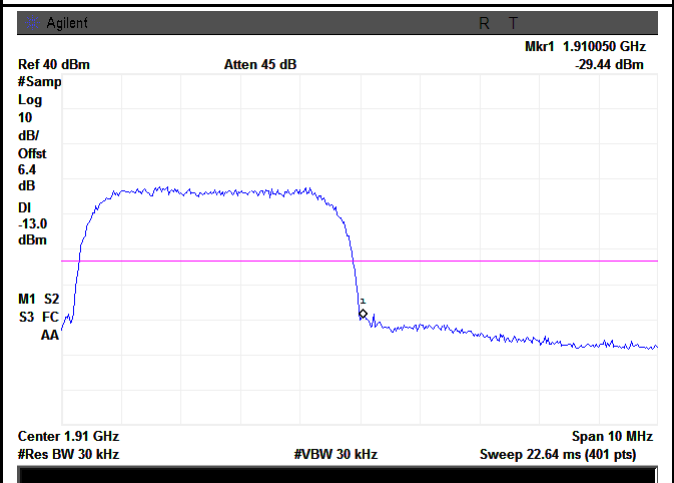

UMTS-FDD Band II - High Channel

Note: Offset=Cable loss (4.5) + 10log  
 (46.97/30)=4.5+1.9=6.4 dB

## 6.9 Frequency Stability

Temperature	22°C
Relative Humidity	50%
Atmospheric Pressure	1011mbar
Test date :	November 10, 2014
Tested By :	David Huang

### Requirement(s):

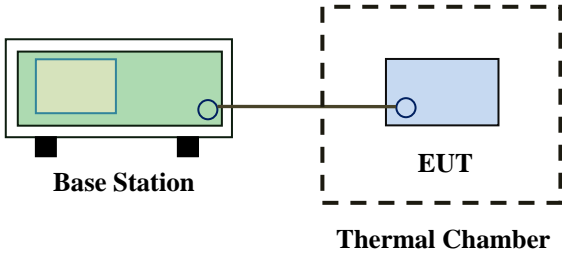
Spec	Item	Requirement	Applicable																																
§2.1055, §22.355 & §24.235	a)	<p>According to §22.355, the carrier frequency of each transmitter in the Public Mobile Services must be maintained within the tolerances given in Table below:</p> <p>Frequency Tolerance for Transmitters in the Public Mobile Services</p> <table border="1"> <thead> <tr> <th>Frequency Range (MHz)</th> <th>Base, fixed (ppm)</th> <th>Mobile ≤ 3 watts (ppm)</th> <th>Mobile ≤ 3 watts (ppm)</th> </tr> </thead> <tbody> <tr> <td>25 to 50</td> <td>20.0</td> <td>20.0</td> <td>50.0</td> </tr> <tr> <td>50 to 450</td> <td>5.0</td> <td>5.0</td> <td>50.0</td> </tr> <tr> <td>450 to 512</td> <td>2.5</td> <td>5.0</td> <td>5.0</td> </tr> <tr> <td>821 to 896</td> <td>1.5</td> <td>2.5</td> <td>2.5</td> </tr> <tr> <td>928 to 929.</td> <td>5.0</td> <td>N/A</td> <td>N/A</td> </tr> <tr> <td>929 to 960.</td> <td>1.5</td> <td>N/A</td> <td>N/A</td> </tr> <tr> <td>2110 to 2220</td> <td>10.0</td> <td>N/A</td> <td>N/A</td> </tr> </tbody> </table> <p>According to §24.235, the frequency stability shall be sufficient to ensure that the fundamental emissions stay within the authorized frequency block.</p>	Frequency Range (MHz)	Base, fixed (ppm)	Mobile ≤ 3 watts (ppm)	Mobile ≤ 3 watts (ppm)	25 to 50	20.0	20.0	50.0	50 to 450	5.0	5.0	50.0	450 to 512	2.5	5.0	5.0	821 to 896	1.5	2.5	2.5	928 to 929.	5.0	N/A	N/A	929 to 960.	1.5	N/A	N/A	2110 to 2220	10.0	N/A	N/A	<input checked="" type="checkbox"/>
		Frequency Range (MHz)	Base, fixed (ppm)	Mobile ≤ 3 watts (ppm)	Mobile ≤ 3 watts (ppm)																														
		25 to 50	20.0	20.0	50.0																														
		50 to 450	5.0	5.0	50.0																														
		450 to 512	2.5	5.0	5.0																														
		821 to 896	1.5	2.5	2.5																														
		928 to 929.	5.0	N/A	N/A																														
		929 to 960.	1.5	N/A	N/A																														
2110 to 2220	10.0	N/A	N/A																																
Test setup	 <p>The diagram illustrates the test setup. On the left, a green rectangular box represents the 'Base Station'. A line connects it to a blue rectangular box labeled 'EUT' (Equipment Under Test), which is enclosed within a dashed-line box representing the 'Thermal Chamber'.</p>																																		

Test Report	14050063-FCC-R1
Page	40 of 53

Procedure	A communication link was established between EUT and base station. The frequency error was monitored and measured by base station under variation of ambient temperature and variation of primary supply voltage.  Limit: The frequency stability of the transmitter shall be maintained within $\pm 0.00025\%$ ( $\pm 2.5\text{ppm}$ ) of the center frequency.
Remark	
Result	<input checked="" type="checkbox"/> Pass <input type="checkbox"/> Fail

Test Data     Yes                       N/A

Test Plot     Yes (See below)             N/A



### Cellular Band (Part 22H) result

Middle Channel, $f_0 = 836.6$ MHz				
Temperature (°C)	Power Supplied (V <sub>DC</sub> )	Frequency Error (Hz)	Frequency Error (ppm)	Limit (ppm)
-10	3.7	22	0.0263	2.5
0		19	0.0227	2.5
10		17	0.0203	2.5
20		15	0.0179	2.5
30		18	0.0215	2.5
40		20	0.0239	2.5
50		28	0.0335	2.5
55		33	0.0394	2.5
25	4.2	21	0.0251	2.5
	3.5	24	0.0287	2.5

### PCS Band (Part 24E) result

Middle Channel, $f_0 = 1880$ MHz				
Temperature (°C)	Power Supplied (V <sub>DC</sub> )	Frequency Error (Hz)	Frequency Error (ppm)	Limit (ppm)
-10	3.7	30	0.0160	2.5
0		21	0.0112	2.5
10		19	0.0101	2.5
20		16	0.0085	2.5
30		19	0.0101	2.5
40		21	0.0112	2.5
50		24	0.0128	2.5
55		27	0.0144	2.5
25	4.2	22	0.0117	2.5
	3.5	26	0.0138	2.5

### UMTS-FDD BandV (Part 22H)

Middle Channel, $f_0 = 835$ MHz				
Temperature (°C)	Power Supplied (V <sub>DC</sub> )	Frequency Error (Hz)	Frequency Error (ppm)	Limit (ppm)
-10	3.7	15	0.0180	2.5
0		12	0.0144	2.5
10		11	0.0132	2.5
20		10	0.0120	2.5
30		13	0.0156	2.5
40		16	0.0192	2.5
50		20	0.0240	2.5
55		23	0.0275	2.5
25	4.2	19	0.0228	2.5
	3.5	16	0.0192	2.5

### UMTS-FDD BandII (Part 24E)

Middle Channel, $f_0 = 1880$ MHz				
Temperature (°C)	Power Supplied (V <sub>DC</sub> )	Frequency Error (Hz)	Frequency Error (ppm)	Limit (ppm)
-10	3.7	13	0.0069	2.5
0		12	0.0064	2.5
10		8	0.0043	2.5
20		5	0.0027	2.5
30		9	0.0048	2.5
40		14	0.0074	2.5
50		15	0.0080	2.5
55		19	0.0101	2.5
25	4.2	8	0.0043	2.5
	3.5	12	0.0064	2.5

## Annex A. TEST INSTRUMENT

Instrument	Model	Serial #	Cal Date	Cal Due	In use
<b>RF Conducted Test</b>					
Agilent ESA-E SERIES SPECTRUM ANALYZER	E4407B	MY45108319	09/17/2014	09/16/2015	<input checked="" type="checkbox"/>
Power Splitter	1#	1#	09/02/2014	09/01/2015	<input checked="" type="checkbox"/>
Universal Radio Communication Tester	CMU200	121393	09/26/2014	09/25/2015	<input checked="" type="checkbox"/>
Temperature/Humidity Chamber	UHL-270	001	10/10/2014	10/09/2015	<input checked="" type="checkbox"/>
DC Power Supply	E3640A	MY40004013	09/18/2014	09/17/2015	<input checked="" type="checkbox"/>
<b>Radiated Emissions</b>					
EMI test receiver	ESL6	100262	09/18/2014	09/17/2015	<input checked="" type="checkbox"/>
OPT 010 AMPLIFIER (0.1-1300MHz)	8447E	2727A02430	09/02/2014	09/01/2015	<input checked="" type="checkbox"/>
Microwave Preamplifier (0.5 ~ 18GHz)	PAM-118	443008	09/02/2014	09/01/2015	<input checked="" type="checkbox"/>
Bilog Antenna (30MHz~6GHz)	JB6	A110712	09/22/2014	09/21/2015	<input checked="" type="checkbox"/>
Bilog Antenna (30MHz~2GHz)	JB1	A112017	09/22/2014	09/21/2015	<input checked="" type="checkbox"/>
Double Ridge Horn Antenna (1 ~18GHz)	AH-118	71259	09/25/2014	09/24/2015	<input checked="" type="checkbox"/>
Double Ridge Horn Antenna (1 ~18GHz)	AH-118	71283	09/25/2014	09/24/2015	<input checked="" type="checkbox"/>
SYNTHESIZED SIGNAL GENERATOR	8665B	3744A01293	09/18/2014	09/17/2015	<input checked="" type="checkbox"/>
Tunable Notch Filter	3NF-800/1000-S	AA4	09/02/2014	09/01/2015	<input checked="" type="checkbox"/>
Tunable Notch Filter	3NF-1000/2000-S	AM 4	09/02/2014	09/01/2015	<input checked="" type="checkbox"/>

## Annex B. EUT And Test Setup Photographs

### Annex B.i. Photograph: EUT External Photo





EUT - Top View



EUT - Bottom View

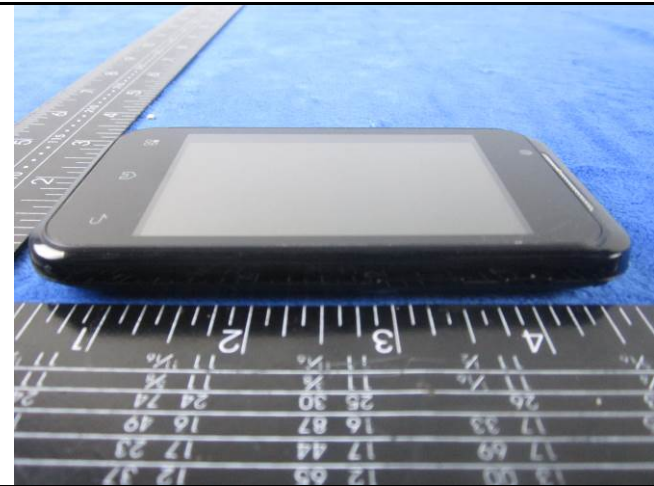

EUT - Left View

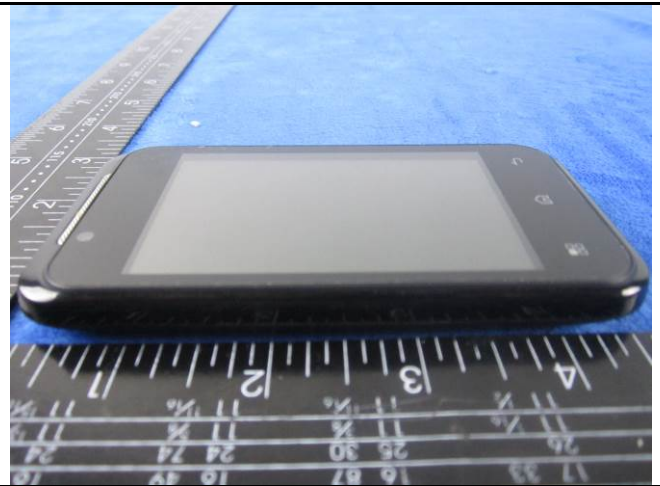

EUT - Right View

**Annex B.ii. Photograph: EUT Internal Photo**



Cover Off - Top View 1



Cover Off - Top View 2

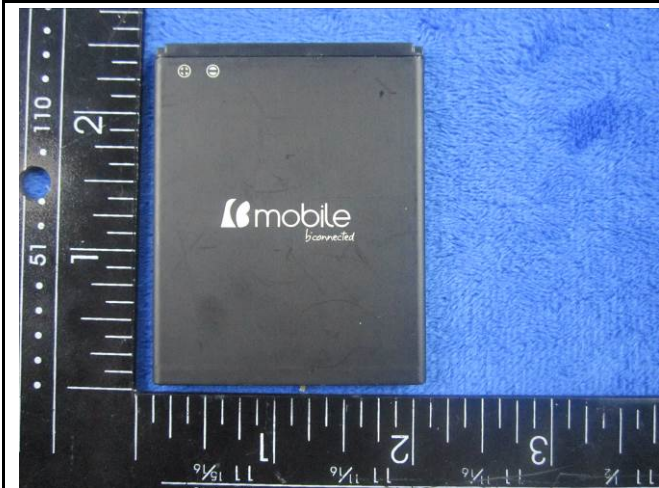

Battery - Top View



Battery - Bottom View

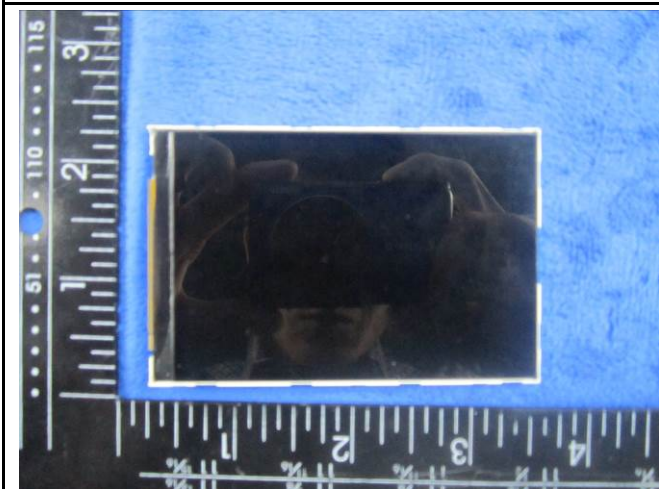

LCD - Front View

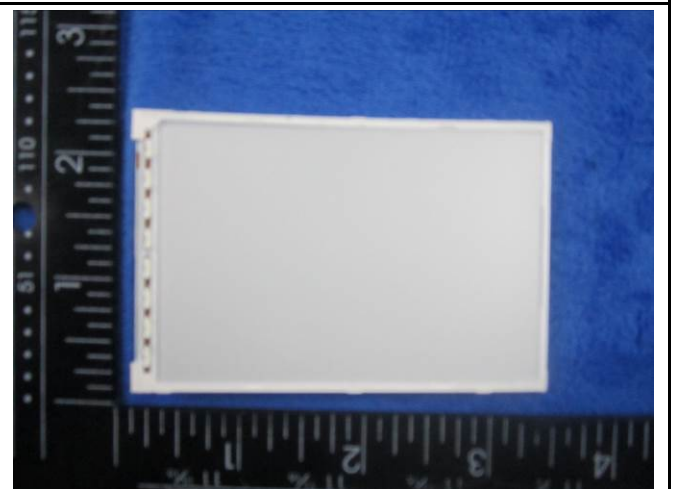

LCD - Rear View

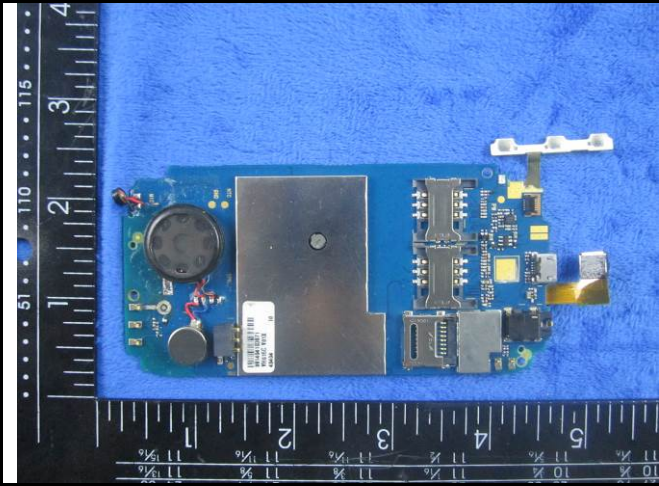

Mainboard With Shielding - Front View

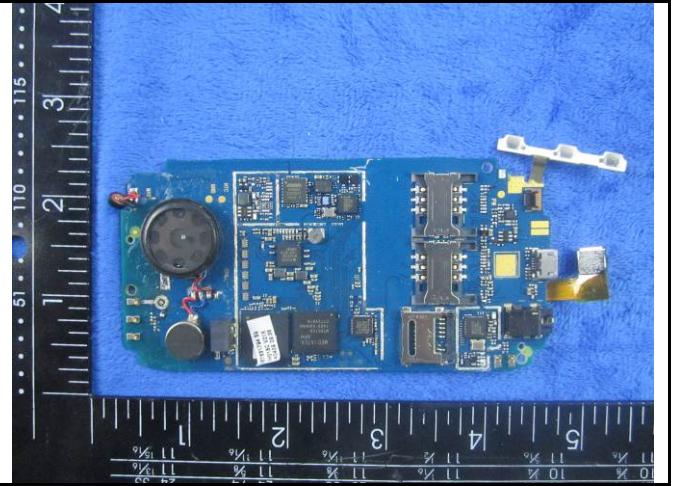

Mainboard Without Shielding - Front View

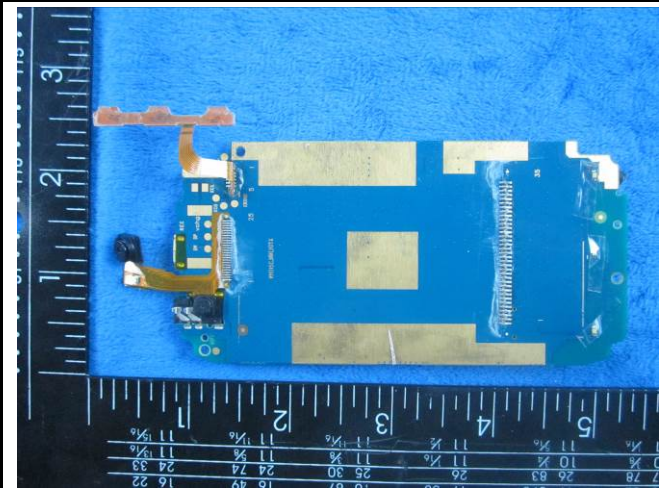

Mainboard With Shielding - Front View



BT/WIFI Antenna View

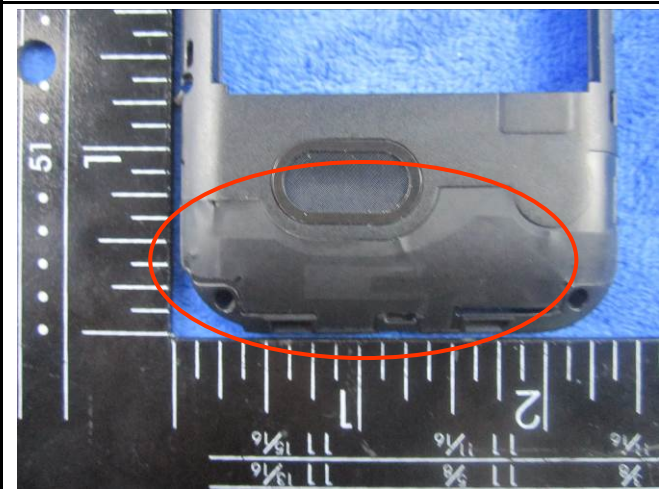

GSM/PCS/UMTS-FDD Antenna View

**Annex B.iii. Photograph: Test Setup Photo**

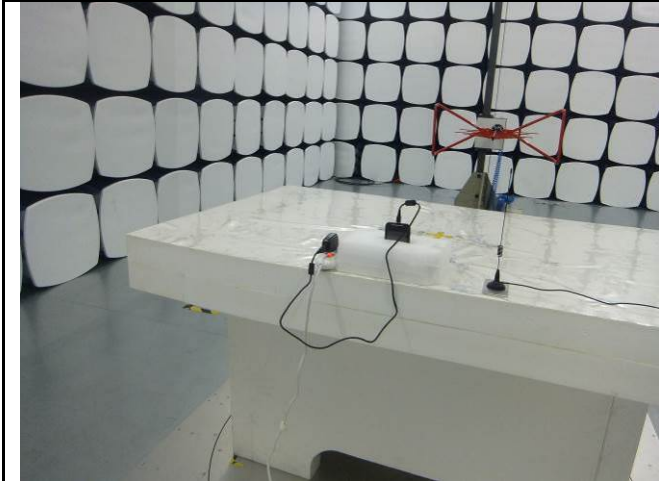

Radiated Spurious Emissions Test Setup Below 1GHz

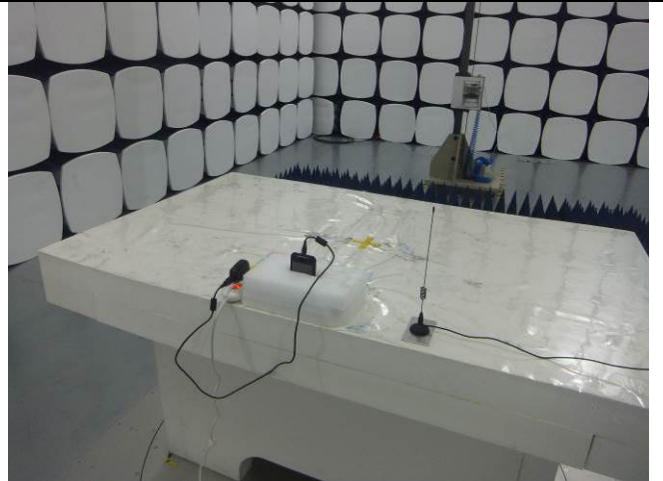

Radiated Spurious Emissions Test Setup Above  
1GHz



## Annex C. TEST SETUP AND SUPPORTING EQUIPMENT

### Annex C.ii. TEST SET UP BLOCK

#### Block Configuration Diagram for Radiated Emissions

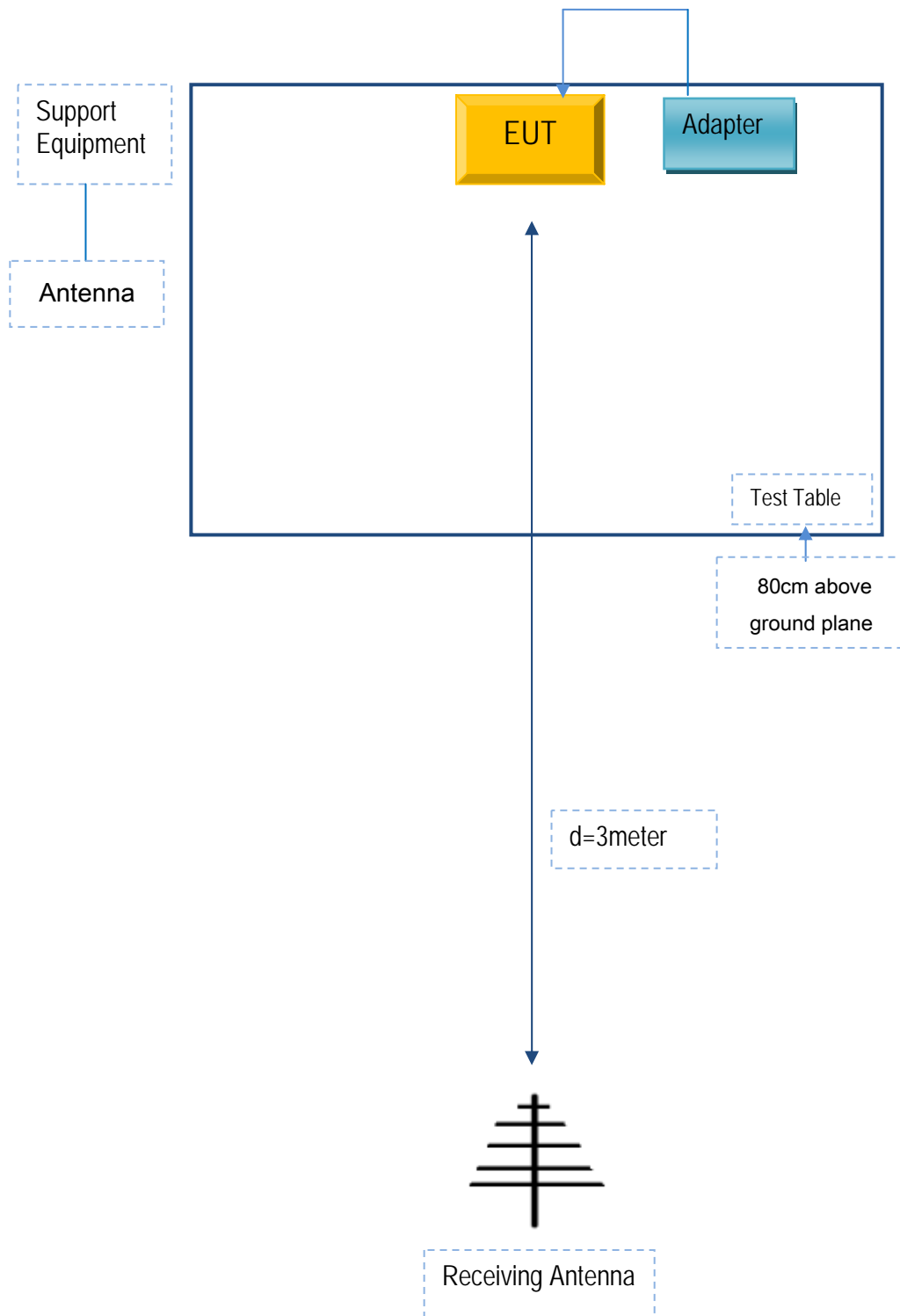

**Annex C. ii. SUPPORTING EQUIPMENT DESCRIPTION**

The following is a description of supporting equipment and details of cables used with the EUT.

Manufacturer	Equipment Description	Model	Calibration Date	Calibration Due Date
N/A	N/A	N/A	N/A	N/A

## Annex C.ii. EUT OPERATING CONKITIONS

The following is the description of how the EUT is exercised during testing.

Test	Description Of Operation
<b>Emissions Testing</b>	The EUT was communicating with base station and set to work at maximum output power.
<b>Others Testing</b>	The EUT was communicating with base station and set to work at maximum output power.

Test Report	14050063-FCC-R1
Page	52 of 53

**Annex D. User Manual / Block Diagram / Schematics / Partlist**

**Please see attachment**

Test Report	14050063-FCC-R1
Page	53 of 53

## Annex E. DECLARATION OF SIMILARITY

N/A