

FCC SAR EVALUATION REPORT

**In accordance with the requirements of
FCC 47 CFR Part 2(2.1093), ANSI/IEEE C95.1-1992 and
IEEE Std 1528-2013**

Product Name : Mobile Phone

Brand Name : Bmobile

Model Name : BL61 PRO

Family Model : N/A

Report No. : S23111603503001

FCC ID : ZSW-30-133

Prepared for

b mobile HK Limited

Flat 18; 14/F Block 1; Golden Industrial Building;16-26 Kwai Tak Street; Kwai Chung;
New Territories; Hong Kong, China

Prepared by

Shenzhen NTEK Testing Technology Co., Ltd.

1/F, Building E, Fenda Science Park, Sanwei Community,
Xixiang Street Bao'an District, Shenzhen 518126 P.R. China

Tel. 400-800-6106, 0755-2320 0050, 0755-2320 0090

Website: <http://www.ntek.org.cn>

TEST RESULT CERTIFICATION

Applicant's name b mobile HK Limited
Address..... Flat 18; 14/F Block 1; Golden Industrial Building;16-26 Kwai Tak Street; Kwai Chung; New Territories; Hong Kong, China
Manufacturer's Name . b mobile HK Limited
Address..... Flat 18; 14/F Block 1; Golden Industrial Building;16-26 Kwai Tak Street; Kwai Chung; New Territories; Hong Kong, China
Product description
 Product name Mobile Phone
 Brand Name Bmobile
 Model and/or type reference BL61 PRO
 Family Model N/A
 FCC 47 CFR Part 2(2.1093)
 ANSI/IEEE C95.1-1992
Standards IEEE Std 1528-2013
 Published RF exposure KDB procedures

This device described above has been tested by Shenzhen NTEK. In accordance with the measurement methods and procedures specified in IEEE Std 1528-2013 and KDB 865664 D01. Testing has shown that this device is capable of compliance with localized specific absorption rate (SAR) specified in FCC 47 CFR Part 2(2.1093) and ANSI/IEEE C95.1-1992. The test results in this report apply only to the tested sample of the stated device/equipment. Other similar device/equipment will not necessarily produce the same results due to production tolerance and measurement uncertainties.

This report shall not be reproduced except in full, without the written approval of Shenzhen NTEK, this document may be altered or revised by Shenzhen NTEK, personal only, and shall be noted in the revision of the document.

Test Sample Number S231116035003

Date of Test

Date (s) of performance of tests... Jan. 08, 2024 ~ Jan. 18, 2024

Date of Issue Feb. 01, 2024

Test Result **Pass**

Prepared By : <u>Jack Li</u> Jack Li (Project Engineer)	Reviewed By : <u>Aaron Cheng</u> Aaron Cheng (Supervisor)	Approved By : <u>Alex Li</u> Alex Li (Manager)
---	---	--

※ ※ Revision History ※ ※

REV.	DESCRIPTION	ISSUED DATE	REMARK
Rev.1.0	Initial Test Report Release	Feb. 01, 2024	Jack Li

TABLE OF CONTENTS

1. General Information	6
1.1. RF exposure limits.....	6
1.2. Statement of Compliance	7
1.3. EUT Description	7
1.4. Test specification(s)	9
1.5. Ambient Condition.....	9
2. SAR Measurement System	10
2.1. SATIMO SAR Measurement Set-up Diagram	10
2.2. Robot	11
2.3. E-Field Probe.....	12
2.3.1. E-Field Probe Calibration	12
2.4. SAM phantoms	13
2.4.1. Technical Data	14
2.5. Device Holder	15
2.6. Test Equipment List	16
3. SAR Measurement Procedures	19
3.1. Power Reference	19
3.2. Area scan & Zoom scan.....	19
3.3. Description of interpolation/extrapolation scheme	21
3.4. Volumetric Scan	21
3.5. Power Drift	21
4. System Verification Procedure	22
4.1. Tissue Verification	22
4.1.1. Tissue Dielectric Parameter Check Results	23
4.2. System Verification Procedure	24
4.2.1. System Verification Results.....	25
5. SAR Measurement variability and uncertainty	26
5.1. SAR measurement variability.....	26
5.2. SAR measurement uncertainty	26
6. RF Exposure Positions.....	27
6.1. Ear and handset reference point	27
6.2. Definition of the cheek position	27
6.3. Definition of the tilt position	29
6.4. Body Worn Accessory	29
6.5. Wireless Router Devices	30
7. RF Output Power	31
7.1. GSM Conducted Power	31
7.2. WCDMA Conducted Power	31
7.3. LTE Conducted Power	33

7.4. WLAN & Bluetooth Output Power	47
8. Antenna Location.....	48
9. Stand-alone SAR test exclusion.....	48
10. SAR Results	49
10.1. SAR measurement Result.....	49
10.1.1. SAR measurement Result of GSM850.....	49
10.1.2. SAR measurement Result of GSM1900.....	50
10.1.3. SAR measurement Result of WCDMA Band 2.....	51
10.1.4. SAR measurement Result of WCDMA Band 4.....	52
10.1.5. SAR measurement Result of WCDMA Band 5.....	53
10.1.6. SAR measurement Result of LTE Band 2	54
10.1.7. SAR measurement Result of LTE Band 4	56
10.1.8. SAR measurement Result of LTE Band 5	58
10.1.9. SAR measurement Result of LTE Band 7	60
10.1.10. SAR measurement Result of LTE Band 38	62
10.1.11. SAR measurement Result of LTE Band 66	64
10.1.12. SAR measurement Result of WLAN 2.4G	66
10.2. Simultaneous Transmission Analysis.....	67
11. Appendix A. Photo documentation	68
12. Appendix B. System Check Plots.....	69
13. Appendix C. Plots of High SAR Measurement.....	80
14. Appendix D. Calibration Certificate	129

1. General Information

1.1. RF exposure limits

(A).Limits for Occupational/Controlled Exposure (W/kg)

Whole-Body	Partial-Body	Hands, Wrists, Feet and Ankles
0.4	8.0	20.0

(B).Limits for General Population/Uncontrolled Exposure (W/kg)

Whole-Body	Partial-Body	Hands, Wrists, Feet and Ankles
0.08	1.6	4.0

NOTE: **Whole-Body SAR** is averaged over the entire body, **partial-body SAR** is averaged over any 1 gram of tissue defined as a tissue volume in the shape of a cube. **SAR for hands, wrists, feet and ankles** is averaged over any 10 grams of tissue defined as a tissue volume in the shape of a cube.

Occupational/Controlled Environments:

Are defined as locations where there is exposure that may be incurred by people who are aware of the potential for exposure, (i.e. as a result of employment or occupation).

General Population/Uncontrolled Environments:

Are defined as locations where there is the exposure of individuals who have no knowledge or control of their exposure.

NOTE

Localized Head, Neck and Trunk LIMIT

1.6 W/kg

APPLIED TO THIS EUT

1.2. Statement of Compliance

The maximum results of Specific Absorption Rate (SAR) found during testing for BL61 PRO are as follows.

RF Exposure Conditions		Max Reported SAR Value(W/kg)
1-g Head		0.192
1-g Body-Worn (Separation distance of 10mm)		1.135
1-g Hotspot (Separation distance of 10mm)		1.135
Max Simultaneous Tx	Head	0.282
	Body-Worn	1.271
	Hotspot	1.271

Note: The Max Simultaneous Tx is calculated based on the same configuration and test position. This device is in compliance with Specific Absorption Rate (SAR) for general population/uncontrolled exposure limits (1.6 W/kg) specified in FCC 47 CFR Part 2(2.1093) and ANSI/IEEE C95.1-1992, and had been tested in accordance with the measurement methods and procedures specified in IEEE Std 1528-2013 & KDB 865664 D01.

1.3. EUT Description

Device Information			
Product Name	Mobile Phone		
Brand Name	Bmobile		
Model Name	BL61 PRO		
Family Model	N/A		
Model Difference	N/A		
FCC ID	ZSW-30-133		
Device Phase	Identical Prototype		
Exposure Category	General population / Uncontrolled environment		
Antenna Type	PIFA Antenna		
Battery Information	DC 3.8V/3000mAh from battery or DC 5V from Adapter.		
HW Version	Bmobile_BL61Pro_TIGO_LATAM_V002		
SW Version	Bmobile_BL61Pro_HW_V1.0		
Device Operating Configurations			
Supporting Mode(s)	GSM850/1900,WCDMABand2/4/5,LTEBand2/4/5/7/38/66, WLAN 2.4G, Bluetooth		
Test Modulation	GSM(GMSK/8PSK), WCDMA(QPSK), LTE(QPSK/16QAM), WLAN(DSSS/OFDM), Bluetooth(GFSK, π/4-DQPSK, 8DPSK),		
Device Class	B		
Operating Frequency	Band	Tx (MHz)	Rx (MHz)

Range(s)	GSM 850	824-849	869-894
	GSM 1900	1850-1910	1930-1990
	WCDMA Band 2	1850-1910	1930-1990
	WCDMA Band 4	1710-1755	2110-2155
	WCDMA Band 5	824-849	869-894
	LTE Band 2	1850-1910	1930-1990
	LTE Band 4	1710-1755	2110-2155
	LTE Band 5	824-849	869-894
	LTE Band 7	2500-2570	2620-2690
	LTE Band 38	2570-2620	
	LTE Band 66	1710-1780	2110-2200
	WLAN 2.4G	2412-2462	
	Bluetooth	2402-2480	
	GPRS Multislot Class(12)	Max Number of Timeslots in Uplink	
Max Number of Timeslots in Downlink		4	
Max Total Timeslot		5	
Power Class	4, tested with power level 5(GSM 850)		
	1, tested with power level 0(GSM 1900)		
	3, tested with power control "all 1"(WCDMA Band 2)		
	3, tested with power control "all 1"(WCDMA Band 4)		
	3, tested with power control "all 1"(WCDMA Band 5)		
	3, tested with power control all Max.(LTE Band 2)		
	3, tested with power control all Max.(LTE Band 4)		
	3, tested with power control all Max.(LTE Band 5)		
	3, tested with power control all Max.(LTE Band 7)		
	3, tested with power control all Max.(LTE Band 38)		
	3, tested with power control all Max.(LTE Band 66)		

1.4. Test specification(s)

FCC 47 CFR Part 2(2.1093)
ANSI/IEEE C95.1-1992
IEEE Std 1528-2013
KDB 865664 D01 SAR measurement 100 MHz to 6 GHz
KDB 865664 D02 RF Exposure Reporting
KDB 447498 D01 General RF Exposure Guidance
KDB 248227 D01 802.11 Wi-Fi SAR
KDB 941225 D01 3G SAR Procedures
KDB 941225 D05 SAR for LTE Devices
KDB 941225 D06 Hotspot SAR
KDB 648474 D04 Handset SAR

1.5. Ambient Condition

Ambient temperature	20°C – 24°C
Relative Humidity	30% – 70%

2. SAR Measurement System

2.1. SATIMO SAR Measurement Set-up Diagram

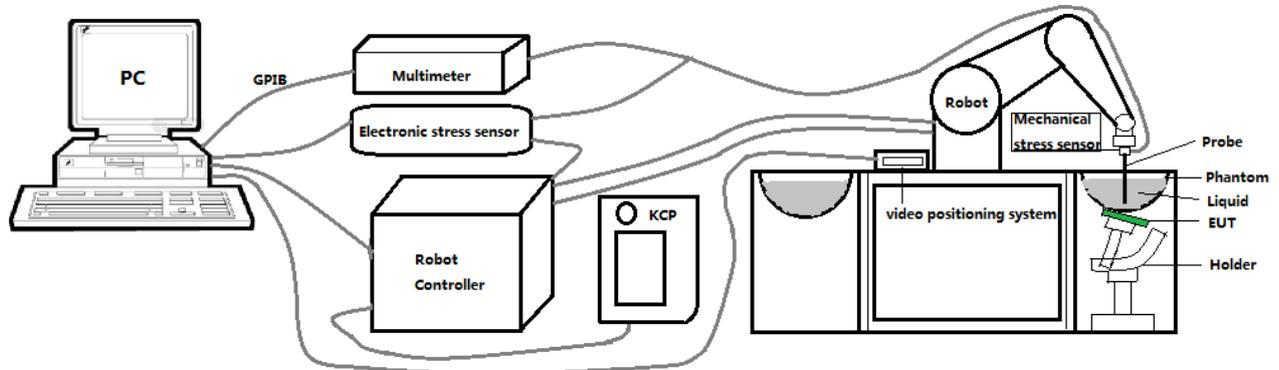

These measurements were performed with the automated near-field scanning system OPENSAR from SATIMO. The system is based on a high precision robot (working range: 901 mm), which positions the probes with a positional repeatability of better than ± 0.03 mm. The SAR measurements were conducted with dosimetric probe (manufactured by SATIMO), designed in the classical triangular configuration and optimized for dosimetric evaluation.

The first step of the field measurement is the evaluation of the voltages induced on the probe by the device under test. Probe diode detectors are nonlinear. Below the diode compression point, the output voltage is proportional to the square of the applied E-field; above the diode compression point, it is linear to the applied E-field. The compression point depends on the diode, and a calibration procedure is necessary for each sensor of the probe.

The Keithley multimeter reads the voltage of each sensor and send these three values to the PC. The corresponding E field value is calculated using the probe calibration factors, which are stored in the working directory. This evaluation includes linearization of the diode characteristics. The field calculation is done separately for each sensor. Each component of the E field is displayed on the "Dipole Area Scan Interface" and the total E field is displayed on the "3D Interface"

2.2. Robot

The SATIMO SAR system uses the high precision robots from KUKA. For the 6-axis controller system, the robot controller version (KUKA) from KUKA is used. The KUKA robot series have many features that are important for our application:



- High precision (repeatability ± 0.03 mm)
- High reliability (industrial design)
- Jerk-free straight movements
- Low ELF interference (the closed metallic construction shields against motor control fields)

2.3. E-Field Probe

This E-field detection probe is composed of three orthogonal dipoles linked to special Schottky diodes with low detection thresholds. The probe allows the measurement of electric fields in liquids such as the one defined in the IEEE and CENELEC standards.

For the measurements the Specific Dosimetric E-Field Probe 3423-EPGO-426 with following specifications is used



- Dynamic range: 0.01-100 W/kg
 - Tip Diameter : 2.5 mm
 - Distance between probe tip and sensor center: 1 mm
 - Distance between sensor center and the inner phantom surface: 2 mm (repeatability better than ± 1 mm).
 - Probe linearity: ± 0.06 dB
 - Axial isotropy: ± 0.01 dB
 - Hemispherical Isotropy: ± 0.01 dB
 - Calibration range: 650MHz to 5900MHz for head & body simulating liquid.
 - Lower detection limit: 8mW/kg
- Angle between probe axis (evaluation axis) and surface normal line: less than 30° .

2.3.1. E-Field Probe Calibration

Each probe needs to be calibrated according to a dosimetric assessment procedure with accuracy better than $\pm 10\%$. The spherical isotropy shall be evaluated and within ± 0.25 dB. The sensitivity parameters (Norm X, Norm Y, and Norm Z), the diode compression parameter (DCP) and the conversion factor (Conv F) of the probe are tested. The calibration data can be referred to appendix D of this report.

2.4. SAM phantoms

Photo of SAM phantom SN 16/15 SAM119



The SAM phantom is used to measure the SAR relative to people exposed to electro-magnetic field radiated by Smart Phones.

2.4.1. Technical Data

Serial Number	Shell thickness	Filling volume	Dimensions	Positionner Material	Permittivity	Loss Tangent
SN 16/15 SAM119	2 mm ±0.2 mm	27 liters	Length:1000 mm Width:500 mm Height:200 mm	Gelcoat with fiberglass	3.4	0.02

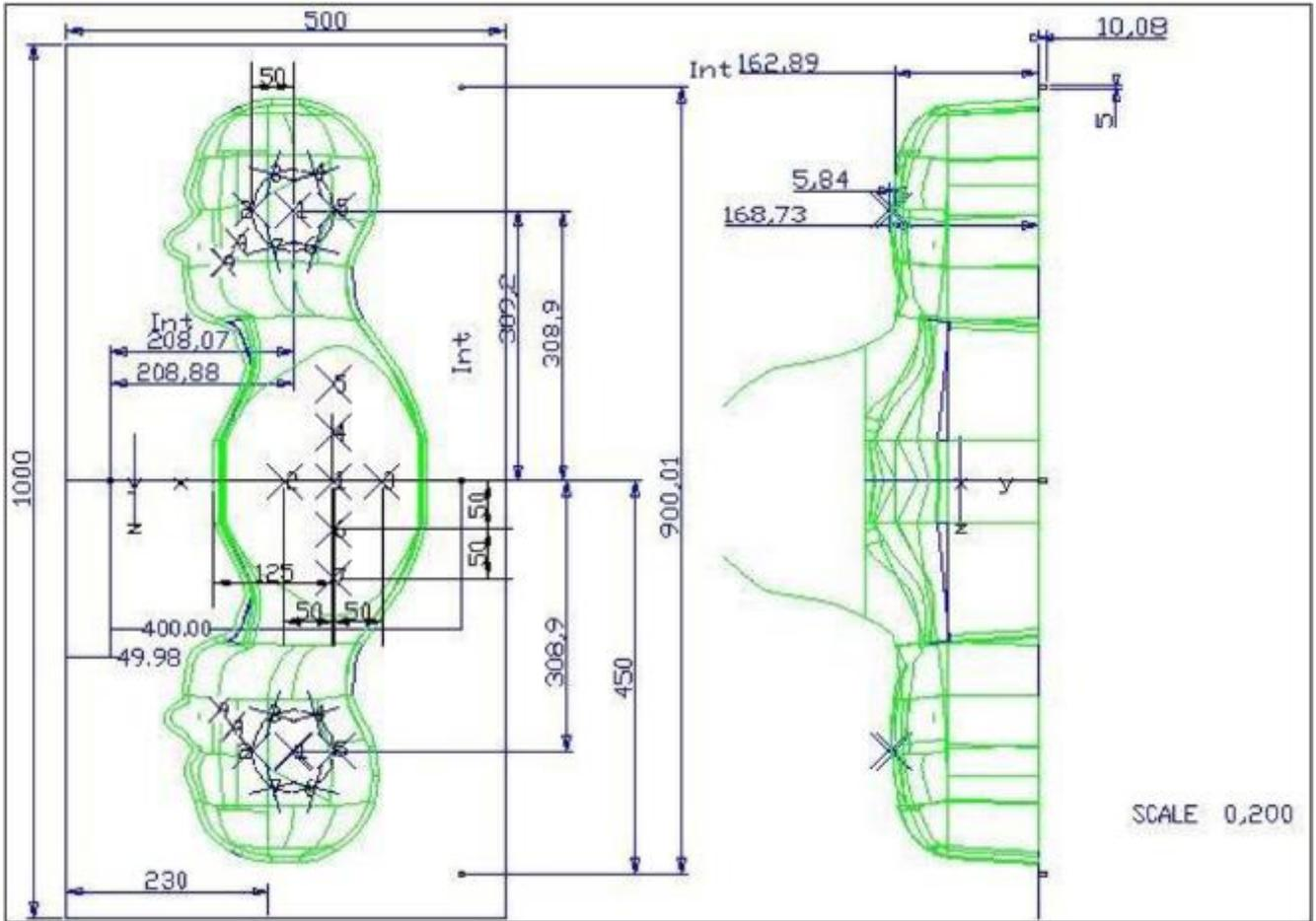

Serial Number	Left Head(mm)		Right Head(mm)		Flat Part(mm)	
	1	2	1	2	1	2
SN 16/15 SAM119	2	2.02	2	2.08	1	2.09
	3	2.05	3	2.06	2	2.06
	4	2.07	4	2.07	3	2.08
	5	2.08	5	2.08	4	2.10
	6	2.05	6	2.07	5	2.10
	7	2.05	7	2.05	6	2.07
	8	2.07	8	2.06	7	2.07
	9	2.08	9	2.06	-	-

The test, based on ultrasonic system, allows measuring the thickness with an accuracy of 10 µm.

2.5. Device Holder

The positioning system allows obtaining cheek and tilting position with a very good accuracy. In compliance with CENELEC, the tilt angle uncertainty is lower than 1 degree.

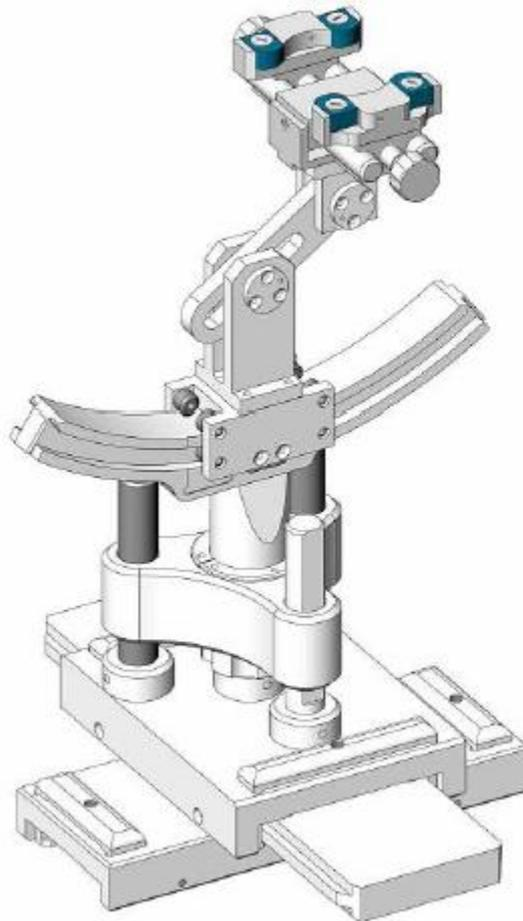

Serial Number	Holder Material	Permittivity	Loss Tangent
SN 16/15 MSH100	Delrin	3.7	0.005

2.6. Test Equipment List

This table gives a complete overview of the SAR measurement equipment.

Devices used during the test described are marked

	Manufacturer	Name of Equipment	Type/Model	Serial Number	Calibration	
					Last Cal.	Due Date
<input checked="" type="checkbox"/>	MVG	E FIELD PROBE	SSE2	3423-EPGO-426	Sep. 18, 2023	Sep. 17, 2024
<input type="checkbox"/>	MVG	750 MHz Dipole	SID750	SN 03/15 DIP 0G750-355	Mar. 01, 2021	Feb. 28, 2024
<input checked="" type="checkbox"/>	MVG	835 MHz Dipole	SID835	SN 03/15 DIP 0G835-347	Mar. 01, 2021	Feb. 28, 2024
<input type="checkbox"/>	MVG	900 MHz Dipole	SID900	SN 03/15 DIP 0G900-348	Mar. 01, 2021	Feb. 28, 2024
<input checked="" type="checkbox"/>	MVG	1800 MHz Dipole	SID1800	SN 03/15 DIP 1G800-349	Mar. 01, 2021	Feb. 28, 2024
<input checked="" type="checkbox"/>	MVG	1900 MHz Dipole	SID1900	SN 03/15 DIP 1G900-350	Mar. 01, 2021	Feb. 28, 2024
<input type="checkbox"/>	MVG	2000 MHz Dipole	SID2000	SN 03/15 DIP 2G000-351	Mar. 01, 2021	Feb. 28, 2024
<input type="checkbox"/>	MVG	2300 MHz Dipole	SID2300	SN 03/16 DIP 2G300-358	Mar. 01, 2021	Feb. 28, 2024
<input checked="" type="checkbox"/>	MVG	2450 MHz Dipole	SID2450	SN 03/15 DIP 2G450-352	Mar. 01, 2021	Feb. 28, 2024
<input checked="" type="checkbox"/>	MVG	2600 MHz Dipole	SID2600	SN 03/15 DIP 2G600-356	Mar. 01, 2021	Feb. 28, 2024
<input type="checkbox"/>	MVG	3500 MHz Dipole	SID3500	SN 09/12 DIP 3G500-360	Oct. 15, 2022	Oct. 14, 2025
<input type="checkbox"/>	MVG	5000 MHz Dipole	SWG5500	SN 13/14 WGA 33	Mar. 01, 2021	Feb. 28, 2024
<input checked="" type="checkbox"/>	MVG	Liquid measurement Kit	SCLMP	SN 21/15 OCPG 72	NCR	NCR
<input checked="" type="checkbox"/>	MVG	Power Amplifier	N.A	AMPLISAR_28/14_003	NCR	NCR
<input checked="" type="checkbox"/>	KEITHLEY	Millivoltmeter	2000	4072790	NCR	NCR
<input checked="" type="checkbox"/>	R&S	Universal radio communication tester	CMU200	117858	May 29, 2023	May 28, 2024
<input checked="" type="checkbox"/>	R&S	Wideband radio communication	CMW500	103917	May 29, 2023	May 28, 2024

		tester				
<input checked="" type="checkbox"/>	HP	Network Analyzer	8753D	3410J01136	May 29, 2023	May 28, 2024
<input checked="" type="checkbox"/>	Agilent	MXG Vector Signal Generator	N5182A	MY47070317	May 29, 2023	May 28, 2024
<input checked="" type="checkbox"/>	Agilent	Power meter	E4419B	MY45102538	May 29, 2023	May 28, 2024
<input checked="" type="checkbox"/>	Agilent	Power sensor	E9301A	MY41495644	May 29, 2023	May 28, 2024
<input checked="" type="checkbox"/>	Agilent	Power sensor	E9301A	US39212148	May 29, 2023	May 28, 2024
<input checked="" type="checkbox"/>	MCLI/USA	Directional Coupler	CB11-20	0D2L51502	Jul. 04, 2023	Jul. 03, 2024
<input checked="" type="checkbox"/>	N/A	Thermometer	N/A	LES-085	Mar. 27, 2023	Mar. 26, 2026
<input checked="" type="checkbox"/>	MVG	SAM Phantom	SSM2	SN 16/15 SAM119	NCR	NCR
<input checked="" type="checkbox"/>	MVG	Device Holder	SMPPD	SN 16/15 MSH100	NCR	NCR
<input checked="" type="checkbox"/>	Shenzhen Tianxu Communication Technology Co., Ltd.	Human Simulating Liquid	Head 835	Head 835	NCR	NCR
<input checked="" type="checkbox"/>	Shenzhen Tianxu Communication Technology Co., Ltd.	Human Simulating Liquid	Head 1800	Head 1800	NCR	NCR
<input checked="" type="checkbox"/>	Shenzhen Tianxu Communication Technology Co., Ltd.	Human Simulating Liquid	Head 1900	Head 1900	NCR	NCR
<input checked="" type="checkbox"/>	Shenzhen Tianxu Communication Technology Co., Ltd.	Human Simulating Liquid	Head 2450	Head 2450	NCR	NCR
<input checked="" type="checkbox"/>	Shenzhen Tianxu Communication Technology Co., Ltd.	Human Simulating Liquid	Head 2600	Head 2600	NCR	NCR

	Co., Ltd.					
--	-----------	--	--	--	--	--

3. SAR Measurement Procedures

The measurement procedures are as follows:

<Conducted power measurement>

- (a) For WWAN power measurement, use base station simulator to configure EUT WWAN transmission in conducted connection with RF cable, at maximum power in each supported wireless interface and frequency band.
- (b) Read the WWAN RF power level from the base station simulator.
- (c) For Wi-Fi/BT power measurement, use engineering software to configure EUT Wi-Fi/BT continuously transmission, at maximum RF power in each supported wireless interface and frequency band.
- (d) Connect EUT RF port through RF cable to the power meter, and measure Wi-Fi/BT output power.

<SAR measurement>

- (a) Use base station simulator to configure EUT WWAN transmission in radiated connection, and engineering software to configure EUT Wi-Fi/BT continuously transmission, at maximum RF power, in the highest power channel.
- (b) Place the EUT in the positions as Appendix A demonstrates.
- (c) Set scan area, grid size and other setting on the OPENSAR software.
- (d) Measure SAR results for the highest power channel on each testing position.
- (e) Find out the largest SAR result on these testing positions of each band.
- (f) Measure SAR results for other channels in worst SAR testing position if the reported SAR of highest power channel is larger than 0.8 W/kg.

According to the test standard, the recommended procedure for assessing the peak spatial-average SAR value consists of the following steps:

- (a) Power reference measurement
- (b) Area scan
- (c) Zoom scan
- (d) Power drift measurement

3.1. Power Reference

The Power Reference Measurement and Power Drift Measurements are for monitoring the power drift of the device under test in the batch process. The minimum distance of probe sensors to surface determines the closest measurement point to phantom surface. This distance cannot be smaller than the distance of sensor calibration points to probe tip as defined in the probe properties.

3.2. Area scan & Zoom scan

The area scan is a 2D scan to find the hot spot location on the DUT. The zoom scan is a 3D scan

above the hot spot to calculate the 1g and 10g SAR value.

Measurement of the SAR distribution with a grid of 8 to 16 mm * 8 to 16 mm and a constant distance to the inner surface of the phantom. Since the sensors cannot directly measure at the inner phantom surface, the values between the sensors and the inner phantom surface are extrapolated. With these values the area of the maximum SAR is calculated by an interpolation scheme. Around this point, a cube of 30 * 30 * 30 mm or 32 * 32 * 32 mm is assessed by measuring 5 or 8 * 5 or 8 * 4 or 5 mm. With these data, the peak spatial-average SAR value can be calculated.

From the scanned SAR distribution, identify the position of the maximum SAR value, in addition identify the positions of any local maxima with SAR values within 2 dB of the maximum value that will not be within the zoom scan of other peaks; additional peaks shall be measured only when the primary peak is within 2 dB of the SAR compliance limit (e.g., 1 W/kg for 1,6 W/kg 1 g limit, or 1,26 W/kg for 2 W/kg, 10 g limit).

Area scan & Zoom scan scan parameters extracted from FCC KDB 865664 D01 SAR measurement 100 MHz to 6 GHz.

		≤ 3 GHz	> 3 GHz	
Maximum distance from closest measurement point (geometric center of probe sensors) to phantom surface		5 ± 1 mm	½·δ·ln(2) ± 0.5 mm	
Maximum probe angle from probe axis to phantom surface normal at the measurement location		30° ± 1°	20° ± 1°	
Maximum area scan spatial resolution: Δx _{Area} , Δy _{Area}		≤ 2 GHz: ≤ 15 mm 2 – 3 GHz: ≤ 12 mm	3 – 4 GHz: ≤ 12 mm 4 – 6 GHz: ≤ 10 mm	
		When the x or y dimension of the test device, in the measurement plane orientation, is smaller than the above, the measurement resolution must be ≤ the corresponding x or y dimension of the test device with at least one measurement point on the test device.		
Maximum zoom scan spatial resolution: Δx _{Zoom} , Δy _{Zoom}		≤ 2 GHz: ≤ 8 mm 2 – 3 GHz: ≤ 5 mm*	3 – 4 GHz: ≤ 5 mm* 4 – 6 GHz: ≤ 4 mm*	
Maximum zoom scan spatial resolution, normal to phantom surface	uniform grid: Δz _{Zoom} (n)	≤ 5 mm	3 – 4 GHz: ≤ 4 mm 4 – 5 GHz: ≤ 3 mm 5 – 6 GHz: ≤ 2 mm	
	graded grid	Δz _{Zoom} (1): between 1 st two points closest to phantom surface	≤ 4 mm	3 – 4 GHz: ≤ 3 mm 4 – 5 GHz: ≤ 2.5 mm 5 – 6 GHz: ≤ 2 mm
		Δz _{Zoom} (n>1): between subsequent points	≤ 1.5·Δz _{Zoom} (n-1)	
Minimum zoom scan volume	x, y, z	≥ 30 mm	3 – 4 GHz: ≥ 28 mm 4 – 5 GHz: ≥ 25 mm 5 – 6 GHz: ≥ 22 mm	

Note: δ is the penetration depth of a plane-wave at normal incidence to the tissue medium; see draft standard IEEE P1528-2011 for details.

* When zoom scan is required and the *reported* SAR from the *area scan based 1-g SAR estimation* procedures of KDB 447498 is ≤ 1.4 W/kg, ≤ 8 mm, ≤ 7 mm and ≤ 5 mm zoom scan resolution may be applied, respectively, for 2 GHz to 3 GHz, 3 GHz to 4 GHz and 4 GHz to 6 GHz.

3.3. Description of interpolation/extrapolation scheme

The local SAR inside the phantom is measured using small dipole sensing elements inside a probe body. The probe tip must not be in contact with the phantom surface in order to minimise measurements errors, but the highest local SAR will occur at the surface of the phantom.

An extrapolation is using to determinate this highest local SAR values. The extrapolation is based on a fourth-order least-square polynomial fit of measured data. The local SAR value is then extrapolated from the liquid surface with a 1 mm step.

The measurements have to be performed over a limited time (due to the duration of the battery) so the step of measurement is high. It could vary between 5 and 8 mm. To obtain an accurate assessment of the maximum SAR averaged over 10 grams and 1 gram requires a very fine resolution in the three dimensional scanned data array.

3.4. Volumetric Scan

The volumetric scan consists to a full 3D scan over a specific area. This 3D scan is useful form multi Tx SAR measurement. Indeed, it is possible with OpenSAR to add, point by point, several volumetric scan to calculate the SAR value of the combined measurement as it is define in the standard IEEE1528 and IEC62209.

3.5. Power Drift

All SAR testing is under the EUT install full charged battery and transmit maximum output power. In OpenSAR measurement software, the power reference measurement and power drift measurement procedures are used for monitoring the power drift of EUT during SAR test. Both these procedures measure the field at a specified reference position before and after the SAR testing. The software will calculate the field difference in V/m. If the power drifts more than $\pm 5\%$, the SAR will be retested.

4. System Verification Procedure

4.1. Tissue Verification

The following tissue formulations are provided for reference only as some of the parameters have not been thoroughly verified. The composition of ingredients may be modified accordingly to achieve the desired target tissue parameters required for routine SAR evaluation.

Ingredients (% of weight)	Head Tissue									
	750	835	900	1800	1900	2000	2450	2600	5200	5800
Frequency Band (MHz)										
Water	34.40	34.40	34.40	55.36	55.36	57.87	57.87	57.87	65.53	65.53
NaCl	0.79	0.79	0.79	0.35	0.35	0.16	0.16	0.16	0.00	0.00
1,2-Propanediol	64.81	64.81	64.81	0.00	0.00	0.00	0.00	0.00	0.00	0.00
Triton X-100	0.00	0.00	0.00	30.45	30.45	19.97	19.97	19.97	24.24	24.24
DGBE	0.00	0.00	0.00	13.84	13.84	22.00	22.00	22.00	10.23	10.23

For SAR measurement of the field distribution inside the phantom, the phantom must be filled with homogeneous tissue simulating liquid to a depth of at least 15 cm. For head SAR testing, the liquid depth from the ear reference point (ERP) of the phantom to the liquid top surface is larger than 15 cm.

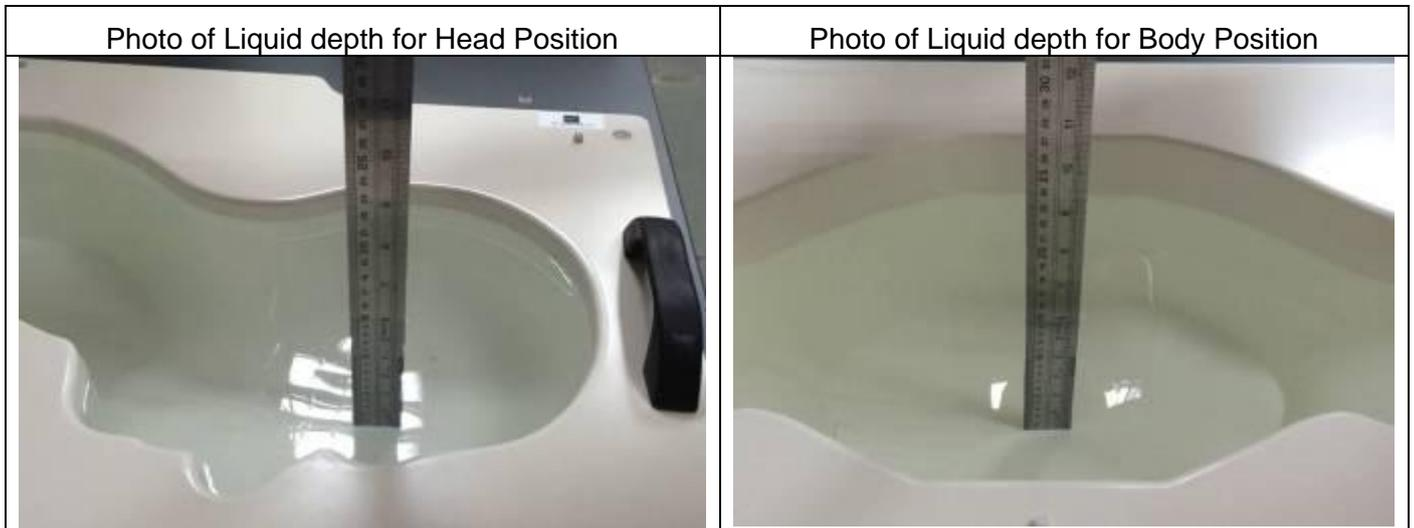

4.1.1. Tissue Dielectric Parameter Check Results

The simulating liquids should be checked at the beginning of a series of SAR measurements to determine if the dielectric parameters are within the tolerances of the specified target values. The measured conductivity and relative permittivity should be within $\pm 5\%$ of the target values.

Tissue Type	Measured Frequency (MHz)	Target Tissue		Measured Tissue		Liquid Temp.	Test Date
		ϵ_r ($\pm 5\%$)	σ (S/m) ($\pm 5\%$)	ϵ_r	σ (S/m)		
Head 850	835	41.50 (39.43~43.58)	0.90 (0.86~0.95)	41.26	0.89	21.8 °C	Jan. 10, 2024
Head 1800	1800	40.00 (38.00~42.00)	1.40 (1.33~1.47)	39.54	1.39	21.4 °C	Jan. 08, 2024
Head 1900	1900	40.00 (38.00~42.00)	1.40 (1.33~1.47)	39.13	1.46	21.2 °C	Jan. 11, 2024
Head 2450	2450	39.20 (37.24~41.16)	1.80 (1.71~1.89)	38.16	1.77	21.5 °C	Jan. 09, 2024
Head 2600	2600	39.01 (37.06~40.96)	1.96 (1.86~2.06)	38.67	1.94	21.7 °C	Jan. 18, 2024

NOTE: The dielectric parameters of the tissue-equivalent liquid should be measured under similar ambient conditions and within 2 °C of the conditions expected during the SAR evaluation to satisfy protocol requirements.

4.2. System Verification Procedure

The system verification is performed for verifying the accuracy of the complete measurement system and performance of the software. The dipole is connected to the signal source consisting of signal generator and amplifier via a directional coupler, N-connector cable and adaption to SMA. It is fed with a power of 100mW (below 5GHz) or 100mW (above 5GHz). To adjust this power a power meter is used. The power sensor is connected to the cable before the system verification to measure the power at this point and do adjustments at the signal generator. At the outputs of the directional coupler both return loss as well as forward power are controlled during the system verification to make sure that emitted power at the dipole is kept constant. This can also be checked by the power drift measurement after the test (result on plot).

The system verification is shown as below picture:

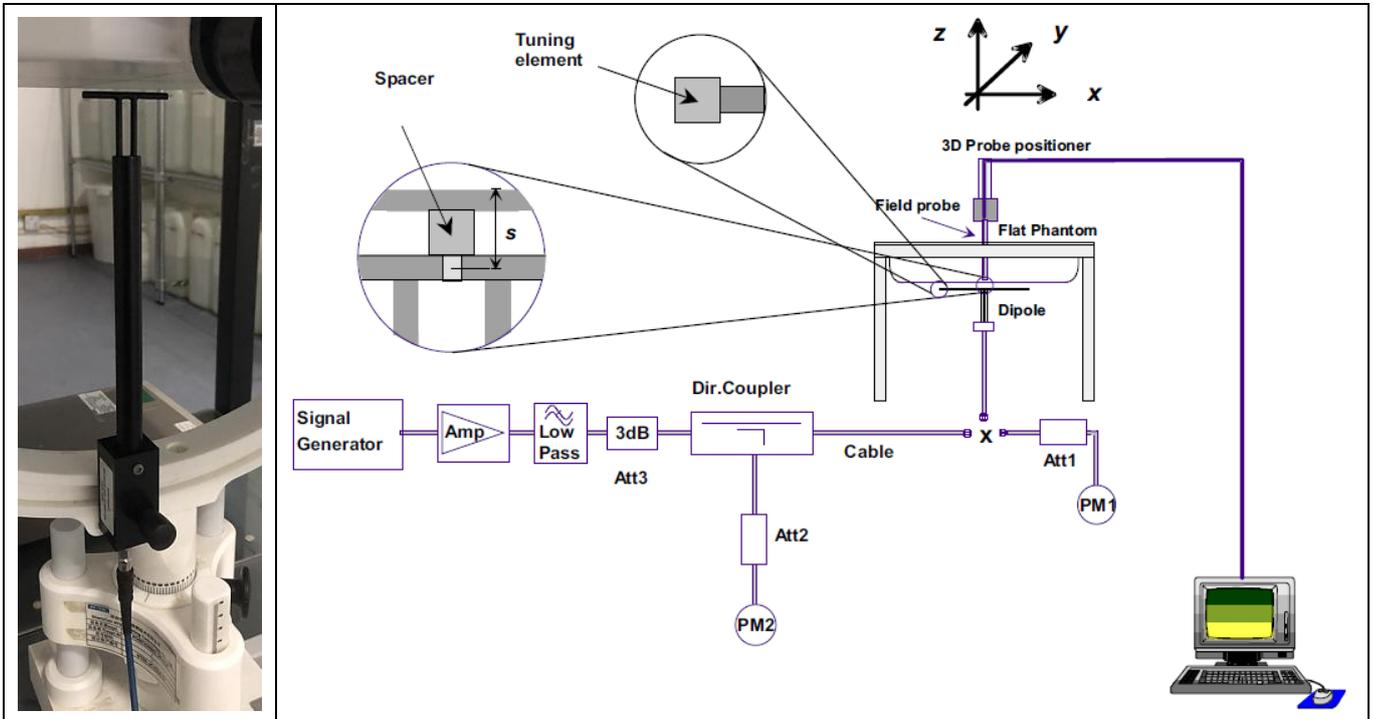

4.2.1. System Verification Results

Comparing to the original SAR value provided by SATIMO, the verification data should be within its specification of $\pm 10\%$. Below table shows the target SAR and measured SAR after normalized to 1W input power. The table below indicates the system performance verification can meet the variation criterion and the plots can be referred to Appendix B of this report.

System Verification	Target SAR (1W)		Measured SAR		Liquid Temp.	Delta (%)		Test Date
	($\pm 10\%$)		(Normalized to 1W)			1-g ($\pm 10\%$)	10-g ($\pm 10\%$)	
	1-g (W/Kg)	10-g (W/Kg)	1-g (W/Kg)	10-g (W/Kg)				
835MHz	9.84 (8.86~10.82)	6.22 (5.60~6.84)	9.97	6.74	21.8 °C	1.32%	8.36%	Jan. 10, 2024
1800MHz	37.96 (34.17~41.75)	19.81 (17.83~21.79)	39.49	18.91	21.4 °C	4.03%	-4.54%	Jan. 08, 2024
1900MHz	40.37 (36.34~44.40)	20.48 (18.44~22.52)	40.81	20.98	21.2 °C	1.09%	2.44%	Jan. 11, 2024
2450MHz	53.69 (48.33~59.05)	23.94 (21.55~26.33)	50.98	24.13	21.5 °C	-5.05%	2.46%	Jan. 09, 2024
2600MHz	55.83 (50.25~61.41)	24.19 (21.78~26.60)	53.57	21.94	21.7 °C	-4.05%	-9.30%	Jan. 18, 2024

5. SAR Measurement variability and uncertainty

5.1. SAR measurement variability

Per KDB865664 D01 SAR measurement 100 MHz to 6 GHz, SAR measurement variability must be assessed for each frequency band, which is determined by the SAR probe calibration point and tissue-equivalent medium used for the device measurements. The additional measurements are repeated after the completion of all measurements requiring the same head or body tissue-equivalent medium in a frequency band. The test device should be returned to ambient conditions (normal room temperature) with the battery fully charged before it is re-mounted on the device holder for the repeated measurement(s) to minimize any unexpected variations in the repeated results.

- 1) Repeated measurement is not required when the original highest measured SAR is < 0.80 W/kg; steps 2) through 4) do not apply.
- 2) When the original highest measured SAR is ≥ 0.80 W/kg, repeat that measurement once.
- 3) Perform a second repeated measurement only if the ratio of largest to smallest SAR for the original and first repeated measurements is > 1.20 or when the original or repeated measurement is ≥ 1.45 W/kg (~ 10% from the 1-g SAR limit).
- 4) Perform a third repeated measurement only if the original, first or second repeated measurement is ≥ 1.5 W/kg and the ratio of largest to smallest SAR for the original, first and second repeated measurements is > 1.20 .

5.2. SAR measurement uncertainty

Per KDB865664 D01 SAR Measurement 100 MHz to 6 GHz, when the highest measured 1-g SAR within a frequency band is < 1.5 W/kg, the extensive SAR measurement uncertainty analysis described in IEEE Std 1528-2013 is not required in SAR reports submitted for equipment approval. The equivalent ratio (1.5/1.6) is applied to extremity and occupational exposure conditions.

6. RF Exposure Positions

6.1. Ear and handset reference point

Figure 6.1.1 shows the front, back, and side views of the SAM phantom. The center-of-mouth reference point is labeled “M”, the left ear reference point (ERP) is marked “LE”, and the right ERP is marked “RE”.



Fig 6.1.1 Front, back, and side views of SAM phantom

6.2. Definition of the cheek position

1. Define two imaginary lines on the handset, the vertical centerline and the horizontal line. The vertical centerline passes through two points on the front side of the handset: the midpoint of the width w_t of the handset at the level of the acoustic output (point A in Figure 6.2.1 and Figure 6.2.2), and the midpoint of the width w_b of the bottom of the handset (point B). The horizontal line is perpendicular to the vertical centerline and passes through the center of the acoustic output (see Figure 6.2.1). The two lines intersect at point A. Note that for many handsets, point A coincides with the center of the acoustic output; however, the acoustic output may be located elsewhere on the horizontal line. Also note that the vertical centerline is not necessarily parallel to the front face of the handset (see Figure 6.2.2), especially for clamshell handsets, handsets with flip covers, and other irregularly-shaped handsets.
2. Position the handset close to the surface of the phantom such that point A is on the (virtual) extension of the line passing through points RE and LE on the phantom (see Figure 6.2.3), such that the plane defined by the vertical centerline and the horizontal line of the handset is approximately parallel to the sagittal plane of the phantom.
3. Translate the handset towards the phantom along the line passing through RE and LE until handset point A touches the pinna at the ERP
4. While maintaining the handset in this plane, rotate it around the LE-RE line until the vertical centerline is in the plane normal to the plane containing B-M and N-F lines, i.e., the Reference Plane.
5. Rotate the handset around the vertical centerline until the handset (horizontal line) is parallel to the N-F line.

6. While maintaining the vertical centerline in the Reference Plane, keeping point A on the line passing through RE and LE, and maintaining the handset contact with the pinna, rotate the handset about the N-F line until any point on the handset is in contact with a phantom point below the pinna on the cheek. See Figure 6.2.3. The actual rotation angles should be documented in the test report.

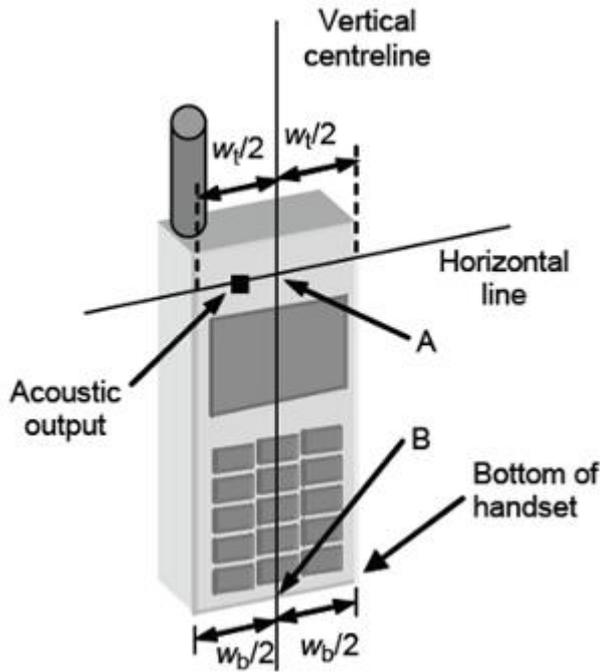

Fig 6.2.1 Handset vertical and horizontal reference lines—“fixed case”

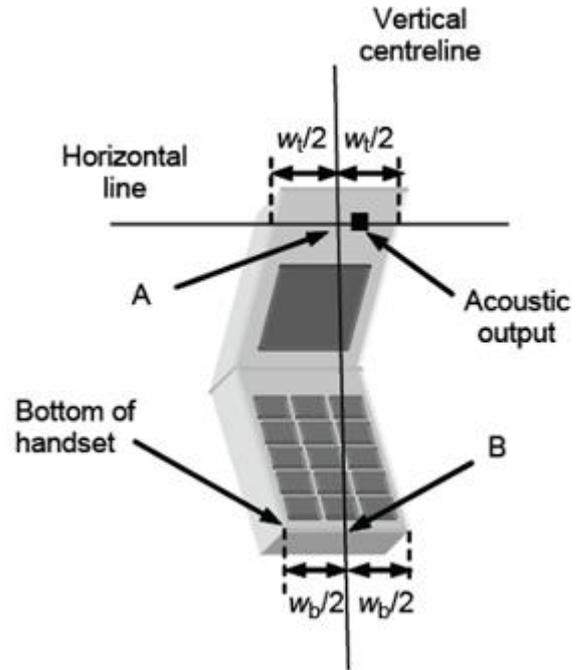

Fig 6.2.2 Handset vertical and horizontal reference lines— “clam-shell case”

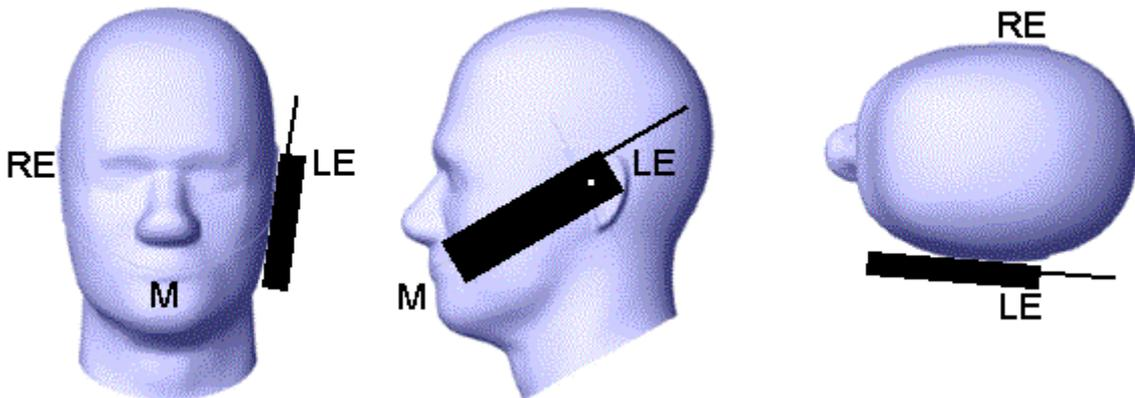

Fig 6.2.3 cheek or touch position. The reference points for the right ear (RE), left ear (LE), and mouth (M), which establish the Reference Plane for handset positioning, are indicated.

6.3. Definition of the tilt position

1. While maintaining the orientation of the handset, retract the handset parallel to the reference plane far enough away from the phantom to enable a rotation of the device by 15 degree.
2. Rotate the Handset around the horizontal line by 15 degree (see Figure 6.3.1).
3. While maintaining the orientation of the handset, move the handset towards the phantom on a line passing through RE and LE until any part of the handset touches the ear. The tilt position is obtained when the contact is on the pinna. If the contact is at any location other than the pinna, e.g., the antenna with the back of the phantom head, the angle of the handset shall be reduced. In this case, the tilt position is obtained if any part of the handset is in contact with the pinna as well as a second part of the handset is in contact with the phantom, e.g., the antenna with the back of the head.

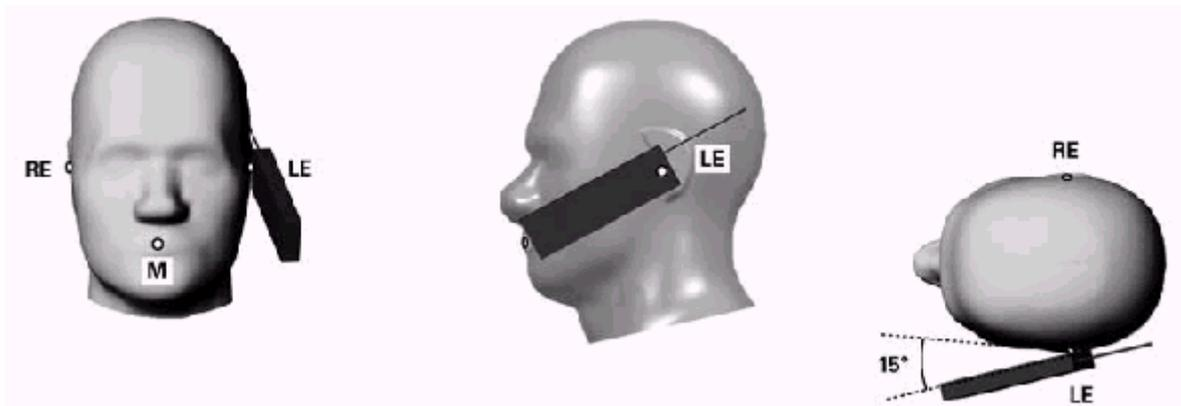

Figure 6.3.1 – Tilt position of the wireless device on the left side of SAM

6.4. Body Worn Accessory

1. Body-worn operating configurations are tested with the belt-clips and holsters attached to the device and positioned against a flat phantom in a normal use configuration (see Figure 6.4.1). Per KDB 648474 D04, body-worn accessory exposure is typically related to voice mode operations when handsets are carried in body-worn accessories. The body-worn accessory procedures in FCC KDB 447498 D01 should be used to test for body-worn accessory SAR compliance, without a headset connected to it. This enables the test results for such configuration to be compatible with that required for hotspot mode when the body-worn accessory test separation distance is greater than or equal to that required for hotspot mode, when applicable. When the reported SAR for body-worn accessory, measured without a headset connected to the handset is < 1.2 W/kg, the highest reported SAR configuration for that wireless mode and frequency band should be repeated for that body-worn accessory with a handset attached to the handset.
2. Accessories for body-worn operation configurations are divided into two categories: those that do not contain metallic components and those that do contain metallic components and those that do contain metallic components. When multiple accessories that do not contain metallic components are supplied with the device, the device is tested with only the accessory that dictates the closest

spacing to the body. Then multiple accessories that contain metallic components are test with the device with each accessory. If multiple accessories share an identical metallic component (i.e. the same metallic belt-clip used with different holsters with no other metallic components) only the accessory that dictates the closest spacing to the body is tested.

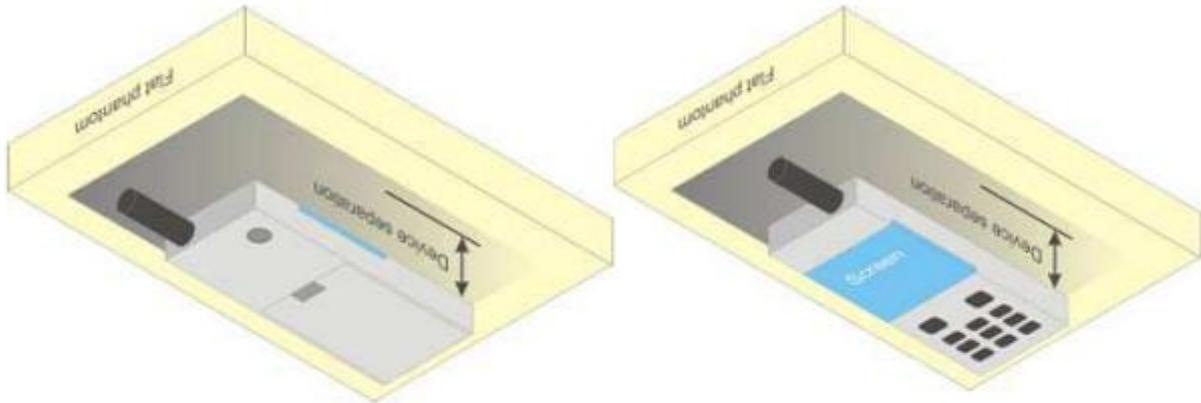

Figure 6.4.1 – Test positions for body-worn devices

6.5. Wireless Router Devices

Some battery-operated handsets have the capability to transmit and receive user through simultaneous transmission of WLAN simultaneously with a separate licensed transmitter. The FCC has provided guidance in FCC KDB Publication 941225 D06 where SAR test considerations for handsets ($L \times W \geq 9 \text{ cm} \times 5 \text{ cm}$) are based on a composite test separation distance of 10mm from the front, back and edges of the device containing transmitting antennas within 2.5cm of their edges, determined from general mixed use conditions for this type of devices. Since the hotspot SAR results may overlap with the body-worn accessory SAR requirements, the more conservative configurations can be considered, thus excluding some body-worn accessory SAR tests.

When the user enables the personal wireless router functions for the handset, actual operations include simultaneous transmission of both the WLAN transmitter and another licensed transmitter. Both transmitters often do not transmit at the same transmitting frequency and thus cannot be evaluated for SAR under actual use conditions due to the limitations of the SAR assessment probes. Therefore, SAR must be evaluated for each frequency transmission and mode separately and spatially summed with the WLAN transmitter according to FCC KDB Publication 447498 D01 publication procedures. The “Portable Hotspot” feature on the handset was NOT activated during SAR assessments, to ensure the SAR measurements were evaluated for a single transmission frequency RF signal at a time.

7. RF Output Power

7.1. GSM Conducted Power

Band GSM850	Burst-Averaged output Power (dBm)				Frame-Averaged output Power (dBm)			
Tx Channel	Tune-up (dBm)	128	189	251	Tune-up	128	189	251
Frequency (MHz)		824.2	836.4	848.8		824.2	836.4	848.8
GSM (GMSK)	33.50	32.91	33.08	32.85	24.47	23.88	24.05	23.82
GPRS(GMSK,1 Tx slot)	33.00	32.80	32.94	32.64	23.97	23.77	23.91	23.61
GPRS(GMSK,2 Tx slot)	32.50	32.05	32.15	31.92	26.48	26.03	26.13	25.90
GPRS(GMSK,3 Tx slot)	30.50	30.27	30.35	30.08	26.24	26.01	26.09	25.82
GPRS(GMSK,4 Tx slot)	29.50	29.13	29.27	28.96	26.49	26.12	26.26	25.95

Band GSM1900	Burst-Averaged output Power (dBm)				Frame-Averaged output Power (dBm)			
Tx Channel	Tune-up (dBm)	512	661	810	Tune-up	512	661	810
Frequency (MHz)		1850.2	1880	1909.8		1850.2	1880	1909.8
GSM (GMSK)	21.00	20.62	20.37	20.86	11.97	11.59	11.34	11.83
GPRS(GMSK,1 Tx slot)	21.00	20.67	20.36	20.84	11.97	11.64	11.33	11.81
GPRS(GMSK,2 Tx slot)	20.50	20.20	19.80	20.21	14.48	14.18	13.78	14.19
GPRS(GMSK,3 Tx slot)	19.00	18.87	18.31	18.66	14.74	14.61	14.05	14.40
GPRS(GMSK,4 Tx slot)	18.00	17.94	17.32	17.71	14.99	14.93	14.31	14.70

7.2. WCDMA Conducted Power

WCDMA Band 2	Burst-Averaged output Power (dBm)			
Tx Channel	Tune-up (dBm)	9262	9400	9538
Frequency (MHz)		1852.4	1880	1907.6
RMC12.2K	24.00	23.03	23.47	23.68
HSDPA Sub 1	23.00	22.02	22.46	22.72
HSDPA Sub 2	22.50	21.21	22.01	22.33
HSDPA Sub 3	21.50	20.32	20.93	21.07
HSDPA Sub 4	21.50	20.47	21.02	21.27
HSUPA Sub 1	22.50	20.97	22.25	22.49
HSUPA Sub 2	23.00	21.88	22.33	22.57
HSUPA Sub 3	21.50	20.29	21.06	21.22
HSUPA Sub 4	23.00	21.96	22.43	22.65
HSUPA Sub 5	22.00	20.64	21.77	21.63

WCDMA Band 4		Burst-Averaged output Power (dBm)			
Tx Channel	Tune-up (dBm)	1312	1413	1513	
Frequency (MHz)		1712.4	1732.6	1752.6	
RMC12.2K	23.00	22.71	22.39	22.18	
HSDPA Sub 1	22.00	21.81	21.49	21.29	
HSDPA Sub 2	21.50	21.39	21.04	20.73	
HSDPA Sub 3	21.00	20.57	19.57	19.33	
HSDPA Sub 4	20.50	19.93	19.89	20.10	
HSUPA Sub 1	21.50	20.94	21.21	20.97	
HSUPA Sub 2	22.00	21.72	21.18	21.20	
HSUPA Sub 3	20.00	19.78	19.99	19.82	
HSUPA Sub 4	22.00	21.75	21.45	21.26	
HSUPA Sub 5	21.00	20.17	20.52	20.44	
WCDMA Band 5		Burst-Averaged output Power (dBm)			
Tx Channel	Tune-up (dBm)	4132	4182	4233	
Frequency (MHz)		826.4	836.4	846.6	
RMC12.2K	22.50	22.14	22.01	22.03	
HSDPA Sub 1	21.50	21.19	21.08	21.12	
HSDPA Sub 2	21.00	20.87	20.50	20.72	
HSDPA Sub 3	20.00	19.73	19.68	19.67	
HSDPA Sub 4	20.00	19.34	19.76	19.85	
HSUPA Sub 1	21.00	20.24	20.86	20.95	
HSUPA Sub 2	21.50	21.09	20.86	20.95	
HSUPA Sub 3	20.00	19.51	19.90	19.75	
HSUPA Sub 4	21.50	21.19	21.10	21.11	
HSUPA Sub 5	20.50	19.50	20.19	20.49	

7.3. LTE Conducted Power

Band	Band Width	Modulation	RB Configuration		Tune-up (dBm)	Channel/Frequency(MHz)		
			RB Size	RB Offset		18607/1850.7	18900/1880	19193/1909.3
LTE Band 2	1.4MHz	QPSK	1	0	21.50	20.88	21.14	21.10
			1	2	21.50	20.93	21.21	21.22
			1	5	21.50	20.76	21.04	21.10
			3	0	21.50	20.92	21.19	21.17
			3	1	21.50	20.87	21.18	21.20
			3	2	21.50	20.82	21.15	21.18
		16QAM	6	0	20.50	19.84	20.20	20.22
			1	0	20.50	20.04	20.37	20.28
			1	2	20.50	19.96	20.43	20.35
			1	5	20.50	19.93	20.28	20.27
			3	0	20.50	19.87	20.20	20.17
			3	1	20.50	19.80	20.19	20.20
			3	2	20.50	19.70	20.15	20.22
			6	0	19.50	18.84	19.20	19.19
Band	Band Width	Modulation	RB Configuration		Tune-up (dBm)	Channel/Frequency(MHz)		
			RB Size	RB Offset		18615/1851.5	18900/1880	19185/1908.5
LTE Band 2	3MHz	QPSK	1	0	21.50	20.79	21.21	20.88
			1	7	21.50	20.64	21.08	20.95
			1	14	21.50	20.48	20.93	21.07
			8	0	20.50	19.70	20.16	19.77
			8	4	20.50	19.66	20.16	20.15
			8	7	20.50	19.56	20.08	20.12
			15	0	20.50	19.66	20.10	20.06
		16QAM	1	0	20.50	19.91	20.34	19.93
			1	7	20.50	19.80	20.35	20.12
			1	14	20.50	19.64	20.12	19.98
			8	0	19.50	18.67	19.12	18.47
			8	4	19.50	18.62	19.14	19.12
			8	7	19.50	18.53	19.05	19.13
			15	0	19.50	18.58	19.05	19.00
Band	Band Width	Modulation	RB Configuration		Tune-up (dBm)	Channel/Frequency(MHz)		

2			1	74	21.00	19.49	19.45	20.50			
			36	0	20.00	18.85	19.73	18.40			
			36	18	20.00	18.58	19.58	18.85			
			36	37	20.00	18.36	19.24	19.49			
			75	0	20.00	18.70	19.50	19.07			
		16QAM	1	0	20.00	19.31	19.82	18.11			
			1	37	20.00	18.73	19.84	18.98			
			1	74	20.00	18.71	18.66	19.66			
			36	0	19.00	17.79	18.66	17.33			
			36	18	19.00	17.54	18.52	17.80			
			36	37	19.00	17.29	18.19	18.43			
			75	0	18.50	17.60	18.41	17.99			
			Band	Band Width	Modulation	RB Configuration		Tune-up (dBm)	Channel/Frequency(MHz)		
						RB Size	RB Offset		18700/1860	18900/1880	19100/1900
LTE Band 2	20MHz	QPSK	1	0	21.00	19.93	20.15	20.77			
			1	49	21.00	19.53	20.69	20.41			
			1	99	21.00	19.81	20.85	20.30			
			50	0	20.00	18.95	19.58	18.64			
			50	24	20.00	18.57	19.61	18.55			
			50	49	20.00	18.48	19.26	19.52			
		16QAM	100	0	19.50	18.76	19.38	19.08			
			1	0	20.00	19.12	19.37	18.99			
			1	49	20.00	18.71	19.87	18.62			
			1	99	20.00	19.08	18.05	19.52			
			50	0	19.00	17.87	18.49	17.59			
			50	24	19.00	17.51	18.51	17.49			
			50	49	19.00	17.39	18.20	18.45			
			100	0	18.50	17.68	18.29	18.01			

Band	Band Width	Modulation	RB Configuration		Tune-up (dBm)	Channel/Frequency(MHz)		
			RB Size	RB Offset		19957/1710.7	20175/1732.5	20393/1754.3
LTE Band 4	1.4MHz	QPSK	1	0	21.50	20.98	20.07	20.42
			1	2	21.50	21.08	20.20	20.50
			1	5	21.50	20.96	20.08	20.35
			3	0	21.50	21.06	20.12	20.47
			3	1	21.50	21.07	20.14	20.48

			3	2	21.50	21.05	20.15	20.43
			6	0	20.50	20.12	19.23	18.53
		16QAM	1	0	20.50	20.10	19.28	18.61
			1	2	20.50	20.24	19.50	18.79
			1	5	20.50	20.11	19.37	18.67
			3	0	20.50	19.99	19.13	19.54
			3	1	20.50	20.05	19.20	19.47
			3	2	20.50	20.05	19.15	19.50
			6	0	19.50	19.07	18.24	17.57
Band	Band Width		Modulation	RB Configuration		Tune-up (dBm)	Channel/Frequency(MHz)	
		RB Size		RB Offset	19965/1711.5		20175/1732.5	20385/1753.5
LTE Band 4	3MHz	QPSK	1	0	21.00	21.00	20.09	19.60
			1	7	21.00	20.98	20.14	19.50
			1	14	21.00	20.93	20.17	19.42
			8	0	20.50	20.09	19.20	18.63
			8	4	20.50	20.10	19.24	18.61
			8	7	20.50	20.07	19.24	18.55
			15	0	20.50	20.07	19.21	18.59
		16QAM	1	0	20.50	20.18	19.30	18.89
			1	7	20.50	20.20	19.43	18.70
			1	14	20.50	20.09	19.35	18.63
			8	0	19.50	19.09	18.16	17.61
			8	4	19.50	19.07	18.23	17.58
			8	7	19.50	19.03	18.21	17.53
			15	0	19.00	19.00	18.15	17.54
Band	Band Width	Modulation	RB Configuration		Tune-up (dBm)	Channel/Frequency(MHz)		
			RB Size	RB Offset		19975/1712.5	20175/1732.5	20375/1752.5
LTE Band 4	5MHz	QPSK	1	0	21.00	20.91	19.97	19.67
			1	12	21.00	20.97	20.16	19.60
			1	24	21.00	20.68	20.12	19.35
			12	0	20.50	20.08	19.17	18.77
			12	6	20.50	20.08	19.25	18.69
			12	11	20.50	19.89	19.21	18.54
			25	0	20.50	20.01	19.21	18.69
		16QAM	1	0	20.50	20.15	19.21	18.87
			1	12	20.50	20.21	19.39	18.89

Band	Band Width	Modulation	RB Configuration		Tune-up (dBm)	Channel/Frequency(MHz)		
			RB Size	RB Offset		20000/1715	20175/1732.5	20350/1750
			1	24	20.50	19.87	19.40	18.59
			12	0	19.50	19.05	18.11	17.71
			12	6	19.50	19.04	18.21	17.65
			12	11	19.50	18.87	18.18	17.55
			25	0	19.00	18.95	18.14	17.64
LTE Band 4	10MHz	QPSK	1	0	21.50	21.03	20.08	20.13
			1	24	21.50	20.91	20.27	20.94
			1	49	21.50	20.42	20.28	20.46
			25	0	20.50	20.13	19.19	19.09
			25	12	20.50	19.94	19.29	18.96
			25	24	20.50	19.77	19.34	18.72
		16QAM	50	0	20.00	19.98	19.27	18.93
			1	0	20.50	20.30	19.30	19.33
			1	24	20.50	20.17	19.48	19.15
			1	49	20.50	19.70	19.49	18.78
			25	0	19.50	19.04	18.12	18.01
			25	12	19.50	18.87	18.24	17.89
			25	24	19.50	18.70	18.26	17.65
			50	0	19.00	18.90	18.20	17.86
Band	Band Width	Modulation	RB Configuration		Tune-up (dBm)	Channel/Frequency(MHz)		
			RB Size	RB Offset		20025/1717.5	20175/1732.5	20325/1747.5
LTE Band 4	15MHz	QPSK	1	0	21.00	20.96	20.01	20.21
			1	37	21.00	20.61	20.19	20.02
			1	74	21.00	20.11	20.26	19.42
			36	0	20.00	19.98	19.11	19.26
			36	18	20.00	19.69	19.28	19.09
			36	37	20.00	19.46	19.33	18.80
		16QAM	75	0	20.00	19.75	19.25	19.04
			1	0	20.50	20.14	19.18	19.40
			1	37	20.50	19.89	19.47	19.13
			1	74	20.50	19.39	19.51	18.62
			36	0	19.00	18.94	18.06	18.20
			36	18	19.00	18.62	18.20	18.03
			36	37	19.00	18.38	18.27	17.76

Band	Band Width	Modulation	RB Configuration		Tune-up (dBm)	Channel/Frequency(MHz)		
			RB Size	RB Offset		20050/1720	20175/1732.5	20300/1745
			75	0	19.00	18.66	18.18	17.97
LTE Band 4	20MHz	QPSK	1	0	21.00	20.76	19.89	19.98
			1	49	21.00	20.45	20.20	20.25
			1	99	21.00	19.84	20.07	19.23
			50	0	20.00	19.90	19.13	19.45
			50	24	20.00	19.59	19.32	19.28
			50	49	20.00	19.44	19.36	18.98
			100	0	20.00	19.62	19.22	19.18
		16QAM	1	0	20.00	19.92	19.15	19.23
			1	49	20.00	19.76	19.45	19.53
			1	99	20.00	19.06	19.28	18.51
			50	0	19.00	18.82	18.05	18.37
			50	24	19.00	18.49	18.24	18.21
			50	49	19.00	18.38	18.31	17.89
			100	0	19.00	18.54	18.14	18.08

Band	Band Width	Modulation	RB Configuration		Tune-up (dBm)	Channel/Frequency(MHz)		
			RB Size	RB Offset		20407/824.7	20525/836.5	20643/848.3
LTE Band 5	1.4MHz	QPSK	1	0	22.00	21.48	21.78	21.69
			1	2	22.00	21.60	21.89	21.75
			1	5	22.00	21.49	21.79	21.67
			3	0	22.00	21.59	21.83	21.73
			3	1	22.00	21.58	21.87	21.74
			3	2	22.00	21.55	21.83	21.73
			6	0	21.00	20.53	20.81	20.71
		16QAM	1	0	21.50	20.80	21.02	20.88
			1	2	21.50	20.92	21.06	21.04
			1	5	21.50	20.84	21.02	20.85
			3	0	21.00	20.61	20.85	20.65
			3	1	21.00	20.58	20.83	20.69
			3	2	21.00	20.53	20.86	20.70
			6	0	20.00	19.67	19.98	19.76
Band	Band Width	Modulation	RB Configuration		Tune-up (dBm)	Channel/Frequency(MHz)		

5			1	49	22.00	21.30	21.40	21.37	
			25	0	21.00	20.32	20.51	20.63	
			25	12	21.00	20.50	20.70	20.86	
			25	24	21.00	20.53	20.82	20.69	
			50	0	21.00	20.38	20.70	20.88	
	16QAM			1	0	21.50	20.50	20.70	21.08
				1	24	21.50	20.57	20.77	21.17
				1	49	21.50	20.74	20.53	20.61
				25	0	20.00	19.27	19.56	19.59
				25	12	20.00	19.46	19.69	19.91
				25	24	20.00	19.55	19.90	19.81
				50	0	20.00	19.60	19.98	20.00

Band	Band Width	Modulation	RB Configuration		Tune-up (dBm)	Channel/Frequency(MHz)		
			RB Size	RB Offset		20775/2502.5	21100/2535	21425/2567.5
LTE Band 7	5MHz	QPSK	1	0	23.00	21.38	21.35	22.19
			1	12	23.00	21.64	21.68	22.61
			1	24	23.00	21.58	21.71	22.61
			12	0	22.00	20.56	20.54	21.50
			12	6	22.00	20.66	20.72	21.65
			12	11	22.00	20.62	20.77	21.67
			25	0	22.00	20.59	20.70	21.63
		16QAM	1	0	22.00	20.50	20.60	21.36
			1	12	22.00	20.43	20.84	21.69
			1	24	22.00	20.32	20.88	21.77
			12	0	21.00	19.02	19.57	20.45
			12	6	21.00	19.14	19.72	20.62
			12	11	21.00	19.09	19.77	20.61
			25	0	21.00	19.06	19.66	20.57
Band	Band Width	Modulation	RB Configuration		Tune-up (dBm)	Channel/Frequency(MHz)		
			RB Size	RB Offset		20800/2505	21100/2535	21400/2565
LTE Band 7	10MHz	QPSK	1	0	23.00	21.07	21.30	21.82
			1	24	23.00	21.32	21.77	22.37
			1	49	23.00	21.29	22.01	22.71
			25	0	22.00	20.30	20.55	21.19
			25	12	22.00	20.33	20.79	21.43

Band	Band Width	Modulation	RB Configuration		Tune-up (dBm)	Channel/Frequency(MHz)		
			RB Size	RB Offset		20825/2507.5	21100/2535	21375/2562.5
		16QAM	25	24	22.00	20.36	20.97	21.59
			50	0	21.50	20.34	20.80	21.38
			1	0	22.00	20.26	20.51	20.90
			1	24	22.00	20.59	21.01	21.51
			1	49	22.00	20.55	21.18	21.78
			25	0	21.00	19.24	19.51	20.12
			25	12	21.00	19.28	19.74	20.36
			25	24	21.00	19.30	19.92	20.52
			50	0	20.50	19.28	19.72	20.31
Band	Band Width	Modulation	RB Configuration		Tune-up (dBm)	Channel/Frequency(MHz)		
			RB Size	RB Offset		20825/2507.5	21100/2535	21375/2562.5
LTE Band 7	15MHz	QPSK	1	0	23.00	21.02	21.09	21.58
			1	37	23.00	21.36	21.73	22.05
			1	74	23.00	21.20	22.03	22.59
			36	0	21.50	20.33	20.48	20.85
			36	18	21.50	20.40	20.77	21.14
			36	37	21.50	20.36	21.03	21.40
			75	0	21.50	20.36	20.74	21.16
		16QAM	1	0	22.00	20.26	20.20	20.70
			1	37	22.00	20.52	20.90	21.22
			1	74	22.00	20.35	21.24	21.68
			36	0	20.50	19.31	19.43	19.78
			36	18	20.50	19.37	19.73	20.08
			36	37	20.50	19.34	20.01	20.35
			75	0	20.50	19.32	19.69	20.07
Band	Band Width	Modulation	RB Configuration		Tune-up (dBm)	Channel/Frequency(MHz)		
			RB Size	RB Offset		20850/2510	21100/2535	21350/2560
LTE Band 7	20MHz	QPSK	1	0	22.50	20.85	20.83	21.50
			1	49	22.50	21.48	21.78	21.85
			1	99	22.50	22.47	22.48	22.49
			50	0	21.50	20.43	20.39	20.77
			50	24	21.50	20.47	20.82	20.96
			50	49	21.50	20.32	21.01	21.23
			100	0	21.00	20.36	20.69	20.97
		16QAM	1	0	21.50	20.03	20.03	20.69
			1	49	21.50	20.65	20.96	21.05

Band	Band Width	Modulation	RB Configuration		Tune-up (dBm)	Channel/Frequency(MHz)		
			RB Size	RB Offset		37825/2577.5	38000/2595	38175/2612.5
			25	24	22.00	21.63	21.77	21.66
			50	0	22.00	21.75	21.66	21.76
LTE Band 38	15MHz	QPSK	1	0	24.50	23.60	23.17	23.81
			1	37	24.50	23.64	23.65	23.82
			1	74	24.50	23.17	24.12	23.91
			36	0	23.50	22.84	22.55	23.11
			36	18	23.50	22.75	22.81	22.96
			36	37	23.50	22.47	22.98	22.78
			75	0	23.00	22.69	22.79	23.00
		16QAM	1	0	23.00	22.61	22.11	22.95
			1	37	23.00	22.64	22.62	22.73
			1	74	23.00	22.12	22.88	22.45
			36	0	22.00	21.66	21.34	21.93
			36	18	22.00	21.56	21.59	21.76
			36	37	22.00	21.29	21.76	21.59
			75	0	22.00	21.51	21.56	21.79
Band	Band Width	Modulation	RB Configuration		Tune-up (dBm)	Channel/Frequency(MHz)		
			RB Size	RB Offset		37850/2580	38000/2595	38150/2610
LTE Band 38	20MHz	QPSK	1	0	24.50	23.45	23.01	23.89
			1	49	24.50	23.58	23.67	23.74
			1	99	24.50	22.93	24.30	23.88
			50	0	23.50	22.89	22.64	23.37
			50	24	23.50	22.71	22.90	23.22
			50	49	23.50	22.39	23.07	22.92
			100	0	23.50	22.64	22.80	23.13
		16QAM	1	0	23.00	22.47	21.94	22.79
			1	49	23.00	22.55	22.70	22.92
			1	99	23.00	21.88	22.72	22.27
			50	0	22.50	21.70	21.42	22.16
			50	24	22.50	21.53	21.67	21.98
			50	49	22.50	21.20	21.86	21.70
			100	0	22.00	21.46	21.60	21.95

Band	Band	Modulation	RB	Tune-u	Channel/Frequency(MHz)
------	------	------------	----	--------	------------------------

	Width		Configuration		p (dBm)			
			RB Size	RB Offset		131979/1710.7	132322/1745	132665/177 9.3
LTE Band 66	1.4MHz	QPSK	1	0	22.00	21.40	20.74	20.68
			1	2	22.00	21.51	20.87	20.81
			1	5	22.00	21.40	20.72	20.67
			3	0	22.00	21.46	20.81	20.73
			3	1	22.00	21.51	20.83	20.78
			3	2	22.00	21.50	20.80	20.75
		16QAM	6	0	21.00	20.53	19.88	19.84
			1	0	21.00	20.66	19.92	19.95
			1	2	21.00	20.76	20.03	19.91
			1	5	21.00	20.58	19.93	19.92
			3	0	21.00	20.51	19.84	19.78
			3	1	21.00	20.53	19.84	19.85
			3	2	21.00	20.49	19.77	19.78
6	0	20.00	19.55	18.91	18.85			
Band	Band Width	Modulation	RB Configuration		Tune-u p (dBm)	Channel/Frequency(MHz)		
			RB Size	RB Offset		131987/1711.5	132322/1745	132657/177 8.5
LTE Band 66	3MHz	QPSK	1	0	21.50	21.42	20.82	20.68
			1	7	21.50	21.46	20.79	20.76
			1	14	21.50	21.40	20.69	20.71
			8	0	21.00	20.53	19.91	19.82
			8	4	21.00	20.55	19.90	19.85
			8	7	21.00	20.51	19.84	19.81
			15	0	21.00	20.53	19.86	19.83
		16QAM	1	0	21.00	20.70	20.03	19.92
			1	7	21.00	20.75	19.94	20.02
			1	14	21.00	20.68	19.87	19.96
			8	0	20.00	19.53	18.86	18.77
			8	4	20.00	19.53	18.90	18.83
			8	7	20.00	19.49	18.85	18.78
15	0	19.50	19.45	18.80	18.73			
Band	Band Width	Modulation	RB Configuration		Tune-u p (dBm)	Channel/Frequency(MHz)		
			RB Size	RB Offset		131997/1712.5	132322/1745	132647/177 7.5
LTE	5MHz	QPSK	1	0	21.50	21.31	20.70	20.46

Band 66			1	12	21.50	21.46	20.78	20.72
			1	24	21.50	21.21	20.51	20.59
			12	0	21.00	20.51	19.89	19.75
			12	6	21.00	20.57	19.91	19.85
			12	11	21.00	20.40	19.79	19.78
			25	0	21.00	20.50	19.86	19.77
			25	12	21.00	20.40	19.79	19.78
		16QAM	1	0	21.00	20.61	19.89	19.68
			1	12	21.00	20.58	20.00	19.86
			1	24	21.00	20.42	19.80	19.86
			12	0	20.00	19.46	18.84	18.72
			12	6	20.00	19.51	18.86	18.80
			12	11	20.00	19.35	18.76	18.72
			25	0	19.50	19.44	18.80	18.70
Band	Band Width	Modulation	RB Configuration		Tune-up (dBm)	Channel/Frequency(MHz)		
			RB Size	RB Offset		132022/1715	132322/1745	132622/1775
LTE Band 66	10MHz	QPSK	1	0	21.50	21.42	20.79	20.23
			1	24	21.50	21.44	20.82	20.69
			1	49	21.50	20.94	20.47	20.70
			25	0	21.00	20.58	19.90	19.60
			25	12	21.00	20.46	19.92	19.73
			25	24	21.00	20.29	19.78	19.74
			50	0	20.50	20.45	19.88	19.66
		16QAM	1	0	21.00	20.58	20.10	19.38
			1	24	21.00	20.58	19.98	19.93
			1	49	21.00	20.22	19.71	19.92
			25	0	20.00	19.50	18.83	18.52
			25	12	20.00	19.36	18.82	18.64
			25	24	20.00	19.24	18.72	18.65
			50	0	19.50	19.37	18.80	18.56
Band	Band Width	Modulation	RB Configuration		Tune-up (dBm)	Channel/Frequency(MHz)		
			RB Size	RB Offset		132047/1717.5	132322/1745	132597/1772.5
LTE Band 66	15MHz	QPSK	1	0	21.50	21.37	20.69	19.75
			1	37	21.50	21.15	20.80	20.37
			1	74	21.50	20.55	20.22	20.56
			36	0	21.00	20.50	19.91	19.20
			36	18	21.00	20.24	19.89	19.44

Band	Band Width	Modulation	RB Configuration		Tune-up p (dBm)	Channel/Frequency(MHz)		
			RB Size	RB Offset		132072/1720	132322/1745	132572/1770
LTE Band 66	20MHz	16QAM	36	37	21.00	19.97	19.65	19.58
			75	0	20.50	20.25	19.84	19.41
			1	0	21.00	20.61	19.90	19.05
			1	37	21.00	20.36	20.06	19.54
			1	74	21.00	19.89	19.47	19.79
			36	0	19.50	19.46	18.87	18.14
			36	18	19.50	19.18	18.82	18.39
			36	37	19.50	18.89	18.61	18.53
			75	0	19.50	19.18	18.76	18.33
		QPSK	1	0	21.50	21.15	20.39	20.46
			1	49	21.50	21.02	20.84	20.24
			1	99	21.50	20.22	19.82	20.38
			50	0	20.50	20.41	19.97	18.99
			50	24	20.50	20.09	19.93	19.31
			50	49	20.50	19.91	19.62	19.50
			100	0	20.50	20.13	19.79	19.23
16QAM	1		0	20.50	20.32	19.62	18.68	
	1		49	20.50	20.23	20.09	19.48	
	1	99	20.50	19.51	19.01	19.68		
	50	0	19.50	19.35	18.93	17.93		
	50	24	19.50	19.00	18.85	18.22		
	50	49	19.50	18.83	18.54	18.40		
	100	0	19.50	19.06	18.73	18.14		

7.4. WLAN & Bluetooth Output Power

Mode	Channel	Frequency (MHz)	Tune-up (dBm)	Output Power (dBm)
802.11b	1	2412	15.00	14.00
	6	2437	15.00	14.64
	11	2462	15.00	14.43
802.11g	1	2412	11.50	11.00
	6	2437	11.50	11.21
	11	2462	11.50	10.56
802.11n HT20	1	2412	11.00	11.00
	6	2437	11.00	10.95
	11	2462	11.00	10.63
802.11n HT40	3	2422	13.00	12.58
	6	2437	13.00	12.20
	9	2452	13.00	12.25

NOTE: Power measurement results of WLAN 2.4G.

BR+EDR	Output Power (dBm)				
	Channel	Tune-up (dBm)	Data Rates		
			1M	2M	3M
	0CH	1.00	0.78	0.84	0.95
	39CH	3.00	2.04	1.47	1.64
	78CH	2.00	1.22	0.39	0.64

BLE	Channel	Tune-up (dBm)	Output Power (dBm)
			1M
	0CH	1.00	0.45
	19CH	2.00	1.88
39CH	2.00	1.01	

NOTE: Power measurement results of Bluetooth.

Bluetooth	3.00	2.00	5	2.480	0.6	3	Yes
-----------	------	------	---	-------	-----	---	-----

NOTE: Standalone SAR test exclusion for Bluetooth.

When standalone SAR test exclusion applies to an antenna that transmits simultaneously with other antennas, the standalone SAR must be estimated according to following to determine simultaneous transmission SAR test exclusion:

$$[(\text{max. power of channel, including tune-up tolerance, mW}) / (\text{min. test separation distance, mm})] * [\sqrt{f_{\text{GHz}}/x}] \text{ W/kg}$$
 for test separation distances $\leq 50\text{mm}$, where $x = 7.5$ for 1-g SAR and $x = 18.75$ for 10-g SAR.

When the minimum test separation distance is $< 5 \text{ mm}$, a distance of 5 mm is applied to determine SAR test exclusion.

Mode	Position	P_{max} (dBm)	P_{max} (mW)	Distance (mm)	f (GHz)	x	Estimated SAR (W/Kg)
Bluetooth	Head	3.00	2.00	5	2.48	7.5	0.084
Bluetooth	Body	3.00	2.00	10	2.48	7.5	0.042
Bluetooth	Hotspot	3.00	2.00	10	2.48	7.5	0.042

NOTE: Estimated SAR calculation for Bluetooth

10. SAR Results

10.1. SAR measurement Result

10.1.1. SAR measurement Result of GSM850

Test Position of Head	Test channel /Freq.	Mode	SAR Value (W/kg)		Power Drift(%)	Conducted Power (dBm)	Tune-up Power (dBm)	Scaled SAR 1-g (W/Kg)	Date	Plot
			1-g	10-g						
Left Cheek	189/836.4	GPRS(GMSK 4TS)	0.177	0.134	1.27	29.27	29.50	0.187	2024/1/10	1#
Left Tilt 15 Degree	189/836.4	GPRS(GMSK 4TS)	0.089	0.065	-2.46	29.27	29.50	0.094	2024/1/10	
Right Cheek	189/836.4	GPRS(GMSK 4TS)	0.153	0.111	-2.40	29.27	29.50	0.161	2024/1/10	
Right Tilt 15 Degree	189/836.4	GPRS(GMSK 4TS)	0.079	0.059	3.65	29.27	29.50	0.083	2024/1/10	

NOTE: Head SAR test results of GSM850.

Test	Test	Test Mode	SAR Value	Power	Conducted	Tune-up	Scaled	Date	Plot
------	------	-----------	-----------	-------	-----------	---------	--------	------	------

Position of Body-Worn with 10mm	channel /Freq.		(W/kg)		Drift (±5%)	power (dBm)	power (dBm)	SAR 1g (W/Kg)		
			1g	10g						
Front Side	189/836.4	GPRS(GMSK 4TS)	0.138	0.099	-1.45	29.27	29.50	0.146	2024/1/10	
Back Side	189/836.4	GPRS(GMSK 4TS)	0.228	0.170	-0.51	29.27	29.50	0.240	2024/1/10	2#

NOTE: Body-Worn SAR test results of GSM850

Test Position of Hotspot with 10mm	Test channel /Freq.	Mode	SAR Value (W/kg)		Power Drift(%)	Conducted Power (dBm)	Tune-up Power (dBm)	Scaled SAR 1-g (W/Kg)	Date	Plot
			1-g	10-g						
Front Side	189/836.4	GPRS(GMSK 4TS)	0.138	0.099	-1.45	29.27	29.50	0.146	2024/1/10	
Back Side	189/836.4	GPRS(GMSK 4TS)	0.228	0.170	-0.51	29.27	29.50	0.240	2024/1/10	2#
Left Side	189/836.4	GPRS(GMSK 4TS)	0.069	0.049	2.09	29.27	29.50	0.073	2024/1/10	
Right Side	189/836.4	GPRS(GMSK 4TS)	0.078	0.056	-0.64	29.27	29.50	0.082	2024/1/10	
Bottom Side	189/836.4	GPRS(GMSK 4TS)	0.115	0.086	-1.54	29.27	29.50	0.121	2024/1/10	

NOTE: Hotspot SAR test results of GSM850

10.1.2. SAR measurement Result of GSM1900

Test Position of Head	Test channel /Freq.	Mode	SAR Value (W/kg)		Power Drift(%)	Conducted Power (dBm)	Tune-up Power (dBm)	Scaled SAR 1-g (W/Kg)	Date	Plot
			1-g	10-g						
Left Cheek	661/1880	GPRS(GMSK 4TS)	0.164	0.104	-2.43	17.32	18.00	0.192	2024/1/11	3#
Left Tilt 15 Degree	661/1880	GPRS(GMSK 4TS)	0.084	0.051	-1.30	17.32	18.00	0.098	2024/1/11	
Right Cheek	661/1880	GPRS(GMSK 4TS)	0.144	0.091	-0.11	17.32	18.00	0.168	2024/1/11	
Right Tilt 15 Degree	661/1880	GPRS(GMSK 4TS)	0.079	0.050	-3.54	17.32	18.00	0.092	2024/1/11	

NOTE: Head SAR test results of GSM1900

Test Position of	Test channel	Test Mode	SAR Value (W/kg)	Power Drift	Conducted power	Tune-up power	Scaled SAR	Date	Plot
------------------	--------------	-----------	------------------	-------------	-----------------	---------------	------------	------	------

Body-Worn with 10mm	/Freq.		1g	10g	(±5%)	(dBm)	(dBm)	1g (W/Kg)		
Front Side	661/1880	GPRS(GMSK 4TS)	0.360	0.189	0.87	17.32	18.00	0.421	2024/1/11	
Back Side	661/1880	GPRS(GMSK 4TS)	0.581	0.314	-0.57	17.32	18.00	0.679	2024/1/11	4#

NOTE: Body-Worn SAR test results of GSM1900

Test Position of Hotspot with 10mm	Test channel /Freq.	Mode	SAR Value (W/kg)		Power Drift(%)	Conducted Power (dBm)	Tune-up Power (dBm)	Scaled SAR 1-g (W/Kg)	Date	Plot
			1-g	10-g						
Front Side	661/1880	GPRS(GMSK 4TS)	0.360	0.189	0.87	17.32	18.00	0.421	2024/1/11	
Back Side	661/1880	GPRS(GMSK 4TS)	0.581	0.314	-0.57	17.32	18.00	0.679	2024/1/11	4#
Left Side	661/1880	GPRS(GMSK 4TS)	0.180	0.092	0.94	17.32	18.00	0.211	2024/1/11	
Right Side	661/1880	GPRS(GMSK 4TS)	0.183	0.095	3.00	17.32	18.00	0.214	2024/1/11	
Bottom Side	661/1880	GPRS(GMSK 4TS)	0.295	0.155	-3.32	17.32	18.00	0.345	2024/1/11	

NOTE: Hotspot SAR test results of GSM1900

10.1.3. SAR measurement Result of WCDMA Band 2

Test Position of Head	Test channel /Freq	Mode	SAR Value (W/kg)		Power Drift(%)	Conducted Power (dBm)	Tune-up Power (dBm)	Scaled SAR 1-g (W/Kg)	Date	Plot
			1-g	10-g						
Left Cheek	9400/1880	RMC12.2K	0.129	0.081	4.85	23.47	24.00	0.146	2024/1/11	5#
Left Tilt 15 Degree	9400/1880	RMC12.2K	0.073	0.044	0.92	23.47	24.00	0.082	2024/1/11	
Right Cheek	9400/1880	RMC12.2K	0.112	0.067	-2.04	23.47	24.00	0.127	2024/1/11	
Right Tilt 15	9400/1880	RMC12.2K	0.055	0.033	0.74	23.47	24.00	0.062	2024/1/11	

Degree										
--------	--	--	--	--	--	--	--	--	--	--

NOTE: Head SAR test results of WCDMA Band 2

Test Position of Body-Worn with 10mm	Test channel /Freq.	Test Mode	SAR Value (W/kg)		Power Drift ($\pm 5\%$)	Conducted power (dBm)	Tune-up power (dBm)	Scaled SAR 1g (W/Kg)	Date	Plot
			1g	10g						
Front Side	9400/1880	RMC12.2K	0.318	0.168	-2.14	23.47	24.00	0.359	2024/1/11	
Back Side	9400/1880	RMC12.2K	0.485	0.262	-2.72	23.47	24.00	0.548	2024/1/11	6#

NOTE: Body-Worn SAR test results of WCDMA Band 2

Test Position of Hotspot with 10mm	Test channel /Freq.	Mode	SAR Value (W/kg)		Power Drift(%)	Conducted Power (dBm)	Tune-up Power (dBm)	Scaled SAR 1-g (W/Kg)	Date	Plot
			1-g	10-g						
Front Side	9400/1880	RMC12.2K	0.318	0.168	-2.14	23.47	24.00	0.359	2024/1/11	
Back Side	9400/1880	RMC12.2K	0.485	0.262	-2.72	23.47	24.00	0.548	2024/1/11	6#
Left Side	9400/1880	RMC12.2K	0.156	0.081	1.51	23.47	24.00	0.176	2024/1/11	
Right Side	9400/1880	RMC12.2K	0.159	0.083	-2.37	23.47	24.00	0.180	2024/1/11	
Bottom Side	9400/1880	RMC12.2K	0.265	0.136	1.75	23.47	24.00	0.299	2024/1/11	

NOTE: Hotspot SAR test results of WCDMA Band 2

10.1.4. SAR measurement Result of WCDMA Band 4

Test Position of Head	Test channel /Freq	Mode	SAR Value (W/kg)		Power Drift(%)	Conducted Power (dBm)	Tune-up Power (dBm)	Scaled SAR 1-g (W/Kg)	Date	Plot
			1-g	10-g						
Left Cheek	1413/1732.6	RMC12.2K	0.111	0.075	2.32	22.39	23.00	0.128	2024/1/08	7#
Left Tilt 15 Degree	1413/1732.6	RMC12.2K	0.063	0.043	3.66	22.39	23.00	0.073	2024/1/08	
Right	1413/1732.6	RMC12.2K	0.099	0.064	-0.09	22.39	23.00	0.114	2024/1/08	

Cheek										
Right Tilt 15 Degree	1413/1732.6	RMC12.2K	0.052	0.035	-0.91	22.39	23.00	0.060	2024/1/08	

NOTE: Head SAR test results of WCDMA Band 4

Test Position of Body-Worn with 10mm	Test channel /Freq.	Test Mode	SAR Value (W/kg)		Power Drift (±5%)	Conducted power (dBm)	Tune-up power (dBm)	Scaled SAR 1g (W/Kg)	Date	Plot
			1g	10g						
Front Side	1413/1732.6	RMC12.2K	0.180	0.102	1.01	22.39	23.00	0.207	2024/1/08	
Back Side	1413/1732.6	RMC12.2K	0.270	0.155	-1.23	22.39	23.00	0.311	2024/1/08	8#

NOTE: Body-Worn SAR test results of WCDMA Band 4

Test Position of Hotspot with 10mm	Test channel /Freq.	Mode	SAR Value (W/kg)		Power Drift(%)	Conducted Power (dBm)	Tune-up Power (dBm)	Scaled SAR 1-g (W/Kg)	Date	Plot
			1-g	10-g						
Front Side	1413/1732.6	RMC12.2K	0.180	0.102	1.01	22.39	23.00	0.207	2024/1/08	
Back Side	1413/1732.6	RMC12.2K	0.270	0.155	-1.23	22.39	23.00	0.311	2024/1/08	8#
Left Side	1413/1732.6	RMC12.2K	0.087	0.047	-3.94	22.39	23.00	0.100	2024/1/08	
Right Side	1413/1732.6	RMC12.2K	0.081	0.043	-1.93	22.39	23.00	0.093	2024/1/08	
Bottom Side	1413/1732.6	RMC12.2K	0.140	0.077	-3.73	22.39	23.00	0.161	2024/1/08	

NOTE: Hotspot SAR test results of WCDMA Band 4

10.1.5. SAR measurement Result of WCDMA Band 5

Test Position of Head	Test channel /Freq	Mode	SAR Value (W/kg)		Power Drift(%)	Conducted Power (dBm)	Tune-up Power (dBm)	Scaled SAR 1-g (W/Kg)	Date	Plot
			1-g	10-g						
Left Cheek	4182/836.4	RMC12.2K	0.088	0.068	3.89	22.01	22.50	0.099	2024/1/10	9#
Left Tilt 15	4182/836.4	RMC12.2K	0.044	0.033	-2.39	22.01	22.50	0.049	2024/1/10	

Degree										
Right Cheek	4182/836.4	RMC12.2K	0.081	0.062	1.75	22.01	22.50	0.091	2024/1/10	
Right Tilt 15 Degree	4182/836.4	RMC12.2K	0.041	0.031	-3.65	22.01	22.50	0.046	2024/1/10	

NOTE: Head SAR test results of WCDMA Band 5

Test Position of Body-Worn with 10mm	Test channel /Freq.	Test Mode	SAR Value (W/kg)		Power Drift (±5%)	Conducted power (dBm)	Tune-up power (dBm)	Scaled SAR 1g (W/Kg)	Date	Plot
			1g	10g						
Front Side	4182/836.4	RMC12.2K	0.078	0.060	-0.86	22.01	22.50	0.087	2024/1/10	
Back Side	4182/836.4	RMC12.2K	0.111	0.086	-0.08	22.01	22.50	0.124	2024/1/10	10#

NOTE: Body-Worn SAR test results of WCDMA Band 5

Test Position of Hotspot with 10mm	Test channel /Freq.	Mode	SAR Value (W/kg)		Power Drift(%)	Conducted Power (dBm)	Tune-up Power (dBm)	Scaled SAR 1-g (W/Kg)	Date	Plot
			1-g	10-g						
Front Side	4182/836.4	RMC12.2K	0.078	0.060	-0.86	22.01	22.50	0.087	2024/1/10	
Back Side	4182/836.4	RMC12.2K	0.111	0.086	-0.08	22.01	22.50	0.124	2024/1/10	10#
Left Side	4182/836.4	RMC12.2K	0.036	0.028	-0.03	22.01	22.50	0.040	2024/1/10	
Right Side	4182/836.4	RMC12.2K	0.039	0.030	-3.55	22.01	22.50	0.044	2024/1/10	
Bottom Side	4182/836.4	RMC12.2K	0.080	0.060	1.57	22.01	22.50	0.090	2024/1/10	

NOTE: Hotspot SAR test results of WCDMA Band 5

10.1.6. SAR measurement Result of LTE Band 2

Test Position of Head	Test channel /Freq.	Mode	SAR Value (W/kg)		Power Drift(%)	Conducted Power (dBm)	Tune-up Power (dBm)	Scaled SAR 1-g (W/Kg)	Date	Plot
			1-g	10-g						
1RB										

Left Cheek	18900/1880	20M QPSK(1,99)	0.109	0.068	0.52	20.85	21.00	0.113	2024/1/11	13#
Left Tilt 15 Degree	18900/1880	20M QPSK(1,99)	0.062	0.038	2.61	20.85	21.00	0.064	2024/1/11	
Right Cheek	18900/1880	20M QPSK(1,99)	0.096	0.057	2.73	20.85	21.00	0.099	2024/1/11	
Right Tilt 15 Degree	18900/1880	20M QPSK(1,99)	0.052	0.032	-0.22	20.85	21.00	0.054	2024/1/11	
50%RB										
Left Cheek	18900/1880	20M QPSK(50,24)	0.065	0.040	-1.01	19.61	20.00	0.071	2024/1/11	
Left Tilt 15 Degree	18900/1880	20M QPSK(50,24)	0.034	0.022	3.77	19.61	20.00	0.037	2024/1/11	
Right Cheek	18900/1880	20M QPSK(50,24)	0.048	0.031	4.93	19.61	20.00	0.053	2024/1/11	
Right Tilt 15 Degree	18900/1880	20M QPSK(50,24)	0.030	0.017	-2.17	19.61	20.00	0.033	2024/1/11	

NOTE: Head SAR test results of LTE Band 2

Test Position of Body-Worn with 10mm	Test channel /Freq.	Test Mode	SAR Value (W/kg)		Power Drift (±5%)	Conducted power (dBm)	Tune-up power (dBm)	Scaled SAR 1g (W/Kg)	Date	Plot
			1g	10g						
1RB										
Front Side	18900/1880	20M QPSK(1,99)	0.270	0.142	-1.84	20.85	21.00	0.279	2024/1/11	
Back Side	18900/1880	20M QPSK(1,99)	0.442	0.238	-4.09	20.85	21.00	0.458	2024/1/11	14#
50%RB										
Front Side	18900/1880	20M QPSK(50,24)	0.156	0.078	-0.21	19.61	20.00	0.171	2024/1/11	
Back Side	18900/1880	20M QPSK(50,24)	0.237	0.133	0.17	19.61	20.00	0.259	2024/1/11	

NOTE: Body-Worn SAR test results of LTE Band 2

Test Position of Hotspot with	Test channel /Freq.	Mode	SAR Value (W/kg)		Power Drift(%)	Conducted Power (dBm)	Tune-up Power (dBm)	Scaled SAR 1-g (W/Kg)	Date	Plot
			1-g	10-g						

10mm										
1RB										
Front Side	18900/1880	20M QPSK(1,99)	0.270	0.142	-1.84	20.85	21.00	0.279	2024/1/11	
Back Side	18900/1880	20M QPSK(1,99)	0.442	0.238	-4.09	20.85	21.00	0.458	2024/1/11	14#
Left Side	18900/1880	20M QPSK(1,99)	0.135	0.071	-2.30	20.85	21.00	0.140	2024/1/11	
Right Side	18900/1880	20M QPSK(1,99)	0.144	0.076	-1.65	20.85	21.00	0.149	2024/1/11	
Bottom Side	18900/1880	20M QPSK(1,99)	0.245	0.129	-3.59	20.85	21.00	0.254	2024/1/11	
50%RB										
Front Side	18900/1880	20M QPSK(50,24)	0.156	0.078	-0.21	19.61	20.00	0.171	2024/1/11	
Back Side	18900/1880	20M QPSK(50,24)	0.237	0.133	0.17	19.61	20.00	0.259	2024/1/11	
Left Side	18900/1880	20M QPSK(50,24)	0.068	0.040	-1.06	19.61	20.00	0.074	2024/1/11	
Right Side	18900/1880	20M QPSK(50,24)	0.081	0.041	-3.94	19.61	20.00	0.089	2024/1/11	
Bottom Side	18900/1880	20M QPSK(50,24)	0.137	0.067	-1.85	19.61	20.00	0.150	2024/1/11	

NOTE: Hotspot SAR test results of LTE Band 2

10.1.7. SAR measurement Result of LTE Band 4

Test Position of Head	Test channel /Freq.	Mode	SAR Value (W/kg)		Power Drift(%)	Conducted Power (dBm)	Tune-up Power (dBm)	Scaled SAR 1-g (W/Kg)	Date	Plot
			1-g	10-g						
1RB										
Left Cheek	20175/1732.5	20M QPSK(1,0)	0.084	0.056	3.56	19.89	21.00	0.108	2024/1/08	15#
Left Tilt 15 Degree	20175/1732.5	20M QPSK(1,0)	0.048	0.031	3.92	19.89	21.00	0.062	2024/1/08	
Right Cheek	20175/1732.5	20M QPSK(1,0)	0.071	0.047	0.18	19.89	21.00	0.092	2024/1/08	

Right Tilt 15 Degree	20175/1732.5	20M QPSK(1,0)	0.036	0.024	-4.00	19.89	21.00	0.046	2024/1/08	
50%RB										
Left Cheek	20175/1732.5	20M QPSK(50,0)	0.049	0.029	0.98	19.13	20.00	0.060	2024/1/08	
Left Tilt 15 Degree	20175/1732.5	20M QPSK(50,0)	0.028	0.018	-1.87	19.13	20.00	0.034	2024/1/08	
Right Cheek	20175/1732.5	20M QPSK(50,0)	0.037	0.027	1.52	19.13	20.00	0.045	2024/1/08	
Right Tilt 15 Degree	20175/1732.5	20M QPSK(50,0)	0.019	0.013	-3.28	19.13	20.00	0.023	2024/1/08	

NOTE: Head SAR test results of LTE Band 4

Test Position of Body-Worn with 10mm	Test channel /Freq.	Test Mode	SAR Value (W/kg)		Power Drift (±5%)	Conducted power (dBm)	Tune-up power (dBm)	Scaled SAR 1g (W/Kg)	Date	Plot
			1g	10g						
1RB										
Front Side	20175/1732.5	20M QPSK(1,0)	0.138	0.077	-0.31	19.89	21.00	0.178	2024/1/08	
Back Side	20175/1732.5	20M QPSK(1,0)	0.191	0.110	-0.61	19.89	21.00	0.247	2024/1/08	16#
50%RB										
Front Side	20175/1732.5	20M QPSK(50,0)	0.075	0.039	-0.50	19.13	20.00	0.092	2024/1/08	
Back Side	20175/1732.5	20M QPSK(50,0)	0.098	0.059	-1.98	19.13	20.00	0.120	2024/1/08	

NOTE: Body-Worn SAR test results of LTE Band 4

Test Position of Hotspot with 10mm	Test channel /Freq.	Mode	SAR Value (W/kg)		Power Drift(%)	Conducted Power (dBm)	Tune-up Power (dBm)	Scaled SAR 1-g (W/Kg)	Date	Plot
			1-g	10-g						

1RB										
Front Side	20175/1732.5	20M QPSK(1,0)	0.138	0.077	-0.31	19.89	21.00	0.178	2024/1/08	
Back Side	20175/1732.5	20M QPSK(1,0)	0.191	0.110	-0.61	19.89	21.00	0.247	2024/1/08	16#
Left Side	20175/1732.5	20M QPSK(1,0)	0.066	0.038	-1.34	19.89	21.00	0.085	2024/1/08	
Right Side	20175/1732.5	20M QPSK(1,0)	0.064	0.037	1.33	19.89	21.00	0.083	2024/1/08	
Bottom Side	20175/1732.5	20M QPSK(1,0)	0.100	0.055	2.13	19.89	21.00	0.129	2024/1/08	
50%RB										
Front Side	20175/1732.5	20M QPSK(50,0)	0.075	0.039	-0.50	19.13	20.00	0.092	2024/1/08	
Back Side	20175/1732.5	20M QPSK(50,0)	0.098	0.059	-1.98	19.13	20.00	0.120	2024/1/08	
Left Side	20175/1732.5	20M QPSK(50,0)	0.035	0.021	-0.28	19.13	20.00	0.043	2024/1/08	
Right Side	20175/1732.5	20M QPSK(50,0)	0.033	0.021	3.52	19.13	20.00	0.040	2024/1/08	
Bottom Side	20175/1732.5	20M QPSK(50,0)	0.059	0.028	1.78	19.13	20.00	0.072	2024/1/08	

NOTE: Hotspot SAR test results of LTE Band 4

10.1.8. SAR measurement Result of LTE Band 5

Test Position of Head	Test channel /Freq.	Mode	SAR Value (W/kg)		Power Drift(%)	Conducted Power (dBm)	Tune-up Power (dBm)	Scaled SAR 1-g (W/Kg)	Date	Plot
			1-g	10-g						
1RB										
Left Cheek	20525/836.5	10M QPSK(1,0)	0.089	0.069	2.49	21.55	22.00	0.099	2024/1/10	17#
Left Tilt 15 Degree	20525/836.5	10M QPSK(1,0)	0.052	0.038	0.19	21.55	22.00	0.058	2024/1/10	
Right Cheek	20525/836.5	10M QPSK(1,0)	0.080	0.060	-3.10	21.55	22.00	0.089	2024/1/10	
Right	20525/836.5	10M QPSK(1,0)	0.041	0.032	-0.22	21.55	22.00	0.045	2024/1/10	

Tilt 15 Degree										
50%RB										
Left Cheek	20525/836.5	10M QPSK(25,12)	0.050	0.040	4.01	20.70	21.00	0.054	2024/1/10	
Left Tilt 15 Degree	20525/836.5	10M QPSK(25,12)	0.029	0.023	-4.62	20.70	21.00	0.031	2024/1/10	
Right Cheek	20525/836.5	10M QPSK(25,12)	0.044	0.031	0.40	20.70	21.00	0.047	2024/1/10	
Right Tilt 15 Degree	20525/836.5	10M QPSK(25,12)	0.022	0.018	2.62	20.70	21.00	0.024	2024/1/10	

NOTE: Head SAR test results of LTE Band 5

Test Position of Body-Worn with 10mm	Test channel /Freq.	Test Mode	SAR Value (W/kg)		Power Drift (±5%)	Conducted power (dBm)	Tune-up power (dBm)	Scaled SAR 1g (W/Kg)	Date	Plot
			1g	10g						
1RB										
Front Side	20525/836.5	10M QPSK(1,0)	0.078	0.060	0.64	21.55	22.00	0.087	2024/1/10	
Back Side	20525/836.5	10M QPSK(1,0)	0.113	0.088	0.28	21.55	22.00	0.125	2024/1/10	18#
50%RB										
Front Side	20525/836.5	10M QPSK(25,12)	0.043	0.034	0.21	20.70	21.00	0.046	2024/1/10	
Back Side	20525/836.5	10M QPSK(25,12)	0.059	0.052	0.25	20.70	21.00	0.063	2024/1/10	

NOTE: Body-Worn SAR test results of LTE Band 5

Test Position of Hotspot with 10mm	Test channel /Freq.	Mode	SAR Value (W/kg)		Power Drift(%)	Conducted Power (dBm)	Tune-up Power (dBm)	Scaled SAR 1-g (W/Kg)	Date	Plot
			1-g	10-g						

1RB										
Front Side	20525/836.5	10M QPSK(1,0)	0.078	0.060	0.64	21.55	22.00	0.087	2024/1/10	
Back Side	20525/836.5	10M QPSK(1,0)	0.113	0.088	0.28	21.55	22.00	0.125	2024/1/10	18#
Left Side	20525/836.5	10M QPSK(1,0)	0.042	0.033	-0.60	21.55	22.00	0.047	2024/1/10	
Right Side	20525/836.5	10M QPSK(1,0)	0.045	0.034	0.73	21.55	22.00	0.050	2024/1/10	
Bottom Side	20525/836.5	10M QPSK(1,0)	0.060	0.045	2.52	21.55	22.00	0.067	2024/1/10	
50%RB										
Front Side	20525/836.5	10M QPSK(25,12)	0.043	0.034	0.21	20.70	21.00	0.046	2024/1/10	
Back Side	20525/836.5	10M QPSK(25,12)	0.059	0.052	0.25	20.70	21.00	0.063	2024/1/10	
Left Side	20525/836.5	10M QPSK(25,12)	0.022	0.017	3.55	20.70	21.00	0.024	2024/1/10	
Right Side	20525/836.5	10M QPSK(25,12)	0.026	0.020	-3.74	20.70	21.00	0.028	2024/1/10	
Bottom Side	20525/836.5	10M QPSK(25,12)	0.034	0.023	0.18	20.70	21.00	0.036	2024/1/10	

NOTE: Hotspot SAR test results of LTE Band 5

10.1.9. SAR measurement Result of LTE Band 7

Test Position of Head	Test channel /Freq.	Mode	SAR Value (W/kg)		Power Drift(%)	Conducted Power (dBm)	Tune-up Power (dBm)	Scaled SAR 1-g (W/Kg)	Date	Plot
			1-g	10-g						
1RB										
Left Cheek	21100/2535	20M QPSK(1,99)	0.050	0.033	-1.88	22.48	22.50	0.050	2024/1/18	19#
Left Tilt 15 Degree	21100/2535	20M QPSK(1,99)	0.028	0.018	1.20	22.48	22.50	0.028	2024/1/18	
Right Cheek	21100/2535	20M QPSK(1,99)	0.046	0.029	1.94	22.48	22.50	0.046	2024/1/18	
Right	21100/2535	20M QPSK(1,99)	0.022	0.015	1.54	22.48	22.50	0.022	2024/1/18	

Tilt 15 Degree										
50%RB										
Left Cheek	21100/2535	20M QPSK(50,49)	0.026	0.019	-3.65	21.01	21.50	0.029	2024/1/18	
Left Tilt 15 Degree	21100/2535	20M QPSK(50,49)	0.014	0.010	-0.75	21.01	21.50	0.016	2024/1/18	
Right Cheek	21100/2535	20M QPSK(50,49)	0.023	0.017	-4.88	21.01	21.50	0.026	2024/1/18	
Right Tilt 15 Degree	21100/2535	20M QPSK(50,49)	0.011	0.008	-1.15	21.01	21.50	0.012	2024/1/18	

NOTE: Head SAR test results of LTE Band 7

Test Position of Body-Worn with 10mm	Test channel /Freq.	Mode	SAR Value (W/kg)		Power Drift(%)	Conducted Power (dBm)	Tune-up Power (dBm)	Scaled SAR 1-g (W/Kg)	Date	Plot
			1-g	10-g						
1RB										
Front Side	21100/2535	20M QPSK(1,99)	0.618	0.276	0.83	22.48	22.50	0.621	2024/1/18	
Back Side	21100/2535	20M QPSK(1,99)	0.983	0.443	-2.22	22.48	22.50	0.988	2024/1/18	
Back Side	20850/2510	20M QPSK(1,99)	0.903	0.414	-1.48	22.47	22.50	0.909	2024/1/18	
Back Side	21350/2560	20M QPSK(1,99)	1.132	0.511	1.38	22.49	22.50	1.135	2024/1/18	20#
BackSide Repeated	21350/2560	20M QPSK(1,99)	1.127	0.508	0.36	22.49	22.50	1.130	2024/1/18	
50%RB										
Front Side	21100/2535	20M QPSK(50,49)	0.364	0.141	1.79	21.01	21.50	0.407	2024/1/18	
Back Side	21100/2535	20M QPSK(50,49)	0.550	0.237	1.22	21.01	21.50	0.616	2024/1/18	

NOTE: Body-Worn SAR test results of LTE Band 7

Test Position of Hotspot with 10mm	Test channel /Freq.	Mode	SAR Value (W/kg)		Power Drift(%)	Conducted Power (dBm)	Tune-up Power (dBm)	Scaled SAR 1-g (W/Kg)	Date	Plot
			1-g	10-g						
1RB										
Front Side	21100/2535	20M QPSK(1,99)	0.618	0.276	0.83	22.48	22.50	0.621	2024/1/18	

Back Side	21100/2535	20M QPSK(1,99)	0.983	0.443	-2.22	22.48	22.50	0.988	2024/1/18	
Left Side	21100/2535	20M QPSK(1,99)	0.306	0.138	1.47	22.48	22.50	0.307	2024/1/18	
Right Side	21100/2535	20M QPSK(1,99)	0.303	0.132	3.57	22.48	22.50	0.304	2024/1/18	
Bottom Side	21100/2535	20M QPSK(1,99)	0.495	0.214	-1.34	22.48	22.50	0.497	2024/1/18	
Back Side	20850/2510	20M QPSK(1,99)	0.903	0.414	-1.48	22.47	22.50	0.909	2024/1/18	
Back Side	21350/2560	20M QPSK(1,99)	1.132	0.511	1.38	22.49	22.50	1.135	2024/1/18	20#
BackSide Repeated	21350/2560	20M QPSK(1,99)	1.127	0.508	0.36	22.49	22.50	1.130	2024/1/18	
50%RB										
Front Side	21100/2535	20M QPSK(50,49)	0.364	0.141	1.79	21.01	21.50	0.407	2024/1/18	
Back Side	21100/2535	20M QPSK(50,49)	0.550	0.237	1.22	21.01	21.50	0.616	2024/1/18	
Left Side	21100/2535	20M QPSK(50,49)	0.172	0.062	3.16	21.01	21.50	0.193	2024/1/18	
Right Side	21100/2535	20M QPSK(50,49)	0.177	0.069	0.30	21.01	21.50	0.198	2024/1/18	
Bottom Side	21100/2535	20M QPSK(50,49)	0.251	0.112	-3.06	21.01	21.50	0.281	2024/1/18	
100%RB										
Back Side	21100/2535	20M QPSK(100,0)	0.302	0.169	0.56	20.69	21.00	0.324	2024/1/18	

NOTE: Hotspot SAR test results of LTE Band 7

10.1.10. SAR measurement Result of LTE Band 38

Test Position of Head	Test channel /Freq.	Mode	SAR Value (W/kg)		Power Drift(%)	Conducted Power (dBm)	Tune-up Power (dBm)	Scaled SAR 1-g (W/Kg)	Date	Plot
			1-g	10-g						
1RB										
Left Cheek	38000/2595	20M QPSK(1,99)	0.043	0.033	-0.85	24.30	24.50	0.045	2024/1/18	21#
Left Tilt 15 Degree	38000/2595	20M QPSK(1,99)	0.024	0.018	2.23	24.30	24.50	0.025	2024/1/18	
Right Cheek	38000/2595	20M QPSK(1,99)	0.040	0.029	-3.34	24.30	24.50	0.042	2024/1/18	

Right Tilt 15 Degree	38000/2595	20M QPSK(1,99)	0.019	0.017	-3.52	24.30	24.50	0.020	2024/1/18	
50%RB										
Left Cheek	38000/2595	20M QPSK(50,24)	0.022	0.019	-2.11	22.90	23.50	0.025	2024/1/18	
Left Tilt 15 Degree	38000/2595	20M QPSK(50,24)	0.012	0.010	-1.57	22.90	23.50	0.014	2024/1/18	
Right Cheek	38000/2595	20M QPSK(50,24)	0.020	0.017	1.27	22.90	23.50	0.023	2024/1/18	
Right Tilt 15 Degree	38000/2595	20M QPSK(50,24)	0.011	0.009	3.56	22.90	23.50	0.013	2024/1/18	

NOTE: Head SAR test results of LTE Band 38

Test Position of Body-Worn with 10mm	Test channel /Freq.	Mode	SAR Value (W/kg)		Power Drift(%)	Conducted Power (dBm)	Tune-up Power (dBm)	Scaled SAR 1-g (W/Kg)	Date	Plot
			1-g	10-g						
1RB										
Front Side	38000/2595	20M QPSK(1,99)	0.444	0.196	-1.49	24.30	24.50	0.465	2024/1/18	
Back Side	38000/2595	20M QPSK(1,99)	0.740	0.337	-3.17	24.30	24.50	0.775	2024/1/18	22#
50%RB										
Front Side	38000/2595	20M QPSK(50,24)	0.237	0.109	1.52	22.90	23.50	0.272	2024/1/18	
Back Side	38000/2595	20M QPSK(50,24)	0.422	0.170	4.89	22.90	23.50	0.485	2024/1/18	

NOTE: Body-Worn SAR test results of LTE Band 38

Test Position of Hotspot with 10mm	Test channel /Freq.	Mode	SAR Value (W/kg)		Power Drift(%)	Conducted Power (dBm)	Tune-up Power (dBm)	Scaled SAR 1-g (W/Kg)	Date	Plot
			1-g	10-g						
1RB										
Front Side	38000/2595	20M QPSK(1,99)	0.444	0.196	-1.49	24.30	24.50	0.465	2024/1/18	
Back Side	38000/2595	20M QPSK(1,99)	0.740	0.337	-3.17	24.30	24.50	0.775	2024/1/18	22#
Left	38000/2595	20M QPSK(1,99)	0.231	0.105	0.93	24.30	24.50	0.242	2024/1/18	

Side										
Right Side	38000/2595	20M QPSK(1,99)	0.228	0.101	2.17	24.30	24.50	0.239	2024/1/18	
Bottom Side	38000/2595	20M QPSK(1,99)	0.380	0.170	2.70	24.30	24.50	0.398	2024/1/18	
50%RB										
Front Side	38000/2595	20M QPSK(50,24)	0.237	0.109	1.52	22.90	23.50	0.272	2024/1/18	
Back Side	38000/2595	20M QPSK(50,24)	0.422	0.170	4.89	22.90	23.50	0.485	2024/1/18	
Left Side	38000/2595	20M QPSK(50,24)	0.138	0.056	1.66	22.90	23.50	0.158	2024/1/18	
Right Side	38000/2595	20M QPSK(50,24)	0.135	0.059	2.24	22.90	23.50	0.155	2024/1/18	
Bottom Side	38000/2595	20M QPSK(50,24)	0.227	0.099	-4.81	22.90	23.50	0.261	2024/1/18	

NOTE: Hotspot SAR test results of LTE Band 38

10.1.11. SAR measurement Result of LTE Band 66

Test Position of Head	Test channel /Freq.	Mode	SAR Value (W/kg)		Power Drift(%)	Conducted Power (dBm)	Tune-up Power (dBm)	Scaled SAR 1-g (W/Kg)	Date	Plot
			1-g	10-g						
1RB										
Left Cheek	132322/1745	20M QPSK(1,0)	0.096	0.064	-1.08	20.39	21.50	0.124	2024/1/08	23#
Left Tilt 15 Degree	132322/1745	20M QPSK(1,0)	0.052	0.034	0.86	20.39	21.50	0.067	2024/1/08	
Right Cheek	132322/1745	20M QPSK(1,0)	0.091	0.058	0.55	20.39	21.50	0.118	2024/1/08	
Right Tilt 15 Degree	132322/1745	20M QPSK(1,0)	0.043	0.028	0.39	20.39	21.50	0.056	2024/1/08	
50%RB										
Left Cheek	132322/1745	20M QPSK(50,0)	0.049	0.035	-4.99	19.97	20.50	0.055	2024/1/08	
Left Tilt 15	132322/1745	20M QPSK(50,0)	0.029	0.020	-4.52	19.97	20.50	0.033	2024/1/08	

Degree										
Right Cheek	132322/1745	20M QPSK(50,0)	0.045	0.030	3.21	19.97	20.50	0.051	2024/1/08	
Right Tilt 15 Degree	132322/1745	20M QPSK(50,0)	0.025	0.016	-4.90	19.97	20.50	0.028	2024/1/08	

NOTE: Head SAR test results of LTE Band 66

Test Position of Body-Worn with 10mm	Test channel /Freq.	Mode	SAR Value (W/kg)		Power Drift(%)	Conducted Power (dBm)	Tune-up Power (dBm)	Scaled SAR 1-g (W/Kg)	Date	Plot
			1-g	10-g						
1RB										
Front Side	132322/1745	20M QPSK(1,0)	0.156	0.084	-2.55	20.39	21.50	0.201	2024/1/08	
Back Side	132322/1745	20M QPSK(1,0)	0.227	0.128	-1.22	20.39	21.50	0.293	2024/1/08	24#
50%RB										
Front Side	132322/1745	20M QPSK(50,0)	0.079	0.045	2.73	19.97	20.50	0.089	2024/1/08	
Back Side	132322/1745	20M QPSK(50,0)	0.117	0.074	-1.01	19.97	20.50	0.132	2024/1/08	

NOTE: Body-Worn SAR test results of LTE Band 66

Test Position of Hotspot with 10mm	Test channel /Freq.	Mode	SAR Value (W/kg)		Power Drift(%)	Conducted Power (dBm)	Tune-up Power (dBm)	Scaled SAR 1-g (W/Kg)	Date	Plot
			1-g	10-g						
1RB										
Front Side	132322/1745	20M QPSK(1,0)	0.156	0.084	-2.55	20.39	21.50	0.201	2024/1/08	
Back Side	132322/1745	20M QPSK(1,0)	0.227	0.128	-1.22	20.39	21.50	0.293	2024/1/08	24#
Left Side	132322/1745	20M QPSK(1,0)	0.065	0.037	-1.40	20.39	21.50	0.084	2024/1/08	
Right Side	132322/1745	20M QPSK(1,0)	0.069	0.039	-1.13	20.39	21.50	0.089	2024/1/08	
Bottom Side	132322/1745	20M QPSK(1,0)	0.135	0.072	0.03	20.39	21.50	0.174	2024/1/08	
50%RB										
Front Side	132322/1745	20M QPSK(50,0)	0.079	0.045	2.73	19.97	20.50	0.089	2024/1/08	

Back Side	132322/1745	20M QPSK(50,0)	0.117	0.074	-1.01	19.97	20.50	0.132	2024/1/08	
Left Side	132322/1745	20M QPSK(50,0)	0.034	0.021	-0.49	19.97	20.50	0.038	2024/1/08	
Right Side	132322/1745	20M QPSK(50,0)	0.036	0.023	-1.81	19.97	20.50	0.041	2024/1/08	
Bottom Side	132322/1745	20M QPSK(50,0)	0.077	0.043	1.93	19.97	20.50	0.087	2024/1/08	

NOTE: Hotspot SAR test results of LTE Band 66

10.1.12. SAR measurement Result of WLAN 2.4G

Test Position of Head	Test channel /Freq.	Mode	SAR Value (W/kg)		Power Drift(%)	Conducted Power (dBm)	Tune-up Power (dBm)	Scaled SAR 1-g (W/Kg)	Date	Plot
			1-g	10-g						
Left Cheek	6/2437	802.11b	0.083	0.048	-0.93	14.64	15.00	0.090	2024/1/09	11#
Left Tilt 15 Degree	6/2437	802.11b	0.042	0.024	1.19	14.64	15.00	0.046	2024/1/09	
Right Cheek	6/2437	802.11b	0.075	0.042	-0.04	14.64	15.00	0.081	2024/1/09	
Right Tilt 15 Degree	6/2437	802.11b	0.037	0.021	3.73	14.64	15.00	0.040	2024/1/09	

NOTE: Head SAR test results of WLAN2.4G

Test Position of Body-Worn with 10mm	Test channel /Freq.	Mode	SAR Value (W/kg)		Power Drift(%)	Conducted Power (dBm)	Tune-up Power (dBm)	Scaled SAR 1-g (W/Kg)	Date	Plot
			1-g	10-g						
Front Side	6/2437	802.11b	0.090	0.046	-0.49	14.64	15.00	0.098	2024/1/09	
Back Side	6/2437	802.11b	0.125	0.065	1.93	14.64	15.00	0.136	2024/1/09	12#

NOTE: Body-worn SAR test results of WLAN2.4G

Test Position of Hotspot	Test channel /Freq.	Mode	SAR Value (W/kg)		Power Drift(%)	Conducted Power (dBm)	Tune-up Power (dBm)	Scaled SAR 1-g (W/Kg)	Date	Plot
			1-g	10-g						

with 10mm										
Front Side	6/2437	802.11b	0.090	0.046	-0.49	14.64	15.00	0.098	2024/1/09	
Back Side	6/2437	802.11b	0.125	0.065	1.93	14.64	15.00	0.136	2024/1/09	12#
Left Side	6/2437	802.11b	0.045	0.020	3.60	14.64	15.00	0.049	2024/1/09	
Top Side	6/2437	802.11b	0.048	0.024	-0.28	14.64	15.00	0.052	2024/1/09	

NOTE: Hotspot SAR test results of WLAN2.4G

10.2. Simultaneous Transmission Analysis

Per KDB 447498 D01, simultaneous transmission SAR is compliant if,

- 1) Scalar SAR summation < 1.6W/kg.
- 2) $SPLSR = (SAR_1 + SAR_2)^{1.5} / (\text{min. separation distance, mm})$, and the peak separation distance is determined from the square root of $[(x_1-x_2)^2 + (y_1-y_2)^2 + (z_1-z_2)^2]$, where (x_1, y_1, z_1) and (x_2, y_2, z_2) are the coordinates of the extrapolated peak SAR locations in the zoom scan. If $SPLSR \leq 0.04$, simultaneously transmission SAR measurement is not necessary.

Test Position		Scaled SAR _{MAX}		Σ 1-g SAR (W/Kg)	SPLSR	Remark
		WWAN	DTS			
Head	Left Cheek	0.192	0.090	0.282	N/A	N/A
	Left Tilt 15 Degree	0.098	0.046	0.144	N/A	N/A
	Right Cheek	0.168	0.081	0.249	N/A	N/A
	Right Tilt 15 Degree	0.092	0.040	0.132	N/A	N/A
Body-Worn	Front Side	0.621	0.098	0.719	N/A	N/A
	Back Side	1.135	0.136	1.271	N/A	N/A
Hotspot	Front Side	0.621	0.098	0.719	N/A	N/A
	Back Side	1.135	0.136	1.271	N/A	N/A
	Left Side	0.307	0.049	0.356	N/A	N/A
	Right Side	0.304	N/A	0.304	N/A	N/A
	Top Side	N/A	0.052	0.052	N/A	N/A
	Bottom Side	0.497	N/A	0.497	N/A	N/A

Test Position		Scaled SAR _{MAX}		Σ 1-g SAR (W/Kg)	SPLSR	Remark
		WWAN	DSS			

Head	Left Cheek	0.192	0.084	0.276	N/A	N/A
	Left Tilt 15 Degree	0.098	0.084	0.182	N/A	N/A
	Right Cheek	0.168	0.084	0.252	N/A	N/A
	Right Tilt 15 Degree	0.092	0.084	0.176	N/A	N/A
Body-Worn	Front Side	0.621	0.042	0.663	N/A	N/A
	Back Side	1.135	0.042	1.177	N/A	N/A
Hotspot	Front Side	0.621	0.042	0.663	N/A	N/A
	Back Side	1.135	0.042	1.177	N/A	N/A
	Left Side	0.307	0.042	0.349	N/A	N/A
	Right Side	0.304	N/A	0.304	N/A	N/A
	Top Side	N/A	0.042	0.042	N/A	N/A
	Bottom Side	0.497	N/A	0.497	N/A	N/A

11. Appendix A. Photo documentation

Refer to appendix Test Setup photo---SAR

12. Appendix B. System Check Plots

Table of contents
MEASUREMENT 1 System Performance Check - 835MHz
MEASUREMENT 2 System Performance Check - 1800MHz
MEASUREMENT 3 System Performance Check - 1900MHz
MEASUREMENT 4 System Performance Check - 2450MHz
MEASUREMENT 5 System Performance Check - 2600MHz

MEASUREMENT 1

Date of measurement: 10/1/2024

A. Experimental conditions.

Area Scan	<u>dx=15mm dy=15mm, h= 5.00 mm</u>
ZoomScan	<u>5x5x7, dx=8mm dy=8mm dz=5mm</u>
Phantom	<u>Validation plane</u>
Device Position	<u>Dipole</u>
Band	<u>CW835</u>
Channels	<u>Middle</u>
Signal	<u>CW (Crest factor: 1.0)</u>
ConvF	<u>2.32</u>

B. SAR Measurement Results

Frequency (MHz)	835.000000
Relative permittivity (real part)	41.258639
Relative permittivity (imaginary part)	19.199080
Conductivity (S/m)	0.890624
Variation (%)	-3.920000

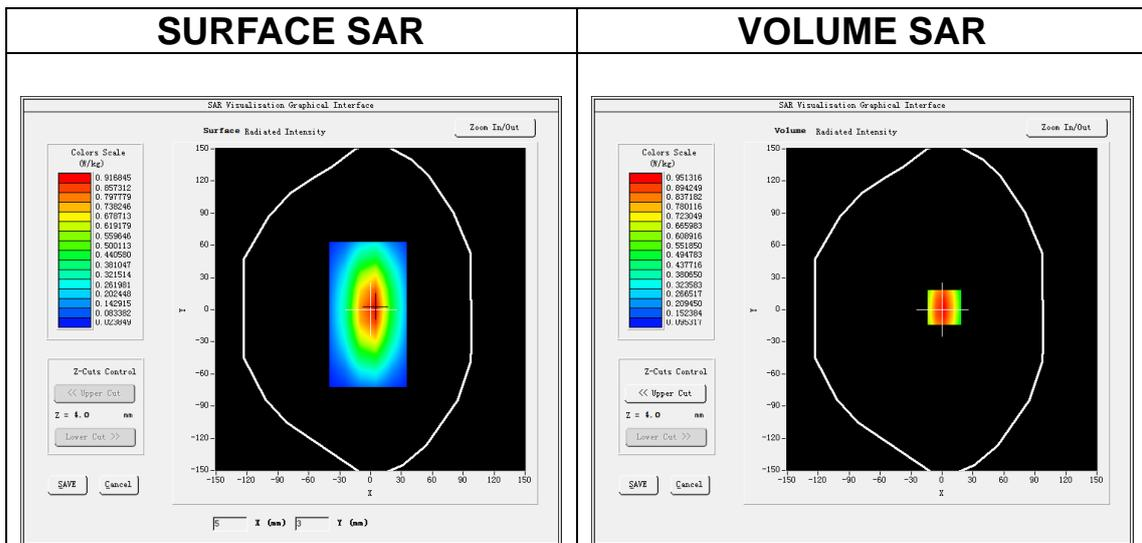

Maximum location: X=2.00, Y=2.00
SAR Peak: 1.29 W/kg

SAR 10g (W/Kg)	0.674158
SAR 1g (W/Kg)	0.997222

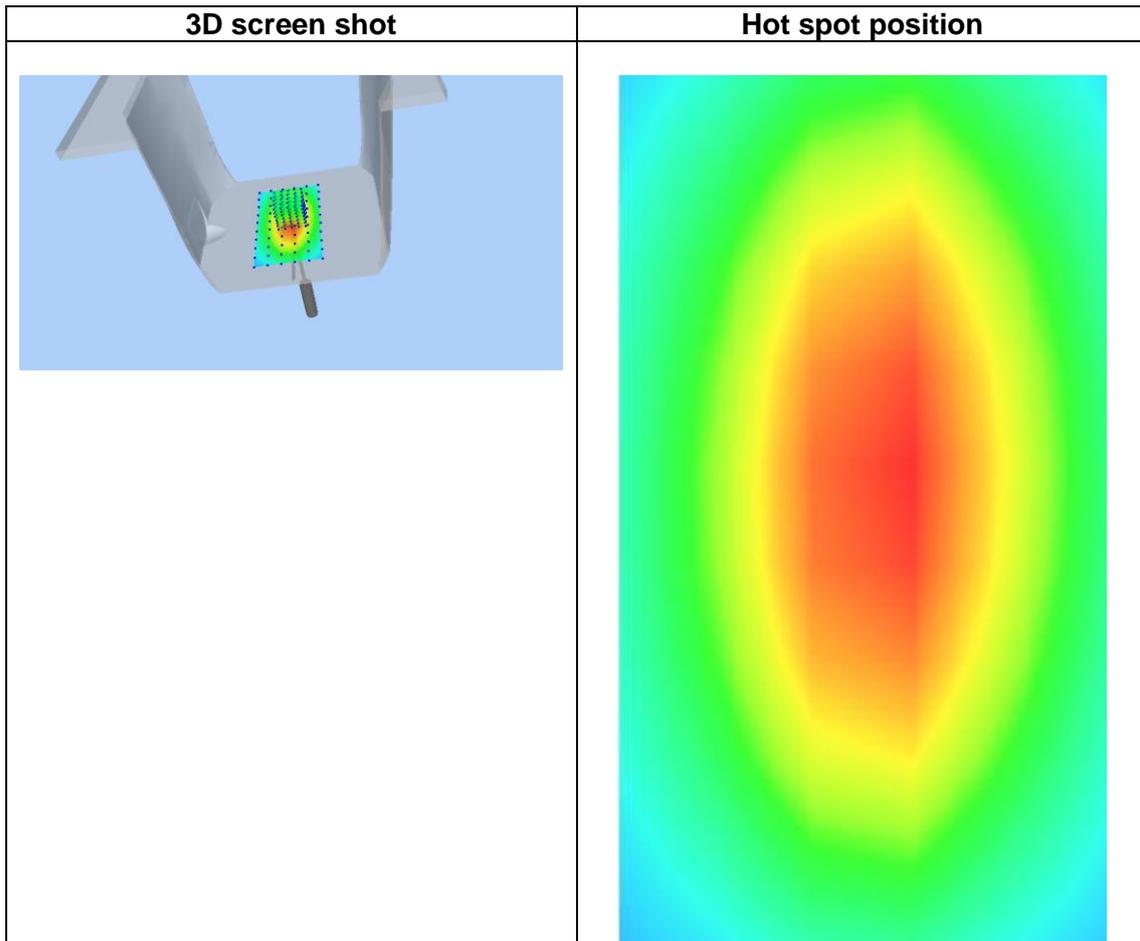
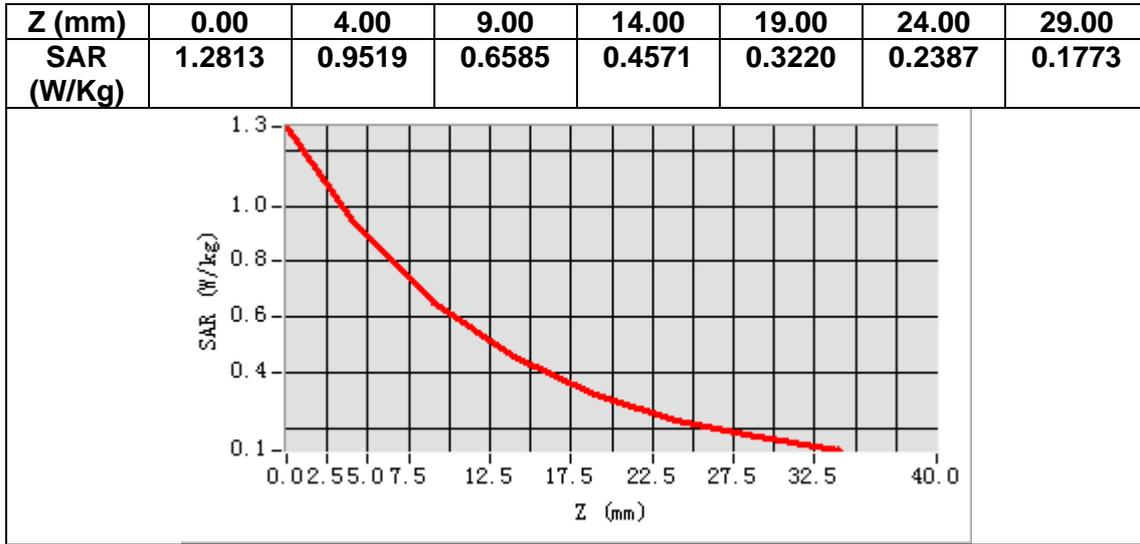

MEASUREMENT 2

Date of measurement: 8/1/2024

A. Experimental conditions.

Area Scan	<u>dx=15mm dy=15mm, h= 5.00 mm</u>
ZoomScan	<u>5x5x7, dx=8mm dy=8mm dz=5mm</u>
Phantom	<u>Validation plane</u>
Device Position	<u>Dipole</u>
Band	<u>CW1800</u>
Channels	<u>Middle</u>
Signal	<u>CW (Crest factor: 1.0)</u>
ConvF	<u>2.45</u>

B. SAR Measurement Results

Frequency (MHz)	1800.000000
Relative permittivity (real part)	39.535625
Relative permittivity (imaginary part)	13.888505
Conductivity (S/m)	1.388851
Variation (%)	-1.080000

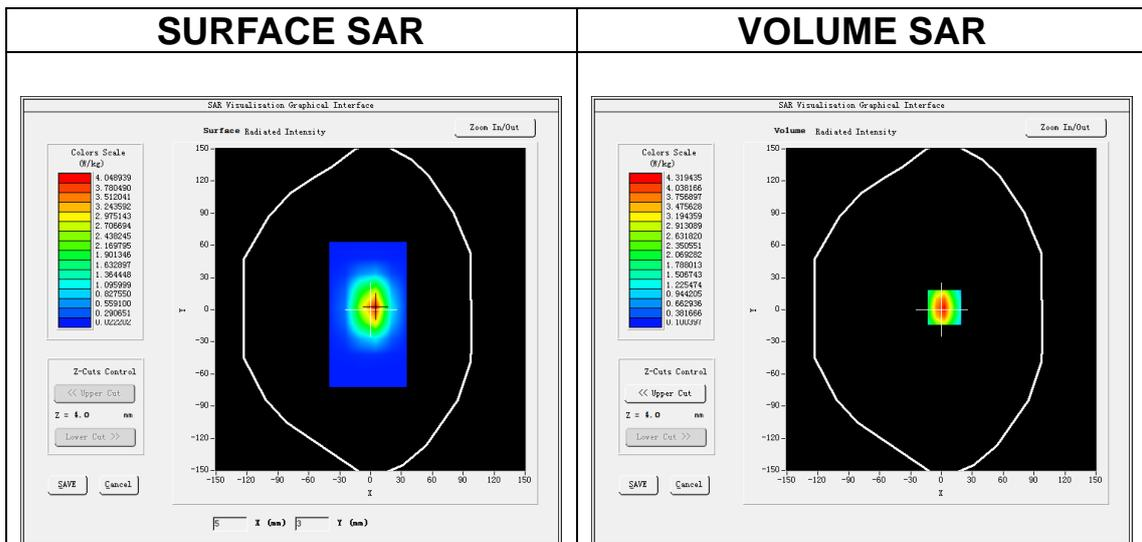

Maximum location: X=3.00, Y=2.00
SAR Peak: 6.82 W/kg

SAR 10g (W/Kg)	1.891321
SAR 1g (W/Kg)	3.949203

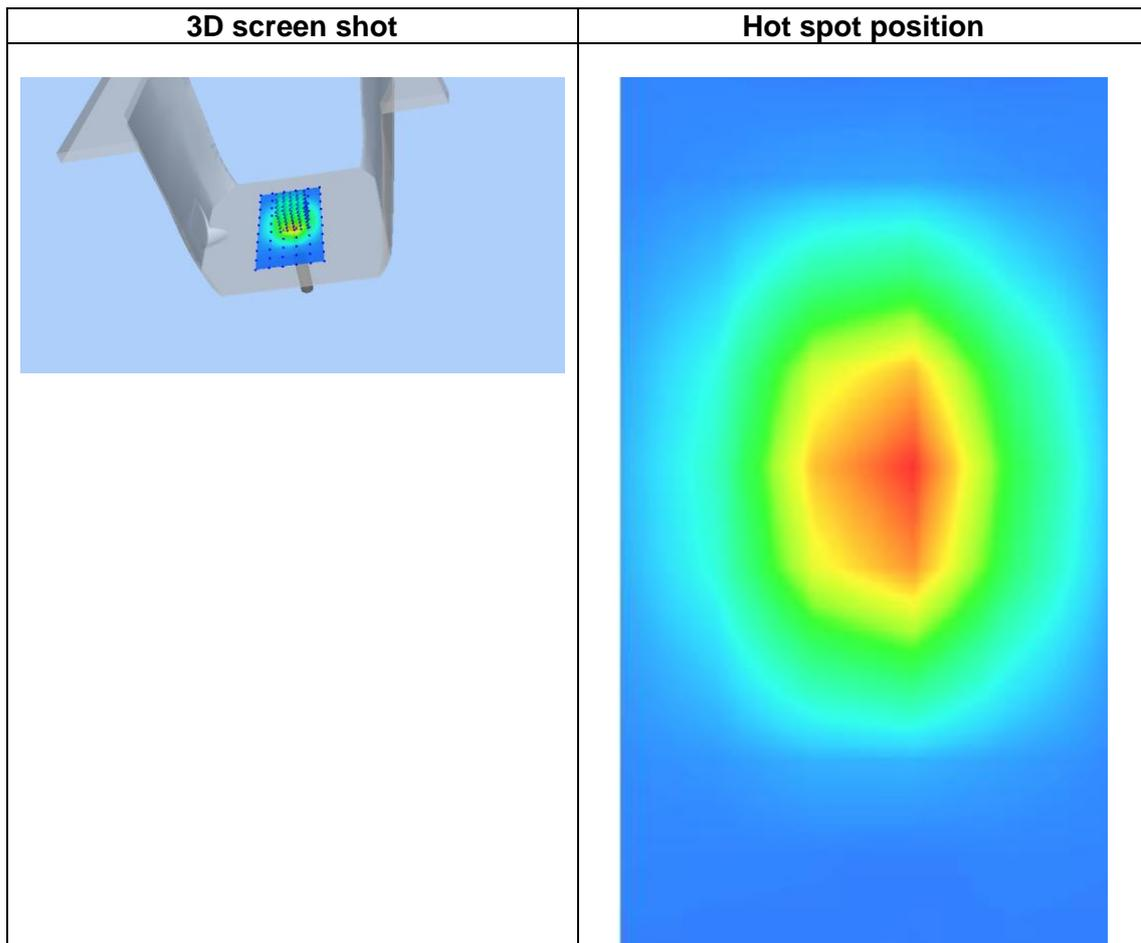
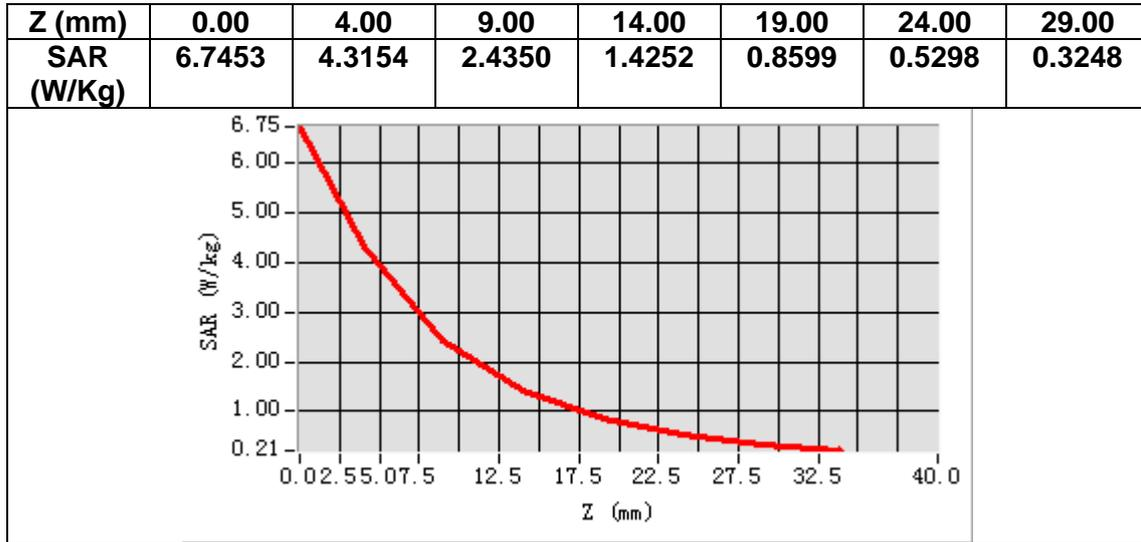

MEASUREMENT 3

Date of measurement: 11/1/2024

A. Experimental conditions.

Area Scan	<u>dx=15mm dy=15mm, h= 5.00 mm</u>
ZoomScan	<u>5x5x7, dx=8mm dy=8mm dz=5mm</u>
Phantom	<u>Validation plane</u>
Device Position	<u>Dipole</u>
Band	<u>CW1900</u>
Channels	<u>Middle</u>
Signal	<u>CW (Crest factor: 1.0)</u>
ConvF	<u>2.63</u>

B. SAR Measurement Results

Frequency (MHz)	1900.000000
Relative permittivity (real part)	39.132044
Relative permittivity (imaginary part)	13.839950
Conductivity (S/m)	1.460884
Variation (%)	1.540000

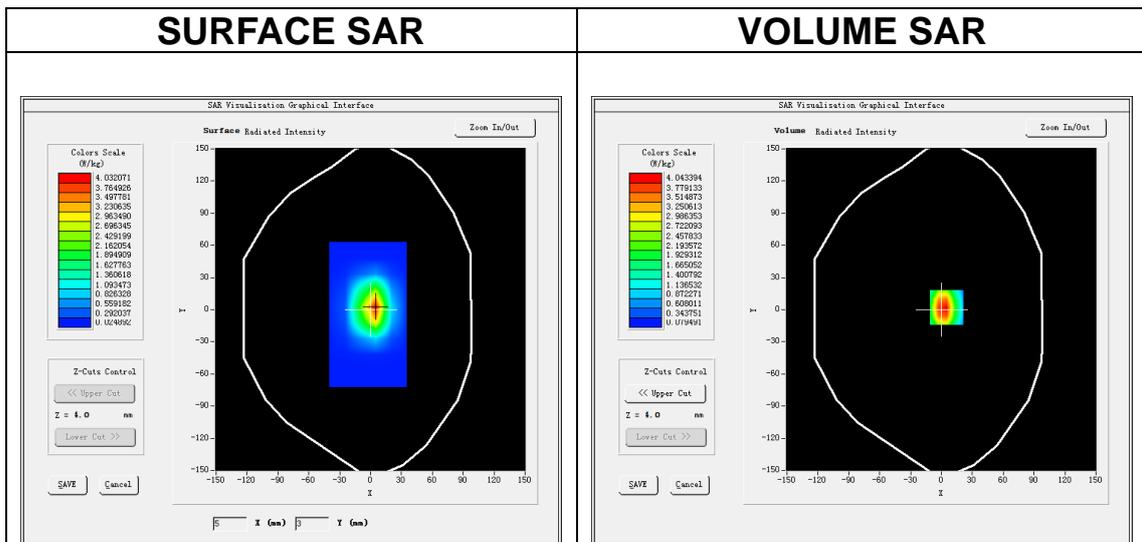

Maximum location: X=5.00, Y=2.00
SAR Peak: 6.70 W/kg

SAR 10g (W/Kg)	2.098249
SAR 1g (W/Kg)	4.081252

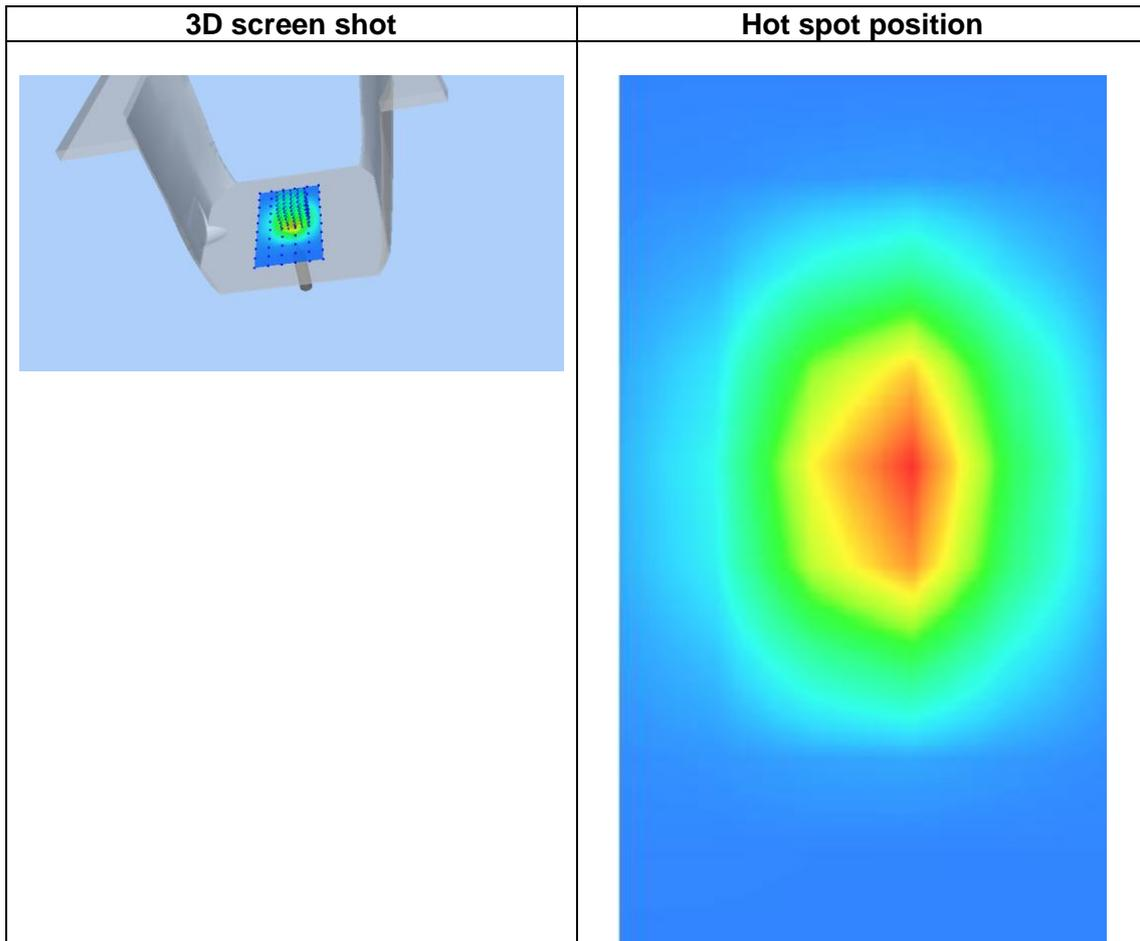
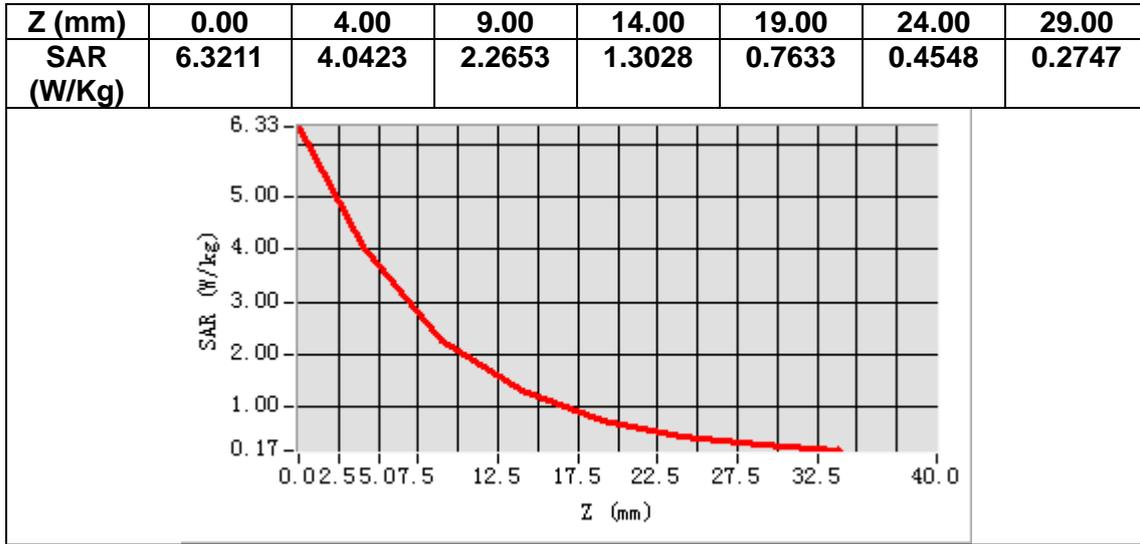

MEASUREMENT 4

Date of measurement: 9/1/2024

A. Experimental conditions.

Area Scan	<u>dx=12mm dy=12mm, h= 5.00 mm</u>
ZoomScan	<u>7x7x7, dx=5mm dy=5mm dz=5mm</u>
Phantom	<u>Validation plane</u>
Device Position	<u>Dipole</u>
Band	<u>CW2450</u>
Channels	<u>Middle</u>
Signal	<u>CW (Crest factor: 1.0)</u>
ConvF	<u>2.85</u>

B. SAR Measurement Results

Frequency (MHz)	2450.000000
Relative permittivity (real part)	38.164719
Relative permittivity (imaginary part)	13.000694
Conductivity (S/m)	1.769539
Variation (%)	0.660000

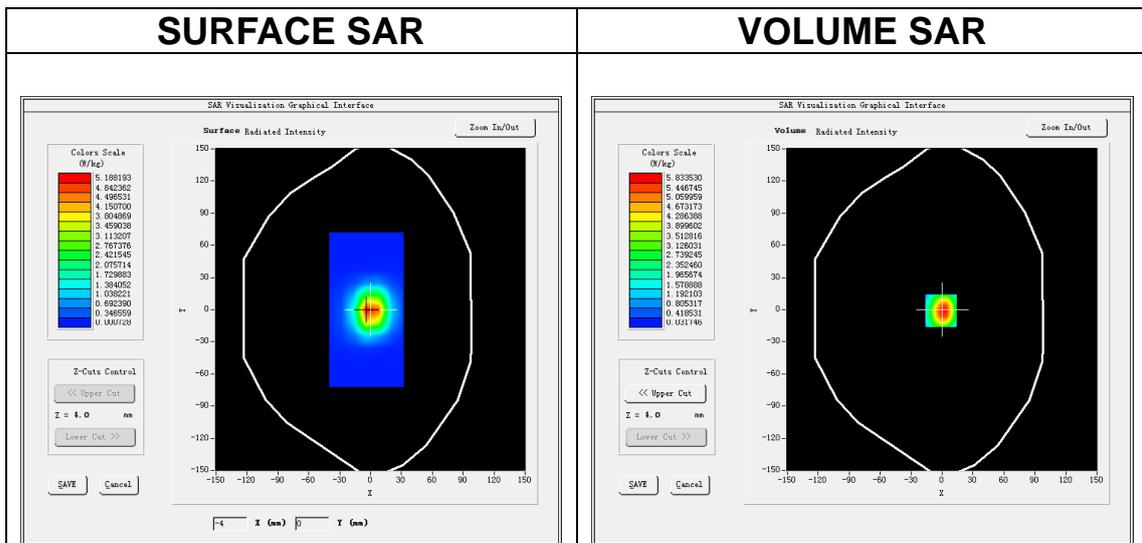

Maximum location: X=-1.00, Y=-1.00
SAR Peak: 9.83 W/kg

SAR 10g (W/Kg)	2.413157
SAR 1g (W/Kg)	5.098305

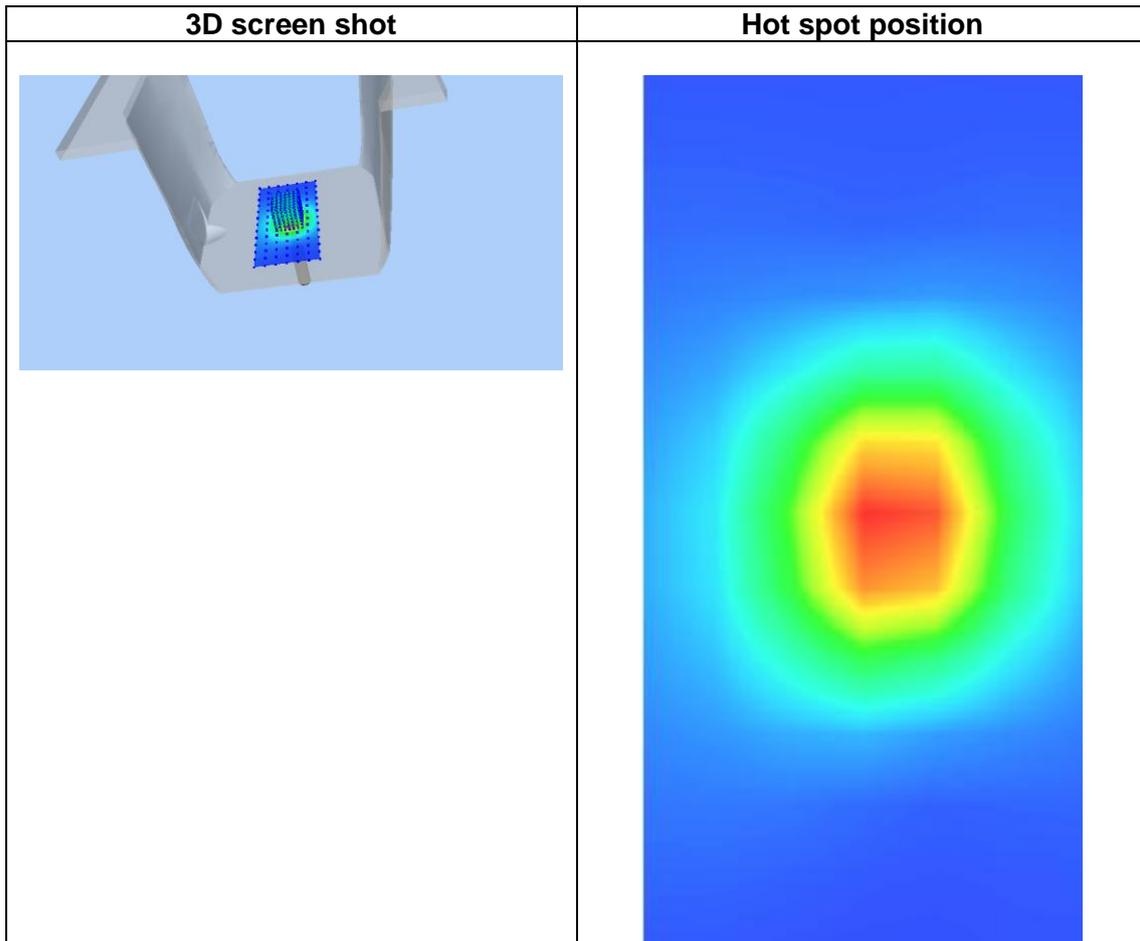
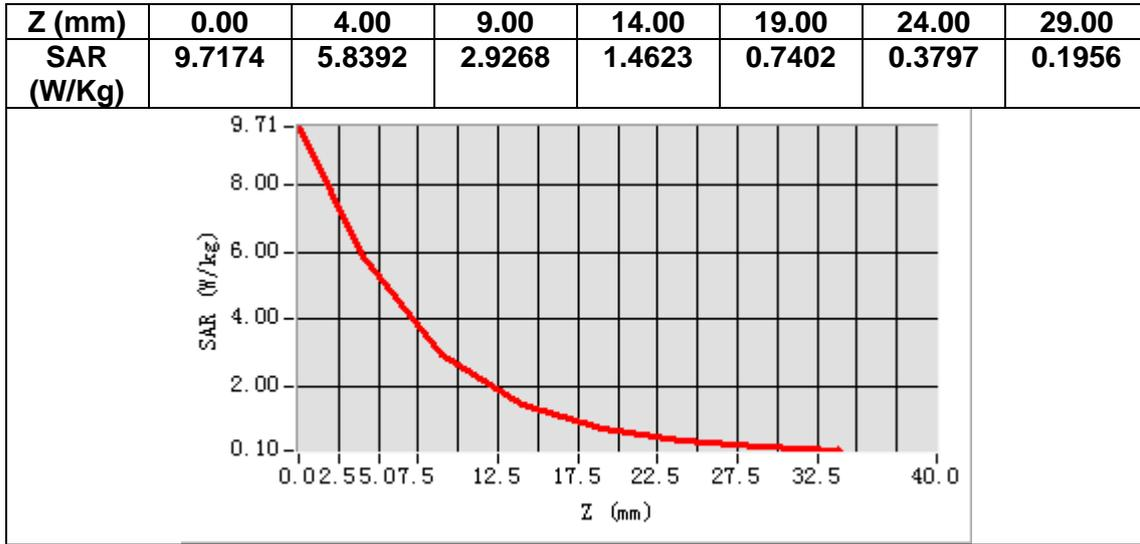

MEASUREMENT 5

Date of measurement: 18/1/2024

A. Experimental conditions.

Area Scan	<u>dx=12mm dy=12mm, h= 5.00 mm</u>
ZoomScan	<u>7x7x7, dx=5mm dy=5mm dz=5mm</u>
Phantom	<u>Validation plane</u>
Device Position	<u>Dipole</u>
Band	<u>CW2600</u>
Channels	<u>Middle</u>
Signal	<u>CW (Crest factor: 1.0)</u>
ConvF	<u>2.65</u>

B. SAR Measurement Results

Frequency (MHz)	2600.000000
Relative permittivity (real part)	38.667421
Relative permittivity (imaginary part)	13.434174
Conductivity (S/m)	1.940492
Variation (%)	-0.680000

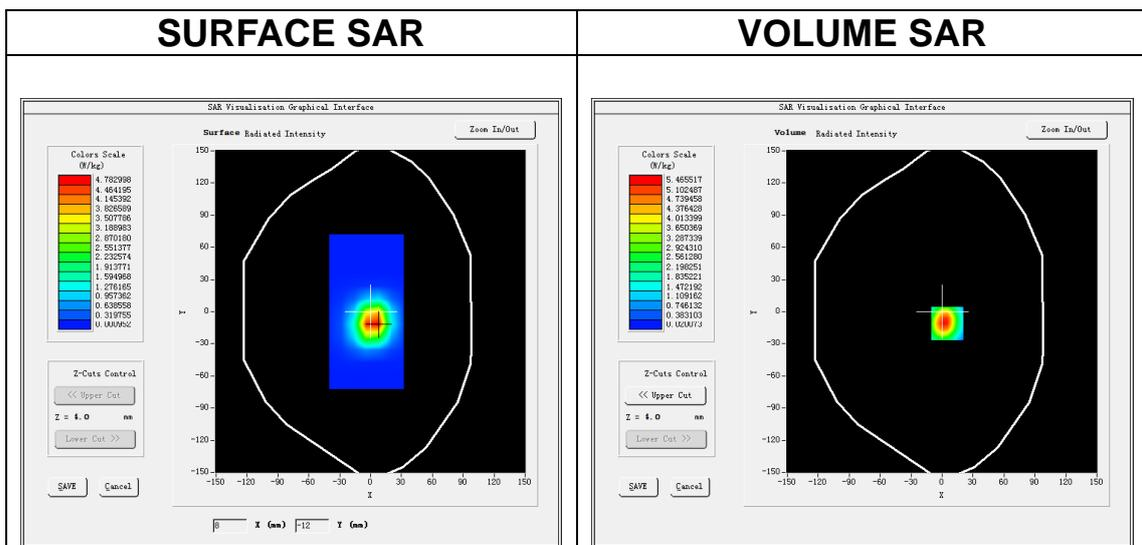

Maximum location: X=5.00, Y=-11.00
SAR Peak: 9.43 W/kg

SAR 10g (W/Kg)	2.194045
SAR 1g (W/Kg)	5.357270

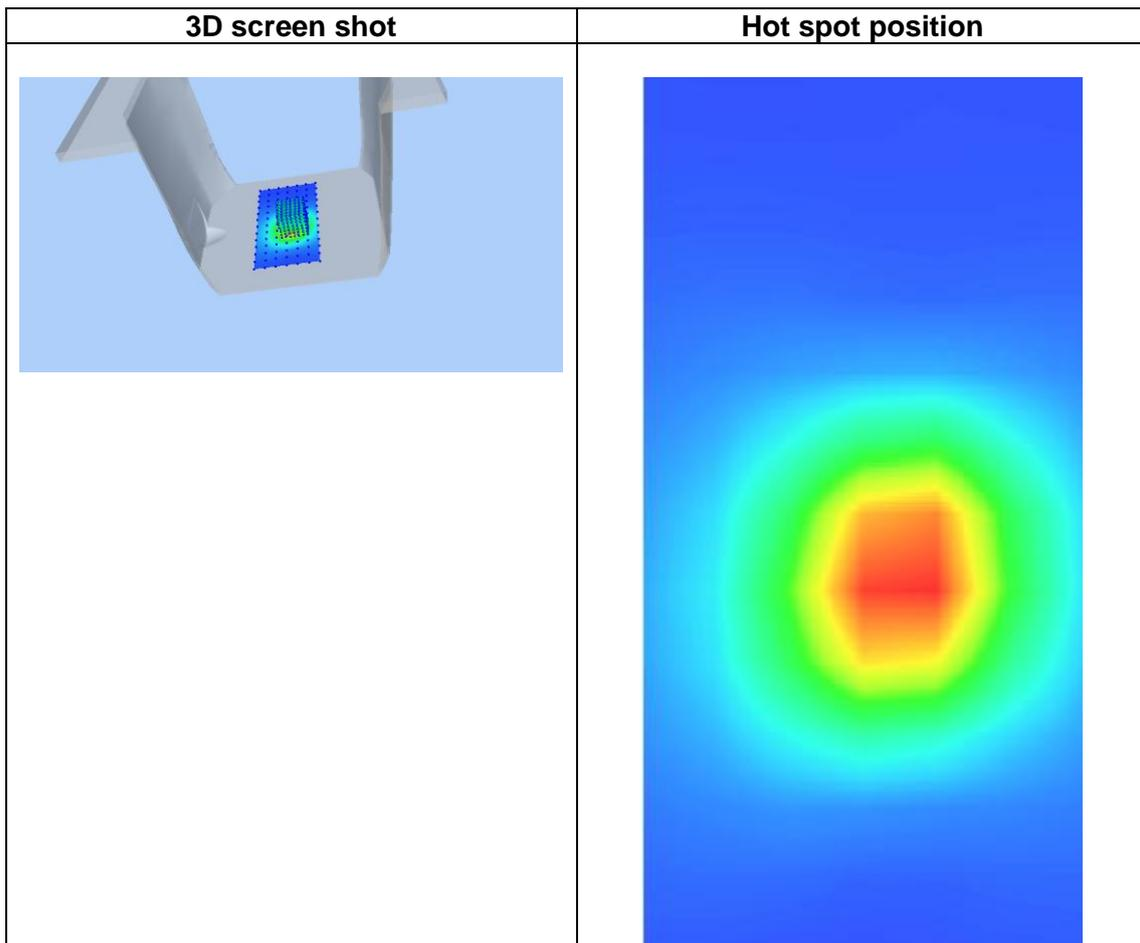
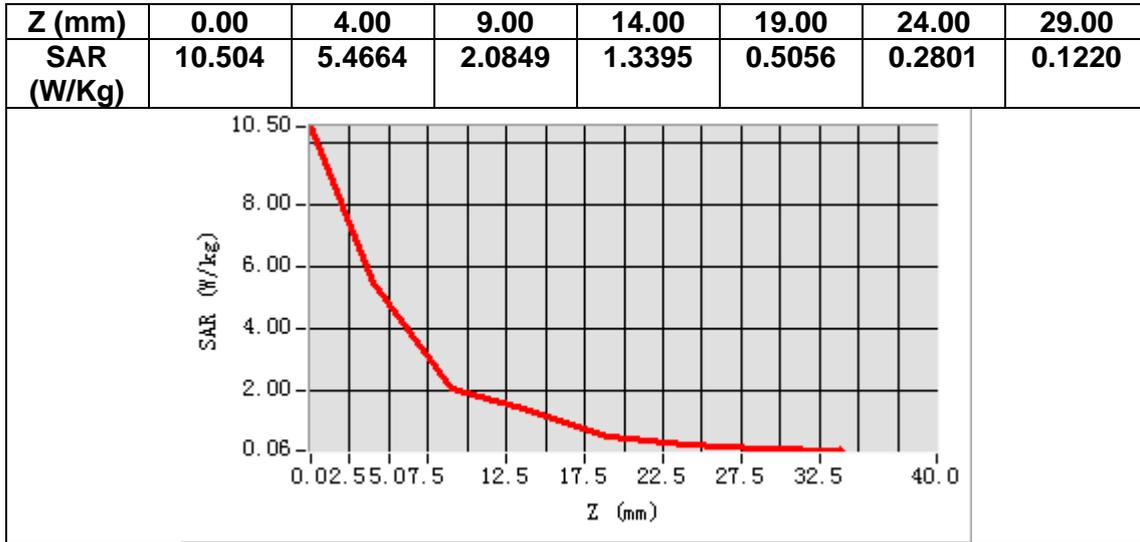

13. Appendix C. Plots of High SAR Measurement

Table of contents
MEASUREMENT 1 GSM 850 Head
MEASUREMENT 2 GSM 850 Body
MEASUREMENT 3 GSM 1900 Head
MEASUREMENT 4 GSM 1900 Body
MEASUREMENT 5 WCDMA Band 2 Head
MEASUREMENT 6 WCDMA Band 2 Body
MEASUREMENT 7 WCDMA Band 4 Head
MEASUREMENT 8 WCDMA Band 4 Body
MEASUREMENT 9 WCDMA Band 5 Head
MEASUREMENT 10 WCDMA Band 5 Body
MEASUREMENT 11 WLAN 2.4G Head
MEASUREMENT 12 WLAN 2.4G Body
MEASUREMENT 13 LTE Band 2 Head
MEASUREMENT 14 LTE Band 2 Body
MEASUREMENT 15 LTE Band 4 Head
MEASUREMENT 16 LTE Band 4 Body
MEASUREMENT 17 LTE Band 5 Head
MEASUREMENT 18 LTE Band 5 Body
MEASUREMENT 19 LTE Band 7 Head
MEASUREMENT 20 LTE Band 7 Body
MEASUREMENT 21 LTE Band 38 Head
MEASUREMENT 22 LTE Band 38 Body
MEASUREMENT 23 LTE Band 66 Head
MEASUREMENT 24 LTE Band 66 Body

MEASUREMENT 1

Date of measurement: 10/1/2024

A. Experimental conditions.

Area Scan	<u>dx=15mm dy=15mm, h= 5.00 mm</u>
ZoomScan	<u>5x5x7, dx=8mm dy=8mm dz=5mm</u>
Phantom	<u>Left head</u>
Device Position	<u>Cheek</u>
Band	<u>GSM850</u>
Channels	<u>Middle</u>
Signal	<u>TDMA (Crest factor: 2.0)</u>
ConvF	<u>2.32</u>

B. SAR Measurement Results

Frequency (MHz)	836.400000
Relative permittivity (real part)	41.415241
Relative permittivity (imaginary part)	19.323738
Conductivity (S/m)	0.897910
Variation (%)	1.270000

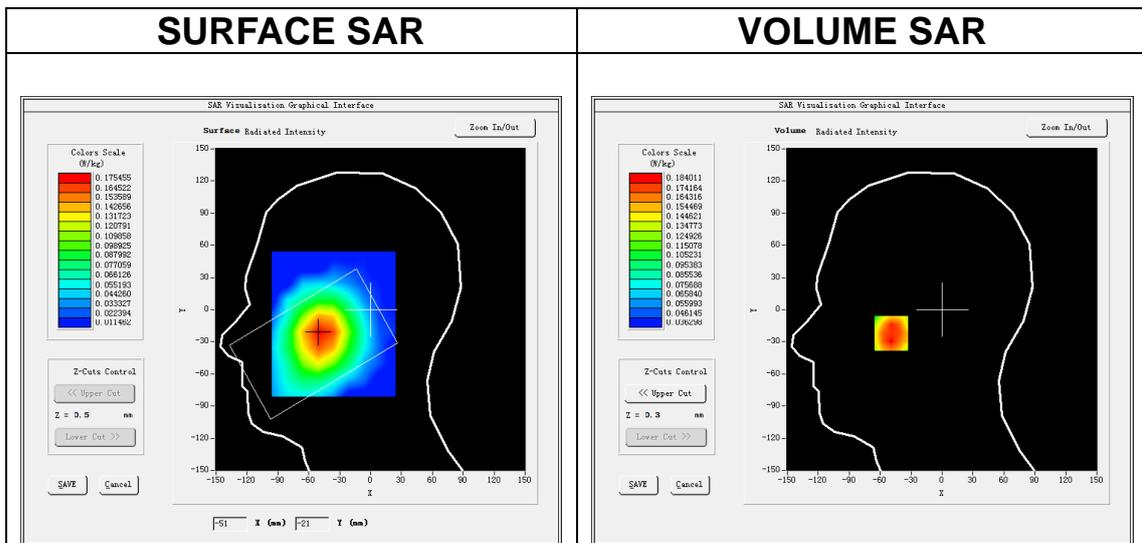

Maximum location: X=-49.00, Y=-22.00
SAR Peak: 0.23 W/kg

SAR 10g (W/Kg)	0.134095
SAR 1g (W/Kg)	0.176946

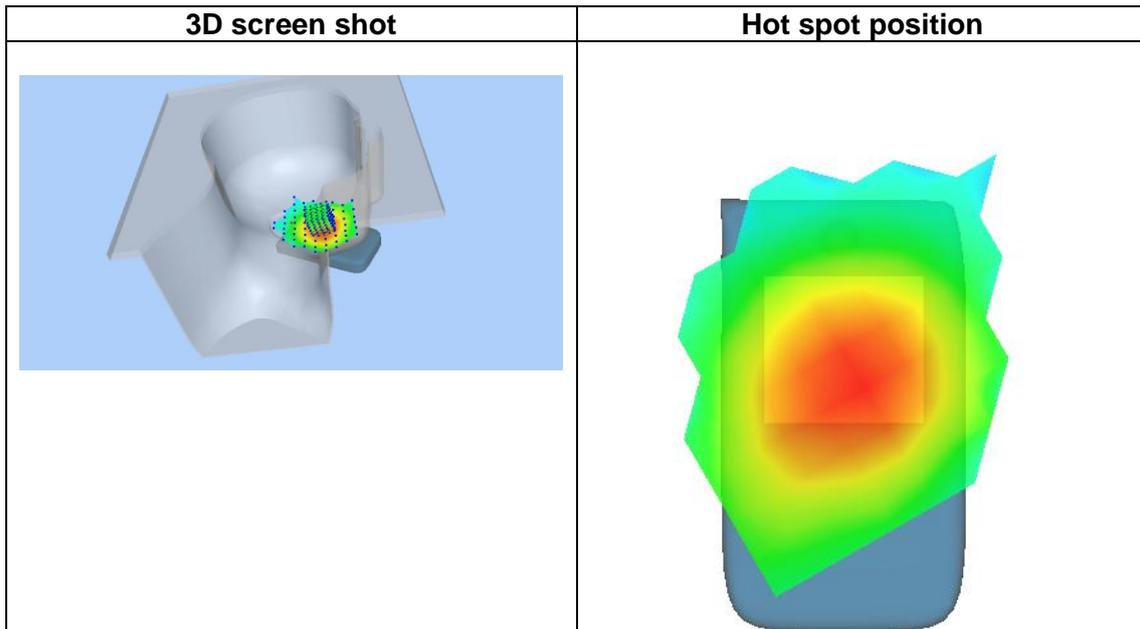
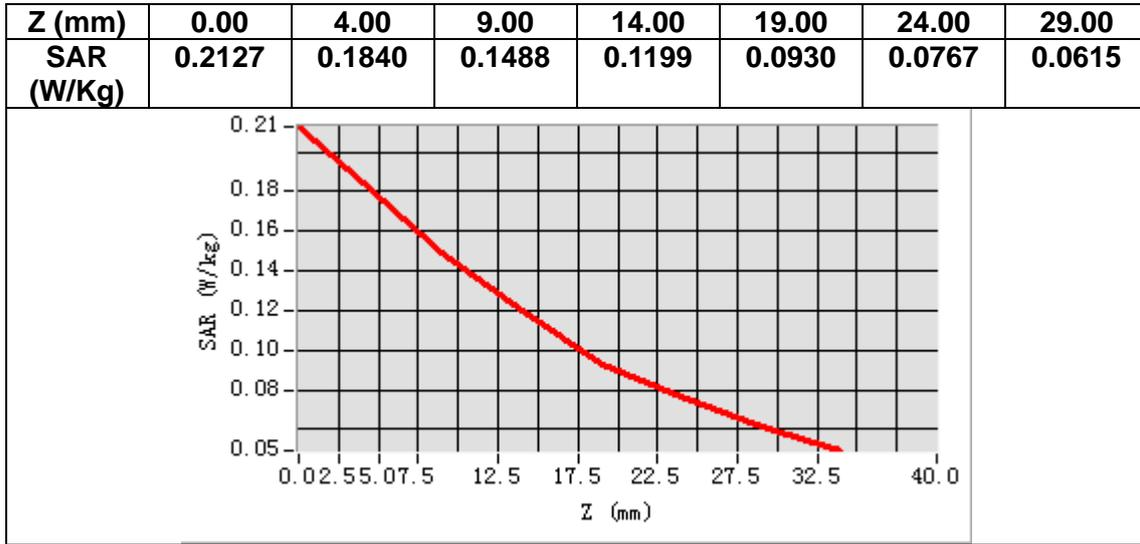

MEASUREMENT 2

Date of measurement: 10/1/2024

A. Experimental conditions.

Area Scan	<u>dx=15mm dy=15mm, h= 5.00 mm</u>
ZoomScan	<u>5x5x7, dx=8mm dy=8mm dz=5mm</u>
Phantom	<u>Validation plane</u>
Device Position	<u>Body</u>
Band	<u>GSM850</u>
Channels	<u>Middle</u>
Signal	<u>TDMA (Crest factor: 2.0)</u>
ConvF	<u>2.32</u>

B. SAR Measurement Results

Frequency (MHz)	836.400000
Relative permittivity (real part)	41.415241
Relative permittivity (imaginary part)	19.323738
Conductivity (S/m)	0.897910
Variation (%)	-0.510000

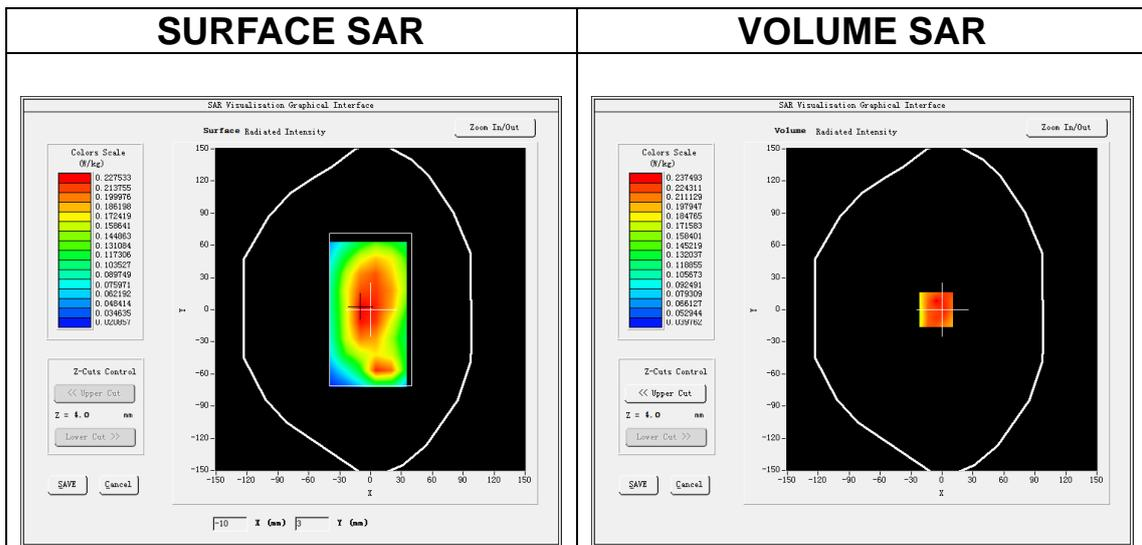

Maximum location: X=-6.00, Y=0.00

SAR Peak: 0.31 W/kg

SAR 10g (W/Kg)	0.170154
SAR 1g (W/Kg)	0.228287

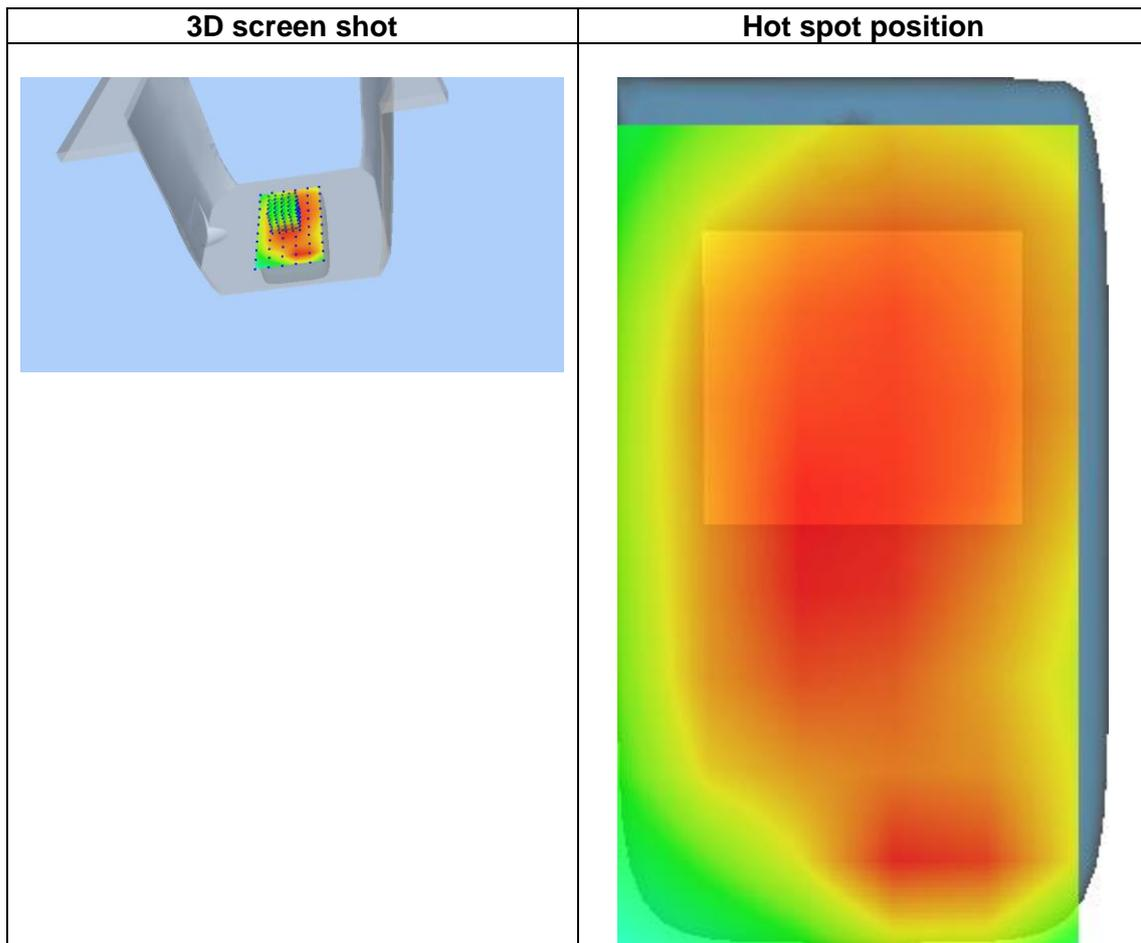
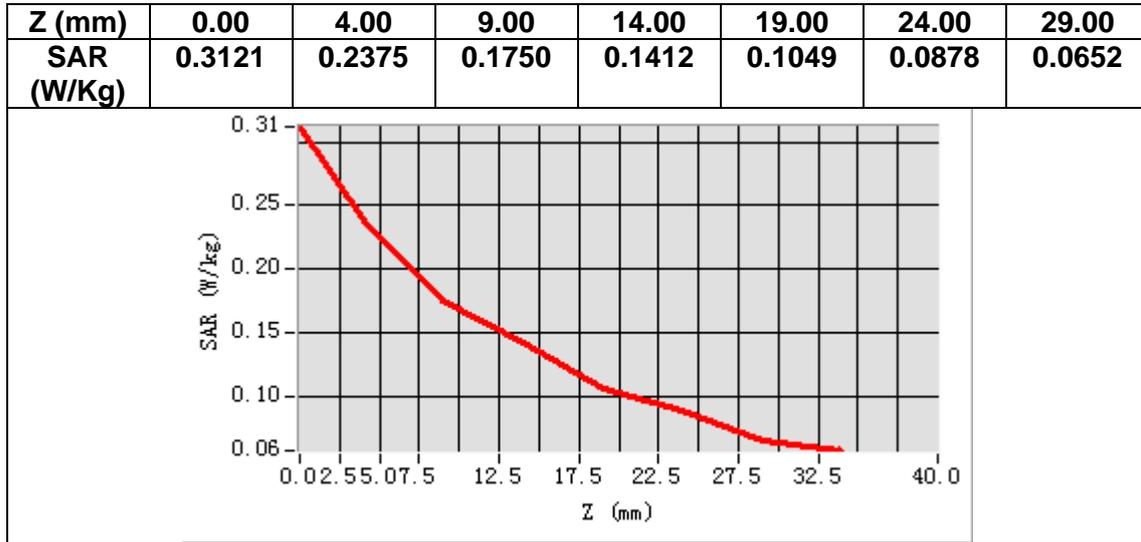

MEASUREMENT 3

Date of measurement: 11/1/2024

A. Experimental conditions.

Area Scan	<u>dx=15mm dy=15mm, h= 5.00 mm</u>
ZoomScan	<u>5x5x7,dx=8mm dy=8mm dz=5mm</u>
Phantom	<u>Left head</u>
Device Position	<u>Cheek</u>
Band	<u>GSM1900</u>
Channels	<u>Middle</u>
Signal	<u>TDMA (Crest factor: 2.0)</u>
ConvF	<u>2.63</u>

B. SAR Measurement Results

Frequency (MHz)	1880.000000
Relative permittivity (real part)	39.207344
Relative permittivity (imaginary part)	13.887850
Conductivity (S/m)	1.450509
Variation (%)	-2.430000

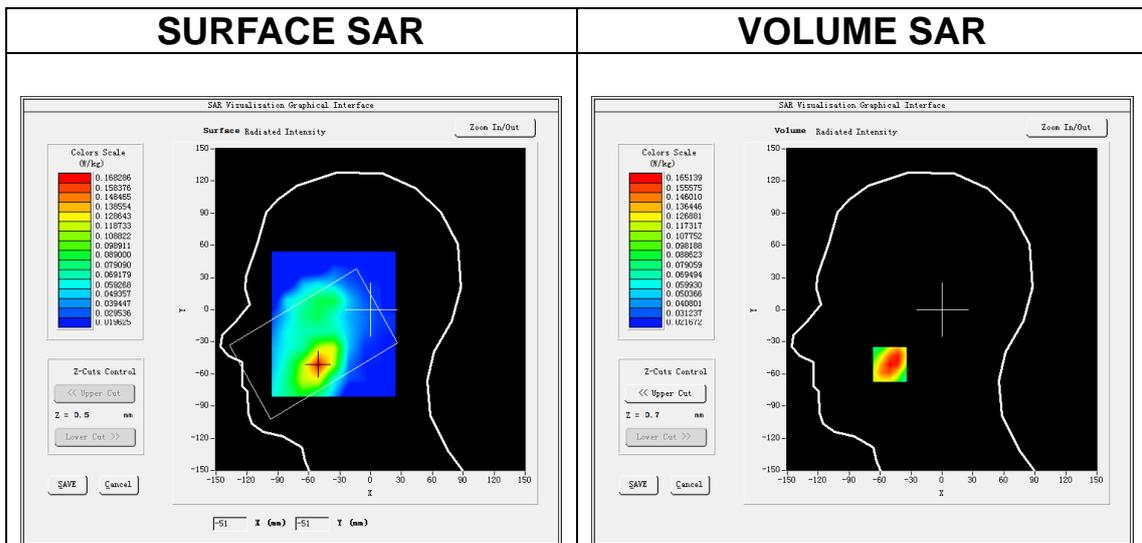

Maximum location: X=-51.00, Y=-51.00
SAR Peak: 0.23 W/kg

SAR 10g (W/Kg)	0.103972
SAR 1g (W/Kg)	0.163855

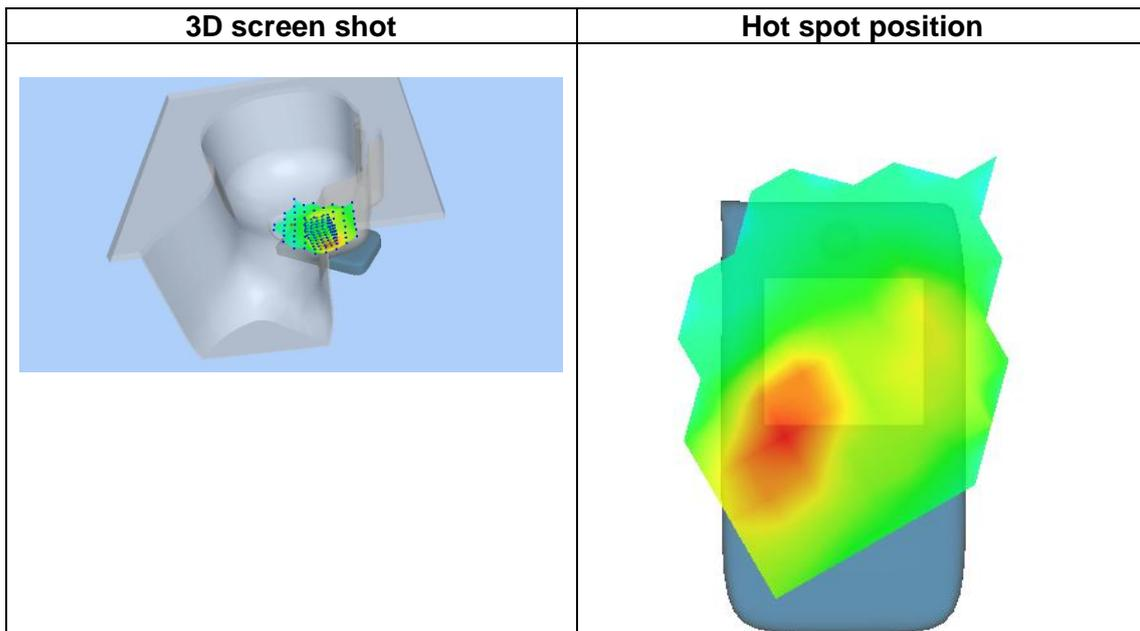
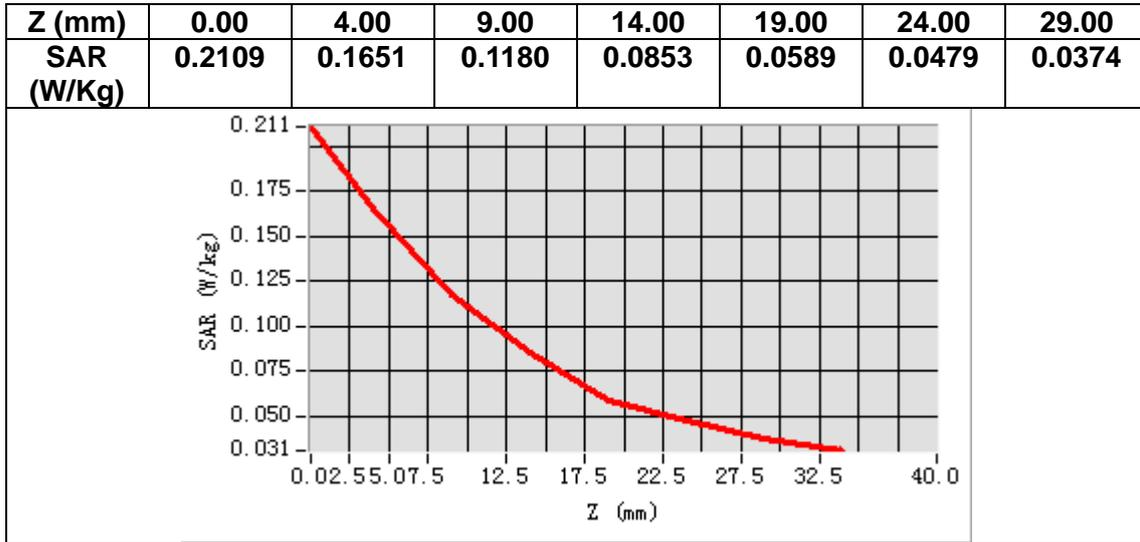

MEASUREMENT 4

Date of measurement: 11/1/2024

A. Experimental conditions.

Area Scan	<u>dx=15mm dy=15mm, h= 5.00 mm</u>
ZoomScan	<u>5x5x7, dx=8mm dy=8mm dz=5mm</u>
Phantom	<u>Validation plane</u>
Device Position	<u>Body</u>
Band	<u>GSM1900</u>
Channels	<u>Middle</u>
Signal	<u>TDMA (Crest factor: 2.0)</u>
ConvF	<u>2.63</u>

B. SAR Measurement Results

Frequency (MHz)	1880.000000
Relative permittivity (real part)	39.207344
Relative permittivity (imaginary part)	13.887850
Conductivity (S/m)	1.450509
Variation (%)	-0.570000

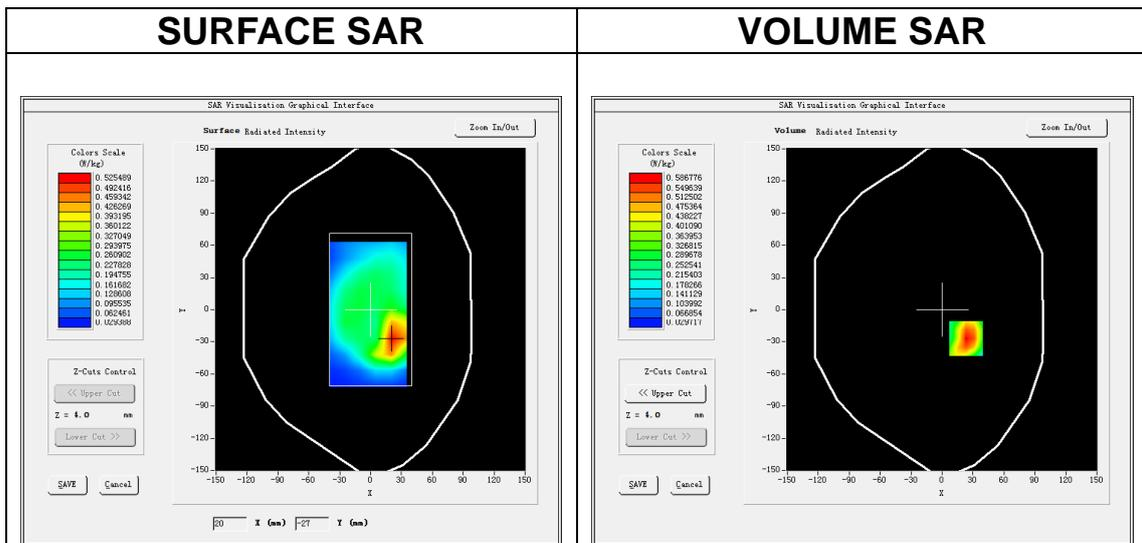

Maximum location: X=23.00, Y=-27.00
SAR Peak: 0.94 W/kg

SAR 10g (W/Kg)	0.314328
SAR 1g (W/Kg)	0.581448

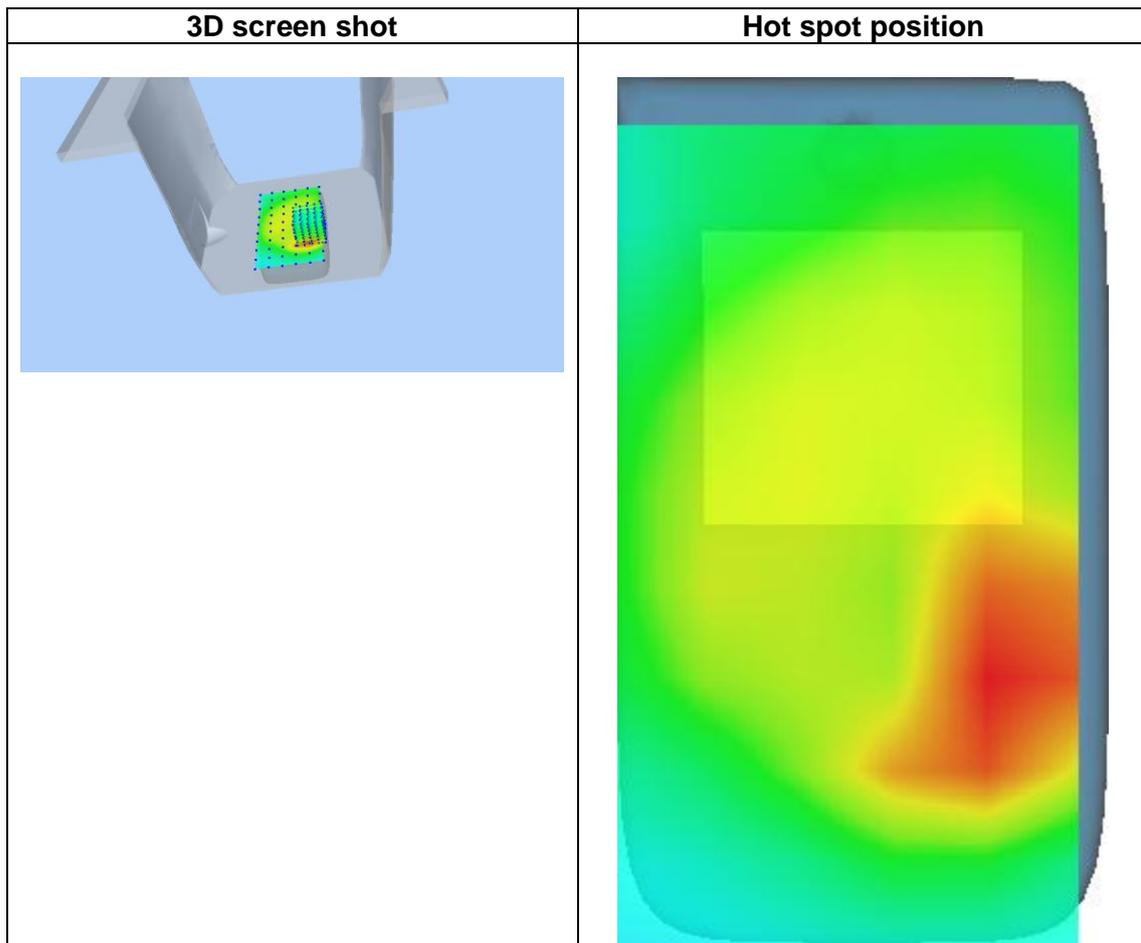
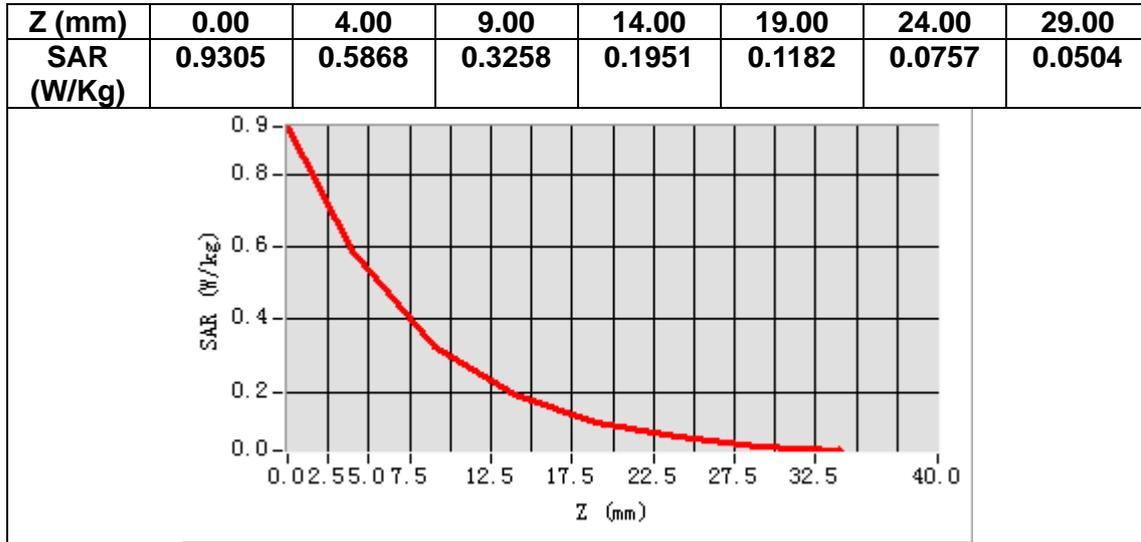

MEASUREMENT 5

Date of measurement: 11/1/2024

A. Experimental conditions.

Area Scan	<u>dx=15mm dy=15mm, h= 5.00 mm</u>
ZoomScan	<u>5x5x7, dx=8mm dy=8mm dz=5mm</u>
Phantom	<u>Left head</u>
Device Position	<u>Cheek</u>
Band	<u>Band2 WCDMA1900</u>
Channels	<u>Middle</u>
Signal	<u>WCDMA (Crest factor: 1.0)</u>
ConvF	<u>2.63</u>

B. SAR Measurement Results

Frequency (MHz)	1880.000000
Relative permittivity (real part)	39.207344
Relative permittivity (imaginary part)	13.887850
Conductivity (S/m)	1.450509
Variation (%)	4.850000

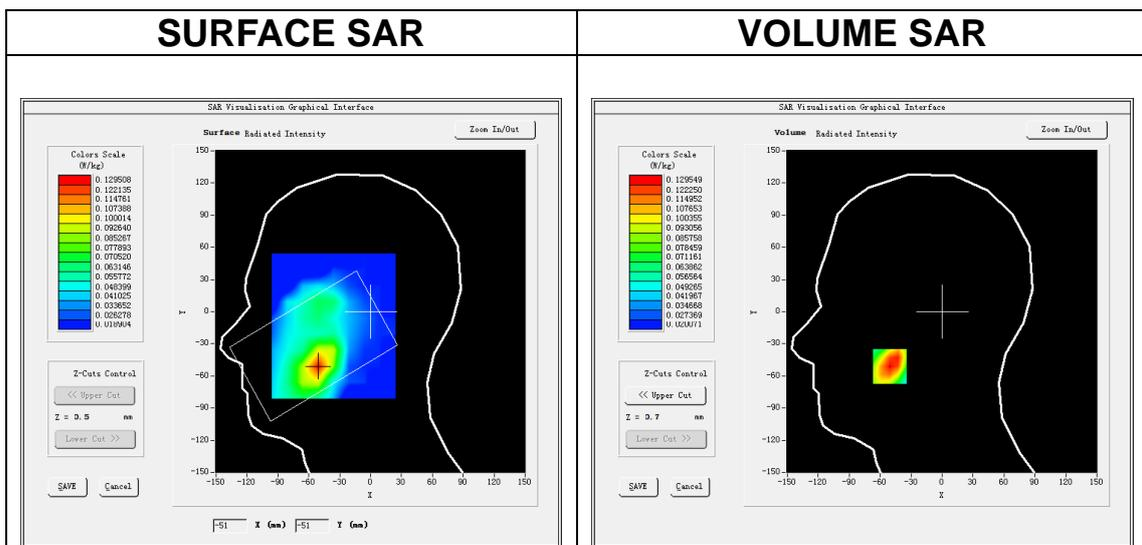

Maximum location: X=-51.00, Y=-51.00
SAR Peak: 0.19 W/kg

SAR 10g (W/Kg)	0.081360
SAR 1g (W/Kg)	0.129387

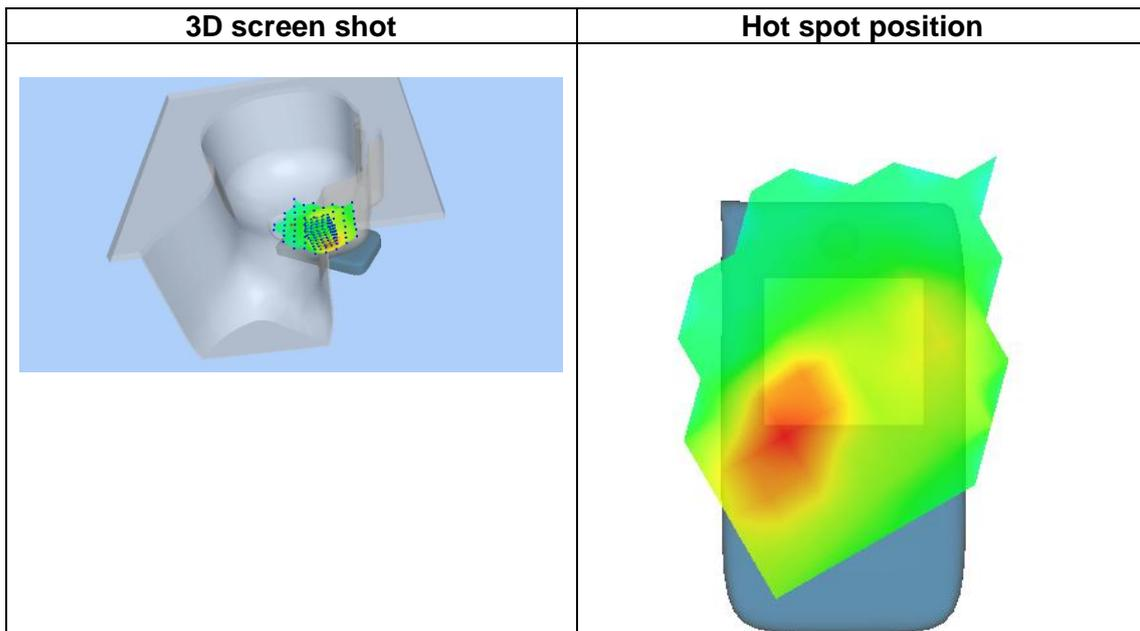
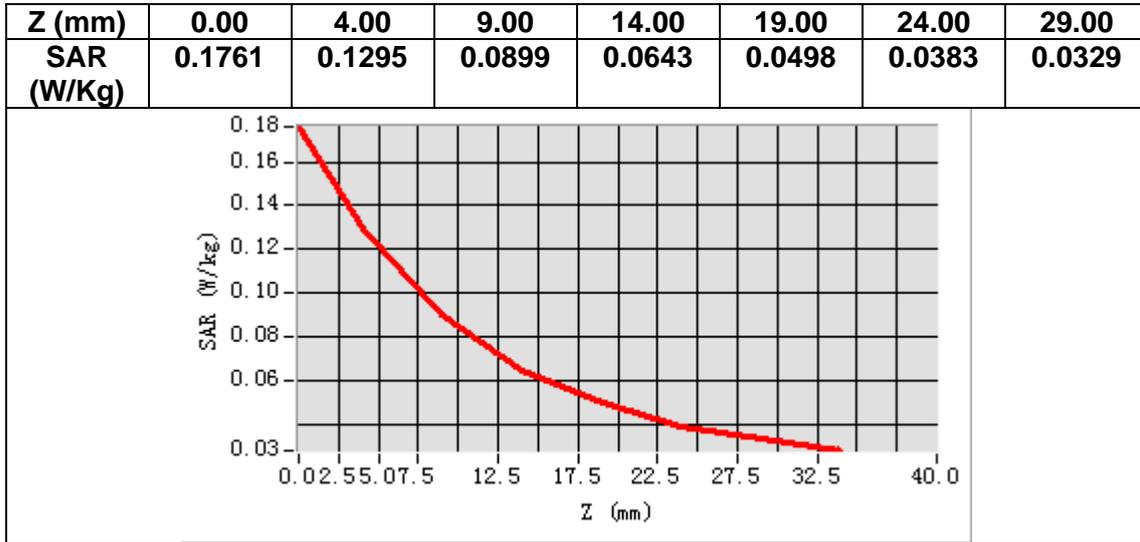

MEASUREMENT 6

Date of measurement: 11/1/2024

A. Experimental conditions.

Area Scan	<u>dx=15mm dy=15mm, h= 5.00 mm</u>
ZoomScan	<u>5x5x7, dx=8mm dy=8mm dz=5mm</u>
Phantom	<u>Validation plane</u>
Device Position	<u>Body</u>
Band	<u>Band2 WCDMA1900</u>
Channels	<u>Middle</u>
Signal	<u>WCDMA (Crest factor: 1.0)</u>
ConvF	<u>2.63</u>

B. SAR Measurement Results

Frequency (MHz)	1880.000000
Relative permittivity (real part)	39.207344
Relative permittivity (imaginary part)	13.887850
Conductivity (S/m)	1.450509
Variation (%)	-2.720000

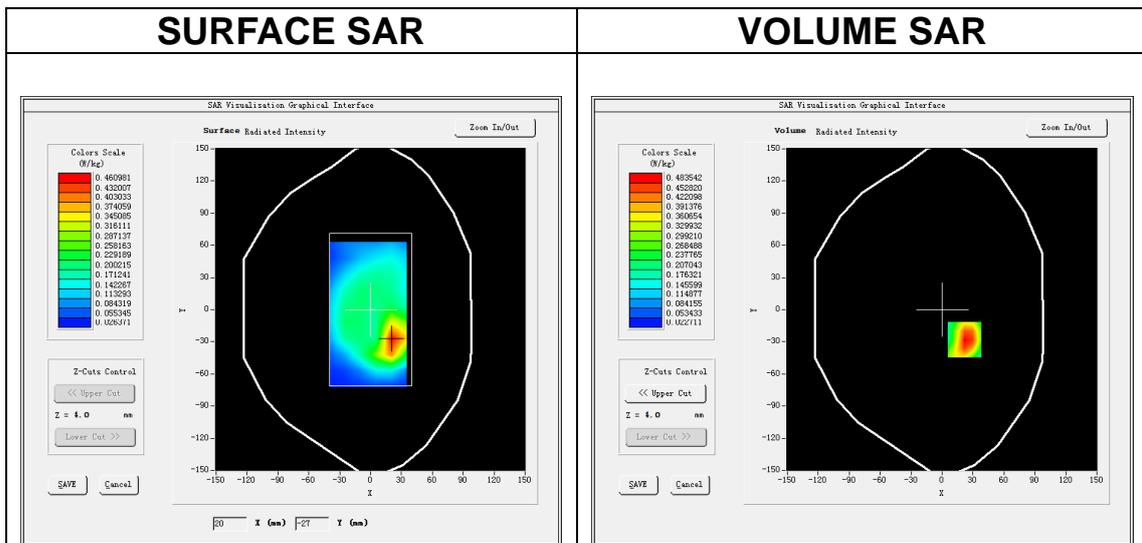

Maximum location: X=22.00, Y=-28.00
SAR Peak: 0.78 W/kg

SAR 10g (W/Kg)	0.262331
SAR 1g (W/Kg)	0.485189

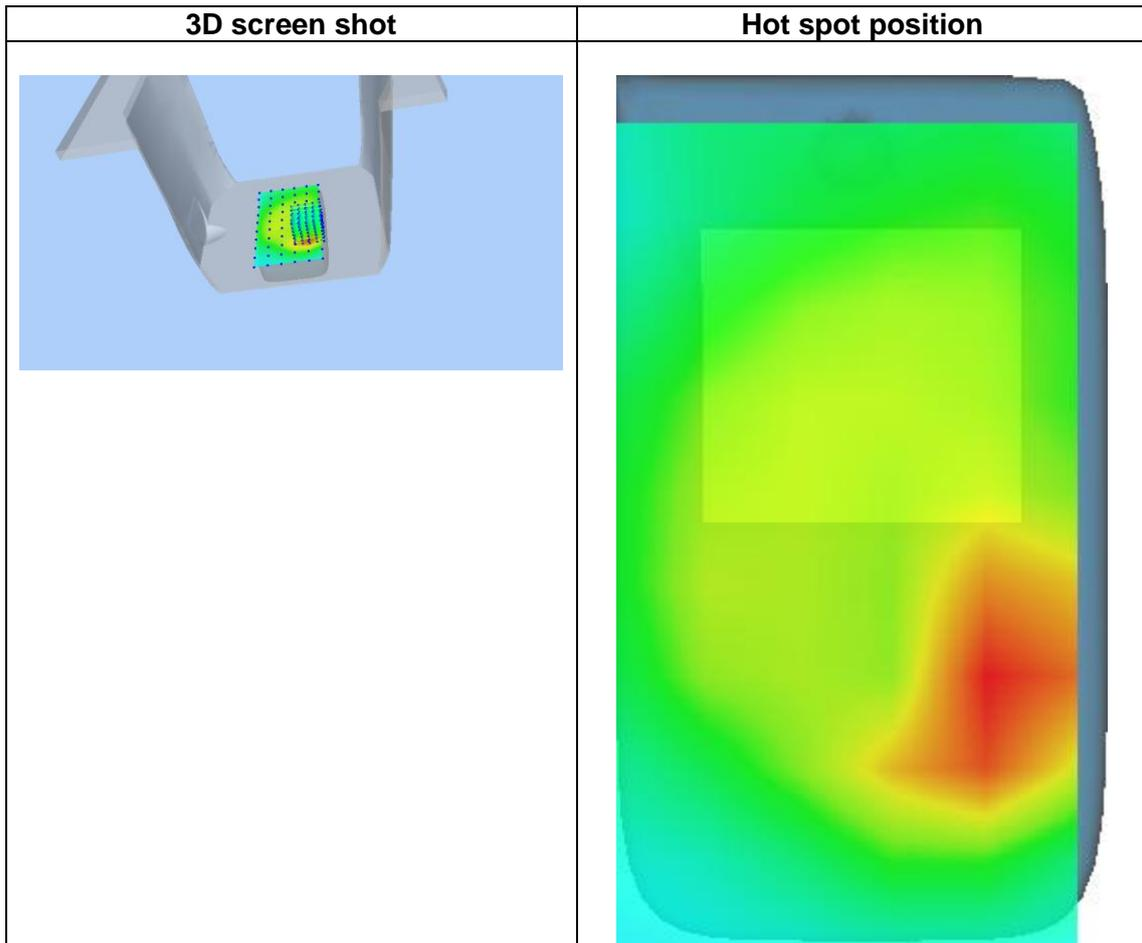
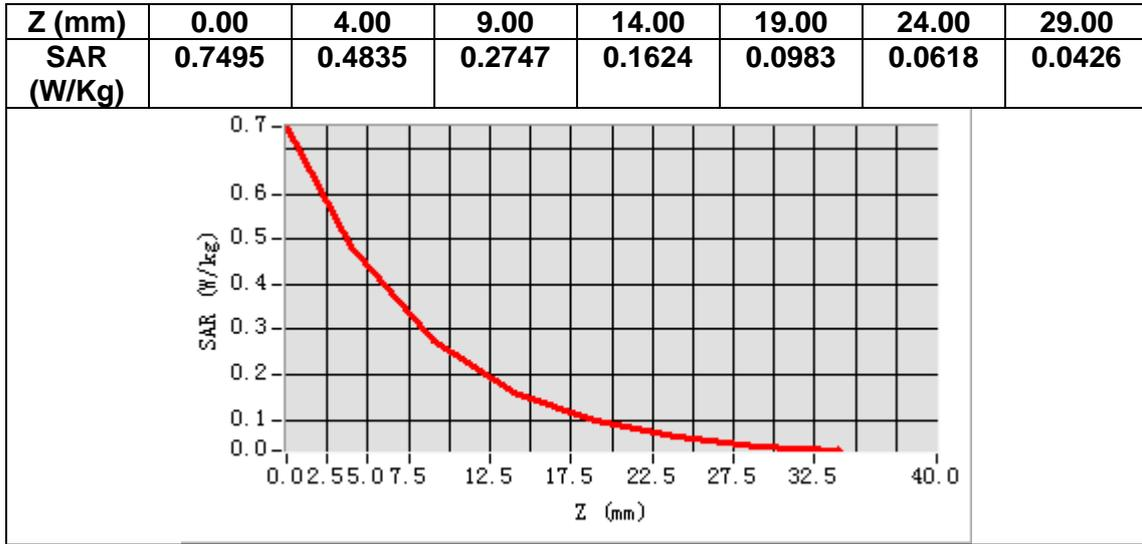

MEASUREMENT 7

Date of measurement: 8/1/2024

A. Experimental conditions.

Area Scan	<u>dx=15mm dy=15mm, h= 5.00 mm</u>
ZoomScan	<u>5x5x7,dx=8mm dy=8mm dz=5mm</u>
Phantom	<u>Left head</u>
Device Position	<u>Cheek</u>
Band	<u>Band4 WCDMA1700</u>
Channels	<u>Middle</u>
Signal	<u>WCDMA (Crest factor: 1.0)</u>
ConvF	<u>2.45</u>

B. SAR Measurement Results

Frequency (MHz)	1732.600000
Relative permittivity (real part)	39.995323
Relative permittivity (imaginary part)	13.840805
Conductivity (S/m)	1.331793
Variation (%)	2.320000

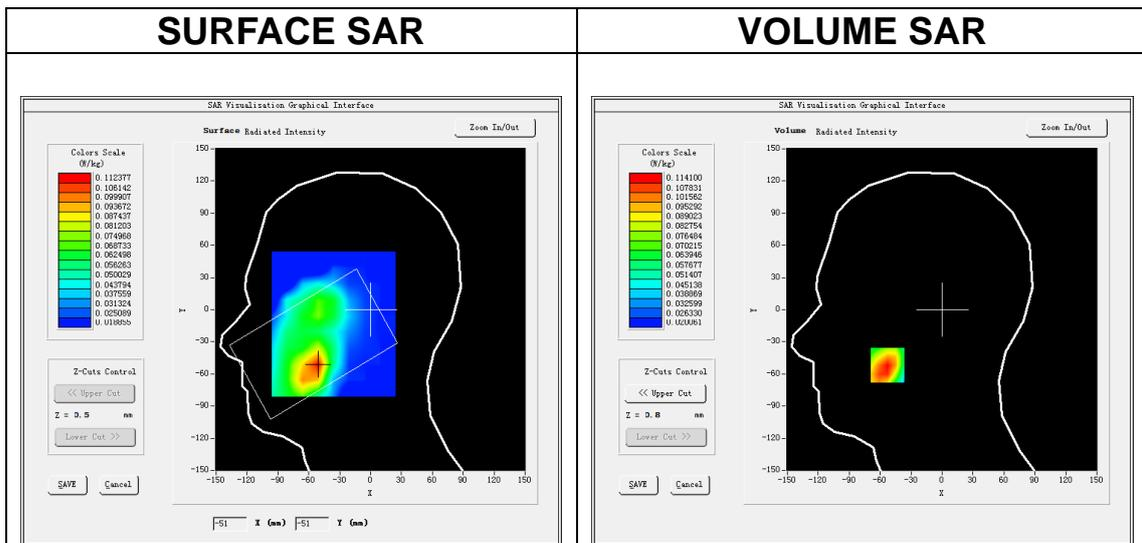

Maximum location: X=-53.00, Y=-52.00
SAR Peak: 0.16 W/kg

SAR 10g (W/Kg)	0.075010
SAR 1g (W/Kg)	0.110733

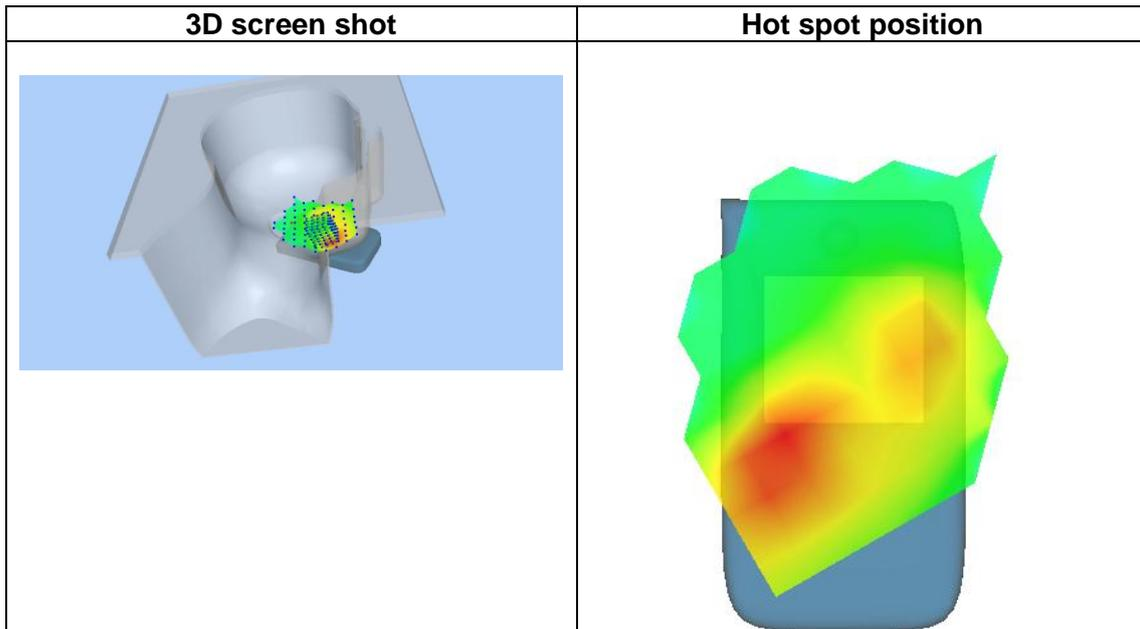
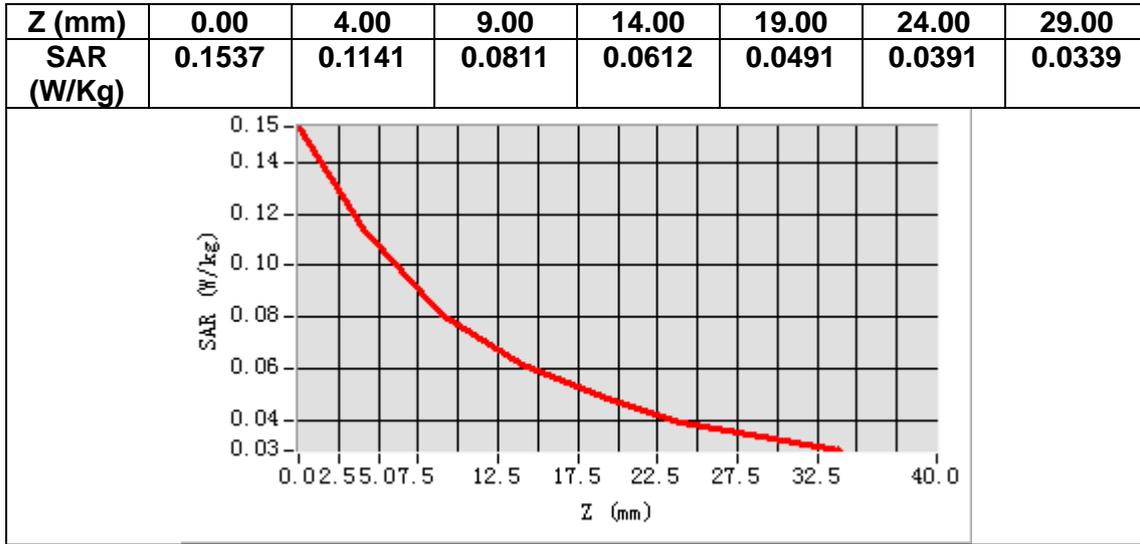

MEASUREMENT 8

Date of measurement: 8/1/2024

A. Experimental conditions.

Area Scan	<u>dx=15mm dy=15mm, h= 5.00 mm</u>
ZoomScan	<u>5x5x7, dx=8mm dy=8mm dz=5mm</u>
Phantom	<u>Validation plane</u>
Device Position	<u>Body</u>
Band	<u>Band4 WCDMA1700</u>
Channels	<u>Middle</u>
Signal	<u>WCDMA (Crest factor: 1.0)</u>
ConvF	<u>2.45</u>

B. SAR Measurement Results

Frequency (MHz)	1732.600000
Relative permittivity (real part)	39.995323
Relative permittivity (imaginary part)	13.840805
Conductivity (S/m)	1.331793
Variation (%)	-1.230000

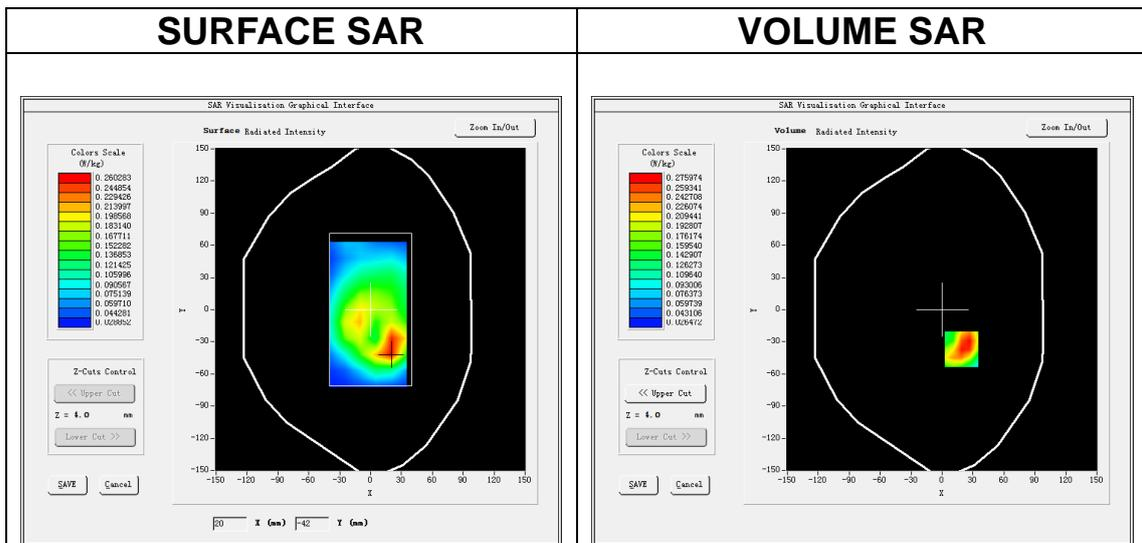

Maximum location: X=19.00, Y=-37.00
SAR Peak: 0.43 W/kg

SAR 10g (W/Kg)	0.155376
SAR 1g (W/Kg)	0.270272

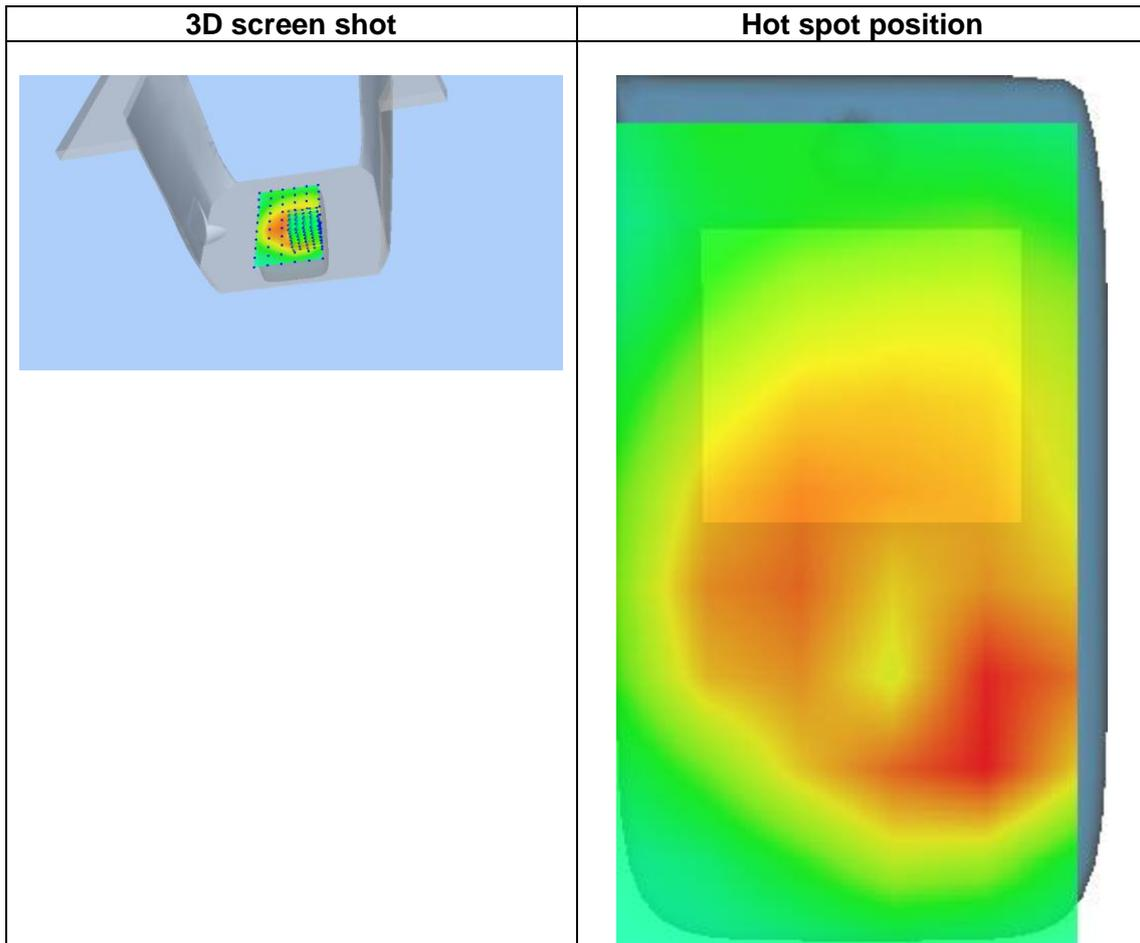
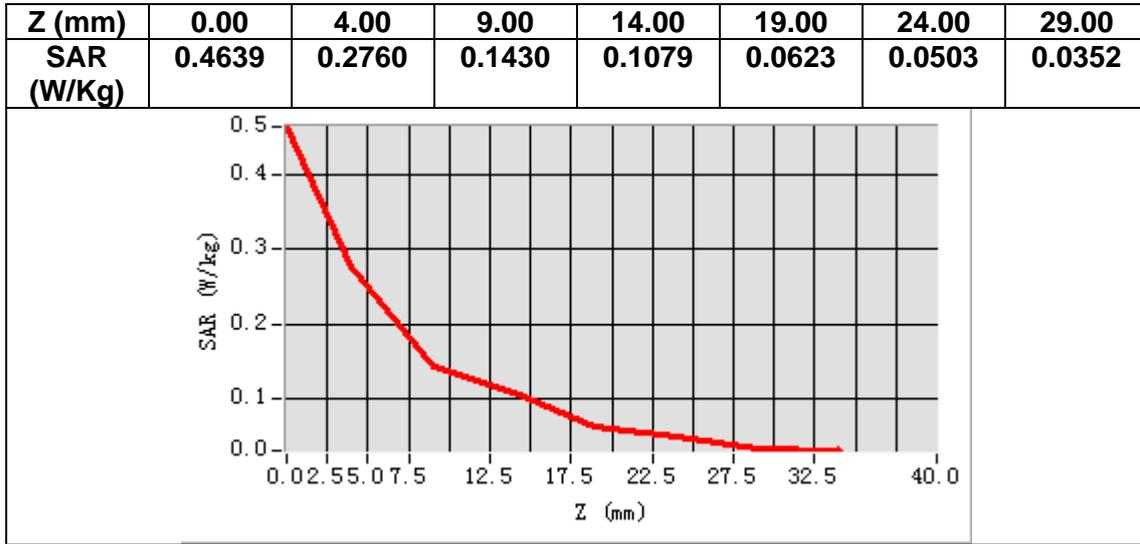

MEASUREMENT 9

Date of measurement: 10/1/2024

A. Experimental conditions.

Area Scan	<u>dx=15mm dy=15mm, h= 5.00 mm</u>
ZoomScan	<u>5x5x7,dx=8mm dy=8mm dz=5mm</u>
Phantom	<u>Left head</u>
Device Position	<u>Cheek</u>
Band	<u>Band5_WCDMA850</u>
Channels	<u>Middle</u>
Signal	<u>WCDMA (Crest factor: 1.0)</u>
ConvF	<u>2.32</u>

B. SAR Measurement Results

Frequency (MHz)	836.400000
Relative permittivity (real part)	41.267719
Relative permittivity (imaginary part)	19.206280
Conductivity (S/m)	0.892452
Variation (%)	3.890000

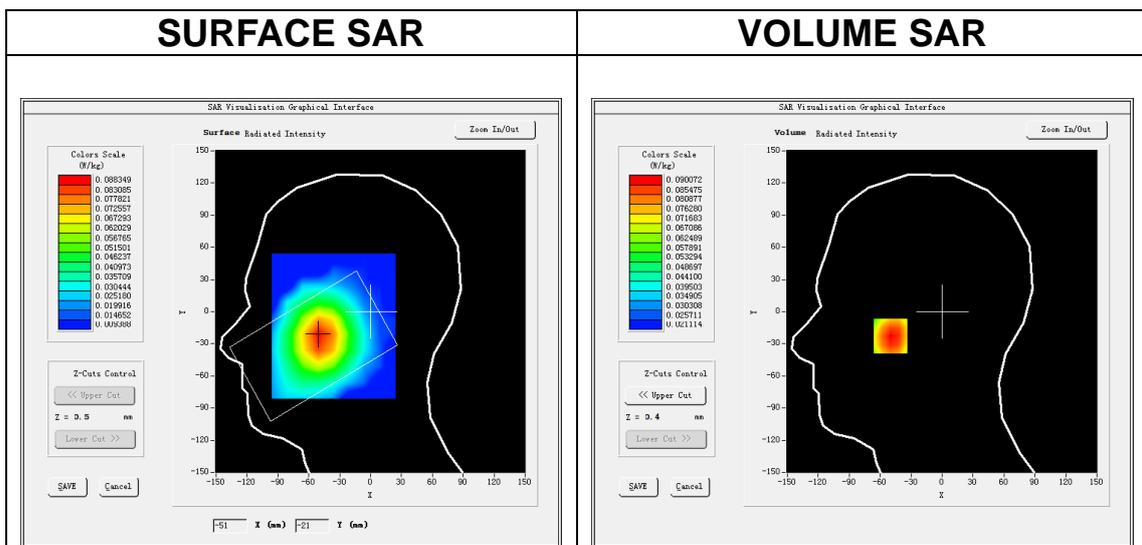

Maximum location: X=-50.00, Y=-23.00
SAR Peak: 0.11 W/kg

SAR 10g (W/Kg)	0.068353
SAR 1g (W/Kg)	0.088336

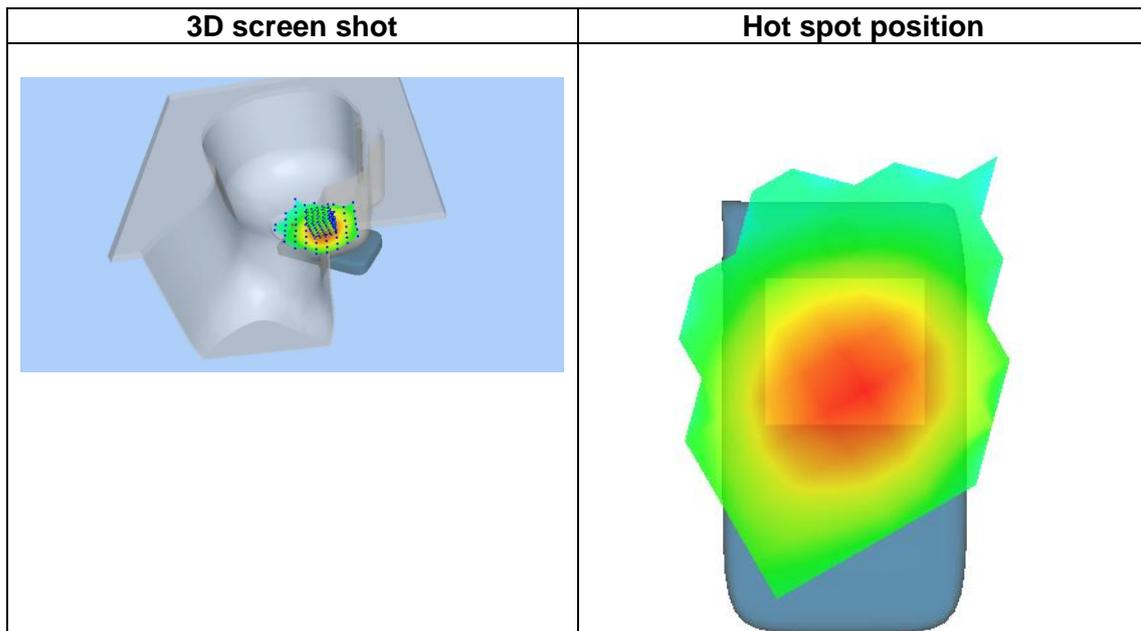
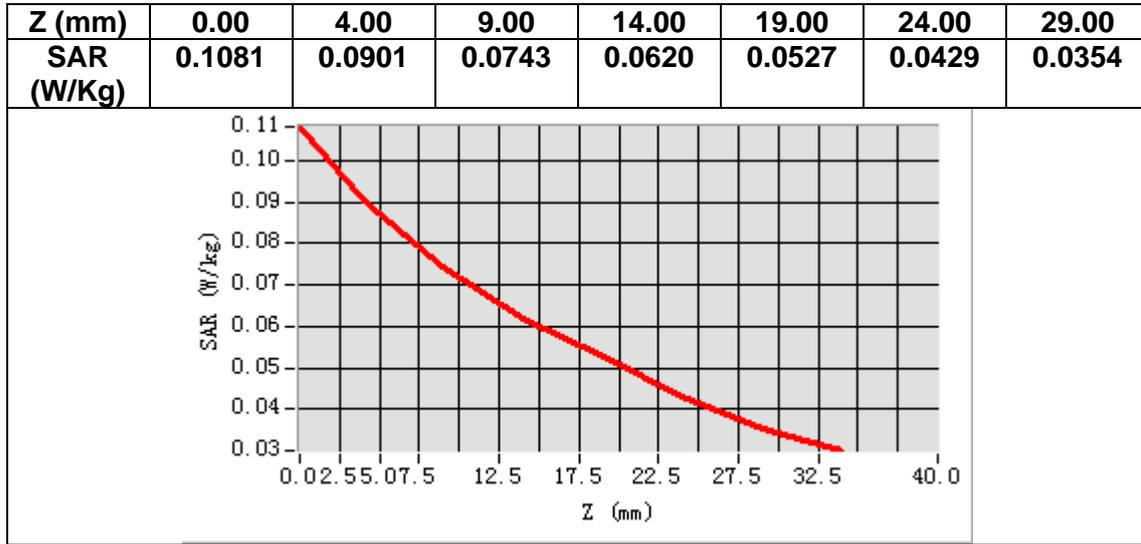

MEASUREMENT 10

Date of measurement: 10/1/2024

A. Experimental conditions.

Area Scan	<u>dx=15mm dy=15mm, h= 5.00 mm</u>
ZoomScan	<u>5x5x7, dx=8mm dy=8mm dz=5mm</u>
Phantom	<u>Validation plane</u>
Device Position	<u>Body</u>
Band	<u>Band5_WCDMA850</u>
Channels	<u>Middle</u>
Signal	<u>WCDMA (Crest factor: 1.0)</u>
ConvF	<u>2.32</u>

B. SAR Measurement Results

Frequency (MHz)	836.400000
Relative permittivity (real part)	41.267719
Relative permittivity (imaginary part)	19.206280
Conductivity (S/m)	0.892452
Variation (%)	-0.080000

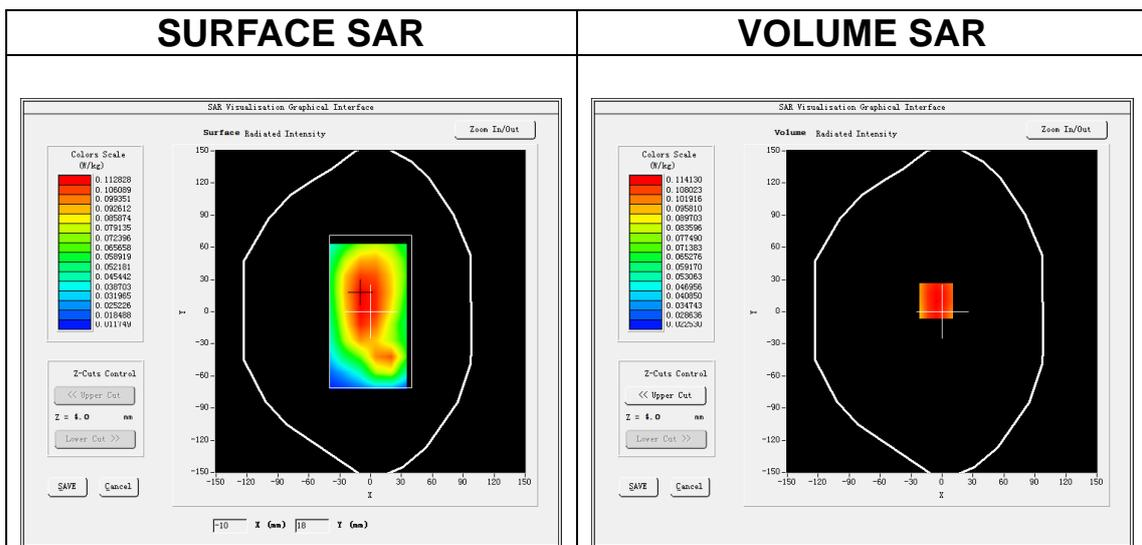

Maximum location: X=-6.00, Y=10.00
SAR Peak: 0.14 W/kg

SAR 10g (W/Kg)	0.085851
SAR 1g (W/Kg)	0.111336

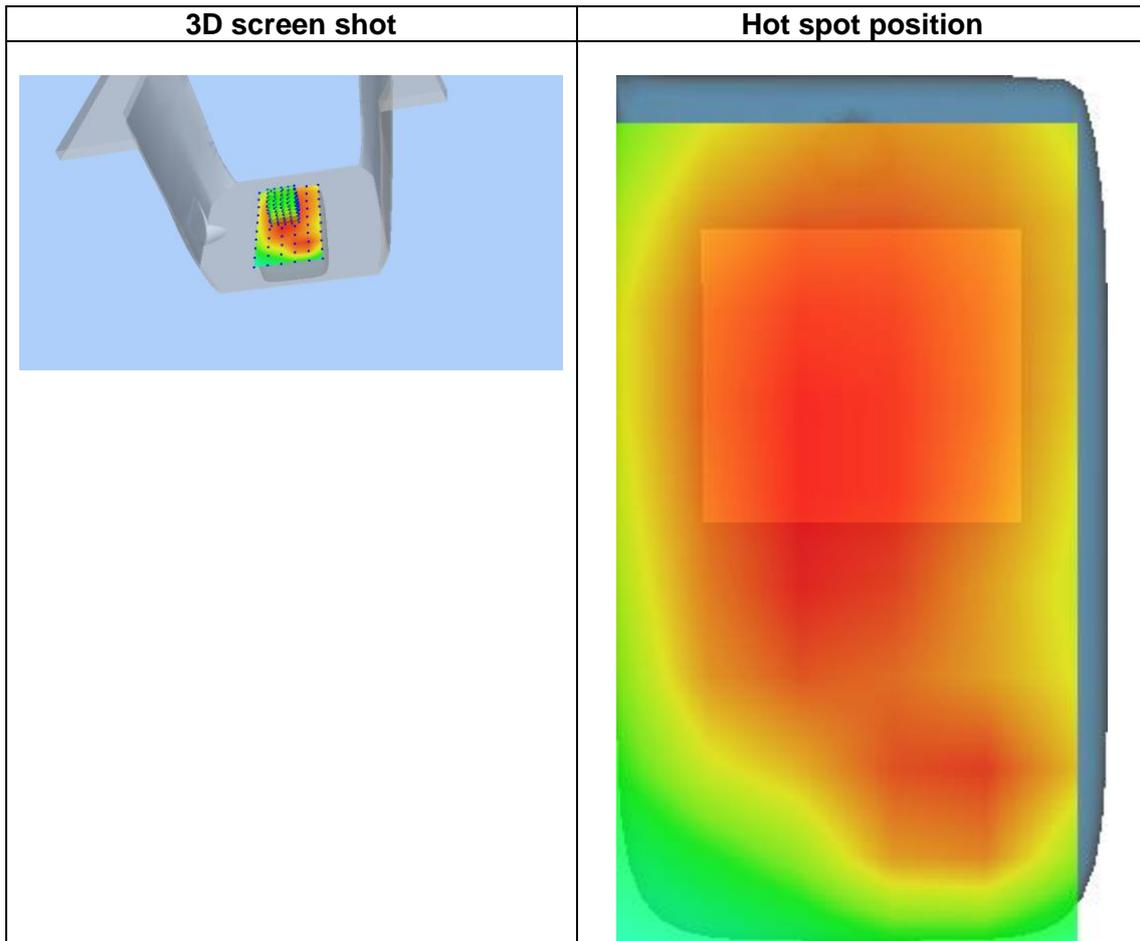
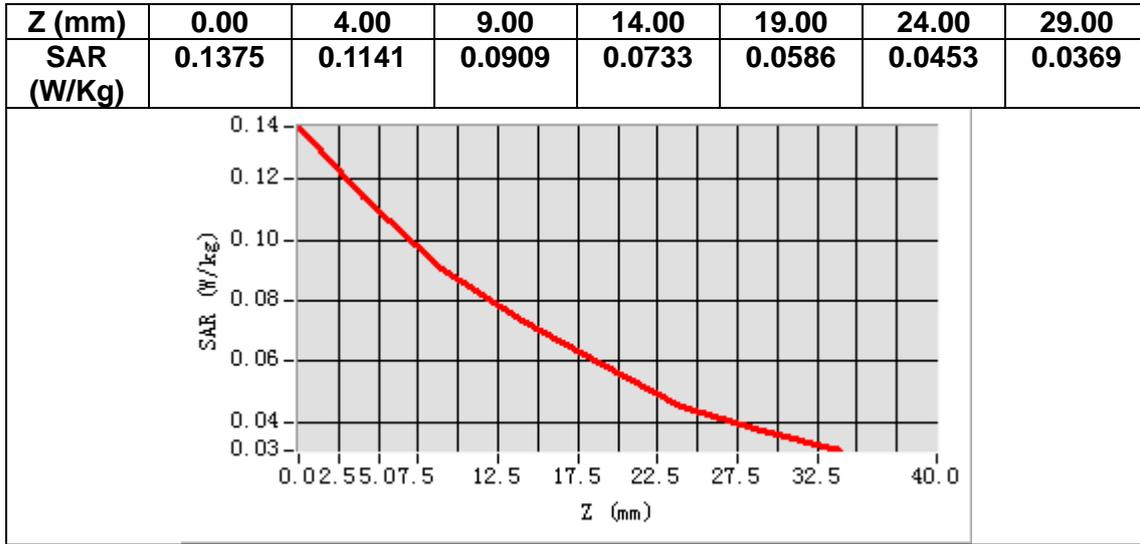

MEASUREMENT 11

Date of measurement: 9/1/2024

A. Experimental conditions.

Area Scan	<u>dx=12mm dy=12mm, h= 5.00 mm</u>
ZoomScan	<u>7x7x7,dx=5mm dy=5mm dz=5mm</u>
Phantom	<u>Left head</u>
Device Position	<u>Cheek</u>
Band	<u>IEEE 802.11b ISM</u>
Channels	<u>Middle</u>
Signal	<u>IEEE802.11b (Crest factor: 1.0)</u>
ConvF	<u>2.85</u>

B. SAR Measurement Results

Frequency (MHz)	2437.000000
Relative permittivity (real part)	38.364342
Relative permittivity (imaginary part)	12.781736
Conductivity (S/m)	1.730505
Variation (%)	-0.930000

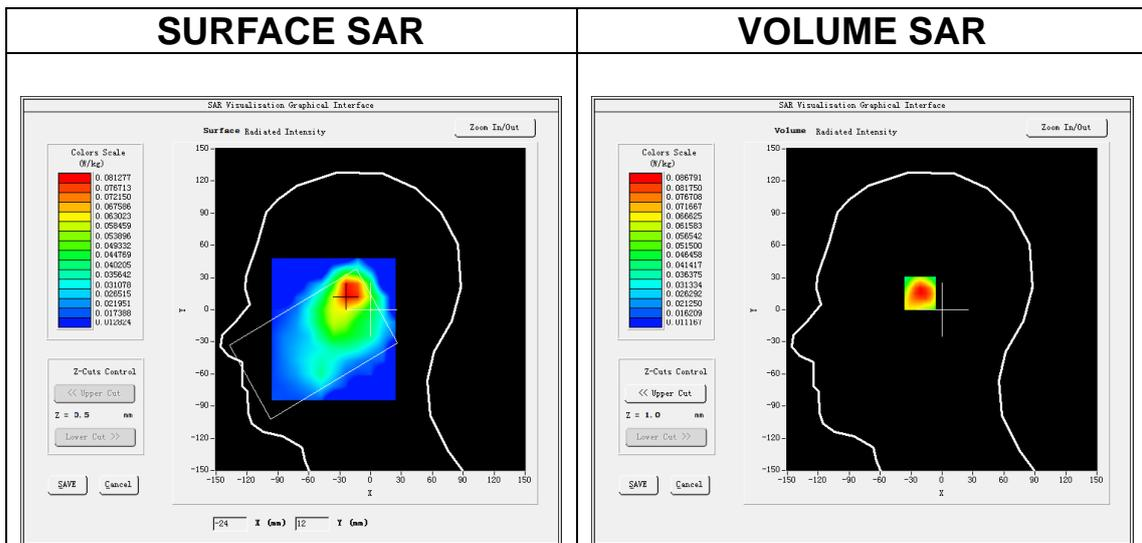

Maximum location: X=-20.00, Y=17.00
SAR Peak: 0.14 W/kg

SAR 10g (W/Kg)	0.048292
SAR 1g (W/Kg)	0.083080

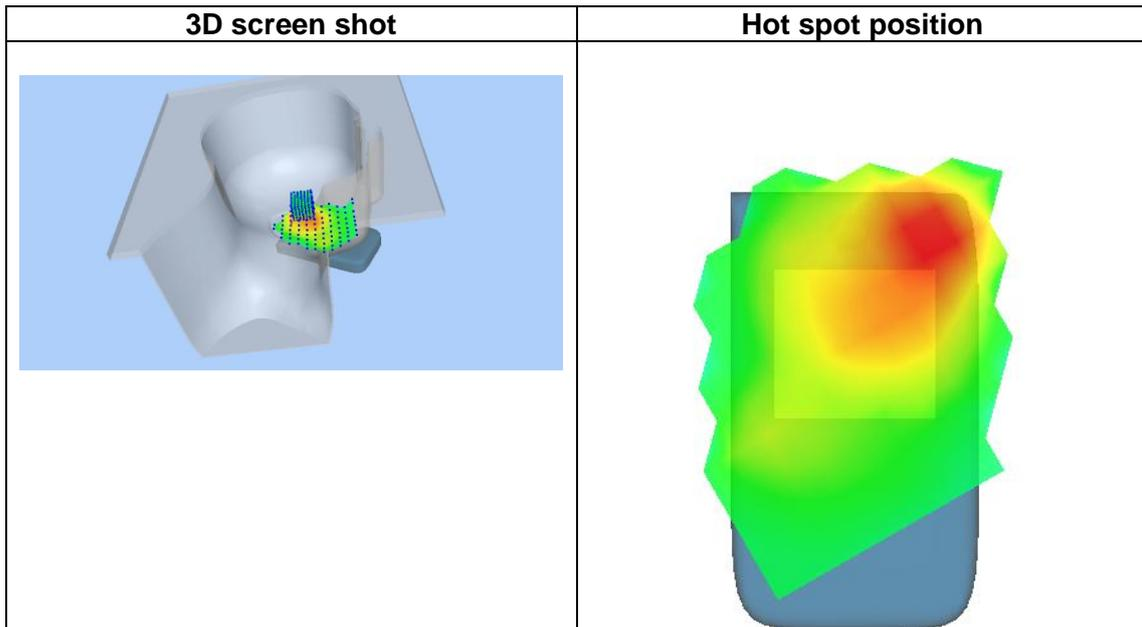
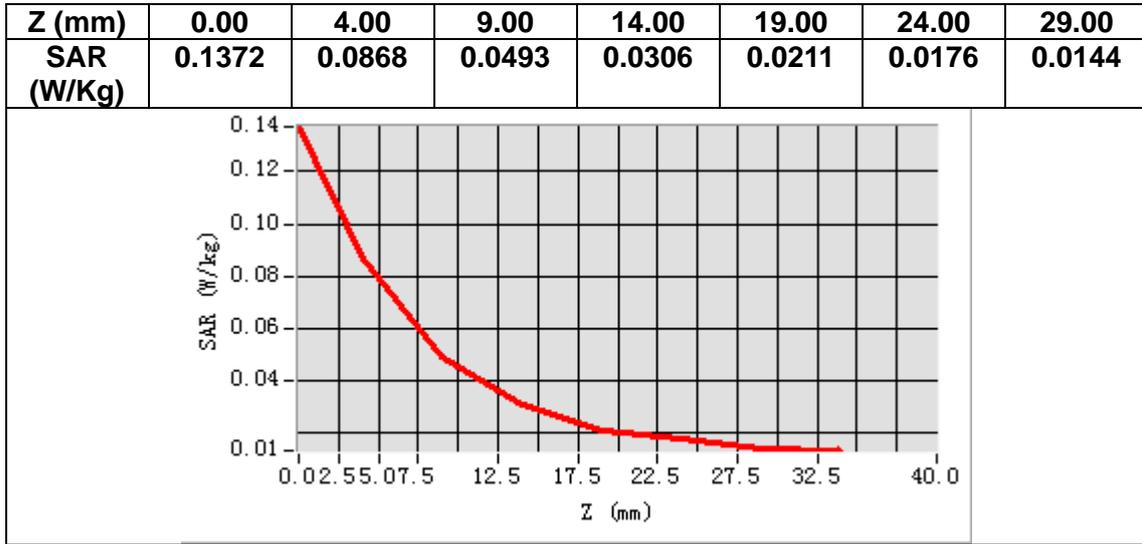

MEASUREMENT 12

Date of measurement: 9/1/2024

A. Experimental conditions.

Area Scan	<u>dx=12mm dy=12mm, h= 5.00 mm</u>
ZoomScan	<u>7x7x7, dx=5mm dy=5mm dz=5mm</u>
Phantom	<u>Validation plane</u>
Device Position	<u>Body</u>
Band	<u>IEEE 802.11b ISM</u>
Channels	<u>Middle</u>
Signal	<u>IEEE802.11b (Crest factor: 1.0)</u>
ConvF	<u>2.85</u>

B. SAR Measurement Results

Frequency (MHz)	2437.000000
Relative permittivity (real part)	38.364342
Relative permittivity (imaginary part)	12.781736
Conductivity (S/m)	1.730505
Variation (%)	1.930000

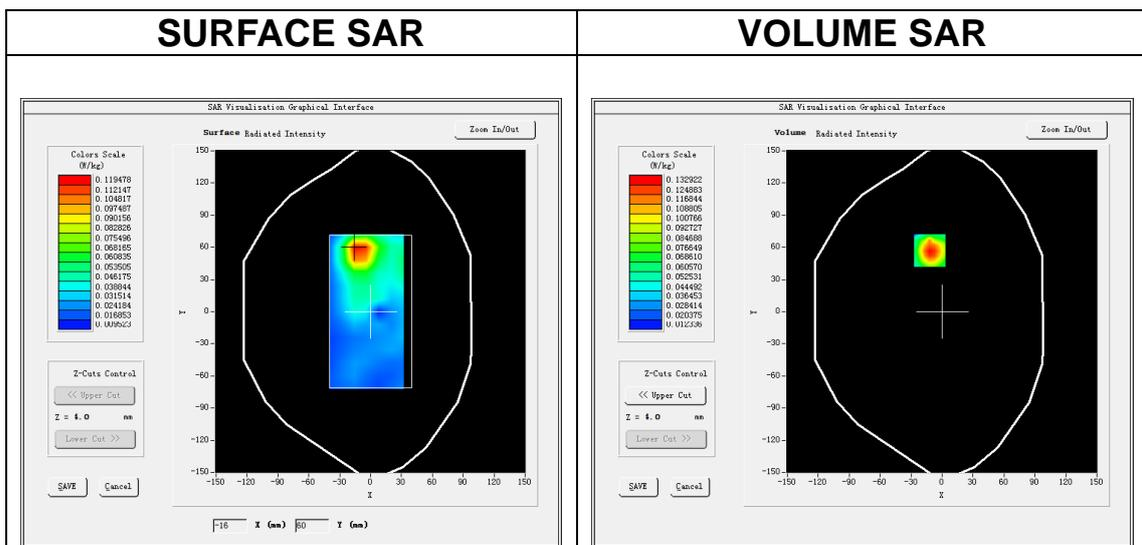

Maximum location: X=-12.00, Y=57.00
SAR Peak: 0.22 W/kg

SAR 10g (W/Kg)	0.065215
SAR 1g (W/Kg)	0.124739

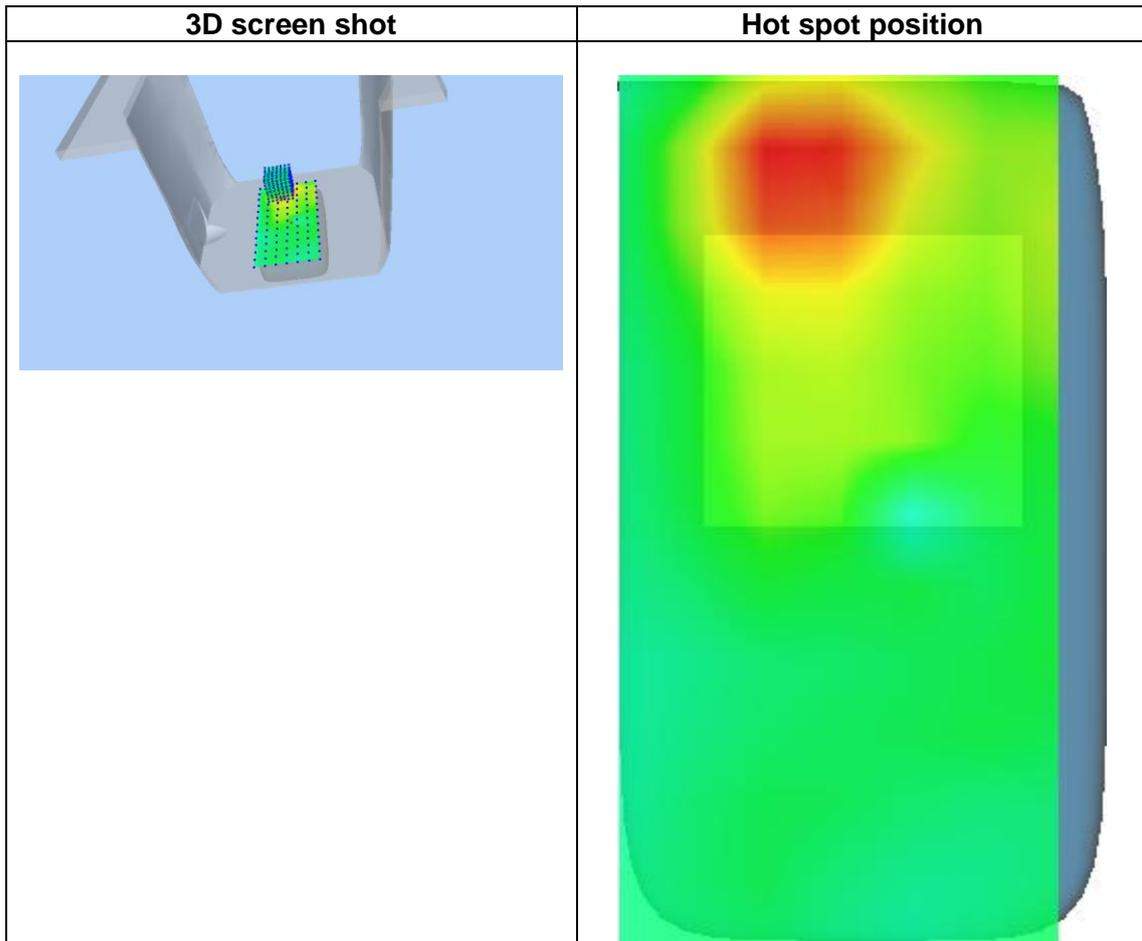
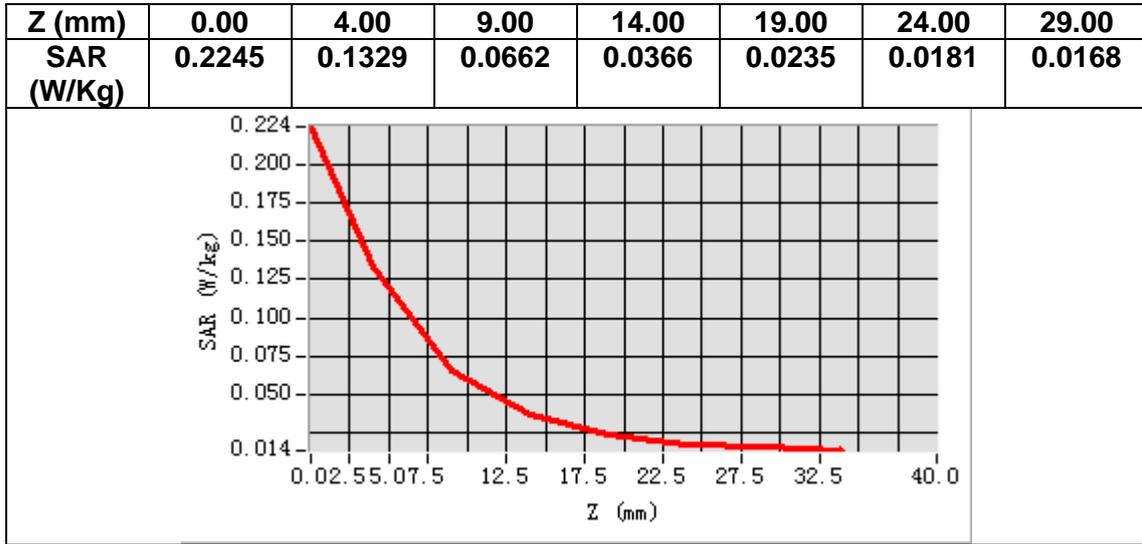

MEASUREMENT 13

Date of measurement: 11/1/2024

A. Experimental conditions.

Area Scan	<u>dx=15mm dy=15mm, h= 5.00 mm</u>
ZoomScan	<u>5x5x7,dx=8mm dy=8mm dz=5mm</u>
Phantom	<u>Left head</u>
Device Position	<u>Cheek</u>
Band	<u>LTE band 2</u>
Channels	<u>Middle</u>
Signal	<u>LTE (Crest factor: 1.0)</u>
ConvF	<u>2.63</u>

B. SAR Measurement Results

Frequency (MHz)	1880.000000
Relative permittivity (real part)	39.207344
Relative permittivity (imaginary part)	13.887850
Conductivity (S/m)	1.450509
Variation (%)	0.520000

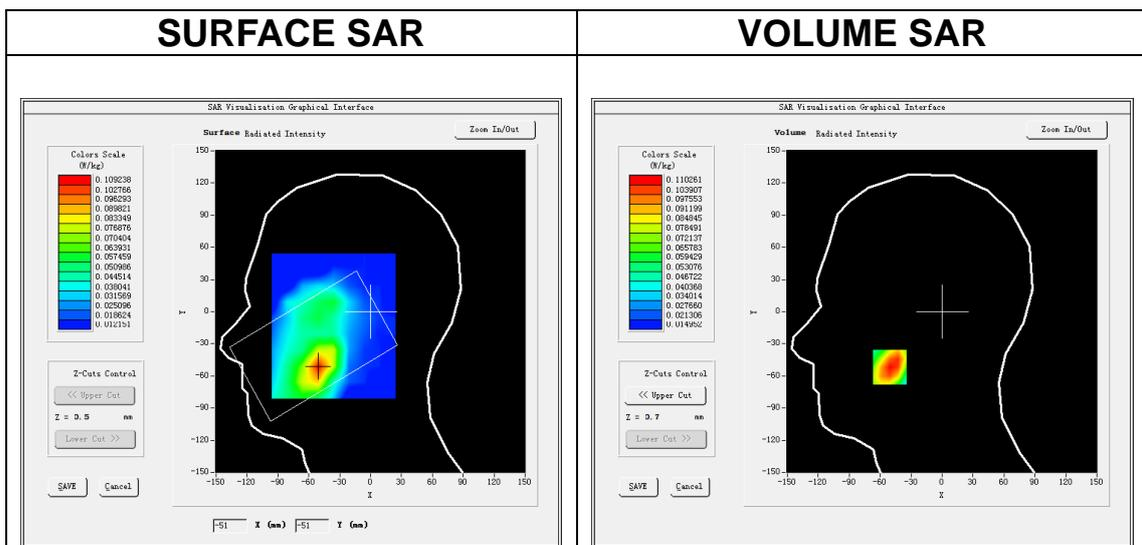

Maximum location: X=-51.00, Y=-52.00
SAR Peak: 0.16 W/kg

SAR 10g (W/Kg)	0.068465
SAR 1g (W/Kg)	0.109207

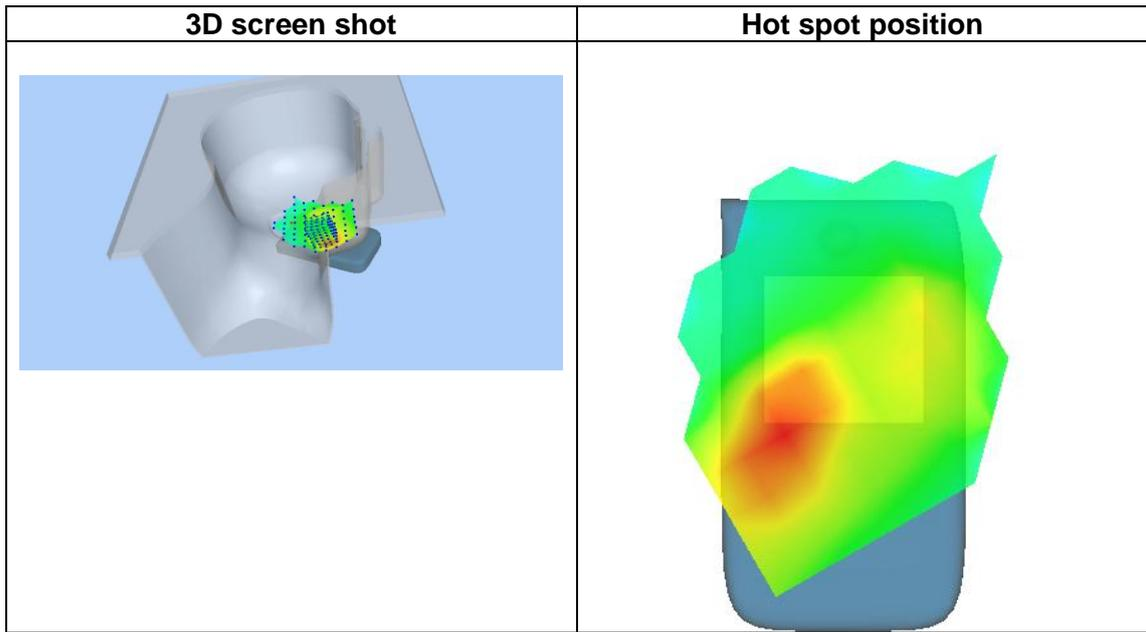
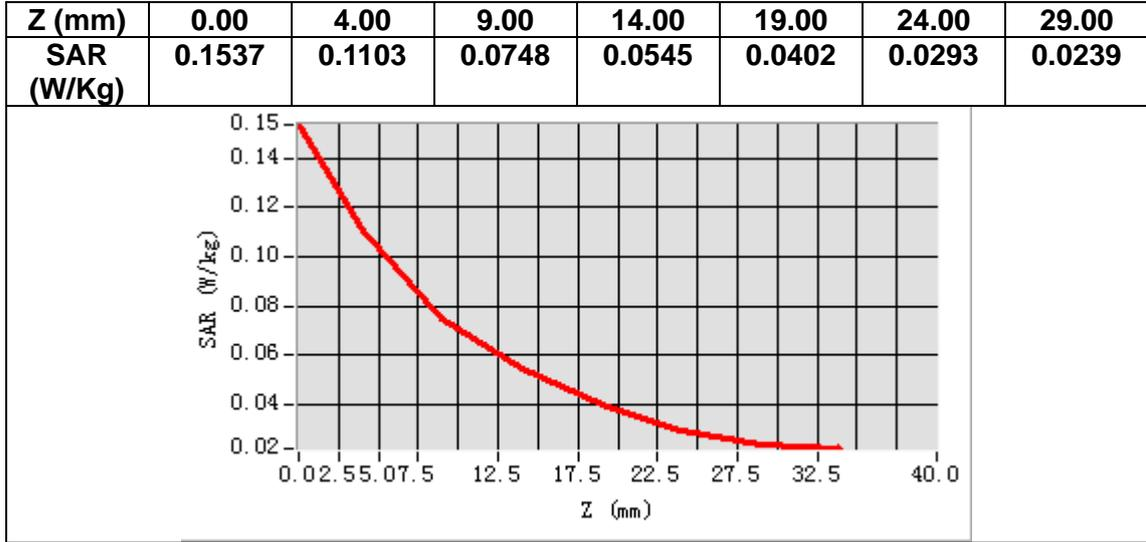

MEASUREMENT 14

Date of measurement: 11/1/2024

A. Experimental conditions.

Area Scan	<u>dx=15mm dy=15mm, h= 5.00 mm</u>
ZoomScan	<u>5x5x7, dx=8mm dy=8mm dz=5mm</u>
Phantom	<u>Validation plane</u>
Device Position	<u>Body</u>
Band	<u>LTE band 2</u>
Channels	<u>Middle</u>
Signal	<u>LTE (Crest factor: 1.0)</u>
ConvF	<u>2.63</u>

B. SAR Measurement Results

Frequency (MHz)	1880.000000
Relative permittivity (real part)	39.207344
Relative permittivity (imaginary part)	13.887850
Conductivity (S/m)	1.450509
Variation (%)	-4.090000

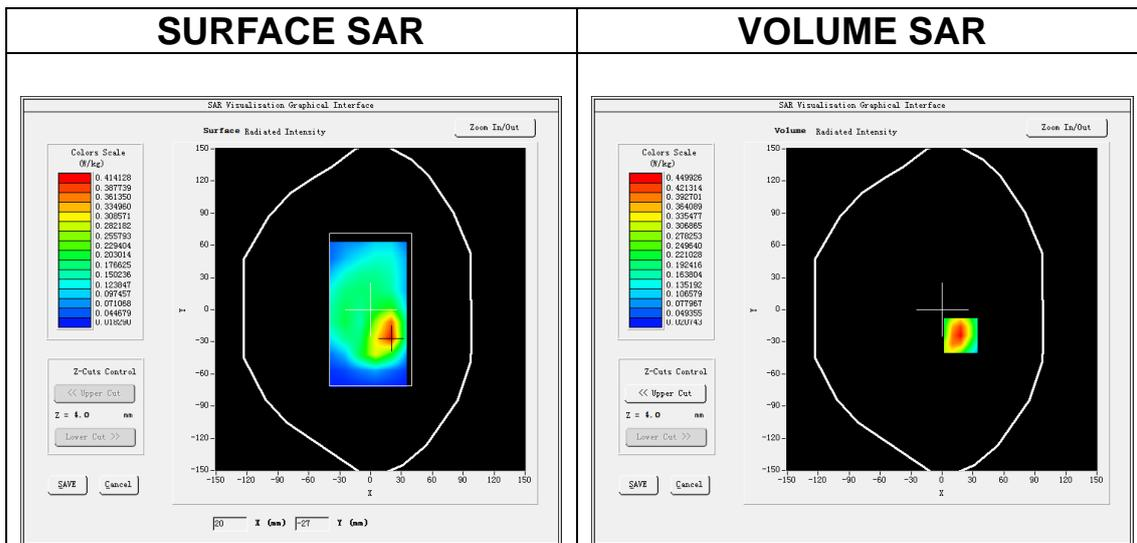

Maximum location: X=18.00, Y=-24.00
SAR Peak: 0.71 W/kg

SAR 10g (W/Kg)	0.238144
SAR 1g (W/Kg)	0.442168

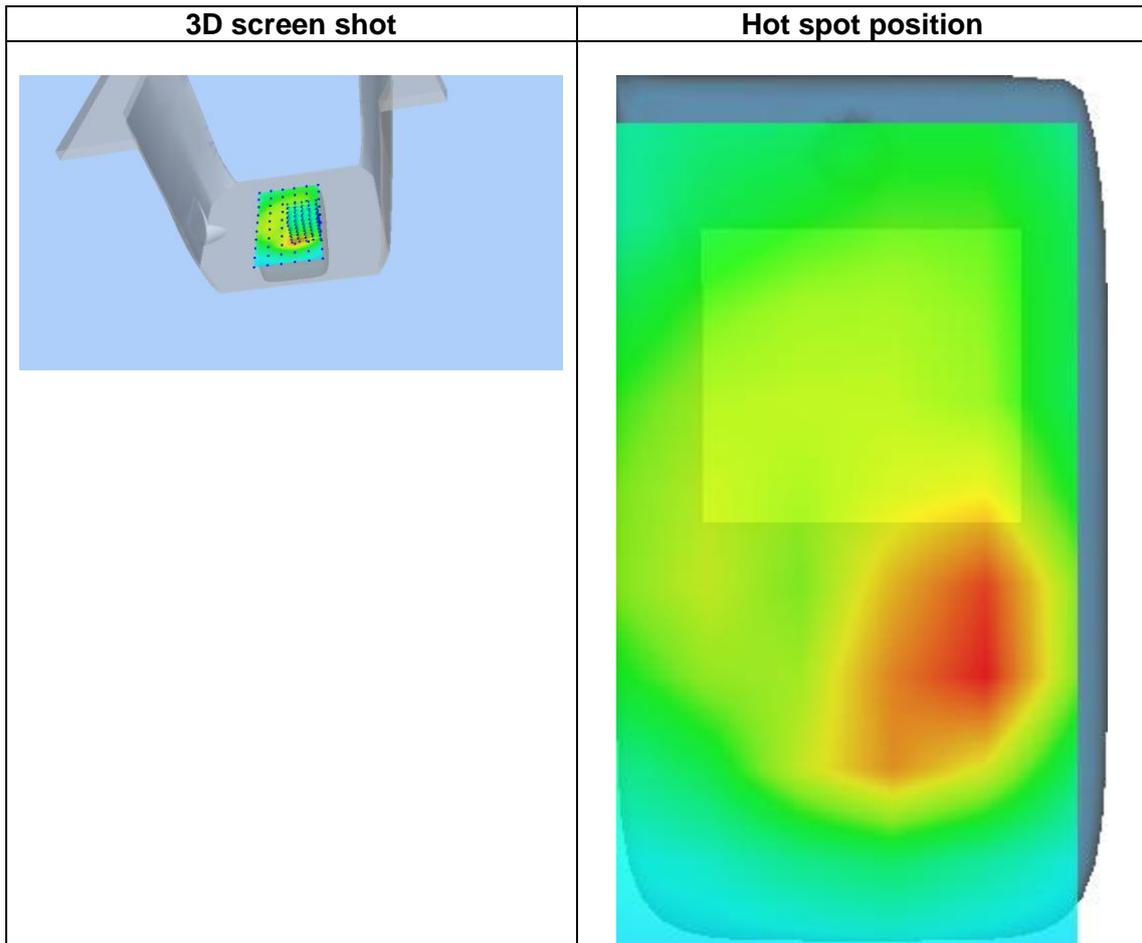
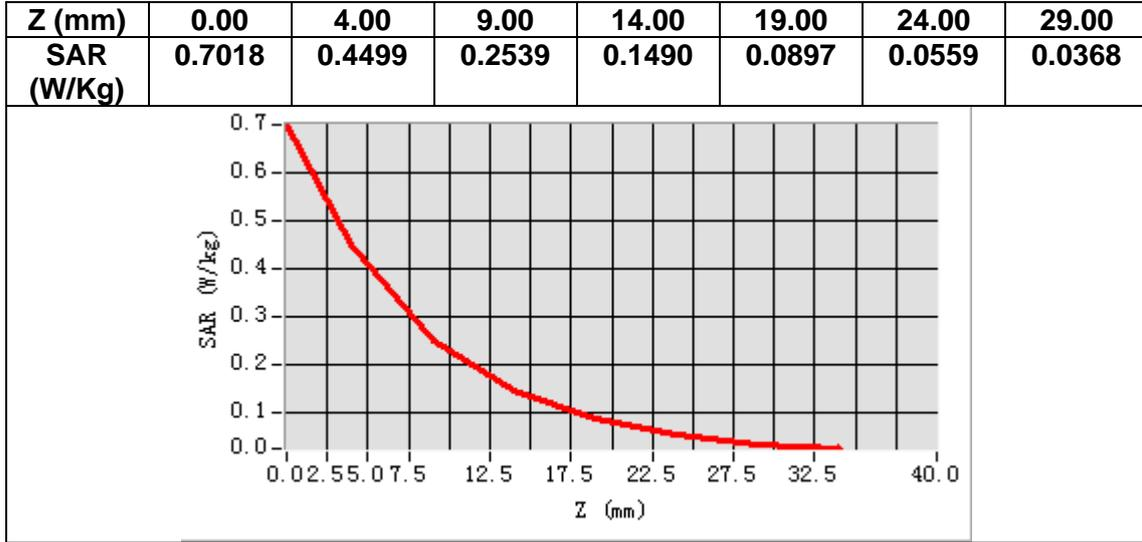

MEASUREMENT 15

Date of measurement: 8/1/2024

A. Experimental conditions.

Area Scan	<u>dx=15mm dy=15mm, h= 5.00 mm</u>
ZoomScan	<u>5x5x7,dx=8mm dy=8mm dz=5mm</u>
Phantom	<u>Left head</u>
Device Position	<u>Cheek</u>
Band	<u>LTE band 4</u>
Channels	<u>Middle</u>
Signal	<u>LTE (Crest factor: 1.0)</u>
ConvF	<u>2.45</u>

B. SAR Measurement Results

Frequency (MHz)	1732.500000
Relative permittivity (real part)	40.003223
Relative permittivity (imaginary part)	13.825655
Conductivity (S/m)	1.330719
Variation (%)	3.560000

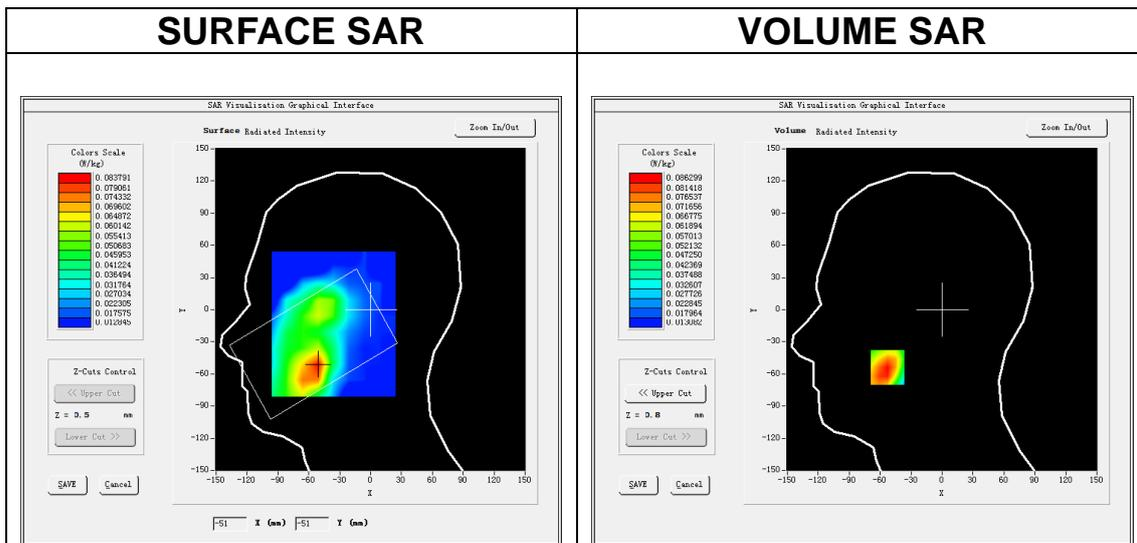

Maximum location: X=-53.00, Y=-54.00
SAR Peak: 0.12 W/kg

SAR 10g (W/Kg)	0.056370
SAR 1g (W/Kg)	0.083667

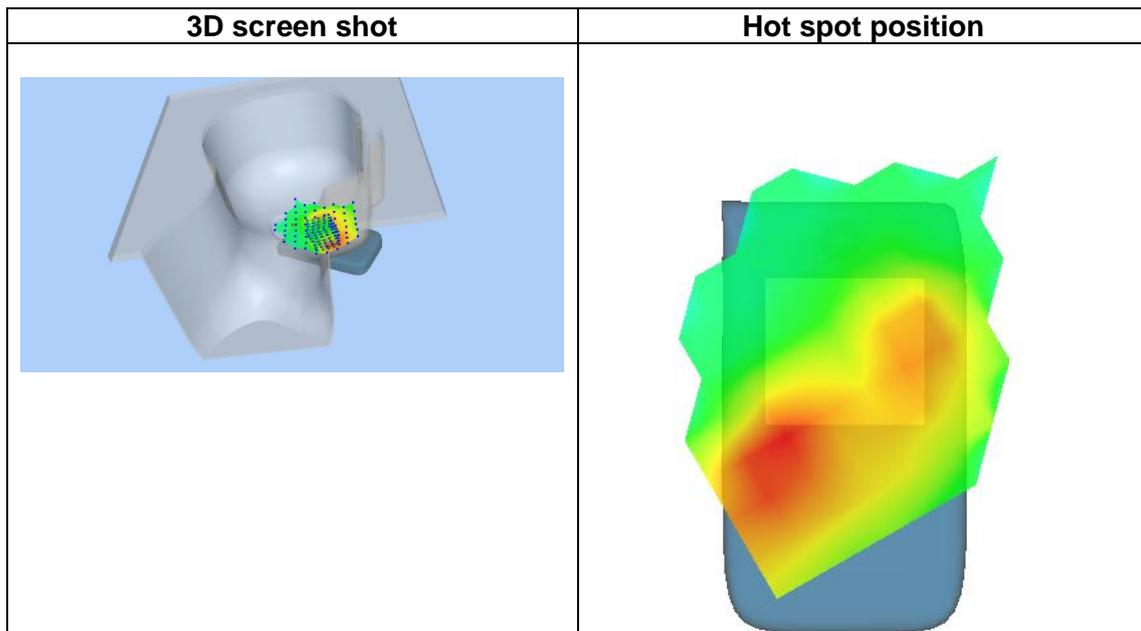
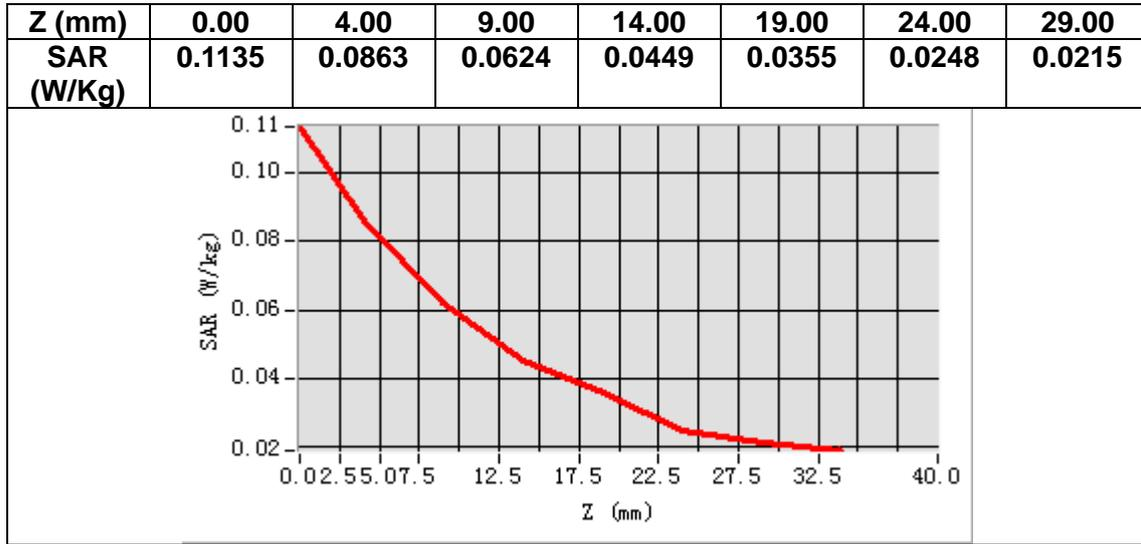

MEASUREMENT 16

Date of measurement: 8/1/2024

A. Experimental conditions.

Area Scan	<u>dx=15mm dy=15mm, h= 5.00 mm</u>
ZoomScan	<u>5x5x7, dx=8mm dy=8mm dz=5mm</u>
Phantom	<u>Validation plane</u>
Device Position	<u>Body</u>
Band	<u>LTE band 4</u>
Channels	<u>Middle</u>
Signal	<u>LTE (Crest factor: 1.0)</u>
ConvF	<u>2.45</u>

B. SAR Measurement Results

Frequency (MHz)	1732.500000
Relative permittivity (real part)	40.003223
Relative permittivity (imaginary part)	13.825655
Conductivity (S/m)	1.330719
Variation (%)	-0.610000

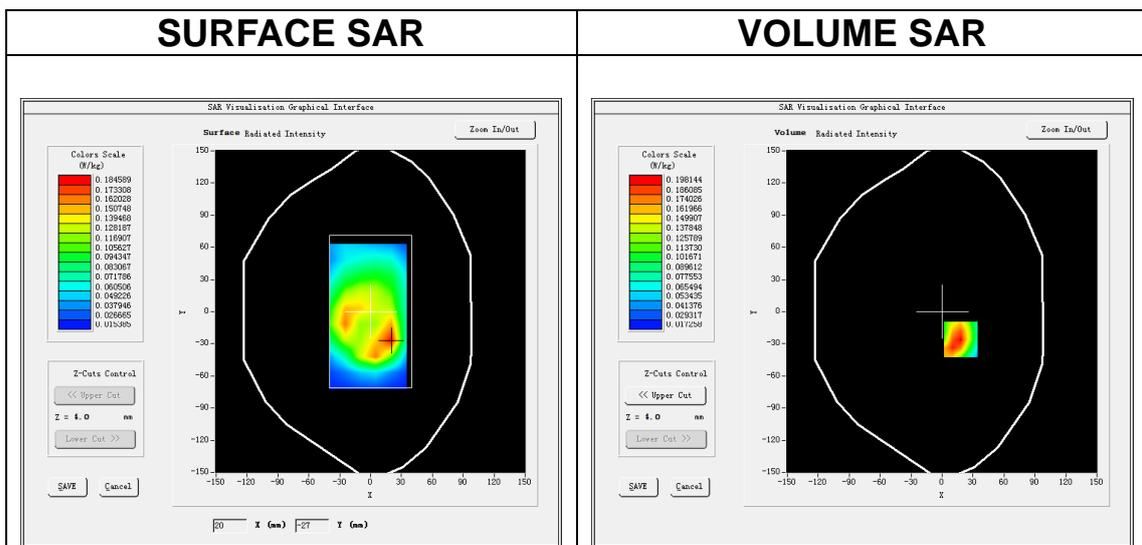

Maximum location: X=18.00, Y=-26.00
SAR Peak: 0.30 W/kg

SAR 10g (W/Kg)	0.109765
SAR 1g (W/Kg)	0.191474

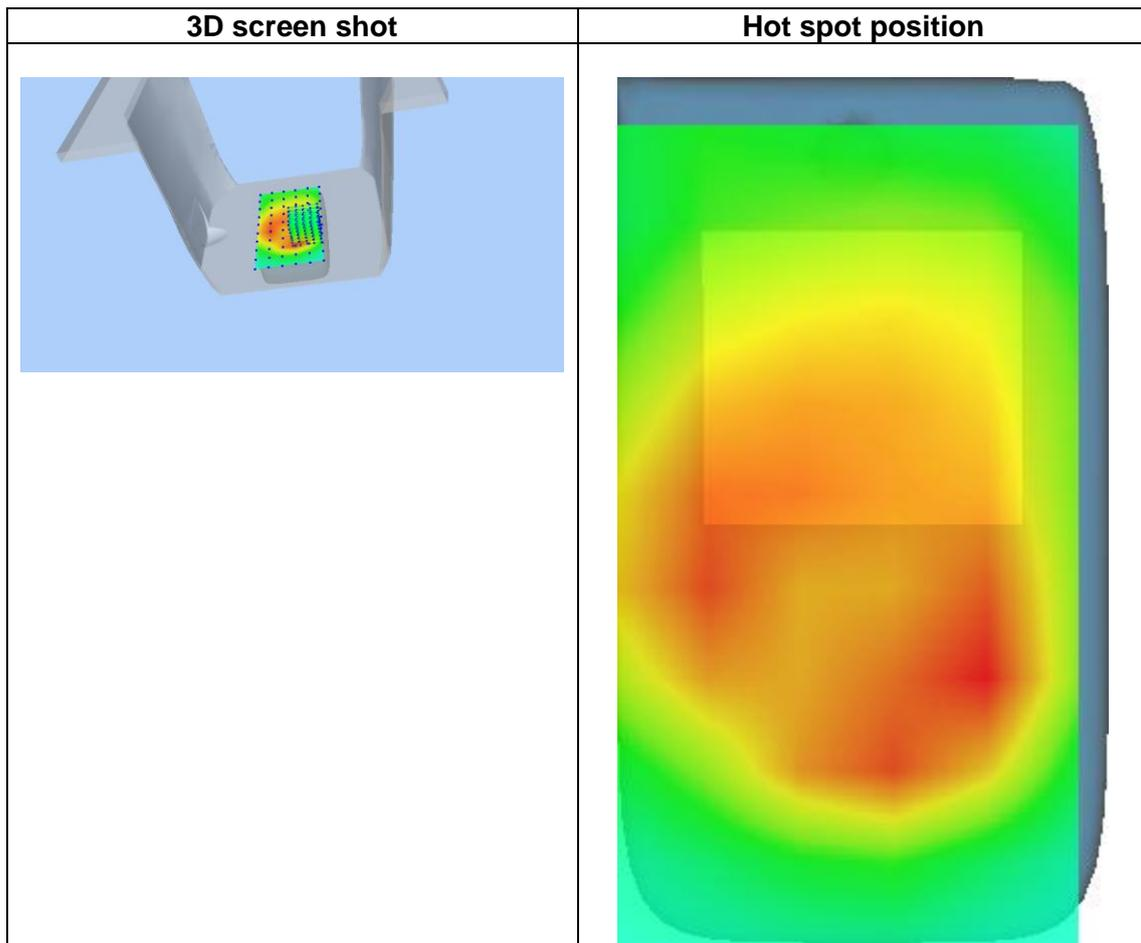
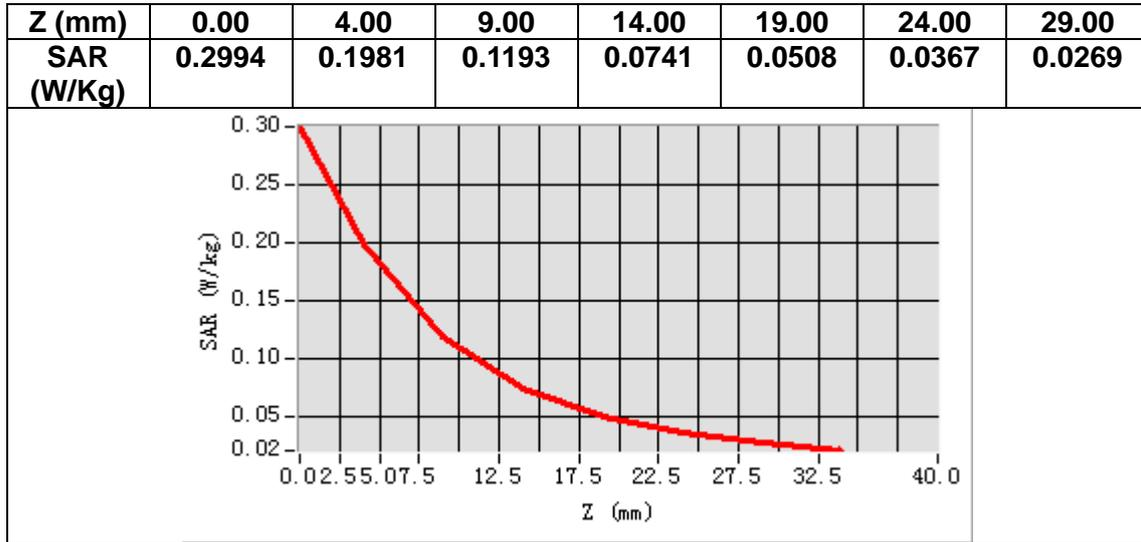

MEASUREMENT 17

Date of measurement: 10/1/2024

A. Experimental conditions.

Area Scan	<u>dx=15mm dy=15mm, h= 5.00 mm</u>
ZoomScan	<u>5x5x7,dx=8mm dy=8mm dz=5mm</u>
Phantom	<u>Left head</u>
Device Position	<u>Cheek</u>
Band	<u>LTE band 5</u>
Channels	<u>Middle</u>
Signal	<u>LTE (Crest factor: 1.0)</u>
ConvF	<u>2.32</u>

B. SAR Measurement Results

Frequency (MHz)	836.500000
Relative permittivity (real part)	41.269989
Relative permittivity (imaginary part)	19.208080
Conductivity (S/m)	0.892642
Variation (%)	2.490000

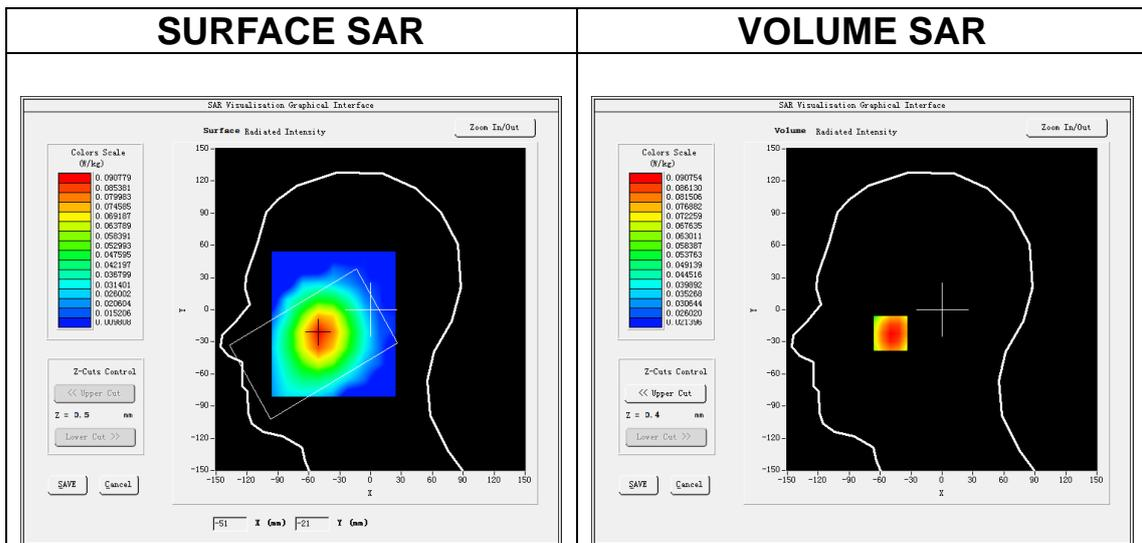

Maximum location: X=-50.00, Y=-22.00
SAR Peak: 0.11 W/kg

SAR 10g (W/Kg)	0.069420
SAR 1g (W/Kg)	0.088766

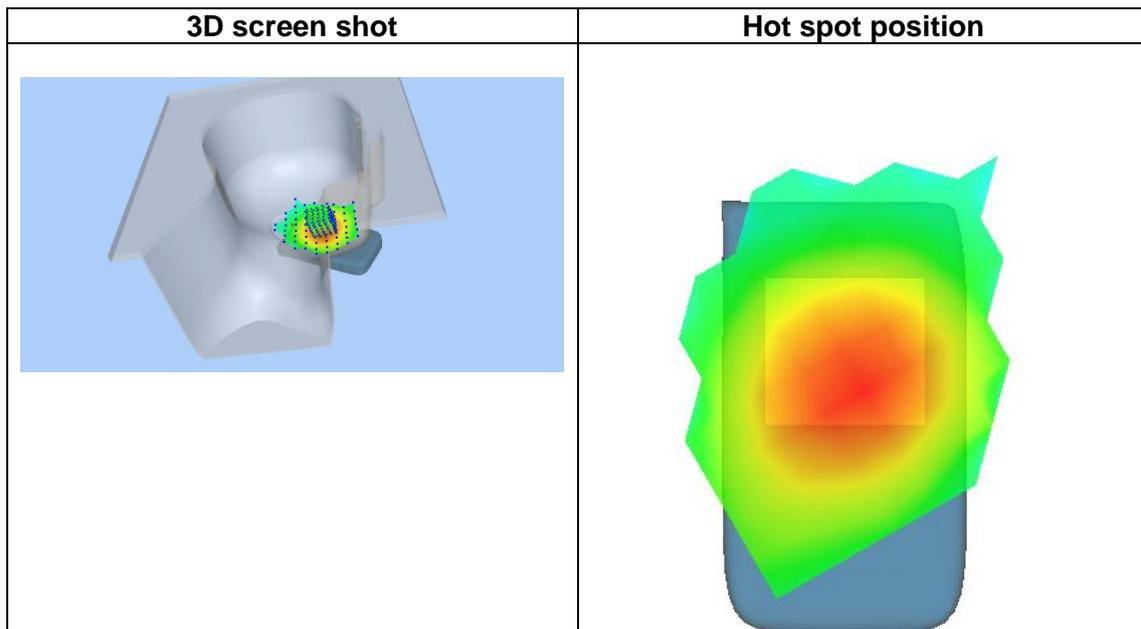
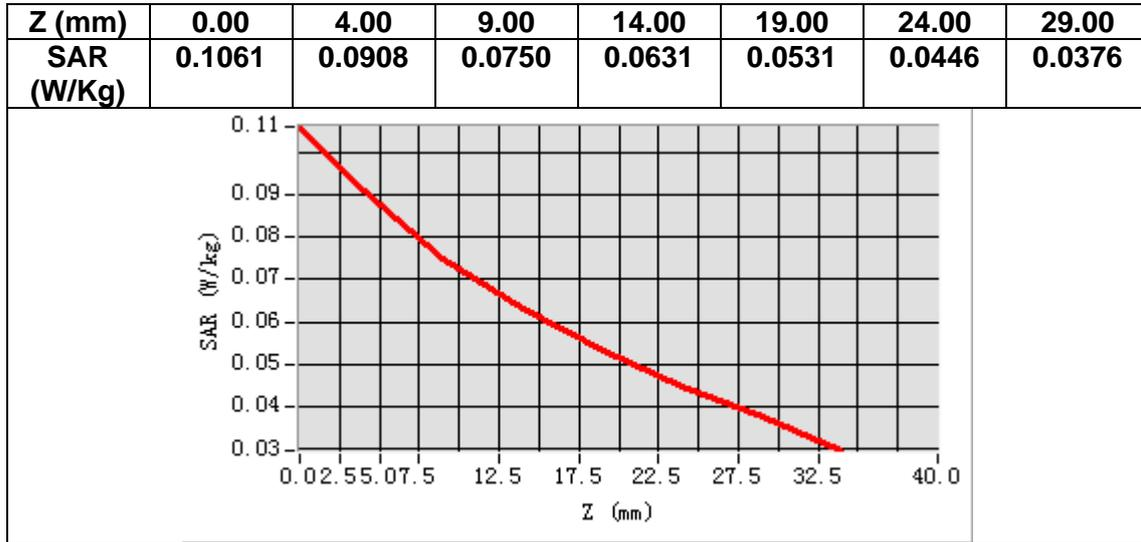

MEASUREMENT 18

Date of measurement: 10/1/2024

A. Experimental conditions.

Area Scan	<u>dx=15mm dy=15mm, h= 5.00 mm</u>
ZoomScan	<u>5x5x7, dx=8mm dy=8mm dz=5mm</u>
Phantom	<u>Validation plane</u>
Device Position	<u>Body</u>
Band	<u>LTE band 5</u>
Channels	<u>Middle</u>
Signal	<u>LTE (Crest factor: 1.0)</u>
ConvF	<u>2.32</u>

B. SAR Measurement Results

Frequency (MHz)	836.500000
Relative permittivity (real part)	41.269989
Relative permittivity (imaginary part)	19.208080
Conductivity (S/m)	0.892642
Variation (%)	0.280000

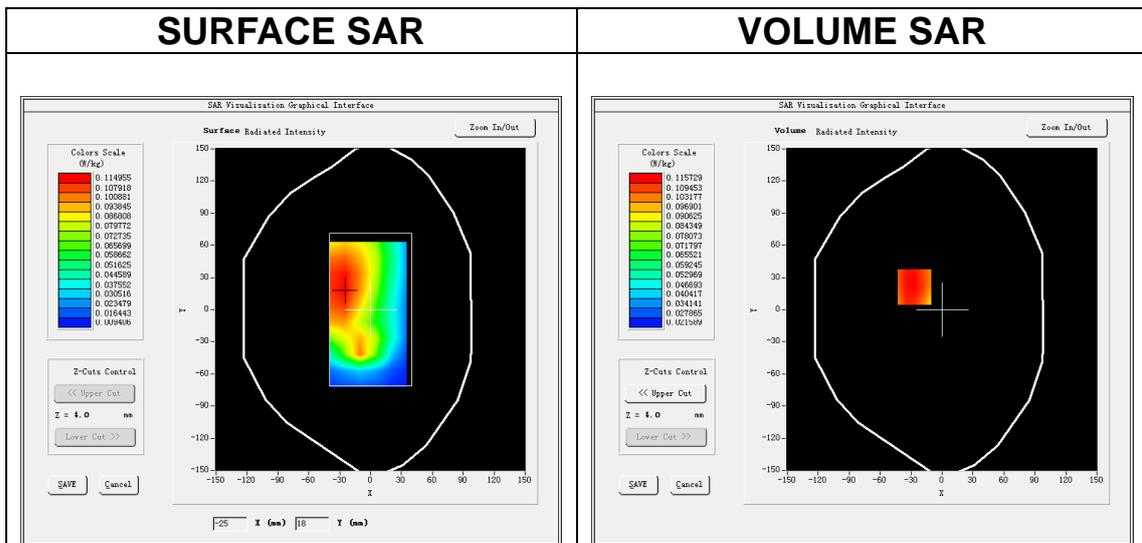

Maximum location: X=-27.00, Y=21.00
SAR Peak: 0.14 W/kg

SAR 10g (W/Kg)	0.087856
SAR 1g (W/Kg)	0.113123