

# FCC SAR EVALUATION REPORT

**In accordance with the requirements of  
FCC 47 CFR Part 2(2.1093), ANSI/IEEE C95.1-1992 and  
IEEE Std 1528-2013**

**Product Name :** Mobile phone

**Brand Name :** Bmobile

**Model Name :** BL63

**Family Model :** N/A

**Report No. :** S23030102803001

**FCC ID :** ZSW-30-125

**Prepared for**

b mobile HK Limited

Flat 18; 14/F Block 1; Golden Industrial Building;16-26 Kwai Tak Street; Kwai Chung; New Territories; Hong Kong, China

**Prepared by**

Shenzhen NTEK Testing Technology Co., Ltd.

1/F, Building E, Fenda Science Park, Sanwei Community, Xixiang Street,  
Bao'an District, Shenzhen 518126 P.R.China.

Tel. 400-800-6106, 0755-2320 0050, 0755-2320 0090

Website: <http://www.ntek.org.cn>

### TEST RESULT CERTIFICATION

**Applicant's name** ..... b mobile HK Limited  
Address..... Flat 18; 14/F Block 1; Golden Industrial Building;16-26 Kwai Tak Street; Kwai Chung; New Territories; Hong Kong, China

**Manufacturer's Name** . b mobile HK Limited  
Address..... Flat 18; 14/F Block 1; Golden Industrial Building;16-26 Kwai Tak Street; Kwai Chung; New Territories; Hong Kong, China

**Product description**

Product name ..... Mobile phone  
Brand Name ..... Bmobile  
Model and/or type reference ..... BL63  
Family Model ..... N/A  
FCC 47 CFR Part 2(2.1093)  
ANSI/IEEE C95.1-1992

**Standards** ..... IEEE Std 1528-2013  
Published RF exposure KDB procedures

This device described above has been tested by Shenzhen NTEK. In accordance with the measurement methods and procedures specified in IEEE Std 1528-2013 and KDB 865664 D01. Testing has shown that this device is capable of compliance with localized specific absorption rate (SAR) specified in FCC 47 CFR Part 2(2.1093) and ANSI/IEEE C95.1-1992. The test results in this report apply only to the tested sample of the stated device/equipment. Other similar device/equipment will not necessarily produce the same results due to production tolerance and measurement uncertainties.

This report shall not be reproduced except in full, without the written approval of Shenzhen NTEK, this document may be altered or revised by Shenzhen NTEK, personal only, and shall be noted in the revision of the document.

Test Sample Number ..... S230301028003

**Date of Test**

Date (s) of performance of tests... Mar. 06, 2023 ~ Mar. 14, 2023

Date of Issue ..... Mar. 29, 2023

Test Result..... **Pass**

Prepared By : Jacob.chen  
(Test Engineer) (Jacob Chen)

Approved By : Alex  
(Lab Manager) (Alex Li)

※ ※ Revision History ※ ※

REV.	DESCRIPTION	ISSUED DATE	REMARK
Rev.1.0	Initial Test Report Release	Mar. 29, 2023	Jacob Chen

## TABLE OF CONTENTS

1. General Information .....	6
1.1. RF exposure limits .....	6
1.2. Statement of Compliance .....	7
1.3. EUT Description .....	7
1.4. Test specification(s) .....	8
1.5. Ambient Condition .....	9
2. SAR Measurement System .....	10
2.1. SATIMO SAR Measurement Set-up Diagram .....	10
2.2. Robot .....	11
2.3. E-Field Probe .....	12
2.3.1. E-Field Probe Calibration .....	12
2.4. SAM phantoms .....	13
2.4.1. Technical Data .....	14
2.5. Device Holder .....	15
2.6. Test Equipment List .....	16
3. SAR Measurement Procedures .....	18
3.1. Power Reference .....	18
3.2. Area scan & Zoom scan .....	18
3.3. Description of interpolation/extrapolation scheme .....	20
3.4. Volumetric Scan .....	20
3.5. Power Drift .....	20
4. System Verification Procedure .....	21
4.1. Tissue Verification .....	21
4.1.1. Tissue Dielectric Parameter Check Results .....	22
4.2. System Verification Procedure .....	23
4.2.1. System Verification Results .....	24
5. SAR Measurement variability and uncertainty .....	25
5.1. SAR measurement variability .....	25
5.2. SAR measurement uncertainty .....	25
6. RF Exposure Positions .....	26
6.1. Ear and handset reference point .....	26
6.2. Definition of the cheek position .....	26
6.3. Definition of the tilt position .....	28
6.4. Body Worn Accessory .....	28
6.5. Wireless Router Devices .....	29
7. RF Output Power .....	30
7.1. GSM Conducted Power .....	30
7.2. WCDMA Conducted Power .....	30
7.3. LTE Conducted Power .....	32

7.4. WLAN & Bluetooth Output Power .....	45
8. Antenna Location.....	47
9. Stand-alone SAR test exclusion.....	47
10. SAR Results .....	48
10.1. SAR measurement Result.....	48
10.1.1. SAR measurement Result of GSM850.....	48
10.1.2. SAR measurement Result of GSM1900.....	49
10.1.3. SAR measurement Result of WCDMA Band 2.....	50
10.1.4. SAR measurement Result of WCDMA Band 4.....	51
10.1.5. SAR measurement Result of WCDMA Band 5.....	53
10.1.6. SAR measurement Result of LTE Band 2 .....	53
10.1.7. SAR measurement Result of LTE Band 4 .....	56
10.1.8. SAR measurement Result of LTE Band 5 .....	58
10.1.9. SAR measurement Result of LTE Band 7 .....	60
10.1.10. SAR measurement Result of LTE Band 38 .....	62
10.1.11. SAR measurement Result of LTE Band 66 .....	64
10.1.12. SAR measurement Result of WLAN2.4G .....	66
10.2. Simultaneous Transmission Analysis.....	67
11. Appendix A. Photo documentation .....	68
12. Appendix B. System Check Plots.....	69
13. Appendix C. Plots of High SAR Measurement.....	81
14. AAppendix D. Calibration Certificate .....	130

## 1. General Information

### 1.1. RF exposure limits

(A).Limits for Occupational/Controlled Exposure (W/kg)

Whole-Body	Partial-Body	Hands, Wrists, Feet and Ankles
0.4	8.0	20.0

(B).Limits for General Population/Uncontrolled Exposure (W/kg)

Whole-Body	Partial-Body	Hands, Wrists, Feet and Ankles
0.08	1.6	4.0

NOTE: **Whole-Body SAR** is averaged over the entire body, **partial-body SAR** is averaged over any 1 gram of tissue defined as a tissue volume in the shape of a cube. **SAR for hands, wrists, feet and ankles** is averaged over any 10 grams of tissue defined as a tissue volume in the shape of a cube.

#### **Occupational/Controlled Environments:**

Are defined as locations where there is exposure that may be incurred by people who are aware of the potential for exposure, (i.e. as a result of employment or occupation).

#### **General Population/Uncontrolled Environments:**

Are defined as locations where there is the exposure of individuals who have no knowledge or control of their exposure.

NOTE  
HEAD AND TRUNK LIMIT  
1.6 W/kg  
APPLIED TO THIS EUT

## 1.2. Statement of Compliance

The maximum results of Specific Absorption Rate (SAR) found during testing for BL63 are as follows.

RF Exposure Conditions		Equipment Class -Highest Reported SAR (W/kg)			
		PCE	DTS	NII	DSS
1-g Head		0.871	0.042	N/A	N/A
1-g Body-Worn (Separation distance of 10mm)		0.892	0.074	N/A	N/A
1-g Hotspot (Separation distance of 10mm)		0.892	0.074	N/A	N/A
Max Simultaneous Tx	Head	1.205	0.913	N/A	1.205
	Body-Worn	1.059	0.966	N/A	1.059
	Hotspot	1.059	0.966	N/A	1.059

Note: The Max Simultaneous Tx is calculated based on the same configuration and test position. This device is in compliance with Specific Absorption Rate (SAR) for general population/uncontrolled exposure limits (1.6 W/kg) specified in FCC 47 CFR Part 2(2.1093) and ANSI/IEEE C95.1-1992, and had been tested in accordance with the measurement methods and procedures specified in IEEE Std 1528-2013 & KDB 865664 D01.

## 1.3. EUT Description

Device Information	
Product Name	Mobile phone
Brand Name	Bmobile
Model Name	BL63
Family Model	N/A
Model Difference	N/A
FCC ID	ZSW-30-125
Device Phase	Identical Prototype
Exposure Category	General population / Uncontrolled environment
Antenna Type	PIFA Antenna
Battery Information	DC 3.8V/3000mAh
HW Version	Bmobile_BL63_HW_V1.0
SW Version	Bmobile_BL63_TIGO_SV_V001
Device Operating Configurations	
Supporting Mode(s)	GSM 850/1900, WCDMA Band 2/4/5, LTE Band 2/4/5/7/38/66 WLAN 2.4G, Bluetooth
Test Modulation	GSM(GMSK/8PSK), WCDMA(QPSK), LTE(QPSK/16QAM),

	WLAN(DSSS/OFDM), Bluetooth(GFSK, π/4-DQPSK, 8DPSK)		
Device Class	B		
Operating Frequency Range(s)	Band	Tx (MHz)	Rx (MHz)
	GSM 850	824-849	869-894
	GSM 1900	1850-1910	1930-1990
	WCDMA Band 2	1850-1910	1930-1990
	WCDMA Band 4	1710-1755	2110-2155
	WCDMA Band 5	824-849	869-894
	LTE Band 2	1850-1910	1930-1990
	LTE Band 4	1710-1755	2110-2155
	LTE Band 5	824-849	869-894
	LTE Band 7	2500-2570	2620-2690
	LTE Band 38	2570-2620	
	LTE Band 66	1710-1780	2110-2200
	WLAN 2.4G	2412-2462	
	Bluetooth	2402-2480	
GPRS Multislot Class(12)	Max Number of Timeslots in Uplink		4
	Max Number of Timeslots in Downlink		4
	Max Total Timeslot		5
EGPRS Multislot Class(12)	Max Number of Timeslots in Uplink		4
	Max Number of Timeslots in Downlink		4
	Max Total Timeslot		5
Power Class	4, tested with power level 5(GSM 850)		
	1, tested with power level 0(GSM 1900)		
	3, tested with power control "all 1"(WCDMA Band 2)		
	3, tested with power control "all 1"(WCDMA Band 4)		
	3, tested with power control "all 1"(WCDMA Band 5)		
	3, tested with power control all Max.(LTE Band 2)		
	3, tested with power control all Max.(LTE Band 4)		
	3, tested with power control all Max.(LTE Band 5)		
	3, tested with power control all Max.(LTE Band 7)		
	3, tested with power control all Max.(LTE Band 38)		
3, tested with power control all Max.(LTE Band 66)			

**1.4. Test specification(s)**

FCC 47 CFR Part 2(2.1093)
ANSI/IEEE C95.1-1992
IEEE Std 1528-2013
KDB 865664 D01 SAR measurement 100 MHz to 6 GHz
KDB 865664 D02 RF Exposure Reporting



KDB 447498 D01 General RF Exposure Guidance
KDB 248227 D01 802.11 Wi-Fi SAR
KDB 941225 D01 3G SAR Procedures
KDB 941225 D05 SAR for LTE Devices
KDB 941225 D06 Hotspot SAR
KDB 648474 D04 Handset SAR

**1.5. Ambient Condition**

Ambient temperature	20°C – 24°C
Relative Humidity	30% – 70%

## 2. SAR Measurement System

### 2.1. SATIMO SAR Measurement Set-up Diagram

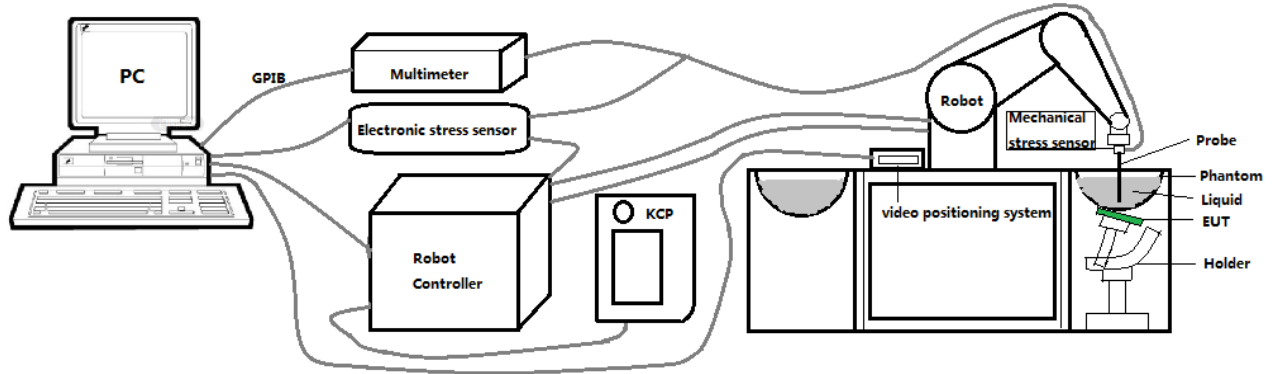

These measurements were performed with the automated near-field scanning system OPENSAR from SATIMO. The system is based on a high precision robot (working range: 901 mm), which positions the probes with a positional repeatability of better than  $\pm 0.03$  mm. The SAR measurements were conducted with dosimetric probe (manufactured by SATIMO), designed in the classical triangular configuration and optimized for dosimetric evaluation.

The first step of the field measurement is the evaluation of the voltages induced on the probe by the device under test. Probe diode detectors are nonlinear. Below the diode compression point, the output voltage is proportional to the square of the applied E-field; above the diode compression point, it is linear to the applied E-field. The compression point depends on the diode, and a calibration procedure is necessary for each sensor of the probe.

The Keithley multimeter reads the voltage of each sensor and send these three values to the PC. The corresponding E field value is calculated using the probe calibration factors, which are stored in the working directory. This evaluation includes linearization of the diode characteristics. The field calculation is done separately for each sensor. Each component of the E field is displayed on the "Dipole Area Scan Interface" and the total E field is displayed on the "3D Interface"

## 2.2. Robot

The SATIMO SAR system uses the high precision robots from KUKA. For the 6-axis controller system, the robot controller version (KUKA) from KUKA is used. The KUKA robot series have many features that are important for our application:



- High precision (repeatability  $\pm 0.03$  mm)
- High reliability (industrial design)
- Jerk-free straight movements
- Low ELF interference (the closed metallic construction shields against motor control fields)

### 2.3. E-Field Probe

This E-field detection probe is composed of three orthogonal dipoles linked to special Schottky diodes with low detection thresholds. The probe allows the measurement of electric fields in liquids such as the one defined in the IEEE and CENELEC standards.

For the measurements the Specific Dosimetric E-Field Probe SN 08/16 EPGO287 with following specifications is used



- Dynamic range: 0.01-100 W/kg
  - Tip Diameter : 2.5 mm
  - Distance between probe tip and sensor center: 1 mm
  - Distance between sensor center and the inner phantom surface: 2 mm (repeatability better than  $\pm 1$  mm).
  - Probe linearity:  $\pm 0.08$  dB
  - Axial isotropy:  $\pm 0.01$  dB
  - Hemispherical Isotropy:  $\pm 0.01$  dB
  - Calibration range: 650MHz to 5900MHz for head & body simulating liquid.
  - Lower detection limit: 8mW/kg
- Angle between probe axis (evaluation axis) and surface normal line: less than  $30^\circ$ .

#### 2.3.1. E-Field Probe Calibration

Each probe needs to be calibrated according to a dosimetric assessment procedure with accuracy better than  $\pm 10\%$ . The spherical isotropy shall be evaluated and within  $\pm 0.25$ dB. The sensitivity parameters (Norm X, Norm Y, and Norm Z), the diode compression parameter (DCP) and the conversion factor (Conv F) of the probe are tested. The calibration data can be referred to appendix D of this report.

## 2.4. SAM phantoms

Photo of SAM phantom SN 16/15 SAM119



The SAM phantom is used to measure the SAR relative to people exposed to electro-magnetic field radiated by Smart Phones.

2.4.1. Technical Data

Serial Number	Shell thickness	Filling volume	Dimensions	Positionner Material	Permittivity	Loss Tangent
SN 16/15 SAM119	2 mm ±0.2 mm	27 liters	Length:1000 mm Width:500 mm Height:200 mm	Gelcoat with fiberglass	3.4	0.02

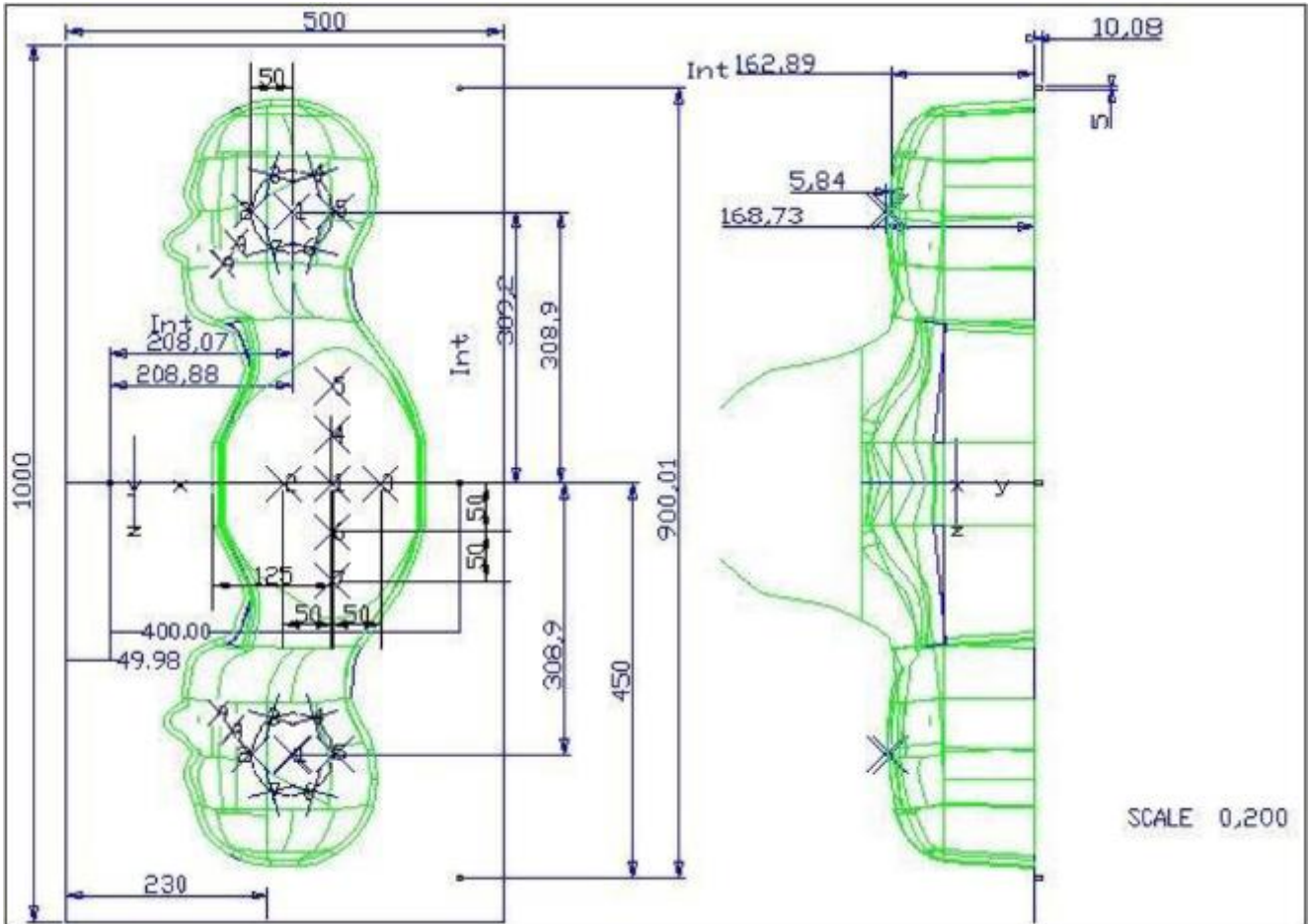

Serial Number	Left Head(mm)		Right Head(mm)		Flat Part(mm)	
	1	2	1	2	1	2
SN 16/15 SAM119	2	2.02	2	2.08	1	2.09
	3	2.05	3	2.06	2	2.06
	4	2.07	4	2.07	3	2.08
	5	2.08	5	2.08	4	2.10
	6	2.05	6	2.07	5	2.10
	7	2.05	7	2.05	6	2.07
	8	2.07	8	2.06	7	2.07
	9	2.08	9	2.06	-	-

The test, based on ultrasonic system, allows measuring the thickness with an accuracy of 10 µm.

### 2.5. Device Holder

The positioning system allows obtaining cheek and tilting position with a very good accuracy. In compliance with CENELEC, the tilt angle uncertainty is lower than 1 degree.

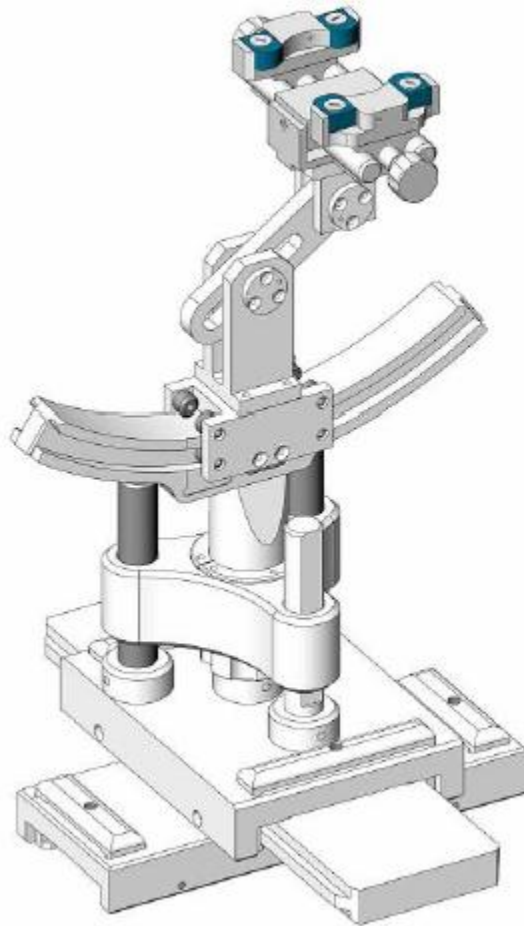

Serial Number	Holder Material	Permittivity	Loss Tangent
SN 16/15 MSH100	Delrin	3.7	0.005

## 2.6. Test Equipment List

This table gives a complete overview of the SAR measurement equipment.

Devices used during the test described are marked

	Manufacturer	Name of Equipment	Type/Model	Serial Number	Calibration	
					Last Cal.	Due Date
<input checked="" type="checkbox"/>	MVG	E FIELD PROBE	SSE2	SN 08/16 EPGO287	Jan. 10, 2023	Jan. 09, 2024
<input type="checkbox"/>	MVG	750 MHz Dipole	SID750	SN 03/15 DIP 0G750-355	Mar. 01, 2021	Feb. 28, 2024
<input checked="" type="checkbox"/>	MVG	835 MHz Dipole	SID835	SN 03/15 DIP 0G835-347	Mar. 01, 2021	Feb. 28, 2024
<input type="checkbox"/>	MVG	900 MHz Dipole	SID900	SN 03/15 DIP 0G900-348	Mar. 01, 2021	Feb. 28, 2024
<input checked="" type="checkbox"/>	MVG	1800 MHz Dipole	SID1800	SN 03/15 DIP 1G800-349	Mar. 01, 2021	Feb. 28, 2024
<input checked="" type="checkbox"/>	MVG	1900 MHz Dipole	SID1900	SN 03/15 DIP 1G900-350	Mar. 01, 2021	Feb. 28, 2024
<input type="checkbox"/>	MVG	2000 MHz Dipole	SID2000	SN 03/15 DIP 2G000-351	Mar. 01, 2021	Feb. 28, 2024
<input type="checkbox"/>	MVG	2300 MHz Dipole	SID2300	SN 03/16 DIP 2G300-358	Mar. 01, 2021	Feb. 28, 2024
<input checked="" type="checkbox"/>	MVG	2450 MHz Dipole	SID2450	SN 03/15 DIP 2G450-352	Mar. 01, 2021	Feb. 28, 2024
<input checked="" type="checkbox"/>	MVG	2600 MHz Dipole	SID2600	SN 03/15 DIP 2G600-356	Mar. 01, 2021	Feb. 28, 2024
<input type="checkbox"/>	MVG	3500 MHz Dipole	SID3500	SN 09/12 DIP 3G500-360	Oct. 15, 2022	Oct. 14, 2025
<input type="checkbox"/>	MVG	5000 MHz Dipole	SWG5500	SN 13/14 WGA 33	Mar. 01, 2021	Feb. 28, 2024
<input checked="" type="checkbox"/>	MVG	Liquid measurement Kit	SCLMP	SN 21/15 OCPG 72	NCR	NCR
<input checked="" type="checkbox"/>	MVG	Power Amplifier	N.A	AMPLISAR_28/14_003	NCR	NCR
<input checked="" type="checkbox"/>	KEITHLEY	Millivoltmeter	2000	4072790	NCR	NCR
<input checked="" type="checkbox"/>	R&S	Universal radio communication tester	CMU200	117858	Jun. 17, 2022	Jun. 16, 2023
<input checked="" type="checkbox"/>	R&S	Wideband radio communication tester	CMW500	103917	Jun. 17, 2022	Jun. 16, 2023



<input checked="" type="checkbox"/>	HP	Network Analyzer	8753D	3410J01136	Jun. 17, 2022	Jun. 16, 2023
<input checked="" type="checkbox"/>	Agilent	MXG Vector Signal Generator	N5182A	MY47070317	Jun. 16, 2022	Jun. 15, 2023
<input checked="" type="checkbox"/>	Agilent	Power meter	E4419B	MY45102538	Jun. 17, 2022	Jun. 16, 2023
<input checked="" type="checkbox"/>	Agilent	Power sensor	E9301A	MY41495644	Jun. 17, 2022	Jun. 16, 2023
<input checked="" type="checkbox"/>	Agilent	Power sensor	E9301A	US39212148	Jun. 17, 2022	Jun. 16, 2023
<input checked="" type="checkbox"/>	MCLI/USA	Directional Coupler	CB11-20	0D2L51502	Jul. 17, 2020	Jul. 16, 2023

### 3. SAR Measurement Procedures

The measurement procedures are as follows:

<Conducted power measurement>

- (a) For WWAN power measurement, use base station simulator to configure EUT WWAN transmission in conducted connection with RF cable, at maximum power in each supported wireless interface and frequency band.
- (b) Read the WWAN RF power level from the base station simulator.
- (c) For Wi-Fi/BT power measurement, use engineering software to configure EUT Wi-Fi/BT continuously transmission, at maximum RF power in each supported wireless interface and frequency band.
- (d) Connect EUT RF port through RF cable to the power meter, and measure Wi-Fi/BT output power.

<SAR measurement>

- (a) Use base station simulator to configure EUT WWAN transmission in radiated connection, and engineering software to configure EUT Wi-Fi/BT continuously transmission, at maximum RF power, in the highest power channel.
- (b) Place the EUT in the positions as Appendix A demonstrates.
- (c) Set scan area, grid size and other setting on the OPENSAR software.
- (d) Measure SAR results for the highest power channel on each testing position.
- (e) Find out the largest SAR result on these testing positions of each band.
- (f) Measure SAR results for other channels in worst SAR testing position if the reported SAR of highest power channel is larger than 0.8 W/kg.

According to the test standard, the recommended procedure for assessing the peak spatial-average SAR value consists of the following steps:

- (a) Power reference measurement
- (b) Area scan
- (c) Zoom scan
- (d) Power drift measurement

#### 3.1. Power Reference

The Power Reference Measurement and Power Drift Measurements are for monitoring the power drift of the device under test in the batch process. The minimum distance of probe sensors to surface determines the closest measurement point to phantom surface. This distance cannot be smaller than the distance of sensor calibration points to probe tip as defined in the probe properties.

#### 3.2. Area scan & Zoom scan

The area scan is a 2D scan to find the hot spot location on the DUT. The zoom scan is a 3D scan

above the hot spot to calculate the 1g and 10g SAR value.

Measurement of the SAR distribution with a grid of 8 to 16 mm \* 8 to 16 mm and a constant distance to the inner surface of the phantom. Since the sensors cannot directly measure at the inner phantom surface, the values between the sensors and the inner phantom surface are extrapolated. With these values the area of the maximum SAR is calculated by an interpolation scheme. Around this point, a cube of 30 \* 30 \* 30 mm or 32 \* 32 \* 32 mm is assessed by measuring 5 or 8 \* 5 or 8 \* 4 or 5 mm. With these data, the peak spatial-average SAR value can be calculated.

From the scanned SAR distribution, identify the position of the maximum SAR value, in addition identify the positions of any local maxima with SAR values within 2 dB of the maximum value that will not be within the zoom scan of other peaks; additional peaks shall be measured only when the primary peak is within 2 dB of the SAR compliance limit (e.g., 1 W/kg for 1,6 W/kg 1 g limit, or 1,26 W/kg for 2 W/kg, 10 g limit).

Area scan & Zoom scan scan parameters extracted from FCC KDB 865664 D01 SAR measurement 100 MHz to 6 GHz.

			≤ 3 GHz	> 3 GHz
Maximum distance from closest measurement point (geometric center of probe sensors) to phantom surface			5 ± 1 mm	$\frac{1}{2} \cdot \delta \cdot \ln(2) \pm 0.5$ mm
Maximum probe angle from probe axis to phantom surface normal at the measurement location			30° ± 1°	20° ± 1°
Maximum area scan spatial resolution: $\Delta x_{Area}$ , $\Delta y_{Area}$			≤ 2 GHz: ≤ 15 mm 2 – 3 GHz: ≤ 12 mm	3 – 4 GHz: ≤ 12 mm 4 – 6 GHz: ≤ 10 mm
			When the x or y dimension of the test device, in the measurement plane orientation, is smaller than the above, the measurement resolution must be ≤ the corresponding x or y dimension of the test device with at least one measurement point on the test device.	
Maximum zoom scan spatial resolution: $\Delta x_{Zoom}$ , $\Delta y_{Zoom}$			≤ 2 GHz: ≤ 8 mm 2 – 3 GHz: ≤ 5 mm*	3 – 4 GHz: ≤ 5 mm* 4 – 6 GHz: ≤ 4 mm*
Maximum zoom scan spatial resolution, normal to phantom surface	uniform grid: $\Delta z_{Zoom}(n)$		≤ 5 mm	3 – 4 GHz: ≤ 4 mm 4 – 5 GHz: ≤ 3 mm 5 – 6 GHz: ≤ 2 mm
	graded grid	$\Delta z_{Zoom}(1)$ : between 1 <sup>st</sup> two points closest to phantom surface	≤ 4 mm	3 – 4 GHz: ≤ 3 mm 4 – 5 GHz: ≤ 2.5 mm 5 – 6 GHz: ≤ 2 mm
		$\Delta z_{Zoom}(n>1)$ : between subsequent points	≤ 1.5 · $\Delta z_{Zoom}(n-1)$	
Minimum zoom scan volume	x, y, z		≥ 30 mm	3 – 4 GHz: ≥ 28 mm 4 – 5 GHz: ≥ 25 mm 5 – 6 GHz: ≥ 22 mm

Note:  $\delta$  is the penetration depth of a plane-wave at normal incidence to the tissue medium; see draft standard IEEE P1528-2011 for details.

\* When zoom scan is required and the *reported* SAR from the *area scan based 1-g SAR estimation* procedures of KDB 447498 is ≤ 1.4 W/kg, ≤ 8 mm, ≤ 7 mm and ≤ 5 mm zoom scan resolution may be applied, respectively, for 2 GHz to 3 GHz, 3 GHz to 4 GHz and 4 GHz to 6 GHz.

### 3.3. Description of interpolation/extrapolation scheme

The local SAR inside the phantom is measured using small dipole sensing elements inside a probe body. The probe tip must not be in contact with the phantom surface in order to minimise measurements errors, but the highest local SAR will occur at the surface of the phantom.

An extrapolation is using to determinate this highest local SAR values. The extrapolation is based on a fourth-order least-square polynomial fit of measured data. The local SAR value is then extrapolated from the liquid surface with a 1 mm step.

The measurements have to be performed over a limited time (due to the duration of the battery) so the step of measurement is high. It could vary between 5 and 8 mm. To obtain an accurate assessment of the maximum SAR averaged over 10 grams and 1 gram requires a very fine resolution in the three dimensional scanned data array.

### 3.4. Volumetric Scan

The volumetric scan consists to a full 3D scan over a specific area. This 3D scan is useful form multi Tx SAR measurement. Indeed, it is possible with OpenSAR to add, point by point, several volumetric scan to calculate the SAR value of the combined measurement as it is define in the standard IEEE1528 and IEC62209.

### 3.5. Power Drift

All SAR testing is under the EUT install full charged battery and transmit maximum output power. In OpenSAR measurement software, the power reference measurement and power drift measurement procedures are used for monitoring the power drift of EUT during SAR test. Both these procedures measure the field at a specified reference position before and after the SAR testing. The software will calculate the field difference in V/m. If the power drifts more than  $\pm 5\%$ , the SAR will be retested.

## 4. System Verification Procedure

### 4.1. Tissue Verification

The following tissue formulations are provided for reference only as some of the parameters have not been thoroughly verified. The composition of ingredients may be modified accordingly to achieve the desired target tissue parameters required for routine SAR evaluation.

Ingredients (% of weight)	Head Tissue									
	750	835	900	1800	1900	2000	2450	2600	5200	5800
Frequency Band (MHz)	750	835	900	1800	1900	2000	2450	2600	5200	5800
Water	34.40	34.40	34.40	55.36	55.36	57.87	57.87	57.87	65.53	65.53
NaCl	0.79	0.79	0.79	0.35	0.35	0.16	0.16	0.16	0.00	0.00
1,2-Propanediol	64.81	64.81	64.81	0.00	0.00	0.00	0.00	0.00	0.00	0.00
Triton X-100	0.00	0.00	0.00	30.45	30.45	19.97	19.97	19.97	24.24	24.24
DGBE	0.00	0.00	0.00	13.84	13.84	22.00	22.00	22.00	10.23	10.23

For SAR measurement of the field distribution inside the phantom, the phantom must be filled with homogeneous tissue simulating liquid to a depth of at least 15 cm. For head SAR testing, the liquid depth from the ear reference point (ERP) of the phantom to the liquid top surface is larger than 15 cm.

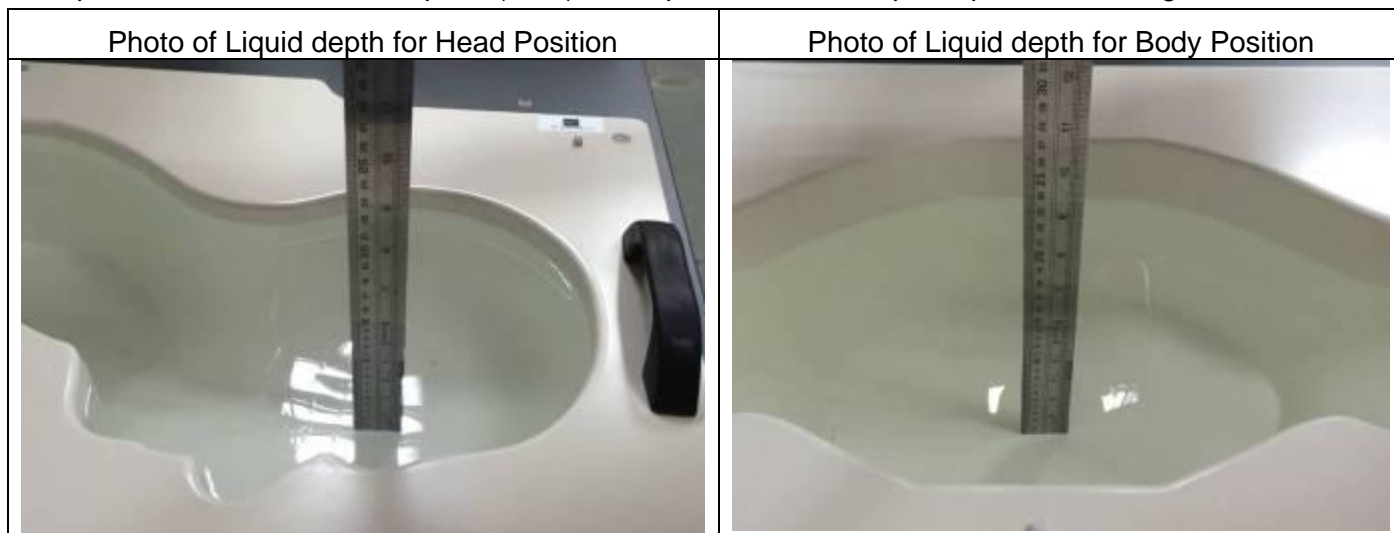

#### 4.1.1. Tissue Dielectric Parameter Check Results

The simulating liquids should be checked at the beginning of a series of SAR measurements to determine if the dielectric parameters are within the tolerances of the specified target values. The measured conductivity and relative permittivity should be within  $\pm 5\%$  of the target values.

Tissue Type	Measured Frequency (MHz)	Target Tissue		Measured Tissue		Liquid Temp.	Test Date
		$\epsilon_r$ ( $\pm 5\%$ )	$\sigma$ (S/m) ( $\pm 5\%$ )	$\epsilon_r$	$\sigma$ (S/m)		
Head 850	835	41.50 (39.43~43.58)	0.90 (0.86~0.95)	41.29	0.92	21.7 °C	Mar. 14, 2023
Head 1800	1800	40.00 (38.00~42.00)	1.40 (1.33~1.47)	38.96	1.38	21.7 °C	Mar. 06, 2023
Head 1900	1900	40.00 (38.00~42.00)	1.40 (1.33~1.47)	38.70	1.42	21.4 °C	Mar. 13, 2023
Head 2450	2450	39.20 (37.24~41.16)	1.80 (1.71~1.89)	38.64	1.83	21.9 °C	Mar. 08, 2023
Head 2600	2600	39.01 (37.06~40.96)	1.96 (1.86~2.06)	38.05	1.98	21.3 °C	Mar. 10, 2023

NOTE: The dielectric parameters of the tissue-equivalent liquid should be measured under similar ambient conditions and within 2 °C of the conditions expected during the SAR evaluation to satisfy protocol requirements.

### 4.2. System Verification Procedure

The system verification is performed for verifying the accuracy of the complete measurement system and performance of the software. The dipole is connected to the signal source consisting of signal generator and amplifier via a directional coupler, N-connector cable and adaption to SMA. It is fed with a power of 100mW (below 5GHz) or 100mW (above 5GHz). To adjust this power a power meter is used. The power sensor is connected to the cable before the system verification to measure the power at this point and do adjustments at the signal generator. At the outputs of the directional coupler both return loss as well as forward power are controlled during the system verification to make sure that emitted power at the dipole is kept constant. This can also be checked by the power drift measurement after the test (result on plot).

The system verification is shown as below picture:

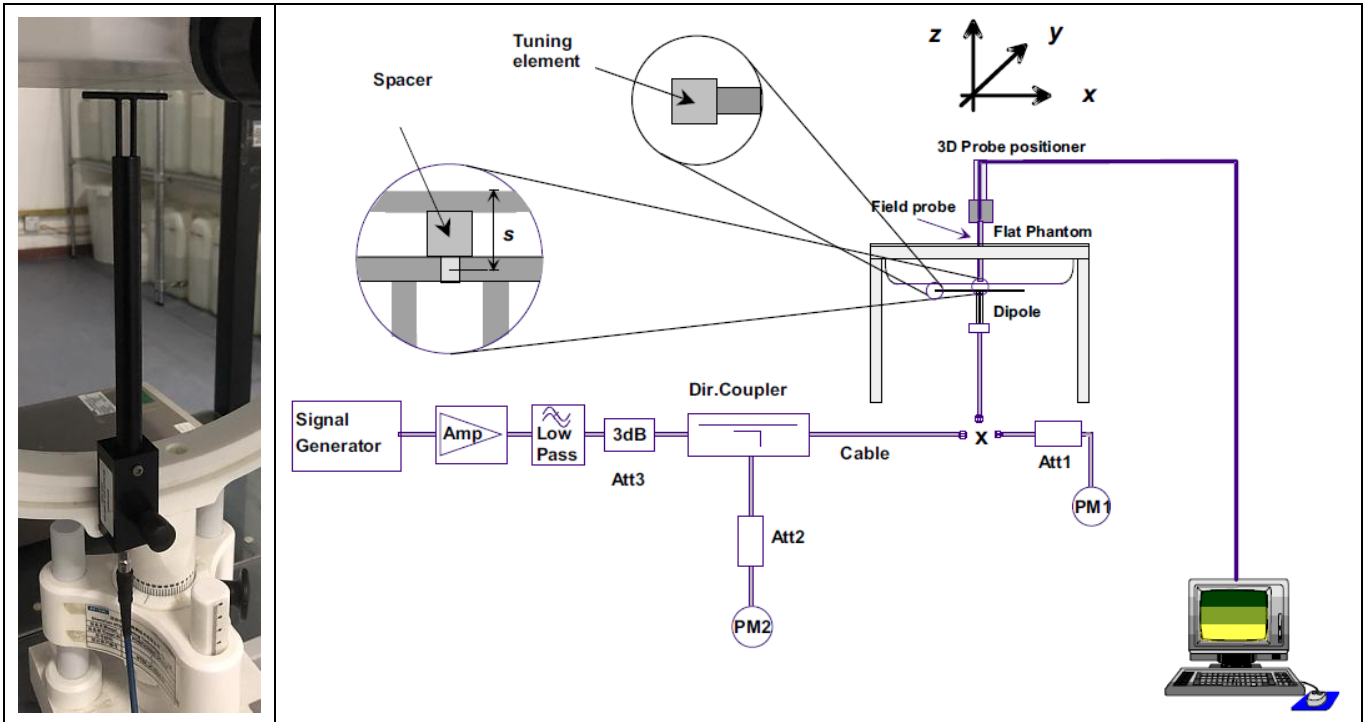

#### 4.2.1. System Verification Results

Comparing to the original SAR value provided by SATIMO, the verification data should be within its specification of  $\pm 10\%$ . Below table shows the target SAR and measured SAR after normalized to 1W input power. The table below indicates the system performance verification can meet the variation criterion and the plots can be referred to Appendix B of this report.

System Verification	Target SAR (1W) ( $\pm 10\%$ )		Measured SAR (Normalized to 1W)		Liquid Temp.	Test Date
	1-g (W/Kg)	10-g (W/Kg)	1-g (W/Kg)	10-g (W/Kg)		
835MHz	9.84 (8.86~10.82)	6.22 (5.60~6.84)	9.35	6.34	21.7 °C	Mar. 14, 2023
1800MHz	37.96 (34.17~41.75)	19.81 (17.83~21.79)	41.36	18.85	21.7 °C	Mar. 06, 2023
1900MHz	40.37 (36.34~44.40)	20.48 (18.44~22.52)	37.26	19.22	21.4 °C	Mar. 13, 2023
2450MHz	53.69 (48.33~59.05)	23.94 (21.55~26.33)	53.19	23.09	21.9 °C	Mar. 08, 2023
2600MHz	55.83 (50.25~61.41)	24.19 (21.78~26.60)	53.08	25.74	21.3 °C	Mar. 10, 2023



## 5. SAR Measurement variability and uncertainty

### 5.1. SAR measurement variability

Per KDB865664 D01 SAR measurement 100 MHz to 6 GHz, SAR measurement variability must be assessed for each frequency band, which is determined by the SAR probe calibration point and tissue-equivalent medium used for the device measurements. The additional measurements are repeated after the completion of all measurements requiring the same head or body tissue-equivalent medium in a frequency band. The test device should be returned to ambient conditions (normal room temperature) with the battery fully charged before it is re-mounted on the device holder for the repeated measurement(s) to minimize any unexpected variations in the repeated results.

- 1) Repeated measurement is not required when the original highest measured SAR is  $< 0.80$  W/kg; steps 2) through 4) do not apply.
- 2) When the original highest measured SAR is  $\geq 0.80$  W/kg, repeat that measurement once.
- 3) Perform a second repeated measurement only if the ratio of largest to smallest SAR for the original and first repeated measurements is  $> 1.20$  or when the original or repeated measurement is  $\geq 1.45$  W/kg (~ 10% from the 1-g SAR limit).
- 4) Perform a third repeated measurement only if the original, first or second repeated measurement is  $\geq 1.5$  W/kg and the ratio of largest to smallest SAR for the original, first and second repeated measurements is  $> 1.20$ .

### 5.2. SAR measurement uncertainty

Per KDB865664 D01 SAR Measurement 100 MHz to 6 GHz, when the highest measured 1-g SAR within a frequency band is  $< 1.5$  W/kg, the extensive SAR measurement uncertainty analysis described in IEEE Std 1528-2013 is not required in SAR reports submitted for equipment approval. The equivalent ratio (1.5/1.6) is applied to extremity and occupational exposure conditions.

## 6. RF Exposure Positions

### 6.1. Ear and handset reference point

Figure 6.1.1 shows the front, back, and side views of the SAM phantom. The center-of-mouth reference point is labeled “M”, the left ear reference point (ERP) is marked “LE”, and the right ERP is marked “RE”.



Fig 6.1.1 Front, back, and side views of SAM phantom

### 6.2. Definition of the cheek position

1. Define two imaginary lines on the handset, the vertical centerline and the horizontal line. The vertical centerline passes through two points on the front side of the handset: the midpoint of the width  $w_t$  of the handset at the level of the acoustic output (point A in Figure 6.2.1 and Figure 6.2.2), and the midpoint of the width  $w_b$  of the bottom of the handset (point B). The horizontal line is perpendicular to the vertical centerline and passes through the center of the acoustic output (see Figure 6.2.1). The two lines intersect at point A. Note that for many handsets, point A coincides with the center of the acoustic output; however, the acoustic output may be located elsewhere on the horizontal line. Also note that the vertical centerline is not necessarily parallel to the front face of the handset (see Figure 6.2.2), especially for clamshell handsets, handsets with flip covers, and other irregularly-shaped handsets.
2. Position the handset close to the surface of the phantom such that point A is on the (virtual) extension of the line passing through points RE and LE on the phantom (see Figure 6.2.3), such that the plane defined by the vertical centerline and the horizontal line of the handset is approximately parallel to the sagittal plane of the phantom.
3. Translate the handset towards the phantom along the line passing through RE and LE until handset point A touches the pinna at the ERP
4. While maintaining the handset in this plane, rotate it around the LE-RE line until the vertical centerline is in the plane normal to the plane containing B-M and N-F lines, i.e., the Reference Plane.
5. Rotate the handset around the vertical centerline until the handset (horizontal line) is parallel to the N-F line.

6. While maintaining the vertical centerline in the Reference Plane, keeping point A on the line passing through RE and LE, and maintaining the handset contact with the pinna, rotate the handset about the N-F line until any point on the handset is in contact with a phantom point below the pinna on the cheek. See Figure 6.2.3. The actual rotation angles should be documented in the test report.

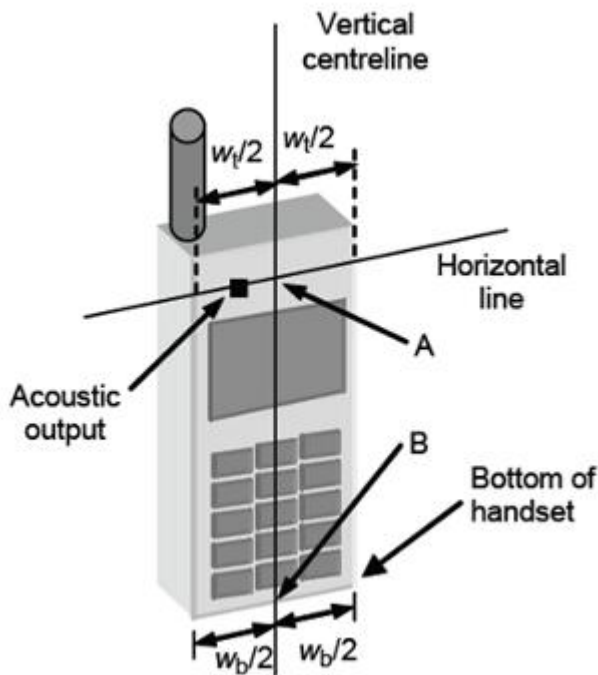

Fig 6.2.1 Handset vertical and horizontal reference lines—“fixed case”

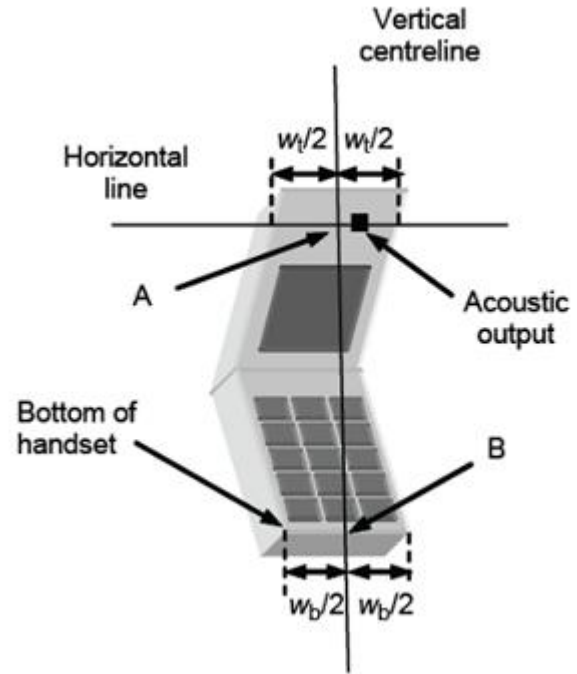

Fig 6.2.2 Handset vertical and horizontal reference lines— “clam-shell case”

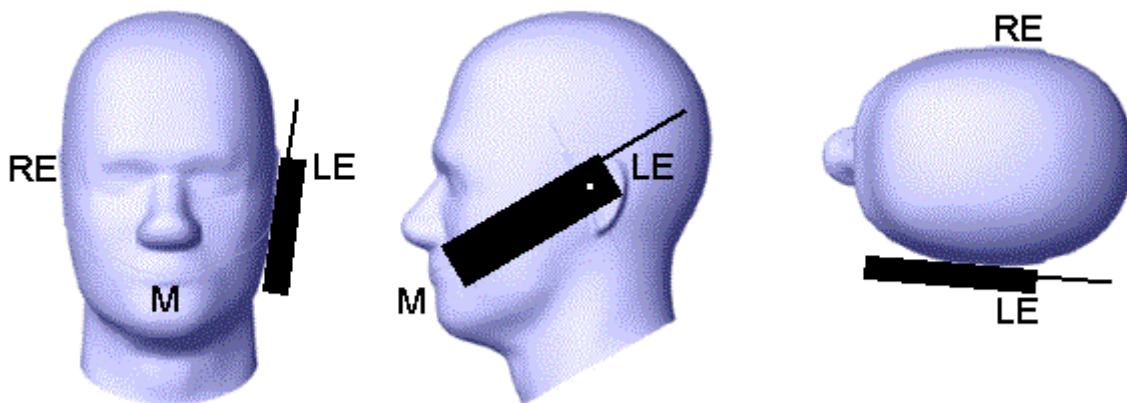

Fig 6.2.3 cheek or touch position. The reference points for the right ear (RE), left ear (LE), and mouth (M), which establish the Reference Plane for handset positioning, are indicated.

### 6.3. Definition of the tilt position

1. While maintaining the orientation of the handset, retract the handset parallel to the reference plane far enough away from the phantom to enable a rotation of the device by 15 degree.
2. Rotate the Handset around the horizontal line by 15 degree (see Figure 6.3.1).
3. While maintaining the orientation of the handset, move the handset towards the phantom on a line passing through RE and LE until any part of the handset touches the ear. The tilt position is obtained when the contact is on the pinna. If the contact is at any location other than the pinna, e.g., the antenna with the back of the phantom head, the angle of the handset shall be reduced. In this case, the tilt position is obtained if any part of the handset is in contact with the pinna as well as a second part of the handset is in contact with the phantom, e.g., the antenna with the back of the head.

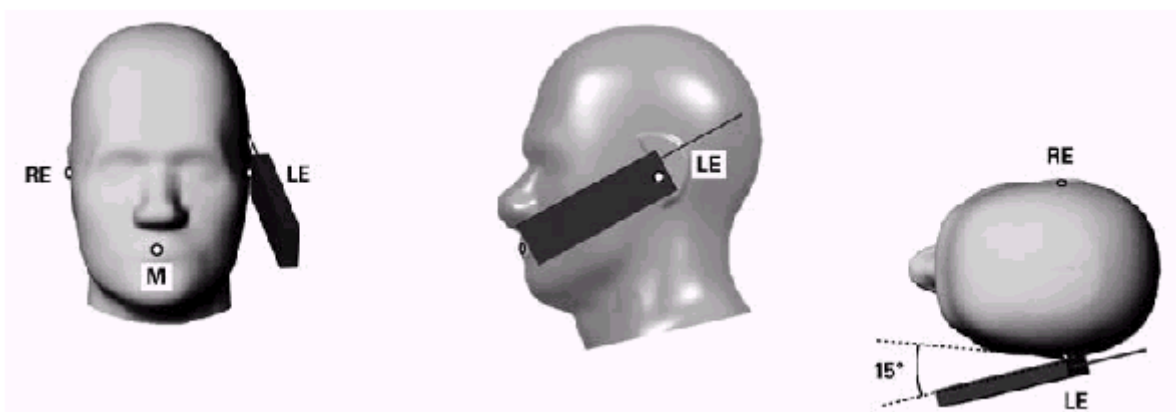

Figure 6.3.1 – Tilt position of the wireless device on the left side of SAM

### 6.4. Body Worn Accessory

1. Body-worn operating configurations are tested with the belt-clips and holsters attached to the device and positioned against a flat phantom in a normal use configuration (see Figure 6.4.1). Per KDB 648474 D04, body-worn accessory exposure is typically related to voice mode operations when handsets are carried in body-worn accessories. The body-worn accessory procedures in FCC KDB 447498 D01 should be used to test for body-worn accessory SAR compliance, without a headset connected to it. This enables the test results for such configuration to be compatible with that required for hotspot mode when the body-worn accessory test separation distance is greater than or equal to that required for hotspot mode, when applicable. When the reported SAR for body-worn accessory, measured without a headset connected to the handset is  $< 1.2$  W/kg, the highest reported SAR configuration for that wireless mode and frequency band should be repeated for that body-worn accessory with a handset attached to the handset.
2. Accessories for body-worn operation configurations are divided into two categories: those that do not contain metallic components and those that do contain metallic components and those that do contain metallic components. When multiple accessories that do not contain metallic components are supplied with the device, the device is tested with only the accessory that dictates the closest

spacing to the body. Then multiple accessories that contain metallic components are tested with the device with each accessory. If multiple accessories share an identical metallic component (i.e. the same metallic belt-clip used with different holsters with no other metallic components) only the accessory that dictates the closest spacing to the body is tested.

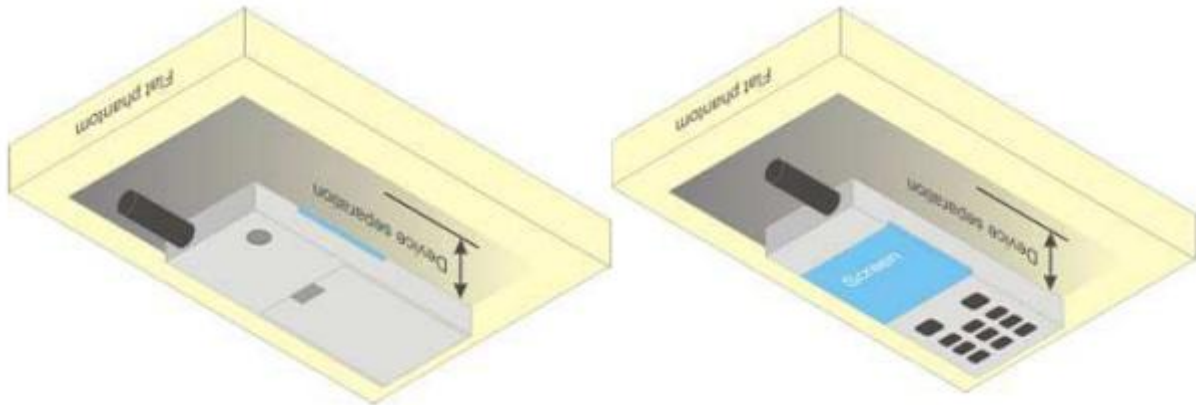

Figure 6.4.1 – Test positions for body-worn devices

## 6.5. Wireless Router Devices

Some battery-operated handsets have the capability to transmit and receive user through simultaneous transmission of WLAN simultaneously with a separate licensed transmitter. The FCC has provided guidance in FCC KDB Publication 941225 D06 where SAR test considerations for handsets ( $L \times W \geq 9 \text{ cm} \times 5 \text{ cm}$ ) are based on a composite test separation distance of 10mm from the front, back and edges of the device containing transmitting antennas within 2.5cm of their edges, determined from general mixed use conditions for this type of devices. Since the hotspot SAR results may overlap with the body-worn accessory SAR requirements, the more conservative configurations can be considered, thus excluding some body-worn accessory SAR tests.

When the user enables the personal wireless router functions for the handset, actual operations include simultaneous transmission of both the WLAN transmitter and another licensed transmitter. Both transmitters often do not transmit at the same transmitting frequency and thus cannot be evaluated for SAR under actual use conditions due to the limitations of the SAR assessment probes. Therefore, SAR must be evaluated for each frequency transmission and mode separately and spatially summed with the WLAN transmitter according to FCC KDB Publication 447498 D01 publication procedures. The “Portable Hotspot” feature on the handset was NOT activated during SAR assessments, to ensure the SAR measurements were evaluated for a single transmission frequency RF signal at a time.



## 7. RF Output Power

### 7.1. GSM Conducted Power

Band GSM850		Burst-Averaged output Power (dBm)			Frame-Averaged output Power (dBm)			
Tx Channel	Tune-up (dBm)	128	189	251	Tune-up (dBm)	128	189	251
Frequency (MHz)		824.2	836.4	848.8		824.2	836.4	848.8
GSM (GMSK)	32.00	31.87	31.98	31.89	22.97	22.84	22.95	22.86
GPRS(GMSK,1 Tx slot)	32.00	31.87	31.95	31.90	22.97	22.84	22.92	22.87
GPRS(GMSK,2 Tx slot)	30.00	29.81	29.86	29.70	23.98	23.79	23.84	23.68
GPRS(GMSK,3 Tx slot)	28.00	27.89	27.94	27.79	23.74	23.63	23.68	23.53
GPRS(GMSK,4 Tx slot)	26.00	25.60	25.66	25.57	22.99	22.59	22.65	22.56
EGPRS(8PSK,1 Tx slot)	25.00	24.20	24.60	24.30	15.97	15.17	15.57	15.27
EGPRS(8PSK,2 Tx slot)	24.50	23.44	24.05	23.82	18.48	17.42	18.03	17.80
EGPRS(8PSK,3 Tx slot)	21.50	20.51	21.17	20.68	17.24	16.25	16.91	16.42
EGPRS(8PSK,4 Tx slot)	19.50	19.07	18.94	18.96	16.49	16.06	15.93	15.95
Band GSM1900		Burst-Averaged output Power (dBm)			Frame-Averaged output Power (dBm)			
Tx Channel	Tune-up (dBm)	512	661	810	Tune-up (dBm)	512	661	810
Frequency (MHz)		1850.2	1880	1909.8		1850.2	1880	1909.8
GSM (GMSK)	29.00	28.64	28.76	28.70	19.97	19.61	19.73	19.67
GPRS(GMSK,1 Tx slot)	29.00	28.63	28.75	28.64	19.97	19.60	19.72	19.61
GPRS(GMSK,2 Tx slot)	27.00	26.97	26.61	26.32	20.98	20.95	20.59	20.30
GPRS(GMSK,3 Tx slot)	25.50	25.35	25.03	24.68	21.24	21.09	20.77	20.42
GPRS(GMSK,4 Tx slot)	23.50	23.34	22.97	22.59	20.49	20.33	19.96	19.58
EGPRS(8PSK,1 Tx slot)	24.50	24.49	23.99	23.74	15.47	15.46	14.96	14.71
EGPRS(8PSK,2 Tx slot)	23.00	22.68	22.82	22.20	16.98	16.66	16.80	16.18
EGPRS(8PSK,3 Tx slot)	21.00	20.52	20.71	20.30	16.74	16.26	16.45	16.04
EGPRS(8PSK,4 Tx slot)	19.00	18.73	18.19	17.50	15.99	15.72	15.18	14.49

### 7.2. WCDMA Conducted Power

WCDMA Band 2	Burst-Averaged output Power (dBm)			
Tx Channel	Tune-up (dBm)	9262	9400	9538
Frequency (MHz)		1852.4	1880	1907.6
RMC12.2K	22.00	21.68	21.74	21.72
HSDPA Sub 1	21.50	21.22	20.79	20.82
HSDPA Sub 2	21.00	20.84	20.56	20.61

HSDPA Sub 3	21.00	20.56	20.49	20.20
HSDPA Sub 4	20.50	20.41	19.98	20.04
HSUPA Sub 1	21.50	21.15	20.80	20.46
HSUPA Sub 2	21.50	21.21	20.99	20.71
HSUPA Sub 3	21.00	20.93	20.57	20.30
HSUPA Sub 4	21.00	20.93	20.68	20.57
HSUPA Sub 5	21.50	21.06	20.74	20.47
WCDMA Band 4	Burst-Averaged output Power (dBm)			
Tx Channel	Tune-up (dBm)	1312	1413	1513
Frequency (MHz)		1712.4	1732.6	1752.6
RMC12.2K	22.00	21.81	21.82	21.84
HSDPA Sub 1	22.00	21.74	21.58	21.40
HSDPA Sub 2	21.50	21.44	21.37	21.20
HSDPA Sub 3	21.50	21.03	21.11	20.83
HSDPA Sub 4	21.50	21.02	20.77	20.76
HSUPA Sub 1	21.50	21.21	21.03	20.82
HSUPA Sub 2	21.50	21.31	21.14	21.01
HSUPA Sub 3	21.00	20.86	20.96	20.63
HSUPA Sub 4	21.50	21.12	20.97	20.73
HSUPA Sub 5	21.50	20.88	21.03	20.78
WCDMA Band 5	Burst-Averaged output Power (dBm)			
Tx Channel	Tune-up (dBm)	4132	4182	4233
Frequency (MHz)		826.4	836.4	846.6
RMC12.2K	22.00	21.93	21.87	21.74
HSDPA Sub 1	21.50	20.20	21.30	21.21
HSDPA Sub 2	21.50	21.23	20.91	21.02
HSDPA Sub 3	21.00	20.94	20.90	20.75
HSDPA Sub 4	21.00	20.46	20.62	20.44
HSUPA Sub 1	21.50	21.36	21.21	21.15
HSUPA Sub 2	21.50	21.34	21.35	21.25
HSUPA Sub 3	21.00	20.96	20.72	20.70
HSUPA Sub 4	21.50	21.34	21.32	20.98
HSUPA Sub 5	21.50	21.04	21.03	21.06

7.3. LTE Conducted Power

Band	Band Width	Modulation	RB Configuration		Tune-up (dBm)	Channel/Frequency(MHz)		
			RB Size	RB Offset		18607/1850.7	18900/1880	19193/1909.3
LTE Band 2	1.4MHz	QPSK	1	0	23.00	21.05	21.53	22.62
			1	2	23.00	21.13	21.51	22.63
			1	5	23.00	21.21	21.50	22.58
			3	0	22.50	20.51	21.51	22.37
			3	1	22.50	20.56	21.43	22.40
			3	2	22.50	20.57	21.49	22.43
			6	0	21.50	19.55	20.41	21.30
		16QAM	1	0	22.00	20.11	20.33	21.84
			1	2	22.00	20.13	20.36	21.90
			1	5	22.00	20.15	20.32	21.80
			3	0	22.00	20.10	20.51	21.52
			3	1	22.00	20.14	20.56	21.59
			3	2	22.00	20.19	20.49	21.68
			6	0	20.50	19.14	19.21	20.14
Band	Band Width	Modulation	RB Configuration		Tune-up (dBm)	Channel/Frequency(MHz)		
			RB Size	RB Offset		18615/1851.5	18900/1880	19185/1908.5
LTE Band 2	3MHz	QPSK	1	0	23.00	21.60	21.46	22.36
			1	7	23.00	21.71	21.56	22.39
			1	14	23.00	21.72	21.48	22.43
			8	0	21.50	20.44	20.47	21.44
			8	4	21.50	20.45	20.42	21.28
			8	7	21.50	20.44	20.39	21.31
			15	0	21.50	20.39	20.39	21.40
		16QAM	1	0	22.00	20.52	20.36	22.00
			1	7	22.00	20.52	20.39	21.86
			1	14	22.00	20.39	20.27	21.82
			8	0	21.00	19.57	19.43	20.52
			8	4	21.00	19.63	19.49	20.50
			8	7	21.00	19.57	19.44	20.49
			15	0	20.50	19.56	19.43	20.44
Band	Band Width	Modulation	RB Configuration		Tune-up (dBm)	Channel/Frequency(MHz)		





2			1	74	23.00	22.19	21.68	22.39			
			36	0	21.50	20.42	20.24	21.13			
			36	18	21.50	20.71	20.29	21.25			
			36	37	21.50	20.82	20.46	21.25			
			75	0	21.50	20.74	20.43	21.15			
		16QAM	1	0	22.00	20.96	20.93	21.55			
			1	37	22.00	21.27	20.77	21.92			
			1	74	22.00	21.72	21.04	21.97			
			36	0	20.50	19.59	19.39	20.19			
			36	18	20.50	19.77	19.34	20.31			
			36	37	20.50	19.92	19.26	20.42			
			75	0	20.50	19.84	19.50	20.46			
			Band	Band Width	Modulation	RB Configuration		Tune-up (dBm)	Channel/Frequency(MHz)		
						RB Size	RB Offset		18700/1860	18900/1880	19100/1900
LTE Band 2	20MHz	QPSK	1	0	23.00	21.66	21.62	22.02			
			1	49	23.00	22.21	21.63	22.51			
			1	99	23.00	22.54	21.72	22.59			
			50	0	21.50	20.60	20.34	20.96			
			50	24	21.50	20.88	20.44	21.23			
			50	49	21.50	21.08	20.55	21.32			
			100	0	21.50	20.84	20.48	21.09			
		16QAM	1	0	21.50	20.34	19.79	20.70			
			1	49	21.50	20.80	19.74	21.21			
			1	99	21.50	21.27	19.92	21.26			
			50	0	20.50	19.67	19.46	20.06			
			50	24	20.50	19.90	19.38	20.24			
			50	49	20.50	20.16	19.52	20.33			
			100	0	20.50	19.91	19.57	20.18			

Band	Band Width	Modulation	RB Configuration		Tune-up (dBm)	Channel/Frequency(MHz)		
			RB Size	RB Offset		19957/1710.7	20175/1732.5	20393/1754.3
LTE Band 4	1.4MHz	QPSK	1	0	21.00	20.08	20.86	19.54
			1	2	21.00	20.06	20.77	19.57
			1	5	21.00	20.09	20.79	19.48
			3	0	21.00	20.09	20.93	19.59
			3	1	21.00	20.18	20.86	19.55

Band	Band Width	Modulation	RB Configuration		Tune-up (dBm)	Channel/Frequency(MHz)		
			RB Size	RB Offset		19965/1711.5	20175/1732.5	20385/1753.5
		16QAM	3	2	21.00	20.09	20.79	19.49
			6	0	20.00	19.09	19.70	18.45
			1	0	20.50	19.22	20.41	19.00
			1	2	20.50	19.19	20.45	19.06
			1	5	20.50	19.10	20.28	19.03
			3	0	20.50	19.20	20.14	18.68
			3	1	20.50	19.30	20.08	18.64
			3	2	20.50	19.31	19.97	18.73
			6	0	19.00	18.02	18.58	17.19
LTE Band 4	3MHz	QPSK	1	0	21.00	20.06	20.90	19.74
			1	7	21.00	20.10	20.83	19.62
			1	14	21.00	20.18	20.79	19.55
			8	0	20.00	19.05	19.89	18.74
			8	4	20.00	19.09	19.75	18.68
			8	7	20.00	19.09	19.71	18.51
			15	0	20.00	19.08	19.73	18.49
		16QAM	1	0	21.00	19.68	20.41	19.18
			1	7	21.00	19.79	20.52	19.14
			1	14	21.00	19.80	20.30	19.01
			8	0	19.50	18.24	19.01	17.86
			8	4	19.50	18.30	18.95	17.75
			8	7	19.50	18.27	18.95	17.75
			15	0	19.00	18.24	18.89	17.82
			LTE Band 4	5MHz	QPSK	1	0	21.50
1	12	21.50				20.42	21.15	19.82
1	24	21.50				20.46	20.95	19.66
12	0	20.00				19.07	19.80	18.57
12	6	20.00				19.18	19.86	18.61
12	11	20.00				19.10	19.77	18.47
25	0	20.00				19.15	19.81	18.47
16QAM	1	0			20.50	19.12	20.01	18.75
	1	12			20.50	19.20	19.94	18.51

Band	Band Width	Modulation	RB Configuration		Tune-up (dBm)	Channel/Frequency(MHz)		
			RB Size	RB Offset		20000/1715	20175/1732.5	20350/1750
			1	24	20.50	19.23	19.75	18.52
			12	0	19.50	18.19	19.04	17.73
			12	6	19.50	18.17	19.00	17.68
			12	11	19.50	18.25	18.87	17.56
			25	0	19.50	18.54	19.08	17.81
LTE Band 4	10MHz	QPSK	1	0	21.50	21.15	21.15	19.95
			1	24	21.50	21.29	20.87	19.71
			1	49	21.50	21.29	20.57	19.55
			25	0	20.50	20.21	19.98	18.98
			25	12	20.50	20.20	19.72	18.77
			25	24	20.50	20.29	19.70	18.66
			50	0	20.50	20.26	19.89	18.84
		16QAM	1	0	21.00	20.62	20.65	19.62
			1	24	21.00	20.84	20.38	19.44
			1	49	21.00	20.79	20.05	19.12
			25	0	19.50	19.11	19.03	17.90
			25	12	19.50	19.25	18.83	17.83
			25	24	19.50	19.29	18.78	17.63
			50	0	19.50	19.30	18.94	17.93
Band	Band Width	Modulation	RB Configuration		Tune-up (dBm)	Channel/Frequency(MHz)		
			RB Size	RB Offset		20025/1717.5	20175/1732.5	20325/1747.5
LTE Band 4	15MHz	QPSK	1	0	22.00	21.36	21.18	20.13
			1	37	22.00	21.52	20.86	20.09
			1	74	22.00	21.46	20.38	20.13
			36	0	20.50	20.26	20.16	19.05
			36	18	20.50	20.34	19.81	19.00
			36	37	20.50	20.36	19.63	18.71
		16QAM	75	0	20.50	20.21	19.77	18.82
			1	0	21.00	20.09	20.82	19.84
			1	37	21.00	20.25	20.38	19.56
			1	74	21.00	20.29	20.01	19.04
			36	0	19.50	19.28	19.13	18.07
			36	18	19.50	19.41	18.90	17.86
36	37	19.50	19.37	18.68	17.66			

Band	Band Width	Modulation	RB Configuration		Tune-up (dBm)	Channel/Frequency(MHz)		
			RB Size	RB Offset		20050/1720	20175/1732.5	20300/1745
			75	0	19.50	19.20	18.91	17.98
LTE Band 4	20MHz	QPSK	1	0	22.00	21.39	21.61	20.48
			1	49	22.00	21.50	21.13	20.07
			1	99	22.00	21.26	20.58	20.01
			50	0	20.50	20.15	19.98	19.19
			50	24	20.50	20.20	19.86	18.99
			50	49	20.50	20.26	19.49	18.78
			100	0	20.50	20.07	19.82	19.01
		16QAM	1	0	20.50	20.01	20.26	19.65
			1	49	20.50	20.36	19.95	19.13
			1	99	20.50	20.04	19.35	18.60
			50	0	19.50	19.22	19.17	18.29
			50	24	19.50	19.35	18.88	18.16
			50	49	19.50	19.21	18.63	17.96
			100	0	19.50	19.39	18.97	18.16

Band	Band Width	Modulation	RB Configuration		Tune-up (dBm)	Channel/Frequency(MHz)		
			RB Size	RB Offset		20407/824.7	20525/836.5	20643/848.3
LTE Band 5	1.4MHz	QPSK	1	0	23.00	22.29	22.87	22.41
			1	2	23.00	22.33	22.90	22.54
			1	5	23.00	22.30	22.91	22.55
			3	0	23.00	22.33	22.79	22.48
			3	1	23.00	22.46	22.71	22.58
			3	2	23.00	22.40	22.80	22.68
			6	0	22.00	21.54	21.58	21.46
		16QAM	1	0	22.50	21.32	22.01	21.91
			1	2	22.50	21.32	21.73	21.70
			1	5	22.50	21.48	21.61	21.82
			3	0	22.00	21.67	21.81	21.65
			3	1	22.00	21.64	21.85	21.74
			3	2	22.00	21.62	21.75	21.63
			6	0	21.00	20.73	20.39	20.15
Band	Band Width	Modulation	RB Configuration		Tune-up (dBm)	Channel/Frequency(MHz)		

Band	Band Width	Modulation	RB Configuration		Tune-up (dBm)	Channel/Frequency(MHz)		
			RB Size	RB Offset		20425/826.5	20525/836.5	20625/846.5
LTE Band 5	3MHz	QPSK	1	0	23.00	20415/825.5	20525/836.5	20635/847.5
			1	7	23.00	22.37	22.85	22.67
			1	14	23.00	22.36	22.89	22.68
			8	0	22.50	22.56	22.86	22.63
			8	4	22.50	21.44	22.17	21.64
			8	7	22.50	21.40	21.78	21.50
			15	0	22.00	21.50	21.62	21.58
		16QAM	1	0	22.50	21.49	21.61	21.65
			1	7	22.50	21.80	22.10	21.51
			1	14	22.50	21.72	21.67	21.45
			8	0	22.50	21.91	21.70	21.32
			8	4	21.50	21.07	21.24	21.13
			8	7	21.50	21.02	20.74	21.05
			15	0	21.50	20.55	20.81	20.54
LTE Band 5	5MHz	QPSK	1	0	23.00	20425/826.5	20525/836.5	20625/846.5
			1	12	23.00	22.63	22.88	22.90
			1	24	23.00	22.77	22.94	22.85
			12	0	22.00	22.65	22.85	22.81
			12	6	22.00	21.37	22.00	21.61
			12	11	22.00	21.45	21.79	21.57
			25	0	22.00	21.53	21.62	21.60
		16QAM	1	0	22.00	21.47	21.63	21.58
			1	12	22.50	21.47	22.12	21.58
			1	24	22.50	21.48	21.57	21.60
			12	0	22.50	21.44	21.96	21.45
			12	6	21.50	21.01	21.09	21.07
			12	11	21.50	20.47	20.72	21.05
			25	0	21.50	20.40	20.70	21.05
LTE Band 5	10MHz	QPSK	1	0	23.00	20450/829	20525/836.5	20600/844
			1	24	23.00	22.30	22.61	22.75
		16QAM	1	0	23.00	22.48	22.63	22.68
			1	12	23.00	22.48	22.63	22.68
			1	24	23.00	22.48	22.63	22.68
			12	0	22.50	21.44	21.96	21.45
			12	6	21.50	21.01	21.09	21.07
			12	11	21.50	20.47	20.72	21.05
			25	0	21.50	20.40	20.70	21.05
			25	0	21.50	20.65	20.85	21.27
			12	6	21.50	20.47	20.72	21.05
			12	11	21.50	20.40	20.70	21.05
			25	0	21.50	20.65	20.85	21.27

5			1	49	23.00	22.69	22.67	22.56	
			25	0	22.50	21.43	22.01	21.59	
			25	12	22.50	21.42	21.79	21.54	
			25	24	22.50	22.08	22.06	21.69	
			50	0	22.00	21.27	21.76	21.56	
	16QAM			1	0	23.00	21.92	22.48	22.67
				1	24	23.00	21.98	22.11	22.16
				1	49	23.00	22.04	22.27	21.92
				25	0	21.50	20.41	21.06	21.06
				25	12	21.50	20.46	20.55	20.63
				25	24	21.50	20.90	21.12	21.00
				50	0	21.00	20.58	20.66	20.62

Band	Band Width	Modulation	RB Configuration		Tune-up (dBm)	Channel/Frequency(MHz)		
			RB Size	RB Offset		20775/2502.5	21100/2535	21425/2567.5
LTE Band 7	5MHz	QPSK	1	0	24.00	23.09	23.51	23.62
			1	12	24.00	23.11	23.53	23.46
			1	24	24.00	23.22	23.57	23.45
			12	0	22.50	22.30	22.22	22.34
			12	6	22.50	22.28	22.39	22.27
			12	11	22.50	22.22	22.41	22.31
			25	0	22.50	22.26	22.25	22.31
		16QAM	1	0	23.00	22.87	22.40	22.45
			1	12	23.00	22.73	22.37	22.34
			1	24	23.00	22.89	22.39	22.40
			12	0	22.00	21.34	21.45	21.44
			12	6	22.00	21.33	21.40	21.32
			12	11	22.00	21.35	21.47	21.52
			25	0	22.00	21.19	21.63	21.56
Band	Band Width	Modulation	RB Configuration		Tune-up (dBm)	Channel/Frequency(MHz)		
RB Size	RB Offset	20800/2505	21100/2535	21400/2565				
LTE Band 7	10MHz	QPSK	1	0	24.00	23.33	23.31	23.25
			1	24	24.00	23.26	23.26	23.37
			1	49	24.00	23.36	23.36	23.31
			25	0	22.50	22.27	22.32	22.26
			25	12	22.50	22.24	22.39	22.36

			25	24	22.50	22.29	22.39	22.28
			50	0	22.50	22.30	22.29	22.40
		16QAM	1	0	23.50	22.92	23.02	22.91
			1	24	23.50	22.89	22.98	22.91
			1	49	23.50	22.89	23.05	22.96
			25	0	21.50	21.30	21.33	21.28
			25	12	21.50	21.34	21.40	21.37
			25	24	21.50	21.30	21.35	21.34
			50	0	21.50	21.44	21.43	21.33
Band	Band Width	Modulation	RB Configuration		Tune-up (dBm)	Channel/Frequency(MHz)		
			RB Size	RB Offset		20825/2507.5	21100/2535	21375/2562.5
LTE Band 7	15MHz	QPSK	1	0	24.00	23.54	23.47	23.51
			1	37	24.00	23.50	23.43	23.37
			1	74	24.00	23.61	23.60	23.43
			36	0	22.50	22.33	22.21	22.20
			36	18	22.50	22.35	22.27	22.23
			36	37	22.50	22.26	22.26	22.27
			75	0	22.50	22.28	22.25	22.11
		16QAM	1	0	22.50	22.21	22.40	22.33
			1	37	22.50	22.43	22.34	22.19
			1	74	22.50	22.40	22.41	22.31
			36	0	22.00	21.57	21.48	21.48
			36	18	22.00	21.54	21.50	21.43
			36	37	22.00	21.58	21.51	21.42
			75	0	21.50	21.35	21.40	21.36
Band	Band Width	Modulation	RB Configuration		Tune-up (dBm)	Channel/Frequency(MHz)		
			RB Size	RB Offset		20850/2510	21100/2535	21350/2560
LTE Band 7	20MHz	QPSK	1	0	24.00	23.40	23.48	23.60
			1	49	24.00	23.50	23.50	23.32
			1	99	24.00	23.48	23.55	23.44
			50	0	22.50	22.29	22.28	22.28
			50	24	22.50	22.37	22.28	22.23
			50	49	22.50	22.30	22.38	22.39
			100	0	22.50	22.31	22.33	22.35
		16QAM	1	0	23.00	22.21	22.58	22.37
			1	49	23.00	22.30	22.51	22.29



			1	99	23.00	22.34	22.53	22.27
			50	0	22.00	21.45	21.48	21.40
			50	24	22.00	21.41	21.48	21.34
			50	49	22.00	21.47	21.55	21.45
			100	0	21.50	21.46	21.42	21.43

Band	Band Width	Modulation	RB Configuration		Tune-up (dBm)	Channel/Frequency(MHz)		
			RB Size	RB Offset		37775/2572.5	38000/2595	38225/2617.5
LTE Band 38	5MHz	QPSK	1	0	24.00	22.83	23.39	23.48
			1	12	24.00	23.09	23.41	23.46
			1	24	24.00	23.06	23.45	23.49
			12	0	22.50	21.99	22.09	22.22
			12	6	22.50	22.03	22.03	22.08
			12	11	22.50	22.04	22.05	22.10
			25	0	22.50	22.04	22.04	22.12
		16QAM	1	0	22.00	21.67	21.66	21.85
			1	12	22.00	21.68	21.68	21.78
			1	24	22.00	21.70	21.76	21.76
			12	0	21.00	20.56	20.63	20.70
			12	6	21.00	20.60	20.61	20.71
			12	11	21.00	20.61	20.73	20.66
			25	0	21.00	20.72	20.72	20.76

Band	Band Width	Modulation	RB Configuration		Tune-up (dBm)	Channel/Frequency(MHz)		
			RB Size	RB Offset		37800/2575	38000/2595	38200/2615
LTE Band 38	10MHz	QPSK	1	0	24.00	23.55	23.37	23.55
			1	24	24.00	23.67	23.39	23.51
			1	49	24.00	23.51	23.52	23.49
			25	0	22.50	21.96	21.99	22.21
			25	12	22.50	22.10	22.09	22.06
			25	24	22.50	22.09	22.06	22.02
			50	0	22.50	21.96	22.04	22.22
		16QAM	1	0	22.00	21.72	21.70	21.90
			1	24	22.00	21.71	21.78	21.80
			1	49	22.00	21.69	21.78	21.75
			25	0	21.00	20.68	20.69	20.81
			25	12	21.00	20.73	20.69	20.81

Band	Band Width	Modulation	RB Configuration		Tune-up (dBm)	Channel/Frequency(MHz)		
			RB Size	RB Offset		37825/2577.5	38000/2595	38175/2615
			25	24	21.00	20.67	20.74	20.80
			50	0	21.00	20.64	20.70	20.84
LTE Band 38	15MHz	QPSK	1	0	24.00	23.59	23.48	23.27
			1	37	24.00	23.63	23.44	23.33
			1	74	24.00	23.51	23.55	23.15
			36	0	22.50	22.14	22.04	22.25
			36	18	22.50	22.13	22.11	22.18
			36	37	22.50	22.12	22.22	22.07
			75	0	22.50	22.11	22.14	22.06
		16QAM	1	0	22.50	21.81	21.72	22.09
			1	37	22.50	21.81	21.67	22.01
			1	74	22.50	21.65	21.82	21.93
			36	0	21.00	20.67	20.60	20.76
			36	18	21.00	20.62	20.63	20.77
			36	37	21.00	20.59	20.68	20.67
			75	0	21.00	20.61	20.75	20.84
Band	Band Width	Modulation	RB Configuration		Tune-up (dBm)	Channel/Frequency(MHz)		
			RB Size	RB Offset		37850/2580	38000/2595	38150/2610
LTE Band 38	20MHz	QPSK	1	0	24.00	23.60	23.52	23.65
			1	49	24.00	23.62	23.45	23.55
			1	99	24.00	23.45	23.52	23.47
			50	0	22.50	22.06	22.01	22.24
			50	24	22.50	22.04	22.16	22.23
			50	49	22.50	22.10	22.19	22.14
			100	0	22.50	21.95	22.10	22.27
		16QAM	1	0	22.00	21.72	21.74	21.99
			1	49	22.00	21.71	21.69	21.86
			1	99	22.00	21.55	21.79	21.79
			50	0	21.00	20.71	20.82	20.91
			50	24	21.00	20.76	20.75	20.88
			50	49	21.00	20.68	20.79	20.85
			100	0	21.00	20.67	20.68	20.74

Band	Band	Modulation	RB	Tune-up	Channel/Frequency(MHz)
------	------	------------	----	---------	------------------------



Band 66			1	12	22.00	21.54	20.50	20.48
			1	24	22.00	21.49	20.36	20.37
			12	0	20.50	20.23	19.33	19.40
			12	6	20.50	20.31	19.19	19.31
			12	11	20.50	20.24	19.19	19.23
			25	0	20.50	20.21	19.21	19.25
			25	0	20.50	20.24	19.20	19.44
		16QAM	1	12	20.50	20.26	19.30	19.32
			1	24	20.50	20.26	19.05	19.15
			12	0	19.50	19.23	18.30	18.46
			12	6	19.50	19.26	18.34	18.37
			12	11	19.50	19.35	18.56	18.36
			25	0	19.50	19.44	18.45	18.56
			25	0	19.50	19.44	18.45	18.56
Band	Band Width	Modulation	RB Configuration		Tune-up (dBm)	Channel/Frequency(MHz)		
			RB Size	RB Offset		132022/1715	132322/1745	132622/1775
LTE Band 66	10MHz	QPSK	1	0	22.00	21.18	20.24	20.84
			1	24	22.00	21.33	20.04	20.53
			1	49	22.00	21.39	20.02	20.22
			25	0	20.50	20.13	19.17	19.55
			25	12	20.50	20.32	19.19	19.51
			25	24	20.50	20.26	19.05	19.34
			50	0	20.50	20.31	19.19	19.42
		16QAM	1	0	21.00	20.76	19.91	20.19
			1	24	21.00	20.81	19.75	19.90
			1	49	21.00	20.90	19.41	19.72
			25	0	19.50	19.18	18.39	18.67
			25	12	19.50	19.29	18.19	18.50
			25	24	19.50	19.31	18.47	18.37
			50	0	19.50	19.34	18.29	18.55
Band	Band Width	Modulation	RB Configuration		Tune-up (dBm)	Channel/Frequency(MHz)		
			RB Size	RB Offset		132047/1717.5	132322/1745	132597/1772.5
LTE Band 66	15MHz	QPSK	1	0	22.00	21.30	20.32	21.06
			1	37	22.00	21.47	20.12	20.72
			1	74	22.00	21.37	20.94	20.23
			36	0	20.50	20.17	19.22	19.83
			36	18	20.50	20.39	19.13	19.62

Band	Band Width	Modulation	RB Configuration		Tune-up (dBm)	Channel/Frequency(MHz)		
			RB Size	RB Offset		132072/1720	132322/1745	132572/1770
		16QAM	36	37	20.50	20.37	18.99	19.34
			75	0	20.50	20.39	19.11	19.61
			1	0	21.00	20.65	19.95	20.43
			1	37	21.00	20.85	19.73	20.06
			1	74	21.00	20.82	19.32	19.59
			36	0	19.50	19.21	18.36	18.88
			36	18	19.50	19.32	18.22	18.69
			36	37	19.50	19.42	18.04	18.46
			75	0	19.50	19.45	18.42	18.84
LTE Band 66	20MHz	QPSK	1	0	22.00	21.45	20.78	21.55
			1	49	22.00	21.59	20.23	21.11
			1	99	22.00	21.37	20.79	20.47
			50	0	20.50	20.16	19.35	20.08
			50	24	20.50	20.34	19.13	19.75
			50	49	20.50	20.32	18.95	19.54
			100	0	20.50	20.23	19.15	19.87
		16QAM	1	0	20.50	20.06	19.68	20.35
			1	49	20.50	20.34	19.33	19.73
			1	99	20.50	20.13	18.91	19.21
			50	0	19.50	19.32	18.44	19.10
			50	24	19.50	19.39	18.31	18.89
			50	49	19.50	19.26	18.15	18.64
			100	0	19.50	19.34	18.38	18.96

**7.4. WLAN & Bluetooth Output Power**

Mode	Channel	Frequency (MHz)	Tune-up (dBm)	Output Power (dBm)
802.11b	1	2412	16.00	14.90
	6	2437	16.00	13.97
	11	2462	16.00	15.53
802.11g	1	2412	13.50	13.06
	6	2437	13.50	12.24
	11	2462	13.50	13.41
802.11n	1	2412	11.50	11.21

HT20	6	2437	11.50	10.40
	11	2462	11.50	11.18

NOTE: Power measurement results of WLAN 2.4G.

BR+EDR	Output Power (dBm)				
	Data Rates	Tune-up (dBm)	Channel		
			0CH	39CH	78CH
1M	9.00	6.88	7.75	8.04	
2M	9.00	7.88	8.16	8.37	
3M	9.00	8.05	8.82	8.99	

BLE	Channel	Tune-up (dBm)	Output Power (dBm)
	0CH	0.00	-0.01
	19CH	0.00	-0.95
	39CH	-1.00	-1.37

NOTE: Power measurement results of Bluetooth.

### 8. Antenna Location

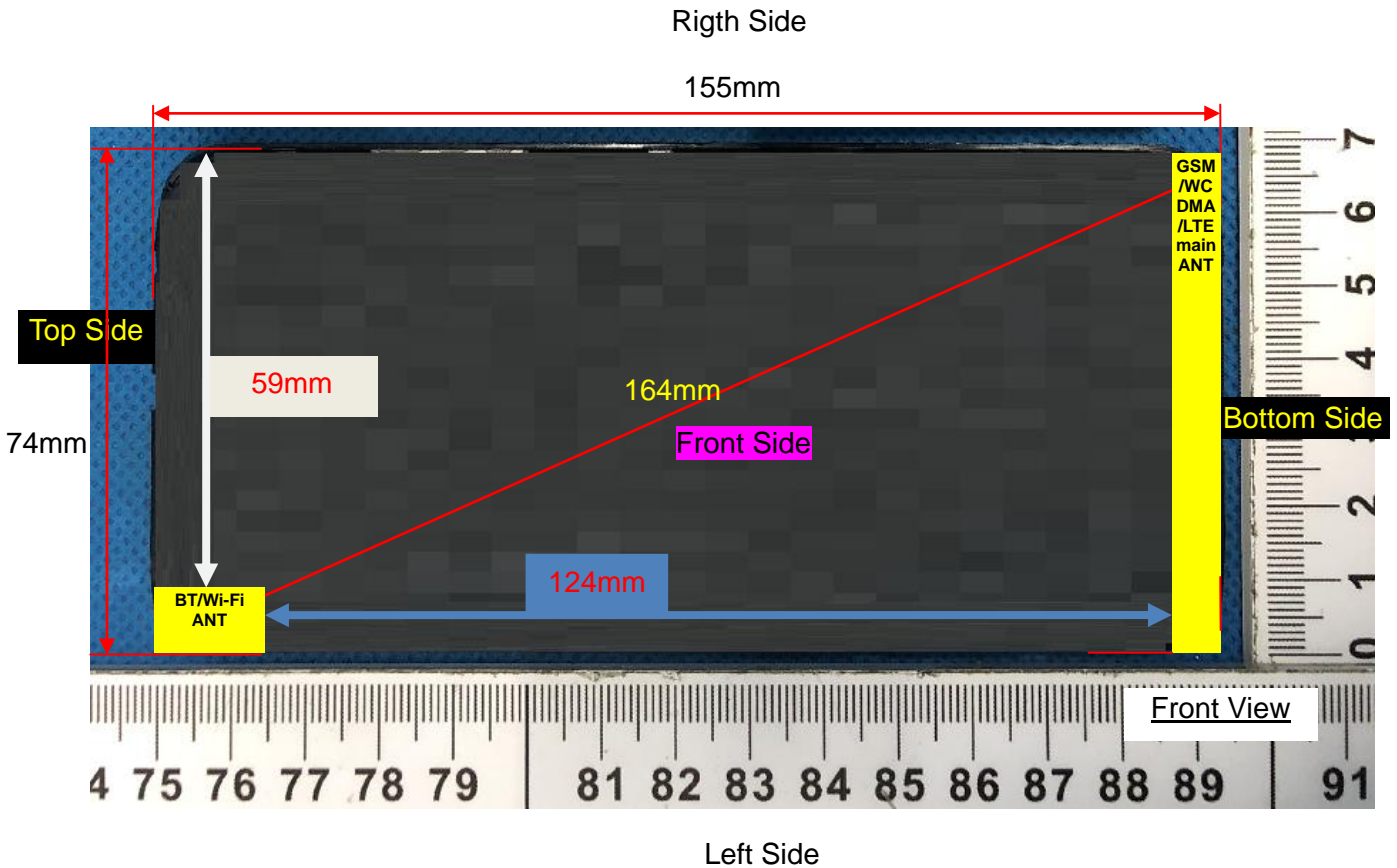

Note: Since the confidentiality request of EUT, the antenna location example diagram see as above.

Distance of the Antenna to the EUT surface/edge						
Antennas	Front Side	Back Side	Left Side	Right Side	Top Side	Bottom Side
WWAN Main ANT	≤ 25mm	≤ 25mm	≤ 25mm	≤ 25mm	> 25mm	≤ 25mm
WLAN & Bluetooth	≤ 25mm	≤ 25mm	≤ 25mm	> 25mm	≤ 25mm	>25mm
Positions for SAR tests						
Antennas	Front Side	Back Side	Left Side	Right Side	Top Side	Bottom Side
WWAN Main ANT	Yes	Yes	Yes	Yes	NO	Yes
WLAN & Bluetooth	Yes	Yes	Yes	NO	Yes	NO

### 9. Stand-alone SAR test exclusion

Refer to FCC KDB 447498D01, the 1-g SAR and 10-g SAR test exclusion thresholds for 100 MHz to 6 GHz at test separation distances ≤ 50 mm are determined by:

$$[(\text{max. power of channel, including tune-up tolerance, mW}) / (\text{min. test separation distance, mm})] \cdot [\sqrt{f_{\text{GHz}}}] \leq 3.0 \text{ for 1-g SAR and } \leq 7.5 \text{ for 10-g extremity SAR, where:}$$

- $f_{\text{GHz}}$  is the RF channel transmit frequency in GHz
- Power and distance are rounded to the nearest mW and mm before calculation
- The result is rounded to one decimal place for comparison

When the minimum test separation distance is < 5 mm, a distance of 5 mm is applied to determine

SAR test exclusion.

Mode	P <sub>max</sub> (dBm)	P <sub>max</sub> (mW)	Distance (mm)	f (GHz)	Calculation Result	SAR Exclusion threshold	SAR test exclusion
Bluetooth	9.00	7.94	5	2.480	2.5	3	Yes

NOTE: Standalone SAR test exclusion for Bluetooth.

When standalone SAR test exclusion applies to an antenna that transmits simultaneously with other antennas, the standalone SAR must be estimated according to following to determine simultaneous transmission SAR test exclusion:

$[(\text{max. power of channel, including tune-up tolerance, mW}) / (\text{min. test separation distance, mm})] * [\sqrt{f_{\text{(GHz)}} / x}] \text{ W/kg}$  for test separation distances  $\leq 50\text{mm}$ , where  $x = 7.5$  for 1-g SAR and  $x = 18.75$  for 10-g SAR.

When the minimum test separation distance is  $< 5 \text{ mm}$ , a distance of  $5 \text{ mm}$  is applied to determine SAR test exclusion.

Mode	Position	P <sub>max</sub> (dBm)	P <sub>max</sub> (mW)	Distance (mm)	f (GHz)	x	Estimated SAR (W/Kg)
Bluetooth	Head	9.00	7.94	5	2.48	7.5	0.334
Bluetooth	Body	9.00	7.94	10	2.48	7.5	0.167
Bluetooth	Hotspot	9.00	7.94	10	2.48	7.5	0.167

NOTE: Estimated SAR calculation for Bluetooth

## 10. SAR Results

### 10.1. SAR measurement Result

#### 10.1.1. SAR measurement Result of GSM850

Test Position of Head	Test channel /Freq.	Mode	SAR Value (W/kg)		Power Drift(%)	Conducted Power (dBm)	Tune-up Power (dBm)	Scaled SAR 1-g (W/Kg)	Date	Plot
			1-g	10-g						
Left Cheek	189/836.4	GPRS(GMSK 2TS)	0.291	0.195	-2.32	29.86	30.00	0.301	2023/3/14	1#
Left Tilt 15 Degree	189/836.4	GPRS(GMSK 2TS)	0.160	0.107	-2.47	29.86	30.00	0.165	2023/3/14	
Right Cheek	189/836.4	GPRS(GMSK 2TS)	0.247	0.162	-1.96	29.86	30.00	0.255	2023/3/14	
Right Tilt 15 Degree	189/836.4	GPRS(GMSK 2TS)	0.132	0.085	2.03	29.86	30.00	0.136	2023/3/14	



NOTE: Head SAR test results of GSM850.

Test Position of Body-Worn with 10mm	Test channel /Freq.	Test Mode	SAR Value (W/kg)		Power Drift (±5%)	Conducted power (dBm)	Tune-up power (dBm)	Scaled SAR 1g (W/Kg)	Date	Plot
			1g	10g						
Front Side	189/836.4	GPRS(GMSK 2TS)	0.252	0.121	3.74	29.86	30.00	0.260	2023/3/14	
Back Side	189/836.4	GPRS(GMSK 2TS)	0.378	0.189	-0.04	29.86	30.00	0.390	2023/3/14	2#

NOTE: Body-Worn SAR test results of GSM850

Test Position of Hotspot with 10mm	Test channel /Freq.	Mode	SAR Value (W/kg)		Power Drift(%)	Conducted Power (dBm)	Tune-up Power (dBm)	Scaled SAR 1-g (W/Kg)	Date	Plot
			1-g	10-g						
Front Side	189/836.4	GPRS(GMSK 2TS)	0.252	0.121	3.74	29.86	30.00	0.260	2023/3/14	
Back Side	189/836.4	GPRS(GMSK 2TS)	0.378	0.189	-0.04	29.86	30.00	0.390	2023/3/14	2#
Left Side	189/836.4	GPRS(GMSK 2TS)	0.120	0.058	-2.95	29.86	30.00	0.124	2023/3/14	
Right Side	189/836.4	GPRS(GMSK 2TS)	0.117	0.059	3.40	29.86	30.00	0.121	2023/3/14	
Bottom Side	189/836.4	GPRS(GMSK 2TS)	0.195	0.094	-3.89	29.86	30.00	0.201	2023/3/14	

NOTE: Hotspot SAR test results of GSM850

**10.1.2. SAR measurement Result of GSM1900**

Test Position of Head	Test channel /Freq.	Mode	SAR Value (W/kg)		Power Drift(%)	Conducted Power (dBm)	Tune-up Power (dBm)	Scaled SAR 1-g (W/Kg)	Date	Plot
			1-g	10-g						
Left Cheek	661/1880	GPRS(GMSK 3TS)	0.409	0.212	2.82	25.03	25.50	0.456	2023/3/13	3#
Left Tilt 15 Degree	661/1880	GPRS(GMSK 3TS)	0.226	0.117	1.80	25.03	25.50	0.252	2023/3/13	

Right Cheek	661/1880	GPRS(GMSK 3TS)	0.356	0.179	-3.30	25.03	25.50	0.397	2023/3/13	
Right Tilt 15 Degree	661/1880	GPRS(GMSK 3TS)	0.193	0.098	-2.49	25.03	25.50	0.215	2023/3/13	

NOTE: Head SAR test results of GSM1900

Test Position of Body-Worn with 10mm	Test channel /Freq.	Test Mode	SAR Value (W/kg)		Power Drift (±5%)	Conducted power (dBm)	Tune-up power (dBm)	Scaled SAR 1g (W/Kg)	Date	Plot
			1g	10g						
Front Side	661/1880	GPRS(GMSK 3TS)	0.324	0.156	0.27	25.03	25.50	0.361	2023/3/13	
Back Side	661/1880	GPRS(GMSK 3TS)	0.492	0.244	-1.80	25.03	25.50	0.548	2023/3/13	4#

NOTE: Body-Worn SAR test results of GSM1900

Test Position of Hotspot with 10mm	Test channel /Freq.	Mode	SAR Value (W/kg)		Power Drift(%)	Conducted Power (dBm)	Tune-up Power (dBm)	Scaled SAR 1-g (W/Kg)	Date	Plot
			1-g	10-g						
Front Side	661/1880	GPRS(GMSK 3TS)	0.324	0.156	0.27	25.03	25.50	0.361	2023/3/13	
Back Side	661/1880	GPRS(GMSK 3TS)	0.492	0.244	-1.80	25.03	25.50	0.548	2023/3/13	4#
Left Side	661/1880	GPRS(GMSK 3TS)	0.156	0.073	1.37	25.03	25.50	0.174	2023/3/13	
Right Side	661/1880	GPRS(GMSK 3TS)	0.162	0.080	3.84	25.03	25.50	0.181	2023/3/13	
Bottom Side	661/1880	GPRS(GMSK 3TS)	0.265	0.125	3.78	25.03	25.50	0.295	2023/3/13	

NOTE: Hotspot SAR test results of GSM1900

**10.1.3. SAR measurement Result of WCDMA Band 2**

Test Position of Head	Test channel	Mode	SAR Value (W/kg)	Power Drift(%)	Conducted Power	Tune-up Power	Scaled SAR	Date	Plot
-----------------------	--------------	------	------------------	----------------	-----------------	---------------	------------	------	------

	/Freq		1-g	10-g		(dBm)	(dBm)	1-g (W/Kg)		
Left Cheek	9400/1880	RMC12.2K	0.583	0.315	0.69	21.74	22.00	0.619	2023/3/13	5#
Left Tilt 15 Degree	9400/1880	RMC12.2K	0.331	0.173	3.17	21.74	22.00	0.351	2023/3/13	
Right Cheek	9400/1880	RMC12.2K	0.534	0.277	-2.46	21.74	22.00	0.567	2023/3/13	
Right Tilt 15 Degree	9400/1880	RMC12.2K	0.280	0.144	3.01	21.74	22.00	0.297	2023/3/13	

NOTE: Head SAR test results of WCDMA Band 2

Test Position of Body-Worn with 10mm	Test channel /Freq.	Test Mode	SAR Value (W/kg)		Power Drift (±5%)	Conducted power (dBm)	Tune-up power (dBm)	Scaled SAR 1g (W/Kg)	Date	Plot
			1g	10g						
Front Side	9400/1880	RMC12.2K	0.450	0.226	-1.54	21.74	22.00	0.478	2023/3/13	
Back Side	9400/1880	RMC12.2K	0.716	0.379	0.80	21.74	22.00	0.760	2023/3/13	6#

NOTE: Body-Worn SAR test results of WCDMA Band 2

Test Position of Hotspot with 10mm	Test channel /Freq.	Mode	SAR Value (W/kg)		Power Drift(%)	Conducted Power (dBm)	Tune-up Power (dBm)	Scaled SAR 1-g (W/Kg)	Date	Plot
			1-g	10-g						
Front Side	9400/1880	RMC12.2K	0.450	0.226	-1.54	21.74	22.00	0.478	2023/3/13	
Back Side	9400/1880	RMC12.2K	0.716	0.379	0.80	21.74	22.00	0.760	2023/3/13	6#
Left Side	9400/1880	RMC12.2K	0.222	0.114	-3.72	21.74	22.00	0.236	2023/3/13	
Right Side	9400/1880	RMC12.2K	0.225	0.118	2.07	21.74	22.00	0.239	2023/3/13	
Bottom Side	9400/1880	RMC12.2K	0.375	0.197	3.99	21.74	22.00	0.398	2023/3/13	

NOTE: Hotspot SAR test results of WCDMA Band 2

**10.1.4. SAR measurement Result of WCDMA Band 4**

Test Position	Test channel /Freq	Mode	SAR Value (W/kg)	Power Drift(%)	Conducted Power	Tune-up Power	Scaled SAR	Date	Plot
---------------	--------------------	------	------------------	----------------	-----------------	---------------	------------	------	------

of Head			1-g	10-g		(dBm)	(dBm)	1-g (W/Kg)		
Left Cheek	1413/1732.6	RMC12.2K	0.104	0.064	0.53	21.82	22.00	0.108	2023/3/06	7#
Left Tilt 15 Degree	1413/1732.6	RMC12.2K	0.057	0.034	-3.50	21.82	22.00	0.059	2023/3/06	
Right Cheek	1413/1732.6	RMC12.2K	0.099	0.060	-2.87	21.82	22.00	0.103	2023/3/06	
Right Tilt 15 Degree	1413/1732.6	RMC12.2K	0.048	0.029	-3.49	21.82	22.00	0.050	2023/3/06	

NOTE: Head SAR test results of WCDMA Band 4

Test Position of Body-Worn with 10mm	Test channel /Freq.	Test Mode	SAR Value (W/kg)		Power Drift (±5%)	Conducted power (dBm)	Tune-up power (dBm)	Scaled SAR 1g (W/Kg)	Date	Plot
			1g	10g						
Front Side	1413/1732.6	RMC12.2K	0.240	0.127	-3.42	21.82	22.00	0.250	2023/3/06	
Back Side	1413/1732.6	RMC12.2K	0.366	0.197	0.01	21.82	22.00	0.381	2023/3/06	8#

NOTE: Body-Worn SAR test results of WCDMA Band 4

Test Position of Hotspot with 10mm	Test channel /Freq.	Mode	SAR Value (W/kg)		Power Drift(%)	Conducted Power (dBm)	Tune-up Power (dBm)	Scaled SAR 1-g (W/Kg)	Date	Plot
			1-g	10-g						
Front Side	1413/1732.6	RMC12.2K	0.240	0.127	-3.42	21.82	22.00	0.250	2023/3/06	
Back Side	1413/1732.6	RMC12.2K	0.366	0.197	0.01	21.82	22.00	0.381	2023/3/06	8#
Left Side	1413/1732.6	RMC12.2K	0.123	0.066	-1.49	21.82	22.00	0.128	2023/3/06	
Right Side	1413/1732.6	RMC12.2K	0.114	0.061	-0.55	21.82	22.00	0.119	2023/3/06	
Bottom Side	1413/1732.6	RMC12.2K	0.200	0.103	-1.34	21.82	22.00	0.208	2023/3/06	

NOTE: Hotspot SAR test results of WCDMA Band 4

**10.1.5. SAR measurement Result of WCDMA Band 5**

Test Position of Head	Test channel /Freq	Mode	SAR Value (W/kg)		Power Drift(%)	Conducted Power (dBm)	Tune-up Power (dBm)	Scaled SAR 1-g (W/Kg)	Date	Plot
			1-g	10-g						
Left Cheek	4182/836.4	RMC12.2K	0.258	0.188	-0.98	21.87	22.00	0.266	2023/3/14	9#
Left Tilt 15 Degree	4182/836.4	RMC12.2K	0.153	0.107	-0.60	21.87	22.00	0.158	2023/3/14	
Right Cheek	4182/836.4	RMC12.2K	0.221	0.159	-2.02	21.87	22.00	0.228	2023/3/14	
Right Tilt 15 Degree	4182/836.4	RMC12.2K	0.103	0.071	-1.70	21.87	22.00	0.106	2023/3/14	

NOTE: Head SAR test results of WCDMA Band 5

Test Position of Body-Worn with 10mm	Test channel /Freq.	Test Mode	SAR Value (W/kg)		Power Drift (±5%)	Conducted power (dBm)	Tune-up power (dBm)	Scaled SAR 1g (W/Kg)	Date	Plot
			1g	10g						
Front Side	4182/836.4	RMC12.2K	0.216	0.115	3.78	21.87	22.00	0.223	2023/3/14	
Back Side	4182/836.4	RMC12.2K	0.329	0.183	-0.95	21.87	22.00	0.339	2023/3/14	10#

NOTE: Body-Worn SAR test results of WCDMA Band 5

Test Position of Hotspot with 10mm	Test channel /Freq.	Mode	SAR Value (W/kg)		Power Drift(%)	Conducted Power (dBm)	Tune-up Power (dBm)	Scaled SAR 1-g (W/Kg)	Date	Plot
			1-g	10-g						
Front Side	4182/836.4	RMC12.2K	0.216	0.115	3.78	21.87	22.00	0.223	2023/3/14	
Back Side	4182/836.4	RMC12.2K	0.329	0.183	-0.95	21.87	22.00	0.339	2023/3/14	10#
Left Side	4182/836.4	RMC12.2K	0.102	0.054	-0.95	21.87	22.00	0.105	2023/3/14	
Right Side	4182/836.4	RMC12.2K	0.102	0.054	0.26	21.87	22.00	0.105	2023/3/14	
Bottom Side	4182/836.4	RMC12.2K	0.180	0.100	0.05	21.87	22.00	0.185	2023/3/14	

NOTE: Hotspot SAR test results of WCDMA Band 5

**10.1.6. SAR measurement Result of LTE Band 2**

Test Position of Head	Test channel /Freq.	Mode	SAR Value (W/kg)		Power Drift(%)	Conducted Power (dBm)	Tune-up Power (dBm)	Scaled SAR 1-g (W/Kg)	Date	Plot
			1-g	10-g						

1RB										
Left Cheek	18900/1880	20M QPSK(1,49)	0.649	0.353	-0.48	21.72	23.00	0.871	2023/3/13	13#
Left Tilt 15 Degree	18900/1880	20M QPSK(1,49)	0.341	0.184	2.35	21.72	23.00	0.458	2023/3/13	
Right Cheek	18900/1880	20M QPSK(1,49)	0.592	0.306	-3.53	21.72	23.00	0.795	2023/3/13	
Right Tilt 15 Degree	18900/1880	20M QPSK(1,49)	0.271	0.144	2.48	21.72	23.00	0.364	2023/3/13	
Left Cheek	18900/1880	20M QPSK(1,49)	0.528	0.273	1.53	22.54	23.00	0.587	1900/1/0	
Left Cheek	18900/1880	20M QPSK(1,49)	0.570	0.307	3.29	22.59	23.00	0.626	1900/1/0	
Left Cheek Repeated	18900/1880	20M QPSK(1,49)	0.637	0.333	0.33	21.72	23.00	0.855	1900/1/0	
50%RB										
Left Cheek	18900/1880	20M QPSK(50,49)	0.358	0.197	-4.94	20.55	21.50	0.446	2023/3/13	
Left Tilt 15 Degree	18900/1880	20M QPSK(50,49)	0.174	0.098	3.91	20.55	21.50	0.217	2023/3/13	
Right Cheek	18900/1880	20M QPSK(50,49)	0.302	0.171	-0.55	20.55	21.50	0.376	2023/3/13	
Right Tilt 15 Degree	18900/1880	20M QPSK(50,49)	0.145	0.079	-1.44	20.55	21.50	0.180	2023/3/13	
100%RB										
Left Cheek	18900/1880	20M QPSK(100,0)	0.310	0.147	-0.44	19.57	20.50	0.384	2023/3/13	

NOTE: Head SAR test results of LTE Band 2

Test Position of Body-Worn with 10mm	Test channel /Freq.	Test Mode	SAR Value (W/kg)		Power Drift (±5%)	Conducted power (dBm)	Tune-up power (dBm)	Scaled SAR 1g (W/Kg)	Date	Plot
			1g	10g						
1RB										
Front Side	18900/1880	20M QPSK(1,49)	0.372	0.137	-0.54	21.72	23.00	0.500	2023/3/13	
Back Side	18900/1880	20M QPSK(1,49)	0.611	0.232	-0.52	21.72	23.00	0.820	2023/3/13	
Back Side	18700/1860	20M	0.794	0.425	-0.84	22.54	23.00	0.883	2023/3/13	

		QPSK(1,49)								
Back Side	19100/1900	20M QPSK(1,49)	0.812	0.431	0.37	22.59	23.00	0.892	2023/3/13	14#
BackSide Repeated	19100/1900	20M QPSK(1,49)	0.802	0.421	0.88	22.59	23.00	0.881	2023/3/13	
50%RB										
Front Side	18900/1880	20M QPSK(50,49)	0.301	0.139	3.32	20.55	21.50	0.375	2023/3/13	
Back Side	18900/1880	20M QPSK(50,49)	0.424	0.247	3.21	20.55	21.50	0.528	2023/3/13	

NOTE: Body-Worn SAR test results of LTE Band 2

Test Position of Hotspot with 10mm	Test channel /Freq.	Mode	SAR Value (W/kg)		Power Drift(%)	Conducted Power (dBm)	Tune-up Power (dBm)	Scaled SAR 1-g (W/Kg)	Date	Plot
			1-g	10-g						
1RB										
Front Side	18900/1880	20M QPSK(1,49)	0.372	0.137	-0.54	21.72	23.00	0.500	2023/3/13	
Back Side	18900/1880	20M QPSK(1,49)	0.611	0.232	-0.52	21.72	23.00	0.820	2023/3/13	
Left Side	18900/1880	20M QPSK(1,49)	0.192	0.071	-2.23	21.72	23.00	0.258	2023/3/13	
Right Side	18900/1880	20M QPSK(1,49)	0.195	0.074	0.69	21.72	23.00	0.262	2023/3/13	
Bottom Side	18900/1880	20M QPSK(1,49)	0.315	0.120	-1.55	21.72	23.00	0.423	2023/3/13	
Back Side	18700/1860	20M QPSK(1,49)	0.794	0.425	-0.84	22.54	23.00	0.883	2023/3/13	
Back Side	19100/1900	20M QPSK(1,49)	0.812	0.431	0.37	22.59	23.00	0.892	2023/3/13	14#
BackSide Repeated	19100/1900	20M QPSK(1,49)	0.802	0.421	0.88	22.59	23.00	0.881	2023/3/13	
50%RB										
Front Side	18900/1880	20M QPSK(50,49)	0.301	0.139	3.32	20.55	21.50	0.375	2023/3/13	
Back Side	18900/1880	20M QPSK(50,49)	0.424	0.247	3.21	20.55	21.50	0.528	2023/3/13	
Left Side	18900/1880	20M	0.135	0.072	-4.15	20.55	21.50	0.168	2023/3/13	

		QPSK(50,49)								
Right Side	18900/1880	20M QPSK(50,49)	0.131	0.078	-2.65	20.55	21.50	0.163	2023/3/13	
Bottom Side	18900/1880	20M QPSK(50,49)	0.252	0.116	-4.06	20.55	21.50	0.314	2023/3/13	
100%RB										
Back Side	18900/1880	20M QPSK(50,49)	0.353	0.178	0.02	19.57	20.50	0.437	2023/3/13	

NOTE: Hotspot SAR test results of LTE Band 2

### 10.1.7. SAR measurement Result of LTE Band 4

Test Position of Head	Test channel /Freq.	Mode	SAR Value (W/kg)		Power Drift(%)	Conducted Power (dBm)	Tune-up Power (dBm)	Scaled SAR 1-g (W/Kg)	Date	Plot
			1-g	10-g						
1RB										
Left Cheek	20175/1732.5	20M QPSK(1,0)	0.402	0.226	-0.03	21.61	22.00	0.440	2023/3/06	15#
Left Tilt 15 Degree	20175/1732.5	20M QPSK(1,0)	0.237	0.127	2.93	21.61	22.00	0.259	2023/3/06	
Right Cheek	20175/1732.5	20M QPSK(1,0)	0.377	0.203	-0.50	21.61	22.00	0.412	2023/3/06	
Right Tilt 15 Degree	20175/1732.5	20M QPSK(1,0)	0.205	0.113	2.67	21.61	22.00	0.224	2023/3/06	
50%RB										
Left Cheek	20175/1732.5	20M QPSK(50,49)	0.229	0.123	2.63	19.49	20.50	0.289	2023/3/06	
Left Tilt 15 Degree	20175/1732.5	20M QPSK(50,49)	0.139	0.071	0.96	19.49	20.50	0.175	2023/3/06	
Right Cheek	20175/1732.5	20M QPSK(50,49)	0.225	0.121	-0.06	19.49	20.50	0.284	2023/3/06	
Right Tilt 15 Degree	20175/1732.5	20M QPSK(50,49)	0.108	0.065	-0.78	19.49	20.50	0.136	2023/3/06	

NOTE: Head SAR test results of LTE Band 4



Test Position of Body-Worn with 10mm	Test channel /Freq.	Test Mode	SAR Value (W/kg)		Power Drift (±5%)	Conducted power (dBm)	Tune-up power (dBm)	Scaled SAR 1g (W/Kg)	Date	Plot
			1g	10g						
1RB										
Front Side	20175/1732.5	20M QPSK(1,0)	0.246	0.127	-2.09	21.61	22.00	0.269	2023/3/06	
Back Side	20175/1732.5	20M QPSK(1,0)	0.397	0.213	-0.31	21.61	22.00	0.434	2023/3/06	16#
50%RB										
Front Side	20175/1732.5	20M QPSK(50,49)	0.134	0.067	-4.46	19.49	20.50	0.169	2023/3/06	
Back Side	20175/1732.5	20M QPSK(50,49)	0.204	0.128	3.61	19.49	20.50	0.257	2023/3/06	

NOTE: Body-Worn SAR test results of LTE Band 4

Test Position of Hotspot with 10mm	Test channel /Freq.	Mode	SAR Value (W/kg)		Power Drift(%)	Conducted Power (dBm)	Tune-up Power (dBm)	Scaled SAR 1-g (W/Kg)	Date	Plot
			1-g	10-g						
1RB										
Front Side	20175/1732.5	20M QPSK(1,0)	0.246	0.127	-2.09	21.61	22.00	0.269	2023/3/06	
Back Side	20175/1732.5	20M QPSK(1,0)	0.397	0.213	-0.31	21.61	22.00	0.434	2023/3/06	16#
Left Side	20175/1732.5	20M QPSK(1,0)	0.120	0.062	-1.97	21.61	22.00	0.131	2023/3/06	
Right Side	20175/1732.5	20M QPSK(1,0)	0.120	0.063	-1.26	21.61	22.00	0.131	2023/3/06	
Bottom Side	20175/1732.5	20M QPSK(1,0)	0.200	0.103	1.50	21.61	22.00	0.219	2023/3/06	
50%RB										
Front Side	20175/1732.5	20M QPSK(50,49)	0.134	0.067	-4.46	19.49	20.50	0.169	2023/3/06	
Back	20175/1732.5	20M	0.204	0.128	3.61	19.49	20.50	0.257	2023/3/06	

Side		QPSK(50,49)								
Left Side	20175/1732.5	20M QPSK(50,49)	0.071	0.033	-3.66	19.49	20.50	0.090	2023/3/06	
Right Side	20175/1732.5	20M QPSK(50,49)	0.063	0.034	-1.08	19.49	20.50	0.079	2023/3/06	
Bottom Side	20175/1732.5	20M QPSK(50,49)	0.111	0.052	1.83	19.49	20.50	0.140	2023/3/06	

NOTE: Hotspot SAR test results of LTE Band 4

**10.1.8. SAR measurement Result of LTE Band 5**

Test Position of Head	Test channel /Freq.	Mode	SAR Value (W/kg)		Power Drift(%)	Conducted Power (dBm)	Tune-up Power (dBm)	Scaled SAR 1-g (W/Kg)	Date	Plot
			1-g	10-g						
1RB										
Left Cheek	20525/836.5	10M QPSK(1,0)	0.239	0.175	-0.17	22.61	23.00	0.261	2023/3/14	17#
Left Tilt 15 Degree	20525/836.5	10M QPSK(1,0)	0.134	0.095	3.58	22.61	23.00	0.147	2023/3/14	
Right Cheek	20525/836.5	10M QPSK(1,0)	0.209	0.145	2.49	22.61	23.00	0.229	2023/3/14	
Right Tilt 15 Degree	20525/836.5	10M QPSK(1,0)	0.104	0.075	2.89	22.61	23.00	0.114	2023/3/14	
50%RB										
Left Cheek	20525/836.5	10M QPSK(25,24)	0.143	0.100	0.01	22.06	22.50	0.158	2023/3/14	
Left Tilt 15 Degree	20525/836.5	10M QPSK(25,24)	0.073	0.054	-1.05	22.06	22.50	0.081	2023/3/14	
Right Cheek	20525/836.5	10M QPSK(25,24)	0.115	0.082	2.47	22.06	22.50	0.127	2023/3/14	
Right Tilt 15 Degree	20525/836.5	10M QPSK(25,24)	0.059	0.039	-3.23	22.06	22.50	0.065	2023/3/14	

NOTE: Head SAR test results of LTE Band 5

Test Position of Body-Worn with 10mm	Test channel /Freq.	Test Mode	SAR Value (W/kg)		Power Drift (±5%)	Conducted power (dBm)	Tune-up power (dBm)	Scaled SAR 1g (W/Kg)	Date	Plot
			1g	10g						
1RB										
Front Side	20525/836.5	10M QPSK(1,0)	0.216	0.117	3.20	22.61	23.00	0.236	2023/3/14	
Back Side	20525/836.5	10M QPSK(1,0)	0.352	0.200	0.54	22.61	23.00	0.385	2023/3/14	18#
50%RB										
Front Side	20525/836.5	10M QPSK(25,24)	0.113	0.059	-4.65	22.06	22.50	0.125	2023/3/14	
Back Side	20525/836.5	10M QPSK(25,24)	0.196	0.115	1.84	22.06	22.50	0.217	2023/3/14	

NOTE: Body-Worn SAR test results of LTE Band 5

Test Position of Hotspot with 10mm	Test channel /Freq.	Mode	SAR Value (W/kg)		Power Drift(%)	Conducted Power (dBm)	Tune-up Power (dBm)	Scaled SAR 1-g (W/Kg)	Date	Plot
			1-g	10-g						
1RB										
Front Side	20525/836.5	10M QPSK(1,0)	0.216	0.117	3.20	22.61	23.00	0.236	2023/3/14	
Back Side	20525/836.5	10M QPSK(1,0)	0.352	0.200	0.54	22.61	23.00	0.385	2023/3/14	18#
Left Side	20525/836.5	10M QPSK(1,0)	0.120	0.067	-1.15	22.61	23.00	0.131	2023/3/14	
Right Side	20525/836.5	10M QPSK(1,0)	0.120	0.068	0.87	22.61	23.00	0.131	2023/3/14	
Bottom Side	20525/836.5	10M QPSK(1,0)	0.190	0.103	-2.66	22.61	23.00	0.208	2023/3/14	
50%RB										
Front Side	20525/836.5	10M QPSK(25,24)	0.113	0.059	-4.65	22.06	22.50	0.125	2023/3/14	
Back	20525/836.5	10M	0.196	0.115	1.84	22.06	22.50	0.217	2023/3/14	

Side		QPSK(25,24)								
Left Side	20525/836.5	10M QPSK(25,24)	0.062	0.035	-3.43	22.06	22.50	0.069	2023/3/14	
Right Side	20525/836.5	10M QPSK(25,24)	0.061	0.038	1.32	22.06	22.50	0.068	2023/3/14	
Bottom Side	20525/836.5	10M QPSK(25,24)	0.113	0.054	2.22	22.06	22.50	0.125	2023/3/14	

NOTE: Hotspot SAR test results of LTE Band 5

**10.1.9. SAR measurement Result of LTE Band 7**

Test Position of Head	Test channel /Freq.	Mode	SAR Value (W/kg)		Power Drift(%)	Conducted Power (dBm)	Tune-up Power (dBm)	Scaled SAR 1-g (W/Kg)	Date	Plot
			1-g	10-g						
1RB										
Left Cheek	21100/2535	20M QPSK(1,0)	0.066	0.033	-2.02	23.48	24.00	0.074	2023/3/10	19#
Left Tilt 15 Degree	21100/2535	20M QPSK(1,0)	0.038	0.018	0.23	23.48	24.00	0.043	2023/3/10	
Right Cheek	21100/2535	20M QPSK(1,0)	0.056	0.027	-3.77	23.48	24.00	0.063	2023/3/10	
Right Tilt 15 Degree	21100/2535	20M QPSK(1,0)	0.028	0.014	2.07	23.48	24.00	0.032	2023/3/10	
50%RB										
Left Cheek	21100/2535	20M QPSK(50,49)	0.037	0.019	-3.66	22.38	22.50	0.038	2023/3/10	
Left Tilt 15 Degree	21100/2535	20M QPSK(50,49)	0.021	0.010	-4.44	22.38	22.50	0.022	2023/3/10	
Right Cheek	21100/2535	20M QPSK(50,49)	0.029	0.014	-0.69	22.38	22.50	0.030	2023/3/10	
Right Tilt 15 Degree	21100/2535	20M QPSK(50,49)	0.015	0.007	0.58	22.38	22.50	0.015	2023/3/10	

NOTE: Head SAR test results of LTE Band 7

Test Position of Body-Worn with 10mm	Test channel /Freq.	Mode	SAR Value (W/kg)		Power Drift(%)	Conducted Power (dBm)	Tune-up Power (dBm)	Scaled SAR 1-g (W/Kg)	Date	Plot
			1-g	10-g						
1RB										
Front Side	21100/2535	20M QPSK(1,0)	0.324	0.146	2.87	23.48	24.00	0.365	2023/3/10	
Back Side	21100/2535	20M QPSK(1,0)	0.524	0.244	-0.43	23.48	24.00	0.591	2023/3/10	20#
50%RB										
Front Side	21100/2535	20M QPSK(50,49)	0.192	0.087	4.79	22.38	22.50	0.197	2023/3/10	
Back Side	21100/2535	20M QPSK(50,49)	0.269	0.137	0.32	22.38	22.50	0.277	2023/3/10	

NOTE: Body-Worn SAR test results of LTE Band 7

Test Position of Hotspot with 10mm	Test channel /Freq.	Mode	SAR Value (W/kg)		Power Drift(%)	Conducted Power (dBm)	Tune-up Power (dBm)	Scaled SAR 1-g (W/Kg)	Date	Plot
			1-g	10-g						
1RB										
Front Side	21100/2535	20M QPSK(1,0)	0.324	0.146	2.87	23.48	24.00	0.365	2023/3/10	
Back Side	21100/2535	20M QPSK(1,0)	0.524	0.244	-0.43	23.48	24.00	0.591	2023/3/10	20#
Left Side	21100/2535	20M QPSK(1,0)	0.171	0.076	2.03	23.48	24.00	0.193	2023/3/10	
Right Side	21100/2535	20M QPSK(1,0)	0.171	0.080	-2.18	23.48	24.00	0.193	2023/3/10	
Bottom Side	21100/2535	20M QPSK(1,0)	0.285	0.126	3.36	23.48	24.00	0.321	2023/3/10	
50%RB										
Front Side	21100/2535	20M QPSK(50,49)	0.192	0.087	4.79	22.38	22.50	0.197	2023/3/10	
Back Side	21100/2535	20M QPSK(50,49)	0.269	0.137	0.32	22.38	22.50	0.277	2023/3/10	
Left Side	21100/2535	20M QPSK(50,49)	0.087	0.043	-2.29	22.38	22.50	0.089	2023/3/10	

Right Side	21100/2535	20M QPSK(50,49)	0.094	0.043	-4.68	22.38	22.50	0.097	2023/3/10	
Bottom Side	21100/2535	20M QPSK(50,49)	0.161	0.071	3.23	22.38	22.50	0.166	2023/3/10	

NOTE: Hotspot SAR test results of LTE Band 7

### 10.1.10. SAR measurement Result of LTE Band 38

Test Position of Head	Test channel /Freq.	Mode	SAR Value (W/kg)		Power Drift(%)	Conducted Power (dBm)	Tune-up Power (dBm)	Scaled SAR 1-g (W/Kg)	Date	Plot
			1-g	10-g						
1RB										
Left Cheek	38000/2595	20M QPSK(1,0)	0.055	0.027	0.92	23.52	24.00	0.061	2023/3/10	21#
Left Tilt 15 Degree	38000/2595	20M QPSK(1,0)	0.028	0.013	-0.29	23.52	24.00	0.031	2023/3/10	
Right Cheek	38000/2595	20M QPSK(1,0)	0.051	0.024	0.65	23.52	24.00	0.057	2023/3/10	
Right Tilt 15 Degree	38000/2595	20M QPSK(1,0)	0.025	0.012	-3.82	23.52	24.00	0.028	2023/3/10	
50%RB										
Left Cheek	38000/2595	20M QPSK(50,0)	0.030	0.014	4.01	22.01	22.50	0.034	2023/3/10	
Left Tilt 15 Degree	38000/2595	20M QPSK(50,0)	0.016	0.008	-3.58	22.01	22.50	0.018	2023/3/10	
Right Cheek	38000/2595	20M QPSK(50,0)	0.026	0.012	4.69	22.01	22.50	0.029	2023/3/10	
Right Tilt 15 Degree	38000/2595	20M QPSK(50,0)	0.013	0.007	4.23	22.01	22.50	0.015	2023/3/10	

NOTE: Head SAR test results of LTE Band 38

Test Position of Body-Worn with 10mm	Test channel /Freq.	Mode	SAR Value (W/kg)		Power Drift(%)	Conducted Power (dBm)	Tune-up Power (dBm)	Scaled SAR 1-g (W/Kg)	Date	Plot
			1-g	10-g						

1RB										
Front Side	38000/2595	20M QPSK(1,0)	0.468	0.210	3.88	23.52	24.00	0.523	2023/3/10	
Back Side	38000/2595	20M QPSK(1,0)	0.742	0.351	0.23	23.52	24.00	0.829	2023/3/10	22#
Back Side	37850/2580	20M QPSK(1,0)	0.711	0.336	2.51	23.52	24.00	0.794	2023/3/10	
Back Side	38150/2610	20M QPSK(1,0)	0.632	0.296	-3.17	23.52	24.00	0.706	2023/3/10	
BackSide Repeated	38000/2595	20M QPSK(1,0)	0.710	0.332	2.95	23.52	24.00	0.793	2023/3/10	
50%RB										
Front Side	38000/2595	20M QPSK(50,0)	0.247	0.116	2.65	22.01	22.50	0.277	2023/3/10	
Back Side	38000/2595	20M QPSK(50,0)	0.405	0.188	2.13	22.01	22.50	0.453	2023/3/10	

NOTE: Body-Worn SAR test results of LTE Band 38

Test Position of Hotspot with 10mm	Test channel /Freq.	Mode	SAR Value (W/kg)		Power Drift(%)	Conducted Power (dBm)	Tune-up Power (dBm)	Scaled SAR 1-g (W/Kg)	Date	Plot
			1-g	10-g						
1RB										
Front Side	38000/2595	20M QPSK(1,0)	0.468	0.210	3.88	23.52	24.00	0.523	2023/3/10	
Back Side	38000/2595	20M QPSK(1,0)	0.742	0.351	0.23	23.52	24.00	0.829	2023/3/10	22#
Left Side	38000/2595	20M QPSK(1,0)	0.225	0.105	-0.97	23.52	24.00	0.251	2023/3/10	
Right Side	38000/2595	20M QPSK(1,0)	0.231	0.109	-1.52	23.52	24.00	0.258	2023/3/10	
Bottom Side	38000/2595	20M QPSK(1,0)	0.380	0.173	0.01	23.52	24.00	0.424	2023/3/10	
Back Side	37850/2580	20M QPSK(1,0)	0.711	0.336	2.51	23.52	24.00	0.794	2023/3/10	
Back Side	38150/2610	20M QPSK(1,0)	0.632	0.296	-3.17	23.52	24.00	0.706	2023/3/10	
BackSide Repeated	38000/2595	20M QPSK(1,0)	0.710	0.332	2.95	23.52	24.00	0.793	2023/3/10	

50%RB										
Front Side	38000/2595	20M QPSK(50,0)	0.247	0.116	2.65	22.01	22.50	0.277	2023/3/10	
Back Side	38000/2595	20M QPSK(50,0)	0.405	0.188	2.13	22.01	22.50	0.453	2023/3/10	
Left Side	38000/2595	20M QPSK(50,0)	0.135	0.056	1.81	22.01	22.50	0.151	2023/3/10	
Right Side	38000/2595	20M QPSK(50,0)	0.122	0.058	2.77	22.01	22.50	0.137	2023/3/10	
Bottom Side	38000/2595	20M QPSK(50,0)	0.191	0.092	4.47	22.01	22.50	0.214	2023/3/10	
100%RB										
Back Side	38000/2595	20M QPSK(50,0)	0.209	0.101	-3.97	20.68	21.00	0.225	2023/3/10	

NOTE: Hotspot SAR test results of LTE Band 38

**10.1.11. SAR measurement Result of LTE Band 66**

Test Position of Head	Test channel /Freq.	Mode	SAR Value (W/kg)		Power Drift(%)	Conducted Power (dBm)	Tune-up Power (dBm)	Scaled SAR 1-g (W/Kg)	Date	Plot
			1-g	10-g						
1RB										
Left Cheek	132322/1745	20M QPSK(1,49)	0.477	0.268	-0.61	20.23	22.00	0.717	2023/3/06	23#
Left Tilt 15 Degree	132322/1745	20M QPSK(1,49)	0.256	0.140	-4.00	20.23	22.00	0.385	2023/3/06	
Right Cheek	132322/1745	20M QPSK(1,49)	0.407	0.229	1.91	20.23	22.00	0.612	2023/3/06	
Right Tilt 15 Degree	132322/1745	20M QPSK(1,49)	0.183	0.102	1.04	20.23	22.00	0.275	2023/3/06	
50%RB										
Left Cheek	132322/1745	20M QPSK(50,24)	0.279	0.152	4.24	19.13	20.50	0.382	2023/3/06	
Left Tilt 15 Degree	132322/1745	20M QPSK(50,24)	0.136	0.074	-3.87	19.13	20.50	0.186	2023/3/06	
Right	132322/1745	20M	0.213	0.117	-2.36	19.13	20.50	0.292	2023/3/06	



Cheek		QPSK(50,24)								
Right Tilt 15 Degree	132322/1745	20M QPSK(50,24)	0.096	0.053	2.08	19.13	20.50	0.132	2023/3/06	

NOTE: Head SAR test results of LTE Band 66

Test Position of Body-Worn with 10mm	Test channel /Freq.	Mode	SAR Value (W/kg)		Power Drift(%)	Conducted Power (dBm)	Tune-up Power (dBm)	Scaled SAR 1-g (W/Kg)	Date	Plot
			1-g	10-g						
1RB										
Front Side	132322/1745	20M QPSK(1,49)	0.276	0.146	0.61	20.23	22.00	0.415	2023/3/06	
Back Side	132322/1745	20M QPSK(1,49)	0.430	0.230	-0.96	20.23	22.00	0.646	2023/3/06	24#
50%RB										
Front Side	132322/1745	20M QPSK(50,24)	0.159	0.085	4.69	19.13	20.50	0.218	2023/3/06	
Back Side	132322/1745	20M QPSK(50,24)	0.220	0.137	1.38	19.13	20.50	0.302	2023/3/06	

NOTE: Body-Worn SAR test results of LTE Band 66

Test Position of Hotspot with 10mm	Test channel /Freq.	Mode	SAR Value (W/kg)		Power Drift(%)	Conducted Power (dBm)	Tune-up Power (dBm)	Scaled SAR 1-g (W/Kg)	Date	Plot
			1-g	10-g						
1RB										
Front Side	132322/1745	20M QPSK(1,49)	0.276	0.146	0.61	20.23	22.00	0.415	2023/3/06	
Back Side	132322/1745	20M QPSK(1,49)	0.430	0.230	-0.96	20.23	22.00	0.646	2023/3/06	24#
Left Side	132322/1745	20M QPSK(1,49)	0.138	0.072	-2.35	20.23	22.00	0.207	2023/3/06	
Right Side	132322/1745	20M QPSK(1,49)	0.141	0.075	3.12	20.23	22.00	0.212	2023/3/06	
Bottom Side	132322/1745	20M QPSK(1,49)	0.240	0.122	2.92	20.23	22.00	0.361	2023/3/06	
50%RB										

Front Side	132322/1745	20M QPSK(50,24)	0.159	0.085	4.69	19.13	20.50	0.218	2023/3/06	
Back Side	132322/1745	20M QPSK(50,24)	0.220	0.137	1.38	19.13	20.50	0.302	2023/3/06	
Left Side	132322/1745	20M QPSK(50,24)	0.073	0.040	0.59	19.13	20.50	0.100	2023/3/06	
Right Side	132322/1745	20M QPSK(50,24)	0.078	0.042	-2.91	19.13	20.50	0.107	2023/3/06	
Bottom Side	132322/1745	20M QPSK(50,24)	0.128	0.065	-4.42	19.13	20.50	0.175	2023/3/06	

NOTE: Hotspot SAR test results of LTE Band 66

**10.1.12. SAR measurement Result of WLAN2.4G**

Test Position of Head	Test channel /Freq.	Mode	SAR Value (W/kg)		Power Drift(%)	Conducted Power (dBm)	Tune-up Power (dBm)	Scaled SAR 1-g (W/Kg)	Date	Plot
			1-g	10-g						
Left Cheek	11/2462	802.11b	0.038	0.021	-1.10	15.53	16.00	0.042	2023/3/08	11#
Left Tilt 15 Degree	11/2462	802.11b	0.021	0.011	-2.77	15.53	16.00	0.023	2023/3/08	
Right Cheek	11/2462	802.11b	0.034	0.018	-1.52	15.53	16.00	0.038	2023/3/08	
Right Tilt 15 Degree	11/2462	802.11b	0.017	0.015	2.83	15.53	16.00	0.019	2023/3/08	

NOTE: Head SAR test results of WLAN2.4G

Test Position of Body-Worn with 10mm	Test channel /Freq.	Mode	SAR Value (W/kg)		Power Drift(%)	Conducted Power (dBm)	Tune-up Power (dBm)	Scaled SAR 1-g (W/Kg)	Date	Plot
			1-g	10-g						
Front Side	11/2462	802.11b	0.048	0.024	-0.63	15.53	16.00	0.053	2023/3/08	
Back Side	11/2462	802.11b	0.066	0.033	-0.99	15.53	16.00	0.074	2023/3/08	12#

NOTE: Body-worn SAR test results of WLAN2.4G

Test Position	Test channel /Freq.	Mode	SAR Value (W/kg)	Power Drift(%)	Conducted Power	Tune-up Power	Scaled SAR	Date	Plot
---------------	---------------------	------	------------------	----------------	-----------------	---------------	------------	------	------

of Hotspot with 10mm			1-g	10-g		(dBm)	(dBm)	1-g (W/Kg)		
Front Side	11/2462	802.11b	0.048	0.024	-0.63	15.53	16.00	0.053	2023/3/08	
Back Side	11/2462	802.11b	0.066	0.033	-0.99	15.53	16.00	0.074	2023/3/08	12#
Left Side	11/2462	802.11b	0.030	0.014	-0.79	15.53	16.00	0.033	2023/3/08	
Top Side	11/2462	802.11b	0.024	0.012	-2.55	15.53	16.00	0.027	2023/3/08	

NOTE: Hotspot SAR test results of WLAN2.4G

### 10.2. Simultaneous Transmission Analysis

Per KDB 447498 D01, simultaneous transmission SAR is compliant if,

- 1) Scalar SAR summation < 1.6W/kg.
- 2)  $SPLSR = (SAR_1 + SAR_2)^{1.5} / (\text{min. separation distance, mm})$ , and the peak separation distance is determined from the square root of  $[(x_1-x_2)^2 + (y_1-y_2)^2 + (z_1-z_2)^2]$ , where  $(x_1, y_1, z_1)$  and  $(x_2, y_2, z_2)$  are the coordinates of the extrapolated peak SAR locations in the zoom scan. If  $SPLSR \leq 0.04$ , simultaneously transmission SAR measurement is not necessary.

Test Position		Scaled SAR <sub>MAX</sub>		Σ 1-g SAR (W/Kg)	SPLSR	Remark
		WWAN	DTS			
Head	Left Cheek	0.871	0.042	0.913	N/A	N/A
	Left Tilt 15 Degree	0.458	0.023	0.481	N/A	N/A
	Right Cheek	0.795	0.038	0.833	N/A	N/A
	Right Tilt 15 Degree	0.364	0.019	0.383	N/A	N/A
Body-Worn	Front Side	0.523	0.053	0.576	N/A	N/A
	Back Side	0.892	0.074	0.966	N/A	N/A
Hotspot	Front Side	0.523	0.053	0.576	N/A	N/A
	Back Side	0.892	0.074	0.966	N/A	N/A
	Left Side	0.258	0.033	0.291	N/A	N/A
	Right Side	0.262	N/A	0.262	N/A	N/A
	Top Side	N/A	0.027	0.027	N/A	N/A
	Bottom Side	0.424	N/A	0.424	N/A	N/A

Test Position	Scaled SAR <sub>MAX</sub>	Σ 1-g SAR	SPLSR	Remark
---------------	---------------------------	-----------	-------	--------

		WWAN	DSS	(W/Kg)		
Head	Left Cheek	0.871	0.334	1.205	N/A	N/A
	Left Tilt 15 Degree	0.458	0.334	0.792	N/A	N/A
	Right Cheek	0.795	0.334	1.129	N/A	N/A
	Right Tilt 15 Degree	0.364	0.334	0.698	N/A	N/A
Body-Worn	Front Side	0.523	0.167	0.690	N/A	N/A
	Back Side	0.892	0.167	1.059	N/A	N/A
Hotspot	Front Side	0.523	0.167	0.690	N/A	N/A
	Back Side	0.892	0.167	1.059	N/A	N/A
	Left Side	0.258	0.167	0.425	N/A	N/A
	Right Side	0.262	0.167	0.429	N/A	N/A
	Top Side	N/A	0.167	0.167	N/A	N/A
	Bottom Side	0.424	0.167	0.591	N/A	N/A

**11. Appendix A. Photo documentation**

Refer to appendix Test Setup photo---SAR

## 12. Appendix B. System Check Plots

Table of contents
MEASUREMENT 1 System Performance Check - 835MHz
MEASUREMENT 2 System Performance Check - 1800MHz
MEASUREMENT 3 System Performance Check - 1900MHz
MEASUREMENT 4 System Performance Check - 2450MHz
MEASUREMENT 5 System Performance Check - 2600MHz

# MEASUREMENT 1

Date of measurement: 14/3/2023

## A. Experimental conditions.

<b>Area Scan</b>	<u>dx=15mm dy=15mm, h= 5.00 mm</u>
<b>ZoomScan</b>	<u>5x5x7, dx=8mm dy=8mm dz=5mm</u>
<b>Phantom</b>	<u>Validation plane</u>
<b>Device Position</b>	<u>Dipole</u>
<b>Band</b>	<u>CW835</u>
<b>Channels</b>	<u>Middle</u>
<b>Signal</b>	<u>CW (Crest factor: 1.0)</u>
<b>ConvF</b>	<u>1.50</u>

## B. SAR Measurement Results

<b>Frequency (MHz)</b>	835.000000
<b>Relative permittivity (real part)</b>	41.293576
<b>Relative permittivity (imaginary part)</b>	19.919841
<b>Conductivity (S/m)</b>	0.924059
<b>Variation (%)</b>	-3.920000

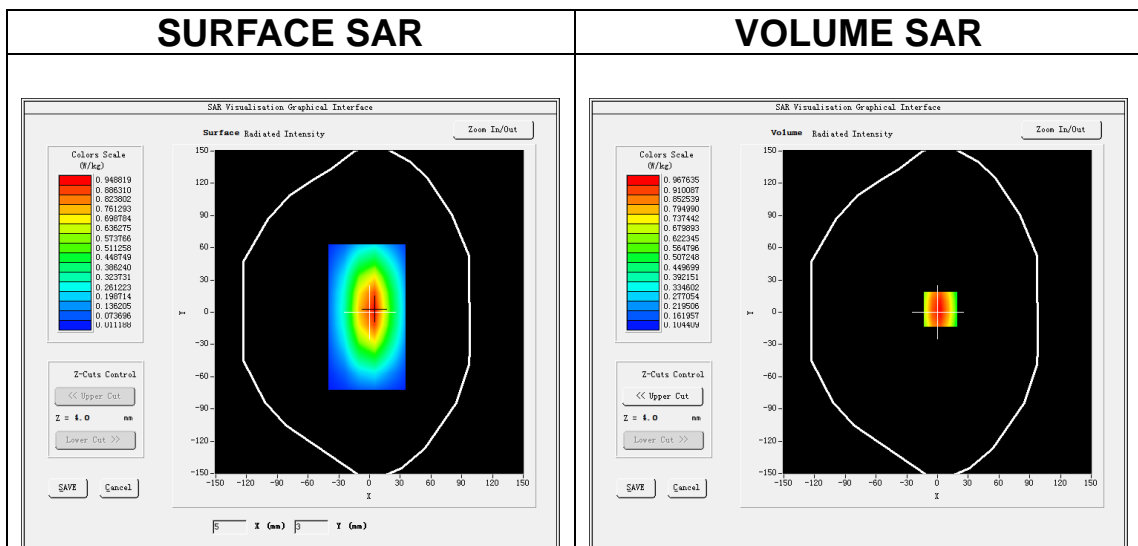

**Maximum location: X=3.00, Y=3.00**  
**SAR Peak: 1.30 W/kg**

<b>SAR 10g (W/Kg)</b>	0.634158
<b>SAR 1g (W/Kg)</b>	0.935222

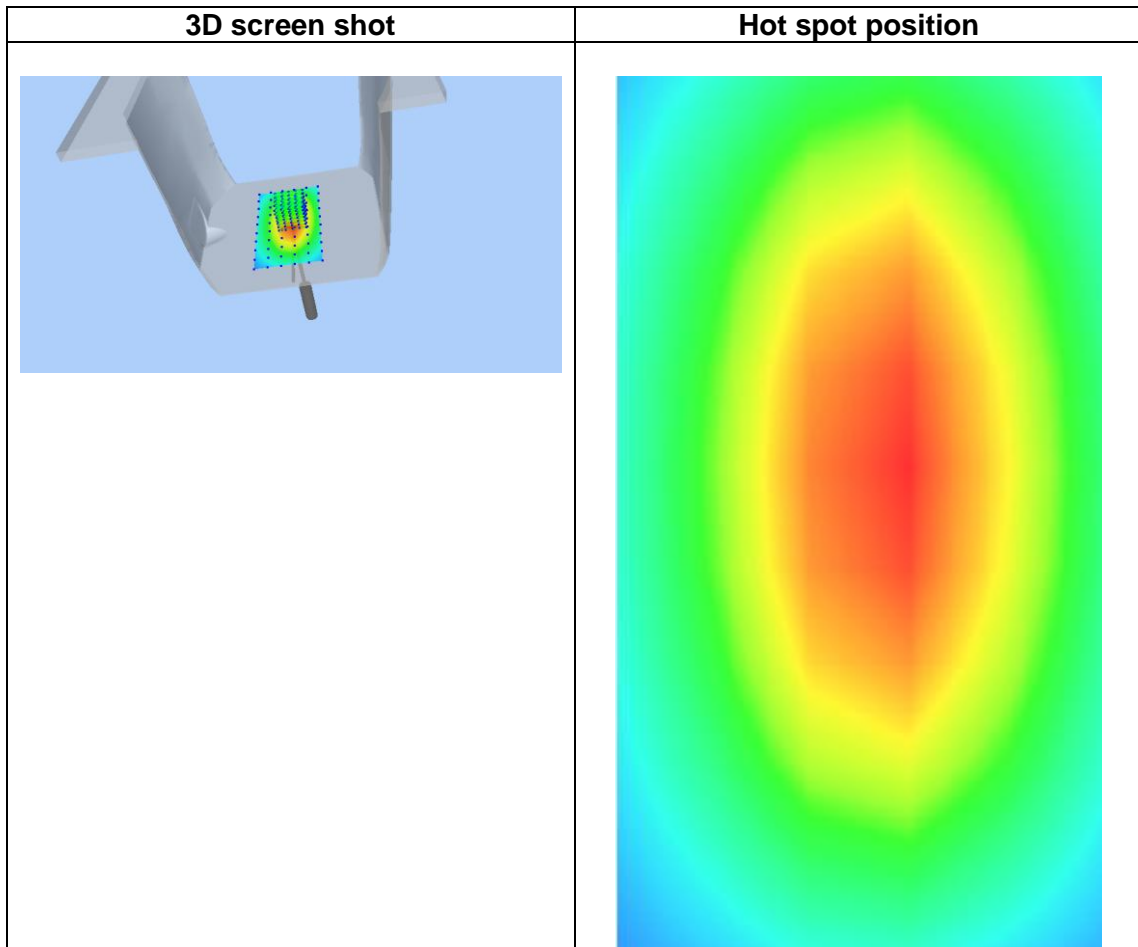
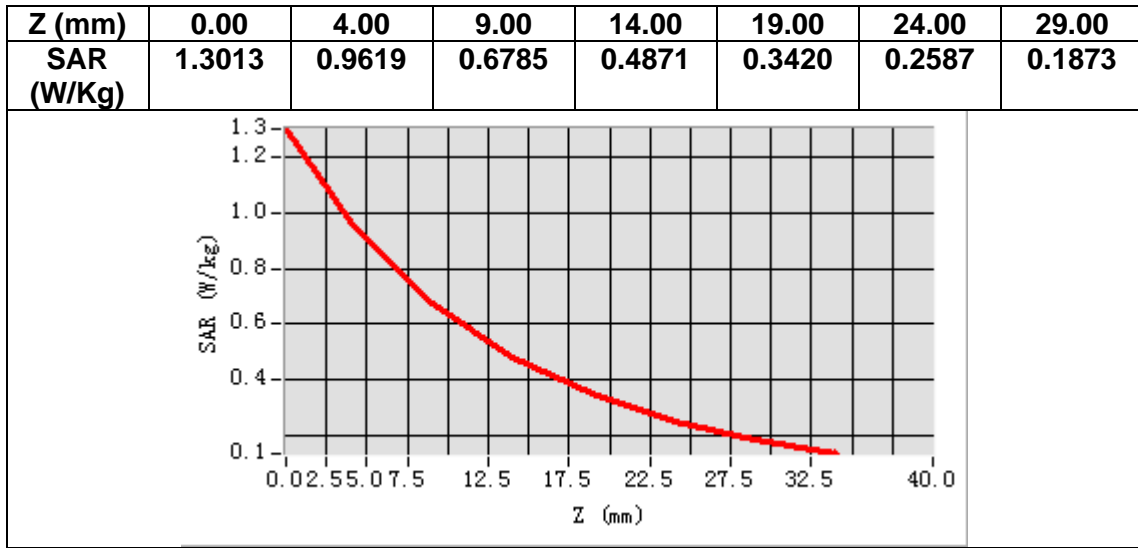

## MEASUREMENT 2

Date of measurement: 6/3/2023

### A. Experimental conditions.

<b>Area Scan</b>	<u>dx=15mm dy=15mm, h= 5.00 mm</u>
<b>ZoomScan</b>	<u>5x5x7, dx=8mm dy=8mm dz=5mm</u>
<b>Phantom</b>	<u>Validation plane</u>
<b>Device Position</b>	<u>Dipole</u>
<b>Band</b>	<u>CW1800</u>
<b>Channels</b>	<u>Middle</u>
<b>Signal</b>	<u>CW (Crest factor: 1.0)</u>
<b>ConvF</b>	<u>1.73</u>

### B. SAR Measurement Results

<b>Frequency (MHz)</b>	1800.000000
<b>Relative permittivity (real part)</b>	38.962126
<b>Relative permittivity (imaginary part)</b>	13.799279
<b>Conductivity (S/m)</b>	1.379928
<b>Variation (%)</b>	-1.080000

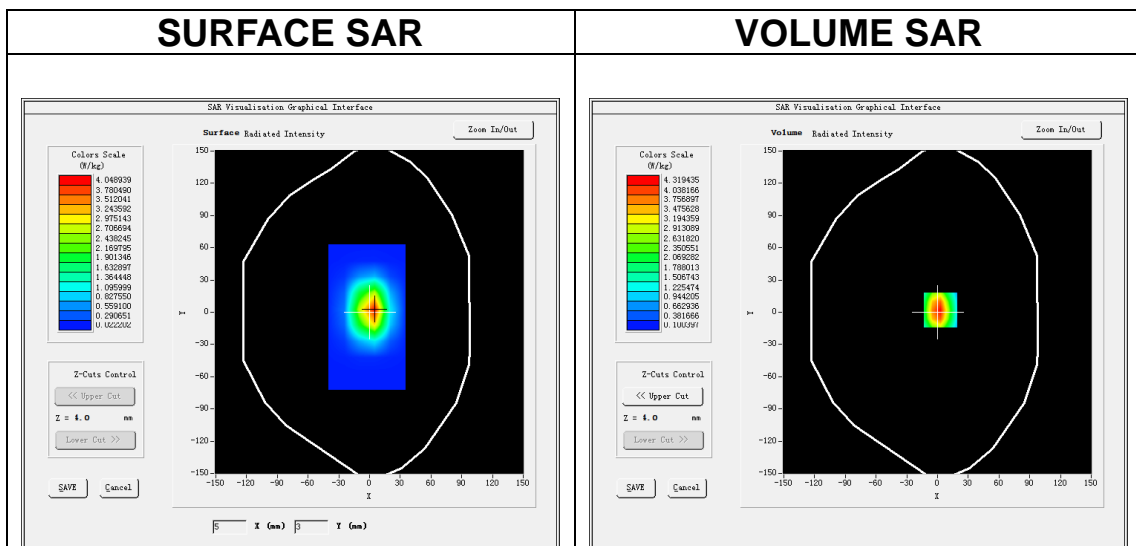

**Maximum location: X=3.00, Y=2.00**  
**SAR Peak: 6.82 W/kg**

<b>SAR 10g (W/Kg)</b>	1.885321
<b>SAR 1g (W/Kg)</b>	4.136203



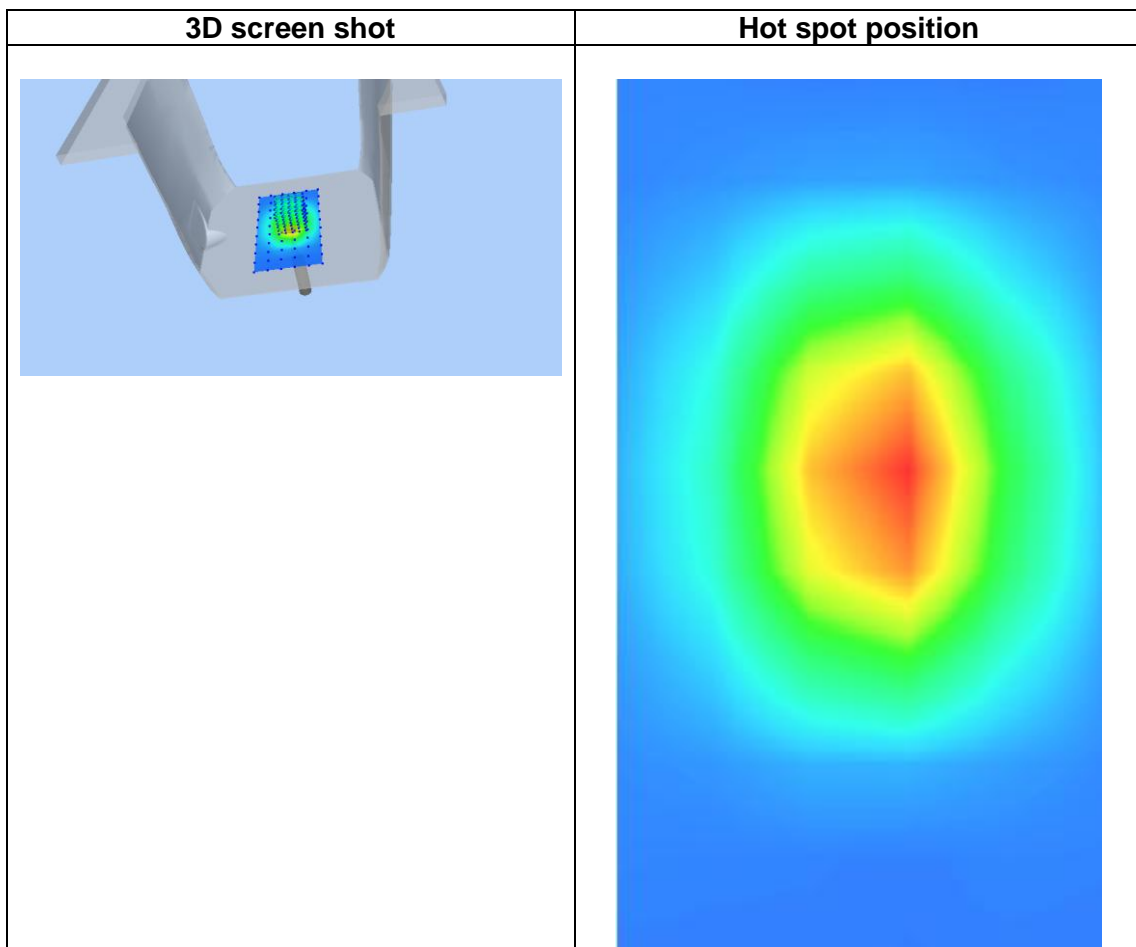
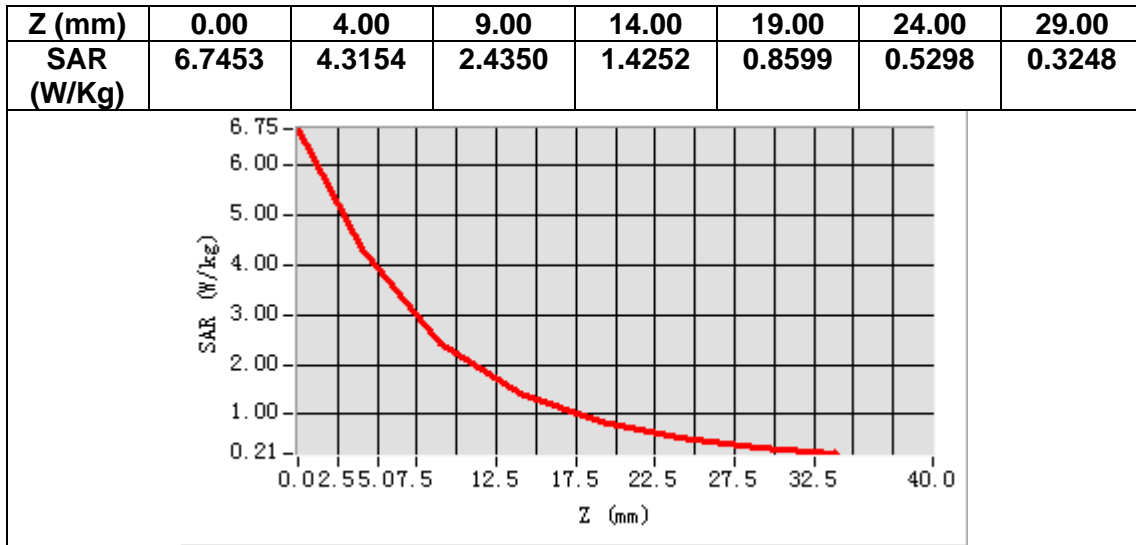

# MEASUREMENT 3

Date of measurement: 13/3/2023

## A. Experimental conditions.

<b>Area Scan</b>	<u>dx=15mm dy=15mm, h= 5.00 mm</u>
<b>ZoomScan</b>	<u>5x5x7, dx=8mm dy=8mm dz=5mm</u>
<b>Phantom</b>	<u>Validation plane</u>
<b>Device Position</b>	<u>Dipole</u>
<b>Band</b>	<u>CW1900</u>
<b>Channels</b>	<u>Middle</u>
<b>Signal</b>	<u>CW (Crest factor: 1.0)</u>
<b>ConvF</b>	<u>1.91</u>

## B. SAR Measurement Results

<b>Frequency (MHz)</b>	1900.000000
<b>Relative permittivity (real part)</b>	38.698190
<b>Relative permittivity (imaginary part)</b>	13.429836
<b>Conductivity (S/m)</b>	1.417594
<b>Variation (%)</b>	1.540000

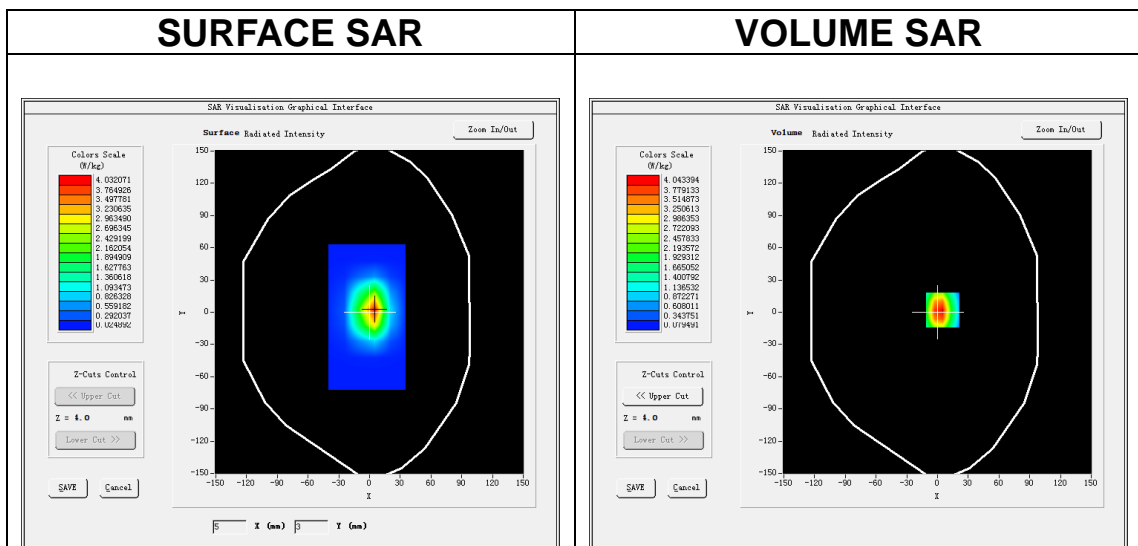

**Maximum location: X=5.00, Y=2.00**  
**SAR Peak: 6.70 W/kg**

<b>SAR 10g (W/Kg)</b>	1.922249
<b>SAR 1g (W/Kg)</b>	3.726252

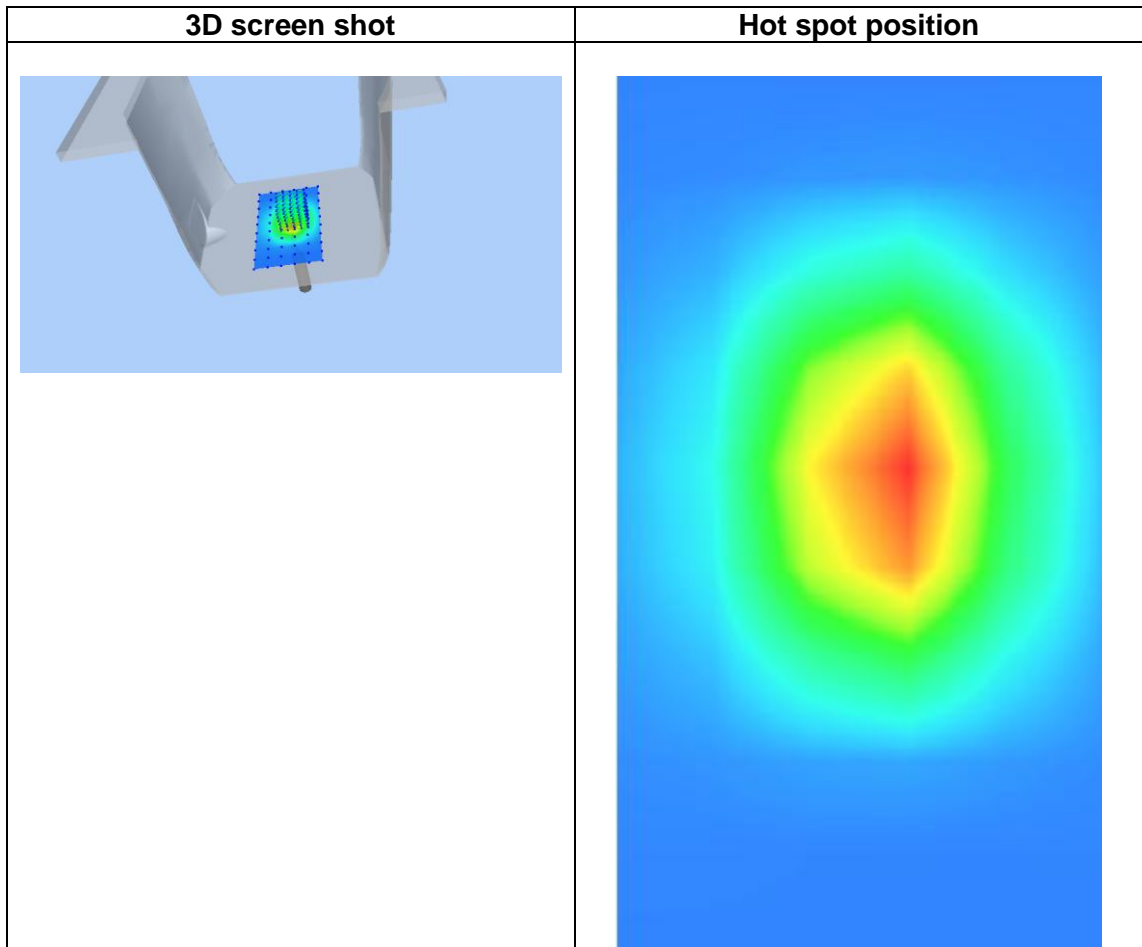
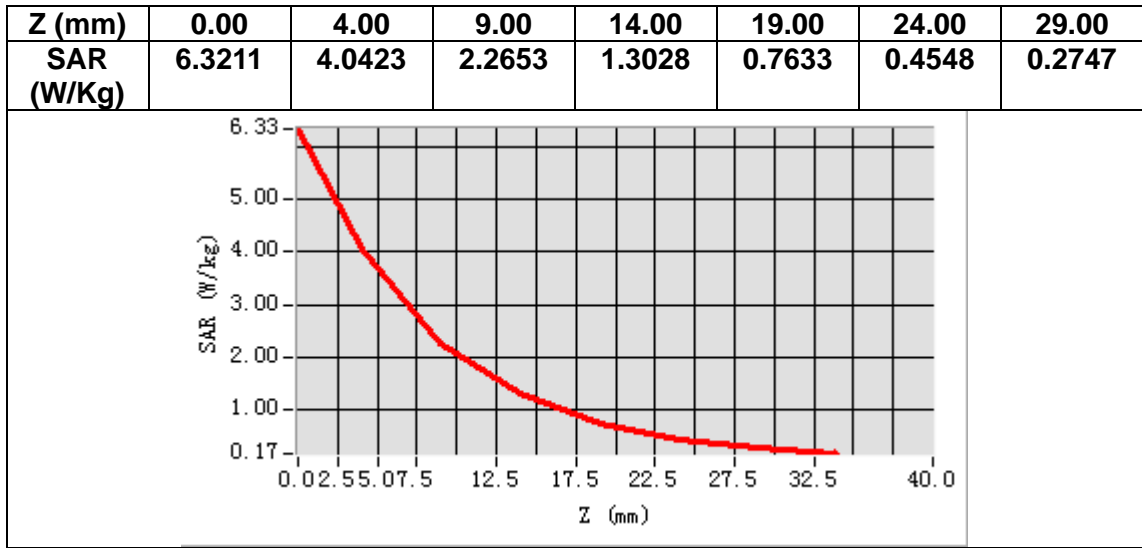

# MEASUREMENT 4

Date of measurement: 8/3/2023

## A. Experimental conditions.

<b>Area Scan</b>	<u>dx=12mm dy=12mm, h= 5.00 mm</u>
<b>ZoomScan</b>	<u>7x7x7, dx=5mm dy=5mm dz=5mm</u>
<b>Phantom</b>	<u>Validation plane</u>
<b>Device Position</b>	<u>Dipole</u>
<b>Band</b>	<u>CW2450</u>
<b>Channels</b>	<u>Middle</u>
<b>Signal</b>	<u>CW (Crest factor: 1.0)</u>
<b>ConvF</b>	<u>1.98</u>

## B. SAR Measurement Results

<b>Frequency (MHz)</b>	2450.000000
<b>Relative permittivity (real part)</b>	38.640497
<b>Relative permittivity (imaginary part)</b>	13.448411
<b>Conductivity (S/m)</b>	1.830478
<b>Variation (%)</b>	0.660000

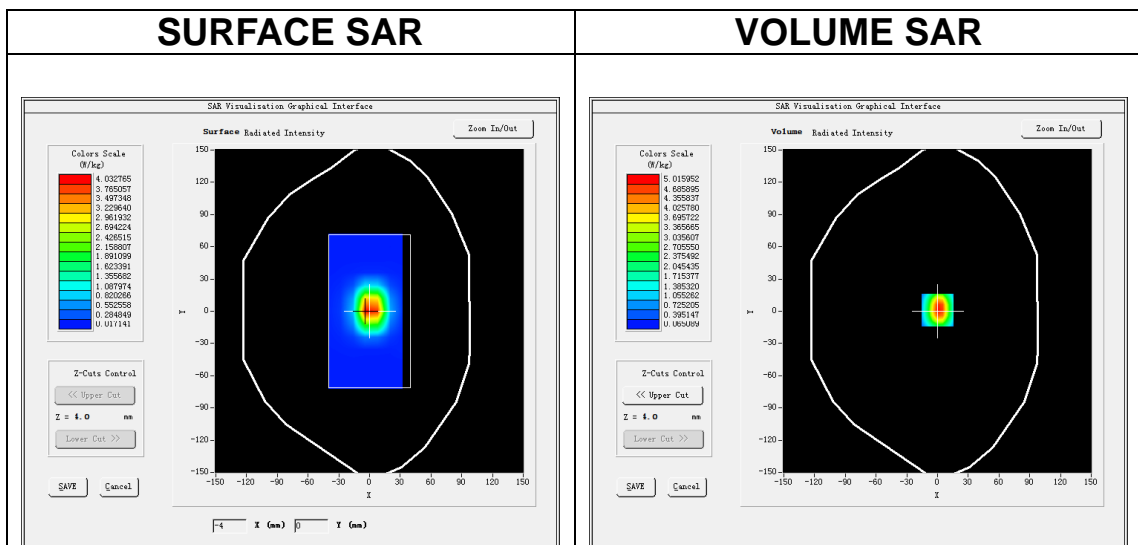

**Maximum location: X=0.00, Y=1.00**

**SAR Peak: 8.14 W/kg**

<b>SAR 10g (W/Kg)</b>	2.309157
<b>SAR 1g (W/Kg)</b>	5.319305

<b>Z (mm)</b>	<b>0.00</b>	<b>4.00</b>	<b>9.00</b>	<b>14.00</b>	<b>19.00</b>	<b>24.00</b>	<b>29.00</b>
<b>SAR (W/Kg)</b>	<b>8.0374</b>	<b>5.0192</b>	<b>2.6968</b>	<b>1.4823</b>	<b>0.8302</b>	<b>0.4697</b>	<b>0.2656</b>

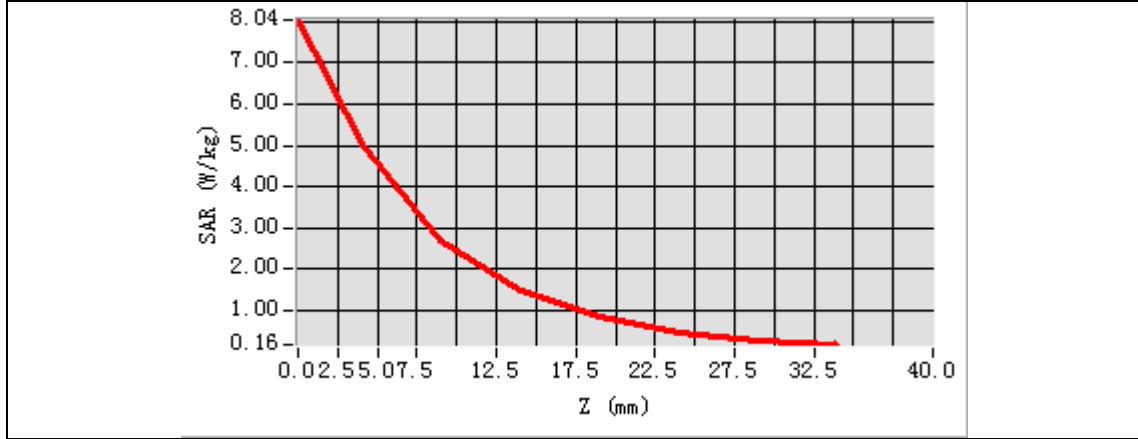

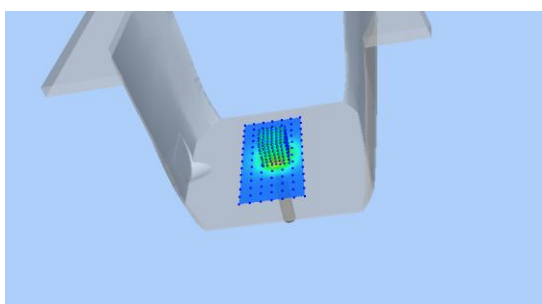
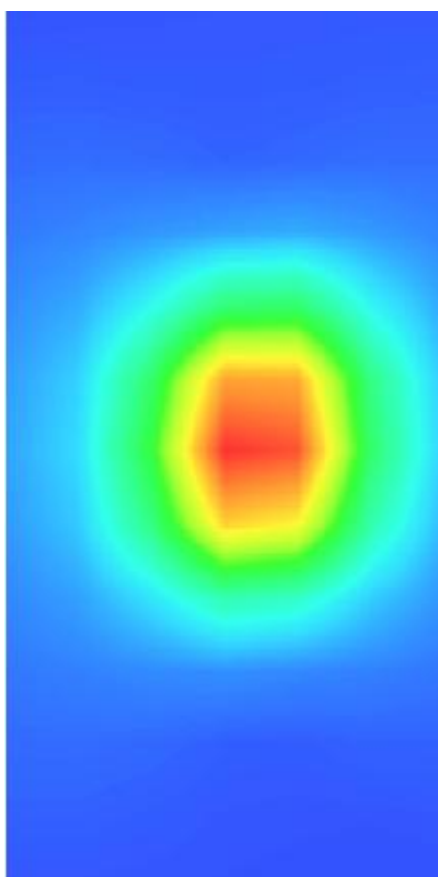
3D screen shot	Hot spot position
	

# MEASUREMENT 5

Date of measurement: 10/3/2023

## A. Experimental conditions.

<b>Area Scan</b>	<u>dx=12mm dy=12mm, h= 5.00 mm</u>
<b>ZoomScan</b>	<u>7x7x7, dx=5mm dy=5mm dz=5mm</u>
<b>Phantom</b>	<u>Validation plane</u>
<b>Device Position</b>	<u>Dipole</u>
<b>Band</b>	<u>CW2600</u>
<b>Channels</b>	<u>Middle</u>
<b>Signal</b>	<u>CW (Crest factor: 1.0)</u>
<b>ConvF</b>	<u>1.87</u>

## B. SAR Measurement Results

<b>Frequency (MHz)</b>	2600.000000
<b>Relative permittivity (real part)</b>	38.046305
<b>Relative permittivity (imaginary part)</b>	13.714823
<b>Conductivity (S/m)</b>	1.981030
<b>Variation (%)</b>	-0.680000

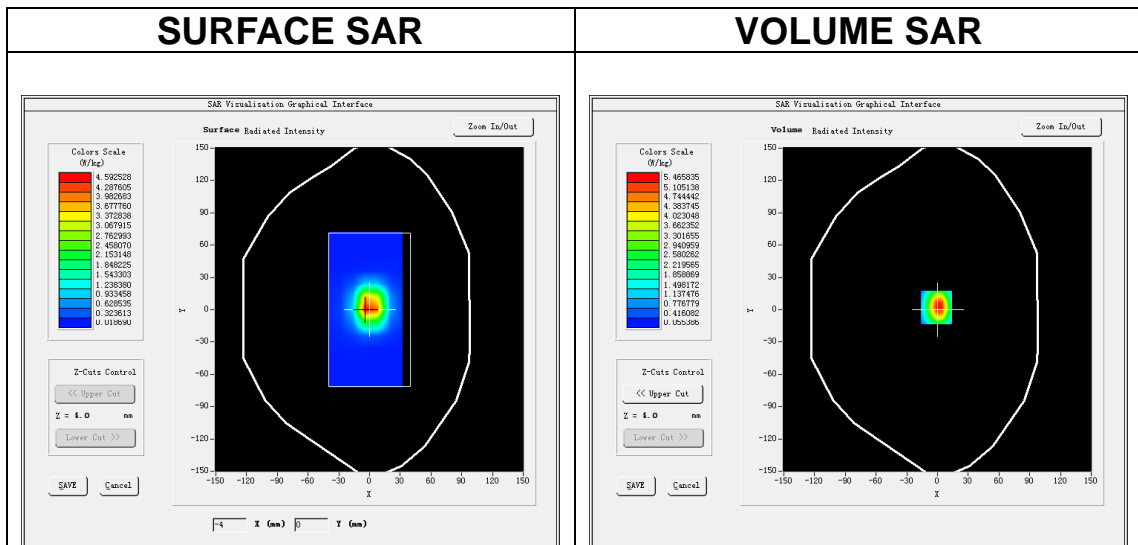

**Maximum location: X=-1.00, Y=2.00**

**SAR Peak: 9.07 W/kg**

<b>SAR 10g (W/Kg)</b>	2.574045
<b>SAR 1g (W/Kg)</b>	5.308270

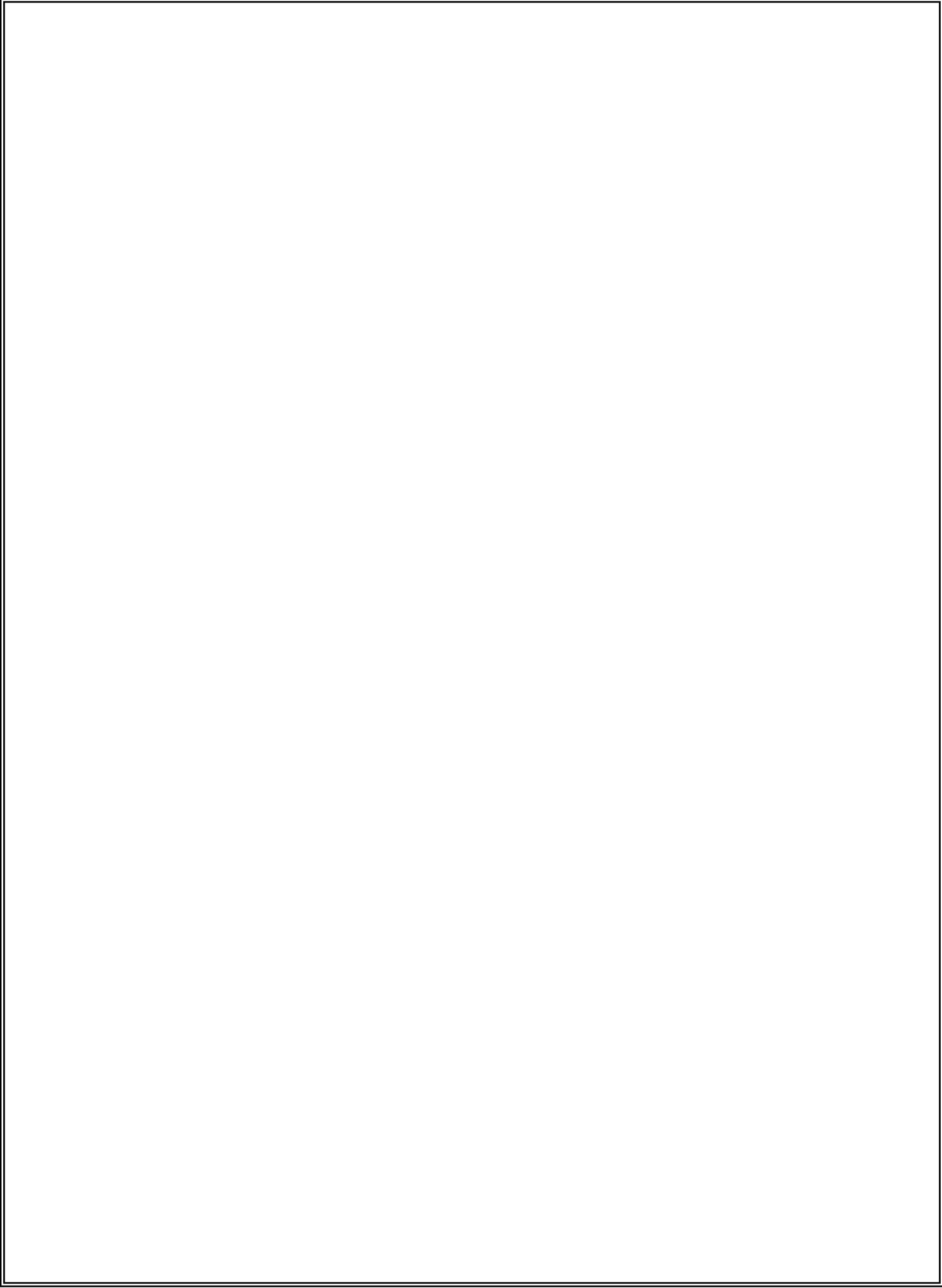

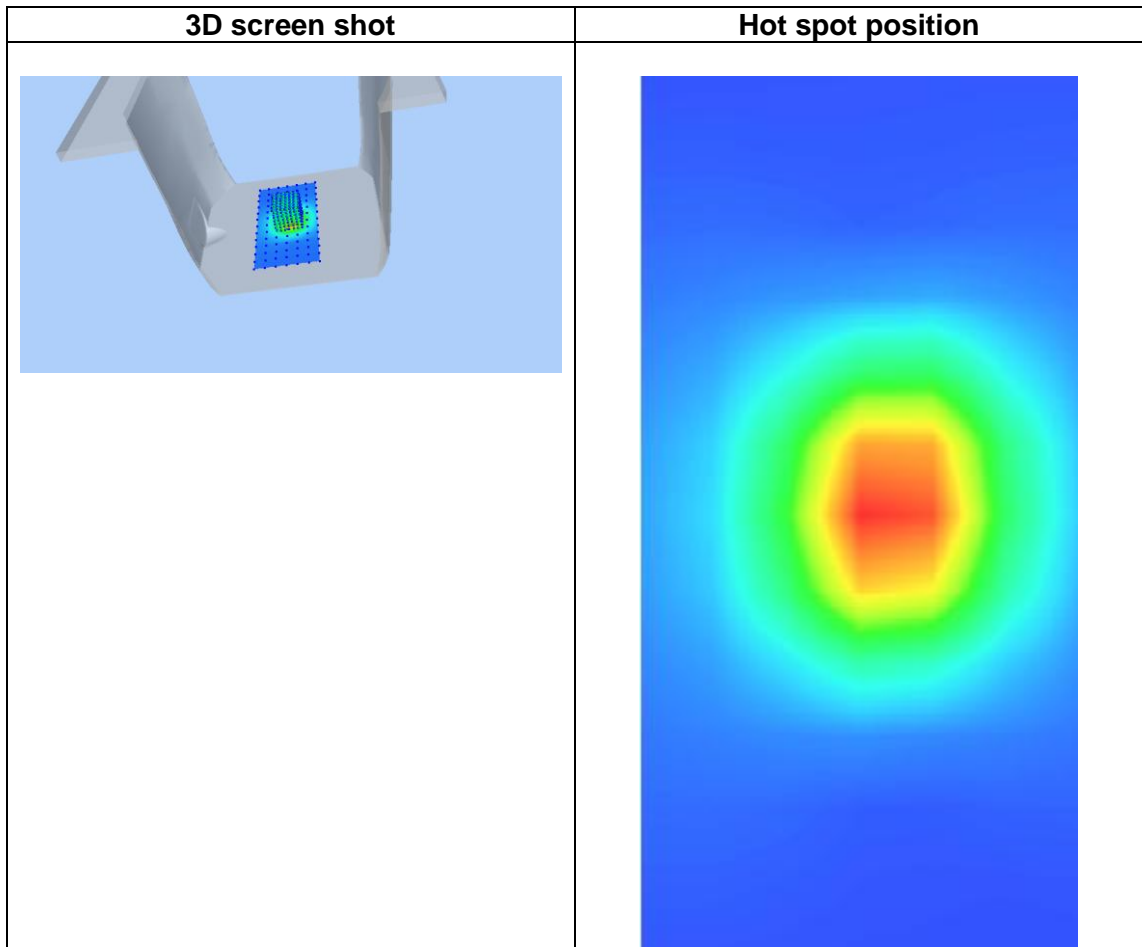
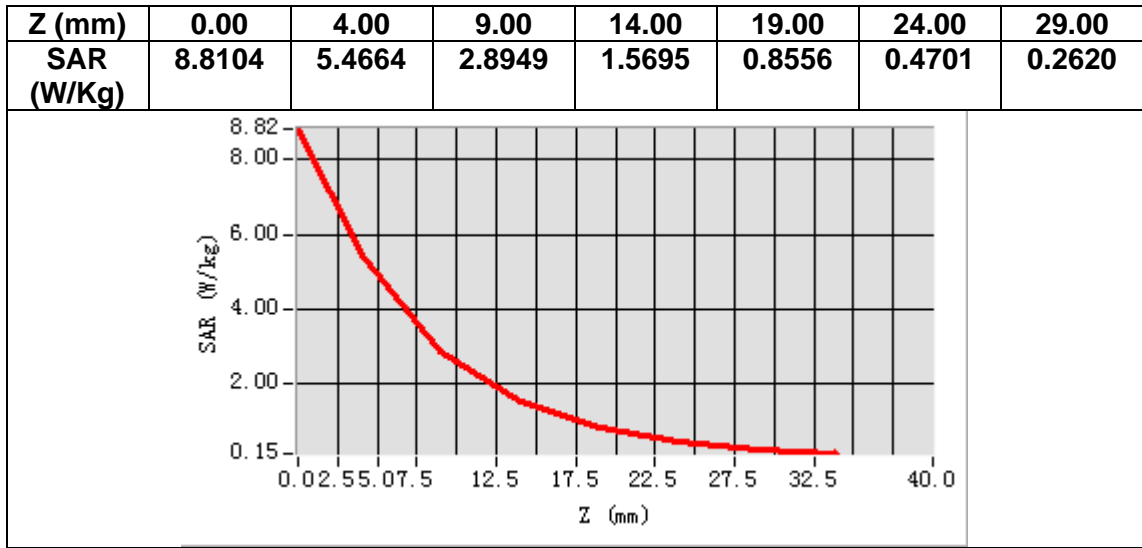



### 13. Appendix C. Plots of High SAR Measurement

Table of contents
<b>MEASUREMENT 1 GSM 850 Head</b>
<b>MEASUREMENT 2 GSM 850 Body</b>
<b>MEASUREMENT 3 GSM 1900 Head</b>
<b>MEASUREMENT 4 GSM 1900 Body</b>
<b>MEASUREMENT 5 WCDMA Band 2 Head</b>
<b>MEASUREMENT 6 WCDMA Band 2 Body</b>
<b>MEASUREMENT 7 WCDMA Band 4 Head</b>
<b>MEASUREMENT 8 WCDMA Band 4 Body</b>
<b>MEASUREMENT 9 WCDMA Band 5 Head</b>
<b>MEASUREMENT 10 WCDMA Band 5 Body</b>
<b>MEASUREMENT 11 WLAN 2.4G Head</b>
<b>MEASUREMENT 12 WLAN 2.4G Body</b>
<b>MEASUREMENT 13 LTE Band 2 Head</b>
<b>MEASUREMENT 14 LTE Band 2 Body</b>
<b>MEASUREMENT 15 LTE Band 4 Head</b>
<b>MEASUREMENT 16 LTE Band 4 Body</b>
<b>MEASUREMENT 17 LTE Band 5 Head</b>
<b>MEASUREMENT 18 LTE Band 5 Body</b>
<b>MEASUREMENT 19 LTE Band 7 Head</b>
<b>MEASUREMENT 20 LTE Band 7 Body</b>
<b>MEASUREMENT 21 LTE Band 38 Head</b>
<b>MEASUREMENT 22 LTE Band 38 Body</b>
<b>MEASUREMENT 23 LTE Band 66 Head</b>
<b>MEASUREMENT 24 LTE Band 66 Body</b>

# MEASUREMENT 1

Date of measurement: 14/3/2023

## A. Experimental conditions.

<b>Area Scan</b>	<u>dx=15mm dy=15mm, h= 5.00 mm</u>
<b>ZoomScan</b>	<u>5x5x7, dx=8mm dy=8mm dz=5mm</u>
<b>Phantom</b>	<u>Left head</u>
<b>Device Position</b>	<u>Cheek</u>
<b>Band</b>	<u>GSM850</u>
<b>Channels</b>	<u>Middle</u>
<b>Signal</b>	<u>TDMA (Crest factor: 4.0)</u>
<b>ConvF</b>	<u>1.50</u>

## B. SAR Measurement Results

<b>Frequency (MHz)</b>	836.400000
<b>Relative permittivity (real part)</b>	41.209236
<b>Relative permittivity (imaginary part)</b>	19.945681
<b>Conductivity (S/m)</b>	0.926809
<b>Variation (%)</b>	-2.320000

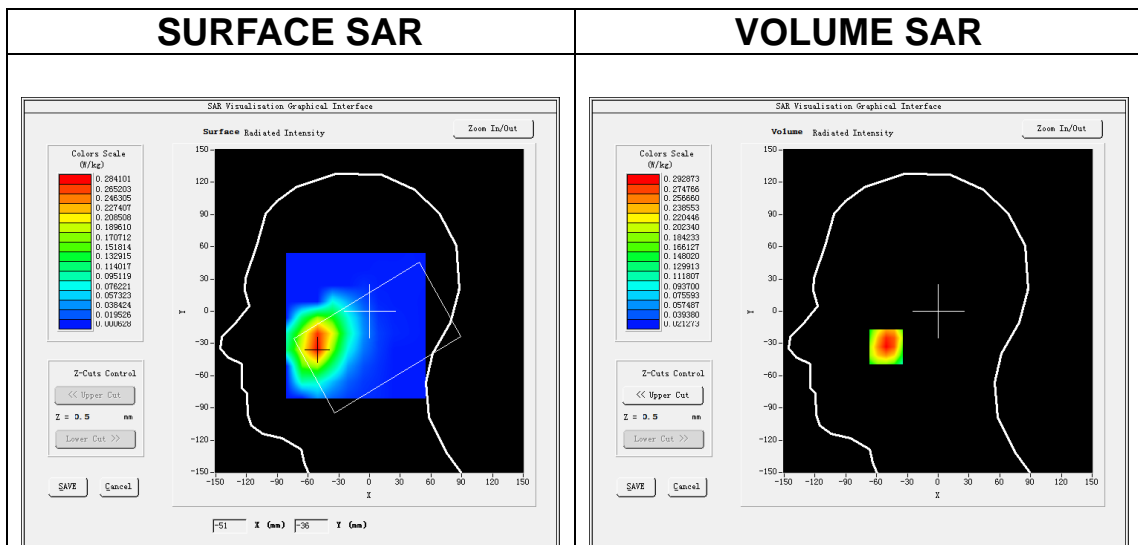

**Maximum location: X=-51.00, Y=-33.00**  
**SAR Peak: 0.40 W/kg**

<b>SAR 10g (W/Kg)</b>	0.194669
<b>SAR 1g (W/Kg)</b>	0.290974

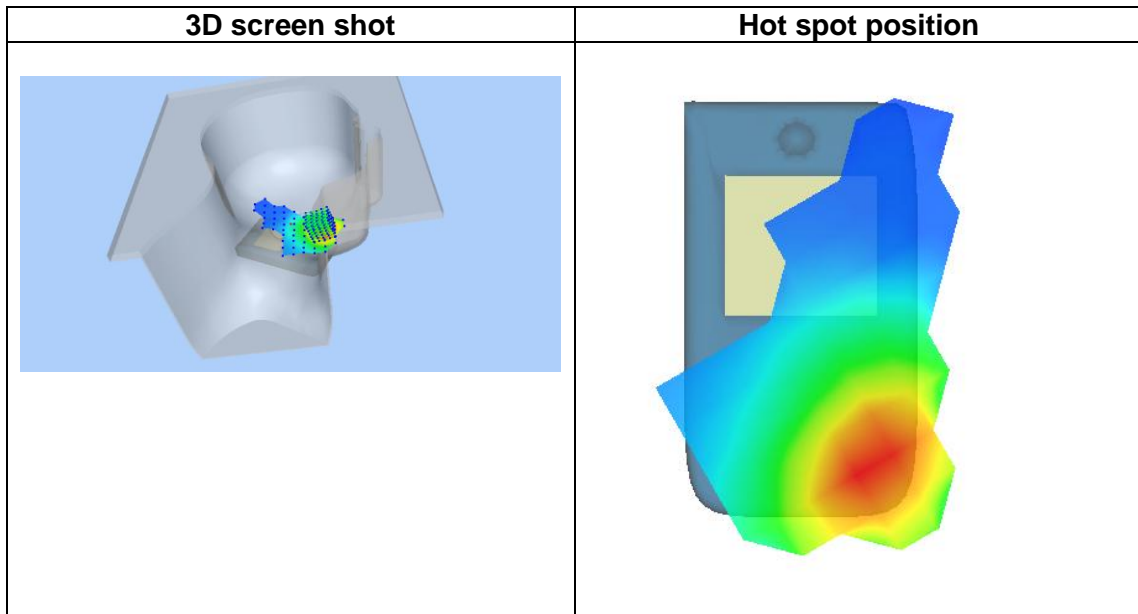
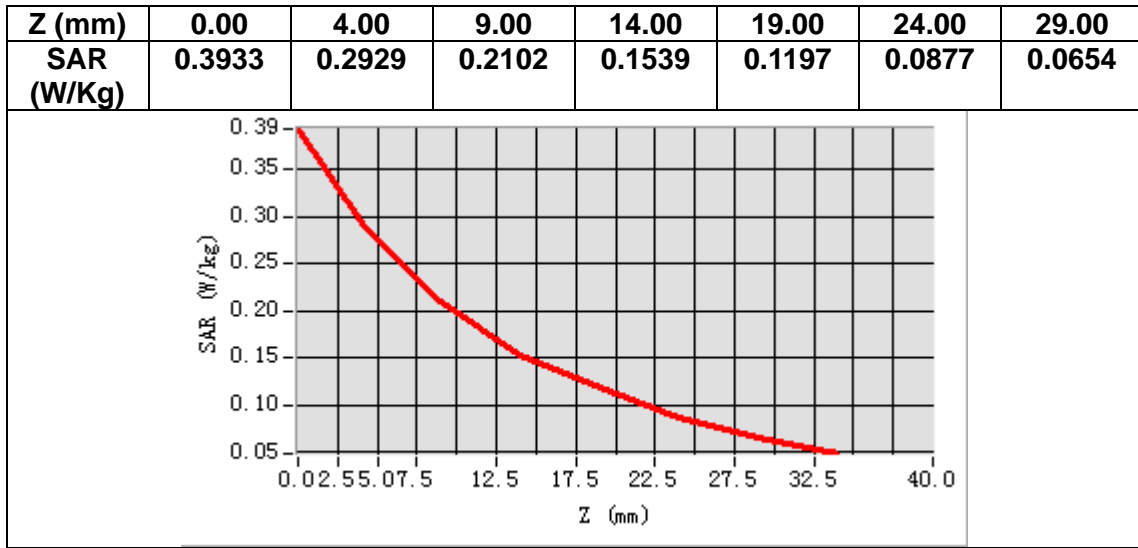

## MEASUREMENT 2

Date of measurement: 14/3/2023

### A. Experimental conditions.

<b>Area Scan</b>	<u>dx=15mm dy=15mm, h= 5.00 mm</u>
<b>ZoomScan</b>	<u>5x5x7, dx=8mm dy=8mm dz=5mm</u>
<b>Phantom</b>	<u>Validation plane</u>
<b>Device Position</b>	<u>Body</u>
<b>Band</b>	<u>GSM850</u>
<b>Channels</b>	<u>Middle</u>
<b>Signal</b>	<u>TDMA (Crest factor: 4.0)</u>
<b>ConvF</b>	<u>1.50</u>

### B. SAR Measurement Results

<b>Frequency (MHz)</b>	836.400000
<b>Relative permittivity (real part)</b>	41.209236
<b>Relative permittivity (imaginary part)</b>	19.945681
<b>Conductivity (S/m)</b>	0.926809
<b>Variation (%)</b>	-0.040000

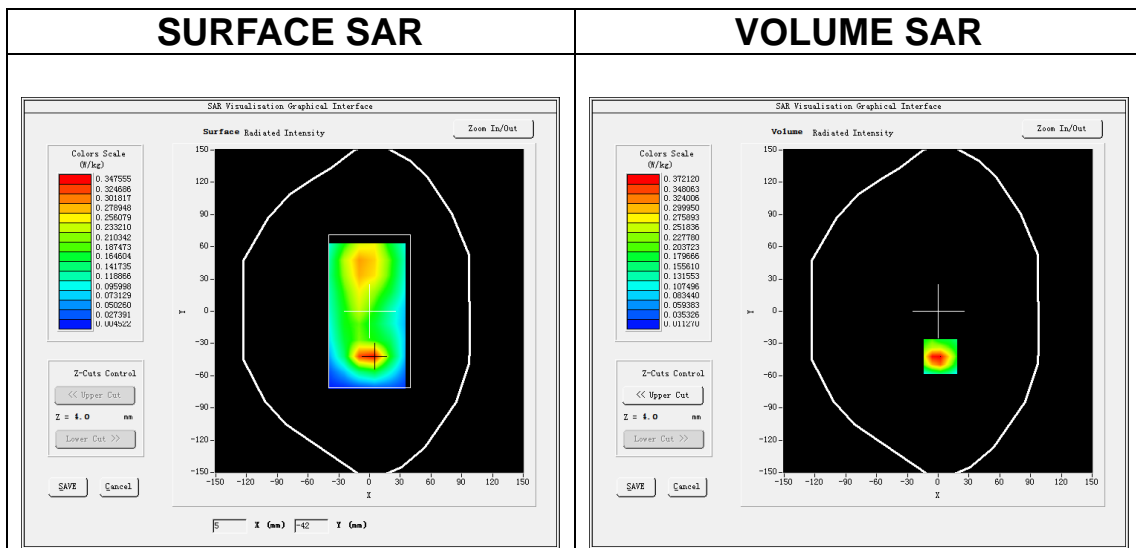

**Maximum location: X=2.00, Y=-42.00**  
**SAR Peak: 0.65 W/kg**

<b>SAR 10g (W/Kg)</b>	0.188649
<b>SAR 1g (W/Kg)</b>	0.377588

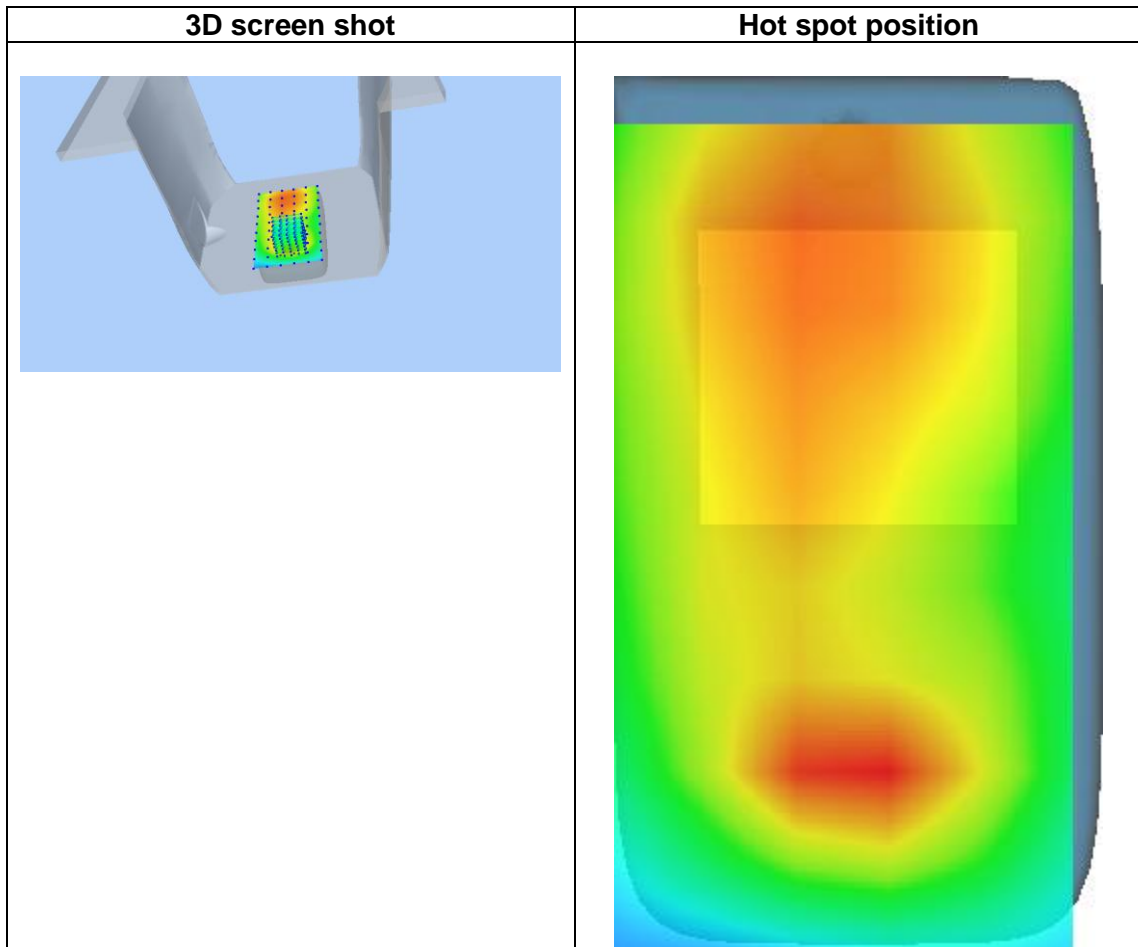
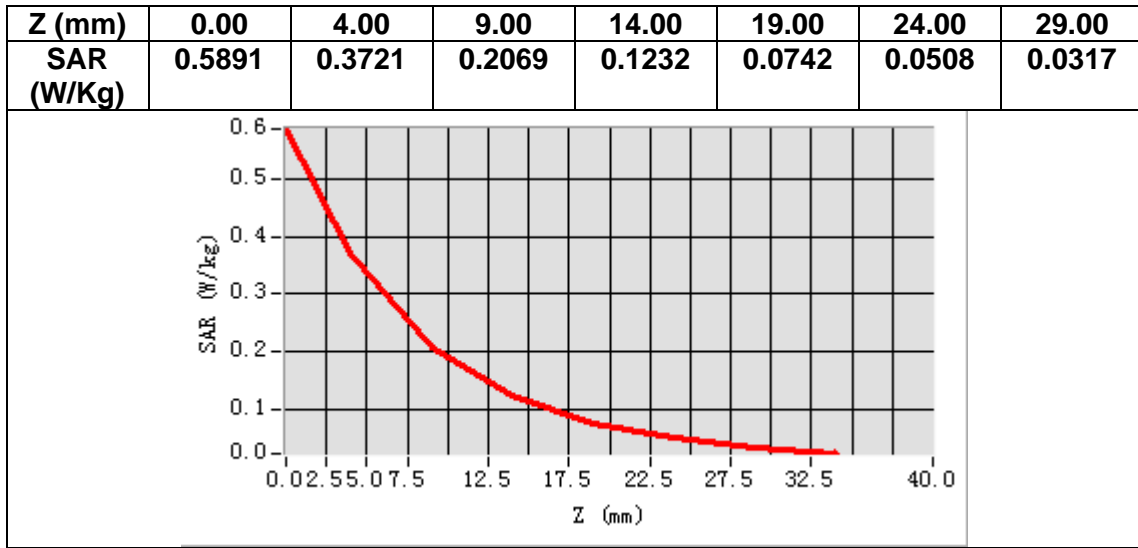

# MEASUREMENT 3

Date of measurement: 13/3/2023

## A. Experimental conditions.

<u>Area Scan</u>	<u>dx=15mm dy=15mm, h= 5.00 mm</u>
<u>ZoomScan</u>	<u>5x5x7, dx=8mm dy=8mm dz=5mm</u>
<u>Phantom</u>	<u>Left head</u>
<u>Device Position</u>	<u>Cheek</u>
<u>Band</u>	<u>GSM1900</u>
<u>Channels</u>	<u>Middle</u>
<u>Signal</u>	<u>TDMA (Crest factor: 4.0)</u>
<u>ConvF</u>	<u>1.91</u>

## B. SAR Measurement Results

<b>Frequency (MHz)</b>	1880.000000
<b>Relative permittivity (real part)</b>	38.784592
<b>Relative permittivity (imaginary part)</b>	13.447636
<b>Conductivity (S/m)</b>	1.404531
<b>Variation (%)</b>	2.820000

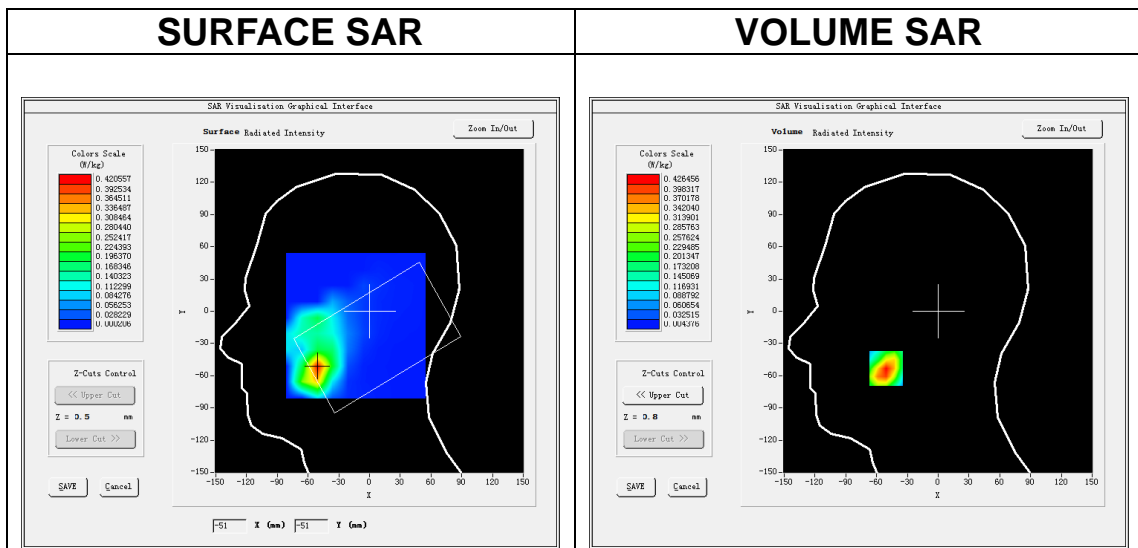

**Maximum location: X=-51.00, Y=-53.00**  
**SAR Peak: 0.66 W/kg**

<b>SAR 10g (W/Kg)</b>	0.212400
<b>SAR 1g (W/Kg)</b>	0.409047

<b>Z (mm)</b>	<b>0.00</b>	<b>4.00</b>	<b>9.00</b>	<b>14.00</b>	<b>19.00</b>	<b>24.00</b>	<b>29.00</b>
<b>SAR (W/Kg)</b>	<b>0.6399</b>	<b>0.4265</b>	<b>0.2523</b>	<b>0.1482</b>	<b>0.0890</b>	<b>0.0522</b>	<b>0.0305</b>

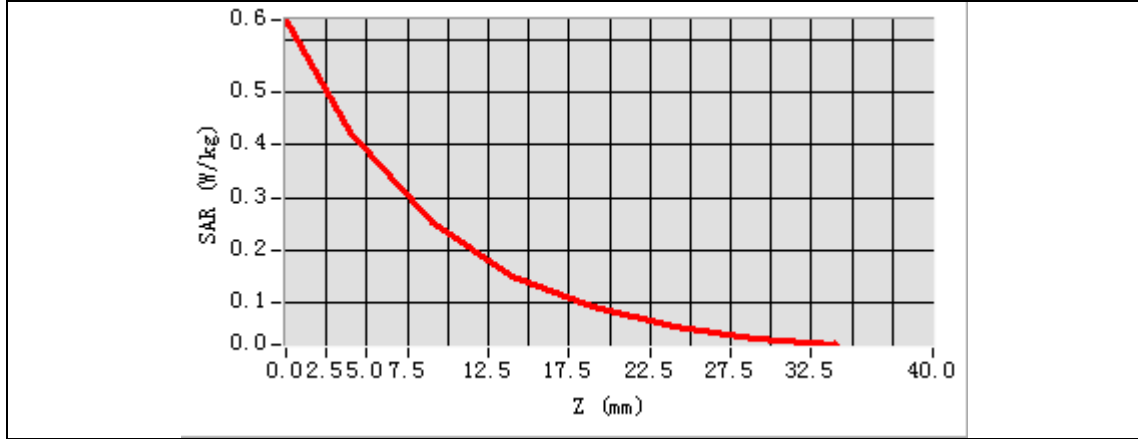

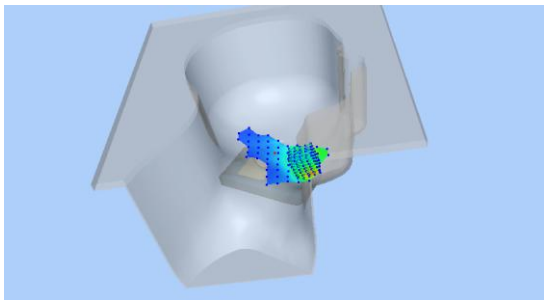
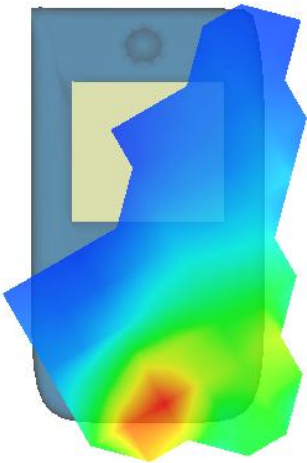
3D screen shot	Hot spot position
	

# MEASUREMENT 4

Date of measurement: 13/3/2023

## A. Experimental conditions.

<b>Area Scan</b>	<u>dx=15mm dy=15mm, h= 5.00 mm</u>
<b>ZoomScan</b>	<u>5x5x7, dx=8mm dy=8mm dz=5mm</u>
<b>Phantom</b>	<u>Validation plane</u>
<b>Device Position</b>	<u>Body</u>
<b>Band</b>	<u>GSM1900</u>
<b>Channels</b>	<u>Middle</u>
<b>Signal</b>	<u>TDMA (Crest factor: 4.0)</u>
<b>ConvF</b>	<u>1.91</u>

## B. SAR Measurement Results

<b>Frequency (MHz)</b>	1880.000000
<b>Relative permittivity (real part)</b>	38.784592
<b>Relative permittivity (imaginary part)</b>	13.447636
<b>Conductivity (S/m)</b>	1.404531
<b>Variation (%)</b>	-1.800000

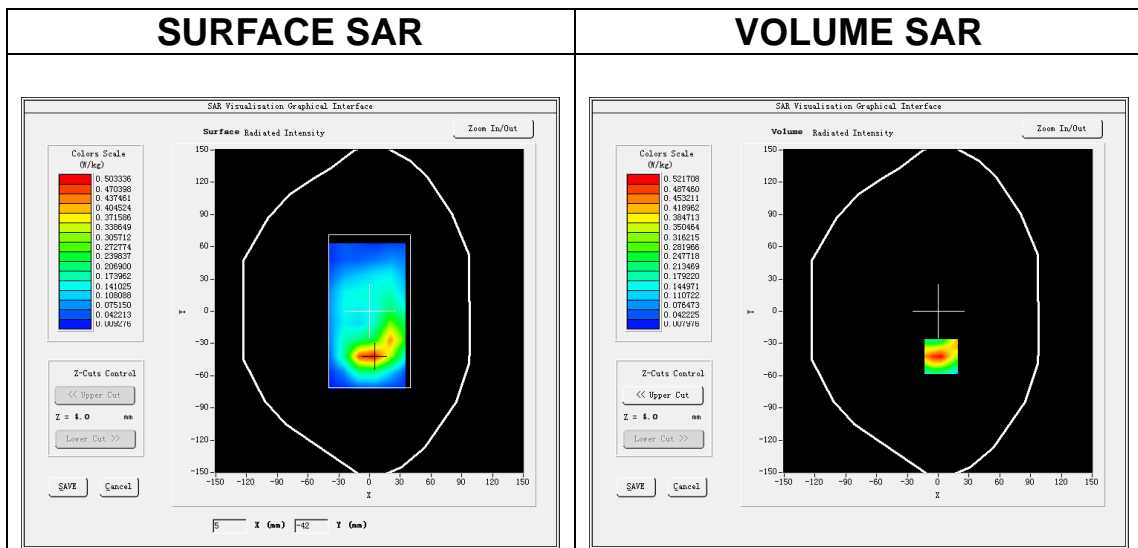

**Maximum location: X=3.00, Y=-42.00**  
**SAR Peak: 0.87 W/kg**

<b>SAR 10g (W/Kg)</b>	0.244168
<b>SAR 1g (W/Kg)</b>	0.492097



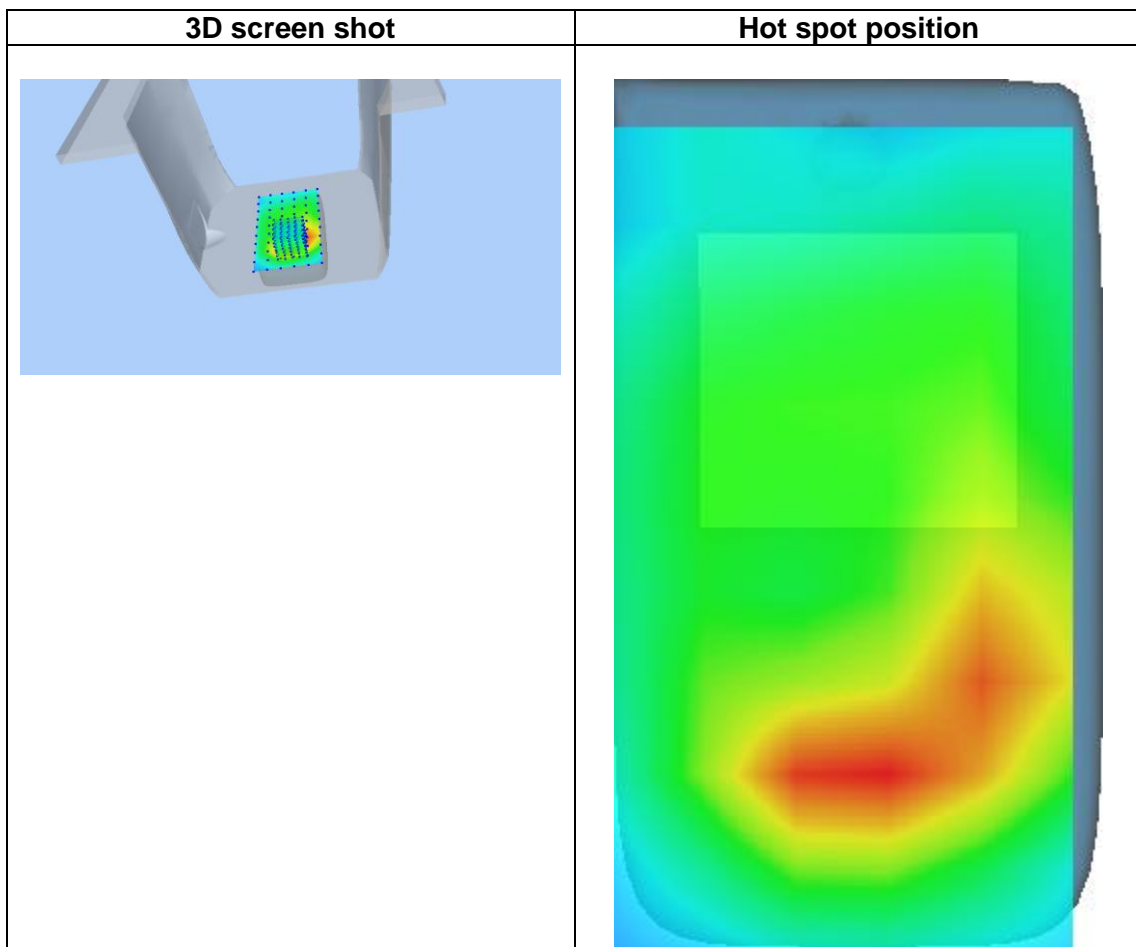
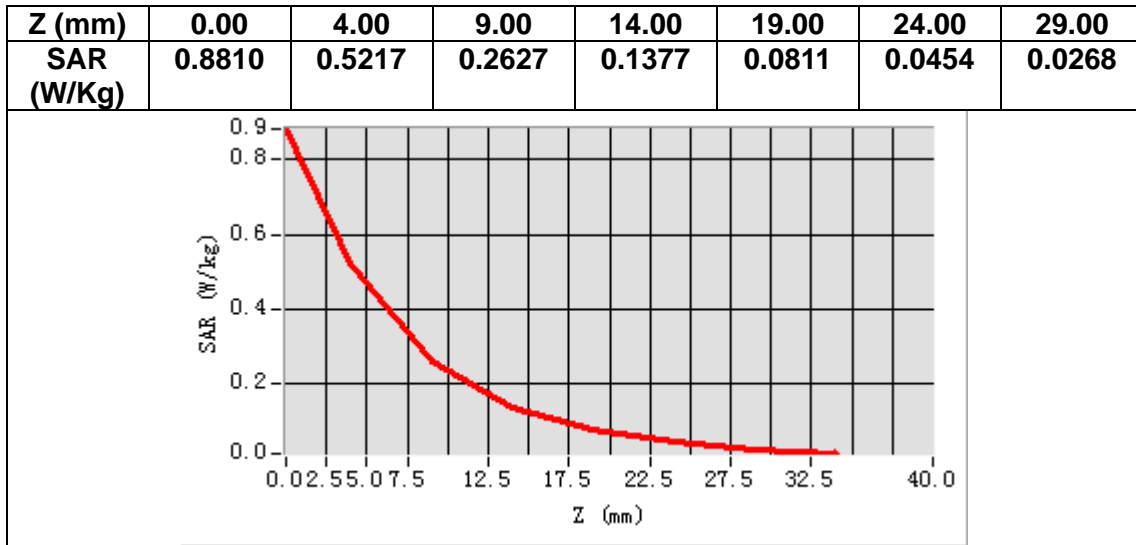

# MEASUREMENT 5

Date of measurement: 13/3/2023

## A. Experimental conditions.

<b>Area Scan</b>	<u>dx=15mm dy=15mm, h= 5.00 mm</u>
<b>ZoomScan</b>	<u>5x5x7, dx=8mm dy=8mm dz=5mm</u>
<b>Phantom</b>	<u>Left head</u>
<b>Device Position</b>	<u>Cheek</u>
<b>Band</b>	<u>Band2_WCDMA1900</u>
<b>Channels</b>	<u>Middle</u>
<b>Signal</b>	<u>WCDMA (Crest factor: 1.0)</u>
<b>ConvF</b>	<u>1.91</u>

## B. SAR Measurement Results

<b>Frequency (MHz)</b>	1880.000000
<b>Relative permittivity (real part)</b>	38.784592
<b>Relative permittivity (imaginary part)</b>	13.447636
<b>Conductivity (S/m)</b>	1.404531
<b>Variation (%)</b>	0.690000

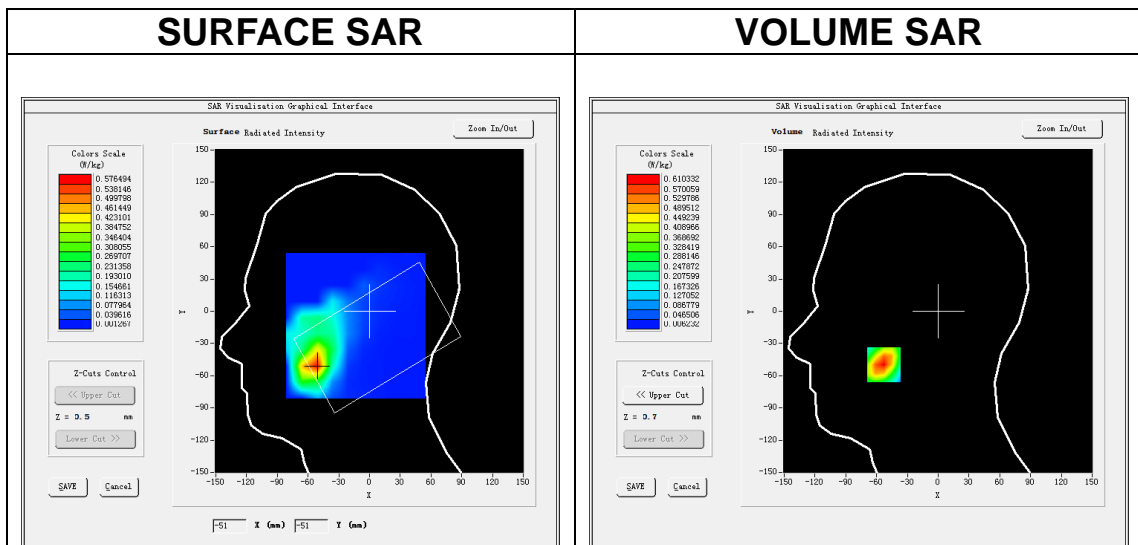

**Maximum location: X=-53.00, Y=-50.00**  
**SAR Peak: 0.92 W/kg**

<b>SAR 10g (W/Kg)</b>	0.314788
<b>SAR 1g (W/Kg)</b>	0.582834

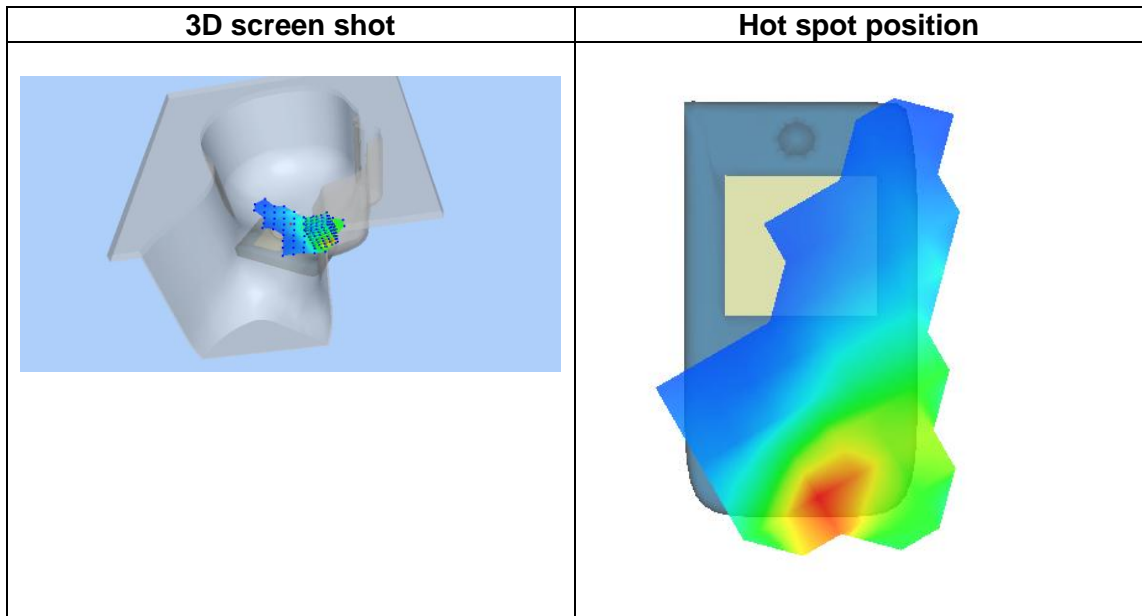
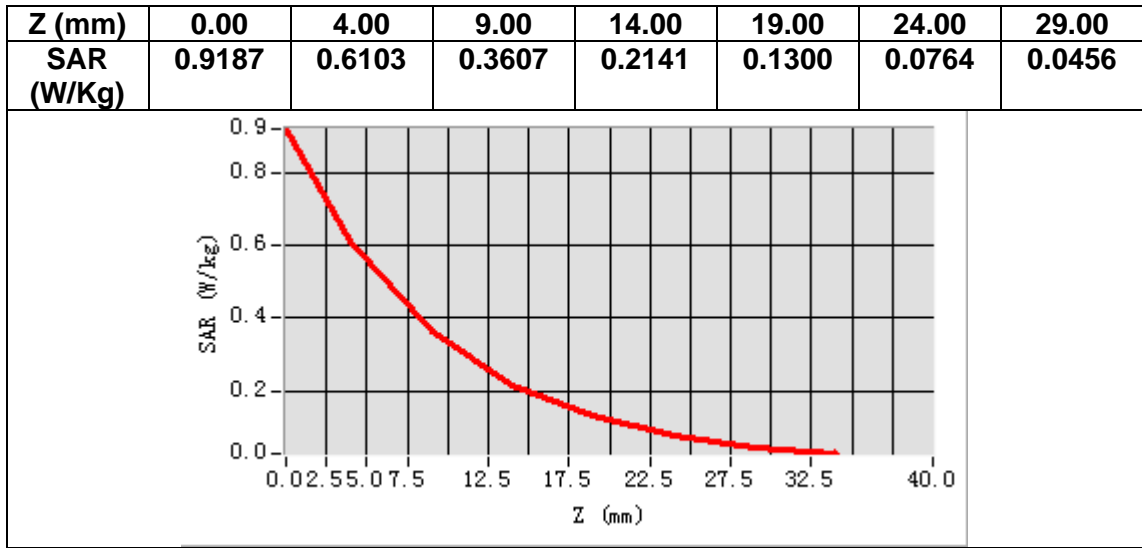

# MEASUREMENT 6

Date of measurement: 13/3/2023

## A. Experimental conditions.

<u>Area Scan</u>	<u>dx=15mm dy=15mm, h= 5.00 mm</u>
<u>ZoomScan</u>	<u>5x5x7, dx=8mm dy=8mm dz=5mm</u>
<u>Phantom</u>	<u>Validation plane</u>
<u>Device Position</u>	<u>Body</u>
<u>Band</u>	<u>Band2_WCDMA1900</u>
<u>Channels</u>	<u>Middle</u>
<u>Signal</u>	<u>WCDMA (Crest factor: 1.0)</u>
<u>ConvF</u>	<u>1.91</u>

## B. SAR Measurement Results

<b>Frequency (MHz)</b>	1880.000000
<b>Relative permittivity (real part)</b>	38.784592
<b>Relative permittivity (imaginary part)</b>	13.447636
<b>Conductivity (S/m)</b>	1.404531
<b>Variation (%)</b>	0.800000

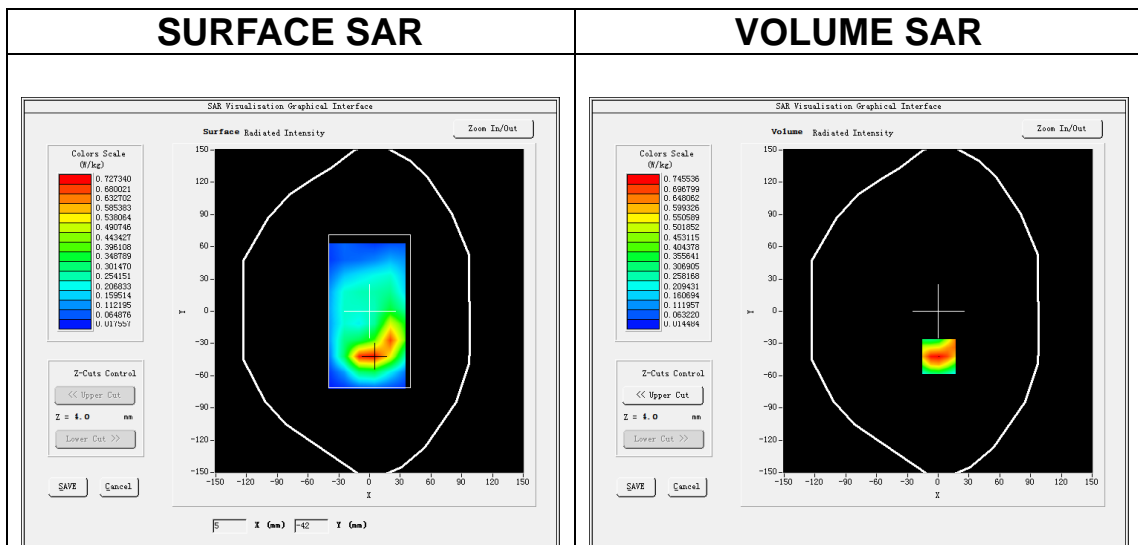

**Maximum location: X=1.00, Y=-42.00**  
**SAR Peak: 1.17 W/kg**

<b>SAR 10g (W/Kg)</b>	0.379179
<b>SAR 1g (W/Kg)</b>	0.715552

<b>Z (mm)</b>	<b>0.00</b>	<b>4.00</b>	<b>9.00</b>	<b>14.00</b>	<b>19.00</b>	<b>24.00</b>	<b>29.00</b>
<b>SAR (W/Kg)</b>	<b>1.1492</b>	<b>0.7455</b>	<b>0.4235</b>	<b>0.2435</b>	<b>0.1403</b>	<b>0.0818</b>	<b>0.0476</b>

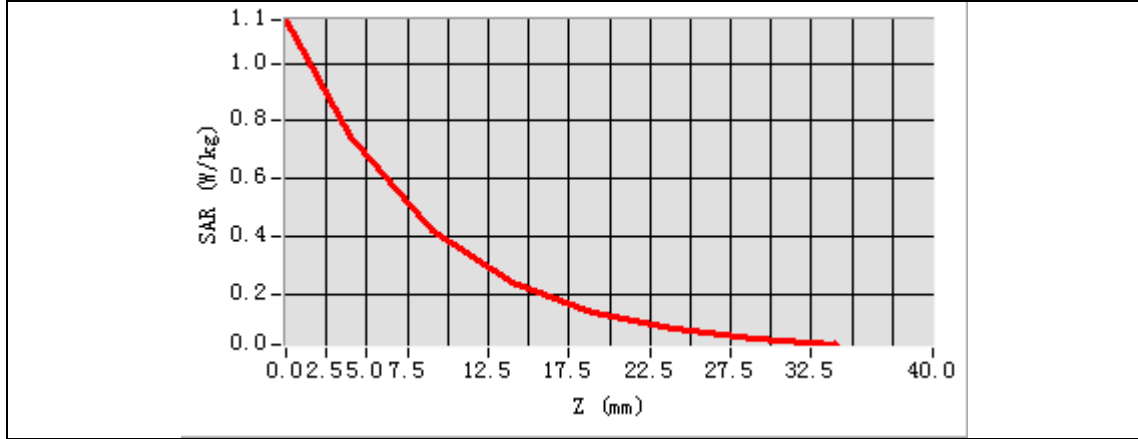

3D screen shot	Hot spot position

# MEASUREMENT 7

Date of measurement: 6/3/2023

## A. Experimental conditions.

<u>Area Scan</u>	<u>dx=15mm dy=15mm, h= 5.00 mm</u>
<u>ZoomScan</u>	<u>5x5x7, dx=8mm dy=8mm dz=5mm</u>
<u>Phantom</u>	<u>Left head</u>
<u>Device Position</u>	<u>Cheek</u>
<u>Band</u>	<u>Band4_WCDMA1700</u>
<u>Channels</u>	<u>Middle</u>
<u>Signal</u>	<u>WCDMA (Crest factor: 1.0)</u>
<u>ConvF</u>	<u>1.73</u>

## B. SAR Measurement Results

<b>Frequency (MHz)</b>	1732.600000
<b>Relative permittivity (real part)</b>	39.421825
<b>Relative permittivity (imaginary part)</b>	13.751579
<b>Conductivity (S/m)</b>	1.323207
<b>Variation (%)</b>	0.530000

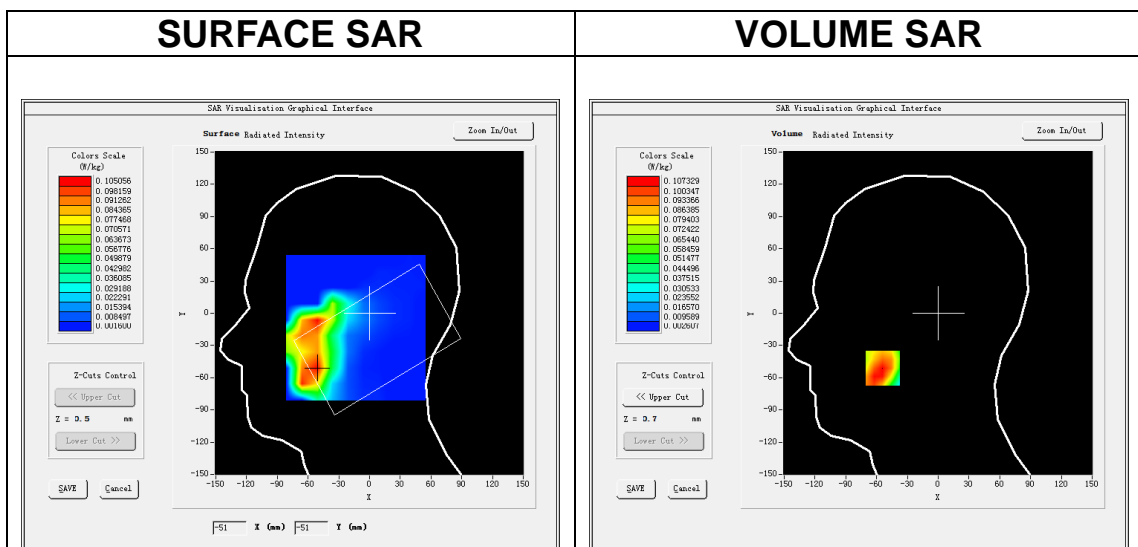

**Maximum location: X=-54.00, Y=-51.00**  
**SAR Peak: 0.15 W/kg**

<b>SAR 10g (W/Kg)</b>	0.064024
<b>SAR 1g (W/Kg)</b>	0.104430

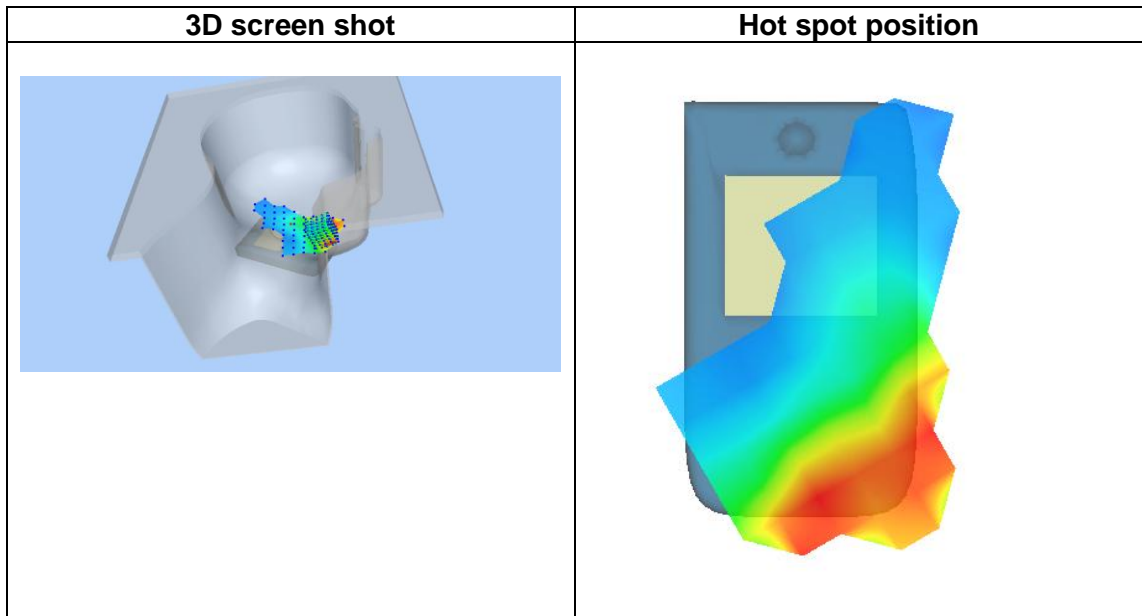
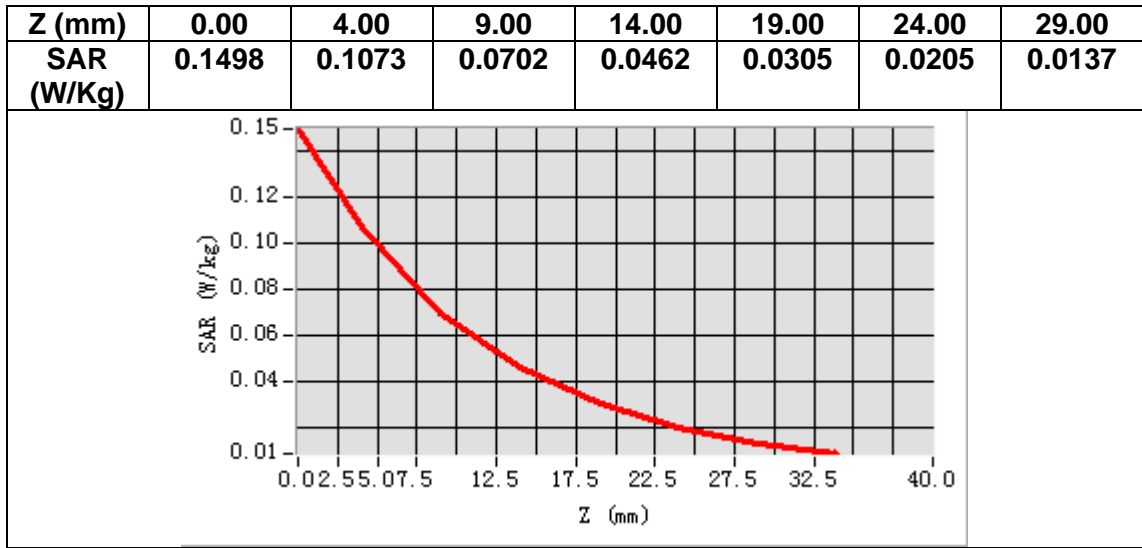

# MEASUREMENT 8

Date of measurement: 6/3/2023

## A. Experimental conditions.

<b>Area Scan</b>	<u>dx=15mm dy=15mm, h= 5.00 mm</u>
<b>ZoomScan</b>	<u>5x5x7, dx=8mm dy=8mm dz=5mm</u>
<b>Phantom</b>	<u>Validation plane</u>
<b>Device Position</b>	<u>Body</u>
<b>Band</b>	<u>Band4_WCDMA1700</u>
<b>Channels</b>	<u>Middle</u>
<b>Signal</b>	<u>WCDMA (Crest factor: 1.0)</u>
<b>ConvF</b>	<u>1.73</u>

## B. SAR Measurement Results

<b>Frequency (MHz)</b>	1732.600000
<b>Relative permittivity (real part)</b>	39.421825
<b>Relative permittivity (imaginary part)</b>	13.751579
<b>Conductivity (S/m)</b>	1.323207
<b>Variation (%)</b>	0.010000

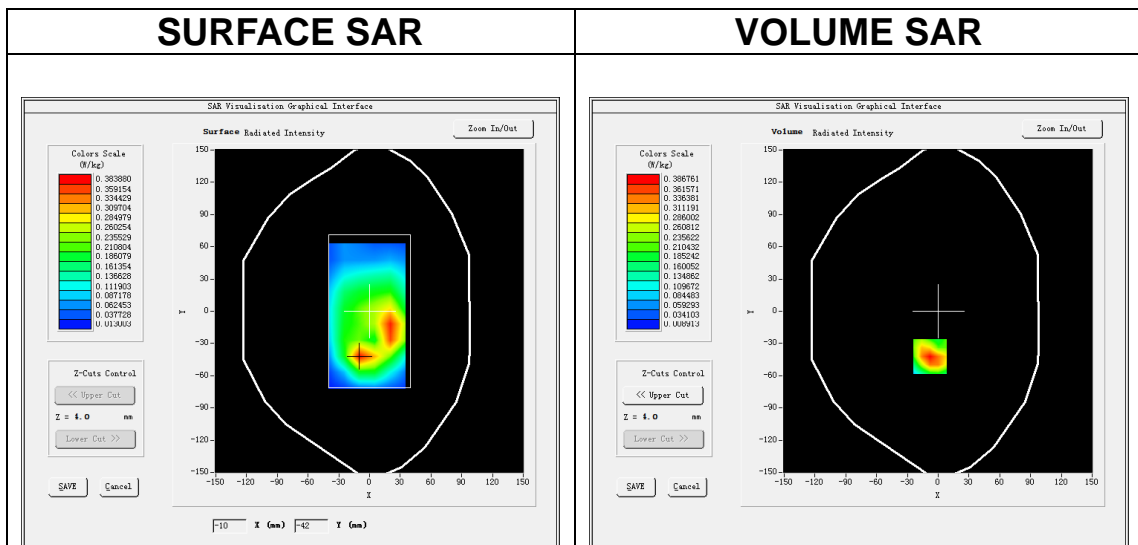

**Maximum location: X=-8.00, Y=-42.00**  
**SAR Peak: 0.60 W/kg**

<b>SAR 10g (W/Kg)</b>	0.196734
<b>SAR 1g (W/Kg)</b>	0.365688



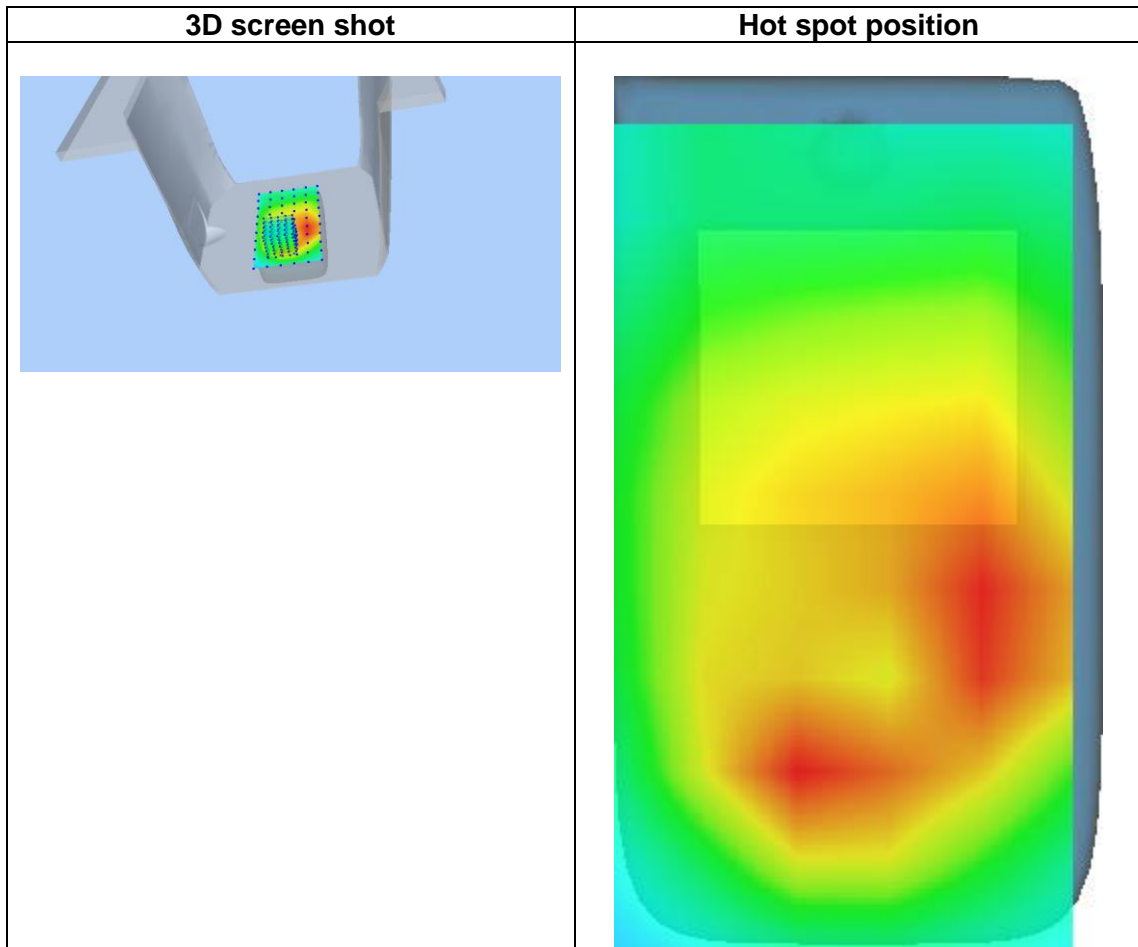
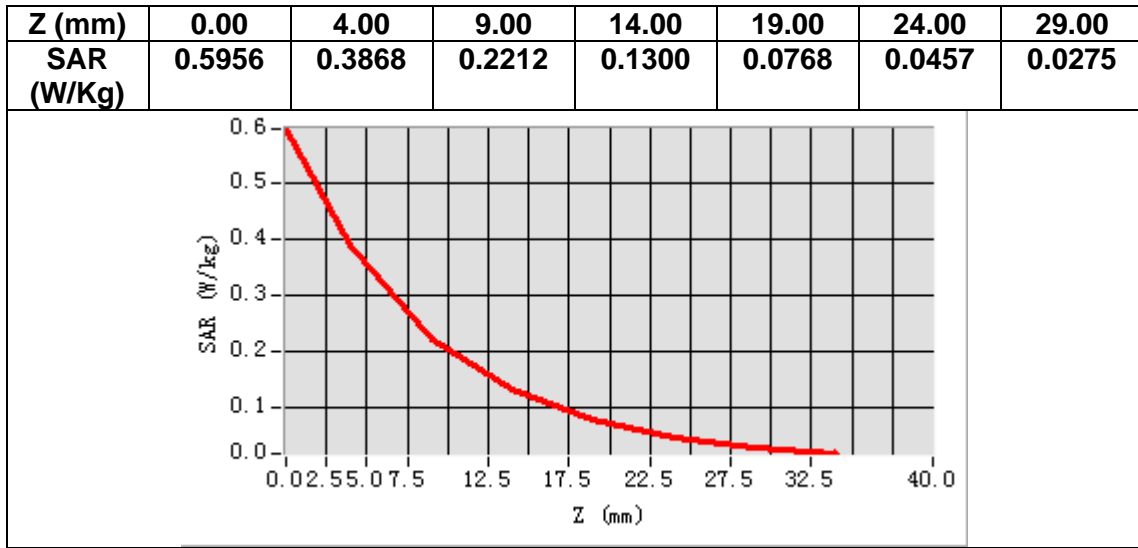

# MEASUREMENT 9

Date of measurement: 14/3/2023

## A. Experimental conditions.

<b>Area Scan</b>	<u>dx=15mm dy=15mm, h= 5.00 mm</u>
<b>ZoomScan</b>	<u>5x5x7, dx=8mm dy=8mm dz=5mm</u>
<b>Phantom</b>	<u>Left head</u>
<b>Device Position</b>	<u>Cheek</u>
<b>Band</b>	<u>Band5_WCDMA850</u>
<b>Channels</b>	<u>Middle</u>
<b>Signal</b>	<u>WCDMA (Crest factor: 1.0)</u>
<b>ConvF</b>	<u>1.50</u>

## B. SAR Measurement Results

<b>Frequency (MHz)</b>	836.400000
<b>Relative permittivity (real part)</b>	41.209236
<b>Relative permittivity (imaginary part)</b>	19.945681
<b>Conductivity (S/m)</b>	0.926809
<b>Variation (%)</b>	-0.980000

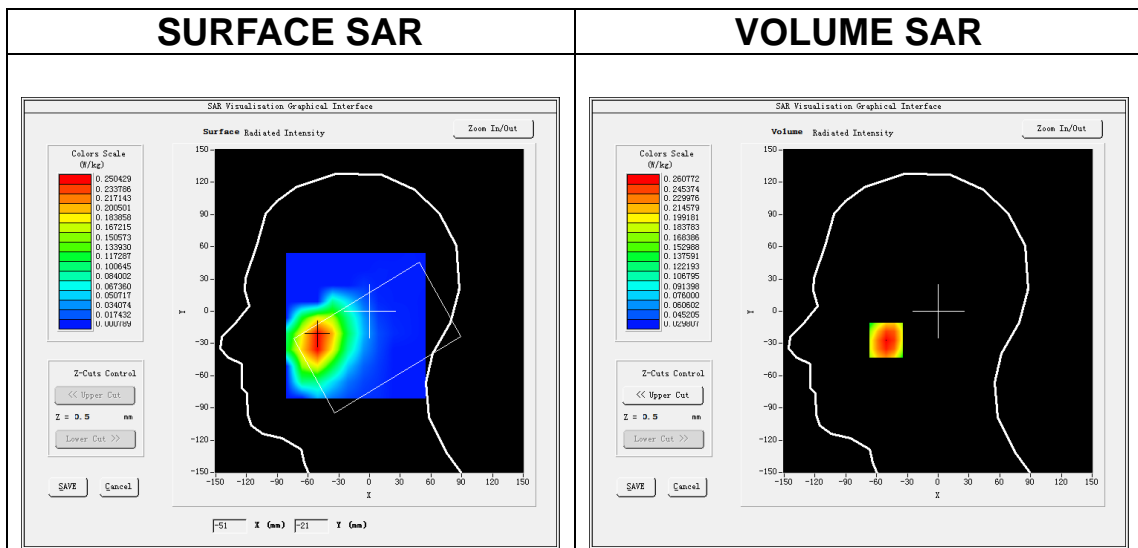

**Maximum location: X=-51.00, Y=-27.00**  
**SAR Peak: 0.32 W/kg**

<b>SAR 10g (W/Kg)</b>	0.188396
<b>SAR 1g (W/Kg)</b>	0.258433

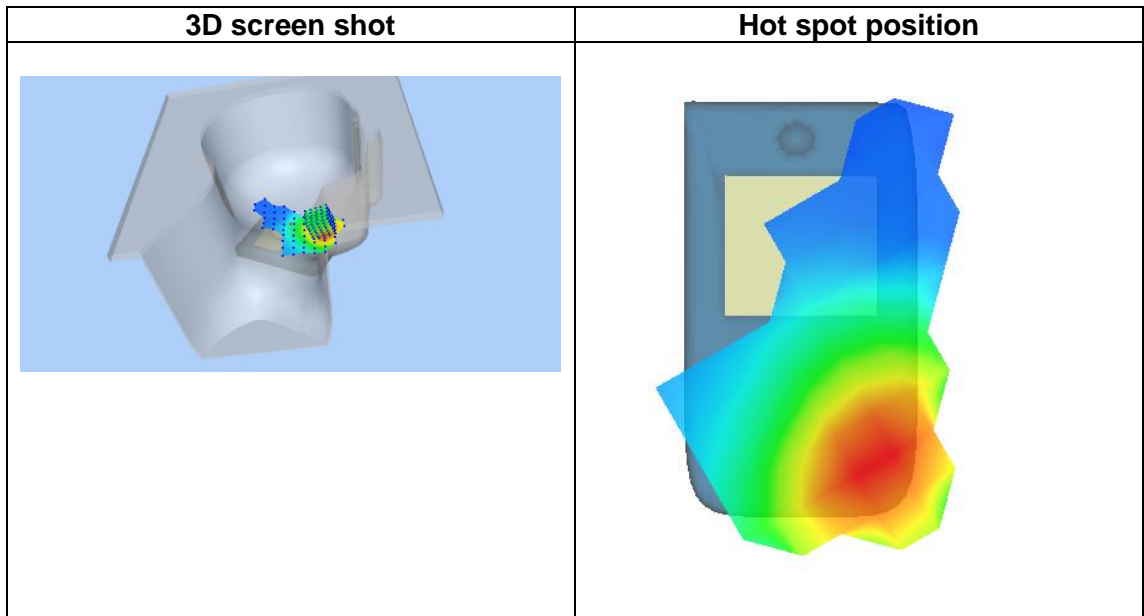
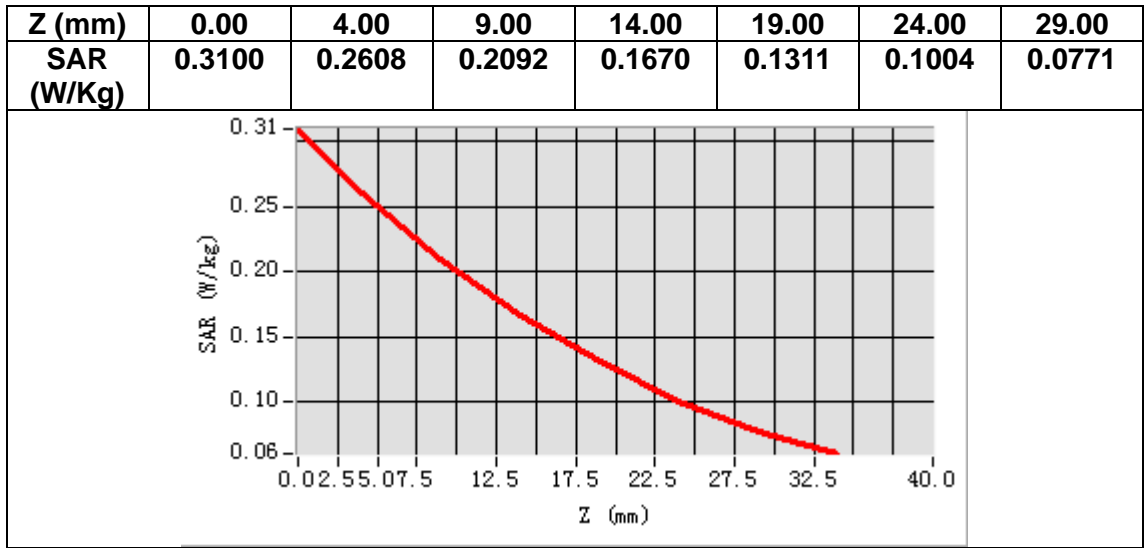

# MEASUREMENT 10

Date of measurement: 14/3/2023

## A. Experimental conditions.

<u>Area Scan</u>	<u>dx=15mm dy=15mm, h= 5.00 mm</u>
<u>ZoomScan</u>	<u>5x5x7, dx=8mm dy=8mm dz=5mm</u>
<u>Phantom</u>	<u>Validation plane</u>
<u>Device Position</u>	<u>Body</u>
<u>Band</u>	<u>Band5_WCDMA850</u>
<u>Channels</u>	<u>Middle</u>
<u>Signal</u>	<u>WCDMA (Crest factor: 1.0)</u>
<u>ConvF</u>	<u>1.50</u>

## B. SAR Measurement Results

<b>Frequency (MHz)</b>	836.400000
<b>Relative permittivity (real part)</b>	41.209236
<b>Relative permittivity (imaginary part)</b>	19.945681
<b>Conductivity (S/m)</b>	0.926809
<b>Variation (%)</b>	-0.950000

### SURFACE SAR

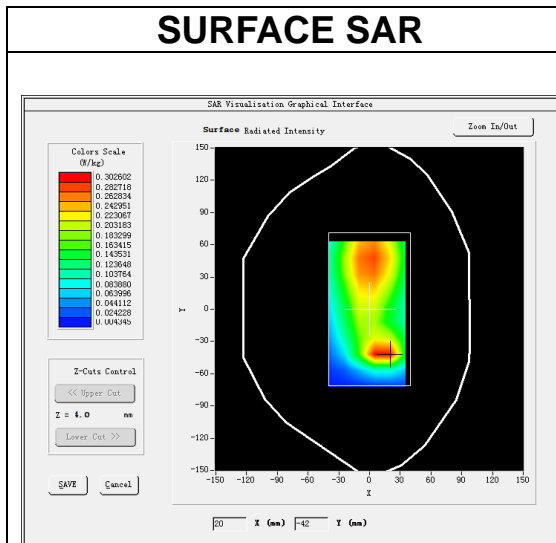

### VOLUME SAR

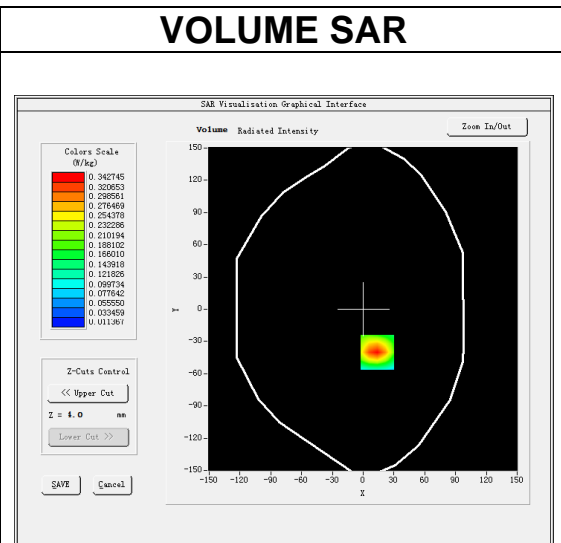

Maximum location: X=14.00, Y=-40.00

SAR Peak: 0.52 W/kg

<b>SAR 10g (W/Kg)</b>	0.182572
<b>SAR 1g (W/Kg)</b>	0.328534

<b>Z (mm)</b>	<b>0.00</b>	<b>4.00</b>	<b>9.00</b>	<b>14.00</b>	<b>19.00</b>	<b>24.00</b>	<b>29.00</b>
<b>SAR (W/Kg)</b>	<b>0.5172</b>	<b>0.3427</b>	<b>0.2042</b>	<b>0.1277</b>	<b>0.0811</b>	<b>0.0525</b>	<b>0.0344</b>

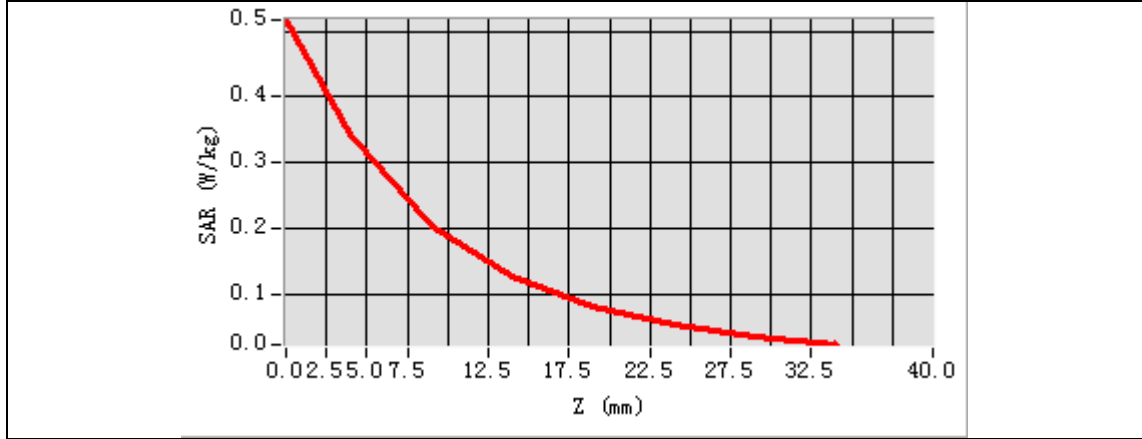

3D screen shot	Hot spot position

# MEASUREMENT 11

Date of measurement: 8/3/2023

## A. Experimental conditions.

<b>Area Scan</b>	<u>dx=12mm dy=12mm, h= 5.00 mm</u>
<b>ZoomScan</b>	<u>7x7x7,dx=5mm dy=5mm dz=5mm</u>
<b>Phantom</b>	<u>Left head</u>
<b>Device Position</b>	<u>Cheek</u>
<b>Band</b>	<u>IEEE 802.11b ISM</u>
<b>Channels</b>	<u>High</u>
<b>Signal</b>	<u>IEEE802.11b (Crest factor: 1.0)</u>
<b>ConvF</b>	<u>1.98</u>

## B. SAR Measurement Results

<b>Frequency (MHz)</b>	2462.000000
<b>Relative permittivity (real part)</b>	38.616497
<b>Relative permittivity (imaginary part)</b>	13.507711
<b>Conductivity (S/m)</b>	1.847554
<b>Variation (%)</b>	-1.100000

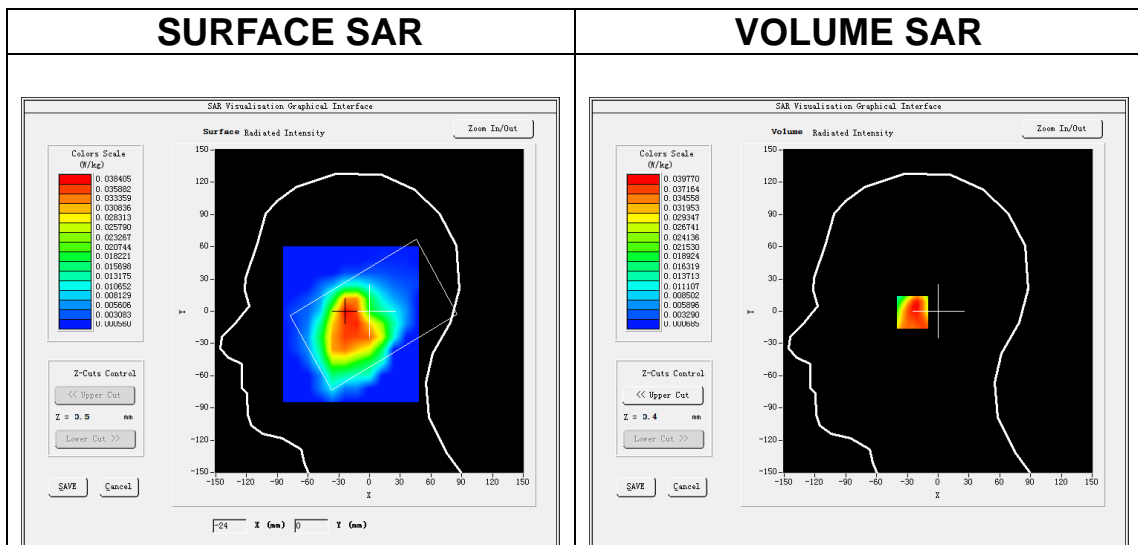

**Maximum location: X=-22.00, Y=-1.00**  
**SAR Peak: 0.06 W/kg**

<b>SAR 10g (W/Kg)</b>	0.021013
<b>SAR 1g (W/Kg)</b>	0.037654

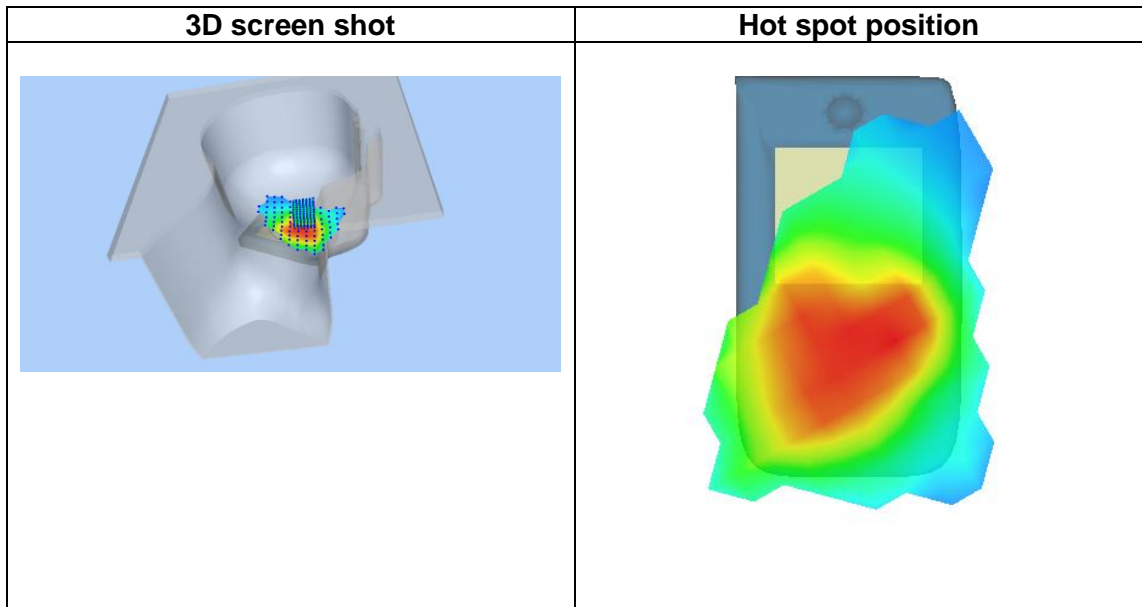
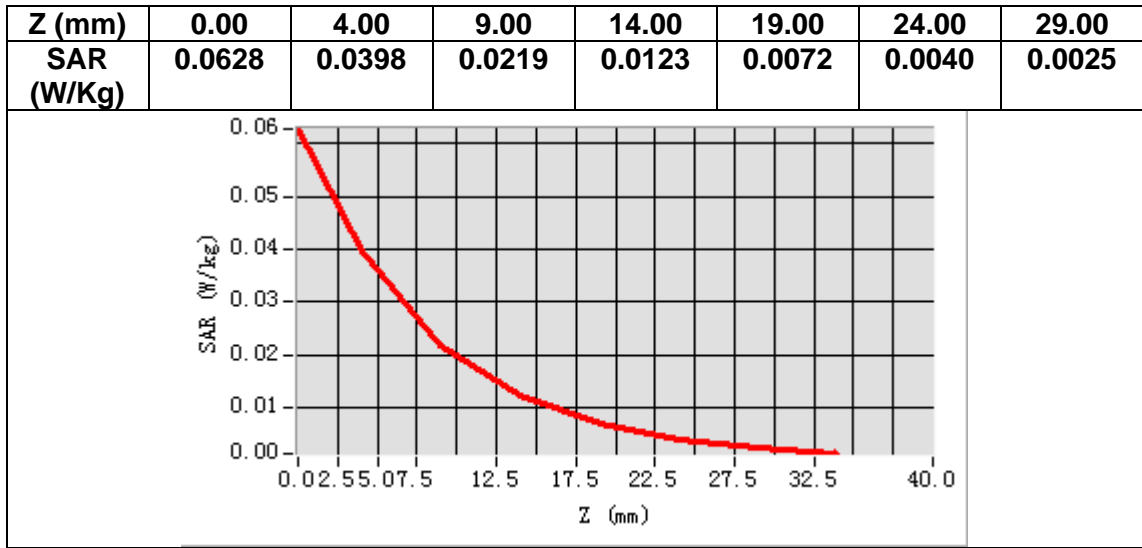

# MEASUREMENT 12

Date of measurement: 8/3/2023

## A. Experimental conditions.

<b>Area Scan</b>	<u>dx=12mm dy=12mm, h= 5.00 mm</u>
<b>ZoomScan</b>	<u>7x7x7, dx=5mm dy=5mm dz=5mm</u>
<b>Phantom</b>	<u>Validation plane</u>
<b>Device Position</b>	<u>Body</u>
<b>Band</b>	<u>IEEE 802.11b ISM</u>
<b>Channels</b>	<u>High</u>
<b>Signal</b>	<u>IEEE802.11b (Crest factor: 1.0)</u>
<b>ConvF</b>	<u>1.98</u>

## B. SAR Measurement Results

<b>Frequency (MHz)</b>	2462.000000
<b>Relative permittivity (real part)</b>	38.616497
<b>Relative permittivity (imaginary part)</b>	13.507711
<b>Conductivity (S/m)</b>	1.847554
<b>Variation (%)</b>	-0.990000

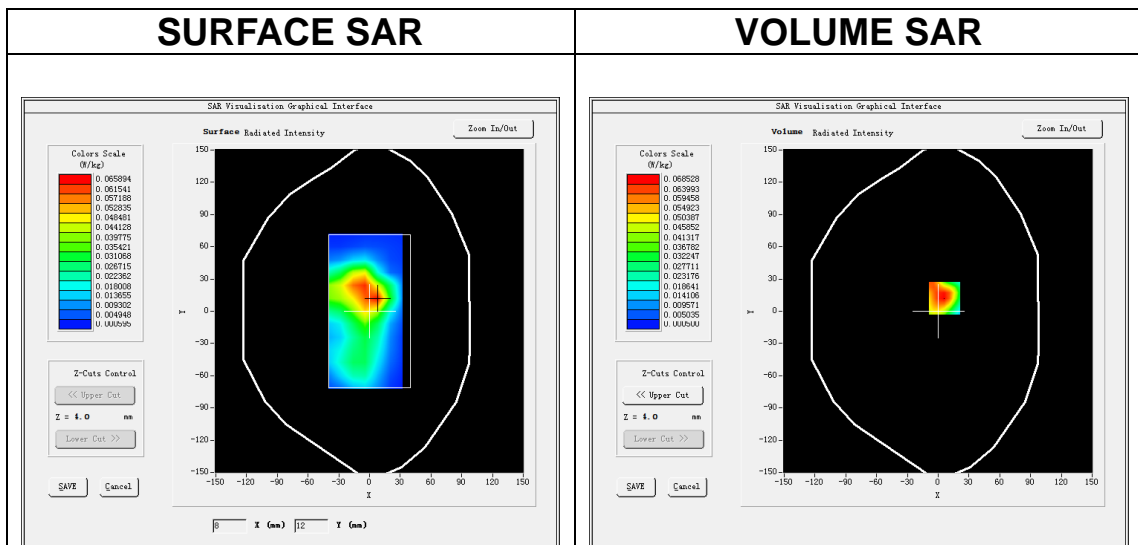

**Maximum location: X=6.00, Y=12.00**

**SAR Peak: 0.12 W/kg**

<b>SAR 10g (W/Kg)</b>	0.032942
<b>SAR 1g (W/Kg)</b>	0.065588



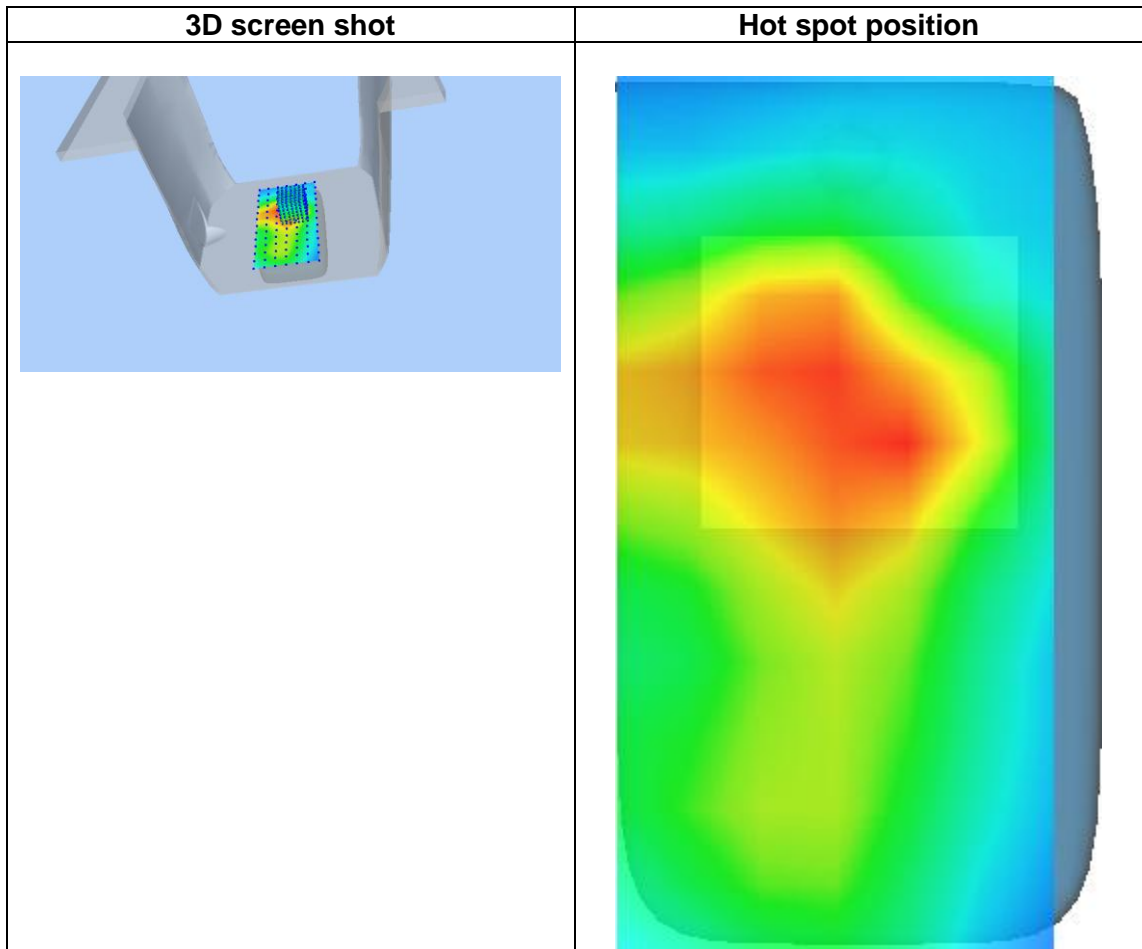
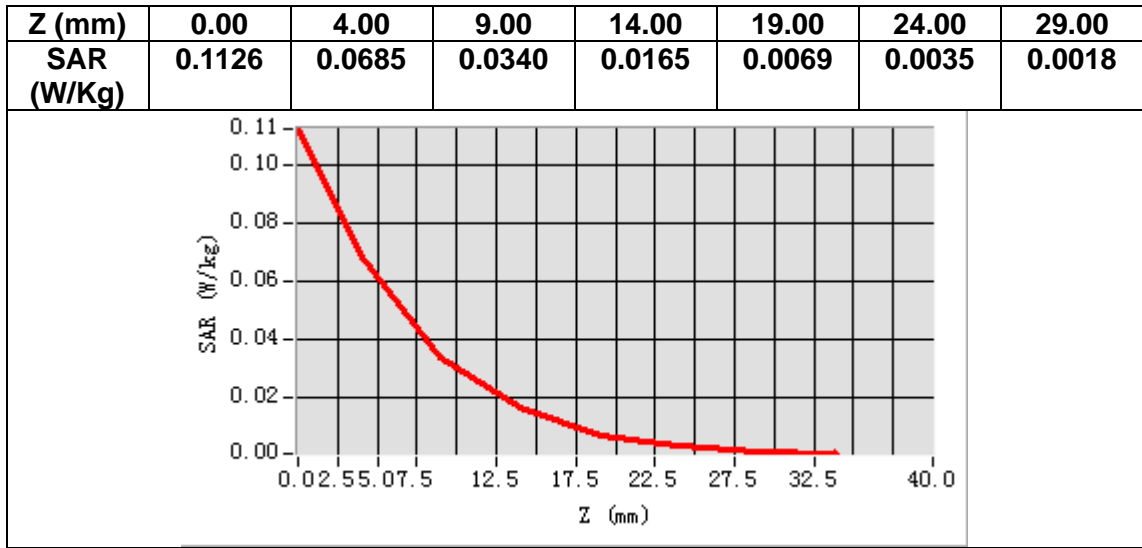

# MEASUREMENT 13

Date of measurement: 13/3/2023

## A. Experimental conditions.

<b>Area Scan</b>	<u>dx=15mm dy=15mm, h= 5.00 mm</u>
<b>ZoomScan</b>	<u>5x5x7, dx=8mm dy=8mm dz=5mm</u>
<b>Phantom</b>	<u>Left head</u>
<b>Device Position</b>	<u>Cheek</u>
<b>Band</b>	<u>LTE band 2</u>
<b>Channels</b>	<u>Middle</u>
<b>Signal</b>	<u>LTE (Crest factor: 1.0)</u>
<b>ConvF</b>	<u>1.91</u>

## B. SAR Measurement Results

<b>Frequency (MHz)</b>	1880.000000
<b>Relative permittivity (real part)</b>	38.784592
<b>Relative permittivity (imaginary part)</b>	13.447636
<b>Conductivity (S/m)</b>	1.404531
<b>Variation (%)</b>	-0.480000

### SURFACE SAR

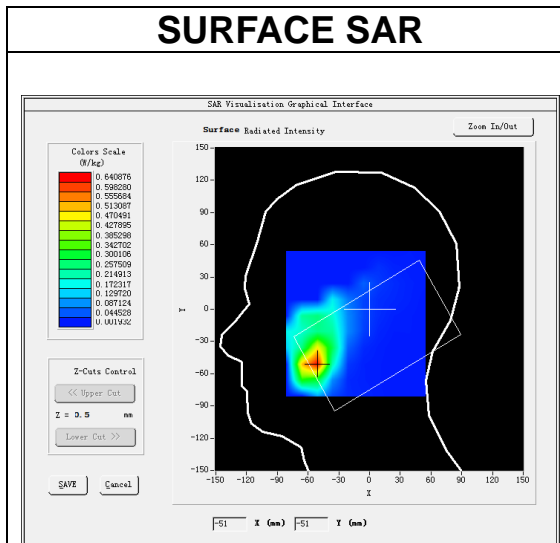

### VOLUME SAR

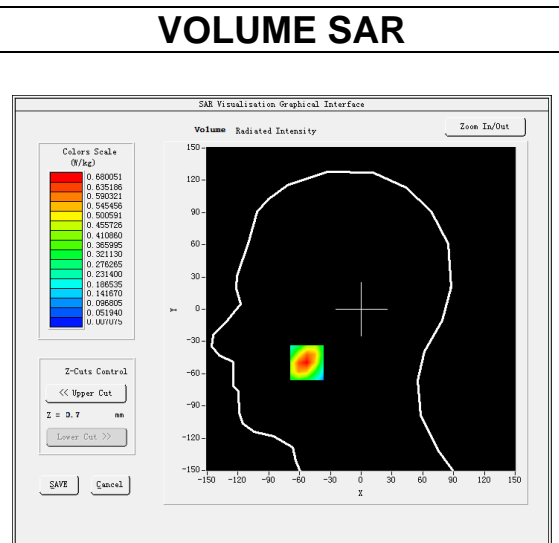

**Maximum location: X=-53.00, Y=-50.00**  
**SAR Peak: 1.01 W/kg**

<b>SAR 10g (W/Kg)</b>	0.353428
<b>SAR 1g (W/Kg)</b>	0.649130

<b>Z (mm)</b>	<b>0.00</b>	<b>4.00</b>	<b>9.00</b>	<b>14.00</b>	<b>19.00</b>	<b>24.00</b>	<b>29.00</b>
<b>SAR (W/Kg)</b>	<b>1.0103</b>	<b>0.6801</b>	<b>0.4076</b>	<b>0.2440</b>	<b>0.1478</b>	<b>0.0873</b>	<b>0.0523</b>

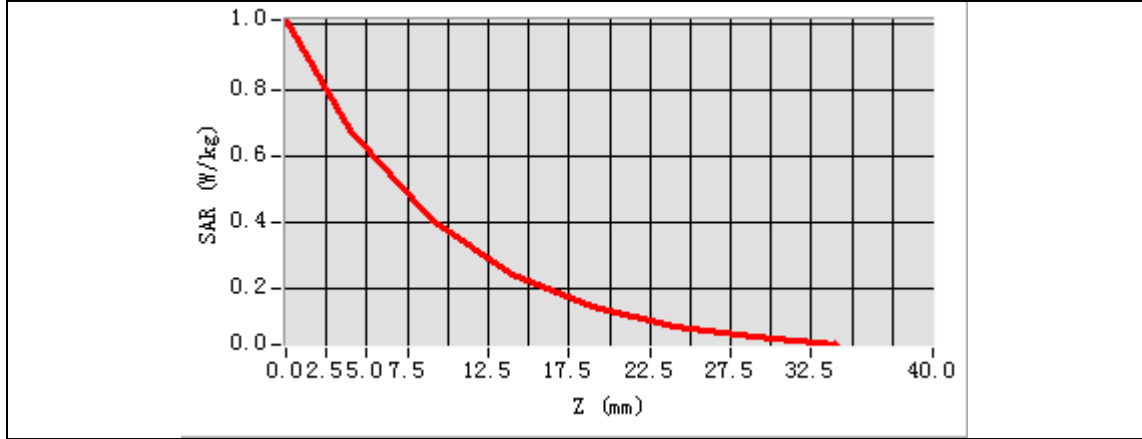

3D screen shot	Hot spot position

# MEASUREMENT 14

Date of measurement: 13/3/2023

## A. Experimental conditions.

<b>Area Scan</b>	<u>dx=15mm dy=15mm, h= 5.00 mm</u>
<b>ZoomScan</b>	<u>5x5x7, dx=8mm dy=8mm dz=5mm</u>
<b>Phantom</b>	<u>Validation plane</u>
<b>Device Position</b>	<u>Body</u>
<b>Band</b>	<u>LTE band 2</u>
<b>Channels</b>	<u>High</u>
<b>Signal</b>	<u>LTE (Crest factor: 1.0)</u>
<b>ConvF</b>	<u>1.91</u>

## B. SAR Measurement Results

<b>Frequency (MHz)</b>	1900.000000
<b>Relative permittivity (real part)</b>	38.698190
<b>Relative permittivity (imaginary part)</b>	13.429836
<b>Conductivity (S/m)</b>	1.417594
<b>Variation (%)</b>	0.370000

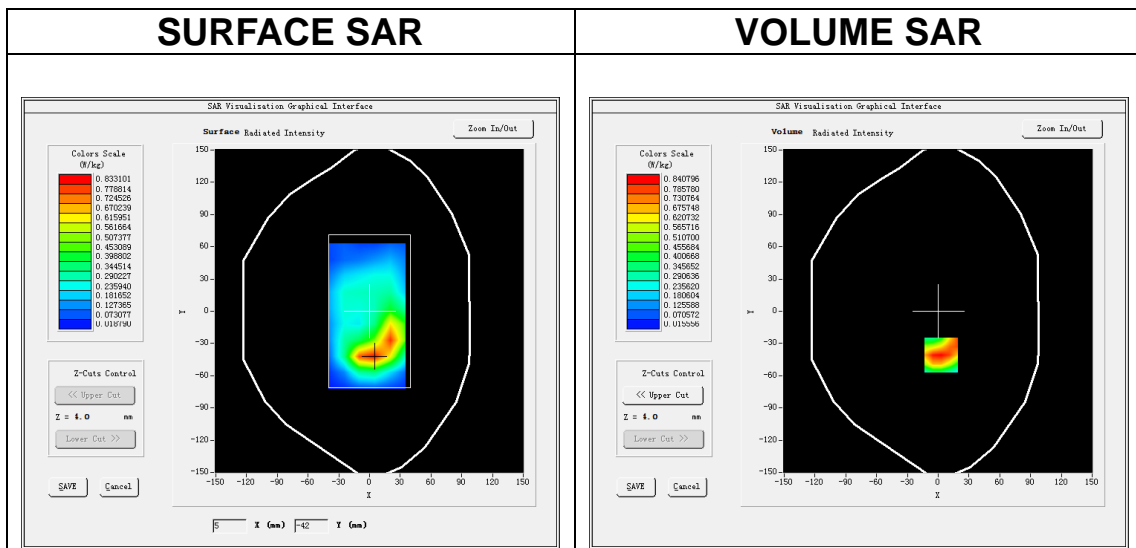

**Maximum location: X=3.00, Y=-41.00**  
**SAR Peak: 1.32 W/kg**

<b>SAR 10g (W/Kg)</b>	0.431091
<b>SAR 1g (W/Kg)</b>	0.811840

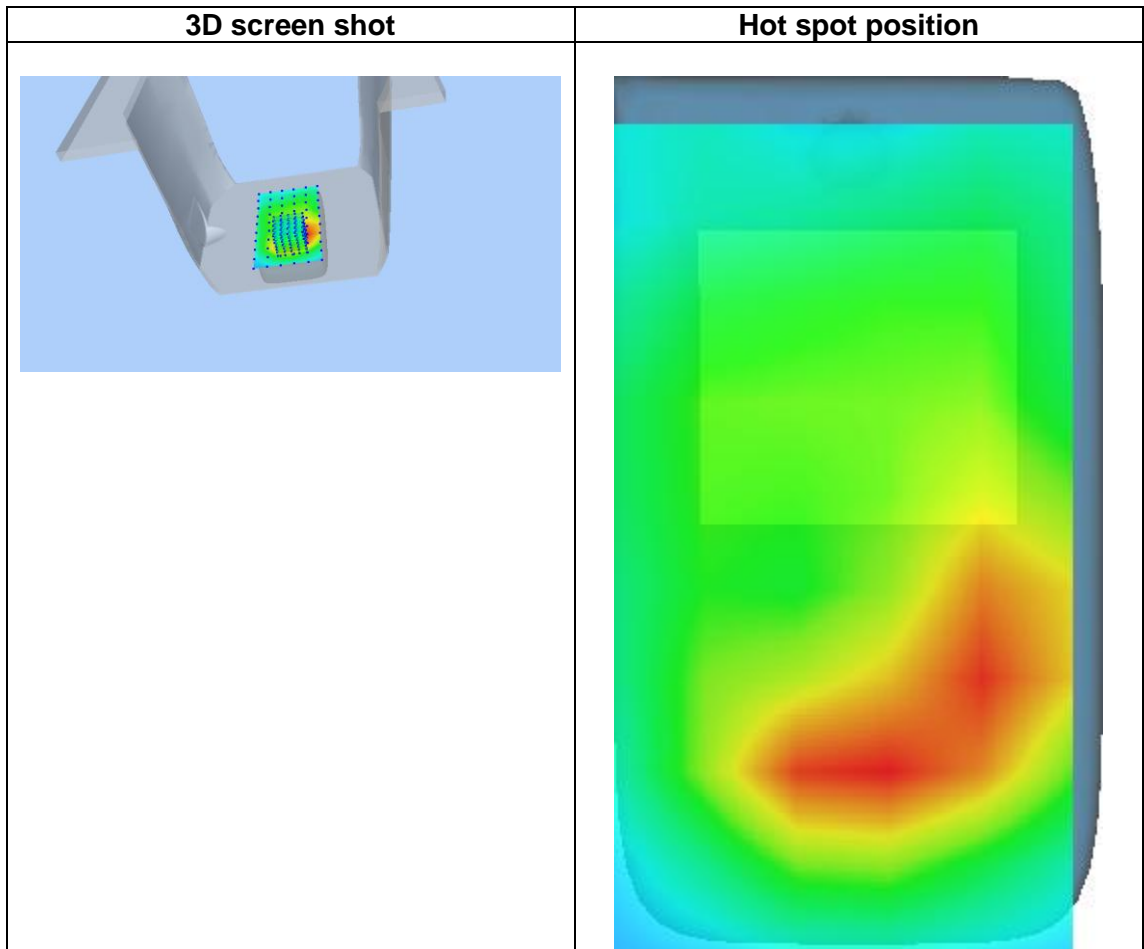
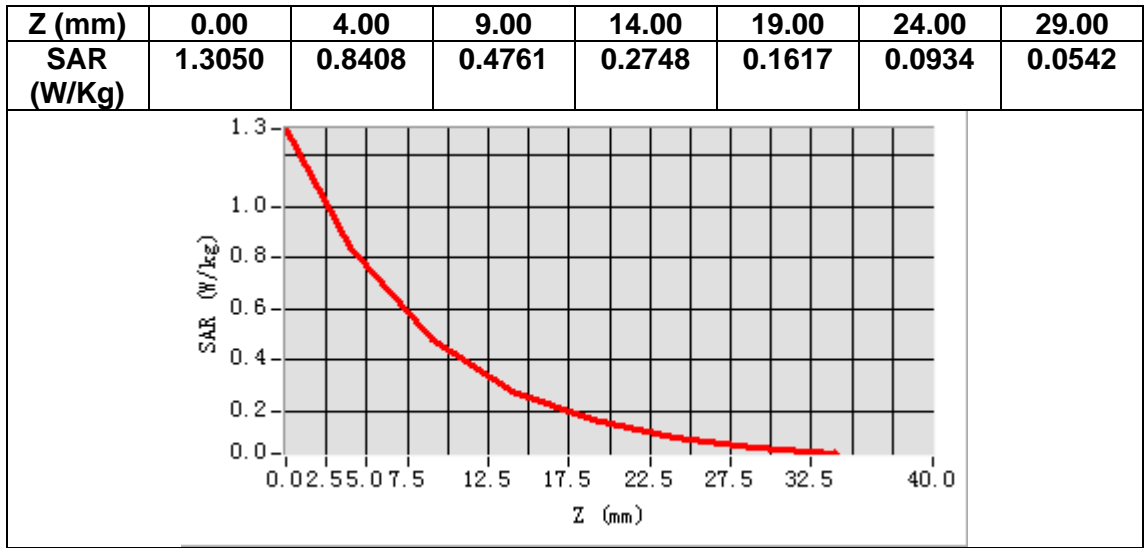

# MEASUREMENT 15

Date of measurement: 6/3/2023

## A. Experimental conditions.

<b>Area Scan</b>	<u>dx=15mm dy=15mm, h= 5.00 mm</u>
<b>ZoomScan</b>	<u>5x5x7, dx=8mm dy=8mm dz=5mm</u>
<b>Phantom</b>	<u>Left head</u>
<b>Device Position</b>	<u>Cheek</u>
<b>Band</b>	<u>LTE band 4</u>
<b>Channels</b>	<u>Middle</u>
<b>Signal</b>	<u>LTE (Crest factor: 1.0)</u>
<b>ConvF</b>	<u>1.73</u>

## B. SAR Measurement Results

<b>Frequency (MHz)</b>	1732.500000
<b>Relative permittivity (real part)</b>	39.429726
<b>Relative permittivity (imaginary part)</b>	13.736429
<b>Conductivity (S/m)</b>	1.322131
<b>Variation (%)</b>	-0.030000

### SURFACE SAR

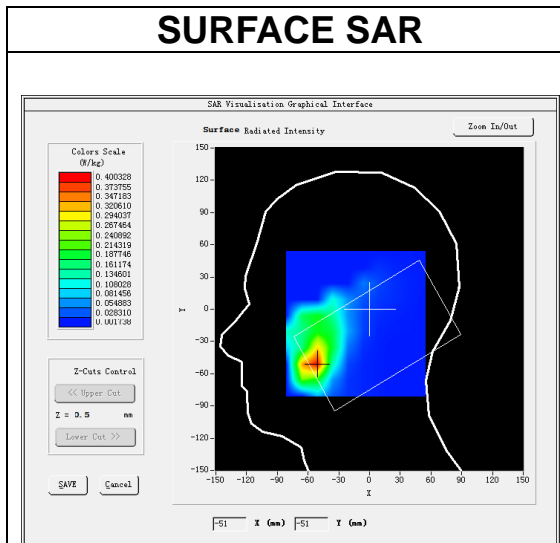

### VOLUME SAR

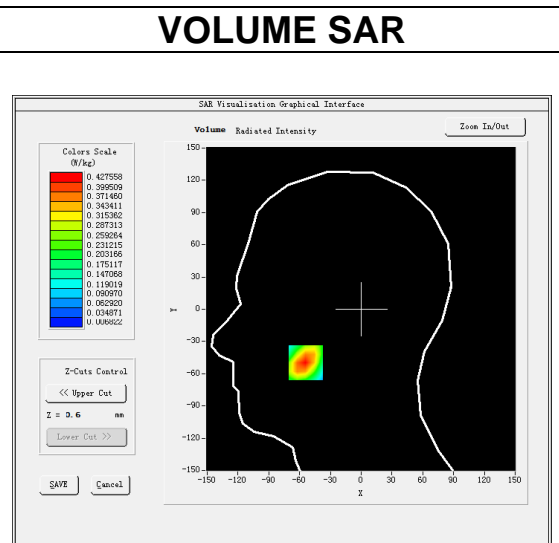

**Maximum location: X=-54.00, Y=-50.00**  
**SAR Peak: 0.62 W/kg**

<b>SAR 10g (W/Kg)</b>	0.226307
<b>SAR 1g (W/Kg)</b>	0.402090

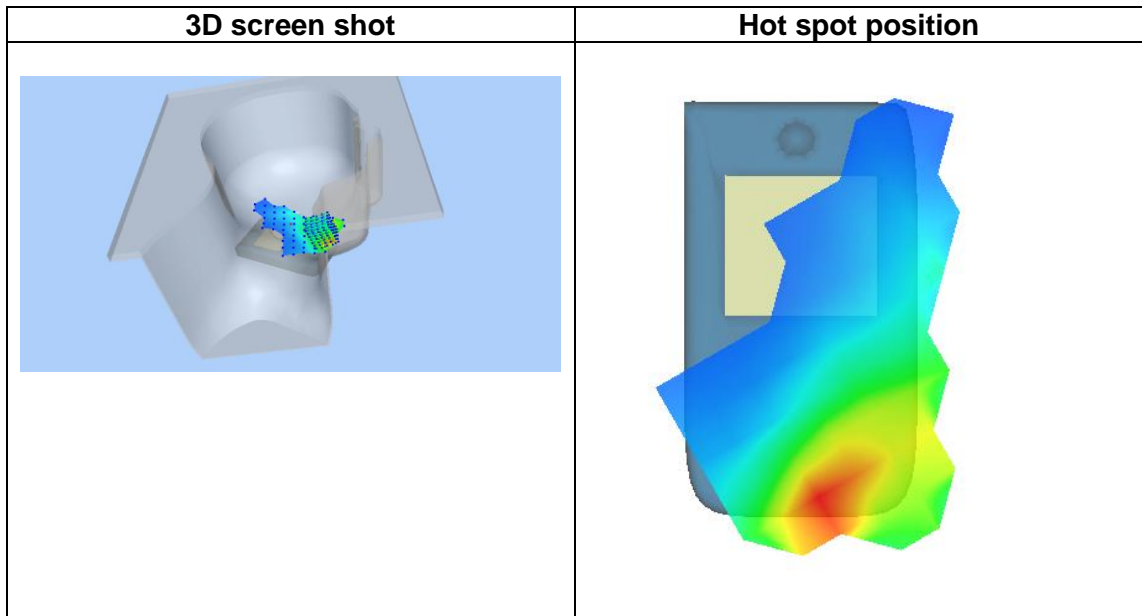
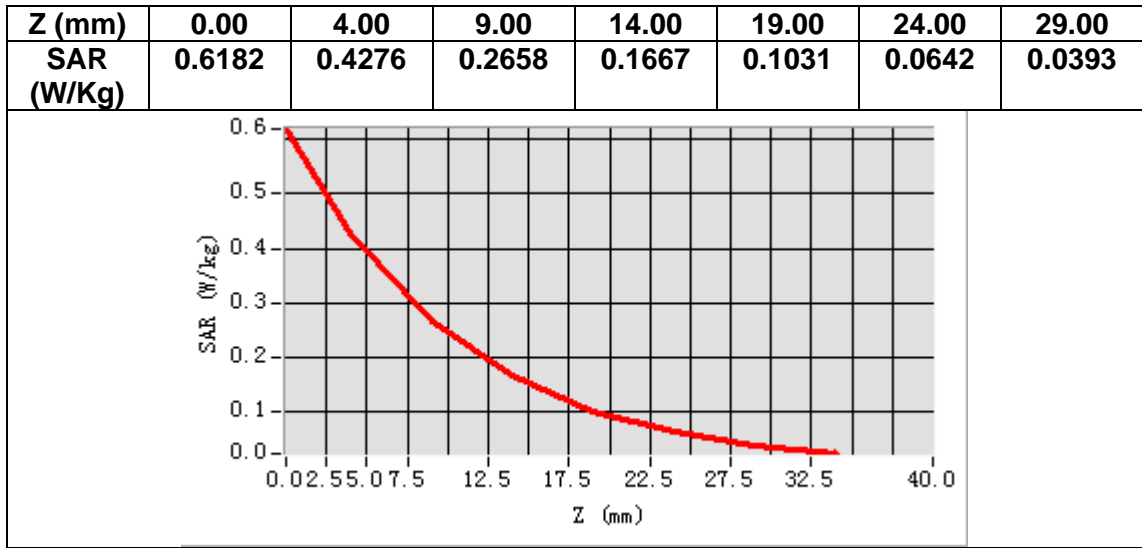

# MEASUREMENT 16

Date of measurement: 6/3/2023

## A. Experimental conditions.

<b>Area Scan</b>	<u>dx=15mm dy=15mm, h= 5.00 mm</u>
<b>ZoomScan</b>	<u>5x5x7, dx=8mm dy=8mm dz=5mm</u>
<b>Phantom</b>	<u>Validation plane</u>
<b>Device Position</b>	<u>Body</u>
<b>Band</b>	<u>LTE band 4</u>
<b>Channels</b>	<u>Middle</u>
<b>Signal</b>	<u>LTE (Crest factor: 1.0)</u>
<b>ConvF</b>	<u>1.73</u>

## B. SAR Measurement Results

<b>Frequency (MHz)</b>	1732.500000
<b>Relative permittivity (real part)</b>	39.429726
<b>Relative permittivity (imaginary part)</b>	13.736429
<b>Conductivity (S/m)</b>	1.322131
<b>Variation (%)</b>	-0.310000

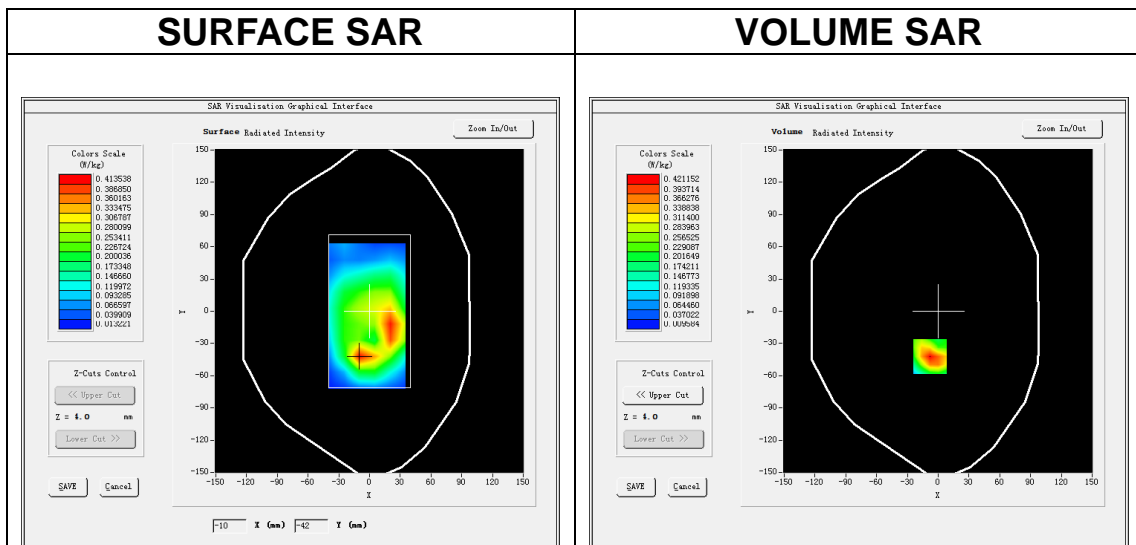

**Maximum location: X=-8.00, Y=-42.00**  
**SAR Peak: 0.65 W/kg**

<b>SAR 10g (W/Kg)</b>	0.213159
<b>SAR 1g (W/Kg)</b>	0.397439



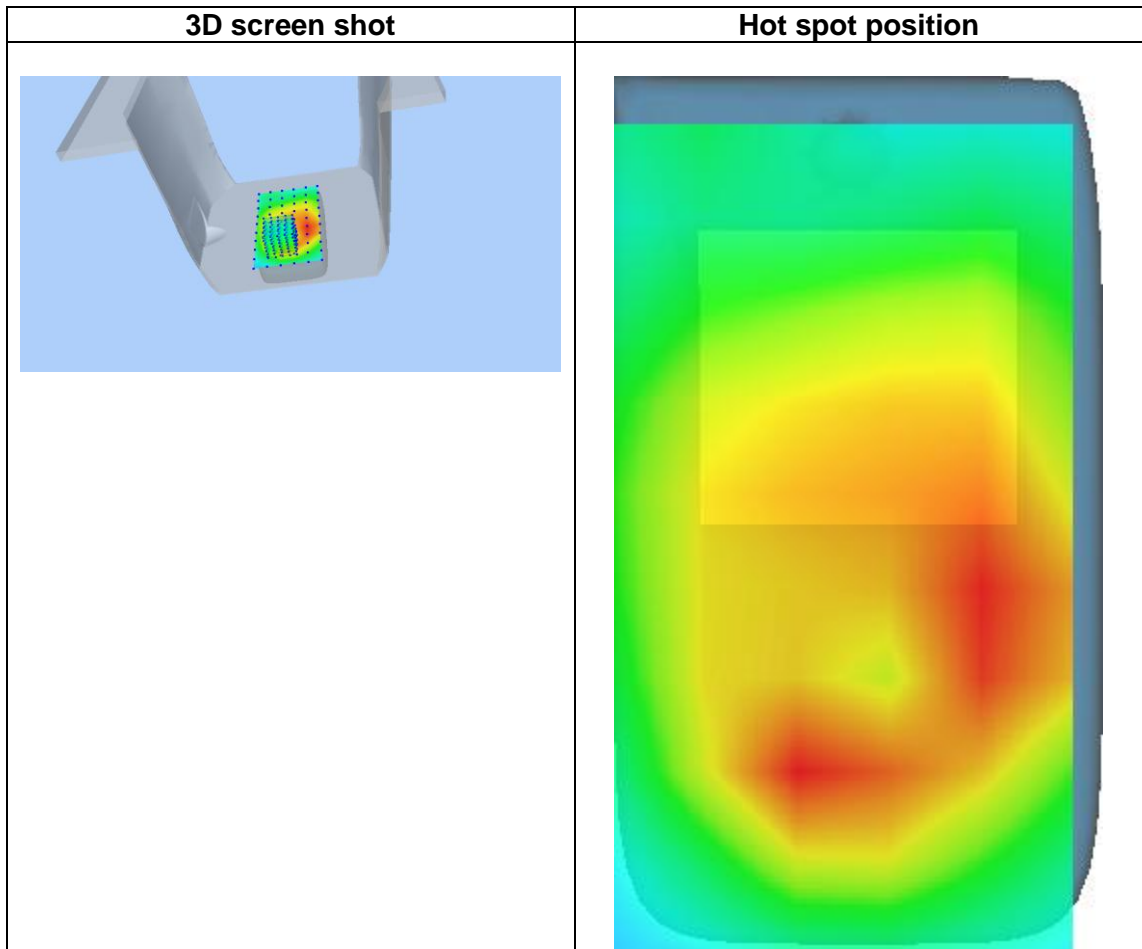
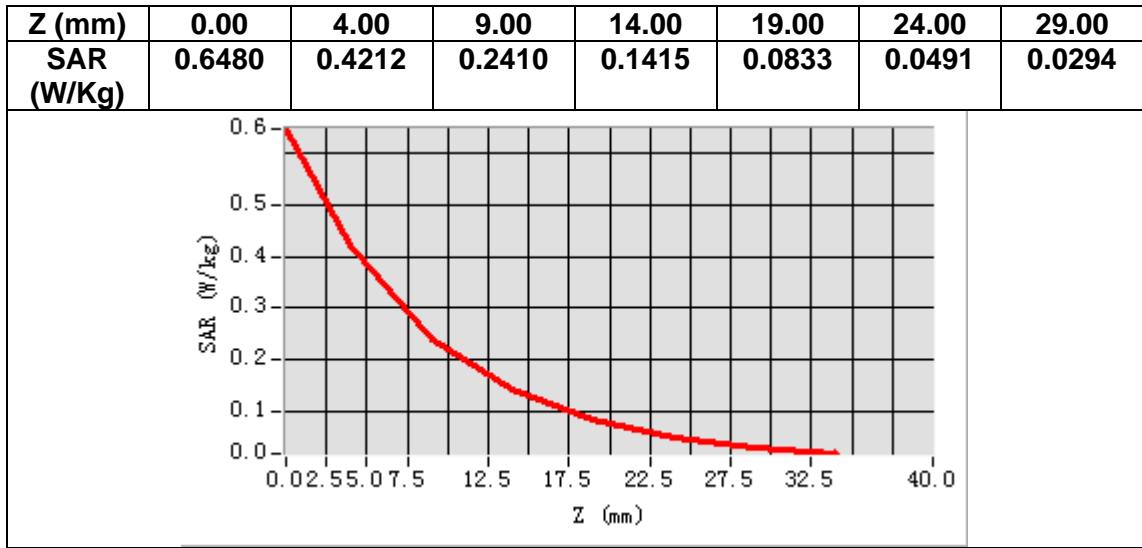

# MEASUREMENT 17

Date of measurement: 14/3/2023

## A. Experimental conditions.

<b>Area Scan</b>	<u>dx=15mm dy=15mm, h= 5.00 mm</u>
<b>ZoomScan</b>	<u>5x5x7, dx=8mm dy=8mm dz=5mm</u>
<b>Phantom</b>	<u>Left head</u>
<b>Device Position</b>	<u>Cheek</u>
<b>Band</b>	<u>LTE band 5</u>
<b>Channels</b>	<u>Middle</u>
<b>Signal</b>	<u>LTE (Crest factor: 1.0)</u>
<b>ConvF</b>	<u>1.50</u>

## B. SAR Measurement Results

<b>Frequency (MHz)</b>	836.500000
<b>Relative permittivity (real part)</b>	41.211826
<b>Relative permittivity (imaginary part)</b>	19.944342
<b>Conductivity (S/m)</b>	0.926858
<b>Variation (%)</b>	-0.170000

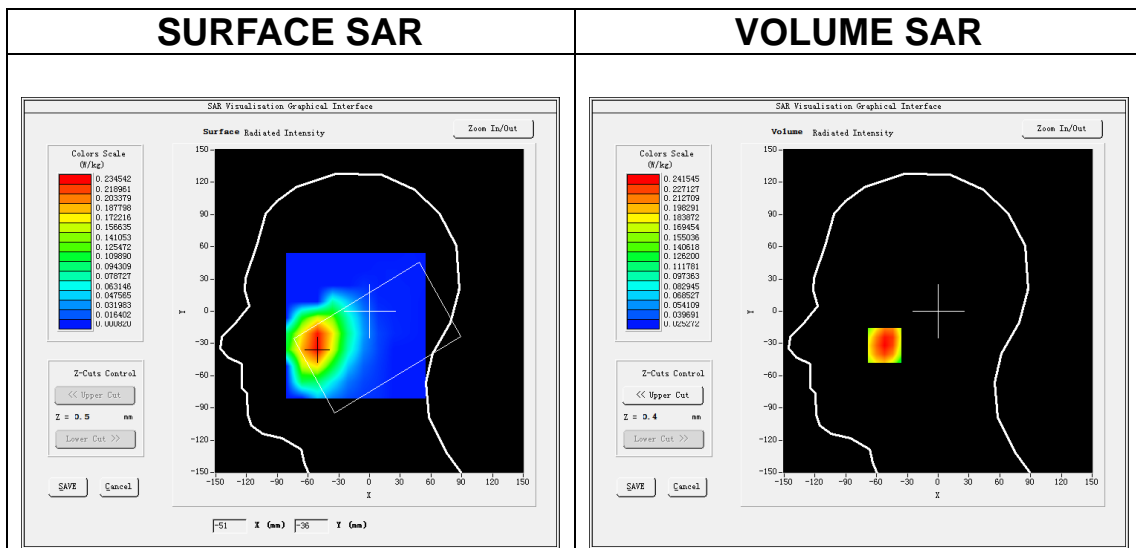

**Maximum location: X=-52.00, Y=-32.00**  
**SAR Peak: 0.29 W/kg**

<b>SAR 10g (W/Kg)</b>	0.174576
<b>SAR 1g (W/Kg)</b>	0.239013

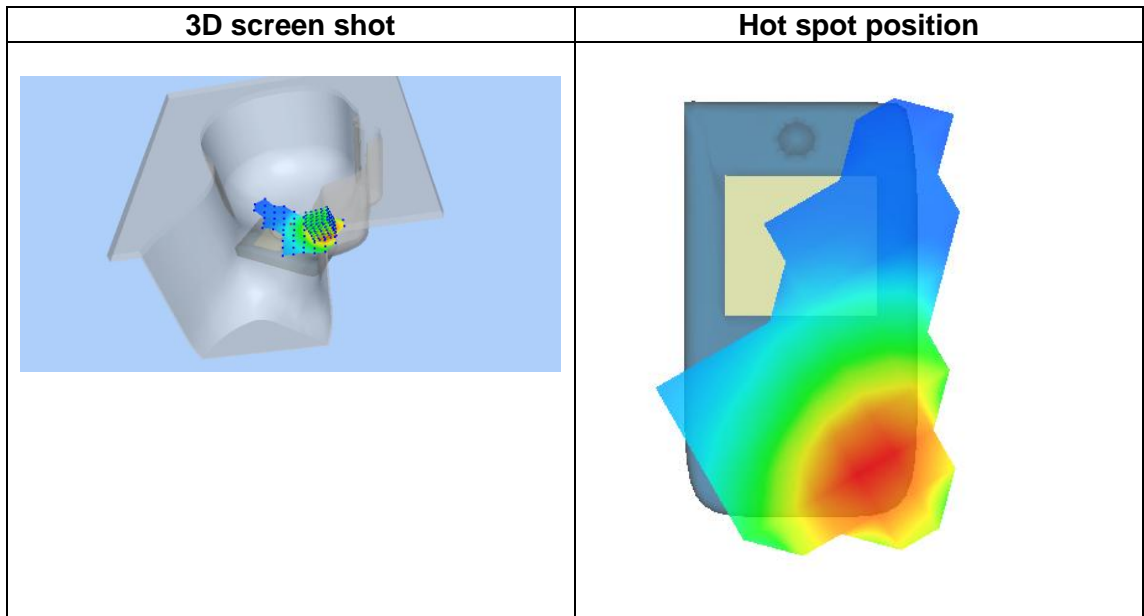
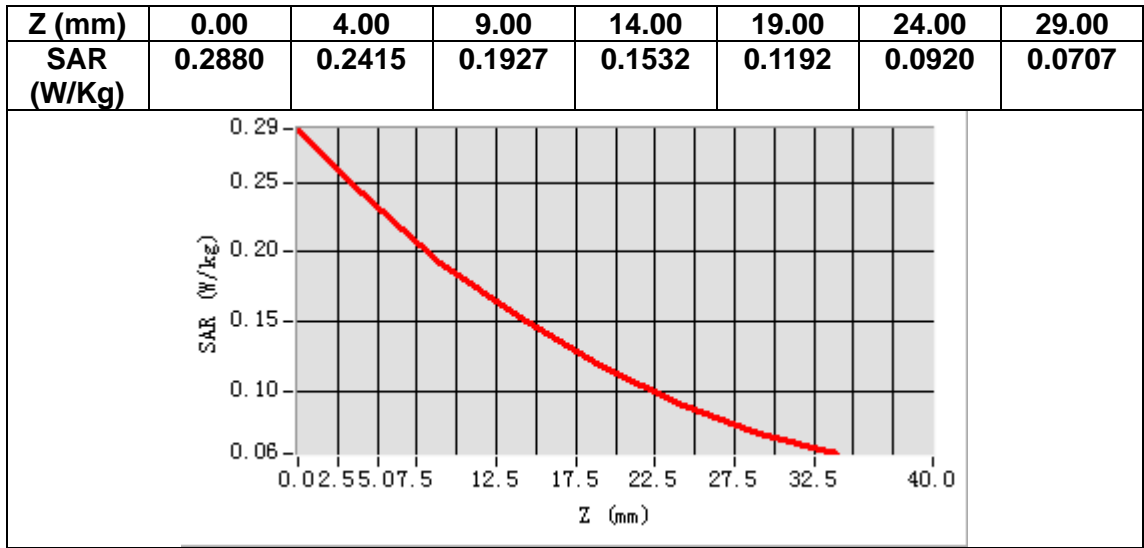

# MEASUREMENT 18

Date of measurement: 14/3/2023

## A. Experimental conditions.

<u>Area Scan</u>	<u>dx=15mm dy=15mm, h= 5.00 mm</u>
<u>ZoomScan</u>	<u>5x5x7, dx=8mm dy=8mm dz=5mm</u>
<u>Phantom</u>	<u>Validation plane</u>
<u>Device Position</u>	<u>Body</u>
<u>Band</u>	<u>LTE band 5</u>
<u>Channels</u>	<u>Middle</u>
<u>Signal</u>	<u>LTE (Crest factor: 1.0)</u>
<u>ConvF</u>	<u>1.50</u>

## B. SAR Measurement Results

<b>Frequency (MHz)</b>	836.500000
<b>Relative permittivity (real part)</b>	41.211826
<b>Relative permittivity (imaginary part)</b>	19.944342
<b>Conductivity (S/m)</b>	0.926858
<b>Variation (%)</b>	0.540000

### SURFACE SAR

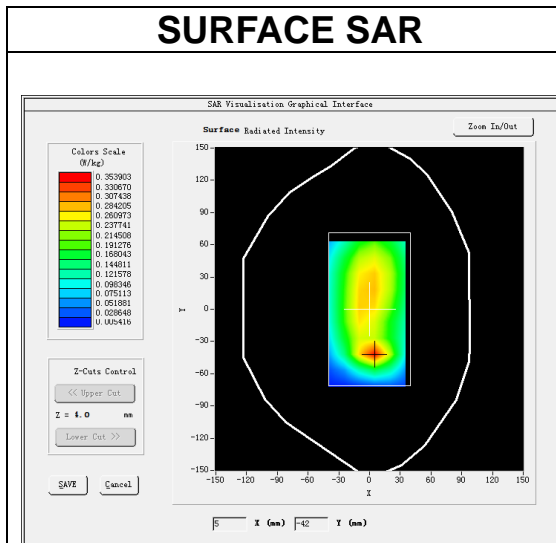

### VOLUME SAR

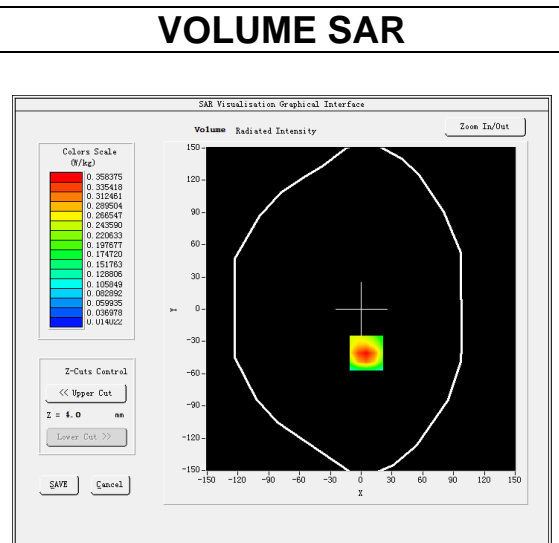

Maximum location: X=5.00, Y=-41.00

SAR Peak: 0.54 W/kg

<b>SAR 10g (W/Kg)</b>	0.200211
<b>SAR 1g (W/Kg)</b>	0.351666

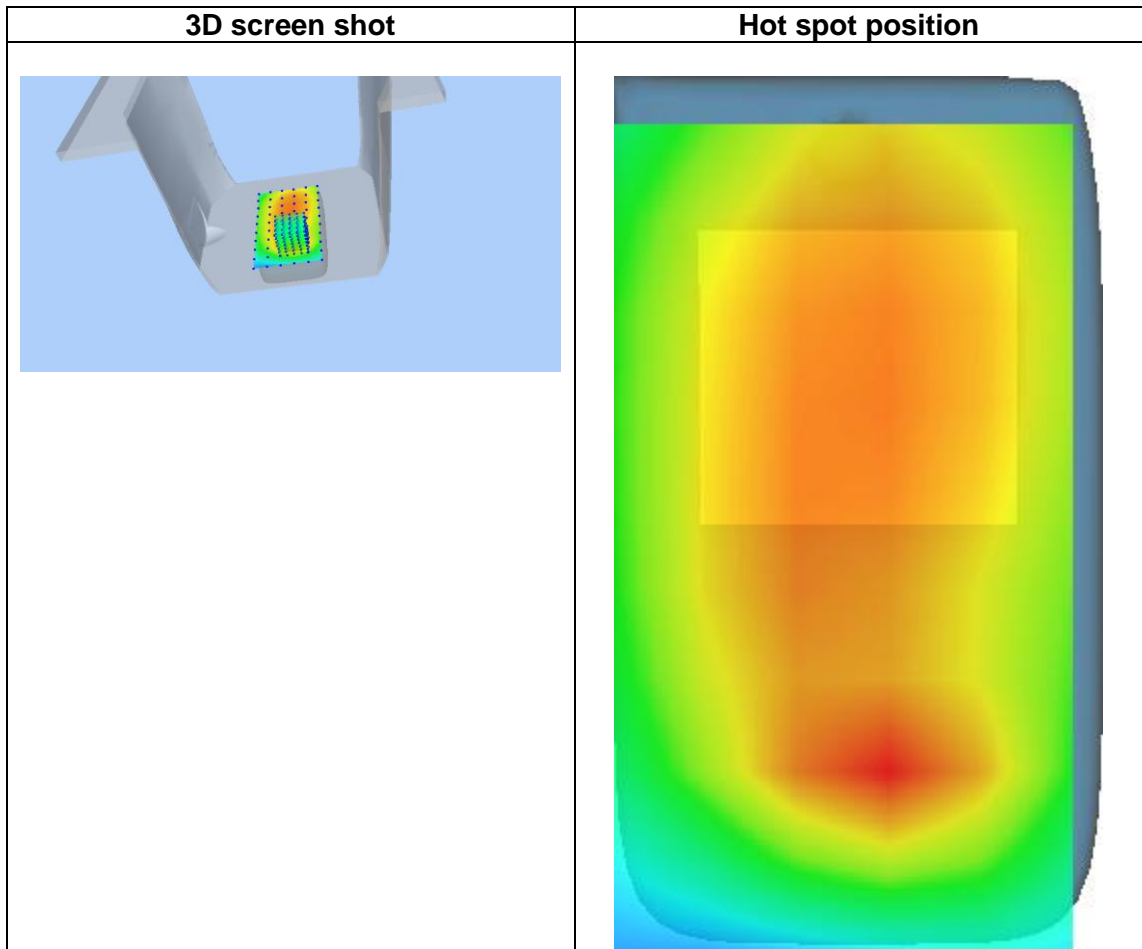
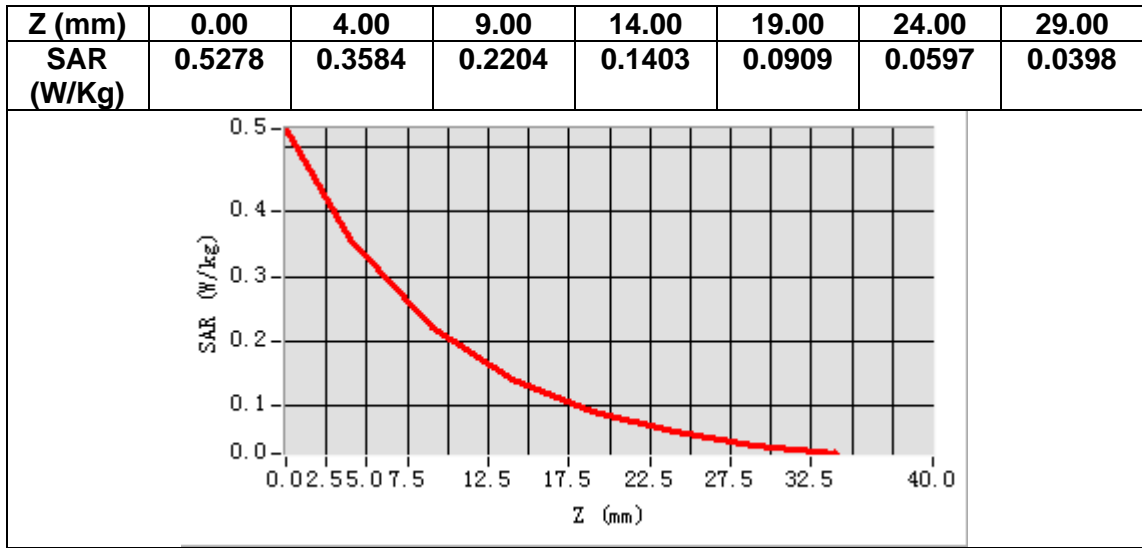

# MEASUREMENT 19

Date of measurement: 10/3/2023

## A. Experimental conditions.

<b>Area Scan</b>	<u>dx=12mm dy=12mm, h= 5.00 mm</u>
<b>ZoomScan</b>	<u>7x7x7,dx=5mm dy=5mm dz=5mm</u>
<b>Phantom</b>	<u>Left head</u>
<b>Device Position</b>	<u>Cheek</u>
<b>Band</b>	<u>LTE band 7</u>
<b>Channels</b>	<u>Middle</u>
<b>Signal</b>	<u>LTE (Crest factor: 1.0)</u>
<b>ConvF</b>	<u>1.87</u>

## B. SAR Measurement Results

<b>Frequency (MHz)</b>	2535.000000
<b>Relative permittivity (real part)</b>	38.381603
<b>Relative permittivity (imaginary part)</b>	13.582723
<b>Conductivity (S/m)</b>	1.912900
<b>Variation (%)</b>	-2.020000

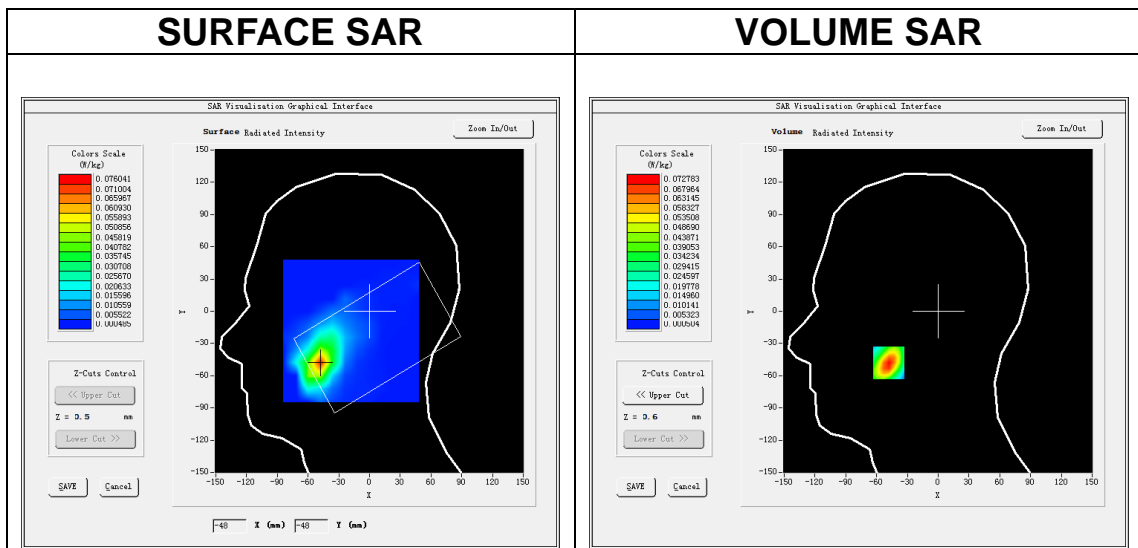

**Maximum location: X=-48.00, Y=-48.00**  
**SAR Peak: 0.11 W/kg**

<b>SAR 10g (W/Kg)</b>	0.033342
<b>SAR 1g (W/Kg)</b>	0.066473

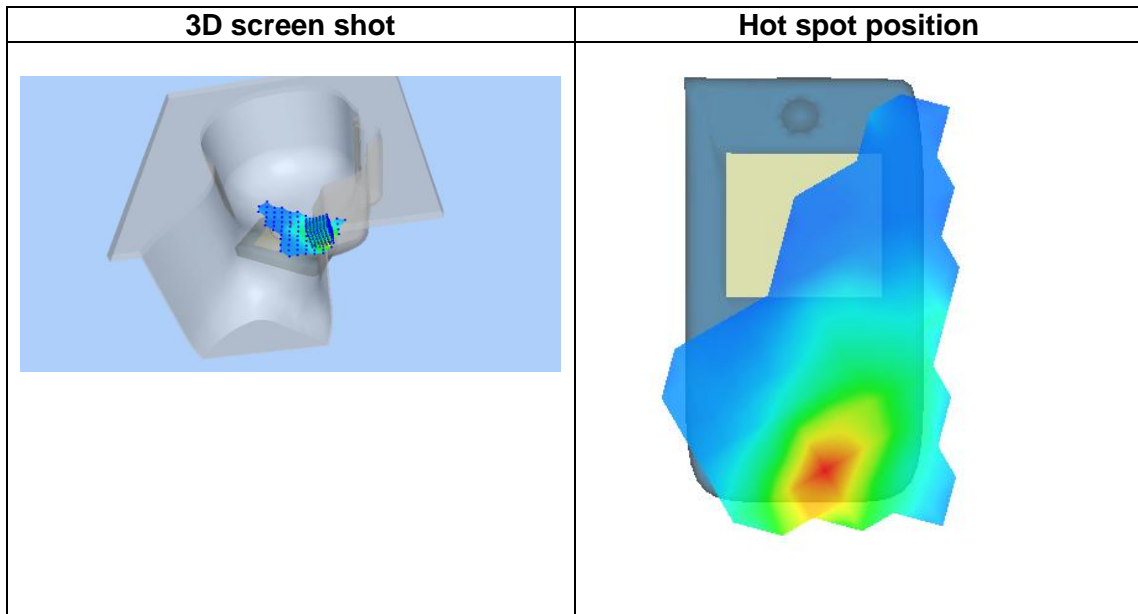
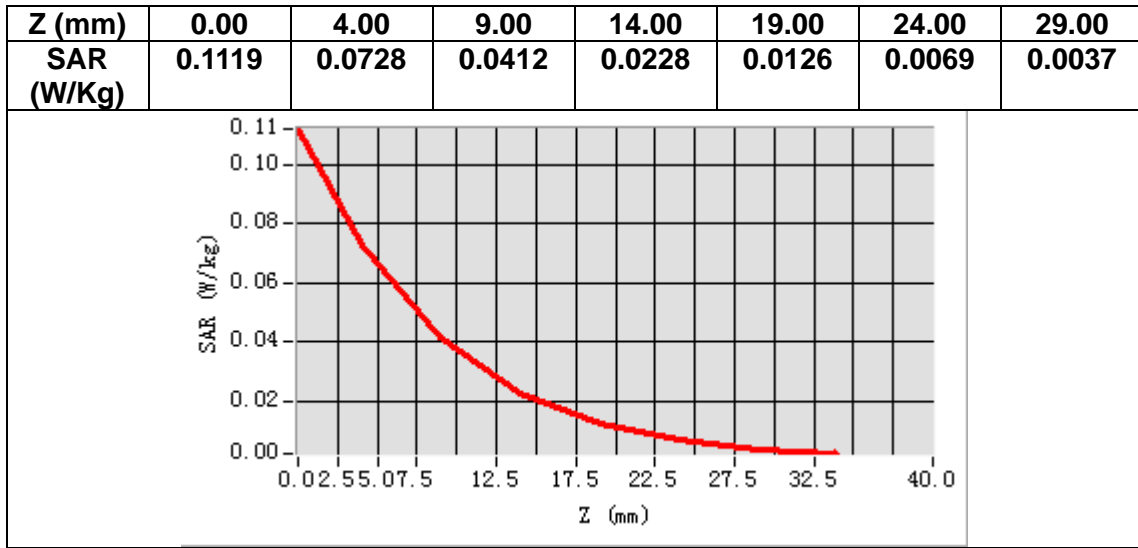

# MEASUREMENT 20

Date of measurement: 10/3/2023

## A. Experimental conditions.

<b>Area Scan</b>	<u>dx=12mm dy=12mm, h= 5.00 mm</u>
<b>ZoomScan</b>	<u>7x7x7,dx=5mm dy=5mm dz=5mm</u>
<b>Phantom</b>	<u>Validation plane</u>
<b>Device Position</b>	<u>Body</u>
<b>Band</b>	<u>LTE band 7</u>
<b>Channels</b>	<u>Middle</u>
<b>Signal</b>	<u>LTE (Crest factor: 1.0)</u>
<b>ConvF</b>	<u>1.87</u>

## B. SAR Measurement Results

<b>Frequency (MHz)</b>	2535.000000
<b>Relative permittivity (real part)</b>	38.381603
<b>Relative permittivity (imaginary part)</b>	13.582723
<b>Conductivity (S/m)</b>	1.912900
<b>Variation (%)</b>	-0.430000

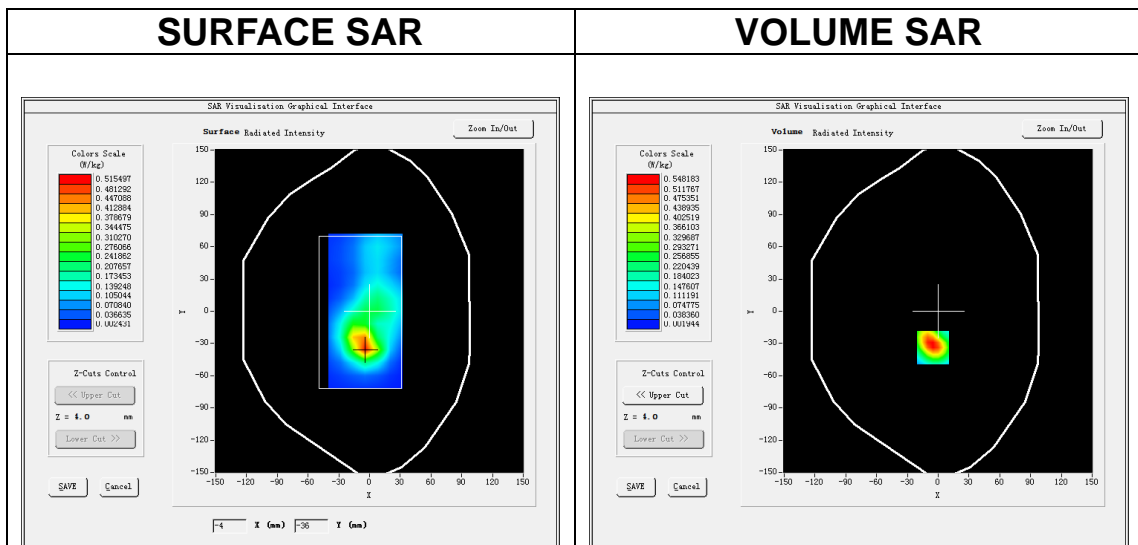

**Maximum location: X=-5.00, Y=-34.00**  
**SAR Peak: 0.94 W/kg**

<b>SAR 10g (W/Kg)</b>	0.244175
<b>SAR 1g (W/Kg)</b>	0.523757



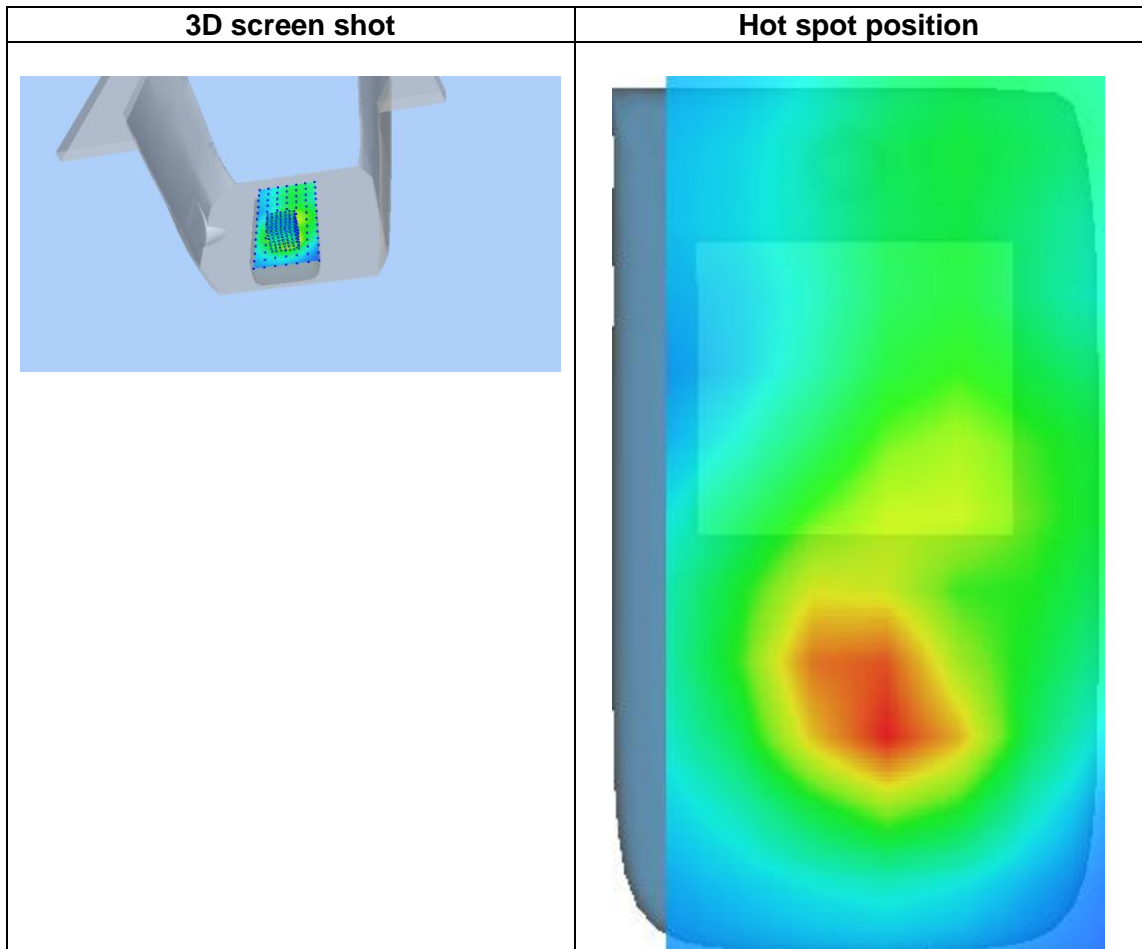
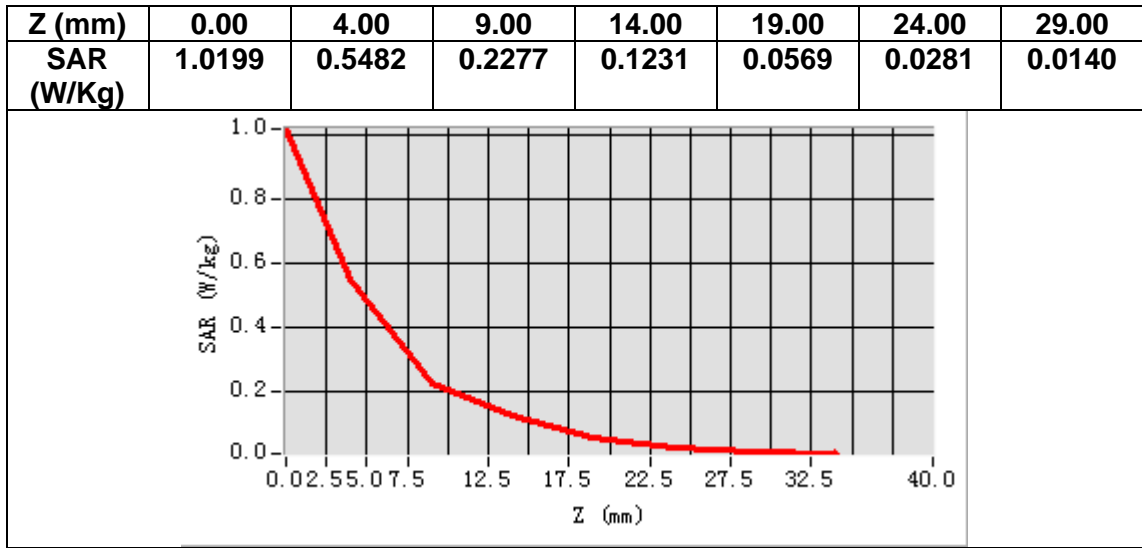

# MEASUREMENT 21

Date of measurement: 10/3/2023

## A. Experimental conditions.

<b>Area Scan</b>	<u>dx=12mm dy=12mm, h= 5.00 mm</u>
<b>ZoomScan</b>	<u>7x7x7,dx=5mm dy=5mm dz=5mm</u>
<b>Phantom</b>	<u>Left head</u>
<b>Device Position</b>	<u>Cheek</u>
<b>Band</b>	<u>LTE band 38</u>
<b>Channels</b>	<u>Middle</u>
<b>Signal</b>	<u>LTE (Crest factor: 1.0)</u>
<b>ConvF</b>	<u>1.87</u>

## B. SAR Measurement Results

<b>Frequency (MHz)</b>	2595.000000
<b>Relative permittivity (real part)</b>	38.013706
<b>Relative permittivity (imaginary part)</b>	13.796523
<b>Conductivity (S/m)</b>	1.988999
<b>Variation (%)</b>	0.920000

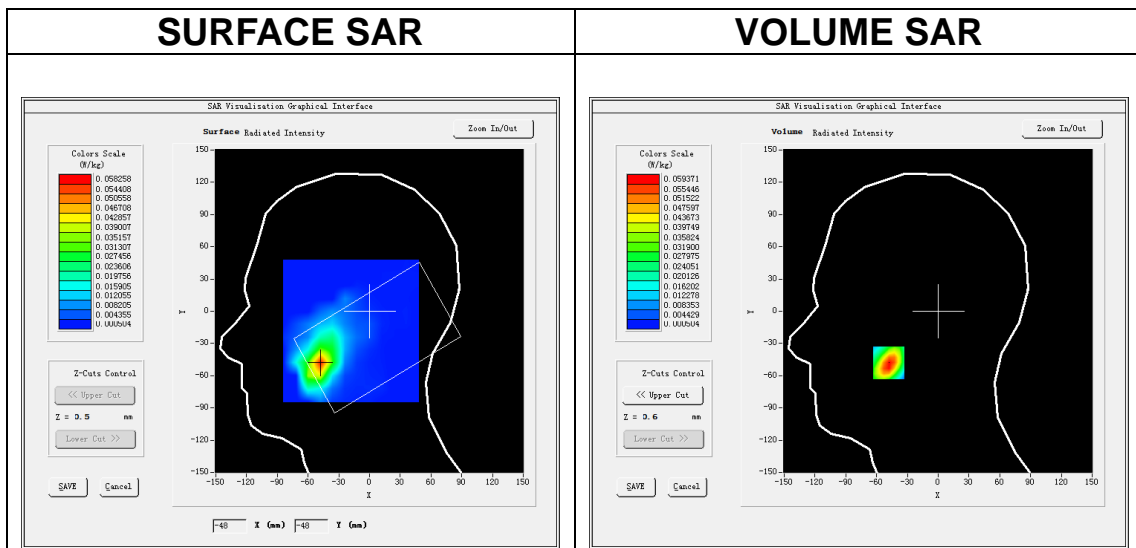

**Maximum location: X=-48.00, Y=-48.00**  
**SAR Peak: 0.09 W/kg**

<b>SAR 10g (W/Kg)</b>	0.027071
<b>SAR 1g (W/Kg)</b>	0.055303

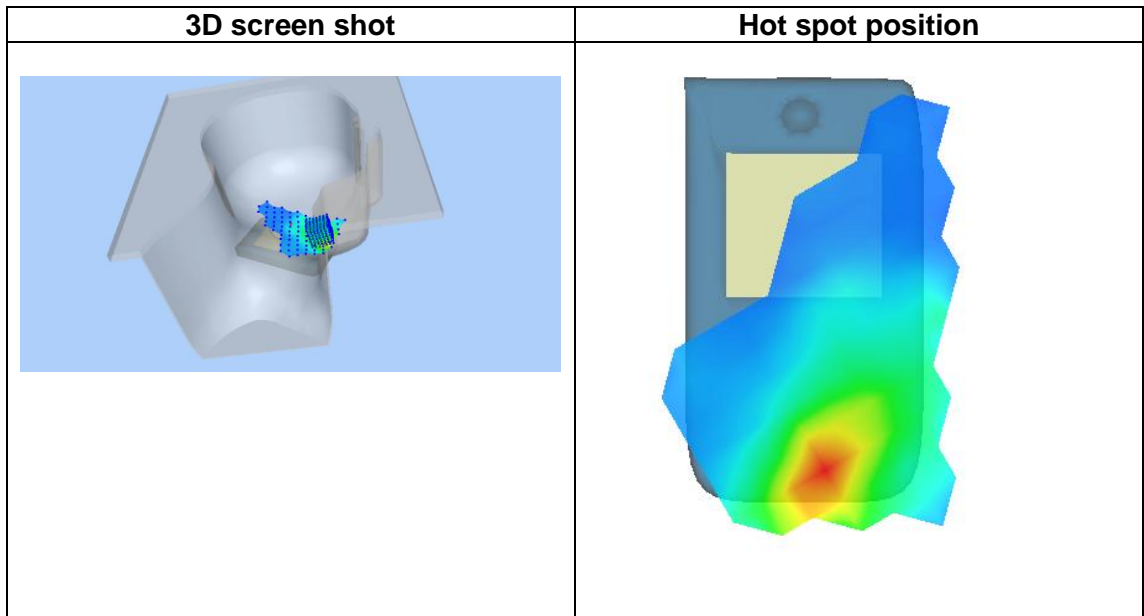
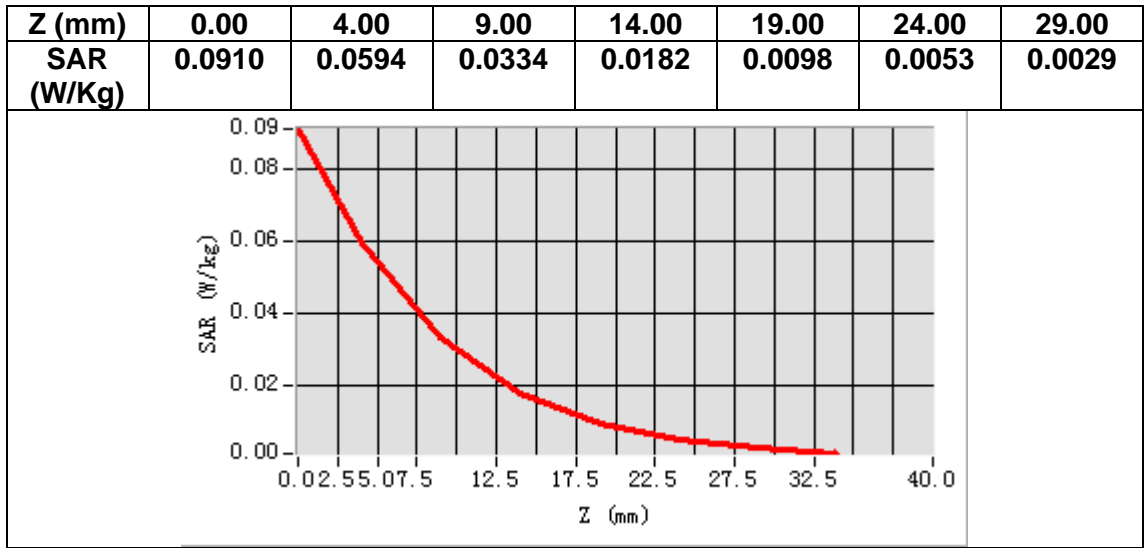

# MEASUREMENT 22

Date of measurement: 10/3/2023

## A. Experimental conditions.

<b>Area Scan</b>	<u>dx=12mm dy=12mm, h= 5.00 mm</u>
<b>ZoomScan</b>	<u>7x7x7,dx=5mm dy=5mm dz=5mm</u>
<b>Phantom</b>	<u>Validation plane</u>
<b>Device Position</b>	<u>Body</u>
<b>Band</b>	<u>LTE band 38</u>
<b>Channels</b>	<u>Middle</u>
<b>Signal</b>	<u>LTE (Crest factor: 1.0)</u>
<b>ConvF</b>	<u>1.87</u>

## B. SAR Measurement Results

<b>Frequency (MHz)</b>	2595.000000
<b>Relative permittivity (real part)</b>	38.013706
<b>Relative permittivity (imaginary part)</b>	13.796523
<b>Conductivity (S/m)</b>	1.988999
<b>Variation (%)</b>	0.230000

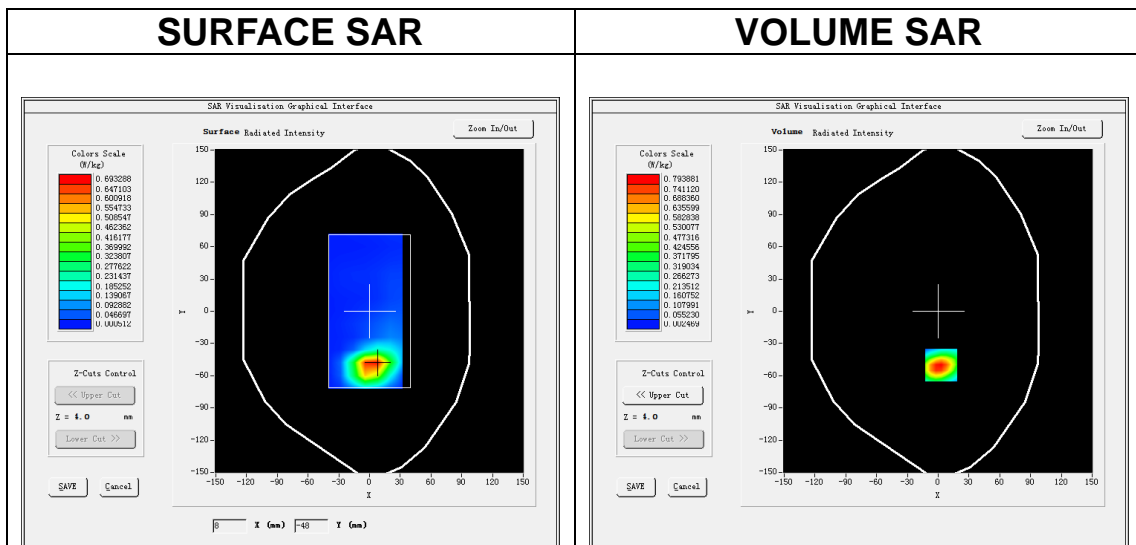

**Maximum location: X=3.00, Y=-50.00**  
**SAR Peak: 1.30 W/kg**

<b>SAR 10g (W/Kg)</b>	0.350676
<b>SAR 1g (W/Kg)</b>	0.741804

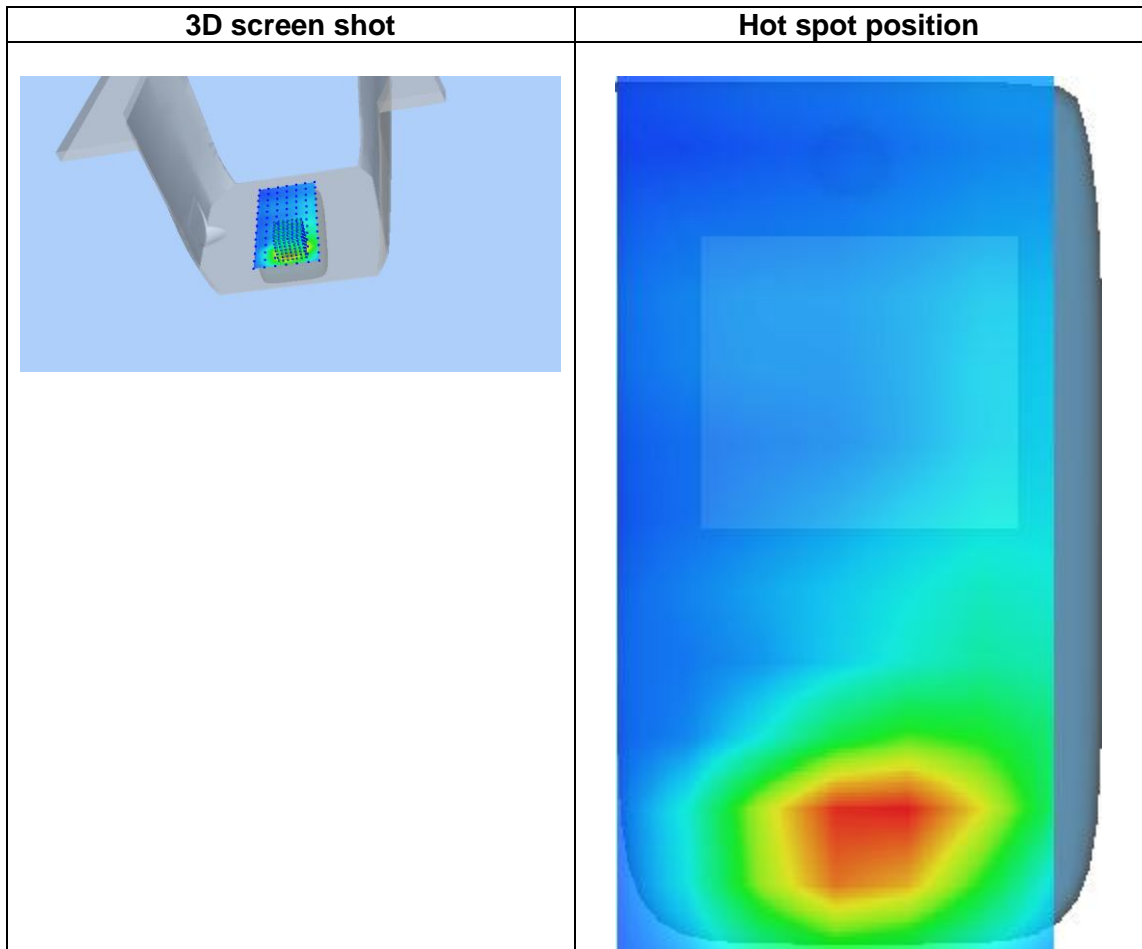
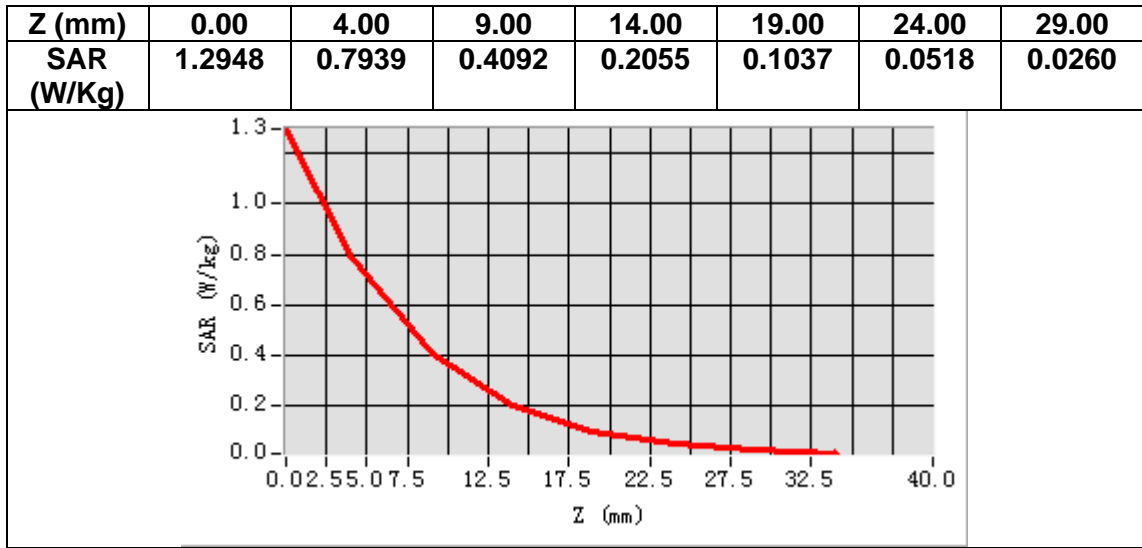

# MEASUREMENT 23

Date of measurement: 6/3/2023

## A. Experimental conditions.

<b>Area Scan</b>	<u>dx=15mm dy=15mm, h= 5.00 mm</u>
<b>ZoomScan</b>	<u>5x5x7, dx=8mm dy=8mm dz=5mm</u>
<b>Phantom</b>	<u>Left head</u>
<b>Device Position</b>	<u>Cheek</u>
<b>Band</b>	<u>FDDBand66</u>
<b>Channels</b>	<u>Middle</u>
<b>Signal</b>	<u>(Crest factor: 1.0)</u>
<b>ConvF</b>	<u>1.73</u>

## B. SAR Measurement Results

<b>Frequency (MHz)</b>	1745.000000
<b>Relative permittivity (real part)</b>	39.357925
<b>Relative permittivity (imaginary part)</b>	13.733979
<b>Conductivity (S/m)</b>	1.331433
<b>Variation (%)</b>	-0.610000

### SURFACE SAR

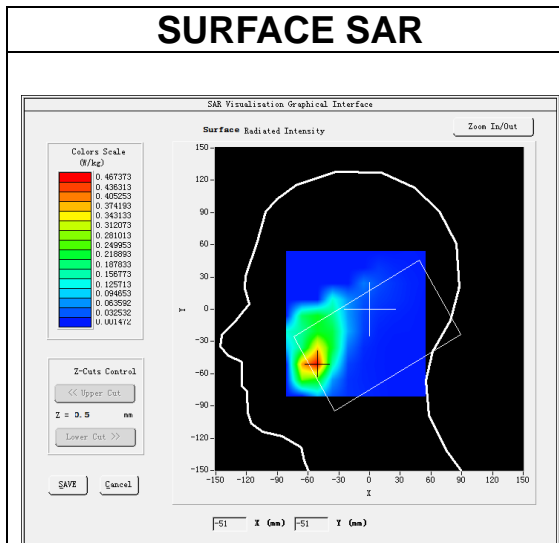

### VOLUME SAR

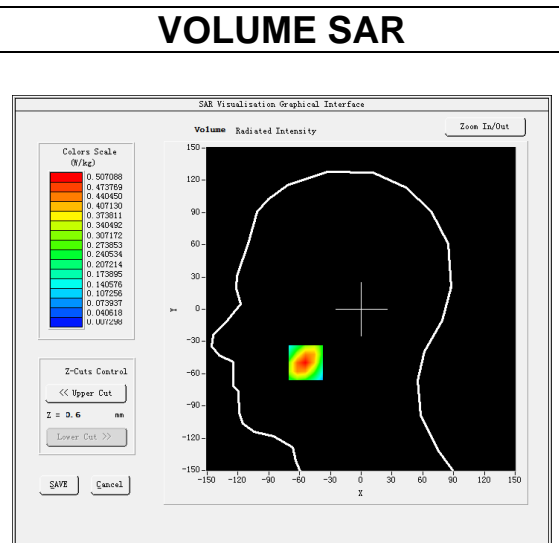

**Maximum location: X=-54.00, Y=-50.00**  
**SAR Peak: 0.74 W/kg**

<b>SAR 10g (W/Kg)</b>	0.268111
<b>SAR 1g (W/Kg)</b>	0.477032

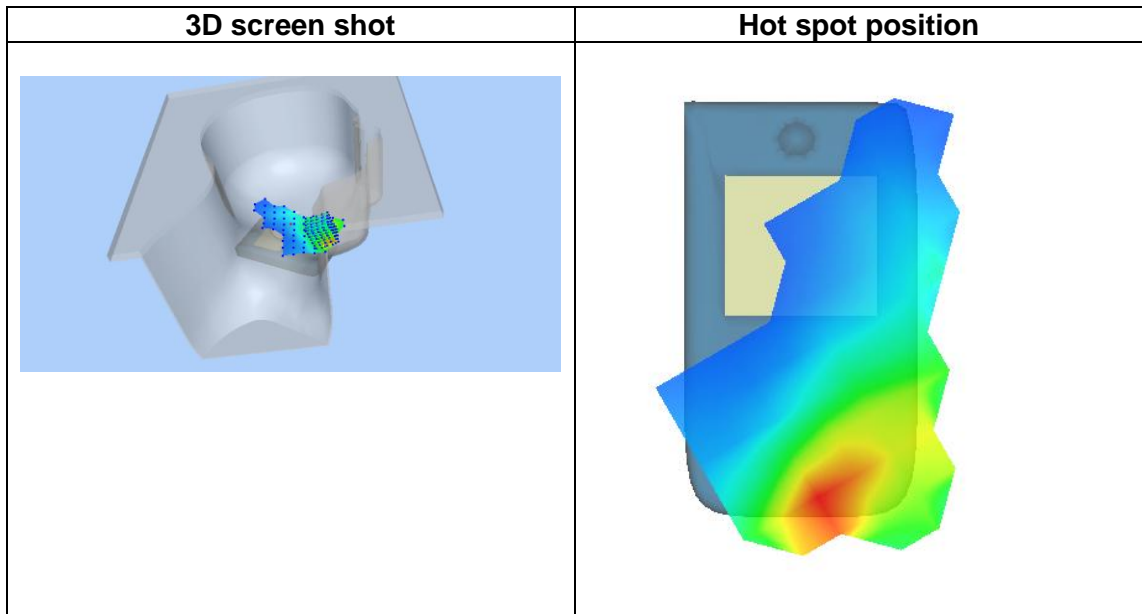
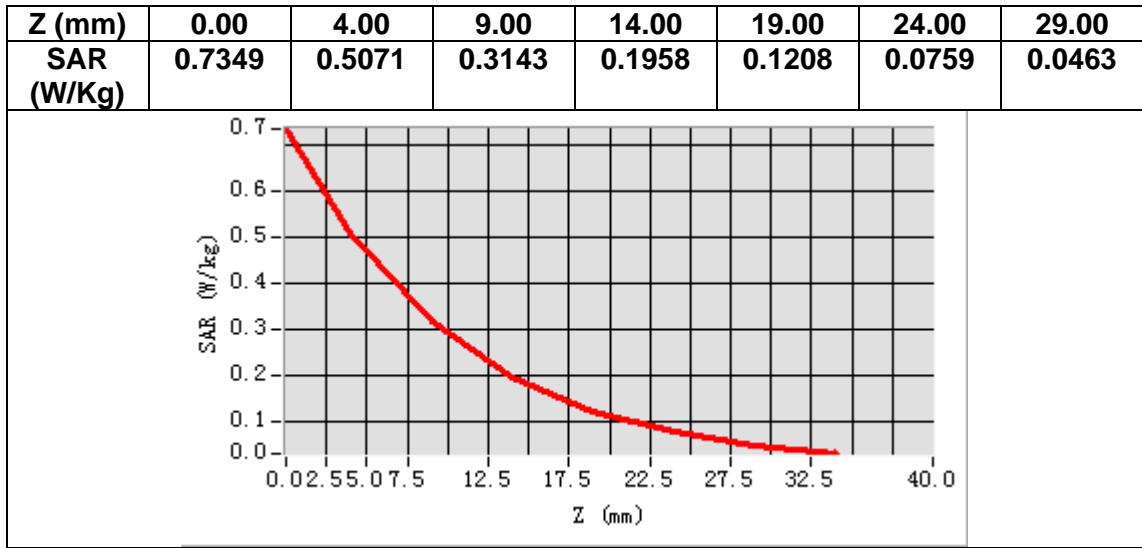

# MEASUREMENT 24

Date of measurement: 6/3/2023

## A. Experimental conditions.

<b>Area Scan</b>	<u>dx=15mm dy=15mm, h= 5.00 mm</u>
<b>ZoomScan</b>	<u>5x5x7, dx=8mm dy=8mm dz=5mm</u>
<b>Phantom</b>	<u>Validation plane</u>
<b>Device Position</b>	<u>Body</u>
<b>Band</b>	<u>FDDBand66</u>
<b>Channels</b>	<u>Middle</u>
<b>Signal</b>	<u>(Crest factor: 1.0)</u>
<b>ConvF</b>	<u>1.73</u>

## B. SAR Measurement Results

<b>Frequency (MHz)</b>	1745.000000
<b>Relative permittivity (real part)</b>	39.357925
<b>Relative permittivity (imaginary part)</b>	13.733979
<b>Conductivity (S/m)</b>	1.331433
<b>Variation (%)</b>	-0.960000

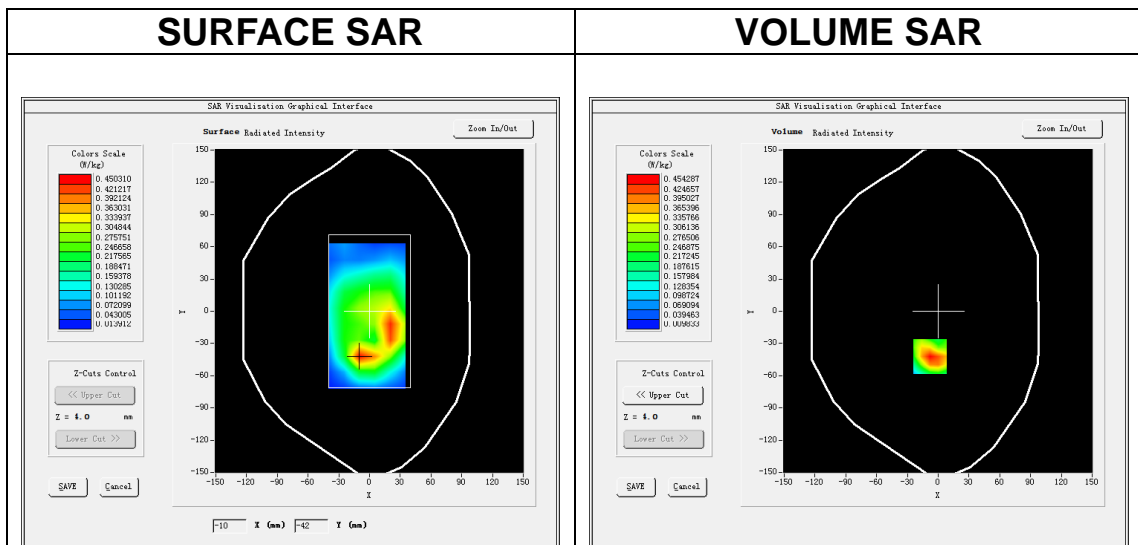

**Maximum location: X=-8.00, Y=-42.00**  
**SAR Peak: 0.71 W/kg**

<b>SAR 10g (W/Kg)</b>	0.230216
<b>SAR 1g (W/Kg)</b>	0.429507



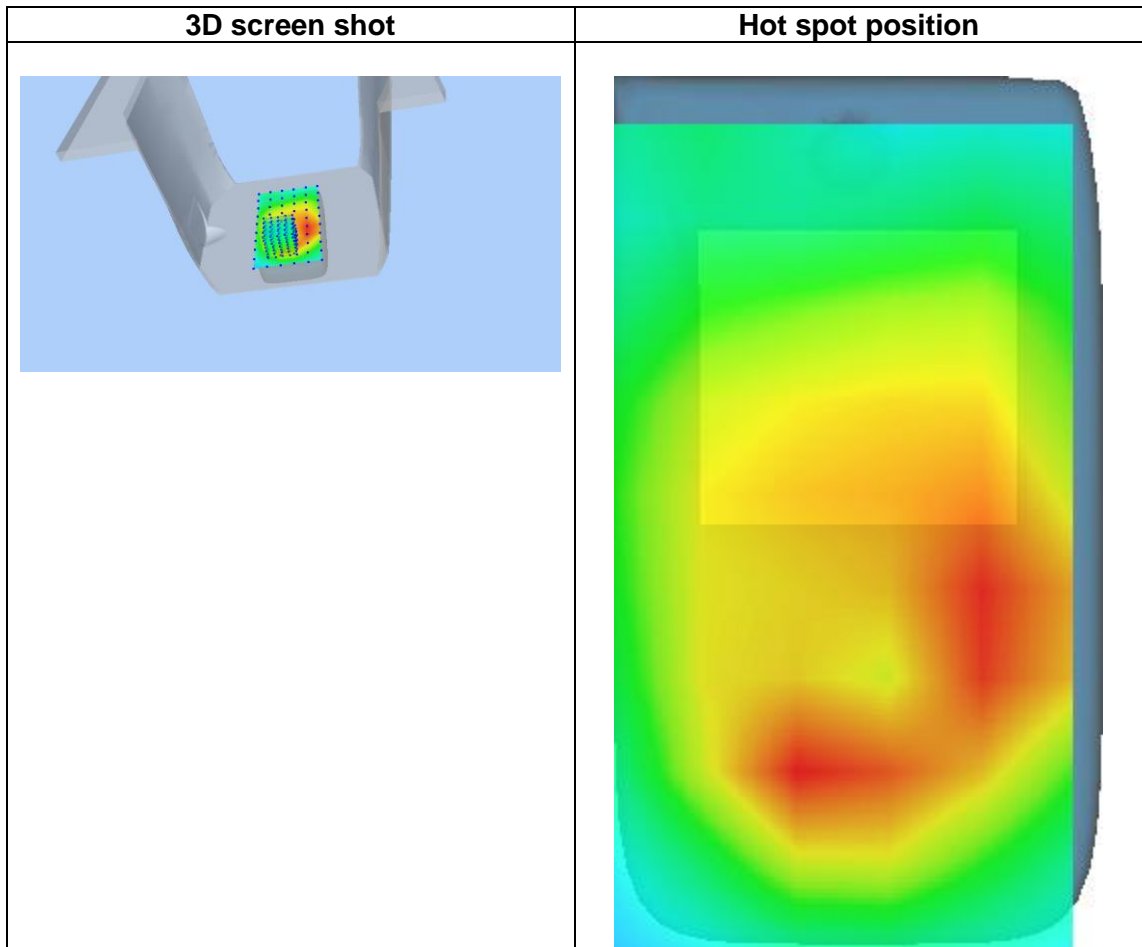
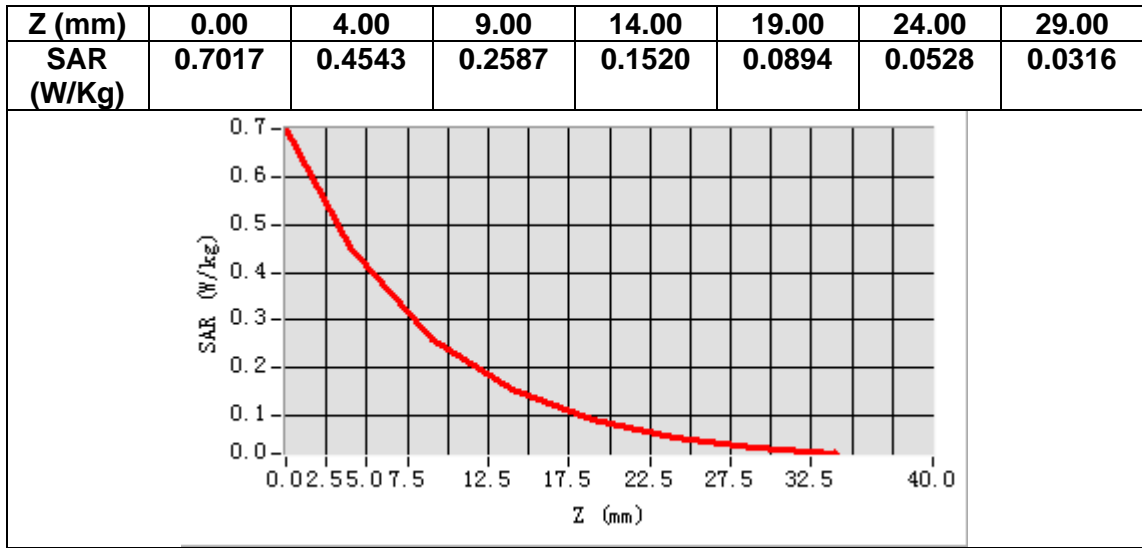

## 14. Appendix D. Calibration Certificate

<b>Table of contents</b>
E Field Probe - SN 08/16 EPGO287
835 MHz Dipole - SN 03/15 DIP 0G835-347
1800 MHz Dipole - SN 03/15 DIP 1G800-349
1900 MHz Dipole - SN 03/15 DIP 1G900-350
2450 MHz Dipole - SN 03/15 DIP 2G450-352
2600 MHz Dipole - SN 03/15 DIP 2G600-356
Extended Calibration Certificate



## COMOSAR E-Field Probe Calibration Report

Ref : ACR.60.1.21.MVGB.A

### SHENZHEN NTEK TESTING TECHNOLOGY CO., LTD.

BUILDING E, FENDA SCIENCE PARK, SANWEI  
COMMUNITY, XIXIANG STREET,  
BAO'AN DISTRICT, SHENZHEN GUANGDONG, CHINA  
MVG COMOSAR DOSIMETRIC E-FIELD PROBE  
SERIAL NO.: SN 08/16 EPG0287

Calibrated at MVG

Z.I. de la pointe du diable

Technopôle Brest Iroise – 295 avenue Alexis de Rochon  
29280 PLOUZANE - FRANCE

Calibration date: 01/10/2023



Accreditations #2-6789 and #2-6814  
Scope available on [www.cofrac.fr](http://www.cofrac.fr)

#### Summary:

This document presents the method and results from an accredited COMOSAR E-Field Probe calibration performed at MVG, using the CALIPROBE test bench, for use with a MVG COMOSAR system only. The test results covered by accreditation are traceable to the International System of Units (SI).



COMOSAR E-FIELD PROBE CALIBRATION REPORT

Ref. ACR.60.1.21.MVGB.A

	Name	Function	Date	Signature
Prepared by :	Jérôme Luc	Technical Manager	1/10/2023	<i>JL</i>
Checked by :	Jérôme Luc	Technical Manager	1/10/2023	<i>JL</i>
Approved by :	Yann Toutain	Laboratory Director	1/10/2023	<i>Yann Toutain</i>

Mode d'emploi 2023.01.10  
11:27:33  
+01'00'

PHILIPS

	Customer Name
Distribution :	SHENZHEN NTEK TESTING TECHNOLOGY CO., LTD.

Issue	Name	Date	Modifications
A	Jérôme Luc	1/10/2023	Initial release



COMOSAR E-FIELD PROBE CALIBRATION REPORT

Ref: ACR.60.1.21.MVGB.A

TABLE OF CONTENTS

1 Device Under Test ..... 4

2 Product Description ..... 4

    2.1 General Information ..... 4

3 Measurement Method ..... 4

    3.1 Linearity ..... 4

    3.2 Sensitivity ..... 5

    3.3 Lower Detection Limit ..... 5

    3.4 Isotropy ..... 5

    3.1 Boundary Effect ..... 5

4 Measurement Uncertainty ..... 6

5 Calibration Measurement Results ..... 6

    5.1 Sensitivity in air ..... 6

    5.2 Linearity ..... 7

    5.3 Sensitivity in liquid ..... 8

    5.4 Isotropy ..... 9

6 List of Equipment ..... 10



COMOSAR E-FIELD PROBE CALIBRATION REPORT

Ref. ACR.60.1.21.MVGB.A

1 DEVICE UNDER TEST

Device Under Test	
Device Type	COMOSAR DOSIMETRIC E FIELD PROBE
Manufacturer	MVG
Model	SSE2
Serial Number	SN 08/16 EPGO287
Product Condition (new / used)	Used
Frequency Range of Probe	0.15 GHz-6GHz
Resistance of Three Dipoles at Connector	Dipole 1: R1=0.211 MΩ Dipole 2: R2=0.199 MΩ Dipole 3: R3=0.199 MΩ

2 PRODUCT DESCRIPTION

2.1 GENERAL INFORMATION

MVG’s COMOSAR E field Probes are built in accordance to the IEEE 1528, FCC KDB865664 D01, CENELEC EN62209 and CEI/IEC 62209 standards.



Figure 1 – MVG COMOSAR Dosimetric E field Dipole

Probe Length	330 mm
Length of Individual Dipoles	2 mm
Maximum external diameter	8 mm
Probe Tip External Diameter	2.5 mm
Distance between dipoles / probe extremity	1 mm

3 MEASUREMENT METHOD

The IEEE 1528, FCC KDB865664 D01, CENELEC EN62209 and CEI/IEC 62209 standards provide recommended practices for the probe calibrations, including the performance characteristics of interest and methods by which to assess their affect. All calibrations / measurements performed meet the fore mentioned standards.

3.1 LINEARITY

The evaluation of the linearity was done in free space using the waveguide, performing a power sweep to cover the SAR range 0.01W/kg to 100W/kg.



COMOSAR E-FIELD PROBE CALIBRATION REPORT

Ref: ACR.60.1.21.MVGB.A

3.2 SENSITIVITY

The sensitivity factors of the three dipoles were determined using a two step calibration method (air and tissue simulating liquid) using waveguides as outlined in the standards.

3.3 LOWER DETECTION LIMIT

The lower detection limit was assessed using the same measurement set up as used for the linearity measurement. The required lower detection limit is 10 mW/kg.

3.4 ISOTROPY

The axial isotropy was evaluated by exposing the probe to a reference wave from a standard dipole with the dipole mounted under the flat phantom in the test configuration suggested for system validations and checks. The probe was rotated along its main axis from 0 to 360 degrees in 15-degree steps. The hemispherical isotropy is determined by inserting the probe in a thin plastic box filled with tissue-equivalent liquid, with the plastic box illuminated with the fields from a half wave dipole. The dipole is rotated about its axis (0°–180°) in 15° increments. At each step the probe is rotated about its axis (0°–360°).

3.1 BOUNDARY EFFECT

The boundary effect is defined as the deviation between the SAR measured data and the expected exponential decay in the liquid when the probe is oriented normal to the interface. To evaluate this effect, the liquid filled flat phantom is exposed to fields from either a reference dipole or waveguide. With the probe normal to the phantom surface, the peak spatial average SAR is measured and compared to the analytical value at the surface.

The boundary effect uncertainty can be estimated according to the following uncertainty approximation formula based on linear and exponential extrapolations between the surface and  $d_{be} + d_{step}$  along lines that are approximately normal to the surface:

$$SAR_{uncertainty} [\%] = \delta SAR_{be} \frac{(d_{be} + d_{step})^2}{2d_{step}} \frac{(e^{-d_{be}/(\delta/2)})}{\delta/2} \text{ for } (d_{be} + d_{step}) < 10 \text{ mm}$$

where

- SAR<sub>uncertainty</sub> is the uncertainty in percent of the probe boundary effect
- $d_{be}$  is the distance between the surface and the closest zoom-scan measurement point, in millimetre
- $\Delta_{step}$  is the separation distance between the first and second measurement points that are closest to the phantom surface, in millimetre, assuming the boundary effect at the second location is negligible
- $\delta$  is the minimum penetration depth in millimetres of the head tissue-equivalent liquids defined in this standard, i.e.,  $\delta \approx 14$  mm at 3 GHz;
- $\Delta SAR_{be}$  in percent of SAR is the deviation between the measured SAR value, at the distance  $d_{be}$  from the boundary, and the analytical SAR value.





COMOSAR E-FIELD PROBE CALIBRATION REPORT

Ref. ACR.60.1.21.MVGB.A

The measured worst case boundary effect SAR uncertainty [%] for scanning distances larger than 4mm is 1.0% Limit (2%).

4 MEASUREMENT UNCERTAINTY

The guidelines outlined in the IEEE 1528, OET 65 Bulletin C, CENELEC EN50361 and CEI/IEC 62209 standards were followed to generate the measurement uncertainty associated with an E-field probe calibration using the waveguide technique. All uncertainties listed below represent an expanded uncertainty expressed at approximately the 95% confidence level using a coverage factor of k=2, traceable to the Internationally Accepted Guides to Measurement Uncertainty.

Uncertainty analysis of the probe calibration in waveguide					
ERROR SOURCES	Uncertainty value (%)	Probability Distribution	Divisor	ci	Standard Uncertainty (%)
Expanded uncertainty 95 % confidence level k = 2					14 %

5 CALIBRATION MEASUREMENT RESULTS

Calibration Parameters	
Liquid Temperature	20 +/- 1 °C
Lab Temperature	20 +/- 1 °C
Lab Humidity	30-70 %

5.1 SENSITIVITY IN AIR

Normx dipole 1 (µV/(V/m) <sup>2</sup> )	Normy dipole 2 (µV/(V/m) <sup>2</sup> )	Normz dipole 3 (µV/(V/m) <sup>2</sup> )
0.72	0.66	0.77

DCP dipole 1 (mV)	DCP dipole 2 (mV)	DCP dipole 3 (mV)
107	110	110

Calibration curves  $e_i=f(V)$  (i=1,2,3) allow to obtain E-field value using the formula:

$$E = \sqrt{E_1^2 + E_2^2 + E_3^2}$$





COMOSAR E-FIELD PROBE CALIBRATION REPORT

Ref: ACR.60.1.21.MVGB.A

Calibration curves

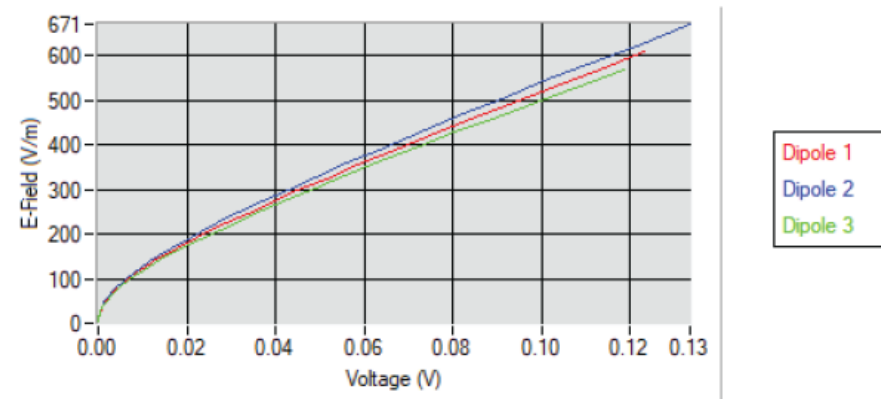

5.2 LINEARITY

Linearity

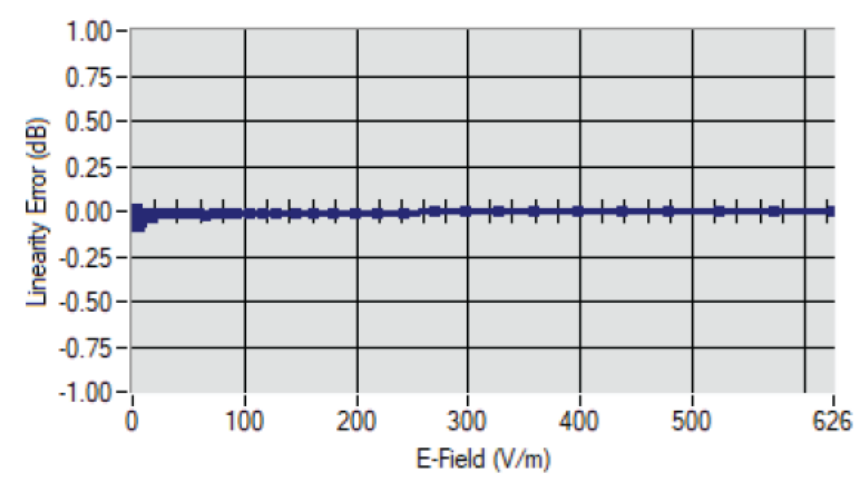

Linearity: +/- 1.90% (+/- 0.08dB)



COMOSAR E-FIELD PROBE CALIBRATION REPORT

Ref. ACR.60.1.21.MVGB.A

5.3 SENSITIVITY IN LIQUID

<u>Liquid</u>	<u>Frequency</u> <u>(MHz +/-</u> <u>100MHz)</u>	<u>ConvF</u>
HL750	750	1.49
HL850	835	1.50
HL900	900	1.61
HL1800	1800	1.73
HL1900	1900	1.91
HL2000	2000	1.97
HL2300	2300	1.92
HL2450	2450	1.98
HL2600	2600	1.87
HL3300	3300	1.79
HL3500	3500	1.85
HL3700	3700	1.79
HL3900	3900	2.07
HL4200	4200	2.21
HL4600	4600	2.25
HL4900	4900	2.05
HL5200	5200	1.80
HL5400	5400	2.05
HL5600	5600	2.16
HL5800	5800	2.07

LOWER DETECTION LIMIT: 8mW/kg



COMOSAR E-FIELD PROBE CALIBRATION REPORT

Ref. ACR.60.1.21.MVGB.A

5.4 ISOTROPY

HL1800 MHz

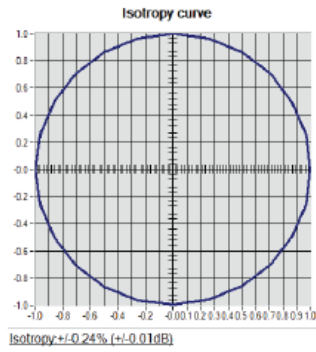



COMOSAR E-FIELD PROBE CALIBRATION REPORT

Ref. ACR.60.1.21.MVGB.A

6 LIST OF EQUIPMENT

Equipment Summary Sheet				
Equipment Description	Manufacturer / Model	Identification No.	Current Calibration Date	Next Calibration Date
Flat Phantom	MVG	SN-20/09-SAM71	Validated. No cal required.	Validated. No cal required.
COMOSAR Test Bench	Version 3	NA	Validated. No cal required.	Validated. No cal required.
Network Analyzer	Rohde & Schwarz ZVM	100203	05/2022	05/2025
Network Analyzer – Calibration kit	Rohde & Schwarz ZV-Z235	101223	05/2022	05/2025
Multimeter	Keithley 2000	1160271	02/2022	02/2025
Signal Generator	Rohde & Schwarz SMB	106589	04/2022	04/2025
Amplifier	Aethercomm	SN 046	Characterized prior to test. No cal required.	Characterized prior to test. No cal required.
Power Meter	NI-USB 5680	170100013	05/2022	05/2025
Directional Coupler	Narda 4216-20	01386	Characterized prior to test. No cal required.	Characterized prior to test. No cal required.
Waveguide	Mega Industries	069Y7-158-13-712	Validated. No cal required.	Validated. No cal required.
Waveguide Transition	Mega Industries	069Y7-158-13-701	Validated. No cal required.	Validated. No cal required.
Waveguide Termination	Mega Industries	069Y7-158-13-701	Validated. No cal required.	Validated. No cal required.
Temperature / Humidity Sensor	Testo 184 H1	44220687	05/2020	05/2023



## SAR Reference Dipole Calibration Report

Ref : ACR.60.3.21.MVGB.A

**SHENZHEN NTEK TESTING TECHNOLOGY  
CO., LTD.**

**BUILDING E, FENDA SCIENCE PARK, SANWEI  
COMMUNITY, XIXIANG STREET,  
BAO'AN DISTRICT, SHENZHEN GUANGDONG, CHINA**

**MVG COMOSAR REFERENCE DIPOLE**

**FREQUENCY: 835 MHZ**

**SERIAL NO.: SN 03/15 DIP0G835-347**

**Calibrated at MVG**

**Z.I. de la pointe du diable**

**Technopôle Brest Iroise – 295 avenue Alexis de Rochon**

**29280 PLOUZANE - FRANCE**

**Calibration date: 03/01/2021**



Accreditations #2-6789 and #2-6814  
Scope available on [www.cofrac.fr](http://www.cofrac.fr)

### *Summary:*

This document presents the method and results from an accredited SAR reference dipole calibration performed at MVG, using the COMOSAR test bench. The test results covered by accreditation are traceable to the International System of Units (SI).



SAR REFERENCE DIPOLE CALIBRATION REPORT

Ref. ACR.60.3.21.MVGB.A

	Name	Function	Date	Signature
Prepared by :	Jérôme Luc	Technical Manager	3/1/2021	<i>JL</i>
Checked by :	Jérôme Luc	Technical Manager	3/1/2021	<i>JL</i>
Approved by :	Yann Toutain	Laboratory Director	3/1/2021	<i>Yann Toutain</i>

Made d'emploi 2021.03.01 13:09:12 +01'00'

PHILIPS

	Customer Name
Distribution :	SHENZHEN NTEK TESTING TECHNOLOGY CO., LTD.

Issue	Name	Date	Modifications
A	Jérôme Luc	3/1/2021	Initial release



**SAR REFERENCE DIPOLE CALIBRATION REPORT**

Ref. ACR.60.3.21.MVGB.A

**TABLE OF CONTENTS**

1	Introduction.....	4
2	Device Under Test .....	4
3	Product Description .....	4
3.1	General Information .....	4
4	Measurement Method .....	5
4.1	Return Loss Requirements .....	5
4.2	Mechanical Requirements .....	5
5	Measurement Uncertainty.....	5
5.1	Return Loss .....	5
5.2	Dimension Measurement .....	5
5.3	Validation Measurement .....	5
6	Calibration Measurement Results.....	6
6.1	Return Loss and Impedance .....	6
6.2	Mechanical Dimensions .....	6
7	Validation measurement .....	7
7.1	Measurement Condition .....	7
7.2	Head Liquid Measurement .....	7
7.3	Measurement Result .....	8
8	List of Equipment .....	10



**SAR REFERENCE DIPOLE CALIBRATION REPORT**

Ref. ACR.60.3.21.MVGB.A

**1 INTRODUCTION**

This document contains a summary of the requirements set forth by the IEEE 1528, FCC KDBs and CEI/IEC 62209 standards for reference dipoles used for SAR measurement system validations and the measurements that were performed to verify that the product complies with the fore mentioned standards.

**2 DEVICE UNDER TEST**

Device Under Test	
Device Type	COMOSAR 835 MHz REFERENCE DIPOLE
Manufacturer	MVG
Model	SID835
Serial Number	SN 03/15 DIP0G835-347
Product Condition (new / used)	Used

**3 PRODUCT DESCRIPTION**

**3.1 GENERAL INFORMATION**

MVG's COMOSAR Validation Dipoles are built in accordance to the IEEE 1528, FCC KDBs and CEI/IEC 62209 standards. The product is designed for use with the COMOSAR test bench only.



**Figure 1 – MVG COMOSAR Validation Dipole**





**SAR REFERENCE DIPOLE CALIBRATION REPORT**

Ref ACR.60.3.21.MVGB.A

**4 MEASUREMENT METHOD**

The IEEE 1528, FCC KDBs and CEI/IEC 62209 standards provide requirements for reference dipoles used for system validation measurements. The following measurements were performed to verify that the product complies with the fore mentioned standards.

**4.1 RETURN LOSS REQUIREMENTS**

The dipole used for SAR system validation measurements and checks must have a return loss of -20 dB or better. The return loss measurement shall be performed against a liquid filled flat phantom, with the phantom constructed as outlined in the fore mentioned standards. A direct method is used with a network analyser and its calibration kit, both with a valid ISO17025 calibration.

**4.2 MECHANICAL REQUIREMENTS**

The IEEE Std. 1528 and CEI/IEC 62209 standards specify the mechanical components and dimensions of the validation dipoles, with the dimension's frequency and phantom shell thickness dependent. The COMOSAR test bench employs a 2 mm phantom shell thickness therefore the dipoles sold for use with the COMOSAR test bench comply with the requirements set forth for a 2 mm phantom shell thickness. A direct method is used with a ISO17025 calibrated caliper.

**5 MEASUREMENT UNCERTAINTY**

All uncertainties listed below represent an expanded uncertainty expressed at approximately the 95% confidence level using a coverage factor of k=2, traceable to the Internationally Accepted Guides to Measurement Uncertainty.

**5.1 RETURN LOSS**

The following uncertainties apply to the return loss measurement:

Frequency band	Expanded Uncertainty on Return Loss
400-6000MHz	0.08 LIN

**5.2 DIMENSION MEASUREMENT**

The following uncertainties apply to the dimension measurements:

Length (mm)	Expanded Uncertainty on Length
0 - 300	0.20 mm
300 - 450	0.44 mm

**5.3 VALIDATION MEASUREMENT**

The guidelines outlined in the IEEE 1528, FCC KDBs, CENELEC EN50361 and CEI/IEC 62209 standards were followed to generate the measurement uncertainty for validation measurements.

Scan Volume	Expanded Uncertainty



SAR REFERENCE DIPOLE CALIBRATION REPORT

Ref. ACR.60.3.21.MVGB.A

1 g	19 % (SAR)
10 g	19 % (SAR)

6 CALIBRATION MEASUREMENT RESULTS

6.1 RETURN LOSS AND IMPEDANCE

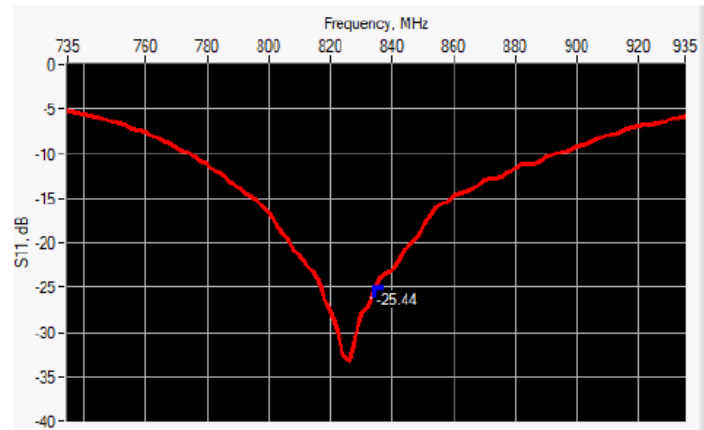

Frequency (MHz)	Return Loss (dB)	Requirement (dB)	Impedance
835	-25.44	-20	54.4 Ω - 2.9 jΩ

6.2 MECHANICAL DIMENSIONS

Frequency MHz	L mm		h mm		d mm	
	required	measured	required	measured	required	measured
300	420.0 ±1 %.		250.0 ±1 %.		6.35 ±1 %.	
450	290.0 ±1 %.		166.7 ±1 %.		6.35 ±1 %.	
750	176.0 ±1 %.		100.0 ±1 %.		6.35 ±1 %.	
835	161.0 ±1 %.	-	89.8 ±1 %.	-	3.6 ±1 %.	-
900	149.0 ±1 %.		83.3 ±1 %.		3.6 ±1 %.	
1450	89.1 ±1 %.		51.7 ±1 %.		3.6 ±1 %.	
1500	80.5 ±1 %.		50.0 ±1 %.		3.6 ±1 %.	
1640	79.0 ±1 %.		45.7 ±1 %.		3.6 ±1 %.	
1750	75.2 ±1 %.		42.9 ±1 %.		3.6 ±1 %.	
1800	72.0 ±1 %.		41.7 ±1 %.		3.6 ±1 %.	
1900	68.0 ±1 %.		39.5 ±1 %.		3.6 ±1 %.	
1950	66.3 ±1 %.		38.5 ±1 %.		3.6 ±1 %.	
2000	64.5 ±1 %.		37.5 ±1 %.		3.6 ±1 %.	
2100	61.0 ±1 %.		35.7 ±1 %.		3.6 ±1 %.	
2300	55.5 ±1 %.		32.6 ±1 %.		3.6 ±1 %.	
2450	51.5 ±1 %.		30.4 ±1 %.		3.6 ±1 %.	



SAR REFERENCE DIPOLE CALIBRATION REPORT

Ref: ACR.60.3.21.MVGB.A

2600	48.5 ±1 %.		28.8 ±1 %.		3.6 ±1 %.	
3000	41.5 ±1 %.		25.0 ±1 %.		3.6 ±1 %.	
3500	37.0±1 %.		26.4 ±1 %.		3.6 ±1 %.	
3700	34.7±1 %.		26.4 ±1 %.		3.6 ±1 %.	

7 VALIDATION MEASUREMENT

The IEEE Std. 1528, FCC KDBs and CEI/IEC 62209 standards state that the system validation measurements must be performed using a reference dipole meeting the fore mentioned return loss and mechanical dimension requirements. The validation measurement must be performed against a liquid filled flat phantom, with the phantom constructed as outlined in the fore mentioned standards. Per the standards, the dipole shall be positioned below the bottom of the phantom, with the dipole length centered and parallel to the longest dimension of the flat phantom, with the top surface of the dipole at the described distance from the bottom surface of the phantom.

7.1 MEASUREMENT CONDITION

Software	OPENSAR V5
Phantom	SN 13/09 SAM68
Probe	SN 41/18 EPG0333
Liquid	Head Liquid Values: eps' : 40.6 sigma : 0.89
Distance between dipole center and liquid	15.0 mm
Area scan resolution	dx=8mm/dy=8mm
Zoon Scan Resolution	dx=8mm/dy=8mm/dz=5mm
Frequency	835835 MHz
Input power	20 dBm
Liquid Temperature	20 +/- 1 °C
Lab Temperature	20 +/- 1 °C
Lab Humidity	30-70 %

7.2 HEAD LIQUID MEASUREMENT

Frequency MHz	Relative permittivity (ε <sub>r</sub> )		Conductivity (σ) S/m	
	required	measured	required	measured
300	45.3 ±10 %		0.87 ±10 %	
450	43.5 ±10 %		0.87 ±10 %	
750	41.9 ±10 %		0.89 ±10 %	
835	41.5 ±10 %	40.6	0.90 ±10 %	0.89
900	41.5 ±10 %		0.97 ±10 %	
1450	40.5 ±10 %		1.20 ±10 %	
1500	40.4 ±10 %		1.23 ±10 %	
1640	40.2 ±10 %		1.31 ±10 %	
1750	40.1 ±10 %		1.37 ±10 %	
1800	40.0 ±10 %		1.40 ±10 %	
1900	40.0 ±10 %		1.40 ±10 %	
1950	40.0 ±10 %		1.40 ±10 %	
2000	40.0 ±10 %		1.40 ±10 %	



SAR REFERENCE DIPOLE CALIBRATION REPORT

Ref. ACR.60.3.21.MVGB.A

2100	39.8 ±10 %		1.49 ±10 %	
2300	39.5 ±10 %		1.67 ±10 %	
2450	39.2 ±10 %		1.80 ±10 %	
2600	39.0 ±10 %		1.96 ±10 %	
3000	38.5 ±10 %		2.40 ±10 %	
3500	37.9 ±10 %		2.91 ±10 %	

7.3 MEASUREMENT RESULT

The IEEE Std. 1528 and CEI/IEC 62209 standards state that the system validation measurements should produce the SAR values shown below (for phantom thickness of 2 mm), within the uncertainty for the system validation. All SAR values are normalized to 1 W forward power. In bracket, the measured SAR is given with the used input power.

Frequency MHz	1 g SAR (W/kg/W)		10 g SAR (W/kg/W)	
	required	measured	required	measured
300	2.85		1.94	
450	4.58		3.06	
750	8.49		5.55	
835	9.56	9.84 (0.98)	6.22	6.22 (0.62)
900	10.9		6.99	
1450	29		16	
1500	30.5		16.8	
1640	34.2		18.4	
1750	36.4		19.3	
1800	38.4		20.1	
1900	39.7		20.5	
1950	40.5		20.9	
2000	41.1		21.1	
2100	43.6		21.9	
2300	48.7		23.3	
2450	52.4		24	
2600	55.3		24.6	
3000	63.8		25.7	
3500	67.1		25	



SAR REFERENCE DIPOLE CALIBRATION REPORT

Ref. ACR.60.3.21.MVGB.A

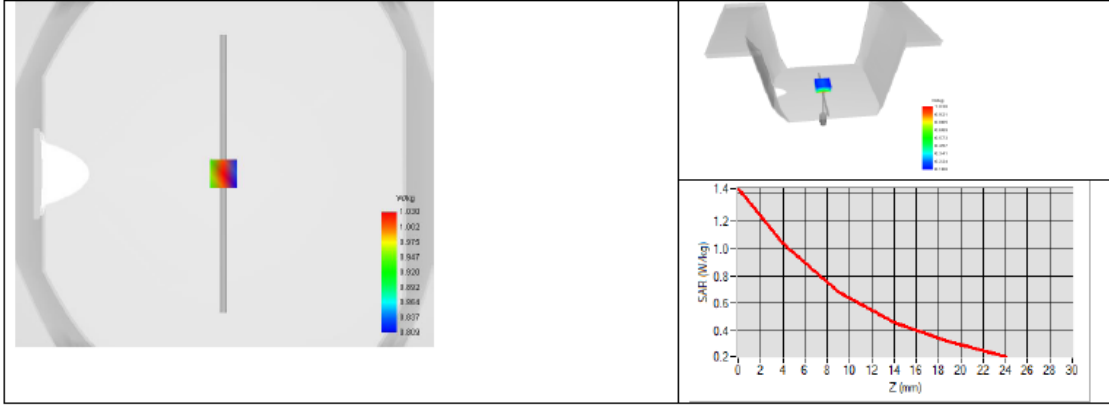



SAR REFERENCE DIPOLE CALIBRATION REPORT

Ref: ACR.60.3.21.MVGB.A

8 LIST OF EQUIPMENT

Equipment Summary Sheet				
Equipment Description	Manufacturer / Model	Identification No.	Current Calibration Date	Next Calibration Date
SAM Phantom	MVG	SN-13/09-SAM68	Validated. No cal required.	Validated. No cal required.
COMOSAR Test Bench	Version 3	NA	Validated. No cal required.	Validated. No cal required.
Network Analyzer	Rohde & Schwarz ZVM	100203	05/2019	05/2022
Network Analyzer – Calibration kit	Rohde & Schwarz ZV-Z235	101223	05/2019	05/2022
Calipers	Mitutoyo	SN 0009732	10/2019	10/2022
Reference Probe	MVG	EPGO333 SN 41/18	05/2020	05/2021
Multimeter	Keithley 2000	1160271	02/2020	02/2023
Signal Generator	Rohde & Schwarz SMB	106589	04/2019	04/2022
Amplifier	Aethercomm	SN 046	Characterized prior to test. No cal required.	Characterized prior to test. No cal required.
Power Meter	NI-USB 5680	170100013	05/2019	05/2022
Directional Coupler	Narda 4216-20	01386	Characterized prior to test. No cal required.	Characterized prior to test. No cal required.
Temperature / Humidity Sensor	Testo 184 H1	44220687	05/2020	05/2023