

7" ANDROID TABLET

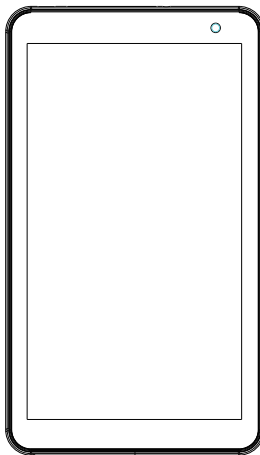

Features

Browse the Web.
Visit your favorite websites

Check your e-mail
Keep in touch with friends and family

Watch YouTube™ videos
Browse the world's most popular
video-sharing community

Read your favorite books
Download thousands of books .

Discover thousands of apps for Android™
Games, applications, and more with
play store(need for customer installed).

Connect to the Internet wirelessly
High-speed Wi-Fi 802.11 b/g/n networking

Enjoy in the comfort of your living room

Enjoy your media library anywhere
Portable powerhouse plays popular music,
video, and photo formats
microSD memory card reader
Increase your storage capacity (up to 32 GB
supported)

Built-in camera
Convenient front-facing camera 0.3MP

Automatic orientation detection
Read any way you want; the display adjusts
automatically!

Unit at a Glance

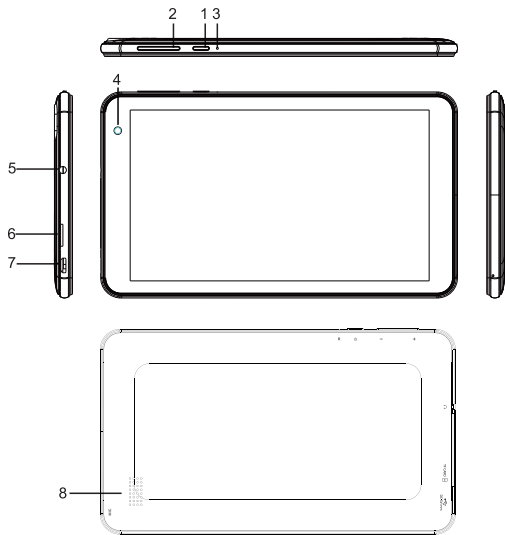

1. Power

Press to turn the unit on, or to turn the screen on or off.
Press and hold to access the Power Off menu.

2. VOL+/VOL-

Press VOL+ to increase the volume level.
Press VOL- to decrease the volume level.

3. RESET

4. front-facing camera

5. Headphone

Audio output connection for headphones.

6. MicroSD CARD

Load external microSD memory cards here.

7. USB HOST

Connect to a USB device or charge the unit.

8. Speaker

Getting Started

Turning the Tablet on or off

To turn the tablet on:

Press and hold the Power key until the LCD screen turns on. Wait until the Home screen appears; the tablet is now ready for use.

To turn the tablet off:

1. Press and hold the Power key until the Device Options menu appears.

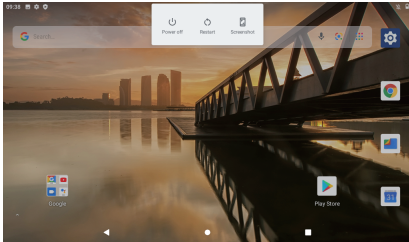

2. Touch ok the screen to turn off the tablet.

Turning the Screen On or off (Standby)

When the tablet is on, you can turn off the screen to conserve battery power. Simply press the Power key once to turn the screen off. Press the Power key again to turn the screen back on.

i To conserve battery power, the screen can be set to turn off automatically when the tablet is not in use (between 1 minute and 30 minutes). This Screen timeout option can be found in the Display menu.

Getting Started

Unlocking the Screen

When the screen turns off, you will have to unlock the screen when you turn it back on. To unlock the screen, swipe up the lock icon.

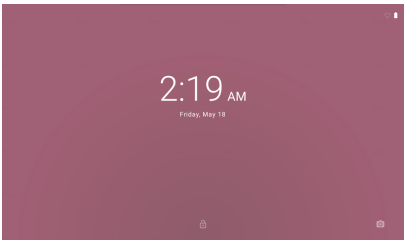

About Applications

To open an application, touch the application icon on the home screen or in the Launcher where you can tap the icon right up on the home screen to get in..

Launcher screen:

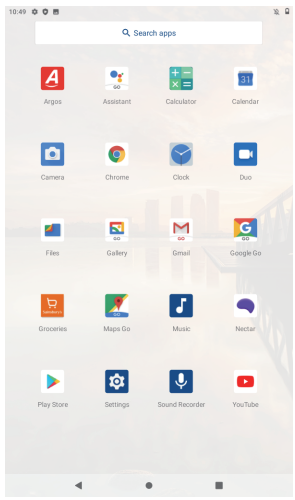

i The screen shown above is for illustrative purposes only. We reserve the right to modify and improve the final list of applications available on the tablet.

About Applications

Preinstalled Applications

Some applications have been installed on your tablet for your convenience.

These applications include:



Browse the web.



Perform simple mathematical operations.



Take pictures or videos with the camera.



Check your e-mail.



Play music.



Access the Settings menu to adjust the tablet's options.

Preinstalled Applications

Installing Applications

You can also download and install additional applications from the device's applications marketplace, the web browser, or other sources.

The tablet must be set to allow installation of applications from non-Market sources. The Unknown sources option can be set in the Application settings menu.

Connect to a Wi-Fi network

The Notification bar displays icons that indicate your tablet's Wi-Fi status.

 Notification that an open Wi-Fi network is in range.

 Connected to a Wi-Fi network (waves indicate connection strength).

[no icon] There are no Wi-Fi networks in range, or the Wi-Fi radio is off.

1. Turn on the Wi-Fi radio if it is not already on. To turn on Wi-Fi:

a. Go to the Home screen: Press the Home key.

b. Open the Settings menu: tap the icon right up on the home screen to get into the launcher, then touch Settings icon.

c. Open the Wireless & networks menu: Slide the icon to ON status.

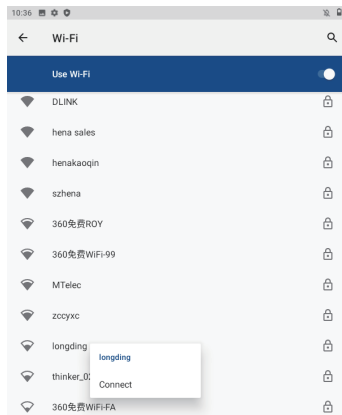

When Wi-Fi is on, the tablet will look for and display a list of available Wi-Fi networks.

 If a network that you have connected to previously is found, the tablet will connect to it. If you don't see your network in the list, you can force the tablet to re-scan. To scan for networks, tap the Menu key, and then touch Scan.

Connect to a Wi-Fi network

2. Select an available Wi-Fi network to connect to:

In the same Wi-Fi settings menu above, touch a network in the list.

If the network is open, the tablet will prompt you to confirm connection to the network. Touch Connect to confirm.

If the network is secured (as indicated by a Lock icon), the tablet will prompt you to enter a password or other credentials. Touch the Wireless password box to show the on-screen keyboard and then use it to enter the password. Touch Connect to confirm.

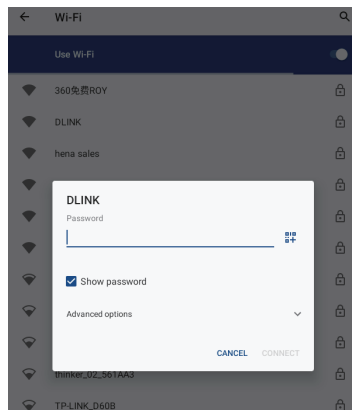

When you have successfully connected to a Wi-Fi network, the Notifications bar at the upper right of the screen will show a Wi-Fi signal indicator.

i To learn about how to add a Wi-Fi network when it is not in range or when the router is set to obscure the network name (SSID); or to configure advanced Wi-Fi options, please refer to the manual.

Optional Connections

Connecting to a Computer

Connect the tablet to a computer to transfer files.

1.Connect your tablet to the computer.

With the included USB cable: Plug the small end of the cable into the USB 2.0 high speed connector of the tablet. Plug the large end of the cable into an available USB 2.0 high speed port on the computer.

2.When your tablet is connected, slide down the USB icon then touch icon USB connected.

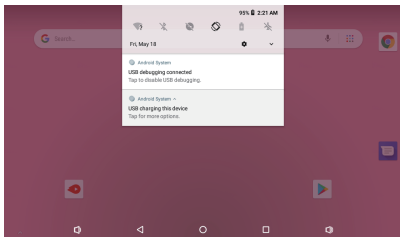

3.Mount the storage.

Touch button Transfer files(MTP) to mount the tablet's built-in storage. When it is mounted, you can copy files to or from your tablet.

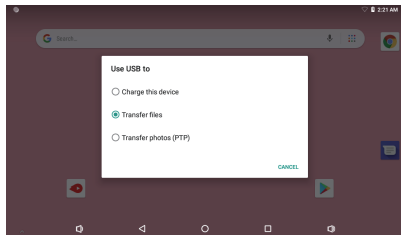

Connect to a Bluetooth device.

1)Turn on Bluetooth.

Go to Settings > Bluetooth.

2)Tap the device in the Devices list, then follow the onscreen instructions to connect to it.

The tablet must be within about 30 feet (10 meters) of the Bluetooth device



FCC Statement

1. This device complies with Part 15 of the FCC Rules. Operation is subject to the following two conditions:

(1) This device may not cause harmful interference.

(2) This device must accept any interference received, including interference that may cause undesired operation.

2. Changes or modifications not expressly approved by the party responsible for compliance could void the user's authority to operate the equipment.

NOTE:

This equipment has been tested and found to comply with the limits for a Class B digital device, pursuant to Part 15 of the FCC Rules.

These limits are designed to provide reasonable protection against harmful interference in a residential installation.

This equipment generates uses and can radiate radio frequency energy and, if not installed and used in accordance with the instructions, may cause harmful interference to radio communications. However, there is no guarantee that interference will not occur in a particular installation. If this equipment does cause harmful interference to radio or television reception, which can be determined by turning the equipment off and on, the user is encouraged to try to correct the interference by one or more of the following measures:

Reorient or relocate the receiving antenna.

Increase the separation between the equipment and receiver.

Connect the equipment into an outlet on a circuit different from that to which the receiver is connected.

Consult the dealer or an experienced radio/TV technician for help.

SAR Information Statement

Your Tablet is a radio transmitter and receiver. It is designed and manufactured not to exceed the emission limits for exposure to radiofrequency (RF) energy set by the Federal Communications Commission of the U.S. Government. These limits are part of comprehensive guidelines and establish permitted levels of RF energy for the general population. The guidelines are based on standards that were developed by independent scientific organizations through periodic and thorough evaluation of scientific studies. The standards include a substantial safety margin designed to assure the safety of all persons, regardless of age and health. The exposure standard for wireless Tablet employs a unit of measurement known as the Specific Absorption Rate, or SAR. The SAR limit set by the FCC is 1.6 W/kg. * Tests for SAR are conducted with the phone transmitting at its highest certified power level in all tested frequency bands. Although the SAR is determined at the highest certified power level, the actual SAR level of the Tablet while operating can be well below the maximum value. This is because the Tablet is designed to operate at multiple power levels so as to use only the power required to reach the network. In general, the closer you are to a wireless base station antenna, the lower the power output. Before Tablet model is available for sale to the public, it must be tested and certified to the FCC that it does not exceed the limit established by the government adopted requirement for safe exposure. The tests are performed in positions and locations (e.g., at the ear and worn on the body) as required by the FCC for each model. The highest SAR value for this Tablet when tested for use on the body, as described in this user guide, is **0.734W/Kg**(Body-worn measurements differ among Tablet models, depending upon available accessories and FCC requirements). While there may be differences between the SAR levels of various Tablet and at various positions, they all meet the government requirement for safe exposure. The FCC has granted an Equipment Authorization for this Tablet with all reported SAR levels evaluated as in compliance with the FCC RFexposure guidelines. SAR information on this model Tablet is on file with the FCC and can be found under the Display Grant section of <http://www.fcc.gov/oet/fccid> after searching on FCC ID: **ZSW-30-104** Additional information on Specific Absorption Rates (SAR) can be found on the Cellular Telecommunications Industry Association (CTIA) web-site at <http://www.wow-com.com>. * In the United States and Canada, the SAR limit for Tablet used by the public is 1.6 watts/kg (W/kg) averaged over one gram of tissue. The standard incorporates a substantial margin of safety to give additional protection for the public and to account for any variations in measurements.

Body-worn Operation

This device was tested for typical body-worn operations. To comply with RF exposure requirements, a minimum separation distance of **0mm** must be maintained between the user's body and the handset, including the antenna. Third-party belt-clips, holsters, and similar accessories used by this device should not contain any metallic components. Body-worn accessories that do not meet these requirements may not comply with RF exposure requirements and should be avoided. Use only the supplied or an approved antenna.