

Band 4, UL Channel 20350, UL Frequency 1750.0, BW 10.0, NO. RB 50, RB POS. Low, QPSK

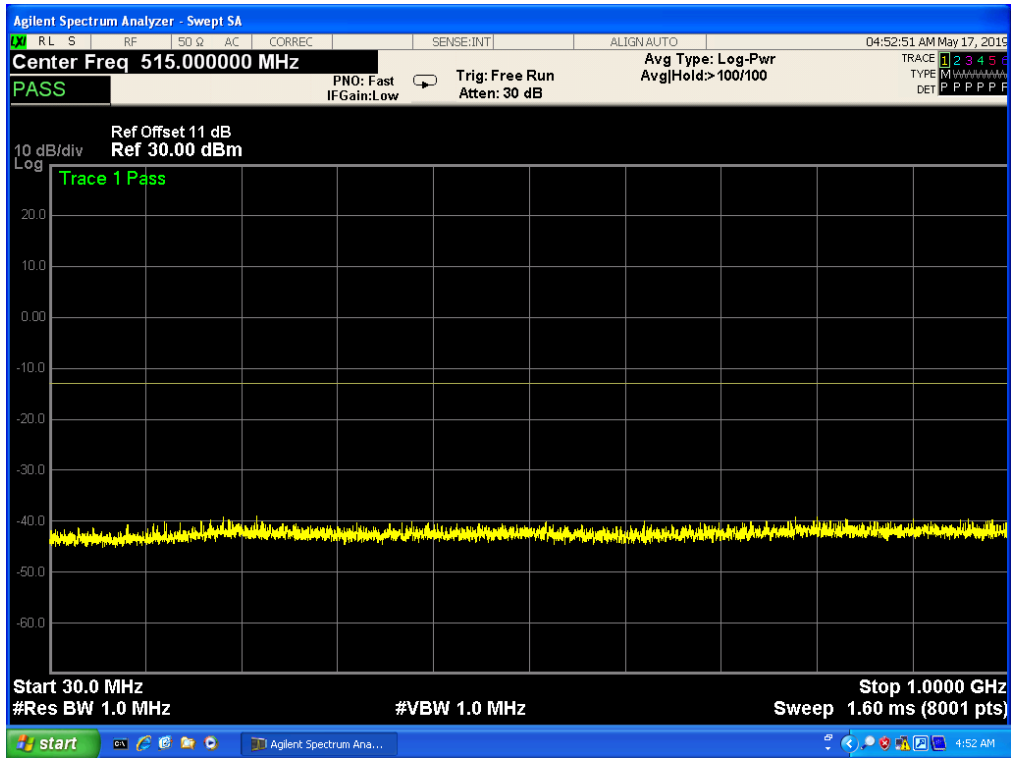

Band 4, UL Channel 20350, UL Frequency 1750.0, BW 10.0, NO. RB 50, RB POS. Low, QPSK

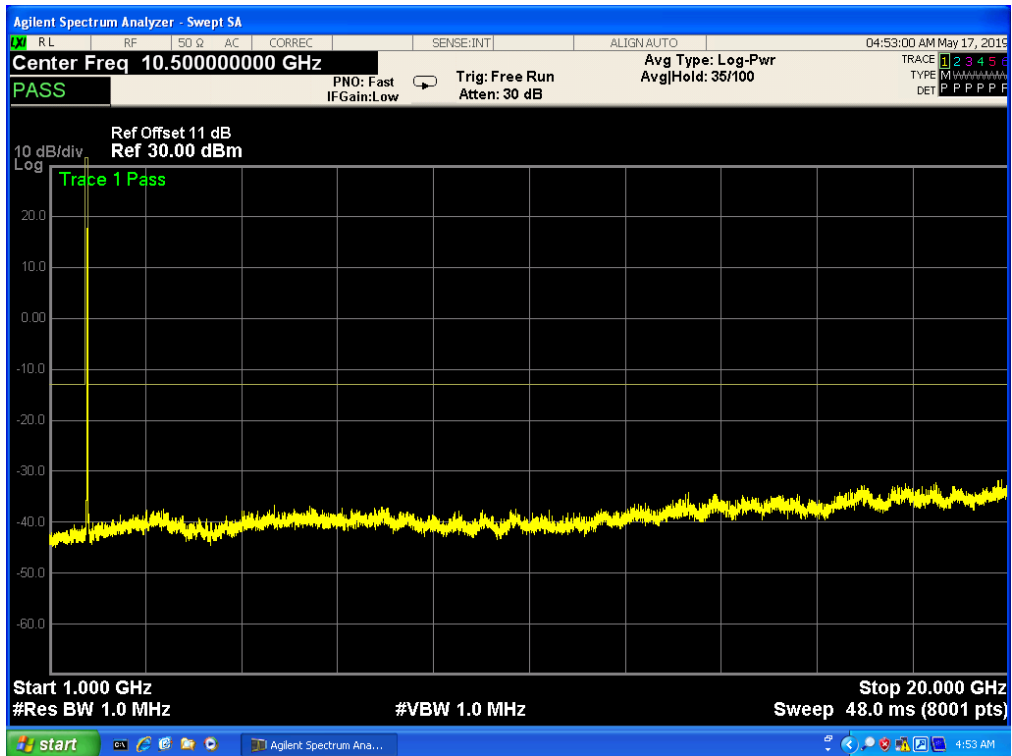

Band 4, UL Channel 20350, UL Frequency 1750.0, BW 10.0, NO. RB 50, RB POS. Low, 16-QAM

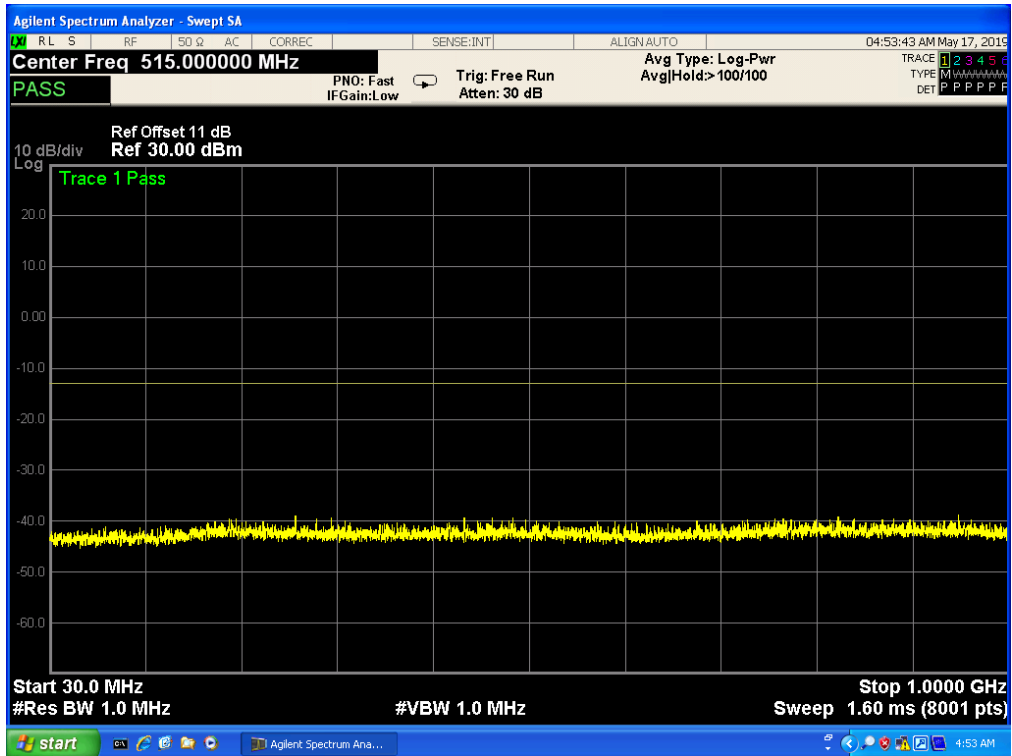

Band 4, UL Channel 20350, UL Frequency 1750.0, BW 10.0, NO. RB 50, RB POS. Low, 16-QAM

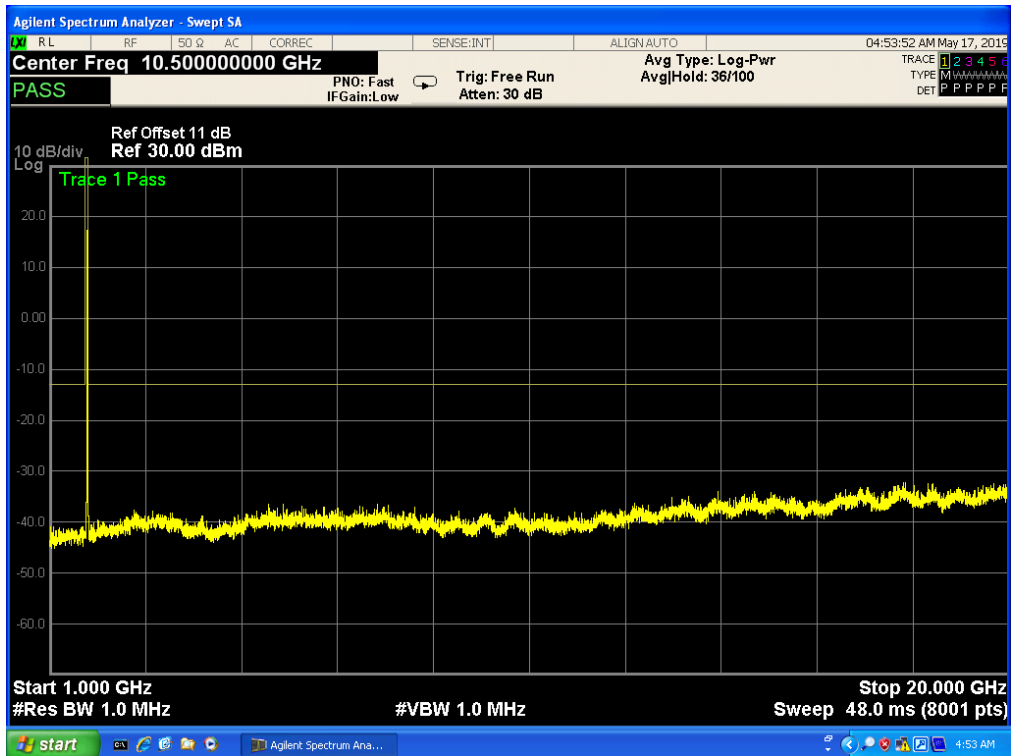

Band 4, UL Channel 20025, UL Frequency 1717.5, BW 15.0, NO. RB 75, RB POS. Low, QPSK

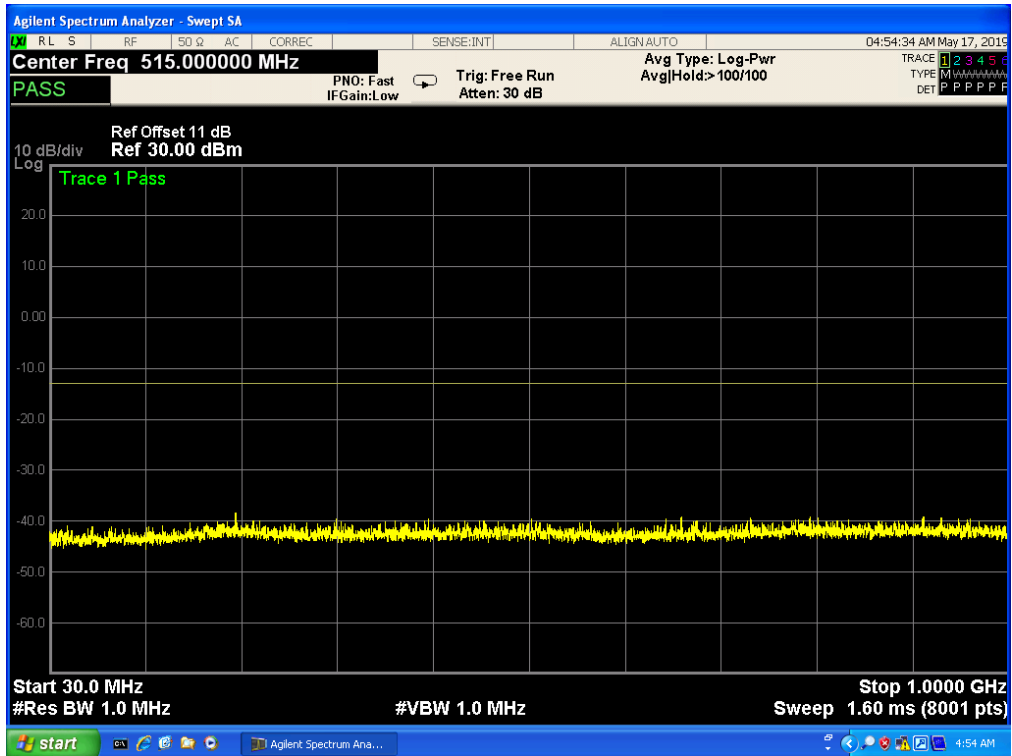

Band 4, UL Channel 20025, UL Frequency 1717.5, BW 15.0, NO. RB 75, RB POS. Low, QPSK

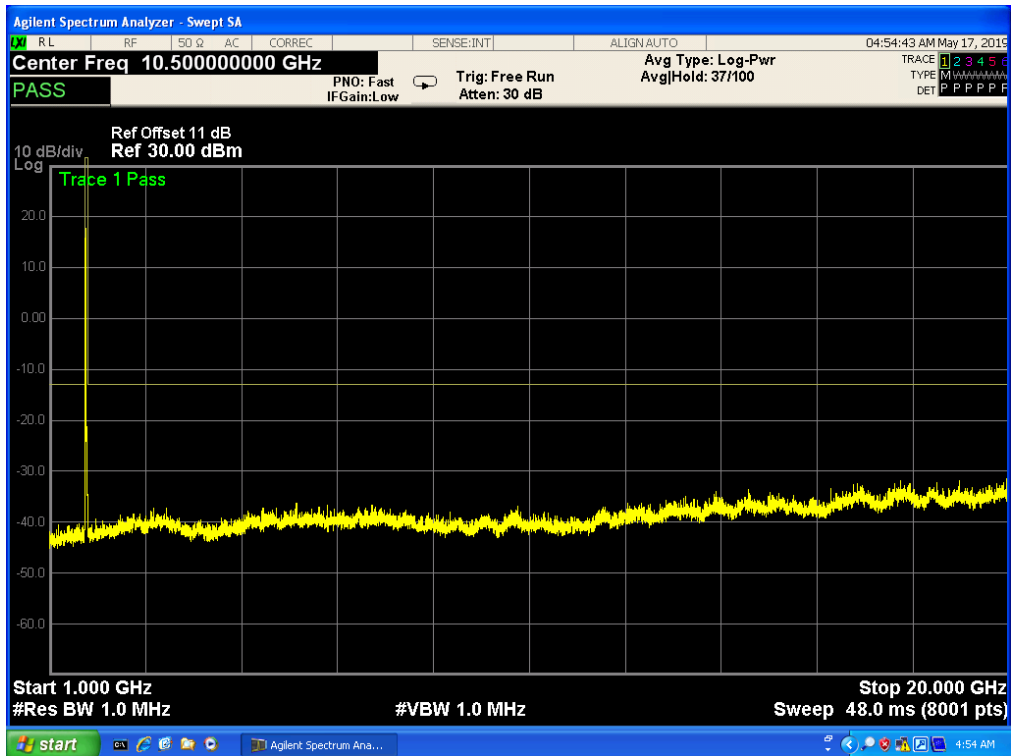

Band 4, UL Channel 20025, UL Frequency 1717.5, BW 15.0, NO. RB 75, RB POS. Low, 16-QAM

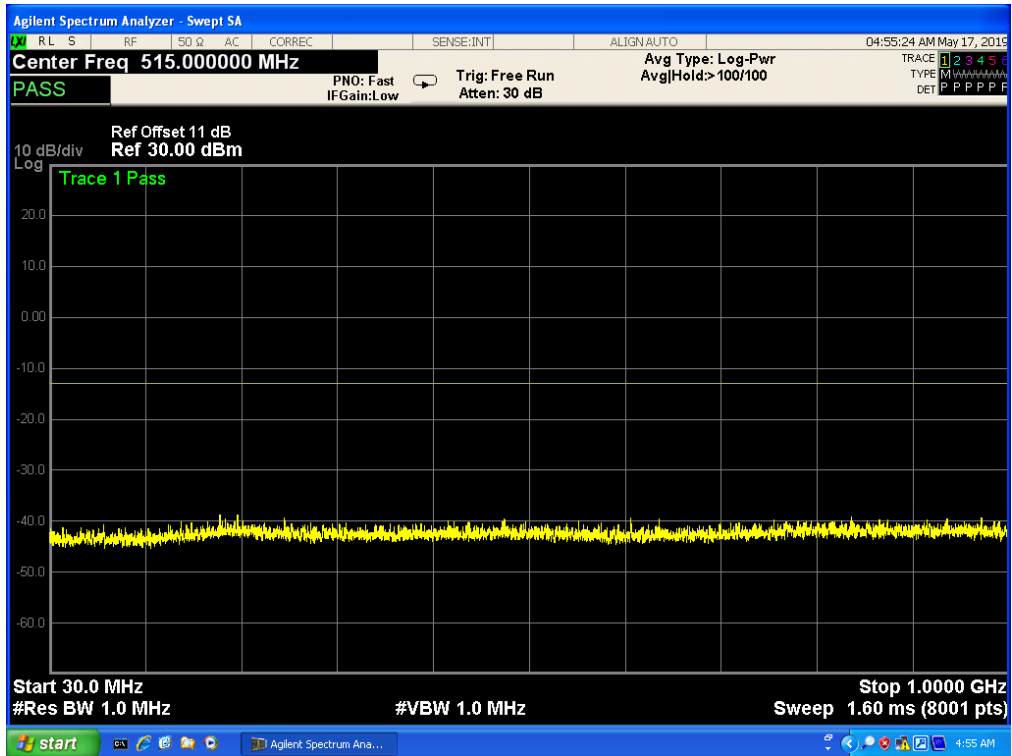

Band 4, UL Channel 20025, UL Frequency 1717.5, BW 15.0, NO. RB 75, RB POS. Low, 16-QAM

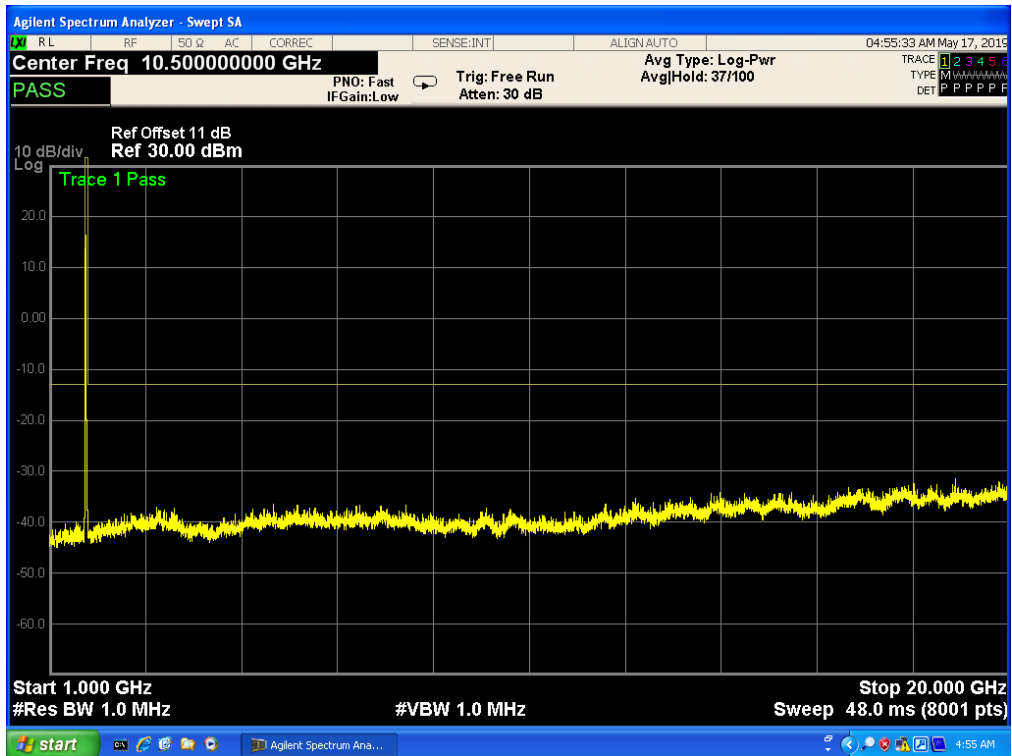

Band 4, UL Channel 20325, UL Frequency 1747.5, BW 15.0, NO. RB 75, RB POS. Low, QPSK

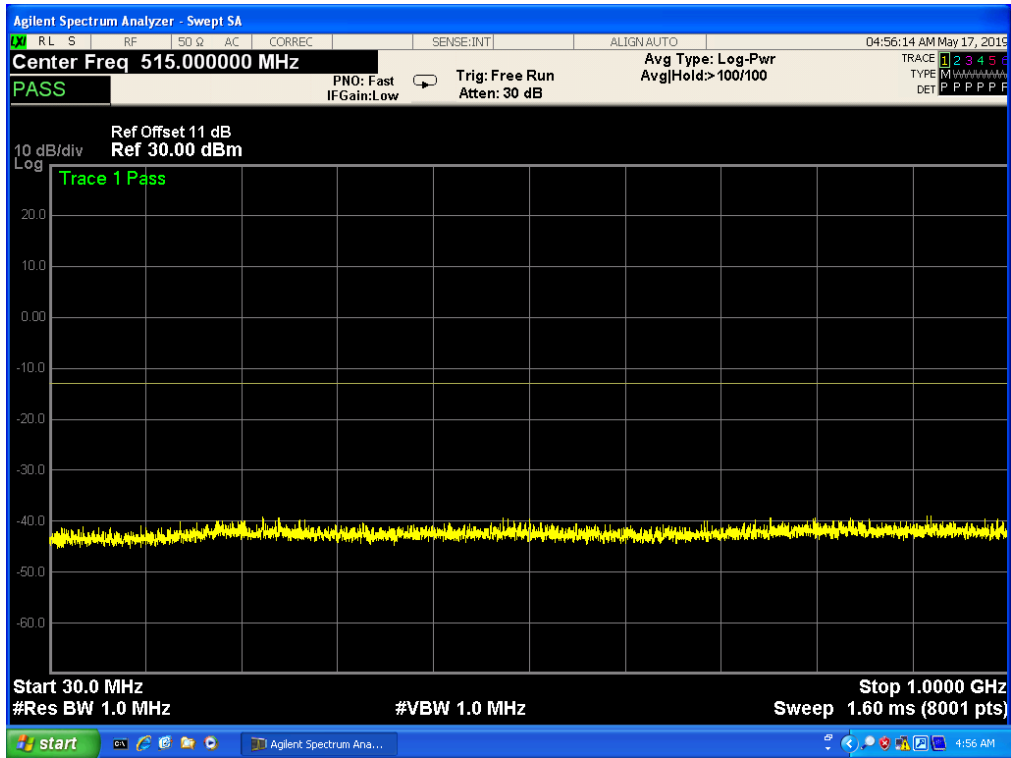

Band 4, UL Channel 20325, UL Frequency 1747.5, BW 15.0, NO. RB 75, RB POS. Low, QPSK

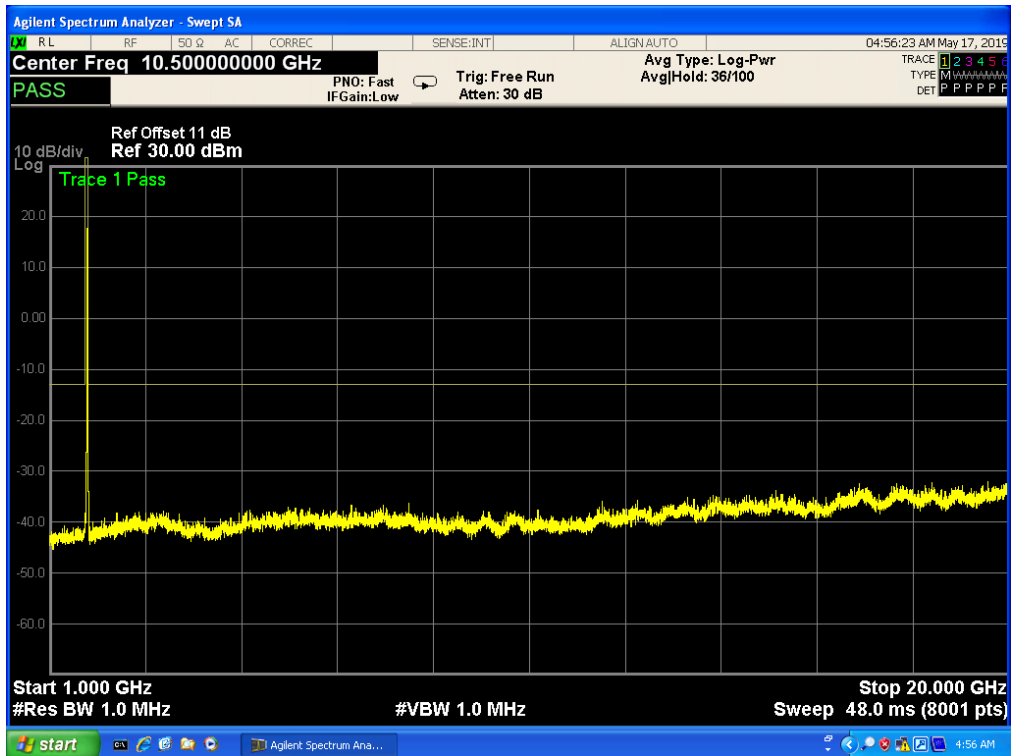

Band 4, UL Channel 20325, UL Frequency 1747.5, BW 15.0, NO. RB 75, RB POS. Low, 16-QAM

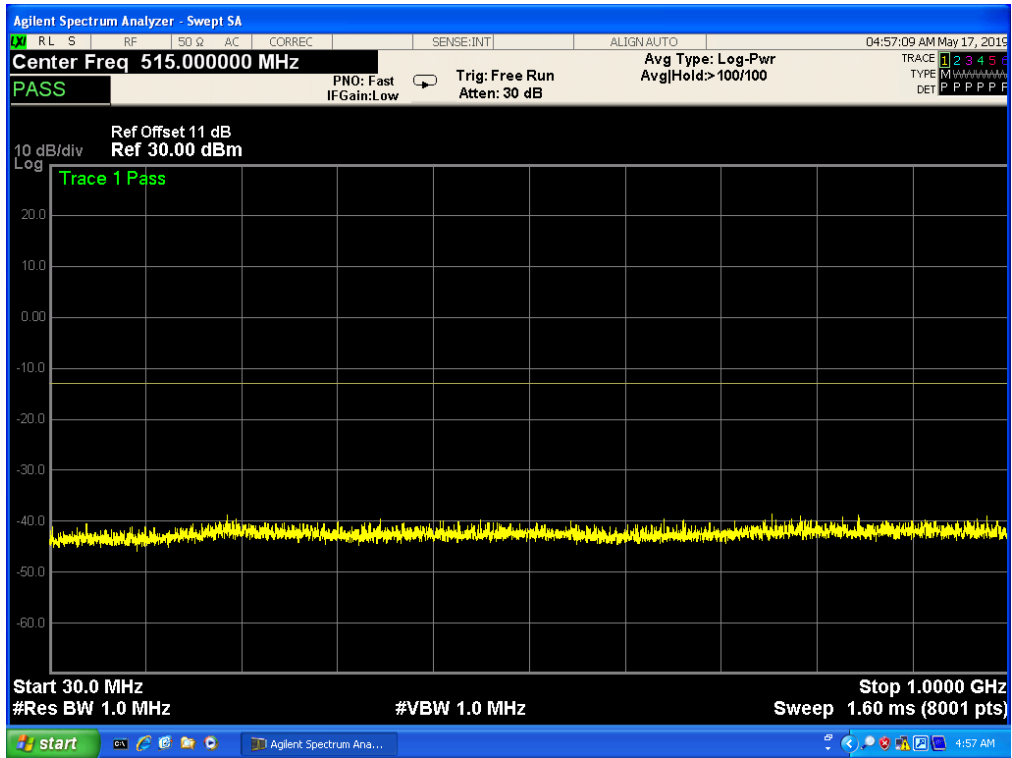

Band 4, UL Channel 20325, UL Frequency 1747.5, BW 15.0, NO. RB 75, RB POS. Low, 16-QAM

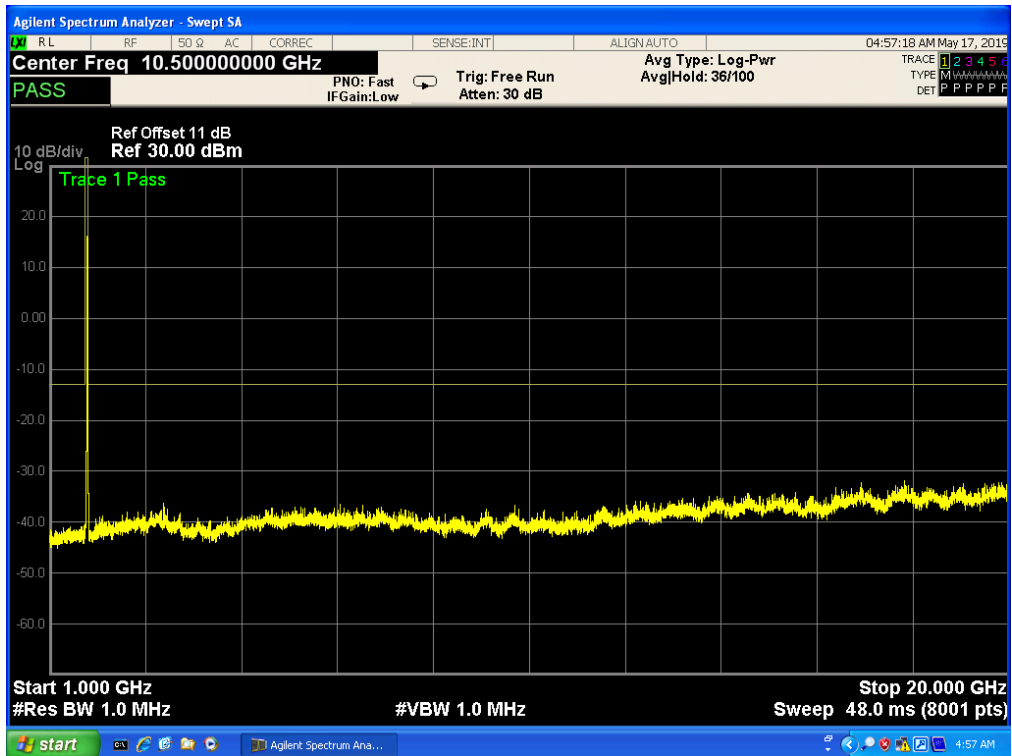

Band 4, UL Channel 20050, UL Frequency 1720.0, BW 20.0, NO. RB 100, RB POS. Low, QPSK

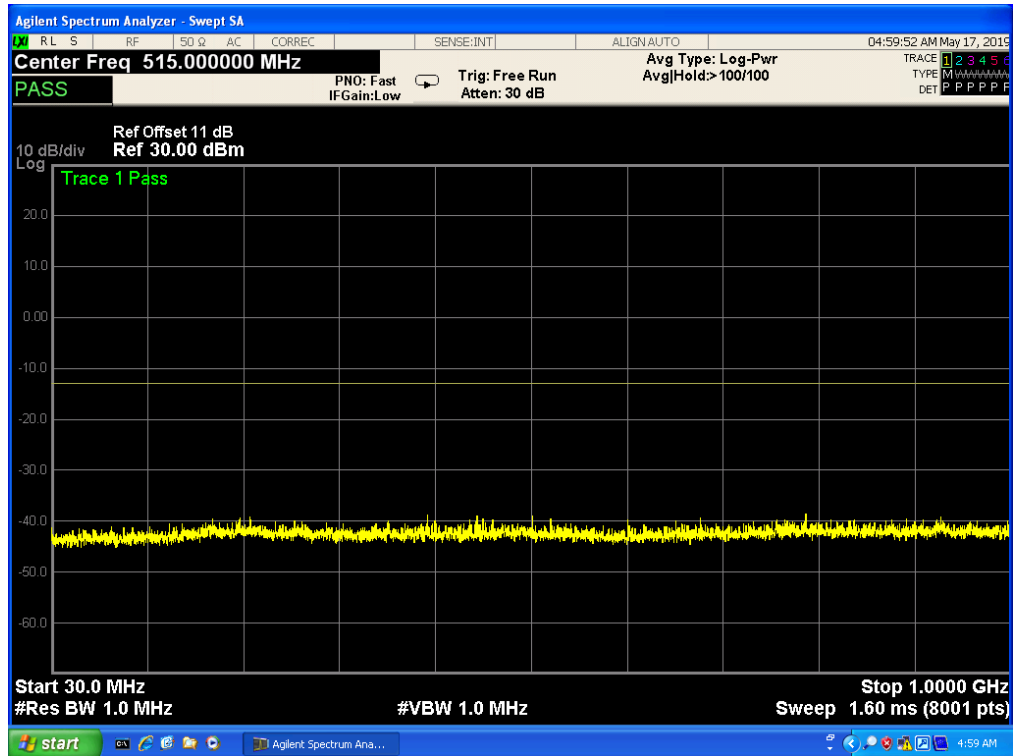

Band 4, UL Channel 20050, UL Frequency 1720.0, BW 20.0, NO. RB 100, RB POS. Low, QPSK

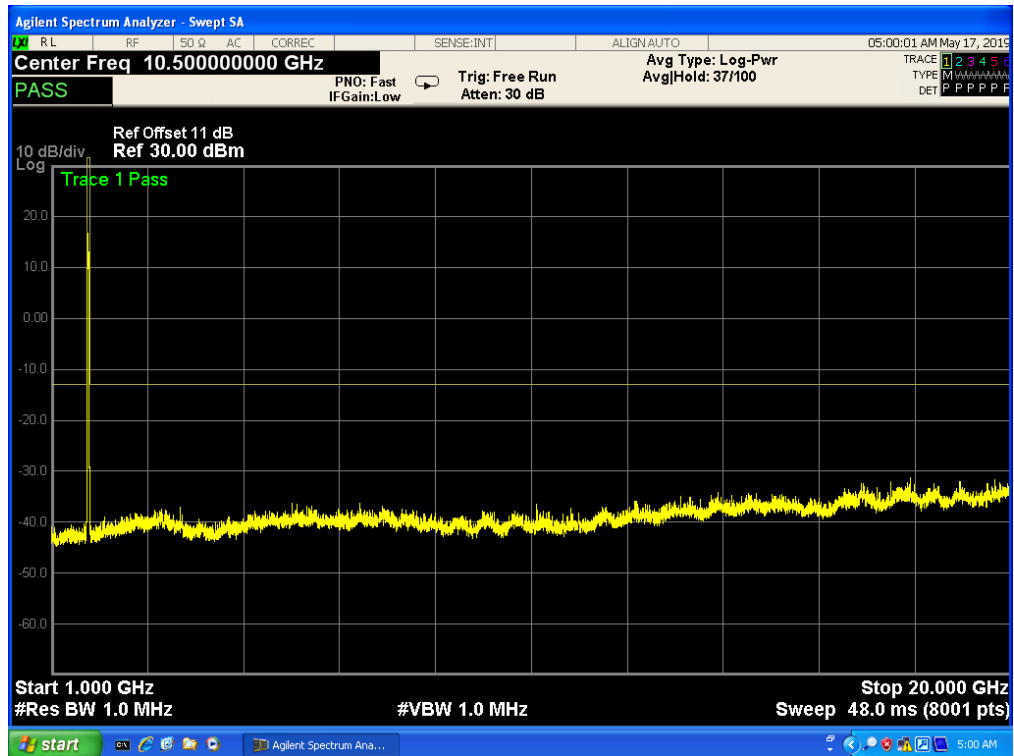

Band 4, UL Channel 20050, UL Frequency 1720.0, BW 20.0, NO. RB 100, RB POS. Low, 16QAM

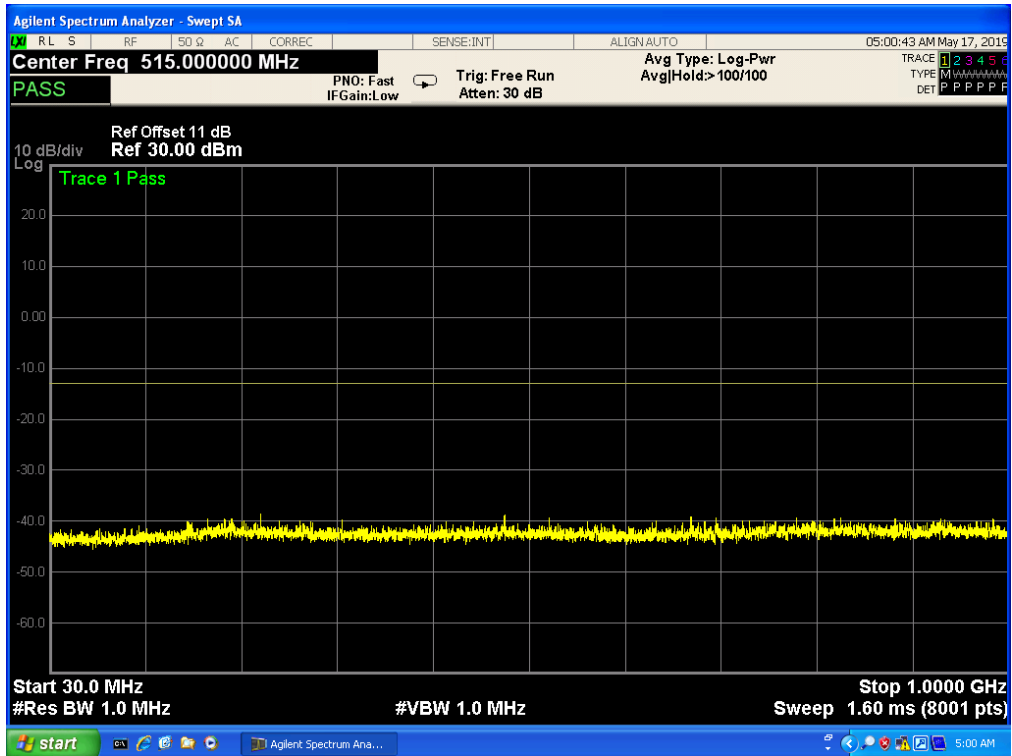

Band 4, UL Channel 20050, UL Frequency 1720.0, BW 20.0, NO. RB 100, RB POS. Low, 16QAM

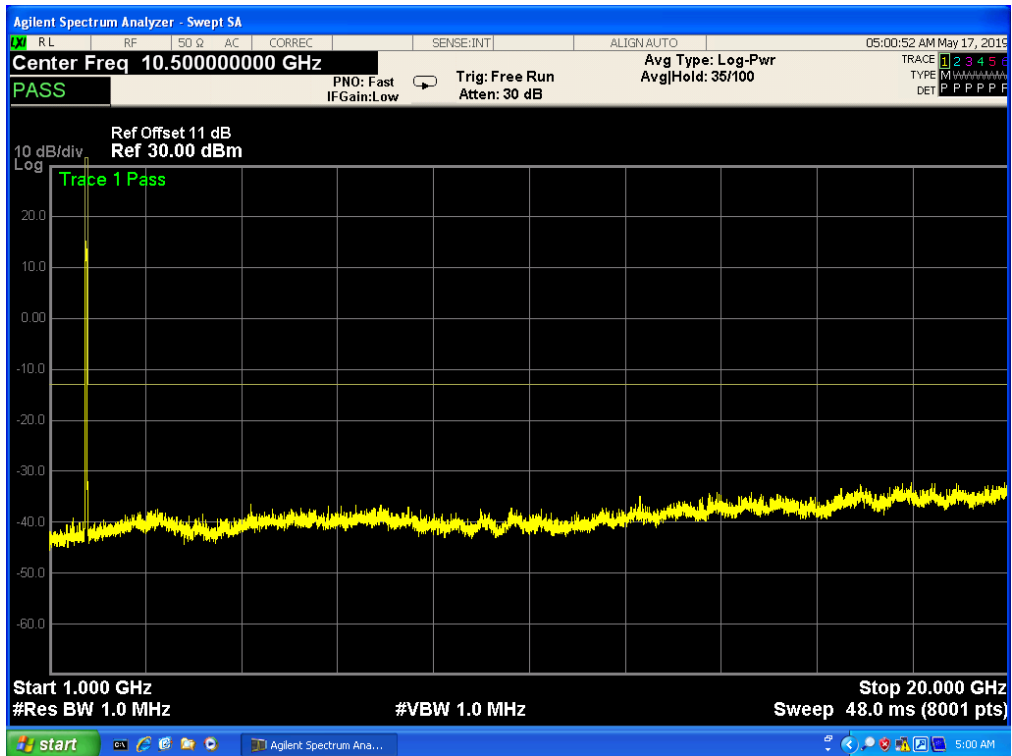

Band 4, UL Channel 20300, UL Frequency 1745.0, BW 20.0, NO. RB 100, RB POS. Low, QPSK

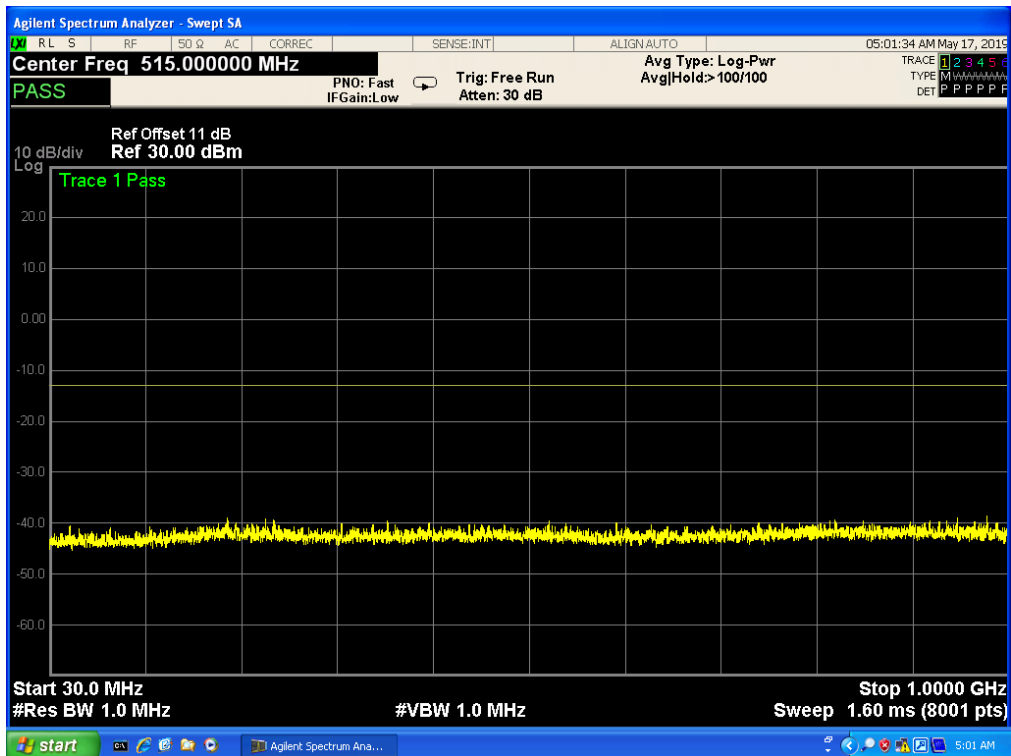

Band 4, UL Channel 20300, UL Frequency 1745.0, BW 20.0, NO. RB 100, RB POS. Low, QPSK

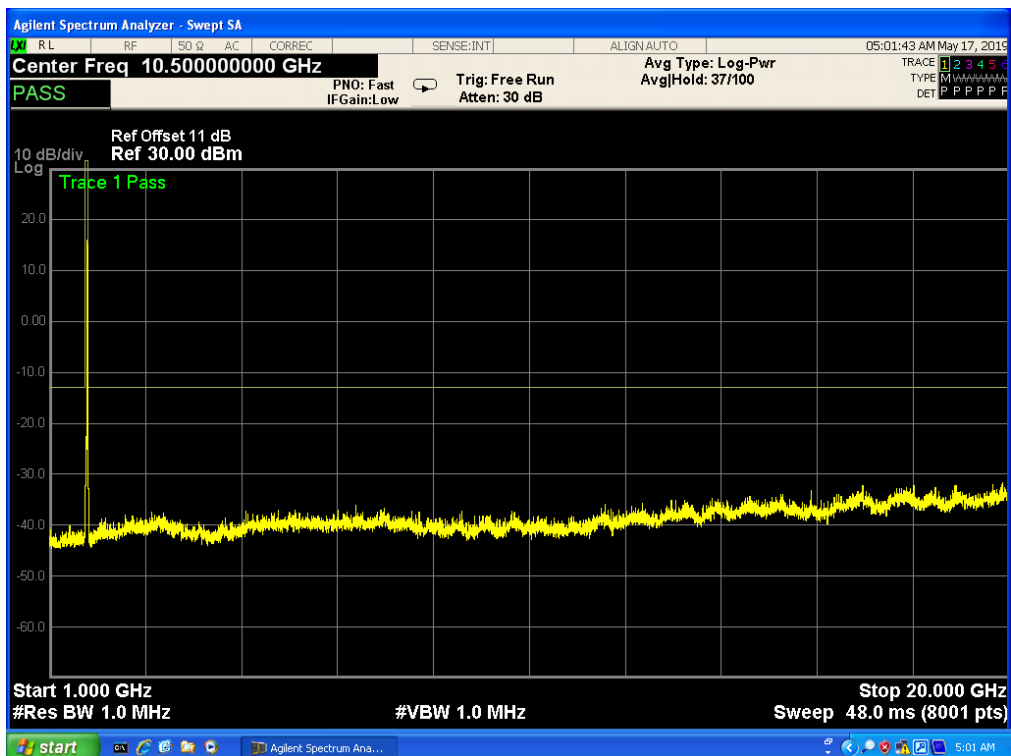

Band 4, UL Channel 20300, UL Frequency 1745.0, BW 20.0, NO. RB 100, RB POS. Low, 16-QAM

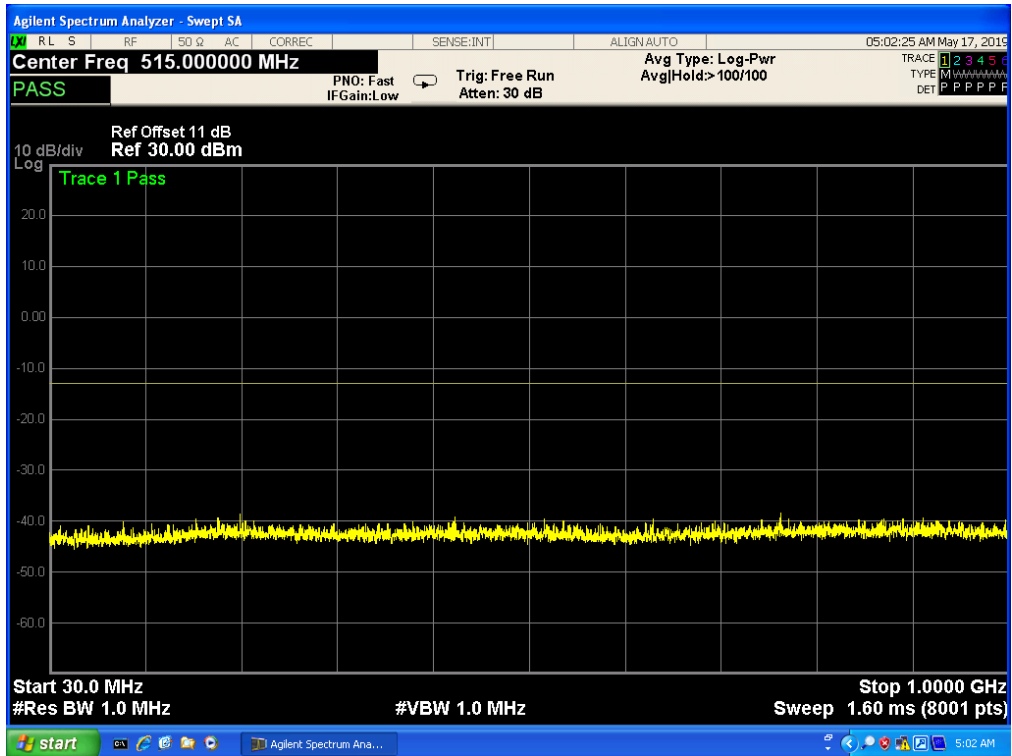

Band 4, UL Channel 20300, UL Frequency 1745.0, BW 20.0, NO. RB 100, RB POS. Low, 16-QAM

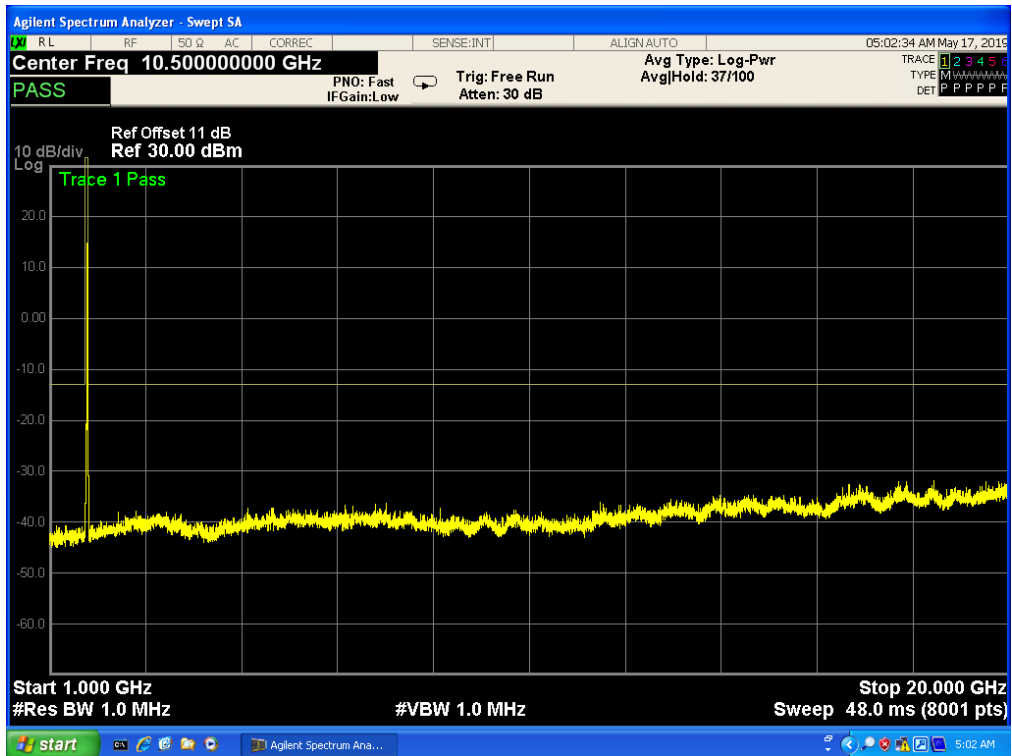

7.3 LTE BAND 5

Band 5, UL Channel 20407, UL Frequency 824.7, BW 1.4, NO. RB 6, RB POS. Low, QPSK

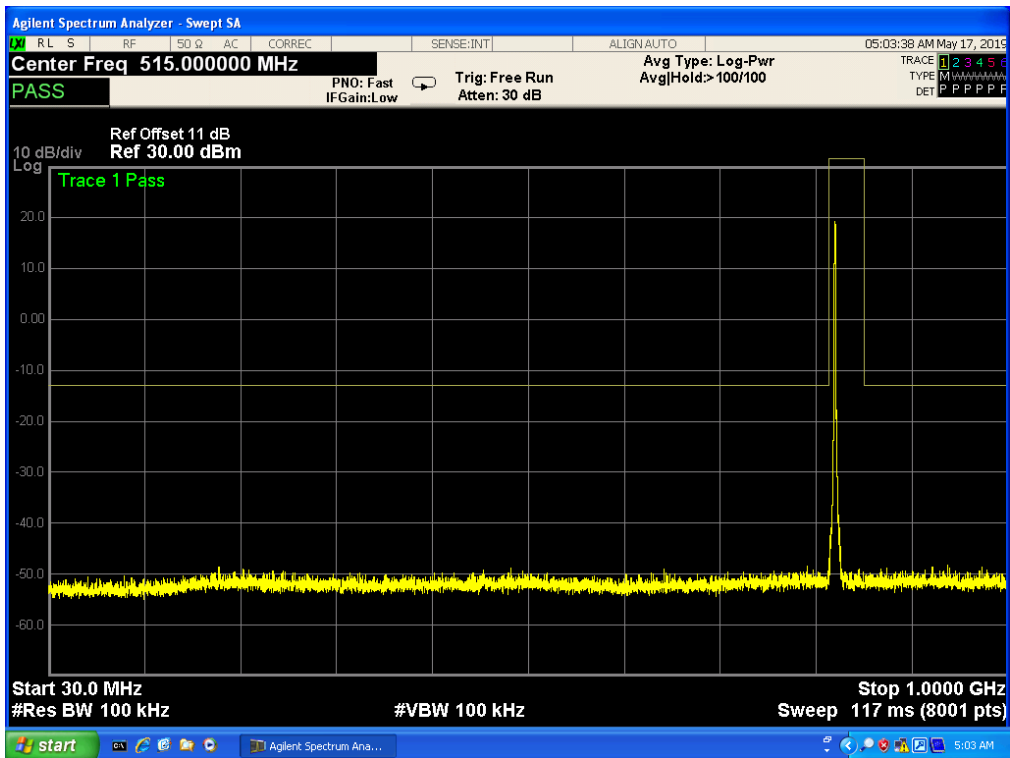

Band 5, UL Channel 20407, UL Frequency 824.7, BW 1.4, NO. RB 6, RB POS. Low, QPSK

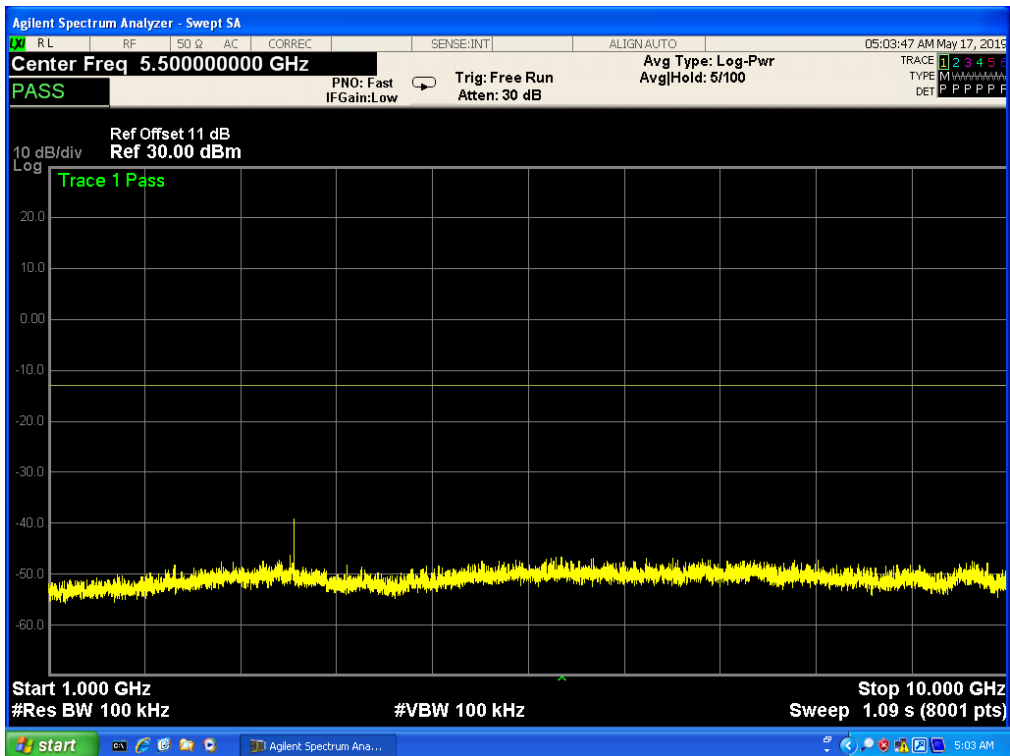

Band 5, UL Channel 20407, UL Frequency 824.7, BW 1.4, NO. RB 6, RB POS. Low, 16-QAM

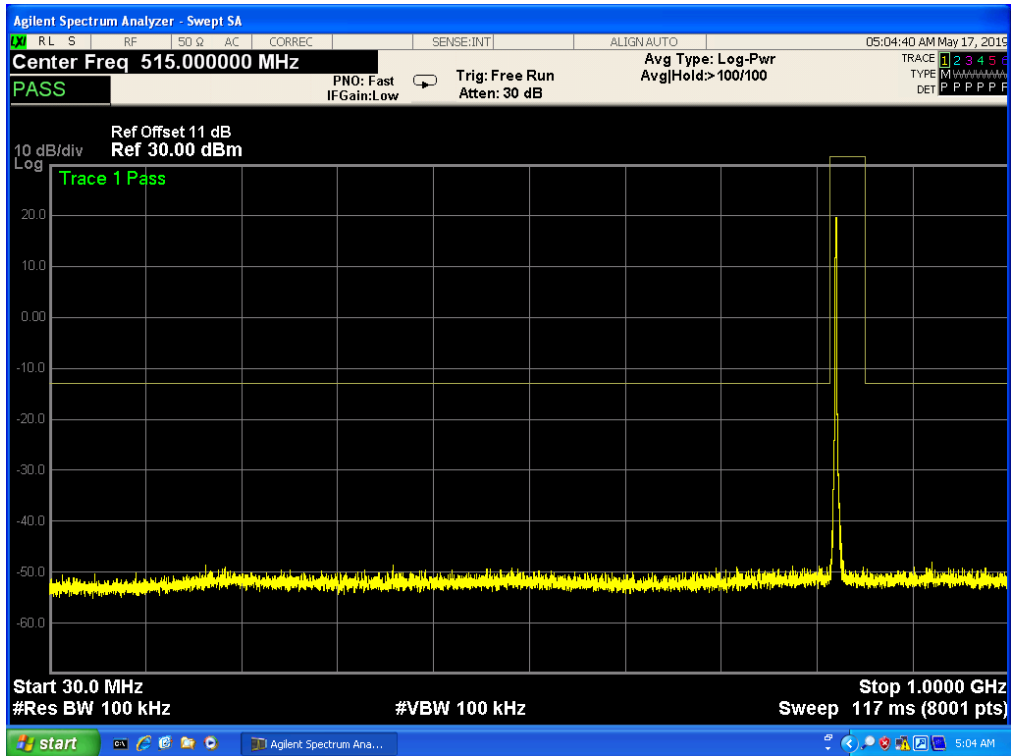

Band 5, UL Channel 20407, UL Frequency 824.7, BW 1.4, NO. RB 6, RB POS. Low, 16-QAM

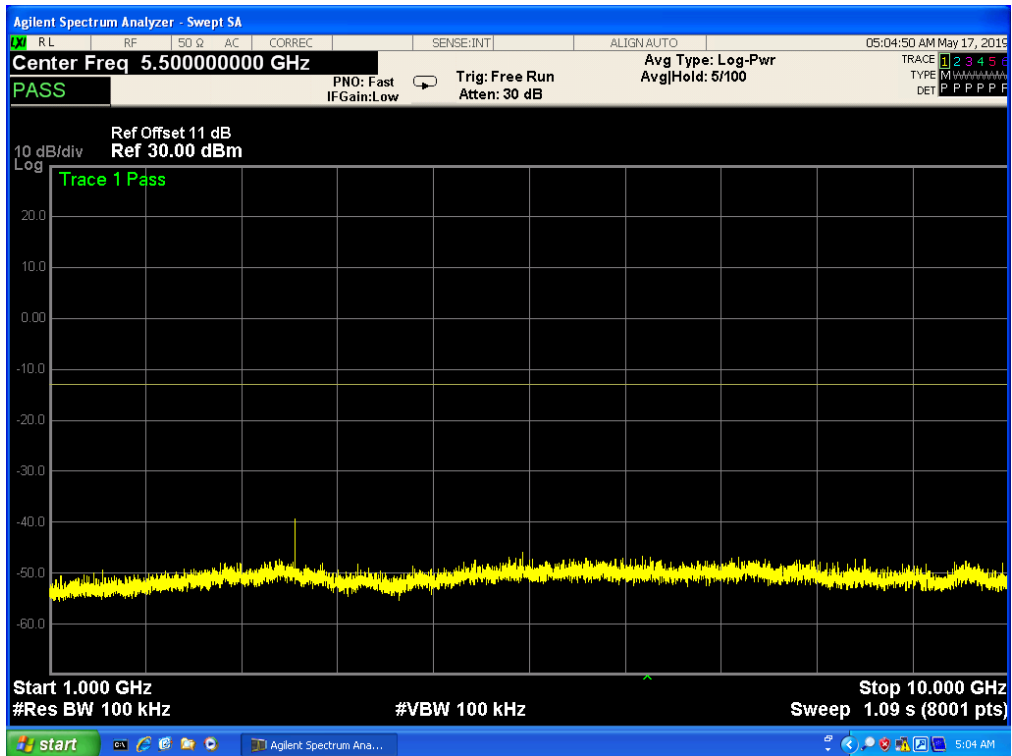

Band 5, UL Channel 20643, UL Frequency 848.3, BW 1.4, NO. RB 6, RB POS. Low, QPSK

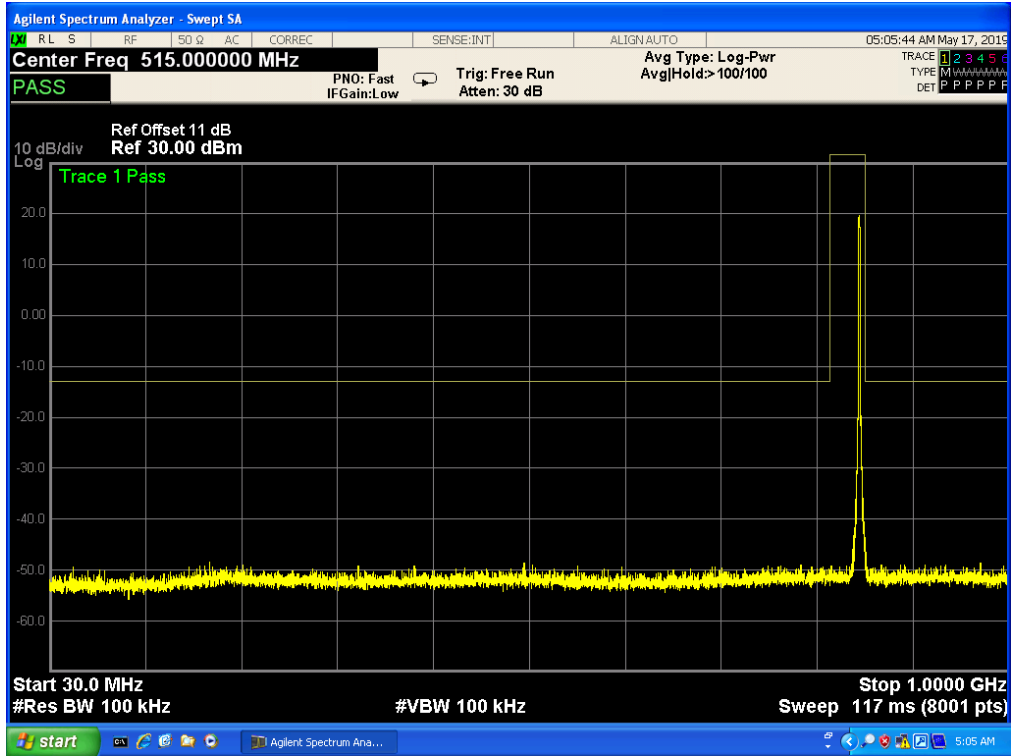

Band 5, UL Channel 20643, UL Frequency 848.3, BW 1.4, NO. RB 6, RB POS. Low, QPSK

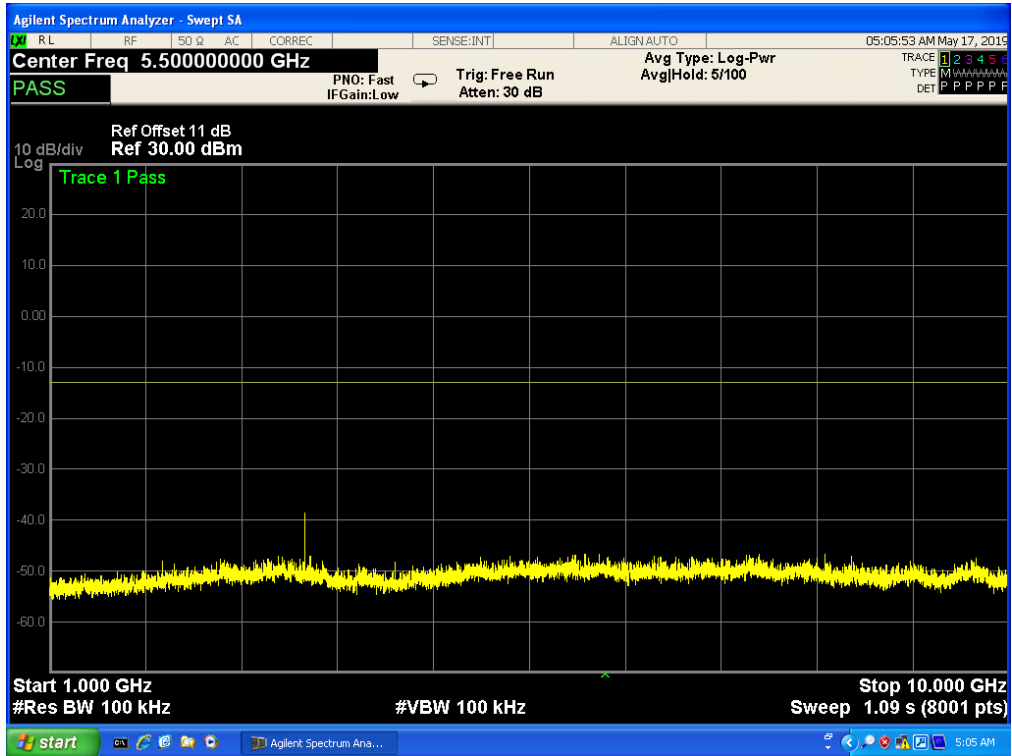

Band 5, UL Channel 20643, UL Frequency 848.3, BW 1.4, NO. RB 6, RB POS. Low, 16-QAM

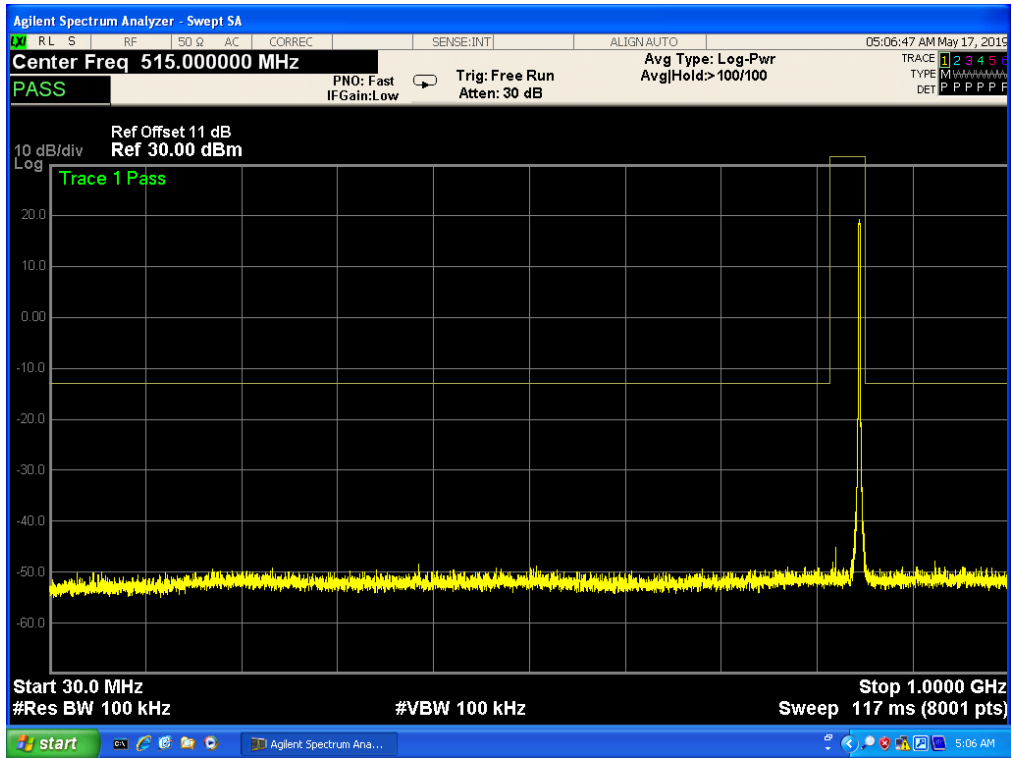

Band 5, UL Channel 20643, UL Frequency 848.3, BW 1.4, NO. RB 6, RB POS. Low, 16-QAM

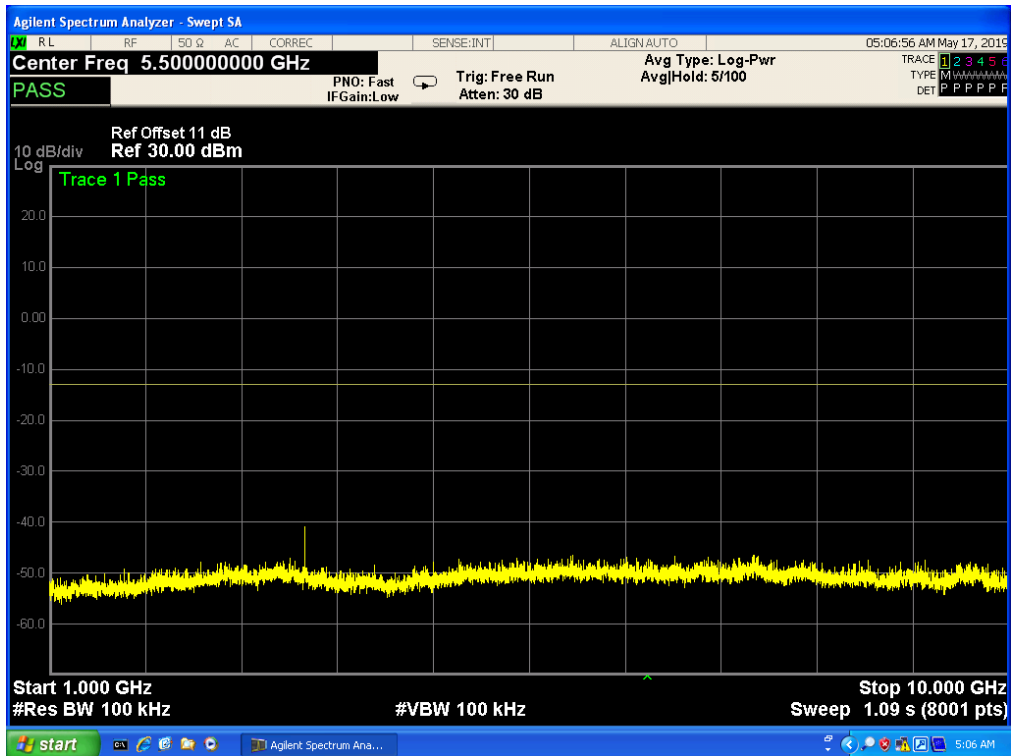

Band 5, UL Channel 20415, UL Frequency 825.5, BW 3.0, NO. RB 15, RB POS. Low, QPSK

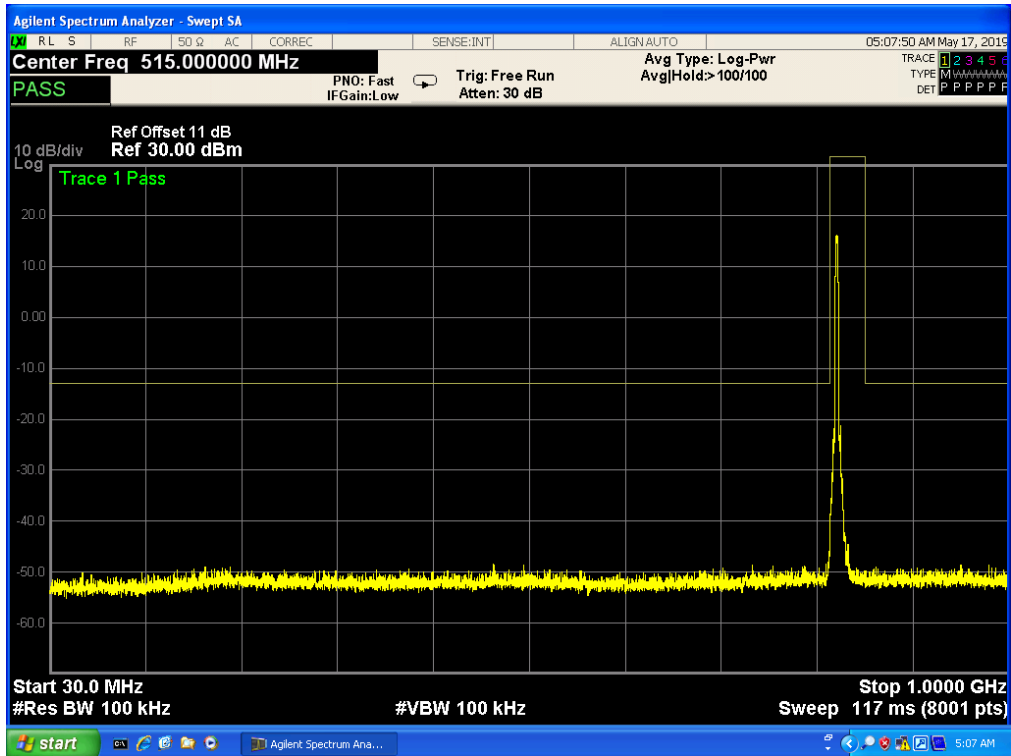

Band 5, UL Channel 20415, UL Frequency 825.5, BW 3.0, NO. RB 15, RB POS. Low, QPSK

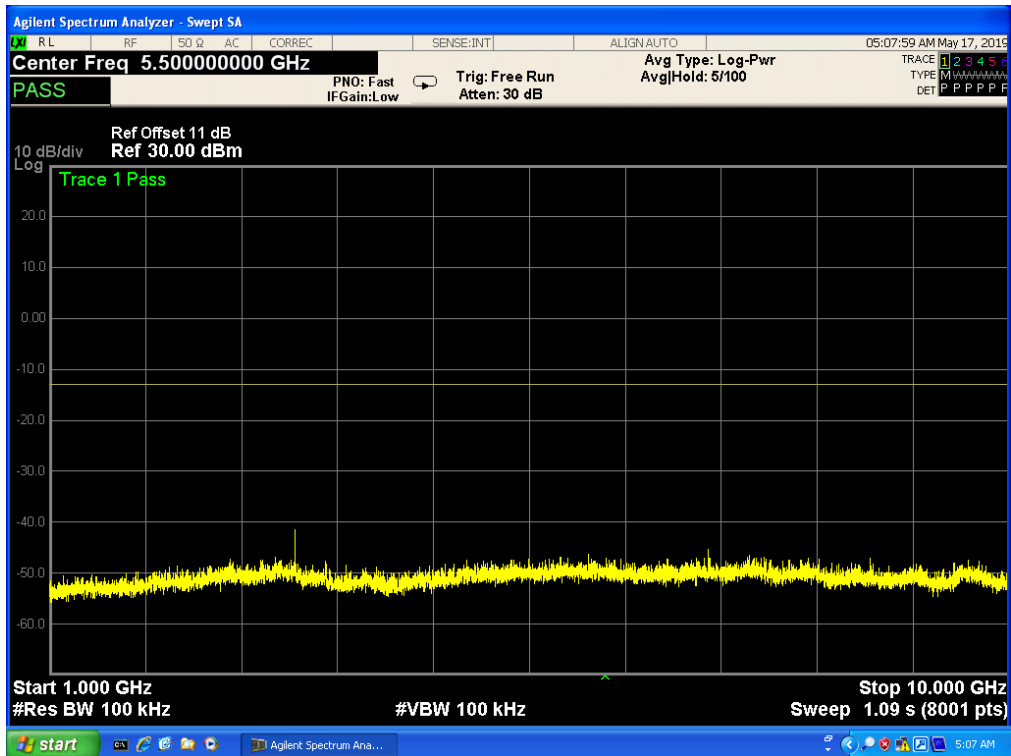

Band 5, UL Channel 20415, UL Frequency 825.5, BW 3.0, NO. RB 15, RB POS. Low, 16-QAM

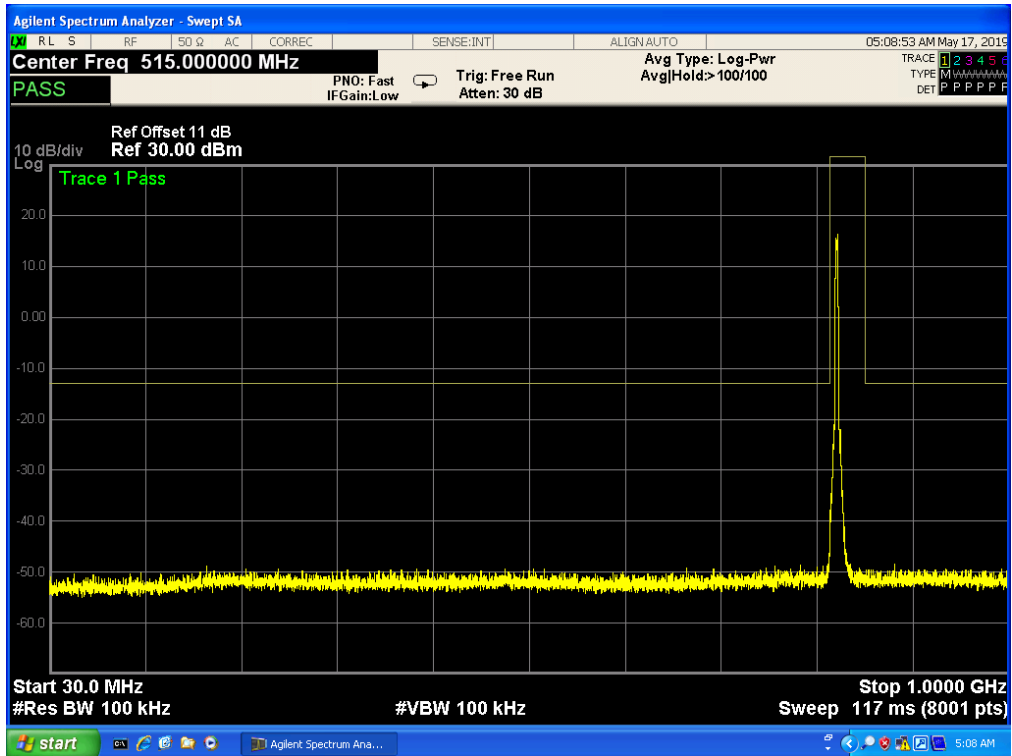

Band 5, UL Channel 20415, UL Frequency 825.5, BW 3.0, NO. RB 15, RB POS. Low, 16-QAM

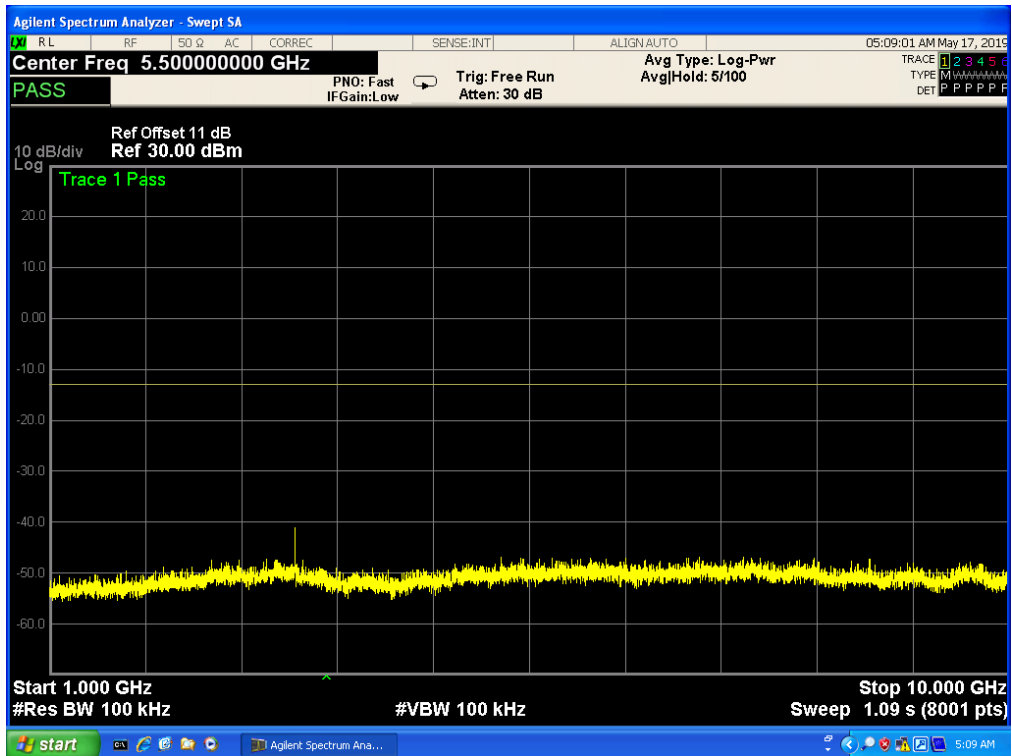

Band 5, UL Channel 20635, UL Frequency 847.5, BW 3.0, NO. RB 15, RB POS. Low, QPSK

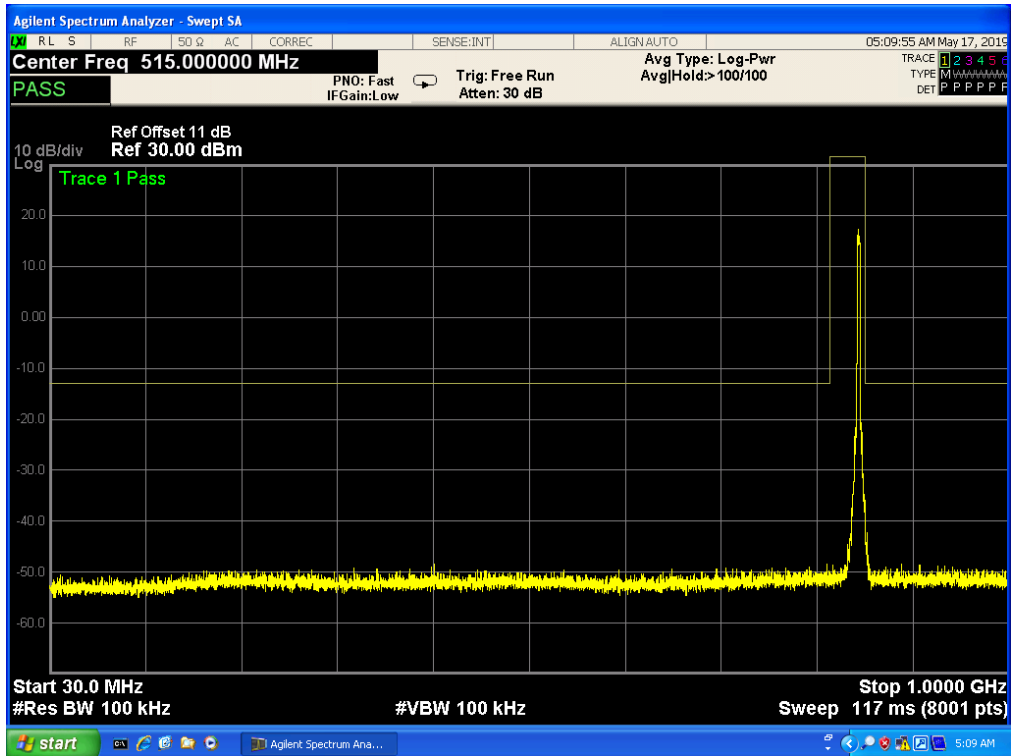

Band 5, UL Channel 20635, UL Frequency 847.5, BW 3.0, NO. RB 15, RB POS. Low, QPSK

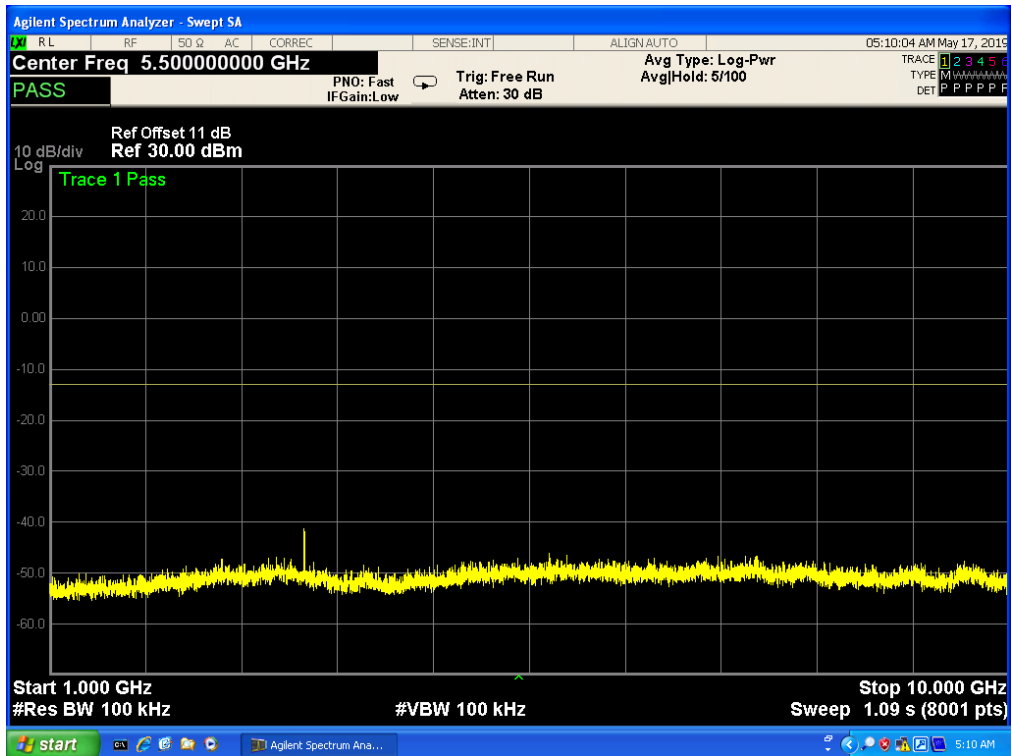

Band 5, UL Channel 20635, UL Frequency 847.5, BW 3.0, NO. RB 15, RB POS. Low, 16-QAM

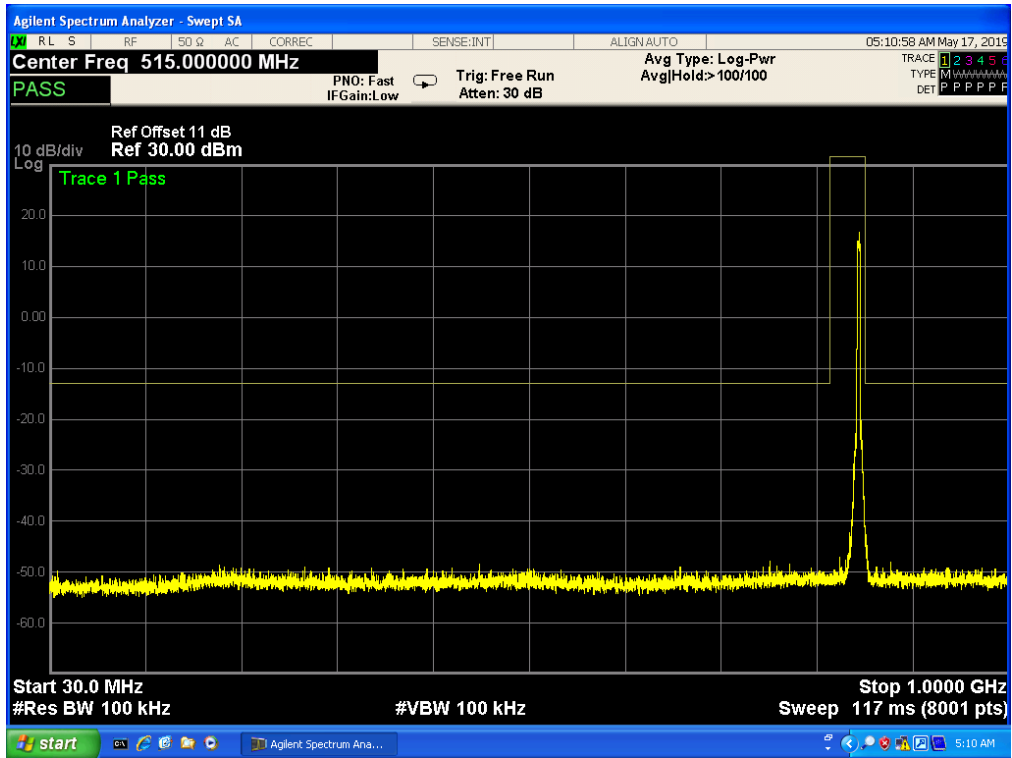

Band 5, UL Channel 20635, UL Frequency 847.5, BW 3.0, NO. RB 15, RB POS. Low, 16-QAM

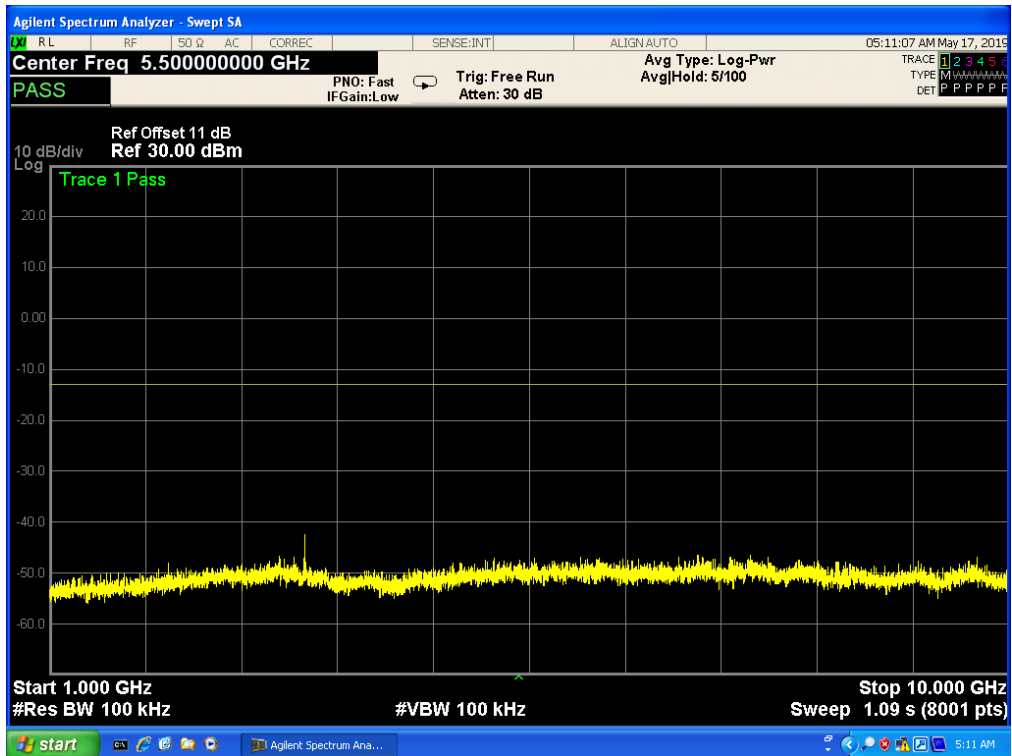

Band 5, UL Channel 20425, UL Frequency 826.5, BW 5.0, NO. RB 25, RB POS. Low, QPSK

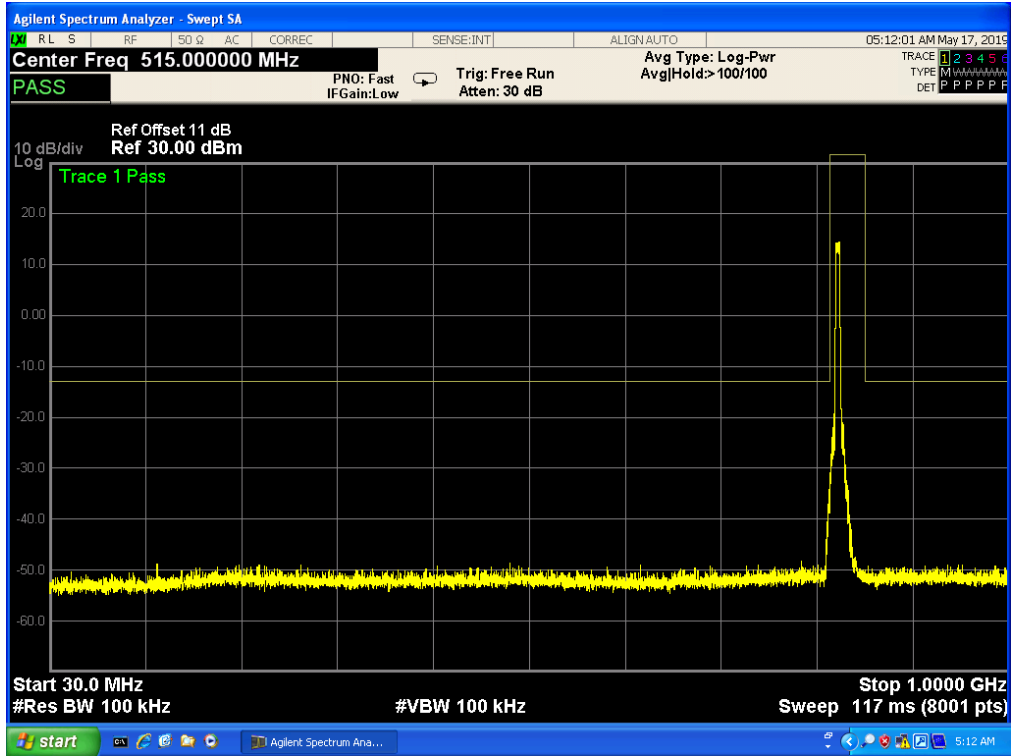

Band 5, UL Channel 20425, UL Frequency 826.5, BW 5.0, NO. RB 25, RB POS. Low, QPSK

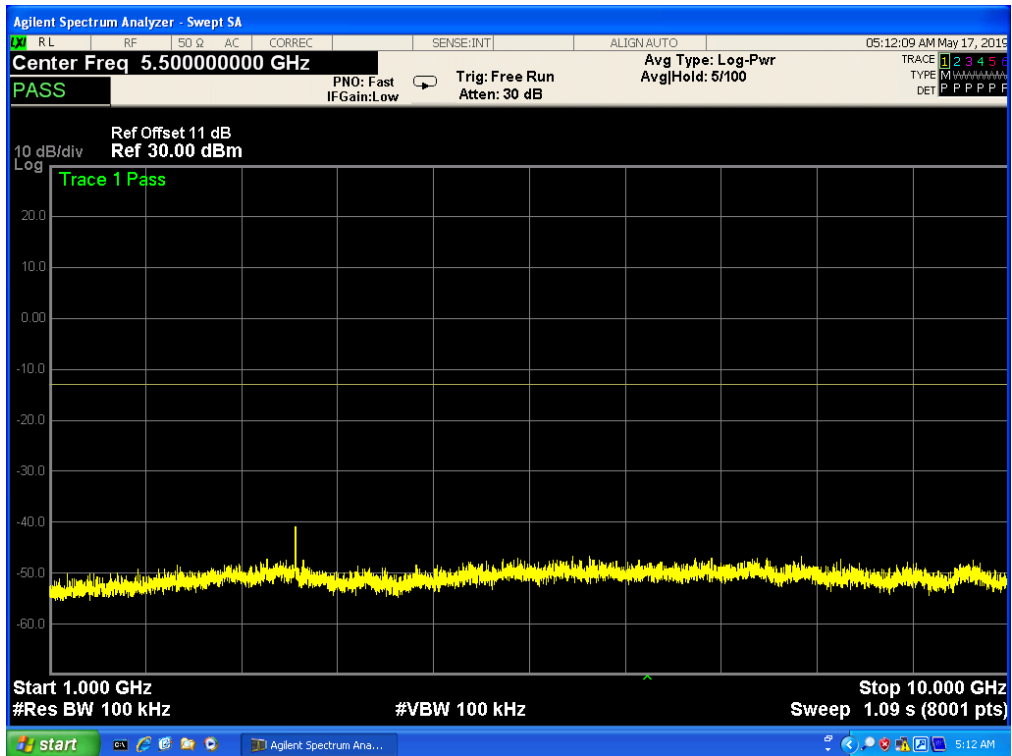

Band 5, UL Channel 20425, UL Frequency 826.5, BW 5.0, NO. RB 25, RB POS. Low, 16-QAM

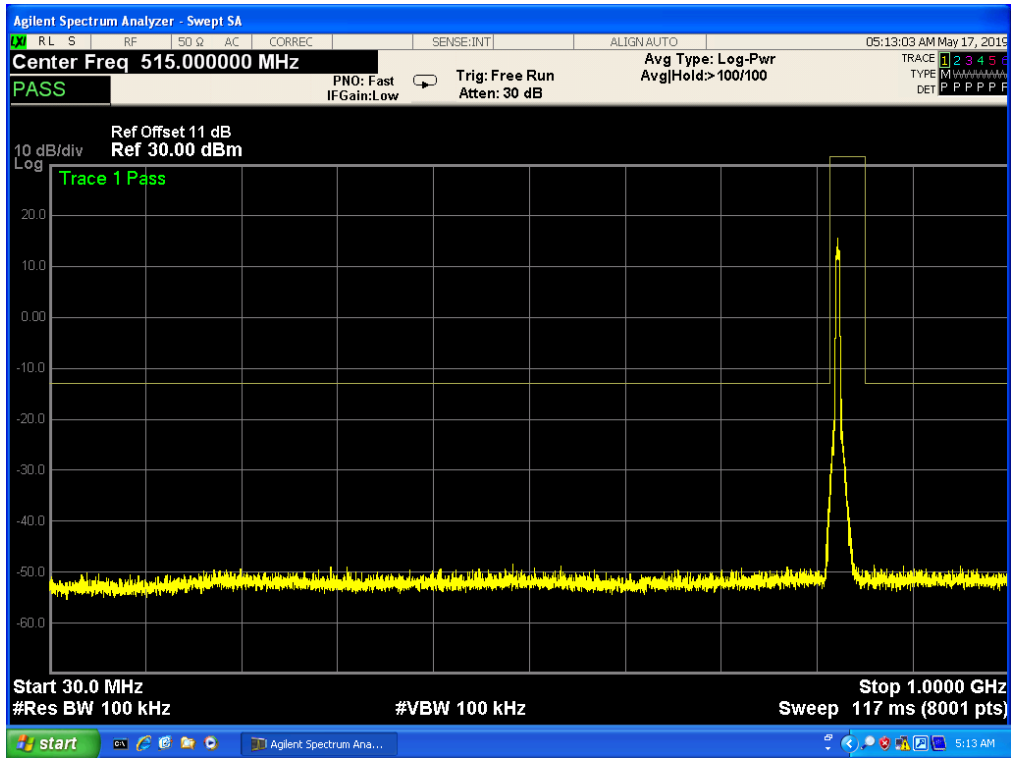

Band 5, UL Channel 20425, UL Frequency 826.5, BW 5.0, NO. RB 25, RB POS. Low, 16-QAM

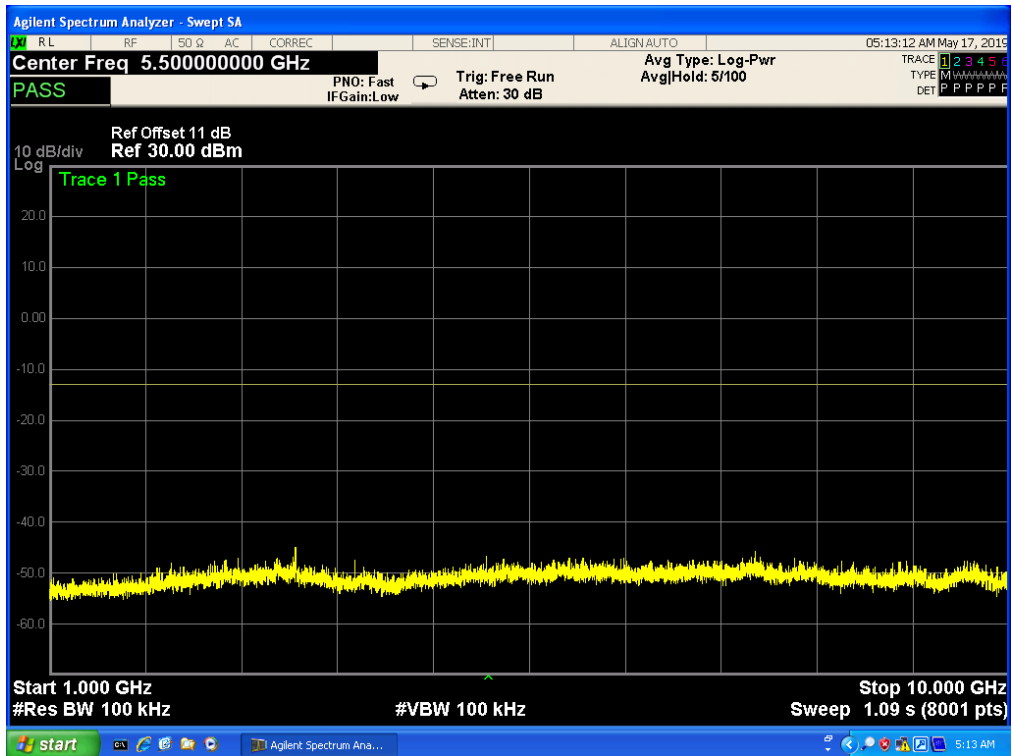

Band 5, UL Channel 20625, UL Frequency 846.5, BW 5.0, NO. RB 25, RB POS. Low, QPSK

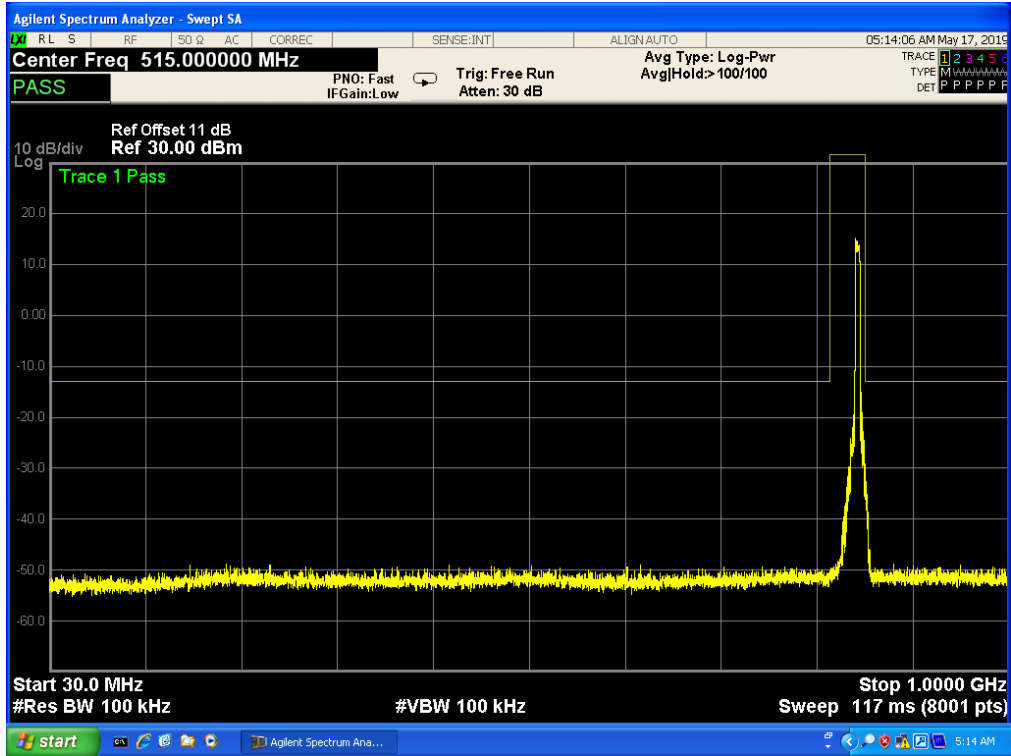

Band 5, UL Channel 20625, UL Frequency 846.5, BW 5.0, NO. RB 25, RB POS. Low, QPSK

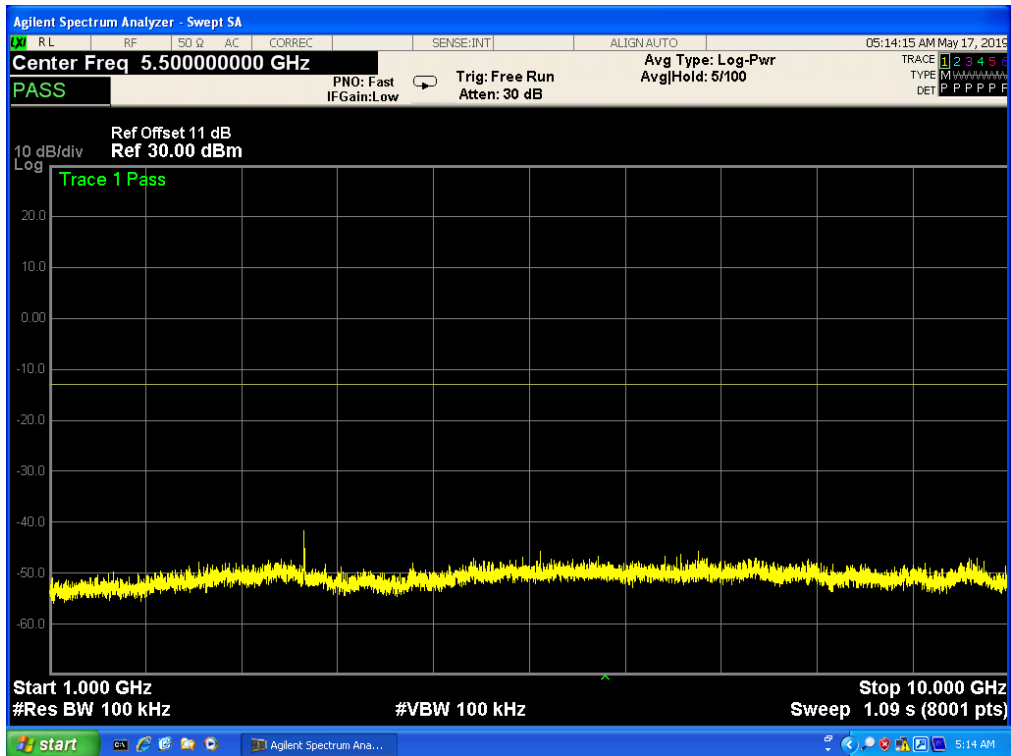

Band 5, UL Channel 20625, UL Frequency 846.5, BW 5.0, NO. RB 25, RB POS. Low, 16-QAM

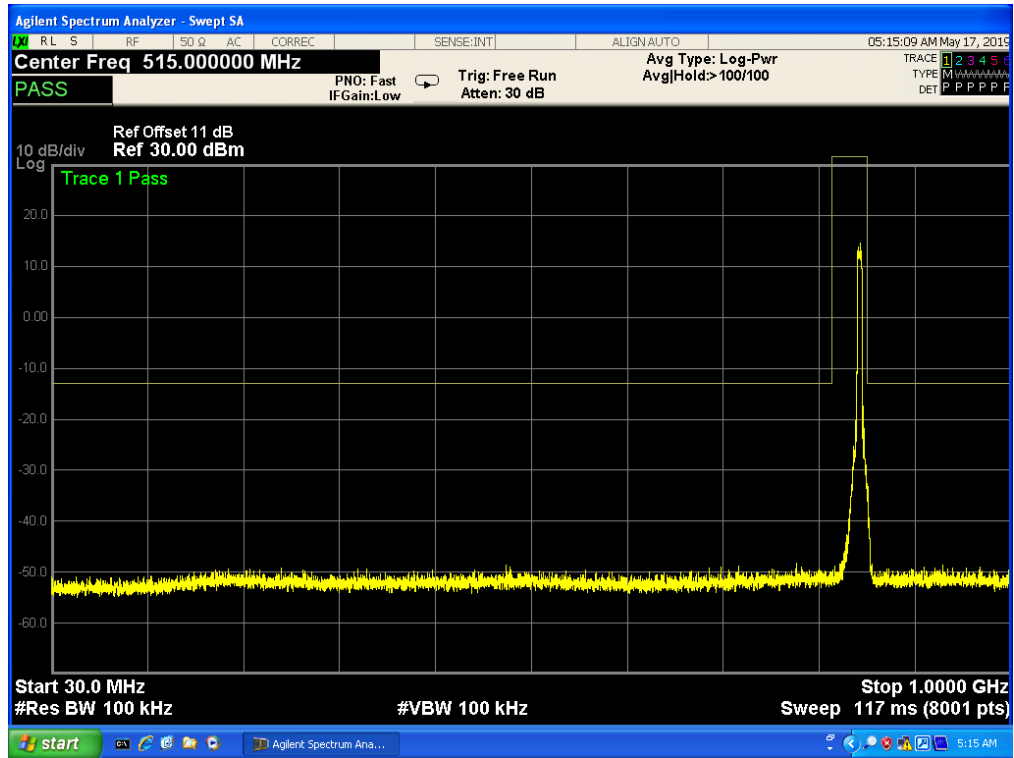

Band 5, UL Channel 20625, UL Frequency 846.5, BW 5.0, NO. RB 25, RB POS. Low, 16-QAM

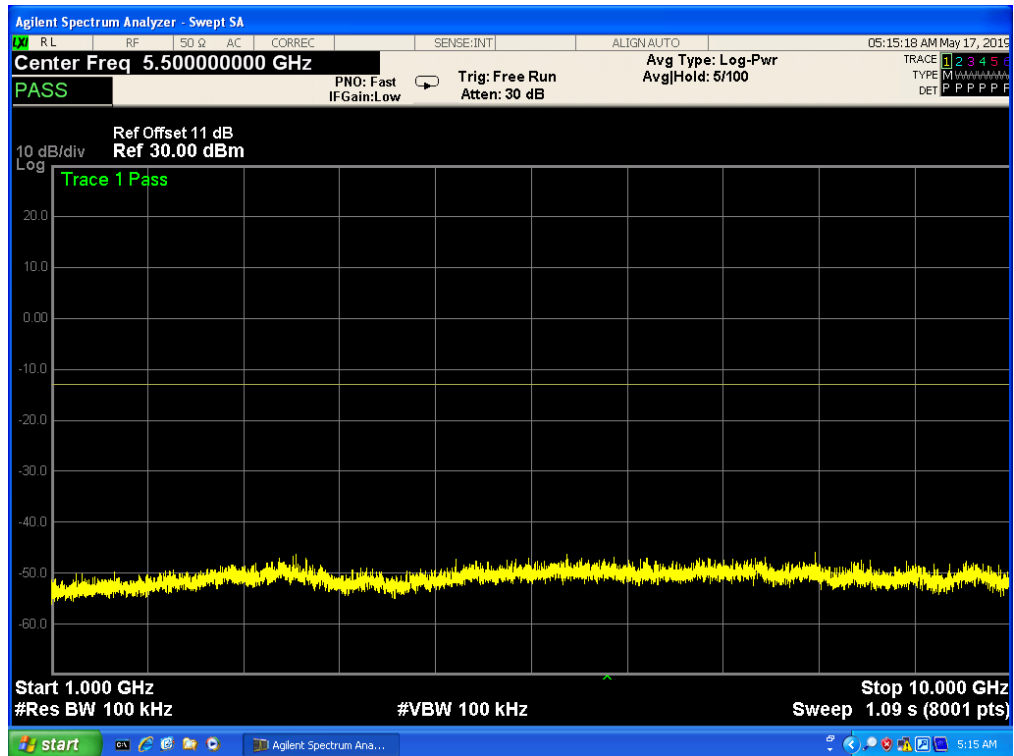

Band 5, UL Channel 20450, UL Frequency 829.0, BW 10.0, NO. RB 50, RB POS. Low, QPSK

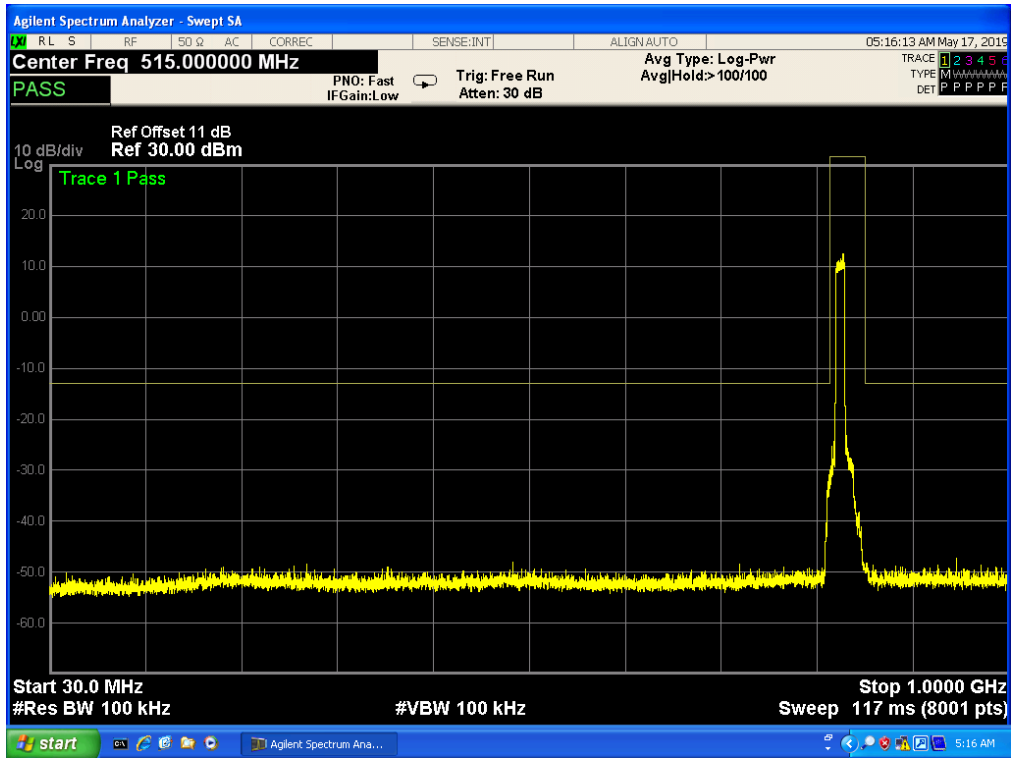

Band 5, UL Channel 20450, UL Frequency 829.0, BW 10.0, NO. RB 50, RB POS. Low, QPSK

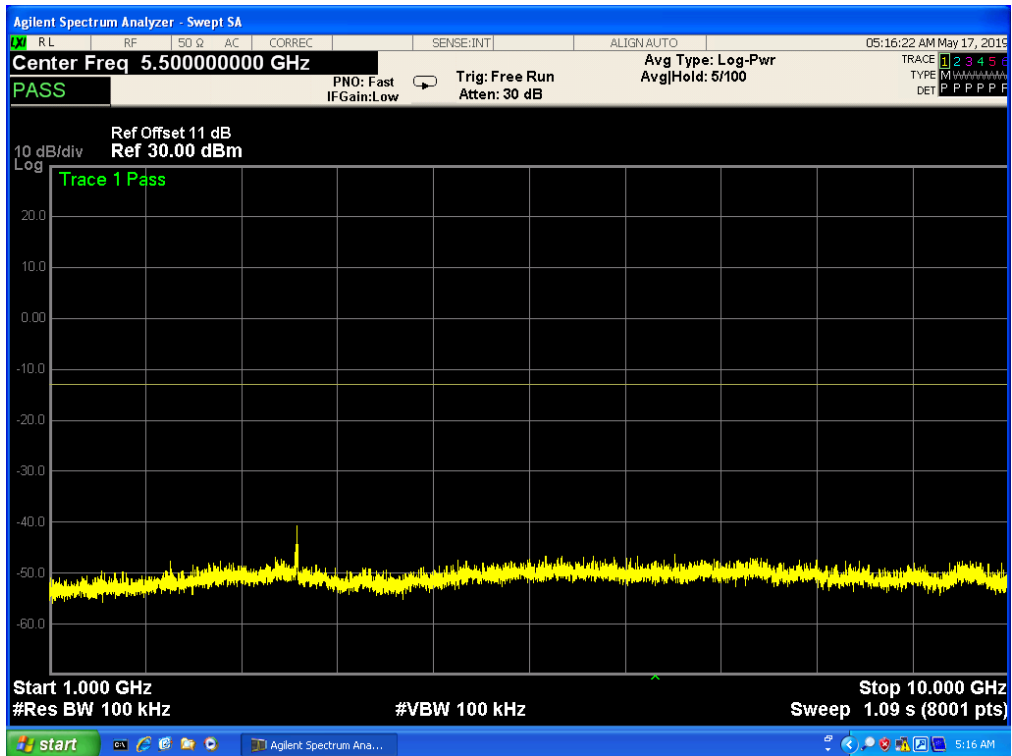

Band 5, UL Channel 20450, UL Frequency 829.0, BW 10.0, NO. RB 50, RB POS. Low, 16-QAM

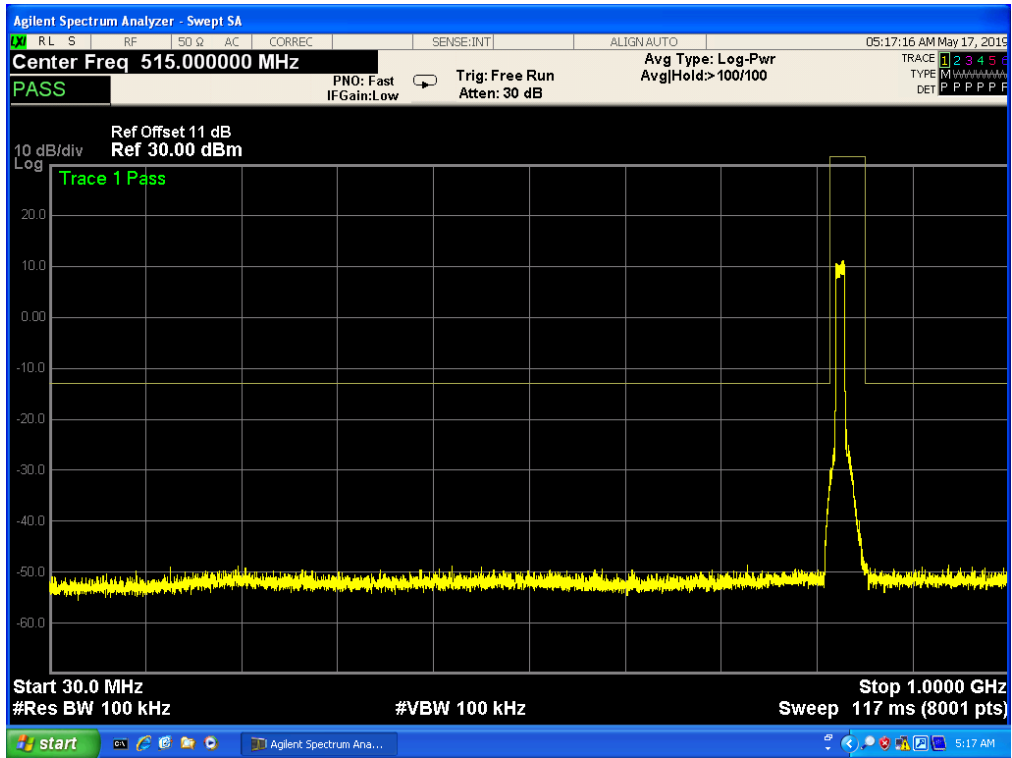

Band 5, UL Channel 20450, UL Frequency 829.0, BW 10.0, NO. RB 50, RB POS. Low, 16-QAM

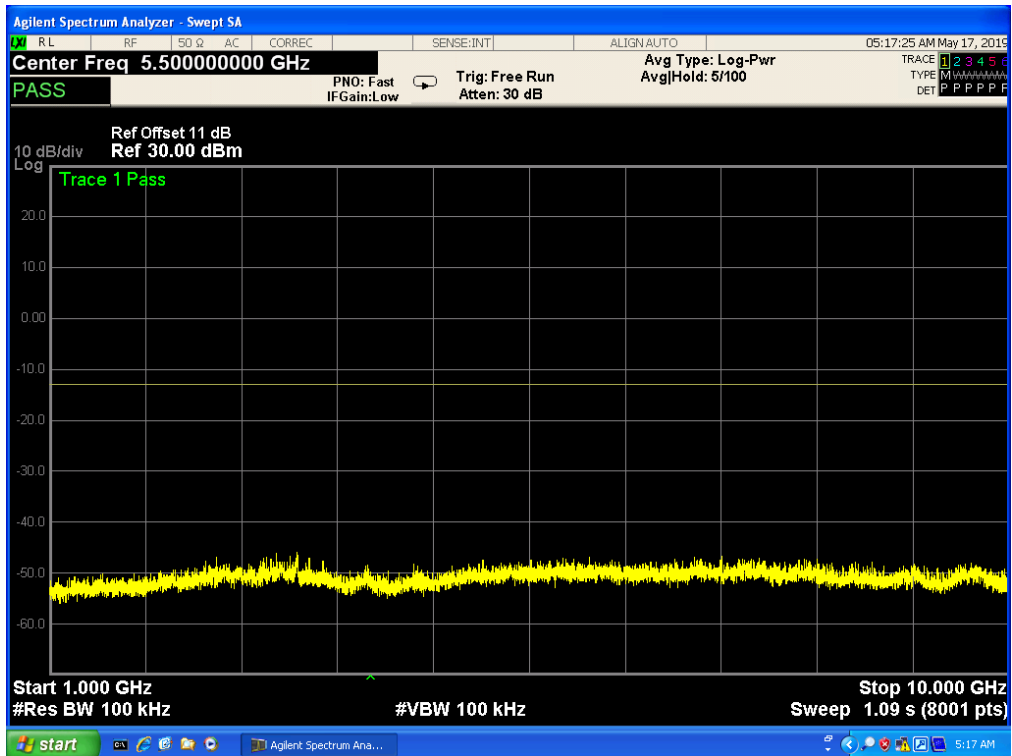

Band 5, UL Channel 20600, UL Frequency 844.0, BW 10.0, NO. RB 50, RB POS. Low, QPSK

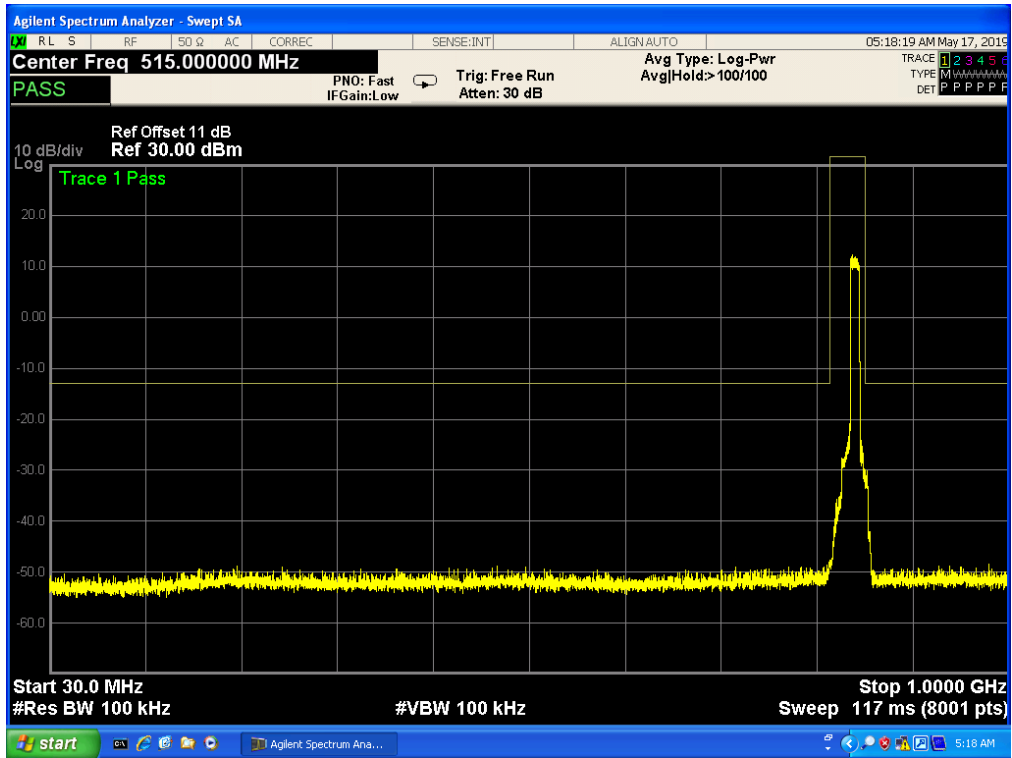

Band 5, UL Channel 20600, UL Frequency 844.0, BW 10.0, NO. RB 50, RB POS. Low, QPSK

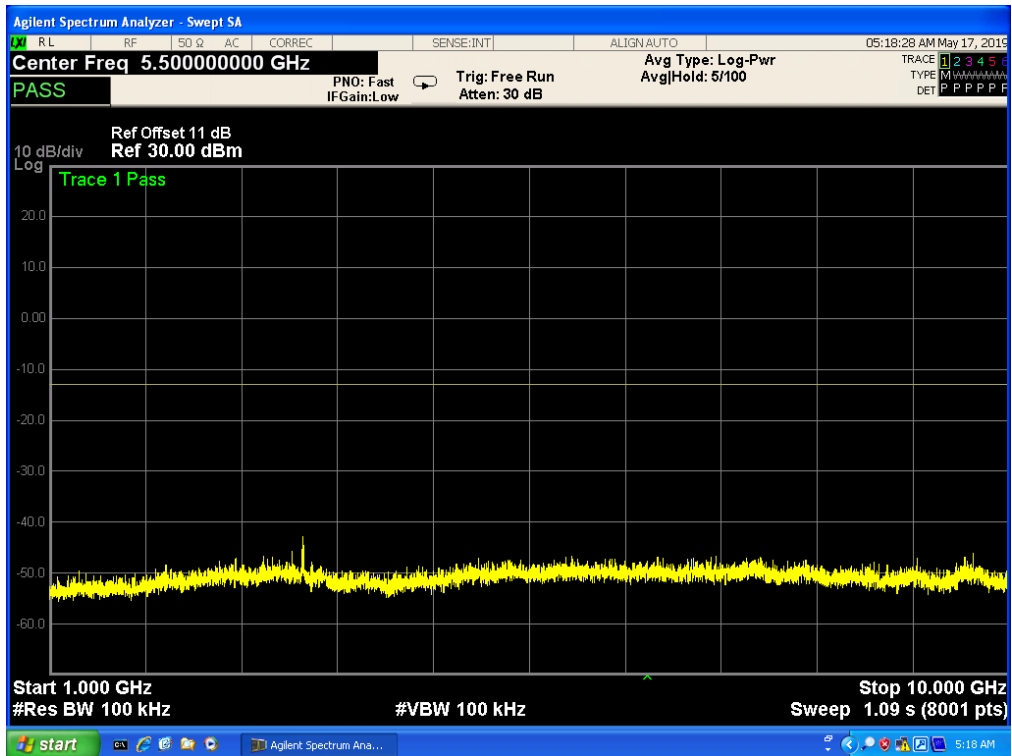

Band 5, UL Channel 20600, UL Frequency 844.0, BW 10.0, NO. RB 50, RB POS. Low, 16-QAM

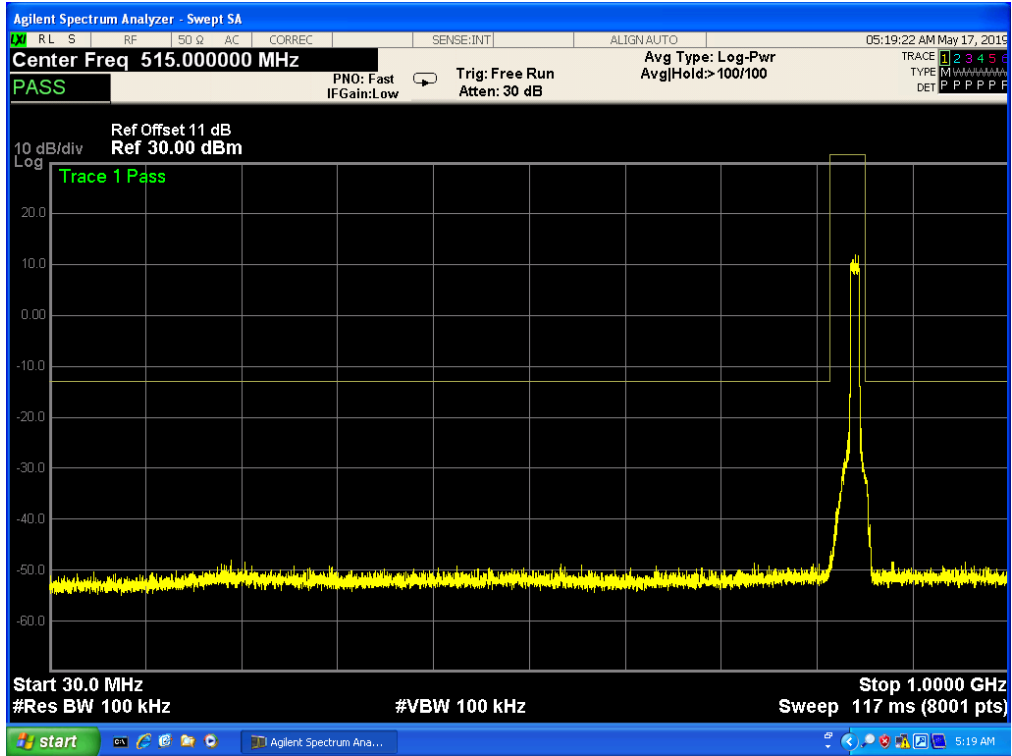

Band 5, UL Channel 20600, UL Frequency 844.0, BW 10.0, NO. RB 50, RB POS. Low, 16-QAM

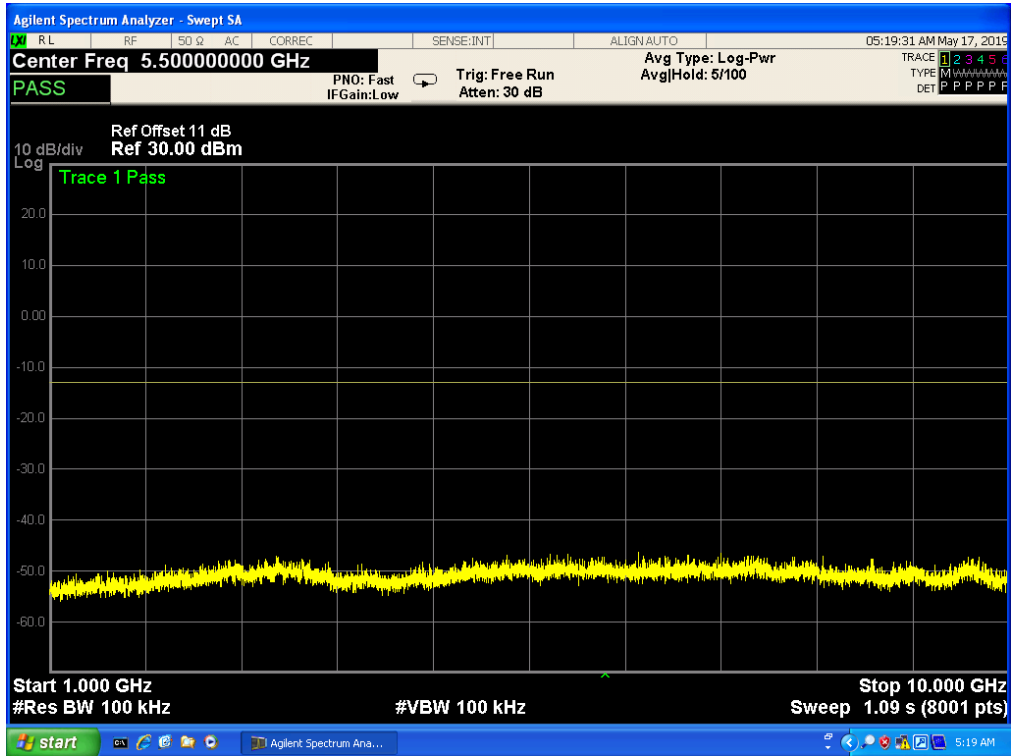

7.4 LTE BAND 7

Band 7, UL Channel 20775, UL Frequency 2502.5, BW 5.0, NO. RB 25, RB POS. Low, QPSK

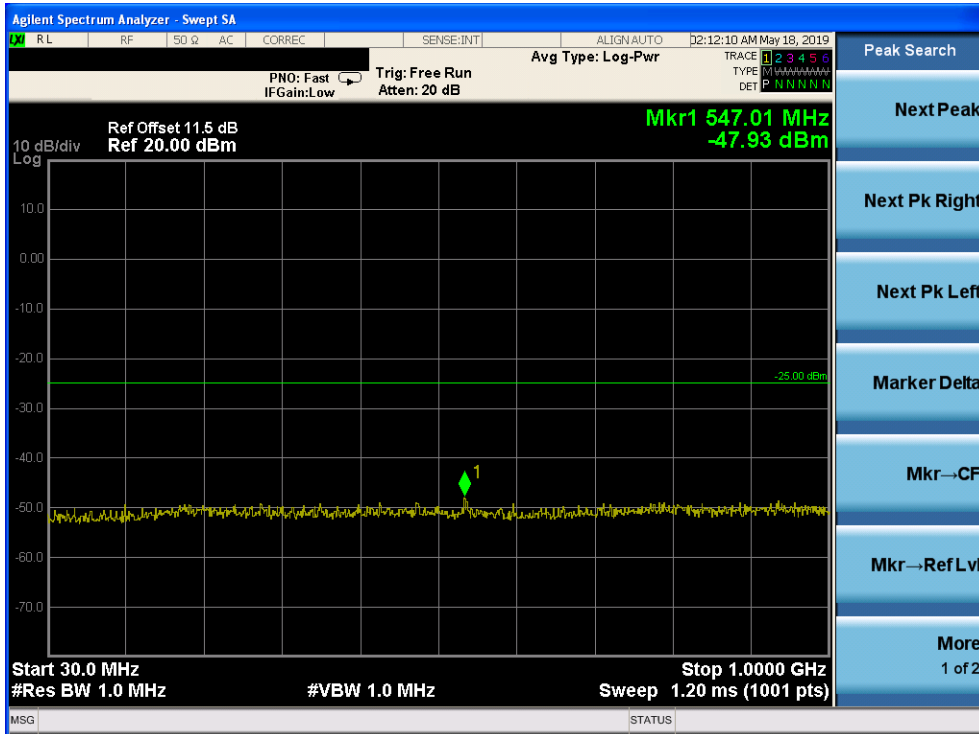

Band 7, UL Channel 20775, UL Frequency 2502.5, BW 5.0, NO. RB 25, RB POS. Low, QPSK

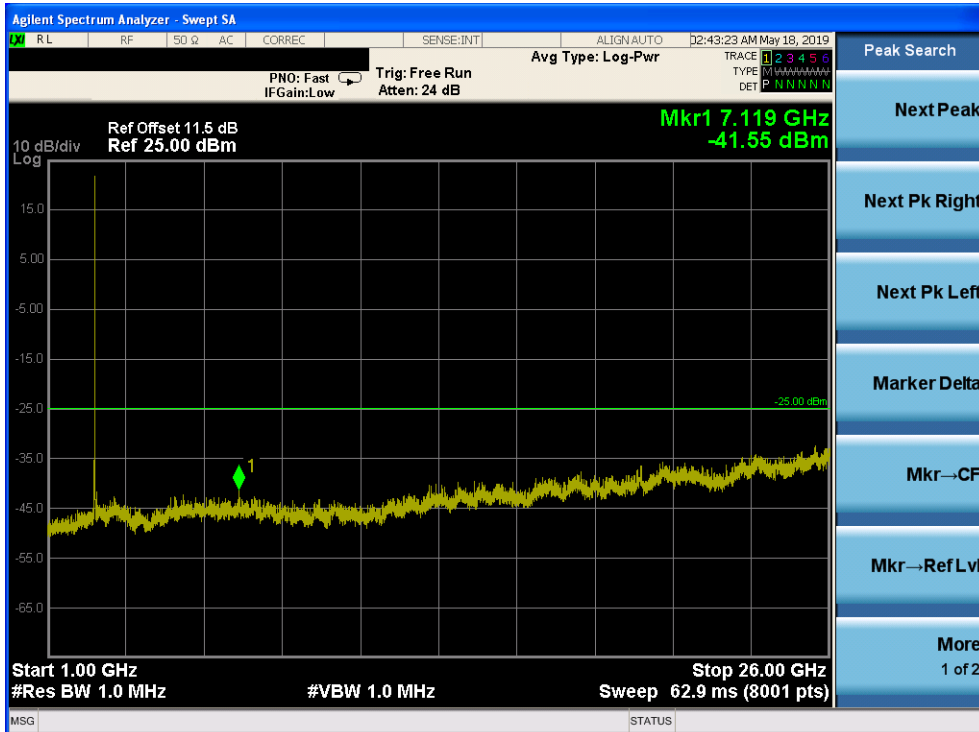

Band 7, UL Channel 20775, UL Frequency 2502.5, BW 5.0, NO. RB 25, RB POS. Low, 16-QAM

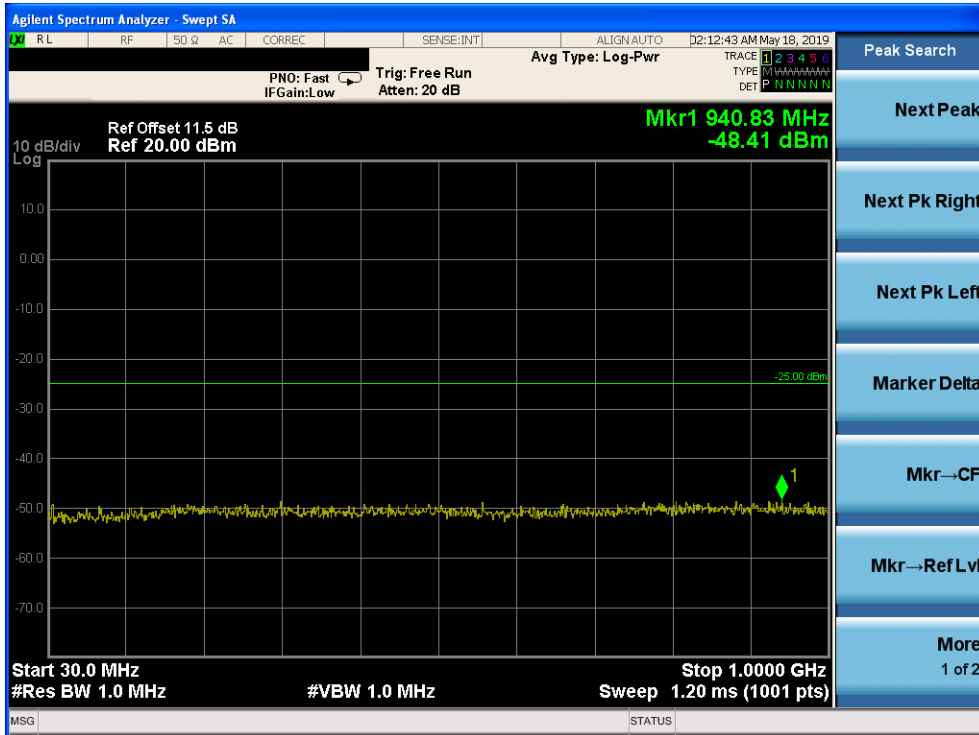

Band 7, UL Channel 20775, UL Frequency 2502.5, BW 5.0, NO. RB 25, RB POS. Low, 16-QAM

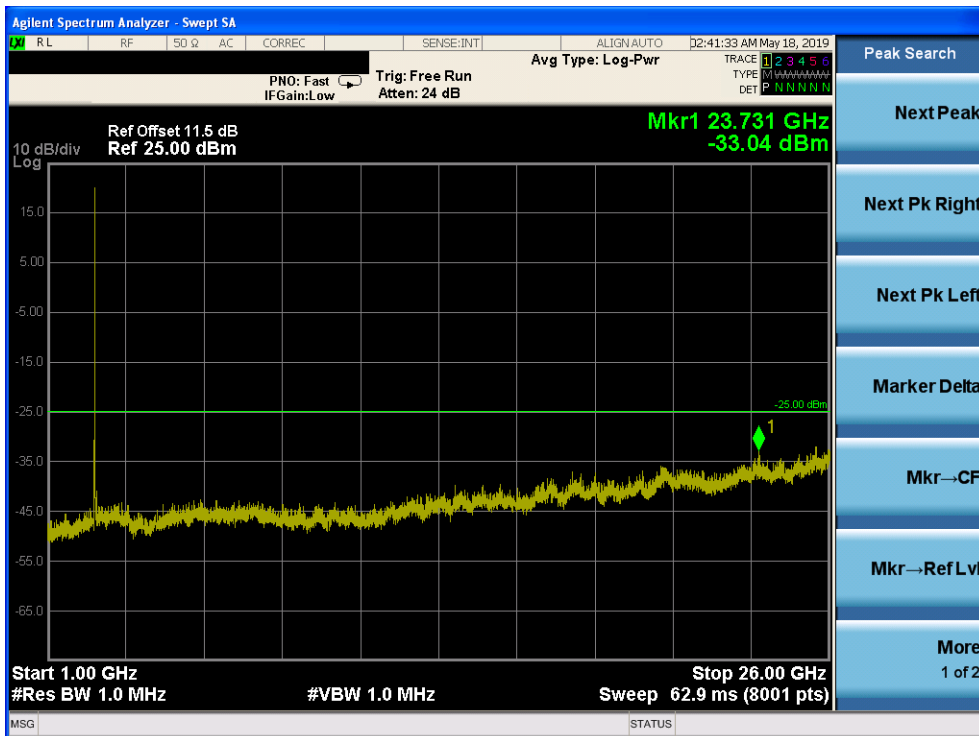

Band 7, UL Channel 21425, UL Frequency 2567.5, BW 5.0, NO. RB 25, RB POS. Low, QPSK

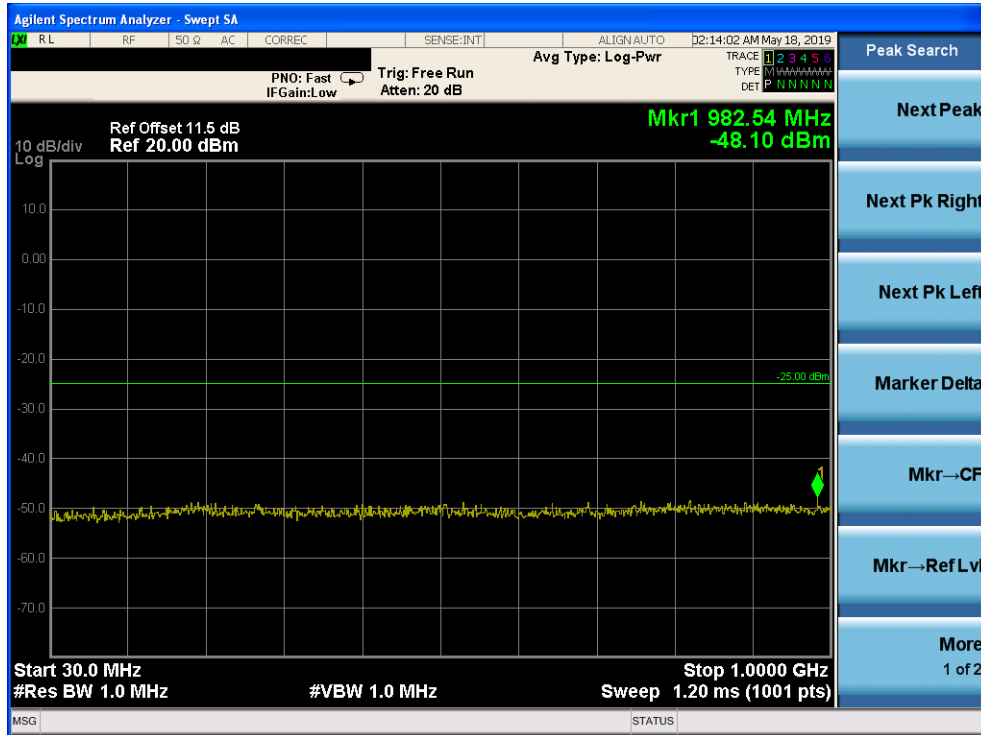

Band 7, UL Channel 21425, UL Frequency 2567.5, BW 5.0, NO. RB 25, RB POS. Low, QPSK

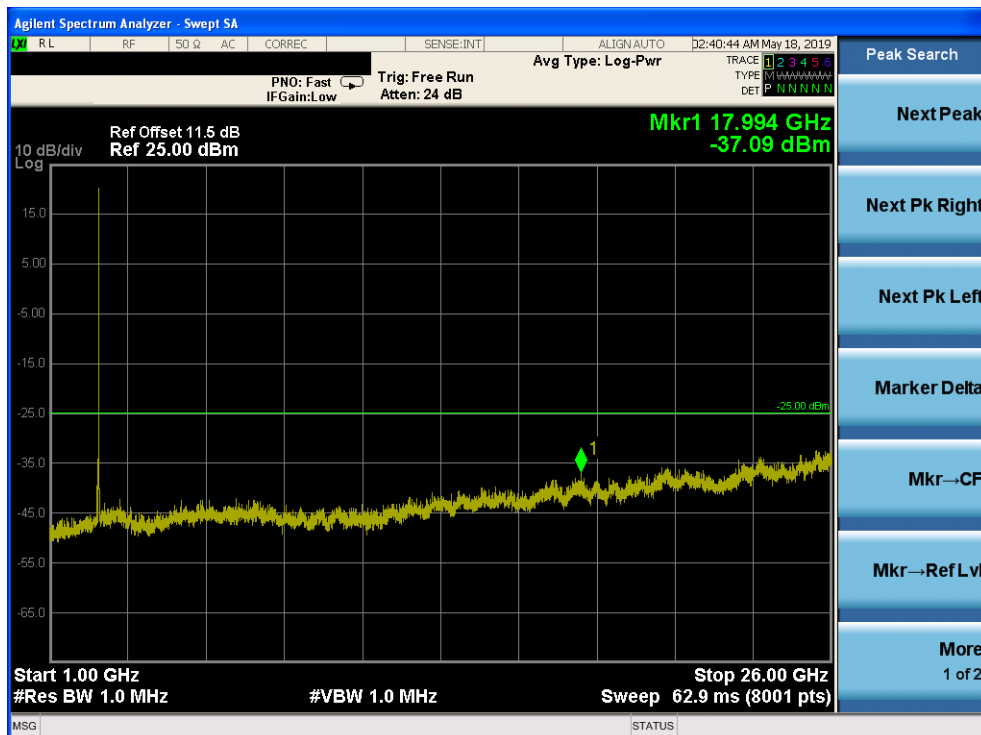

Band 7, UL Channel 21425, UL Frequency 2567.5, BW 5.0, NO. RB 25, RB POS. Low, 16-QAM

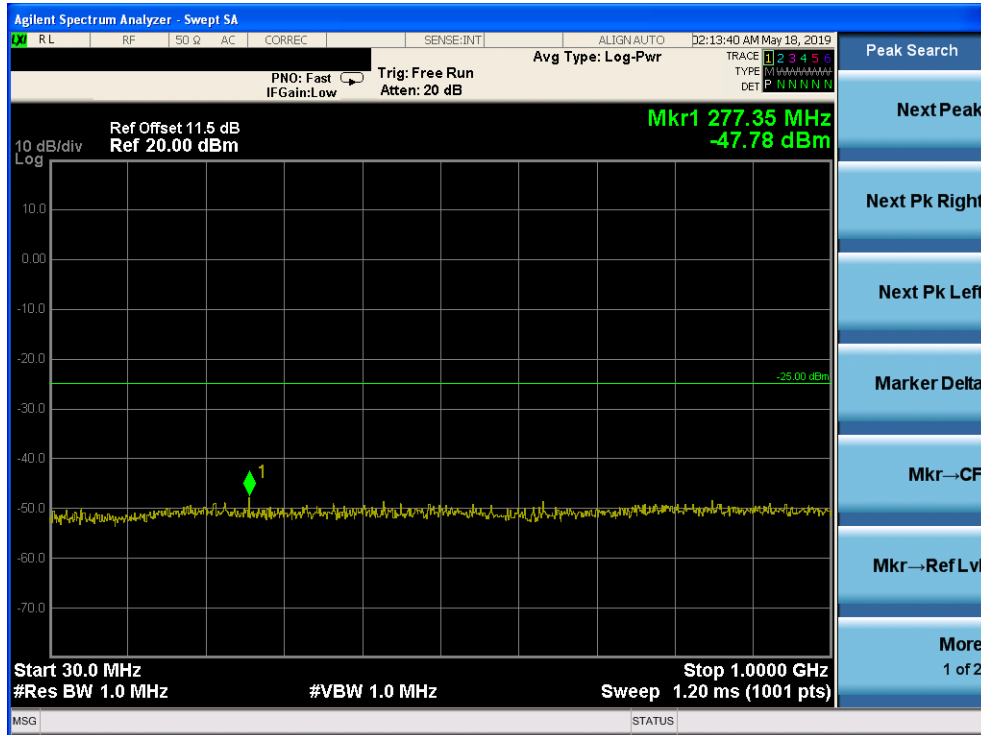

Band 7, UL Channel 21425, UL Frequency 2567.5, BW 5.0, NO. RB 25, RB POS. Low, 16-QAM

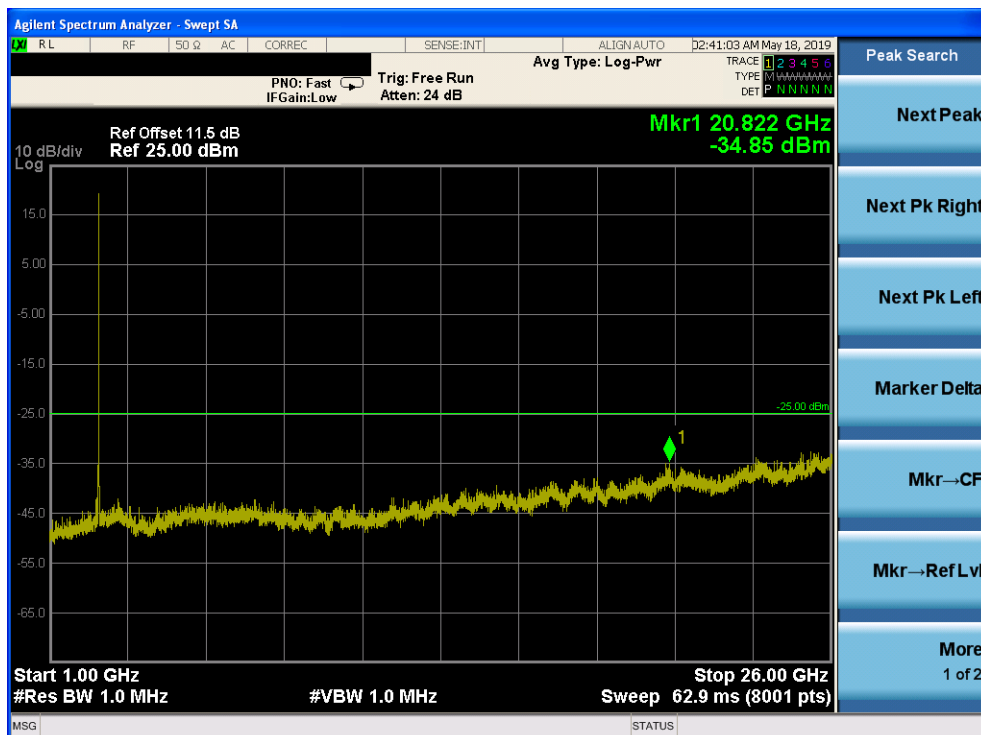

Band 7, UL Channel 20800, UL Frequency 2505.0, BW 10.0, NO. RB 50, RB POS. Low, QPSK

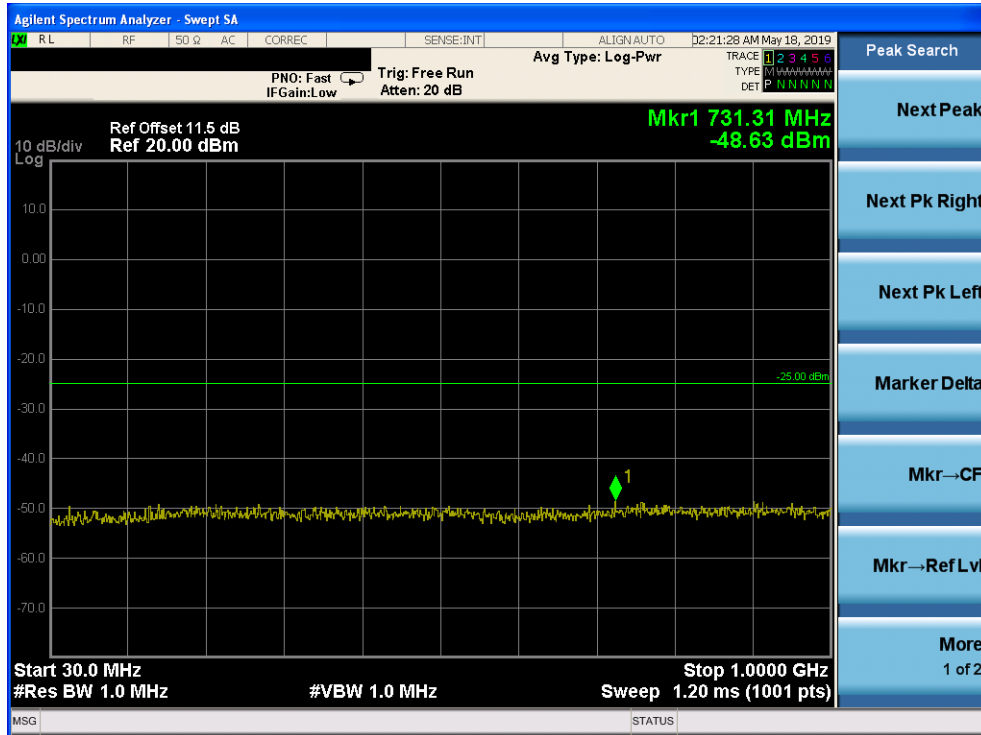

Band 7, UL Channel 20800, UL Frequency 2505.0, BW 10.0, NO. RB 50, RB POS. Low, QPSK

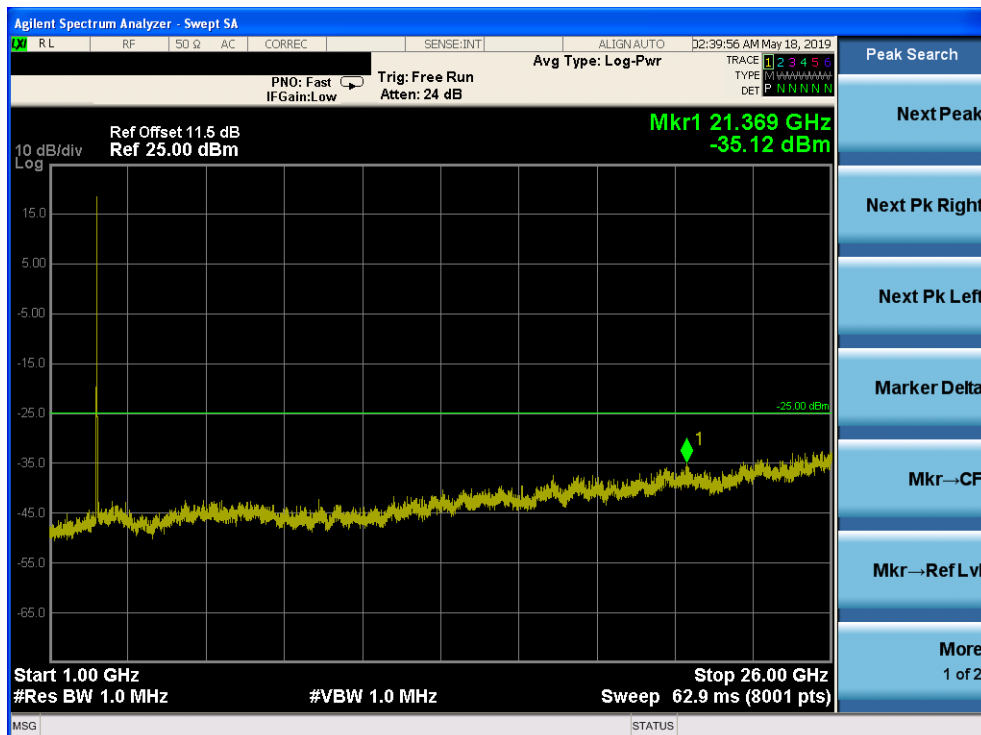

Band 7, UL Channel 20800, UL Frequency 2505.0, BW 10.0, NO. RB 50, RB POS. Low, 16-QAM

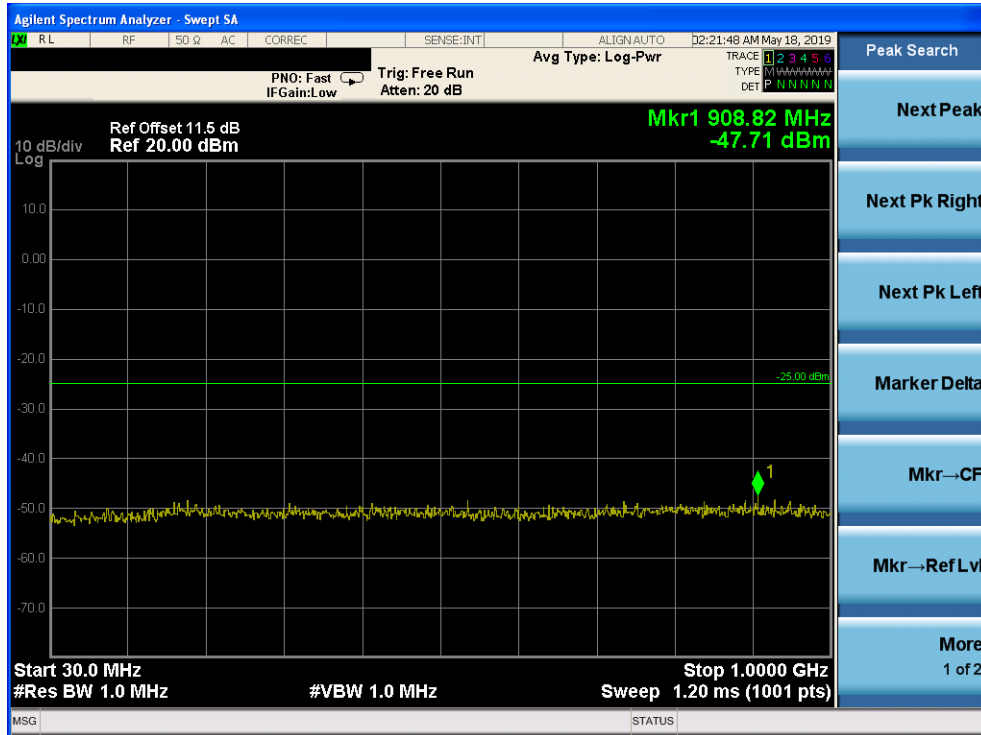

Band 7, UL Channel 20800, UL Frequency 2505.0, BW 10.0, NO. RB 50, RB POS. Low, 16-QAM

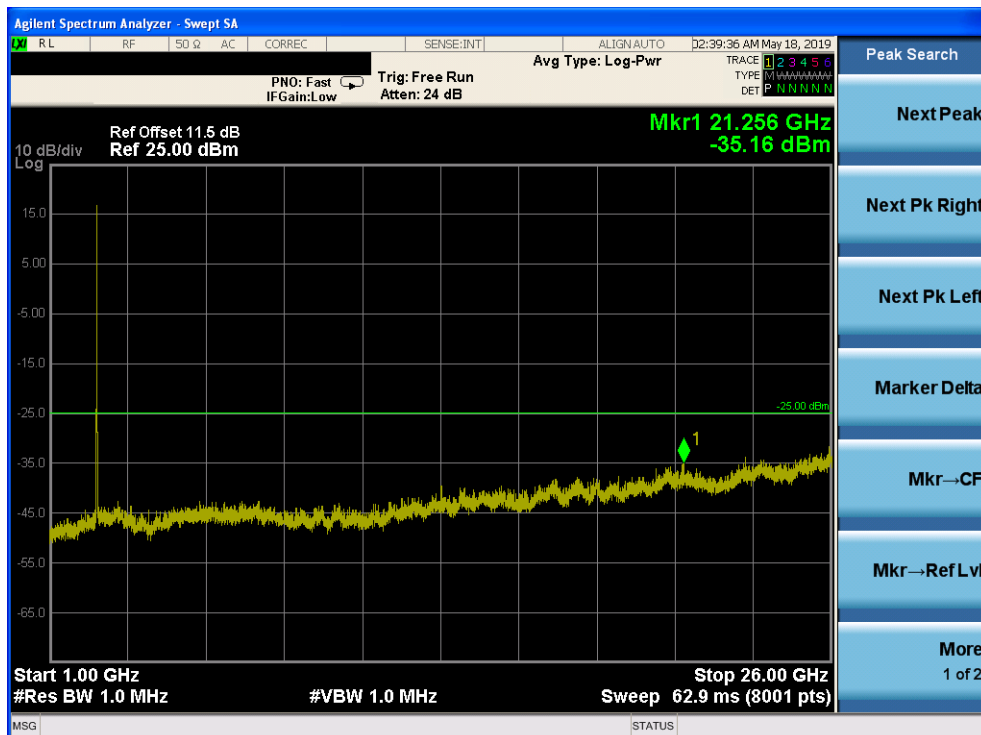

Band 7, UL Channel 21400, UL Frequency 2565.0, BW 10.0, NO. RB 50, RB POS. Low, QPSK

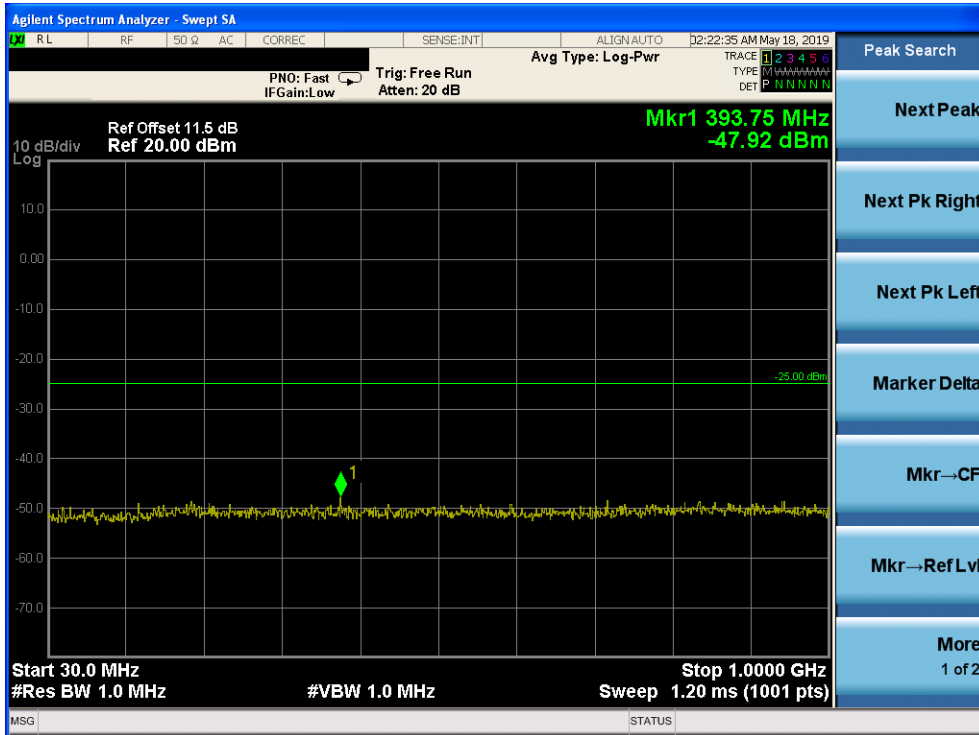

Band 7, UL Channel 21400, UL Frequency 2565.0, BW 10.0, NO. RB 50, RB POS. Low, QPSK

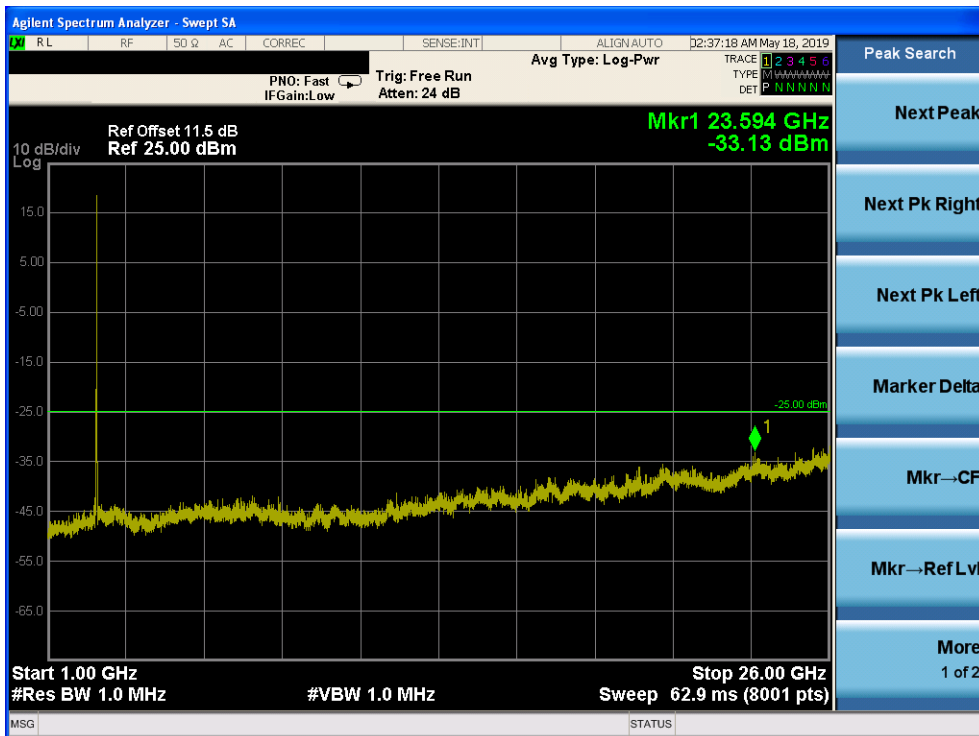

Band 7, UL Channel 21400, UL Frequency 2565.0, BW 10.0, NO. RB 50, RB POS. Low, 16-QAM

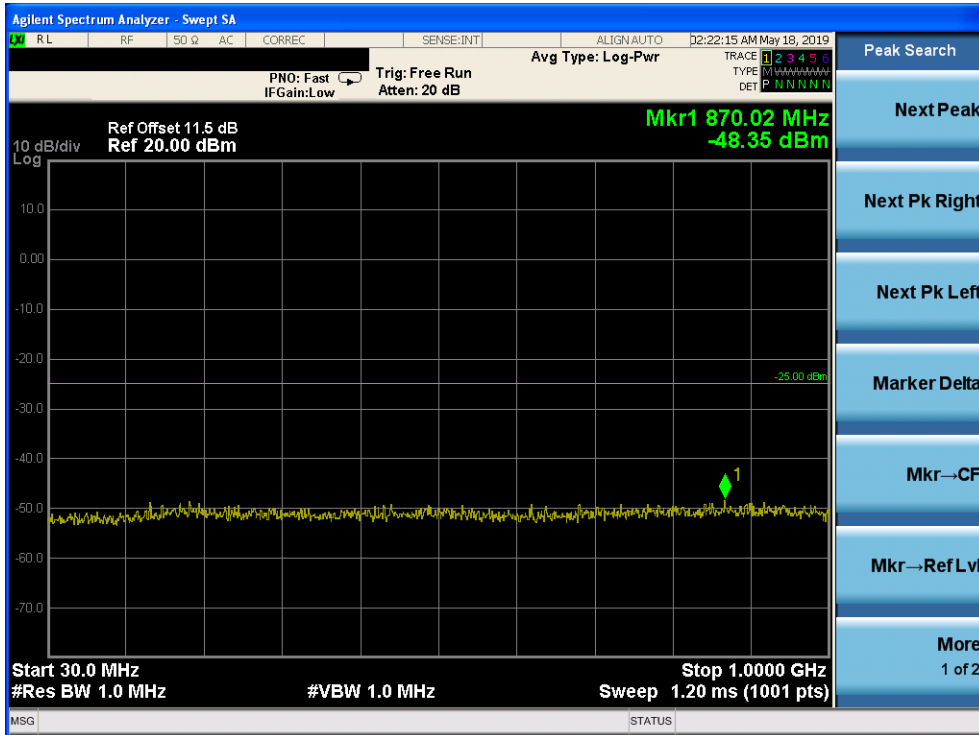

Band 7, UL Channel 21400, UL Frequency 2565.0, BW 10.0, NO. RB 50, RB POS. Low, 16-QAM

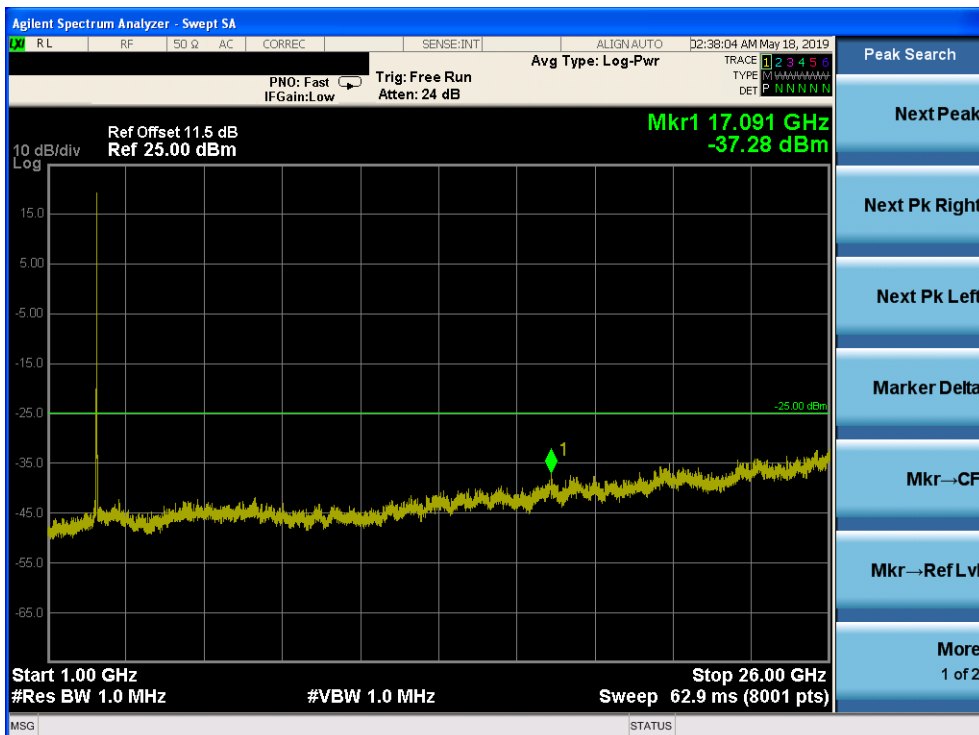

Band 7, UL Channel 20825, UL Frequency 2507.5, BW 15.0, NO. RB 75, RB POS. Low, QPSK

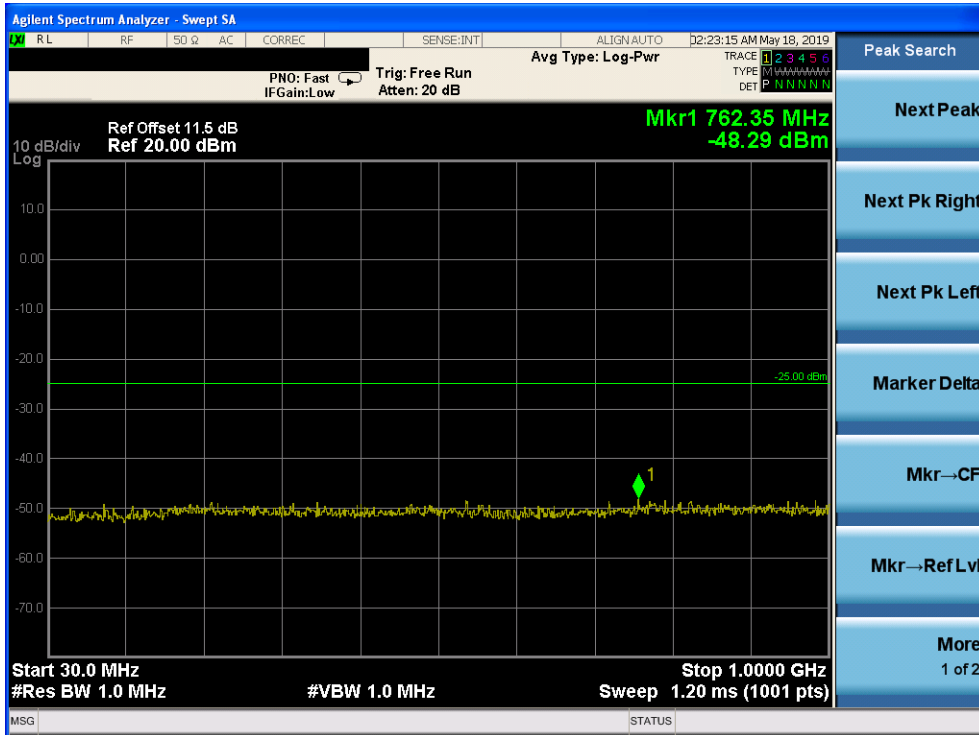

Band 7, UL Channel 20825, UL Frequency 2507.5, BW 15.0, NO. RB 75, RB POS. Low, QPSK

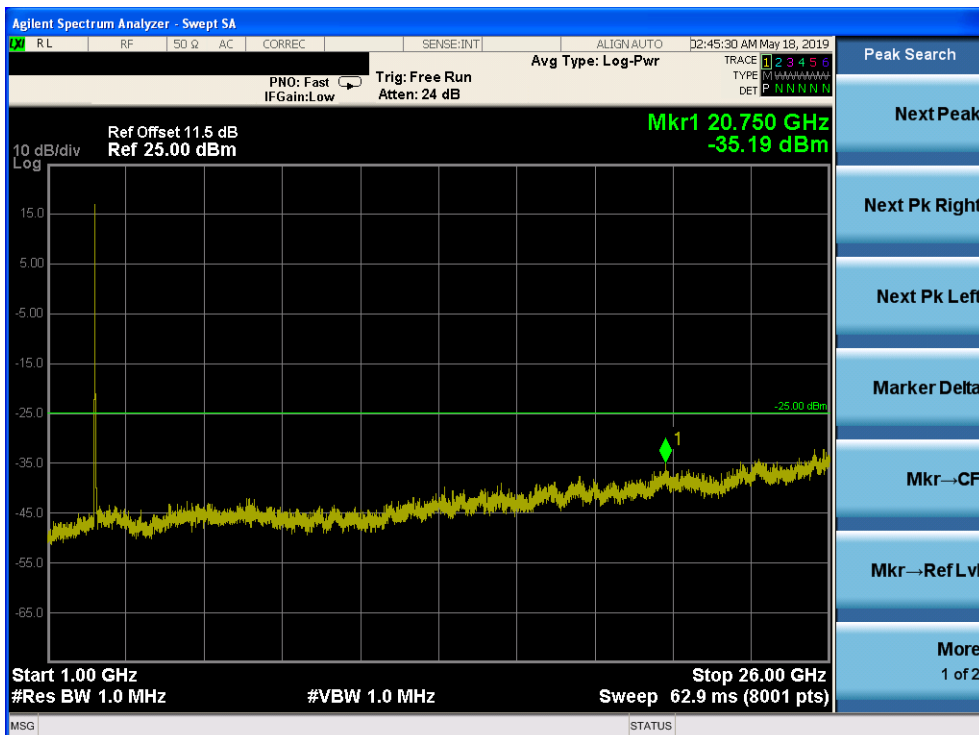

Band 7, UL Channel 20825, UL Frequency 2507.5, BW 15.0, NO. RB 75, RB POS. Low, 16-QAM

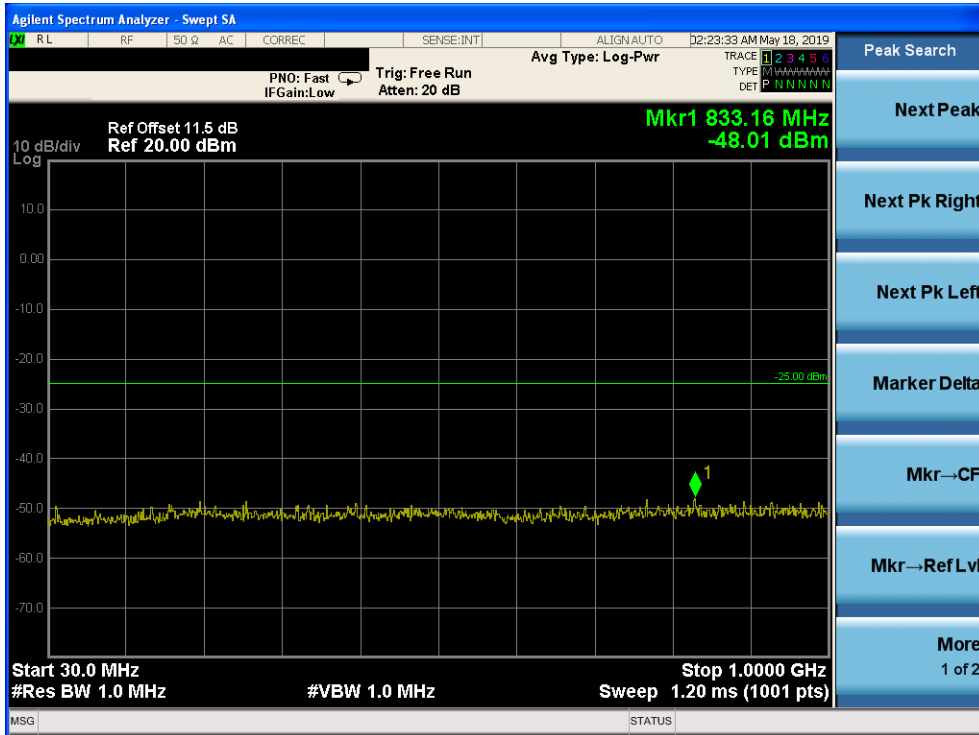

Band 7, UL Channel 20825, UL Frequency 2507.5, BW 15.0, NO. RB 75, RB POS. Low, 16-QAM

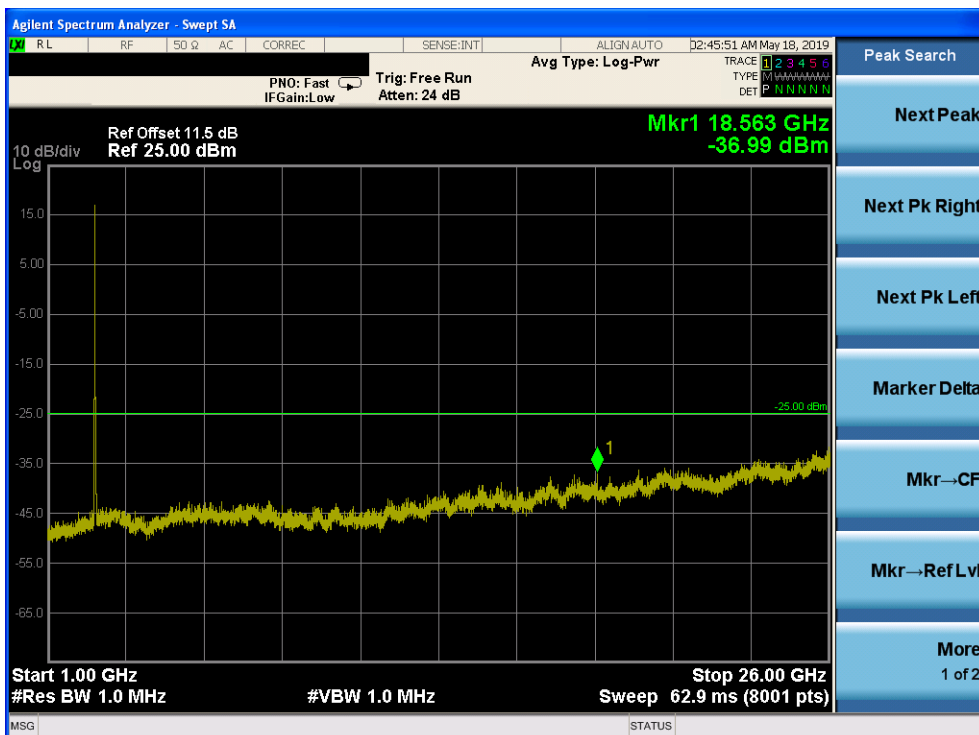

Band 7, UL Channel 21375, UL Frequency 2562.5, BW 15.0, NO. RB 75, RB POS. Low, QPSK

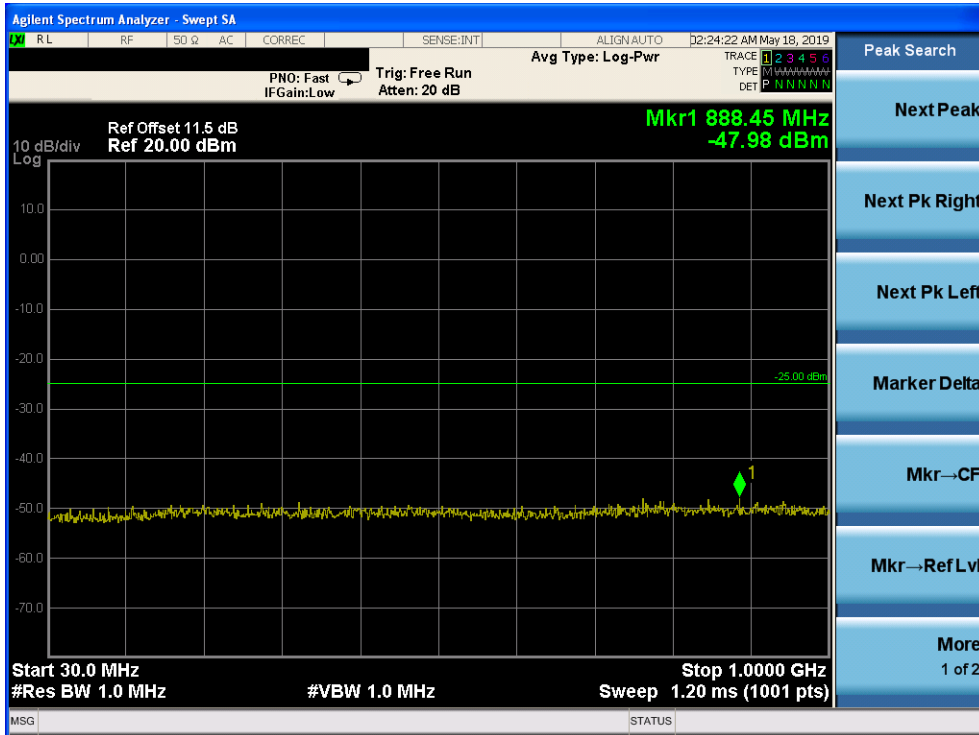

Band 7, UL Channel 21375, UL Frequency 2562.5, BW 15.0, NO. RB 75, RB POS. Low, QPSK

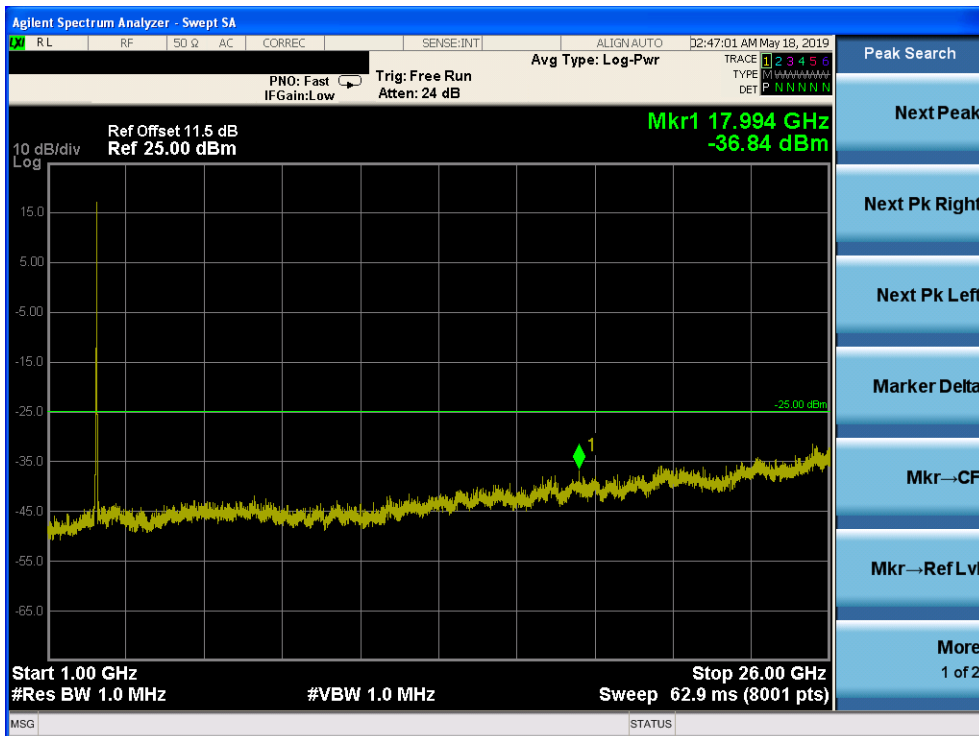

Band 7, UL Channel 21375, UL Frequency 2562.5, BW 15.0, NO. RB 75, RB POS. Low, 16-QAM

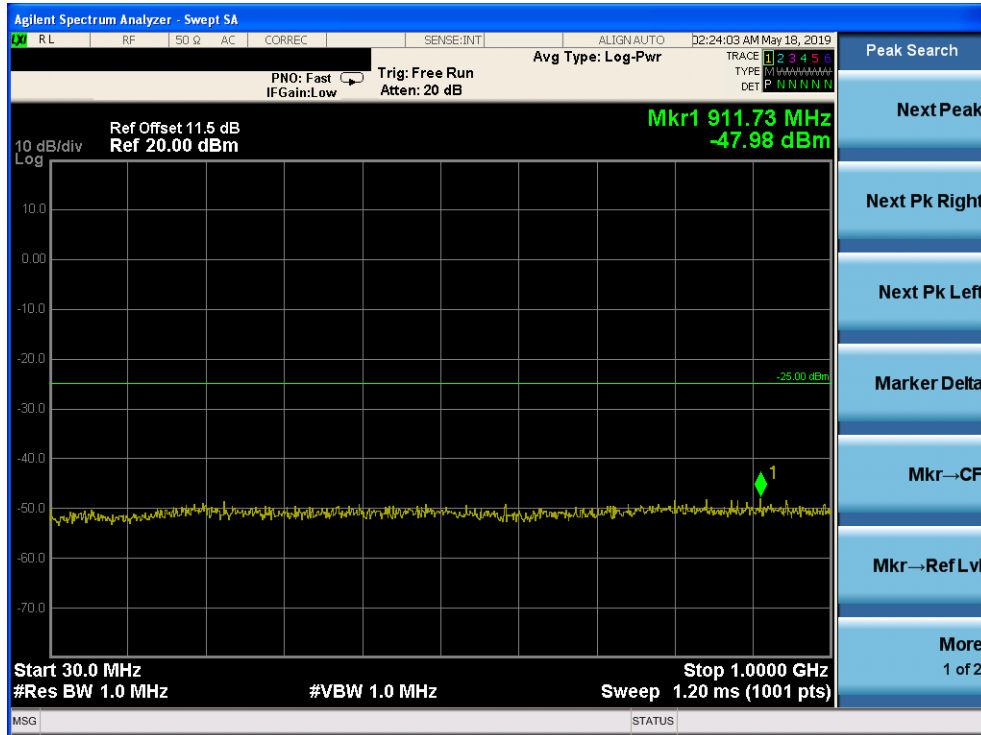

Band 7, UL Channel 21375, UL Frequency 2562.5, BW 15.0, NO. RB 75, RB POS. Low, 16-QAM

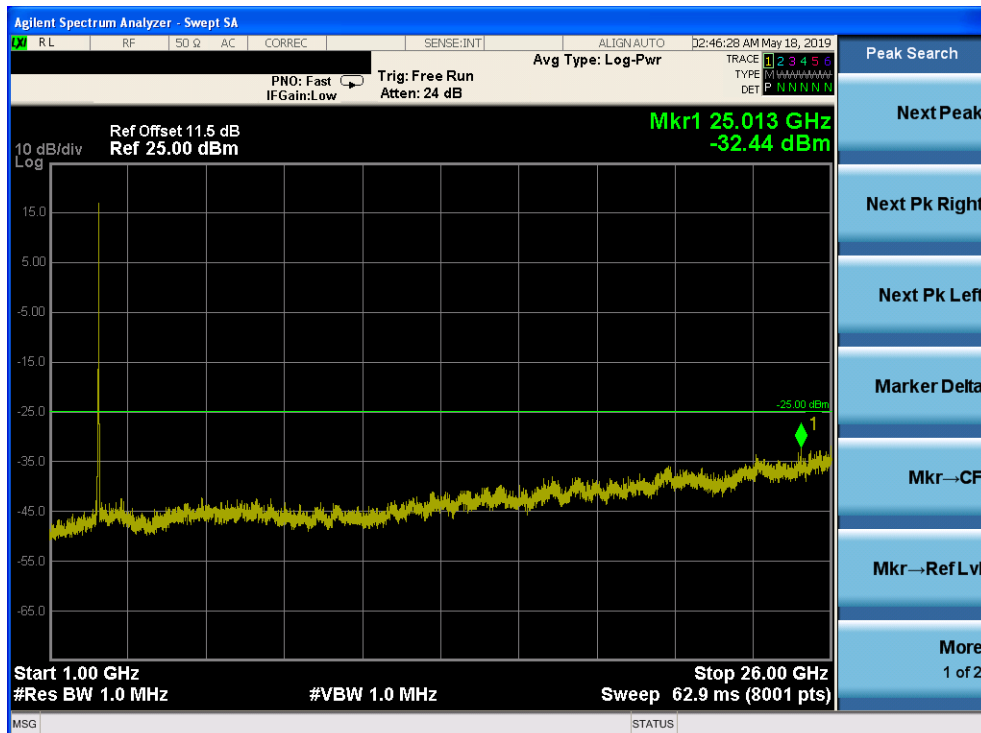

Band 7, UL Channel 20850, UL Frequency 2510.0, BW 20.0, NO. RB 100, RB POS. Low, QPSK

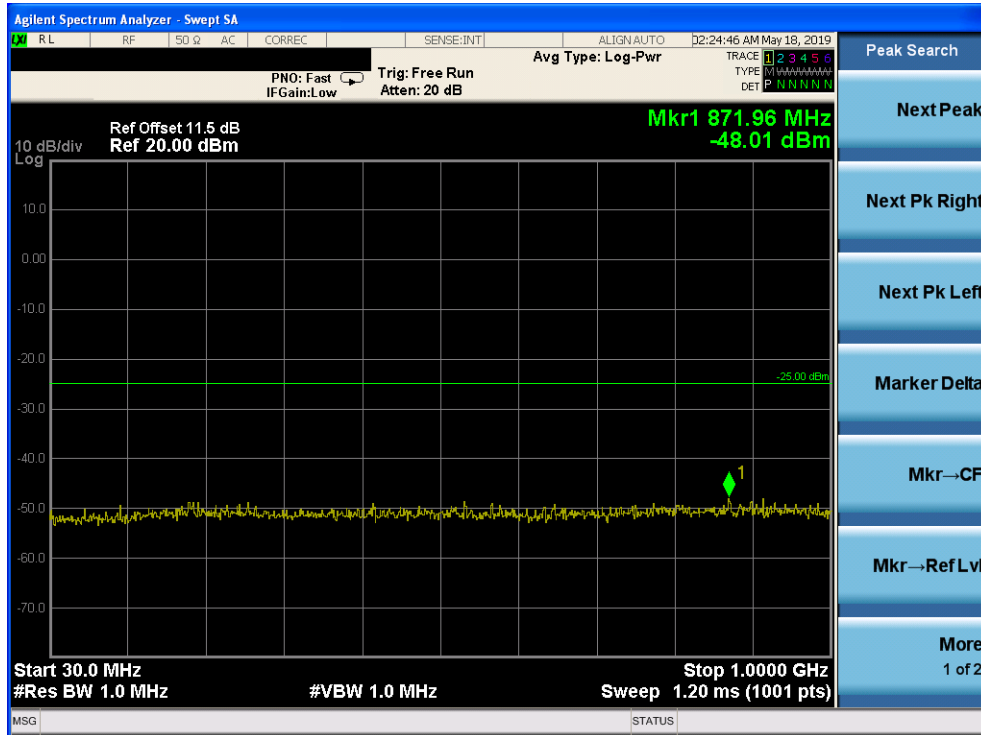

Band 7, UL Channel 20850, UL Frequency 2510.0, BW 20.0, NO. RB 100, RB POS. Low, QPSK

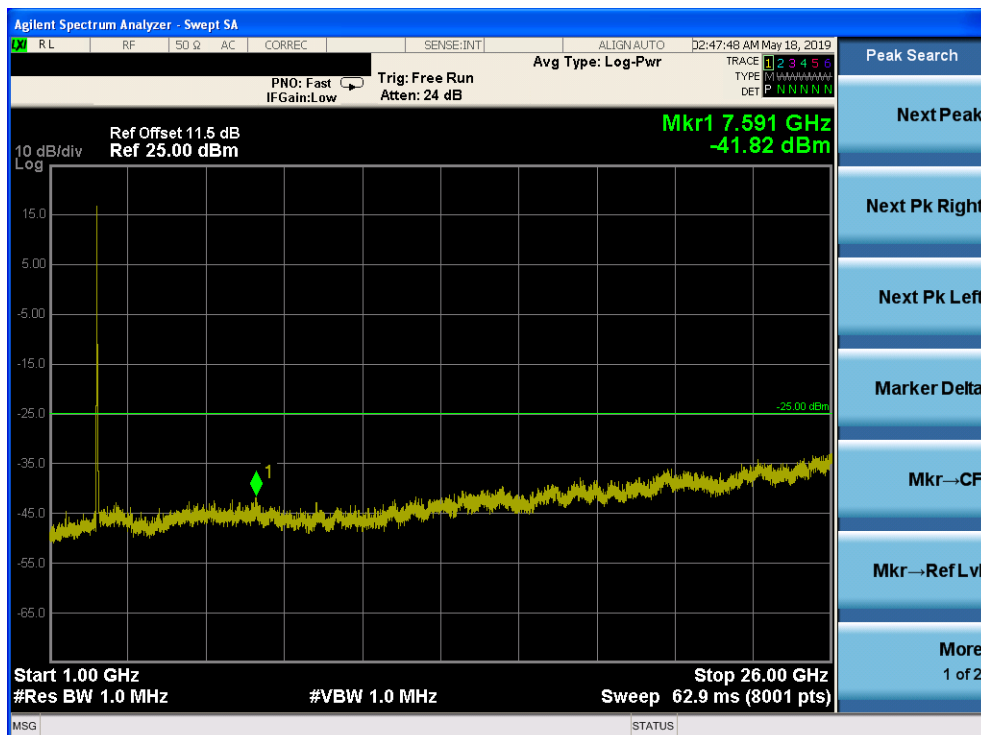

Band 7, UL Channel 20850, UL Frequency 2510.0, BW 20.0, NO. RB 100, RB POS. Low, 16-QAM

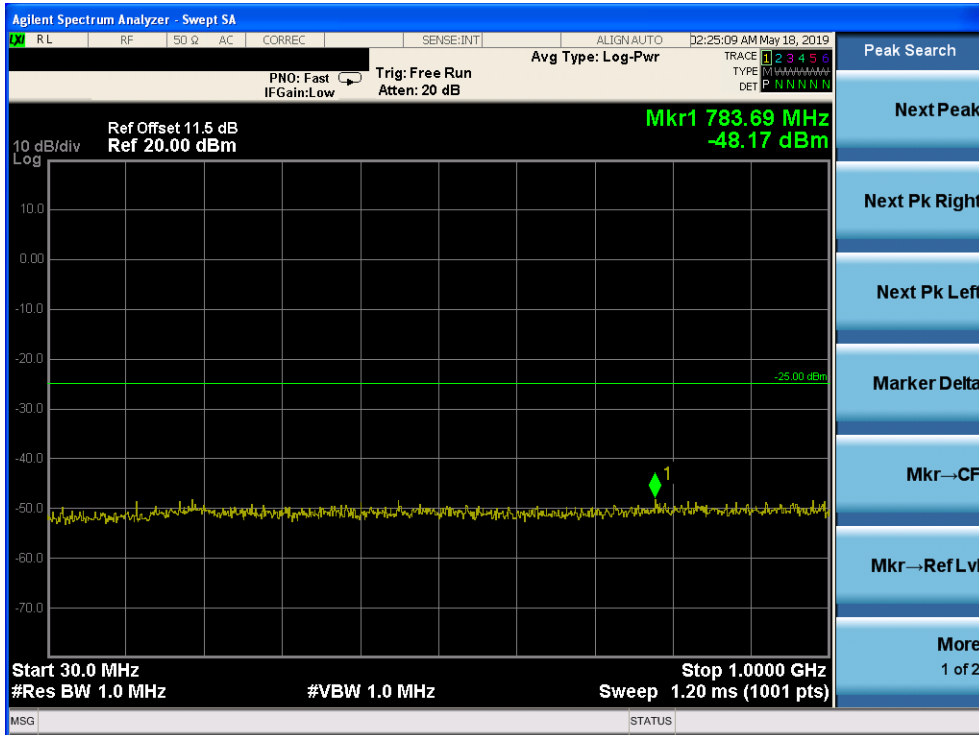

Band 7, UL Channel 20850, UL Frequency 2510.0, BW 20.0, NO. RB 100, RB POS. Low, 16-QAM

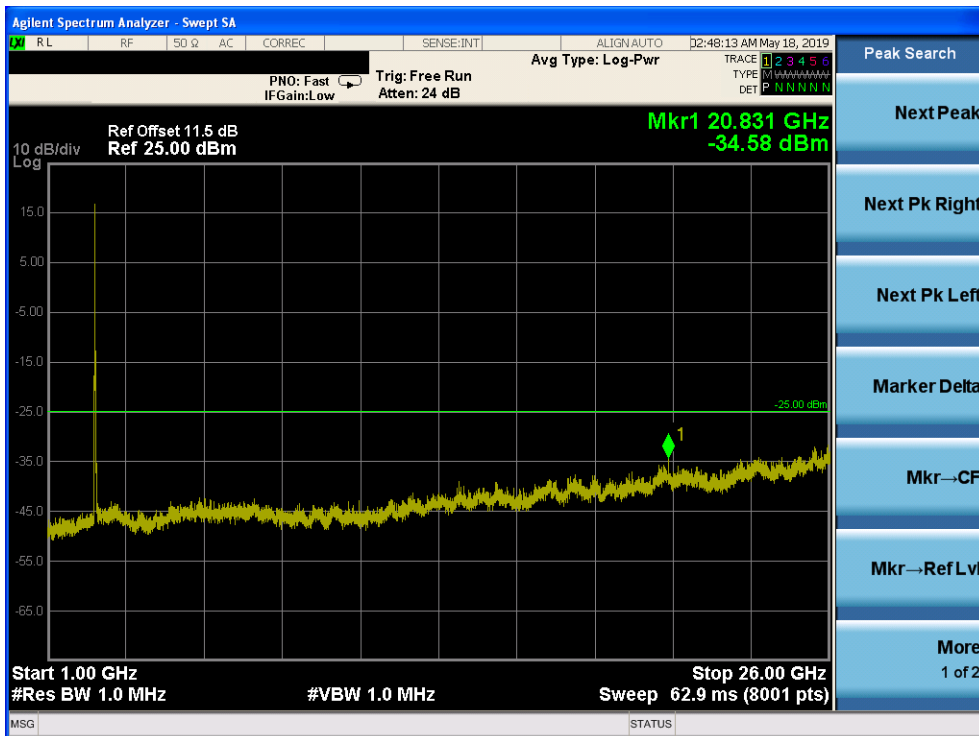

Band 7, UL Channel 21350, UL Frequency 2560.0, BW 20.0, NO. RB 100, RB POS. Low, QPSK

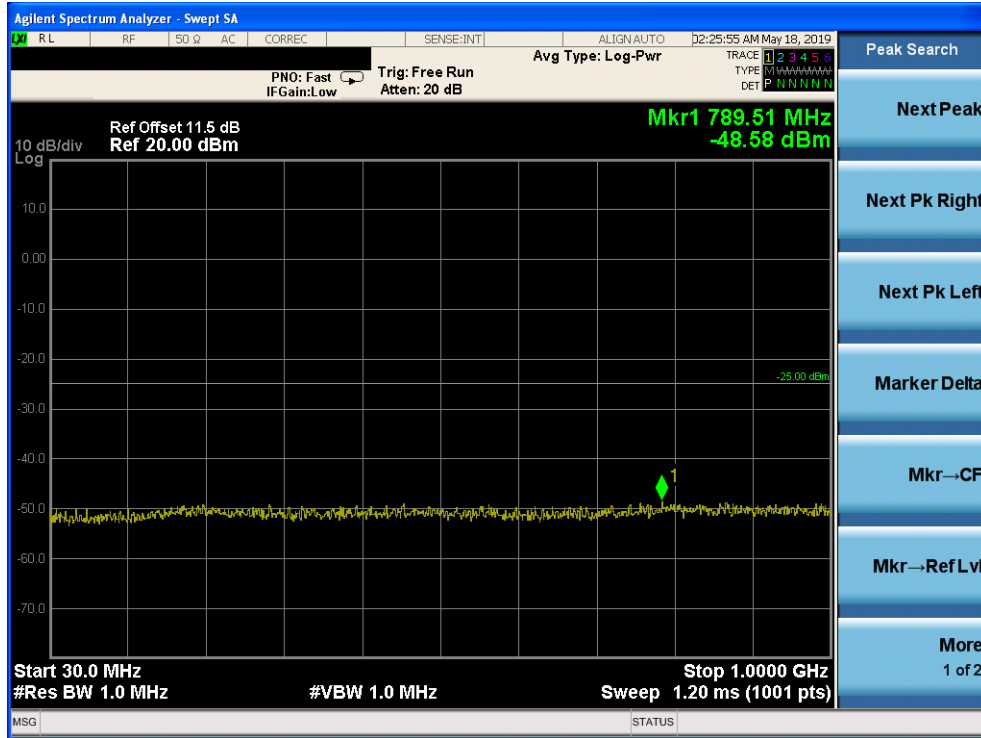

Band 7, UL Channel 21350, UL Frequency 2560.0, BW 20.0, NO. RB 100, RB POS. Low, QPSK

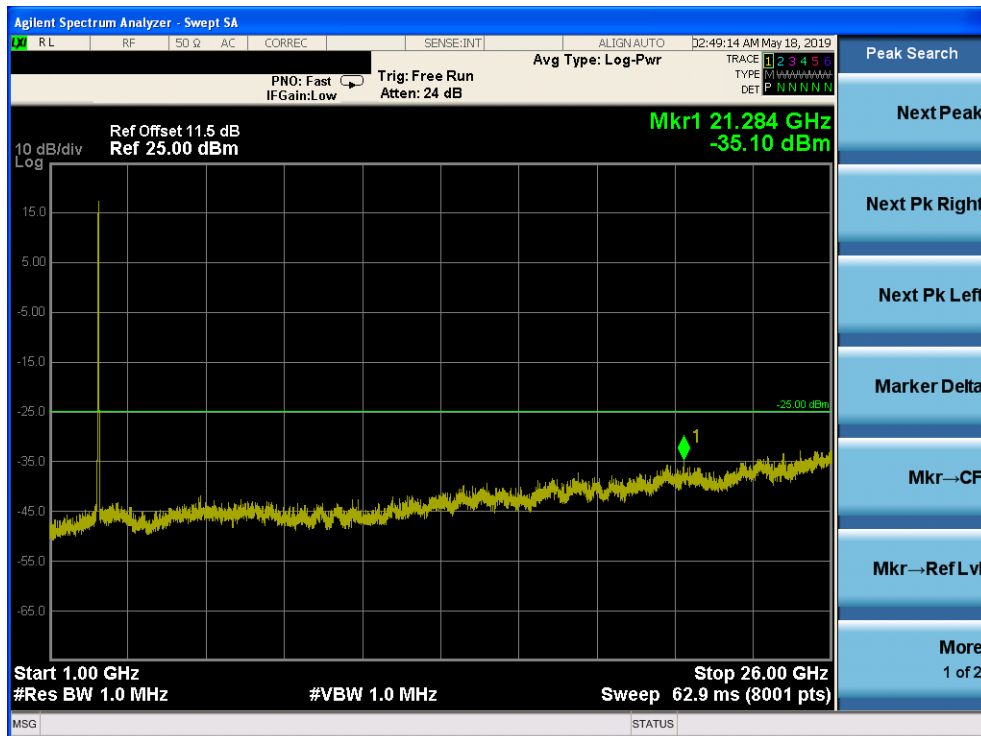

Band 7, UL Channel 21350, UL Frequency 2560.0, BW 20.0, NO. RB 100, RB POS. Low, 16-QAM

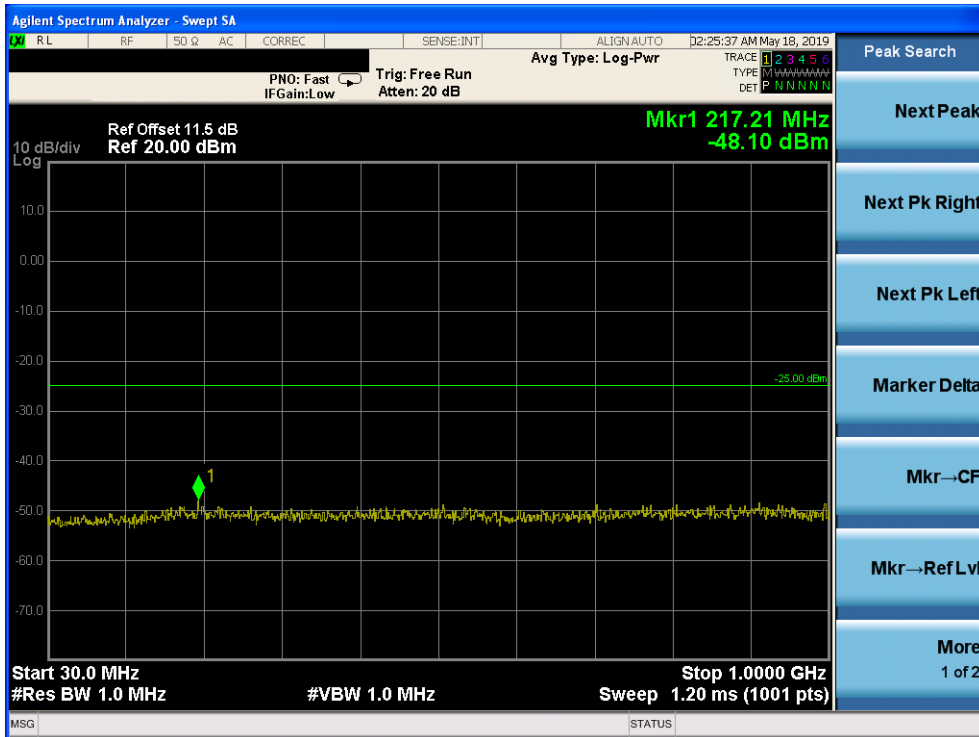

Band 7, UL Channel 21350, UL Frequency 2560.0, BW 20.0, NO. RB 100, RB POS. Low, 16-QAM

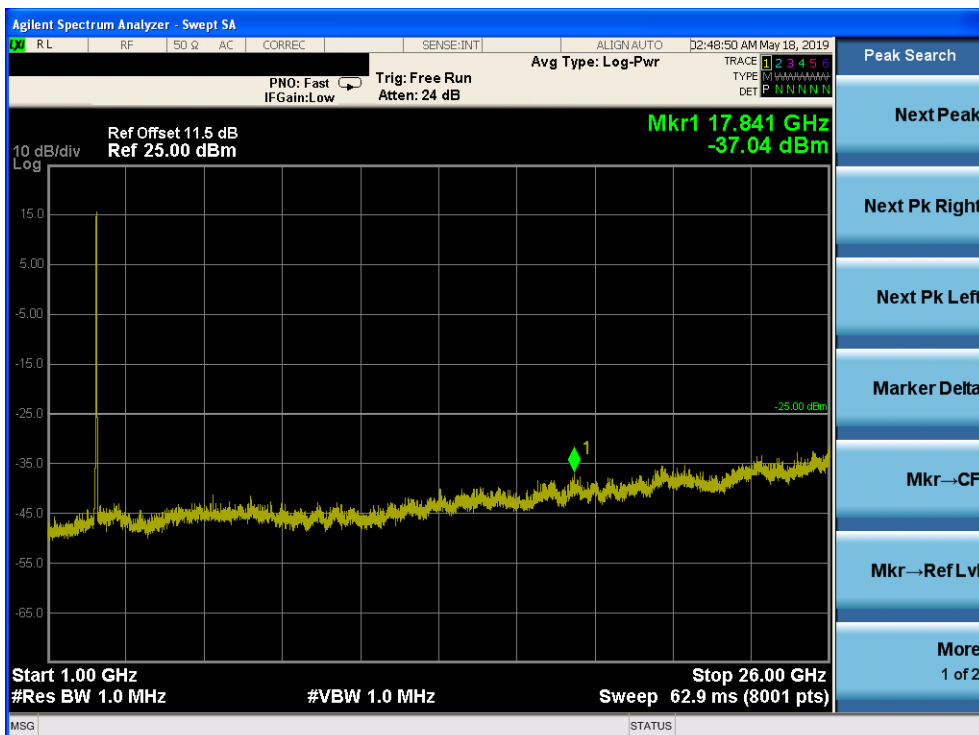

8. RADIATED MEASUREMENT

8.1. RADIATED POWER (ERP & EIRP)

RULE PART(S)

FCC: §2.1046, §22.913, §24.232 and §27.50

LIMITS:

22.913(a) - The ERP of mobile transmitters and auxiliary test transmitters must not exceed 7 Watts.

27.50 (c) (10) the following power and antenna height requirements apply to stations transmitting in the 698–746 MHz band, the portable stations (hand-held devices) are limited to 3 watts ERP.

27.50 (b)(10) Portable stations (hand-held devices) transmitting in the 746–757 MHz, 758–763 MHz, 776–793 MHz, and 805–806 MHz bands are limited to 3 watts ERP.

27.50 (d)(4) The following power and antenna height requirements apply to stations transmitting in the 1710–1755 MHz and 2110–2155 MHz bands: Fixed, mobile, and portable (hand-held) stations operating in the 1710–1755 MHz band are limited to 1 watt EIRP.

TEST PROCEDURE

ANSI/TIA-603-E Clause 2.2.17

KDB 971168 v02r01 RF power output using broadband peak and average power meter method.

KDB 971168 D01 Power Meas License Digital Systems v02r01, "Measurement Guidance for Certification of Licensed Digital Transmitters"

MODES TESTED

- LTE Band 2
- LTE Band 4
- LTE Band5
- LTE Band 7

RESULTS

Pass

8.2 LTE BAND 2

Radiated Power (EIRP) for Band 2										
Mode	RB/ RB SIZE	Frequency	Result						Polarizati on Of Max. ERP	Conclusio n
			SG Level (dBm)	Cable Loss (dBm)	Antenn a Gain (dB)	Max. EIRP Avera ge (dBm)	Max. EIRP			
							Average (mW)			
1.4MHz BW QPSK	6/0	1850.7	-2.62	3.76	28.24	21.86	153.587	Vertical	Pass	
		1880	-2.00	3.91	28.22	22.31	170.138	Vertical	Pass	
		1909.3	-2.03	3.93	28.20	22.24	167.350	Vertical	Pass	
1.4MHz BW 16 QAM	6/0	1850.7	-3.39	3.76	28.24	21.09	128.516	Vertical	Pass	
		1880	-3.60	3.91	28.22	20.71	117.662	Vertical	Pass	
		1909.3	-3.39	3.93	28.20	20.88	122.568	Vertical	Pass	
3.0MHz BW QPSK	15/0	1851.5	-2.33	3.77	28.23	22.13	163.221	Vertical	Pass	
		1880	-1.86	3.91	28.24	22.47	176.685	Vertical	Pass	
		1908.5	-1.95	3.94	28.25	22.36	172.052	Vertical	Pass	
3.0MHz BW 16 QAM	15/0	1851.5	-2.87	3.77	28.23	21.59	144.278	Vertical	Pass	
		1880	-2.80	3.91	28.24	21.53	142.326	Vertical	Pass	
		1908.5	-3.08	3.94	28.25	21.23	132.851	Vertical	Pass	
5.0MHz BW QPSK	25/0	1852.5	-2.38	3.77	28.31	22.16	164.580	Vertical	Pass	
		1880	-2.10	3.91	28.22	22.21	166.473	Vertical	Pass	
		1907.5	-2.14	3.94	28.20	22.12	163.102	Vertical	Pass	
5.0MHz BW 16 QAM	25/0	1852.5	-3.50	3.77	28.31	21.04	127.026	Vertical	Pass	
		1880	-3.03	3.91	28.22	21.28	134.358	Vertical	Pass	
		1907.5	-2.84	3.94	28.20	21.42	138.816	Vertical	Pass	
10.0MHz BW QPSK	50/0	1855	-2.14	3.79	28.33	22.40	173.796	Vertical	Pass	
		1880	-2.40	3.95	28.22	21.87	153.910	Vertical	Pass	
		1905	-1.92	3.97	28.19	22.30	169.661	Vertical	Pass	
10.0MHz BW 16 QAM	50/0	1855	-3.15	3.79	28.33	21.39	137.574	Vertical	Pass	
		1880	-3.18	3.95	28.22	21.09	128.524	Vertical	Pass	
		1905	-3.30	3.97	28.19	20.92	123.602	Vertical	Pass	
15.0MHz BW QPSK	75/0	1857.5	-2.91	3.79	28.34	21.64	145.879	Vertical	Pass	
		1880	-1.86	3.95	28.22	22.41	174.203	Vertical	Pass	
		1902.5	-1.59	3.97	28.18	22.62	182.759	Vertical	Pass	
15.0MHz BW 16 QAM	75/0	1857.5	-3.83	3.79	28.34	20.72	118.101	Vertical	Pass	
		1880	-2.75	3.95	28.22	21.52	141.975	Vertical	Pass	
		1902.5	-3.44	3.97	28.18	20.77	119.502	Vertical	Pass	

20.0MHz BW QPSK	100/ 0	1860	-2.45	3.81	28.35	22.09	161.808	Vertical	Pass
		1880	-1.48	3.96	28.22	22.78	189.671	Vertical	Pass
		1900	-2.17	4.00	28.16	21.99	158.125	Vertical	Pass
20.0MHz BW 16 QAM	100/ 0	1860	-2.29	3.81	28.35	22.25	167.880	Vertical	Pass
		1880	-2.38	3.96	28.22	21.88	154.170	Vertical	Pass
		1900	-2.25	4	28.16	21.91	155.239	Vertical	Pass

Note:

SG Level= Signal generator output

Max. EIRP Average (dBm)= Antenna Gain(dB)+ SG Level (dBm)- Cable Loss(dBm)

Radiated Power (EIRP) for Band 2									
Mode	RB/ RB SIZE	Frequency	Result						Conclusion
			SG Level (dBm)	Cable Loss (dBm)	Anten na Gain (dB)	Max. EIRP Average (dBm)	Max. EIRP Averag e (mW)	Polarizati on Of Max. ERP	
1.4MHz BW QPSK	6/0	1850.7	-2.77	3.76	28.24	21.71	148.318	Horizontal	Pass
		1880	-1.87	3.91	28.22	22.44	175.416	Horizontal	Pass
		1909.3	-2.51	3.93	28.20	21.76	149.980	Horizontal	Pass
1.4MHz BW 16 QAM	6/0	1850.7	-3.29	3.76	28.24	21.19	131.633	Horizontal	Pass
		1880	-3.77	3.91	28.22	20.54	113.262	Horizontal	Pass
		1909.3	-3.57	3.93	28.20	20.70	117.412	Horizontal	Pass
3.0MHz BW QPSK	15/0	1851.5	-2.61	3.77	28.23	21.85	153.111	Horizontal	Pass
		1880	-2.72	3.91	28.24	21.61	145.027	Horizontal	Pass
		1908.5	-2.27	3.94	28.25	22.04	159.830	Horizontal	Pass
3.0MHz BW 16 QAM	15/0	1851.5	-3.41	3.77	28.23	21.05	127.483	Horizontal	Pass
		1880	-3.22	3.91	28.24	21.11	129.224	Horizontal	Pass
		1908.5	-3.80	3.94	28.25	20.51	112.431	Horizontal	Pass
5.0MHz BW QPSK	25/0	1852.5	-2.66	3.77	28.31	21.88	154.315	Horizontal	Pass
		1880	-2.52	3.91	28.22	21.79	151.094	Horizontal	Pass
		1907.5	-2.08	3.94	28.20	22.18	165.014	Horizontal	Pass
5.0MHz BW 16 QAM	25/0	1852.5	-3.57	3.77	28.31	20.97	125.070	Horizontal	Pass
		1880	-2.76	3.91	28.22	21.55	142.727	Horizontal	Pass
		1907.5	-3.56	3.94	28.20	20.70	117.370	Horizontal	Pass
10.0MH z BW QPSK	50/0	1855	-2.86	3.79	28.33	21.68	147.265	Horizontal	Pass
		1880	-2.21	3.95	28.22	22.06	160.526	Horizontal	Pass
		1905	-2.11	3.97	28.19	22.11	162.572	Horizontal	Pass
10.0MH z BW 16 QAM	50/0	1855	-3.61	3.79	28.33	20.93	123.958	Horizontal	Pass
		1880	-3.40	3.95	28.22	20.87	122.133	Horizontal	Pass
		1905	-3.40	3.97	28.19	20.82	120.897	Horizontal	Pass
15.0MH z BW QPSK	75/0	1857.5	-2.89	3.79	28.34	21.66	146.588	Horizontal	Pass
		1880	-2.45	3.95	28.22	21.82	151.959	Horizontal	Pass
		1902.5	-2.10	3.97	28.18	22.11	162.585	Horizontal	Pass
15.0MH z BW 16 QAM	75/0	1857.5	-3.59	3.79	28.34	20.96	124.649	Horizontal	Pass
		1880	-3.67	3.95	28.22	20.60	114.730	Horizontal	Pass
		1902.5	-3.47	3.97	28.18	20.74	118.594	Horizontal	Pass
20.0MH z BW	100/ 0	1860	-1.93	3.81	28.35	22.61	182.390	Horizontal	Pass
		1880	-2.49	3.96	28.22	21.77	150.314	Horizontal	Pass

QPSK		1900	-2.08	4.00	28.16	22.08	161.436	Horizontal	Pass
20.0MHz z BW 16 QAM	100/ 0	1860	-2.62	3.81	28.35	21.92	155.597	Horizontal	Pass
		1880	-2.91	3.96	28.22	21.35	136.458	Horizontal	Pass
		1900	-2.66	4.00	28.16	21.5	141.254	Horizontal	Pass

Note:

SG Level= Signal generator output

Max. EIRP Average (dBm)= Antenna Gain(dB)+ SG Level (dBm)- Cable Loss(dBm)

8.3 LTE BAND 4

Radiated Power (EIRP) for Band 4									
Mode	RB/RB SIZE	Frequency	Result						Conclusion
			SG Level (dBm)	Cable Loss (dBm)	Antenna Gain (dB)	Max. EIRP Average (dBm)	Max. EIRP Average (mW)	Polarization Of Max. ERP	
1.4MHz BW QPSK	6/0	1710.7	-3.61	3.12	27.58	20.85	121.708	Vertical	Pass
		1732.5	-3.97	3.27	27.61	20.37	108.875	Vertical	Pass
		1754.3	-3.87	3.29	27.63	20.47	111.339	Vertical	Pass
1.4MHz BW 16 QAM	6/0	1710.7	-4.31	3.12	27.58	20.15	103.520	Vertical	Pass
		1732.5	-4.97	3.27	27.61	19.37	86.509	Vertical	Pass
		1754.3	-5.03	3.29	27.63	19.31	85.376	Vertical	Pass
3.0MHz BW QPSK	15/0	1711.5	-3.72	3.13	27.61	20.76	119.037	Vertical	Pass
		1732.5	-4.10	3.27	27.61	20.24	105.793	Vertical	Pass
		1753.5	-3.54	3.30	27.62	20.78	119.741	Vertical	Pass
3.0MHz BW 16 QAM	15/0	1711.5	-4.99	3.13	27.61	19.49	88.999	Vertical	Pass
		1732.5	-4.41	3.27	27.61	19.93	98.312	Vertical	Pass
		1753.5	-4.74	3.30	27.62	19.58	90.823	Vertical	Pass
5.0MHz BW QPSK	25/0	1712.5	-3.57	3.13	27.63	20.93	123.841	Vertical	Pass
		1732.5	-3.16	3.27	27.61	21.18	131.139	Vertical	Pass
		1752.5	-3.68	3.30	27.60	20.62	115.300	Vertical	Pass
5.0MHz BW 16 QAM	25/0	1712.5	-4.37	3.13	27.63	20.13	102.934	Vertical	Pass
		1732.5	-4.25	3.27	27.61	20.09	102.125	Vertical	Pass
		1752.5	-4.80	3.30	27.60	19.50	89.192	Vertical	Pass
10.0MHz z BW QPSK	50/0	1715	-3.93	3.15	27.64	20.56	113.738	Vertical	Pass
		1732.5	-3.28	3.31	27.61	21.02	126.352	Vertical	Pass
		1750	-3.03	3.33	27.59	21.23	132.600	Vertical	Pass
10.0MHz z BW 16 QAM	50/0	1715	-5.15	3.15	27.64	19.34	86.000	Vertical	Pass
		1732.5	-4.13	3.31	27.61	20.17	104.035	Vertical	Pass
		1750	-4.95	3.33	27.59	19.31	85.322	Vertical	Pass
15.0MHz z BW QPSK	75/0	1717.5	-3.93	3.15	27.65	20.57	114.014	Vertical	Pass
		1732.5	-3.94	3.31	27.61	20.36	108.672	Vertical	Pass
		1747.5	-3.49	3.33	27.57	20.75	118.897	Vertical	Pass
15.0MHz z BW 16 QAM	75/0	1717.5	-4.55	3.15	27.65	19.95	98.962	Vertical	Pass
		1732.5	-4.95	3.31	27.61	19.35	86.142	Vertical	Pass
		1747.5	-4.53	3.33	27.57	19.71	93.560	Vertical	Pass

20.0MH z BW QPSK	100/0	1720	-3.07	3.17	27.66	21.42	138.676	Vertical	Pass
		1732.5	-3.04	3.32	27.61	21.25	133.352	Vertical	Pass
		1745	-3.24	3.36	27.56	20.96	124.738	Vertical	Pass
20.0MH z BW 16 QAM	100/0	1720	-2.69	3.17	27.66	21.8	151.356	Vertical	Pass
		1732.5	-3.49	3.32	27.61	20.8	120.226	Vertical	Pass
		1745	-3.64	3.36	27.56	20.56	113.763	Vertical	Pass

Note:

SG Level= Signal generator output

Max. EIRP Average (dBm)= Antenna Gain(dB)+ SG Level (dBm)- Cable Loss(dBm)

Radiated Power (EIRP) for Band 4									
Mode	RB/RB SIZE	Frequency	Result						Conclusion
			SG Level (dBm)	Cable Loss (dBm)	Antenna Gain (dB)	Max. EIRP Average (dBm)	Max. EIRP Average (mW)	Polarization Of Max. ERP	
1.4MHz BW QPSK	6/0	1710.7	-4.01	3.12	27.58	20.45	110.983	Horizontal	Pass
		1732.5	-4.00	3.27	27.61	20.34	108.062	Horizontal	Pass
		1754.3	-3.76	3.29	27.63	20.58	114.343	Horizontal	Pass
1.4MHz BW 16 QAM	6/0	1710.7	-4.94	3.12	27.58	19.52	89.583	Horizontal	Pass
		1732.5	-5.07	3.27	27.61	19.27	84.513	Horizontal	Pass
		1754.3	-5.17	3.29	27.63	19.17	82.661	Horizontal	Pass
3.0MHz BW QPSK	15/0	1711.5	-4.24	3.13	27.61	20.24	105.766	Horizontal	Pass
		1732.5	-4.11	3.27	27.61	20.23	105.531	Horizontal	Pass
		1753.5	-3.82	3.30	27.62	20.50	112.178	Horizontal	Pass
3.0MHz BW 16 QAM	15/0	1711.5	-5.59	3.13	27.61	18.89	77.457	Horizontal	Pass
		1732.5	-4.66	3.27	27.61	19.68	92.857	Horizontal	Pass
		1753.5	-4.67	3.30	27.62	19.65	92.353	Horizontal	Pass
5.0MHz BW QPSK	25/0	1712.5	-3.23	3.13	27.63	21.27	133.860	Horizontal	Pass
		1732.5	-3.52	3.27	27.61	20.82	120.865	Horizontal	Pass
		1752.5	-3.57	3.30	27.60	20.73	118.217	Horizontal	Pass
5.0MHz BW 16 QAM	25/0	1712.5	-4.43	3.13	27.63	20.07	101.674	Horizontal	Pass
		1732.5	-4.80	3.27	27.61	19.54	89.922	Horizontal	Pass
		1752.5	-5.19	3.30	27.60	19.11	81.486	Horizontal	Pass
10.0MHz z BW QPSK	50/0	1715	-4.09	3.15	27.64	20.40	109.532	Horizontal	Pass
		1732.5	-3.71	3.31	27.61	20.59	114.622	Horizontal	Pass
		1750	-3.40	3.33	27.59	20.86	121.775	Horizontal	Pass
10.0MHz z BW 16 QAM	50/0	1715	-4.85	3.15	27.64	19.64	92.124	Horizontal	Pass
		1732.5	-5.30	3.31	27.61	19.00	79.417	Horizontal	Pass
		1750	-4.73	3.33	27.59	19.53	89.798	Horizontal	Pass
15.0MHz z BW QPSK	75/0	1717.5	-4.43	3.15	27.65	20.07	101.708	Horizontal	Pass
		1732.5	-3.89	3.31	27.61	20.41	109.938	Horizontal	Pass
		1747.5	-3.72	3.33	27.57	20.52	112.727	Horizontal	Pass
15.0MHz z BW 16 QAM	75/0	1717.5	-4.56	3.15	27.65	19.94	98.633	Horizontal	Pass
		1732.5	-4.86	3.31	27.61	19.44	87.937	Horizontal	Pass
		1747.5	-5.20	3.33	27.57	19.04	80.170	Horizontal	Pass
20.0MHz z BW	100/0	1720	-3.41	3.17	27.66	21.08	128.233	Horizontal	Pass
		1732.5	-3.32	3.32	27.61	20.97	125.026	Horizontal	Pass

QPSK		1745	-3.19	3.36	27.56	21.01	126.183	Horizontal	Pass
20.0MH	100/0	1720	-3.16	3.17	27.66	21.33	135.831	Horizontal	Pass
z BW 16		1732.5	-3.64	3.32	27.61	20.65	116.145	Horizontal	Pass
QAM		1745	-3.82	3.36	27.56	20.38	109.144	Horizontal	Pass

Note:

SG Level= Signal generator output

Max. EIRP Average (dBm)= Antenna Gain(dB)+ SG Level (dBm)- Cable Loss(dBm)

8.4 LTE BAND 5

Radiated Power (ERP) for Band 5										
Mode	RB/ RB SIZE	Freque ncy	Result							Conclu sion
			SG Level (dBm)	Cable Loss (dBm)	Anten na Gain (dB)	Corre ction (dB)	Max. EIRP Averag e (dBm)	Max. EIRP Averag e (mW)	Polarizati on Of Max. ERP	
1.4MHz BW QPSK	6/0	824.7	3.45	2.01	19.68	2.15	18.97	78.910	Vertical	Pass
		836.5	3.23	2.01	19.77	2.15	18.84	76.640	Vertical	Pass
		848.3	3.39	2.02	19.82	2.15	19.04	80.231	Vertical	Pass
1.4MHz BW 16 QAM	6/0	824.7	2.21	2.01	19.68	2.15	17.73	59.284	Vertical	Pass
		836.5	2.38	2.01	19.77	2.15	17.99	62.909	Vertical	Pass
		848.3	2.01	2.02	19.82	2.15	17.66	58.337	Vertical	Pass
3.0MHz BW QPSK	15/0	825.5	2.96	2.01	19.70	2.15	18.50	70.825	Vertical	Pass
		836.5	3.33	2.01	19.77	2.15	18.94	78.350	Vertical	Pass
		847.5	3.04	2.02	19.81	2.15	18.68	73.726	Vertical	Pass
3.0MHz BW 16 QAM	15/0	825.5	1.78	2.01	19.70	2.15	17.32	53.962	Vertical	Pass
		836.5	1.42	2.01	19.77	2.15	17.03	50.480	Vertical	Pass
		847.5	2.20	2.02	19.81	2.15	17.84	60.819	Vertical	Pass
5.0MHz BW QPSK	25/0	826.5	2.57	2.01	19.71	2.15	18.12	64.862	Vertical	Pass
		836.5	3.58	2.01	19.77	2.15	19.19	82.967	Vertical	Pass
		846.5	2.75	2.02	19.79	2.15	18.37	68.686	Vertical	Pass
5.0MHz BW 16 QAM	25/0	826.5	2.26	2.01	19.71	2.15	17.81	60.342	Vertical	Pass
		836.5	1.34	2.01	19.77	2.15	16.95	49.569	Vertical	Pass
		846.5	2.16	2.02	19.79	2.15	17.78	59.934	Vertical	Pass
10.0MH z BW QPSK	50/0	829	3.46	2.01	19.73	2.15	19.03	79.983	Vertical	Pass
		836.5	3.74	2.01	19.77	2.15	19.35	86.099	Vertical	Pass
		844	3.92	2.02	19.78	2.15	19.53	89.743	Vertical	Pass
10.0MH z BW 16 QAM	50/0	829	4	2.01	19.73	2.15	19.57	90.573	Vertical	Pass
		836.5	2.99	2.01	19.77	2.15	18.6	72.444	Vertical	Pass
		844	2.89	2.02	19.78	2.15	18.5	70.795	Vertical	Pass

Note:

SG Level= Signal generator output

Max. EIRP Average (dBm)= Antenna Gain(dB)+ SG Level (dBm)- Cable Loss(dBm)

Radiated Power (ERP) for Band 5										
Mode	RB/ RB SIZE	Freque ncy	Result							Conclu sion
			SG Level (dBm)	Cable Loss (dBm)	Anten na Gain (dB)	Corre ction (dB)	Max. EIRP Averag e (dBm)	Max. EIRP Averag e (mW)	Polarizati on Of Max. ERP	
1.4MHz BW QPSK	6/0	824.7	3.22	2.01	19.68	2.15	18.74	74.858	Horizontal	Pass
		836.5	2.09	2.01	19.77	2.15	17.70	58.891	Horizontal	Pass
		848.3	3.09	2.02	19.82	2.15	18.74	74.752	Horizontal	Pass
1.4MHz BW 16 QAM	6/0	824.7	2.25	2.01	19.68	2.15	17.77	59.855	Horizontal	Pass
		836.5	1.39	2.01	19.77	2.15	17.00	50.119	Horizontal	Pass
		848.3	1.45	2.02	19.82	2.15	17.10	51.339	Horizontal	Pass
3.0MHz BW QPSK	15/0	825.5	2.55	2.01	19.70	2.15	18.09	64.418	Horizontal	Pass
		836.5	2.24	2.01	19.77	2.15	17.85	60.941	Horizontal	Pass
		847.5	2.96	2.02	19.81	2.15	18.60	72.485	Horizontal	Pass
3.0MHz BW 16 QAM	15/0	825.5	1.50	2.01	19.70	2.15	17.04	50.540	Horizontal	Pass
		836.5	1.38	2.01	19.77	2.15	16.99	49.992	Horizontal	Pass
		847.5	1.56	2.02	19.81	2.15	17.20	52.426	Horizontal	Pass
5.0MHz BW QPSK	25/0	826.5	2.60	2.01	19.71	2.15	18.15	65.239	Horizontal	Pass
		836.5	1.70	2.01	19.77	2.15	17.31	53.869	Horizontal	Pass
		846.5	2.93	2.02	19.79	2.15	18.55	71.675	Horizontal	Pass
5.0MHz BW 16 QAM	25/0	826.5	1.26	2.01	19.71	2.15	16.81	47.961	Horizontal	Pass
		836.5	1.34	2.01	19.77	2.15	16.95	49.542	Horizontal	Pass
		846.5	1.86	2.02	19.79	2.15	17.48	55.959	Horizontal	Pass
10.0MH z BW QPSK	50/0	829	3.47	2.01	19.73	2.15	19.04	80.168	Horizontal	Pass
		836.5	3.46	2.01	19.77	2.15	19.07	80.724	Horizontal	Pass
		844	3.39	2.02	19.78	2.15	19	79.433	Horizontal	Pass
10.0MH z BW 16 QAM	50/0	829	2.48	2.01	19.73	2.15	18.05	63.826	Horizontal	Pass
		836.5	2.36	2.01	19.77	2.15	17.97	62.661	Horizontal	Pass
		844	2.57	2.02	19.78	2.15	18.18	65.766	Horizontal	Pass

Note:

SG Level= Signal generator output

Max. EIRP Average (dBm)= Antenna Gain(dB)+ SG Level (dBm)- Cable Loss(dBm)

8.5 LTE BAND 7

Radiated Power (EIRP) for Band 7									
Mode	RB/ RB SIZE	Frequency	Result						Conclusion
			SG Level (dBm)	Cabl e Loss (dBm)	Antenn a Gain (dB)	Max. EIRP Averag e (dBm)	Max. EIRP Averag e (mW)	Polarizati on Of Max. ERP	
5.0MHz BW QPSK	25/0	2502.5	-3.67	4.54	27.75	19.54	89.913	Vertical	Pass
		2535	-3.33	4.69	27.72	19.70	93.219	Vertical	Pass
		2567.5	-3.48	4.71	27.71	19.52	89.524	Vertical	Pass
5.0MHz BW 16 QAM	25/0	2502.5	-4.76	4.54	27.75	18.45	70.046	Vertical	Pass
		2535	-4.55	4.69	27.72	18.48	70.448	Vertical	Pass
		2567.5	-4.49	4.71	27.71	18.51	70.997	Vertical	Pass
10.0MH z BW QPSK	50/0	2505	-3.32	4.55	27.76	19.89	97.517	Vertical	Pass
		2535	-3.11	4.69	27.72	19.92	98.285	Vertical	Pass
		2565	-2.60	4.72	27.70	20.38	109.262	Vertical	Pass
10.0MH z BW 16 QAM	50/0	2505	-4.27	4.55	27.76	18.94	78.363	Vertical	Pass
		2535	-4.05	4.69	27.72	18.98	79.139	Vertical	Pass
		2565	-4.33	4.72	27.70	18.65	73.330	Vertical	Pass
15.0MH z BW QPSK	75/0	2507.5	-3.52	4.55	27.77	19.70	93.280	Vertical	Pass
		2535	-2.82	4.69	27.72	20.21	104.878	Vertical	Pass
		2562.5	-3.05	4.72	27.69	19.92	98.287	Vertical	Pass
15.0MH z BW 16 QAM	75/0	2507.5	-4.31	4.55	27.77	18.91	77.803	Vertical	Pass
		2535	-3.61	4.69	27.72	19.42	87.406	Vertical	Pass
		2562.5	-3.85	4.72	27.69	19.12	81.613	Vertical	Pass
20.0MH z BW QPSK	100/ 0	2510	-1.71	4.57	27.78	21.50	141.254	Vertical	Pass
		2535	-2.24	4.73	27.72	20.75	118.850	Vertical	Pass
		2560	-2.49	4.75	27.68	20.44	110.662	Vertical	Pass
20.0MH z BW 16 QAM	100/ 0	2510	-2.37	4.57	27.78	20.84	121.339	Vertical	Pass
		2535	-2.03	4.73	27.72	20.96	124.738	Vertical	Pass
		2560	-1.9	4.75	27.68	21.03	126.765	Vertical	Pass

Note:

SG Level= Signal generator output

Max. EIRP Average (dBm)= Antenna Gain(dB)+ SG Level (dBm)- Cable Loss(dBm)

Radiated Power (EIRP) for Band 7									
Mode	RB/ RB SIZE	Frequency	Result						Conclusion
			SG Level (dBm)	Cabl e Loss (dBm)	Antenn a Gain (dB)	Max. EIRP Averag e (dBm)	Max. EIRP Averag e (mW)	Polarizati on Of Max. ERP	
5.0MHz BW QPSK	25/0	2502.5	-3.76	4.54	27.75	19.45	88.127	Horizontal	Pass
		2535	-3.46	4.69	27.72	19.57	90.587	Horizontal	Pass
		2567.5	-3.74	4.71	27.71	19.26	84.249	Horizontal	Pass
5.0MHz BW 16 QAM	25/0	2502.5	-4.78	4.54	27.75	18.43	69.689	Horizontal	Pass
		2535	-4.78	4.69	27.72	18.25	66.896	Horizontal	Pass
		2567.5	-4.53	4.71	27.71	18.47	70.249	Horizontal	Pass
10.0MH z BW QPSK	50/0	2505	-3.09	4.55	27.76	20.12	102.836	Horizontal	Pass
		2535	-3.19	4.69	27.72	19.84	96.404	Horizontal	Pass
		2565	-3.10	4.72	27.7	19.88	97.290	Horizontal	Pass
10.0MH z BW 16 QAM	50/0	2505	-4.80	4.55	27.76	18.41	69.382	Horizontal	Pass
		2535	-3.46	4.69	27.72	19.57	90.514	Horizontal	Pass
		2565	-3.88	4.72	27.7	19.10	81.230	Horizontal	Pass
15.0MH z BW QPSK	75/0	2507.5	-3.55	4.55	27.77	19.67	92.626	Horizontal	Pass
		2535	-3.30	4.69	27.72	19.73	94.037	Horizontal	Pass
		2562.5	-3.77	4.72	27.69	19.20	83.173	Horizontal	Pass
15.0MH z BW 16 QAM	75/0	2507.5	-3.96	4.55	27.77	19.26	84.360	Horizontal	Pass
		2535	-4.18	4.69	27.72	18.85	76.651	Horizontal	Pass
		2562.5	-4.47	4.72	27.69	18.50	70.845	Horizontal	Pass
20.0MH z BW QPSK	100/ 0	2510	-3.14	4.57	27.78	20.07	101.720	Horizontal	Pass
		2535	-2.94	4.73	27.72	20.05	101.251	Horizontal	Pass
		2560	-3.41	4.75	27.68	19.52	89.616	Horizontal	Pass
20.0MH z BW 16 QAM	100/ 0	2510	-4.41	4.57	27.78	18.80	75.865	Horizontal	Pass
		2535	-4.81	4.73	27.72	18.18	65.703	Horizontal	Pass
		2560	-4.33	4.75	27.68	18.60	72.474	Horizontal	Pass

Note:

SG Level= Signal generator output

Max. EIRP Average (dBm)= Antenna Gain(dB)+ SG Level (dBm)- Cable Loss(dBm)

9. SPURIOUS RADIATION EMISSION

RULE PART(S)

FCC: §2.1053, §22.917, §24.238 and §27.53

LIMIT

§22.917 (e) and §24.238 (a): Out of band emissions. The power of any emission outside of the authorized operating frequency ranges must be attenuated below the transmitting power (P) by a factor of at least $43 + 10 \log (P)$ dB.

§27.53 (g) For operations in the 698–746 MHz band, the power of any emission outside a licensee's frequency band(s) of operation shall be attenuated below the transmitter power (P) within the licensed band(s) of operation, measured in watts, by at least $43 + 10 \log (P)$ dB.

§27.53 (h) For operations in the 1710–1755 MHz and 2110–2155 MHz bands, the power of any emission outside a licensee's frequency block shall be attenuated below the transmitter power (P) by at least $43 + 10 \log_{10}(P)$ dB.

TEST PROCEDURE

For Cellular equipment - Compliance with these rules is based on the use of measurement instrumentation employing a resolution bandwidth of 100 kHz or greater. In the 1 MHz bands immediately outside and adjacent to the frequency block a resolution bandwidth of at least one percent of the emission bandwidth of the fundamental emission of the transmitter may be employed. A narrower resolution bandwidth is permitted in all cases to improve measurement accuracy provided the measured power is integrated over the full required measurement bandwidth (i.e. 100 kHz or 1 percent of emission bandwidth, as specified). The emission bandwidth is defined as the width of the signal between two points, one below the carrier center frequency and one above the carrier center frequency, outside of which all emissions are attenuated at least 26 dB below the transmitter power.

For PCS equipment - Compliance with these rules is based on the use of measurement instrumentation employing a resolution bandwidth of 1 MHz or greater. However, in the 1 MHz bands immediately outside and adjacent to the frequency block a resolution bandwidth of at least one percent of the emission bandwidth of the fundamental emission of the transmitter may be employed. A narrower resolution bandwidth is permitted in all cases to improve measurement accuracy provided the measured power is integrated over the full required measurement bandwidth (i.e. 1 MHz or 1 percent of emission bandwidth, as specified). The emission bandwidth is defined as the width of the signal between two points, one below the carrier center frequency and one above the carrier center frequency, outside of which all emissions are attenuated at least 26 dB below the transmitter power.

The unwanted emission power shall be measured with a resolution bandwidth of at least 1% of the occupied bandwidth in the 1 MHz band immediately outside and adjacent to the channel edge of the equipment. Beyond the 1 MHz band immediately outside the channel edge of the equipment, a resolution bandwidth of 1 MHz shall be employed. A narrower resolution bandwidth is allowed to be used provided that the measured power is integrated over the full required measurement bandwidth of 1 MHz or 1% of the occupied bandwidth as applicable.

The power of any unwanted emissions measured from the channel edge of the equipment shall be attenuated below the transmitter power, P (dBW), as follows:

- a. for base station and subscriber equipment, other than mobile subscriber equipment, the attenuation shall not be less than $43 + 10 \text{ Log}_{10}(p)$, dB; and
- b. for mobile subscriber equipment, the attenuation shall not be less than $43 + 10 \text{ Log}_{10}(p)$, dB at the channel edges and $55 + 10 \text{ Log}_{10}(p)$ at 5.5 MHz away and beyond the channel edges where p in (a) and (b) is the transmitter power measured in watts.

MODES TESTED

- LTE Band 2
LTE Band 4
- LTE Band 5
LTE Band 7

RESULTS

PASS

9.1 LTE BAND 2

QPSK EIRP POWER FOR LTE BAND 2 (1.4MHZ BANDWIDTH)

Test Results for Low Channel 1850.7MHz							
Frequency(MHz)	SG Level(dBm)	Cable Loss(dB)	Antenna Gain(dB)	Absolute Level(dBm)	Limit (dBm)	Margin(dBm)	Polarity
3701.4	-51.82	4.04	33.51	-22.35	-13	-9.35	Horizontal
3701.4	-53.88	4.04	33.51	-24.41	-13	-11.41	Vertical
5552.1	-56.39	5.24	35.84	-25.79	-13	-12.79	Vertical
5552.1	-67.12	5.24	35.84	-36.52	-13	-23.52	Horizontal
Test Results for Mid Channel 1880MHz							
3760	-52.90	4.04	33.56	-23.38	-13	-10.38	Horizontal
3760	-53.99	4.04	33.56	-24.47	-13	-11.47	Vertical
5640	-54.47	5.24	35.91	-23.80	-13	-10.80	Vertical
5640	-56.15	5.24	35.91	-25.48	-13	-12.48	Horizontal
Test Results for High Channel 1909.3MHz							
3818.6	-53.24	4.04	34.00	-23.28	-13	-10.28	Horizontal
3818.6	-55.32	4.04	34.00	-25.36	-13	-12.36	Vertical
5727.9	-56.94	5.24	36.04	-26.14	-13	-13.14	Vertical
5727.9	-56.35	5.24	36.04	-25.55	-13	-12.55	Horizontal

QPSK EIRP POWER FOR LTE BAND 2 (20.0MHZ BANDWIDTH)

Test Results for Low Channel 1860MHz							
Frequency(MHz)	SG Level(dBm)	Cable Loss(dB)	Antenna Gain(dB)	Absolute Level(dBm)	Limit (dBm)	Margin(dBm)	Polarity
3720	-57.10	4.07	33.54	-27.63	-13	-14.63	Horizontal
3720	-51.51	4.07	33.54	-22.04	-13	-9.04	Vertical
5580	-58.57	5.28	35.86	-27.99	-13	-14.99	Vertical
5580	-59.37	5.28	35.86	-28.79	-13	-15.79	Horizontal
Test Results for Mid Channel 1880MHz							
3760	-56.79	4.04	33.56	-27.27	-13	-14.27	Horizontal
3760	-53.52	4.04	33.56	-24.00	-13	-11.00	Vertical
5640	-57.58	5.24	35.91	-26.91	-13	-13.91	Vertical
5640	-58.44	5.24	35.91	-27.77	-13	-14.77	Horizontal
Test Results for High Channel 1900MHz							
3800	-55.25	4.04	34.00	-25.29	-13	-12.29	Horizontal
3800	-56.22	4.04	34.00	-26.26	-13	-13.26	Vertical
5700	-57.50	5.24	36.04	-26.70	-13	-13.70	Vertical
5700	-56.10	5.24	36.04	-25.30	-13	-12.30	Horizontal

Note: P_{Mea}(dBm)= Power(dBm)+ AR_{pl} (dBm)

. Over Limit= : P_{Mea}(dBm)-Limit(dBm)

. We test both H direction and V direction, recorded worst case direction.

9.2 LTE BAND 4

QPSK EIRP POWER FOR LTE BAND 4 (1.4MHZ BANDWIDTH)

Test Results for Low Channel 1710.7MHz							
Frequency(MHz)	SG Level(dBm)	Cable Loss(dB)	Antenna Gain(dB)	Absolute Level(dBm)	Limit (dBm)	Margin(dBm)	Polarity
3421.4	-59.41	4.02	29.80	-33.63	-13	-20.63	Horizontal
3421.4	-56.79	4.02	29.80	-31.01	-13	-18.01	Vertical
5132.1	-61.07	5.24	35.84	-30.47	-13	-17.47	Vertical
5132.1	-62.12	5.24	35.84	-31.52	-13	-18.52	Horizontal
Test Results for Mid Channel 1732.5MHz							
3465	-50.88	4.03	30.00	-24.91	-13	-11.91	Horizontal
3465	-54.66	4.03	30.00	-28.69	-13	-15.69	Vertical
5197.5	-58.14	5.25	35.86	-27.53	-13	-14.53	Vertical
5197.5	-55.99	5.25	35.86	-25.38	-13	-12.38	Horizontal
Test Results for High Channel 1754.3MHz							
3508.6	-51.11	4.05	30.01	-25.15	-13	-12.15	Horizontal
3508.6	-57.02	4.05	30.01	-31.06	-13	-18.06	Vertical
5262.9	-57.21	5.26	35.86	-26.61	-13	-13.61	Vertical
5262.9	-54.67	5.26	35.86	-24.07	-13	-11.07	Horizontal

QPSK EIRP POWER FOR LTE BAND 4 (20.0MHZ BANDWIDTH)

Test Results for Low Channel 1720MHz							
Frequency(MHz)	SG Level(dBm)	Cable Loss(dB)	Antenna Gain(dB)	Absolute Level(dBm)	Limit (dBm)	Margin(dBm)	Polarity
3440	-56.61	4.02	29.80	-30.83	-13	-17.83	Horizontal
3440	-57.27	4.02	29.80	-31.49	-13	-18.49	Vertical
5160	-59.72	5.24	35.84	-29.12	-13	-16.12	Vertical
5160	-62.14	5.24	35.84	-31.54	-13	-18.54	Horizontal
Test Results for Mid Channel 1732.5MHz							
3465	-50.20	4.03	30.00	-24.23	-13	-11.23	Horizontal
3465	-54.18	4.03	30.00	-28.21	-13	-15.21	Vertical
5197.5	-59.81	5.25	35.86	-29.20	-13	-16.20	Vertical
5197.5	-58.94	5.25	35.86	-28.33	-13	-15.33	Horizontal
Test Results for High Channel 1745MHz							
3490	-53.49	2.91	27.68	-28.72	-13	-15.72	Horizontal
3490	-54.65	2.91	27.68	-29.88	-13	-16.88	Vertical
5235	-58.45	5.26	35.86	-27.85	-13	-14.85	Vertical
5235	-57.71	5.26	35.86	-27.11	-13	-14.11	Horizontal

Note: P_{Mea}(dBm)= Power(dBm)+ ARpl (dBm)
 Over Limit= : P_{Mea}(dBm)-Limit(dBm)
 We test both H direction and V direction, recorded worst case direction.

9.3 LTE BAND 5

QPSK EIRP POWER FOR LTE BAND 5 (1.4MHZ BANDWIDTH)

Test Results for Low Channel 824.7MHz							
Frequency(MHz)	SG Level(dBm)	Cable Loss(dB)	Antenna Gain(dB)	Absolute Level(dBm)	Limit (dBm)	Margin(dBm)	Polarity
1649.4	-55.54	2.78	27.50	-30.82	-13	-17.82	Horizontal
1649.4	-50.12	2.78	27.50	-25.40	-13	-12.40	Vertical
2474.1	-53.26	2.90	27.80	-28.36	-13	-15.36	Vertical
2474.1	-54.47	2.90	27.80	-29.57	-13	-16.57	Horizontal
Test Results For Mid Channel 836.5MHz							
1673	-56.52	2.80	27.48	-31.84	-13	-18.84	Horizontal
1673	-54.48	2.80	27.48	-29.80	-13	-16.80	Vertical
2509.5	-56.92	2.91	27.70	-32.13	-13	-19.13	Vertical
2509.5	-52.85	2.91	27.70	-28.06	-13	-15.06	Horizontal
Test Results for High Channel 848.3MHz							
1696.6	-54.41	2.82	27.43	-29.80	-13	-16.80	Horizontal
1696.6	-54.48	2.82	27.43	-29.87	-13	-16.87	Vertical
2544.9	-49.98	2.92	27.74	-25.16	-13	-12.16	Vertical
2544.9	-56.53	2.92	27.74	-31.71	-13	-18.71	Horizontal

QPSK EIRP POWER FOR LTE BAND 5 (10MHZ BANDWIDTH)

Test Results for Low Channel 829MHz							
Frequency(MHz)	SG Level(dBm)	Cable Loss(dB)	Antenna Gain(dB)	Absolute Level(dBm)	Limit (dBm)	Margin(dBm)	Polarity
1658	-54.47	2.78	27.50	-29.75	-13	-16.75	Horizontal
1658	-56.59	2.78	27.50	-31.87	-13	-18.87	Vertical
2487	-56.86	2.90	27.80	-31.96	-13	-18.96	Vertical
2487	-49.97	2.90	27.80	-25.07	-13	-12.07	Horizontal
Test Results For Mid Channel 836.5MHz							
1673	-53.65	2.80	27.48	-28.97	-13	-15.97	Horizontal
1673	-56.65	2.80	27.48	-31.97	-13	-18.97	Vertical
2509.5	-57.74	2.91	27.70	-32.95	-13	-19.95	Vertical
2509.5	-56.58	2.91	27.70	-31.79	-13	-18.79	Horizontal
Test Results for High Channel 844MHz							
1688	-55.58	2.82	27.43	-30.97	-13	-17.97	Horizontal
1688	-56.59	2.82	27.43	-31.98	-13	-18.98	Vertical
2532	-55.58	2.92	27.74	-30.76	-13	-17.76	Vertical
2532	-56.63	2.92	27.74	-31.81	-13	-18.81	Horizontal

Note: P_{Mea}(dBm)= Power(dBm)+ AR_{pl} (dBm)

. Over Limit= : P_{Mea}(dBm)-Limit(dBm)

. We test both H direction and V direction, recorded worst case direction.

9.4 LTE BAND 7

QPSK EIRP POWER FOR LTE BAND 7 (5.0MHZ BANDWIDTH)

Test Results for Low Channel 2502.5MHz							
Frequency(MHz)	SG Level(dBm)	Cable Loss(dB)	Antenna Gain(dB)	Absolute Level(dBm)	Limit (dBm)	Margin(dBm)	Polarity
5005	-63.65	5.23	35.81	-33.07	-25	-8.07	Horizontal
5005	-62.54	5.23	35.81	-31.96	-25	-6.96	Vertical
7507.5	-62.67	5.67	36.85	-31.49	-25	-6.49	Vertical
7507.5	-63.74	5.67	36.85	-32.56	-25	-7.56	Horizontal
Test Results for Mid Channel 2535MHz							
5070	-62.62	5.23	35.82	-32.03	-25	-7.03	Horizontal
5070	-61.64	5.23	35.82	-31.05	-25	-6.05	Vertical
7605	-61.41	5.67	36.85	-30.23	-25	-5.23	Vertical
7605	-63.26	5.67	36.85	-32.08	-25	-7.08	Horizontal
Test Results for High Channel 2567.5MHz							
5135	-70.85	5.24	35.83	-40.26	-25	-15.26	Horizontal
5135	-69.93	5.24	35.83	-39.34	-25	-14.34	Vertical
7702.5	-62.64	5.68	36.87	-31.45	-25	-6.45	Vertical
7702.5	-67.74	5.68	36.87	-36.55	-25	-11.55	Horizontal

QPSK EIRP POWER FOR LTE BAND 7 (20.0MHZ BANDWIDTH)

Test Results for Low Channel 2510MHz							
Frequency(MHz)	SG Level(dBm)	Cable Loss(dB)	Antenna Gain(dB)	Absolute Level(dBm)	Limit (dBm)	Margin(dBm)	Polarity
5020	-63.65	5.23	35.82	-33.06	-25	-8.06	Horizontal
5020	-62.42	5.23	35.82	-31.83	-25	-6.83	Vertical
7530	-63.62	5.67	36.86	-32.43	-25	-7.43	Vertical
7530	-64.78	5.67	36.86	-33.59	-25	-8.59	Horizontal
Test Results for Mid Channel 2535MHz							
5070	-63.26	5.23	35.82	-32.67	-25	-7.67	Horizontal
5070	-62.51	5.23	35.82	-31.92	-25	-6.92	Vertical
7605	-60.95	5.67	36.85	-29.77	-25	-4.77	Vertical
7605	-64.28	5.67	36.85	-33.10	-25	-8.10	Horizontal
Test Results for High Channel 2560MHz							
5120	-62.21	5.24	35.83	-31.62	-25	-6.62	Horizontal
5120	-61.61	5.24	35.83	-31.02	-25	-6.02	Vertical
7680	-62.64	5.70	36.88	-31.46	-25	-6.46	Vertical
7680	-63.64	5.70	36.88	-32.46	-25	-7.46	Horizontal

Note: P_{Mea}(dBm)= Power(dBm)+ AR_{pl} (dBm)

Over Limit= : P_{Mea}(dBm)-Limit(dBm)

We test both H direction and V direction, recorded worst case direction.

10. FREQUENCY STABILITY

RULE PART(S)

FCC: §2.1055, §22.355, §24.235, §27.54

LIMITS

§22.355 - The carrier frequency shall not depart from the reference frequency in excess of ± 2.5 ppm for mobile stations.

§24.235 - The frequency stability shall be sufficient to ensure that the fundamental emission stays within the authorized frequency block.

TEST PROCEDURE

Use CMW 500 with Frequency Error measurement capability.

- Temp. = -30° to $+50^{\circ}$ C
- Voltage = low voltage, DC 3.6V, Normal, DC 3.8V and High voltage, DC DC 4.4V.

Frequency Stability vs Temperature:

The EUT is placed inside a temperature chamber. The temperature is set to -30° C and allowed to stabilize. After sufficient soak time, the transmitting frequency error is measured. The temperature is increased by 10 degrees, allowed to stabilize and soak, and then the measurement is repeated. This is repeated until $+50^{\circ}$ C is reached.

Frequency Stability vs Voltage:

The peak frequency error is recorded (worst-case).

MODES TESTED

- LTE Band 2
LTE Band 4
- LTE Band 5
LTE Band 7

RESULTS

See the following pages.

10.1 LTE BAND 2

QPSK, (20MHz BANDWIDTH)

Frequency error vs. Voltage

Voltage [Vdc]	Frequency [MHz]	Frequency* Error[Hz]	Frequency Error[ppm]	Limit [ppm]
BAND 2 QPSK, (CH 18900 RB size 100 RB Offset 0 20MHz BANDWIDTH)				
3.2	1880	-14.7	-0.007819	2.5
3.8	1880	-14.8	-0.007872	2.5
4.4	1880	-14.3	-0.007606	2.5

Frequency error vs. Temperature

Temperature [° C]	Frequency [MHz]	Frequency* Error[Hz]	Frequency Error[ppm]	Limit [ppm]
BAND 2 QPSK, (CH 18900 RB size 100 RB Offset 0 20MHz BANDWIDTH)				
Normal (25C)	1880	-14.7	-0.007819	2.5
Extreme (50C)	1880	-15.6	-0.008298	2.5
Extreme (40C)	1880	-15.7	-0.008351	2.5
Extreme (30C)	1880	-14.8	-0.007872	2.5
Extreme (10C)	1880	-14.3	-0.007606	2.5
Extreme (0C)	1880	-12.2	-0.006489	2.5
Extreme (-10C)	1880	-11.9	-0.006330	2.5
Extreme (-20C)	1880	-11.1	-0.005904	2.5
Extreme (-30C)	1880	-11.8	-0.006277	2.5

16QAM, (20MHz BANDWIDTH)

Frequency error vs. Voltage

Voltage [Vdc]	Frequency [MHz]	Frequency* Error[Hz]	Frequency Error[ppm]	Limit [ppm]
BAND 2 16QAM, (CH 18900 RB size 100 RB Offset 0 20MHz BANDWIDTH)				
3.2	1880	-13.6	-0.007234	2.5
3.8	1880	-13.0	-0.006915	2.5
4.4	1880	-13.2	-0.007021	2.5

Frequency error vs. Temperature

Temperature [° C]	Frequency [MHz]	Frequency* Error[Hz]	Frequency Error[ppm]	Limit [ppm]
BAND 2 16QAM, (CH 18900 RB size 100 RB Offset 0 20MHz BANDWIDTH)				
Normal (25C)	1880	-13.9	-0.007394	2.5
Extreme (50C)	1880	-15.1	-0.008032	2.5
Extreme (40C)	1880	-14.7	-0.007819	2.5
Extreme (30C)	1880	-13.2	-0.007021	2.5
Extreme (10C)	1880	-13.8	-0.007340	2.5
Extreme (0C)	1880	-12.7	-0.006755	2.5
Extreme (-10C)	1880	-12.1	-0.006436	2.5
Extreme (-20C)	1880	-11.9	-0.006330	2.5
Extreme (-30C)	1880	-11.2	-0.005957	2.5

*Note: Frequency error measurements were made by using the build-in capability of the Wireless Communication Test Set.

10.2 LTE BAND 4

QPSK, (10MHz BANDWIDTH)

Frequency error vs. Voltage

Voltage [Vdc]	Frequency [MHz]	Frequency* Error[Hz]	Frequency Error[ppm]	Limit [ppm]
BAND 4 QPSK, (CH 20175 RB size 100 RB Offset 0 20MHz BANDWIDTH)				
3.2	1732.5	-6.3	-0.003636	2.5
3.8	1732.5	-6.3	-0.003636	2.5
4.4	1732.5	-6.4	-0.003694	2.5

Frequency error vs. Temperature

Temperature [°C]	Frequency [MHz]	Frequency* Error[Hz]	Frequency Error[ppm]	Limit [ppm]
BAND 4 QPSK, (CH 20175 RB size 100 RB Offset 0 20MHz BANDWIDTH)				
Normal (25C)	1732.5	-6.4	-0.003694	2.5
Extreme (50C)	1732.5	-8.1	-0.004675	2.5
Extreme (40C)	1732.5	-7.8	-0.004502	2.5
Extreme (30C)	1732.5	-7.8	-0.004502	2.5
Extreme (10C)	1732.5	-6.1	-0.003521	2.5
Extreme (0C)	1732.5	-5.3	-0.003059	2.5
Extreme (-10C)	1732.5	-5.6	-0.003232	2.5
Extreme (-20C)	1732.5	-9.8	-0.005657	2.5
Extreme (-30C)	1732.5	-8.2	-0.004733	2.5

16QAM, (20MHz BANDWIDTH)

Frequency error vs. Voltage

Voltage [Vdc]	Frequency [MHz]	Frequency* Error[Hz]	Frequency Error[ppm]	Limit [ppm]
BAND 4 16QAM, (CH 20175 RB size 100 RB Offset 0 20MHz BANDWIDTH)				
3.2	1732.5	-9.2	-0.005310	2.5
3.8	1732.5	-9.9	-0.005714	2.5
4.4	1732.5	-9.7	-0.005599	2.5

Frequency error vs. Temperature

Temperature [°C]	Frequency [MHz]	Frequency* Error[Hz]	Frequency Error[ppm]	Limit [ppm]
BAND 4 16QAM, (CH 20175 RB size 100 RB Offset 0 20MHz BANDWIDTH)				
Normal (25C)	1732.5	-9.8	-0.005657	2.5
Extreme (50C)	1732.5	-6.8	-0.003925	2.5
Extreme (40C)	1732.5	-7.3	-0.004214	2.5
Extreme (30C)	1732.5	-8.6	-0.004964	2.5
Extreme (10C)	1732.5	-9.2	-0.005310	2.5
Extreme (0C)	1732.5	-8.9	-0.005137	2.5
Extreme (-10C)	1732.5	-7.1	-0.004098	2.5
Extreme (-20C)	1732.5	-8.7	-0.005022	2.5
Extreme (-30C)	1732.5	-8.6	-0.004964	2.5

***Note:** Frequency error measurements were made by using the build-in capability of the Wireless Communication Test Set.

10.3 LTE BAND 5

QPSK, (10MHz BANDWIDTH)

Frequency error vs. Voltage

Voltage [Vdc]	Frequency [MHz]	Frequency* Error[Hz]	Frequency Error[ppm]	Limit [ppm]
BAND 5 QPSK, (CH 20525 RB size 50 RB Offset 0 10MHz BANDWIDTH)				
3.2	836.5	-10.9	-0.013030	2.5
3.8	836.5	-10.5	-0.012552	2.5
4.4	836.5	-11.1	-0.013270	2.5

Frequency error vs. Temperature

Temperature [° C]	Frequency [MHz]	Frequency* Error[Hz]	Frequency Error[ppm]	Limit [ppm]
BAND 5 QPSK, (CH 20525 RB size 50 RB Offset 0 10MHz BANDWIDTH)				
Normal (25C)	836.5	-10.6	-0.012672	2.5
Extreme (50C)	836.5	-11.6	-0.013867	2.5
Extreme (40C)	836.5	-11.1	-0.013270	2.5
Extreme (30C)	836.5	-10.9	-0.013030	2.5
Extreme (10C)	836.5	-10.8	-0.012911	2.5
Extreme (0C)	836.5	-9.7	-0.011596	2.5
Extreme (-10C)	836.5	-11.3	-0.013509	2.5
Extreme (-20C)	836.5	-14.1	-0.016856	2.5
Extreme (-30C)	836.5	-15.3	-0.018290	2.5

16QAM, (10MHz BANDWIDTH)

Frequency error vs. Voltage

Voltage [Vdc]	Frequency [MHz]	Frequency* Error[Hz]	Frequency Error[ppm]	Limit [ppm]
BAND 5 16QAM, (CH 20525 RB size 50 RB Offset 0 10MHz BANDWIDTH)				
3.2	836.5	-14.3	-0.017095	2.5
3.8	836.5	-14.5	-0.017334	2.5
4.4	836.5	-14.9	-0.017812	2.5

Frequency error vs. Temperature

Temperature [° C]	Frequency [MHz]	Frequency* Error[Hz]	Frequency Error[ppm]	Limit [ppm]
BAND 5 16QAM, (CH 20525 RB size 50 RB Offset 0 10MHz BANDWIDTH)				
Normal (25C)	836.5	-14.8	-0.017693	2.5
Extreme (50C)	836.5	-15.9	-0.019008	2.5
Extreme (40C)	836.5	-15.9	-0.019008	2.5
Extreme (30C)	836.5	-15.1	-0.018051	2.5
Extreme (10C)	836.5	-14.3	-0.017095	2.5
Extreme (0C)	836.5	-13.3	-0.015900	2.5
Extreme (-10C)	836.5	-15.1	-0.018051	2.5
Extreme (-20C)	836.5	-14.9	-0.017812	2.5
Extreme (-30C)	836.5	-13.8	-0.016497	2.5

*Note: Frequency error measurements were made by using the build-in capability of the Wireless Communication Test Set.

10.4 LTE BAND 7

QPSK, (20MHz BANDWIDTH)

Frequency error vs. Voltage

Voltage [Vdc]	Frequency [MHz]	Frequency* Error[Hz]	Frequency Error[ppm]	Limit [ppm]
BAND 7 QPSK, (CH 21100 RB size 100 RB Offset 0 20MHz BANDWIDTH)				
3.2	2535	-10.6	-0.004181	2.5
3.8	2535	-11.0	-0.004339	2.5
4.4	2535	-11.4	-0.004497	2.5

Frequency error vs. Temperature

Temperature [° C]	Frequency [MHz]	Frequency* Error[Hz]	Frequency Error[ppm]	Limit [ppm]
BAND 7 QPSK, (CH 21100 RB size 100 RB Offset 0 20MHz BANDWIDTH)				
Normal (25C)	2535	-11.3	-0.004458	2.5
Extreme (50C)	2535	-14.1	-0.005562	2.5
Extreme (40C)	2535	-16.2	-0.006391	2.5
Extreme (30C)	2535	-11.2	-0.004418	2.5
Extreme (10C)	2535	-10.8	-0.004260	2.5
Extreme (0C)	2535	-9.9	-0.003905	2.5
Extreme (-10C)	2535	-13.1	-0.005168	2.5
Extreme (-20C)	2535	-11.6	-0.004576	2.5
Extreme (-30C)	2535	-14.7	-0.005799	2.5

16QAM, (20MHz BANDWIDTH)

Frequency error vs. Voltage

Voltage [Vdc]	Frequency [MHz]	Frequency* Error[Hz]	Frequency Error[ppm]	Limit [ppm]
BAND 7 16QAM, (CH 21100 RB size 100 RB Offset 0 20MHz BANDWIDTH)				
3.2	2535	-10.5	-0.004142	2.5
3.8	2535	-10.9	-0.004300	2.5
4.4	2535	-10.9	-0.004300	2.5

Frequency error vs. Temperature

Temperature [° C]	Frequency [MHz]	Frequency* Error[Hz]	Frequency Error[ppm]	Limit [ppm]
BAND 7 16QAM, (CH 21100 RB size 100 RB Offset 0 20MHz BANDWIDTH)				
Normal (25C)	2535	-10.2	-0.004024	2.5
Extreme (50C)	2535	-11.7	-0.004615	2.5
Extreme (40C)	2535	-13.2	-0.005207	2.5
Extreme (30C)	2535	-10.3	-0.004063	2.5
Extreme (10C)	2535	-10.4	-0.004103	2.5
Extreme (0C)	2535	-11.1	-0.004379	2.5
Extreme (-10C)	2535	-11.9	-0.004694	2.5
Extreme (-20C)	2535	-11.5	-0.004536	2.5
Extreme (-30C)	2535	-12.2	-0.004813	2.5

***Note:** Frequency error measurements were made by using the build-in capability of the Wireless Communication Test Set.

11. Peak-to-Average Ratio

11.1 Description of the PAR Measurement

The peak-to-average ratio (PAR) of the transmission may not exceed 13 dB.

11.2 Measuring Instruments

See list of measuring instruments of this test report.

11.3 Test Procedures

1. The EUT was connected to Spectrum Analyzer and Base Station via power divider.
2. The RF output of EUT was connected to the spectrum analyzer by RF cable and attenuator. The path loss was compensated to the results for each measurement.
3. For GSM/EGPRS operating modes:
 - a. Set the RBW = 1MHz, VBW = 1MHz, Peak detector in spectrum analyzer.
 - b. Set EUT in maximum power output, and triggered the burst signal.
 - c. Measured respectively the Peak level and Mean level, and the deviation was recorded as Peak to Average Ratio.
4. For UMTS operating modes:
 - a. Set the CCDF (Complementary Cumulative Distribution Function) option in spectrum analyzer.
 - b. The highest RF powers were measured and recorded the maximum PAPR level associated with a probability of 0.1 %.

11.4 Test Setup

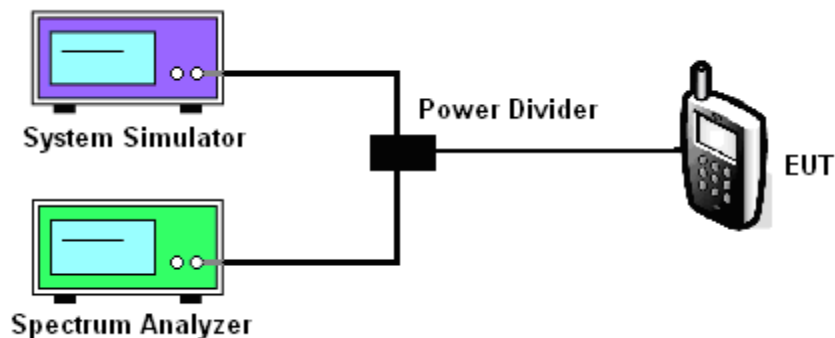

MODES TESTED

- LTE Band2
- LTE Band 4
- LTE Band5
- LTE Band 7

BAND	CHANNEL	Frequency [MHz]	BANDWIDTH	NO. RB	RB POS.	MODULATION	PAR [dB]
2	18900	1880.0	1.4	1	Low	QPSK	4.86
2	18900	1880.0	1.4	1	Low	16-QAM	5.53
2	18900	1880.0	3.0	1	Low	QPSK	4.82
2	18900	1880.0	3.0	1	Low	16-QAM	5.83
2	18900	1880.0	5.0	1	Low	QPSK	4.78
2	18900	1880.0	5.0	1	Low	16-QAM	5.74
2	18900	1880.0	10.0	1	Low	QPSK	4.50
2	18900	1880.0	10.0	1	Low	16-QAM	5.39
2	18900	1880.0	15.0	1	Low	QPSK	4.17
2	18900	1880.0	15.0	1	Low	16-QAM	4.93
2	18900	1880.0	20.0	1	Low	QPSK	3.65
2	18900	1880.0	20.0	1	Low	16-QAM	4.59
4	20175	1732.5	1.4	1	Low	QPSK	4.66
4	20175	1732.5	1.4	1	Low	16-QAM	5.59
4	20175	1732.5	3.0	1	Low	QPSK	4.97
4	20175	1732.5	3.0	1	Low	16-QAM	5.99
4	20175	1732.5	5.0	1	Low	QPSK	5.20
4	20175	1732.5	5.0	1	Low	16-QAM	5.87
4	20175	1732.5	10.0	1	Low	QPSK	4.71
4	20175	1732.5	10.0	1	Low	16-QAM	5.26

4	20175	1732.5	15.0	1	Low	QPSK	4.67
4	20175	1732.5	15.0	1	Low	16-QAM	5.20
4	20175	1732.5	20.0	1	Low	QPSK	4.64
4	20175	1732.5	20.0	1	Low	16-QAM	5.10
5	20525	836.5	1.4	1	Low	QPSK	3.73
5	20525	836.5	1.4	1	Low	16-QAM	4.76
5	20525	836.5	3.0	1	Low	QPSK	3.73
5	20525	836.5	3.0	1	Low	16-QAM	4.76
5	20525	836.5	5.0	1	Low	QPSK	3.73
5	20525	836.5	5.0	1	Low	16-QAM	4.79
5	20525	836.5	10.0	1	Low	QPSK	3.65
5	20525	836.5	10.0	1	Low	16-QAM	4.78
7	21100	2535.0	5.0	1	Low	QPSK	3.79
7	21100	2535.0	5.0	1	Low	16-QAM	4.73
7	21100	2535.0	10.0	1	Low	QPSK	3.88
7	21100	2535.0	10.0	1	Low	16-QAM	4.64
7	21100	2535.0	15.0	1	Low	QPSK	3.87
7	21100	2535.0	15.0	1	Low	16-QAM	4.66
7	21100	2535.0	20.0	1	Low	QPSK	3.77
7	21100	2535.0	20.0	1	Low	16-QAM	4.66

11.5 LTE BAND 2

Band 2, UL Channel 18900, UL Frequency 1880.0, BW 1.4, NO. RB 1, RB POS. Low, QPSK

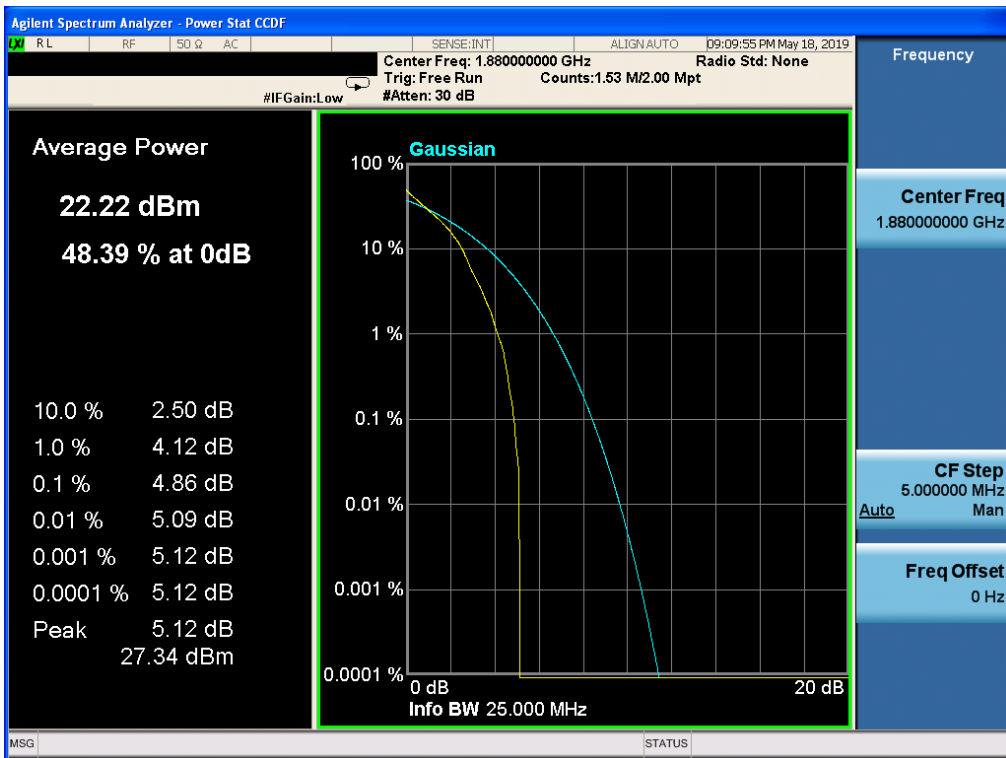

Band 2, UL Channel 18900, UL Frequency 1880.0, BW 1.4, NO. RB 1, RB POS. Low, 16-QAM



Band 2, UL Channel 18900, UL Frequency 1880.0, BW 3.0, NO. RB 1, RB POS. Low, QPSK

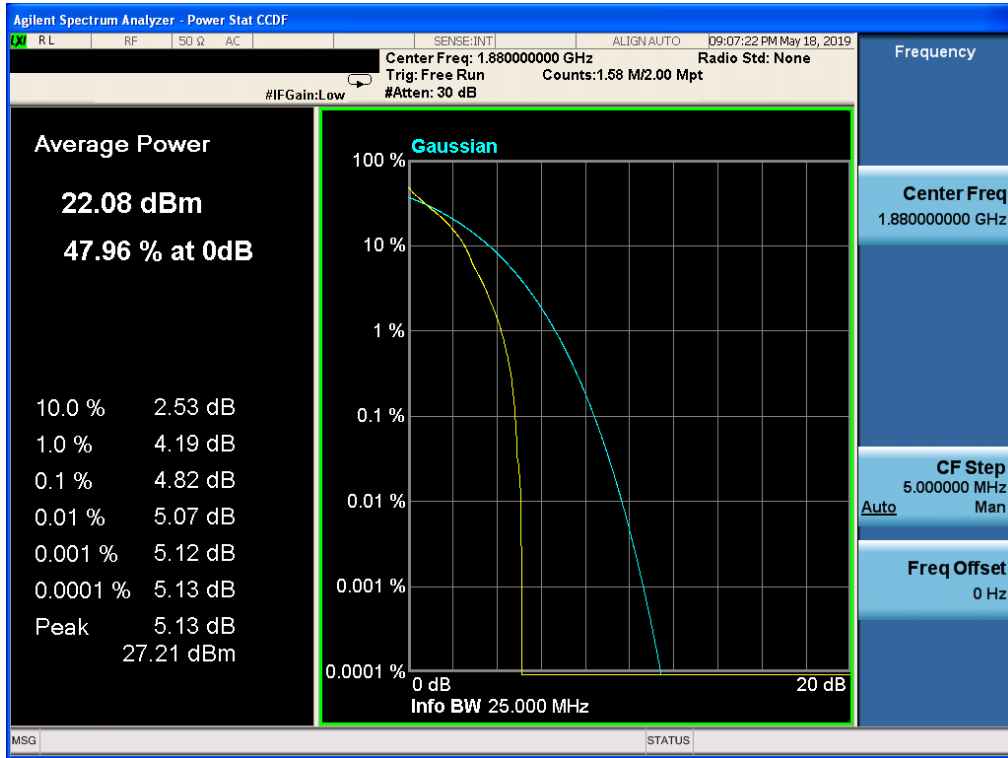

Band 2, UL Channel 18900, UL Frequency 1880.0, BW 3.0, NO. RB 1, RB POS. Low, 16-QAM

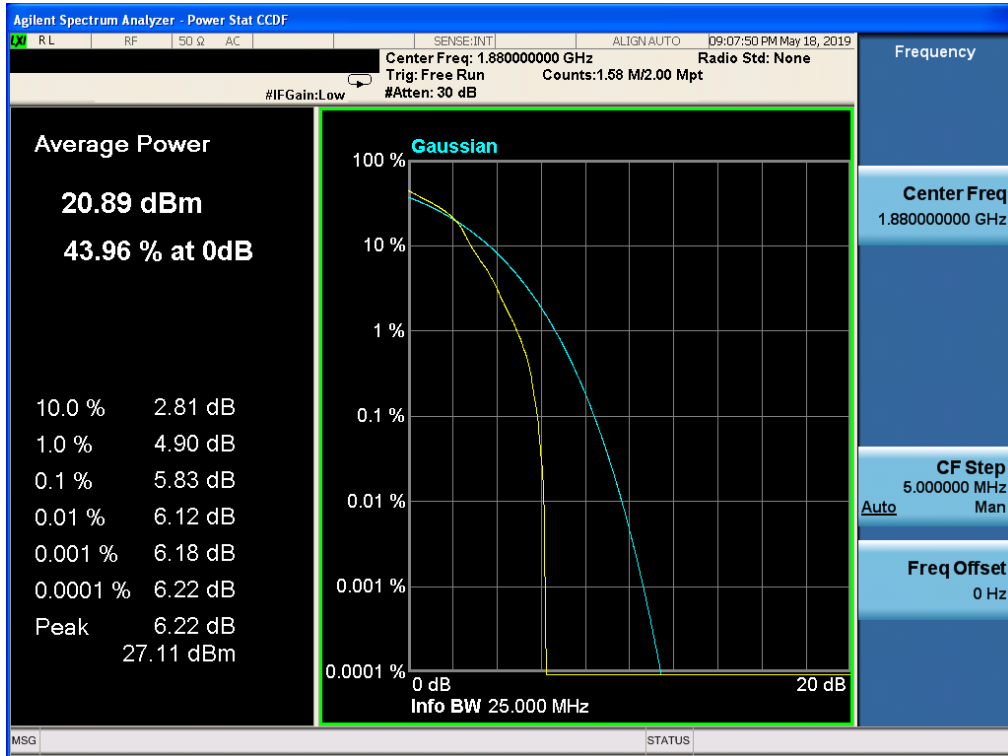

Band 2, UL Channel 18900, UL Frequency 1880.0, BW 5.0, NO. RB 1, RB POS. Low, QPSK

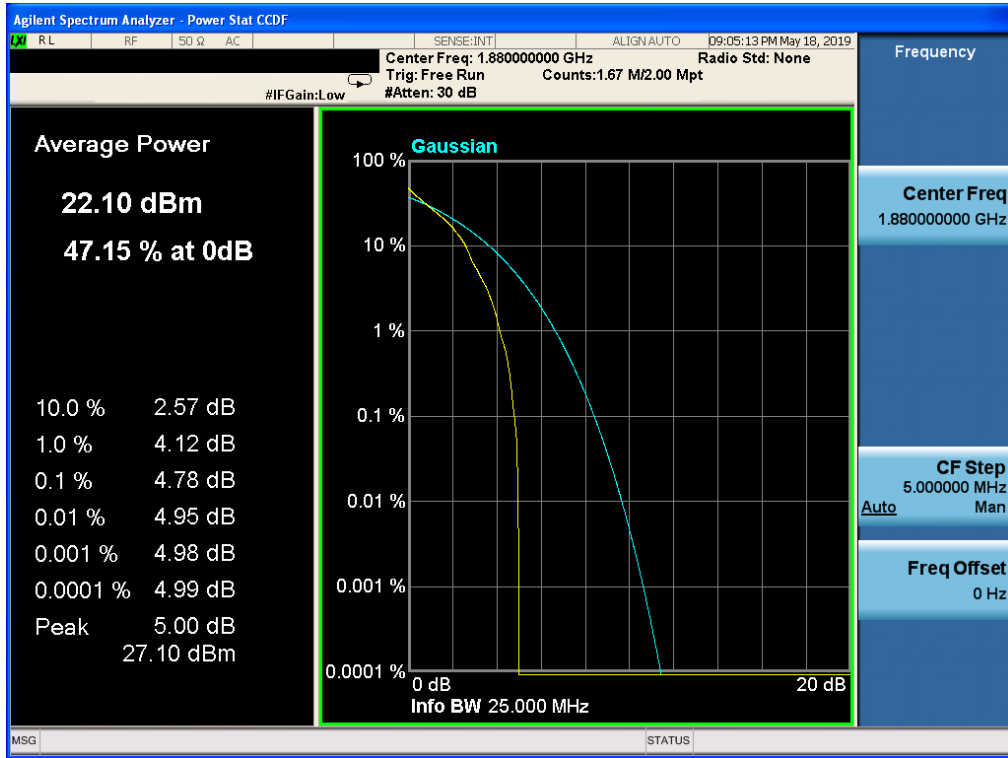

Band 2, UL Channel 18900, UL Frequency 1880.0, BW 5.0, NO. RB 1, RB POS. Low, 16-QAM

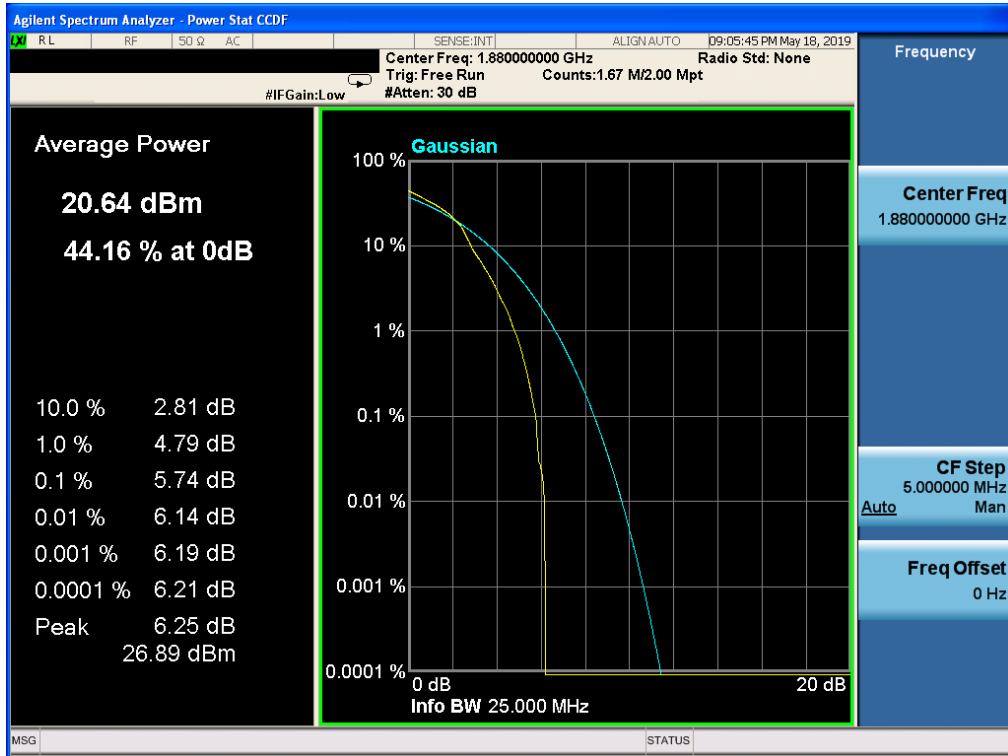

Band 2, UL Channel 18900, UL Frequency 1880.0, BW 10.0, NO. RB 1, RB POS. Low, QPSK

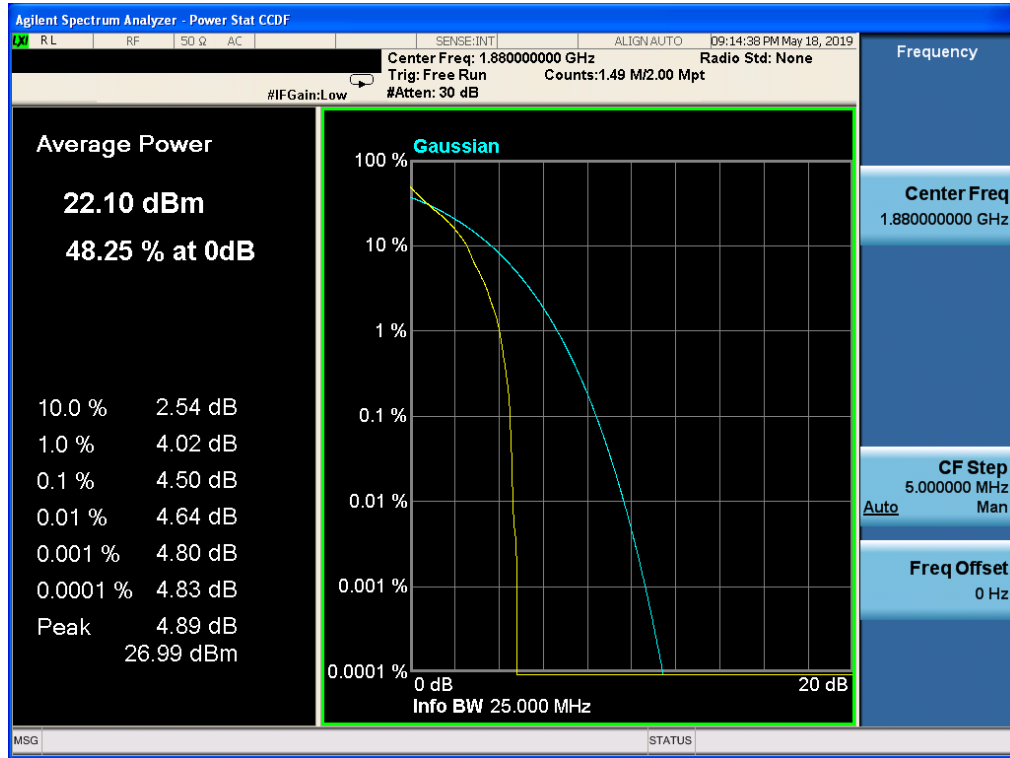

Band 2, UL Channel 18900, UL Frequency 1880.0, BW 10.0, NO. RB 1, RB POS. Low, 16-QAM

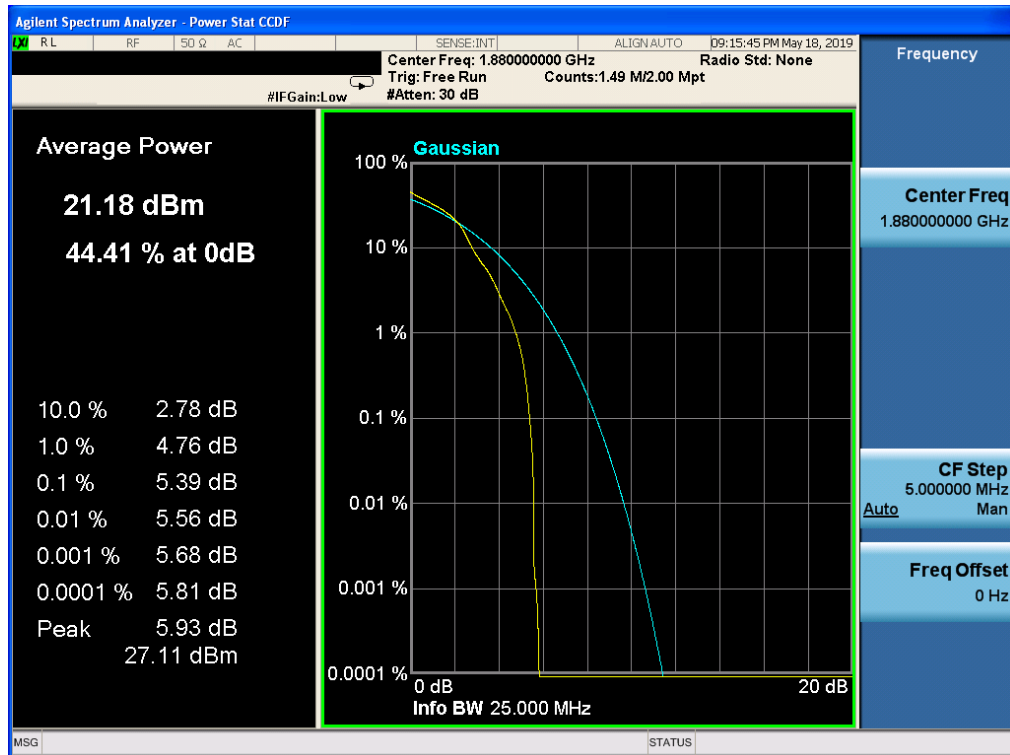

Band 2, UL Channel 18900, UL Frequency 1880.0, BW 15.0, NO. RB 1, RB POS. Low, QPSK

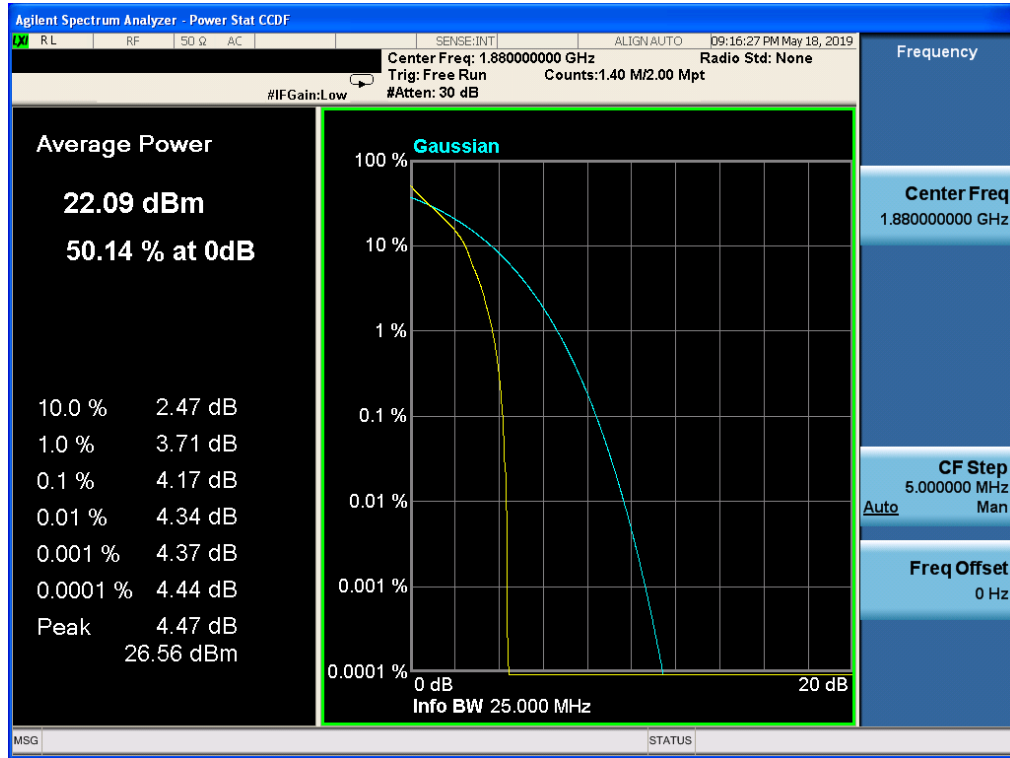

Band 2, UL Channel 18900, UL Frequency 1880.0, BW 15.0, NO. RB 1, RB POS. Low, 16-QAM

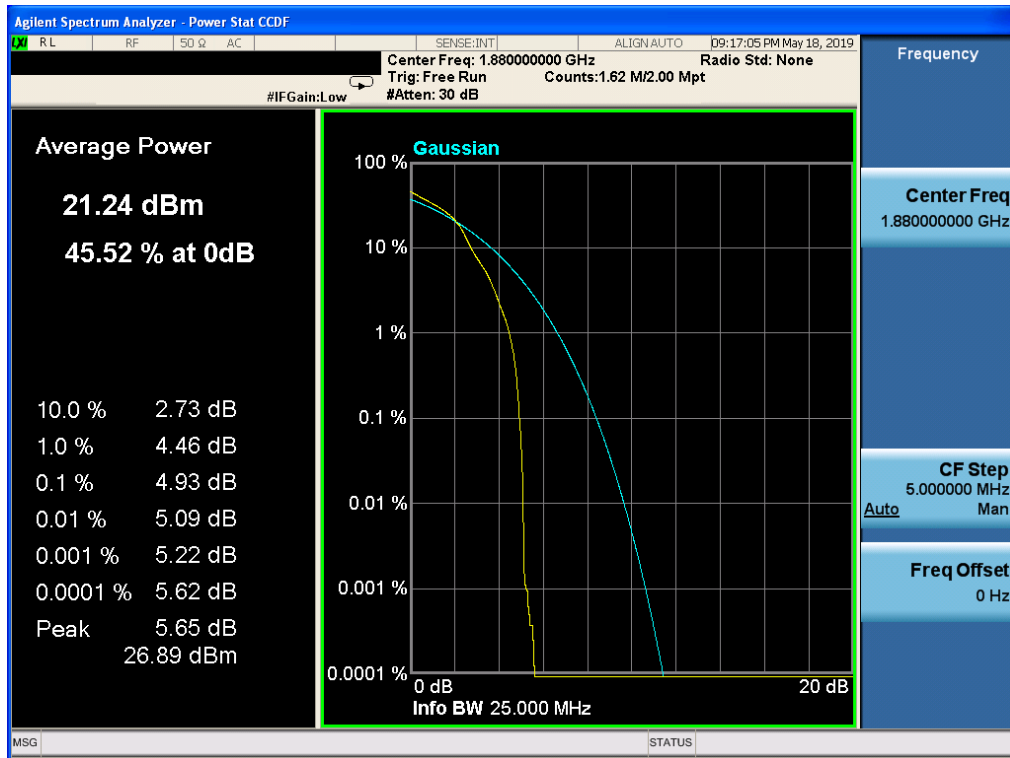

Band 2, UL Channel 18900, UL Frequency 1880.0, BW 20.0, NO. RB 1, RB POS. Low, QPSK

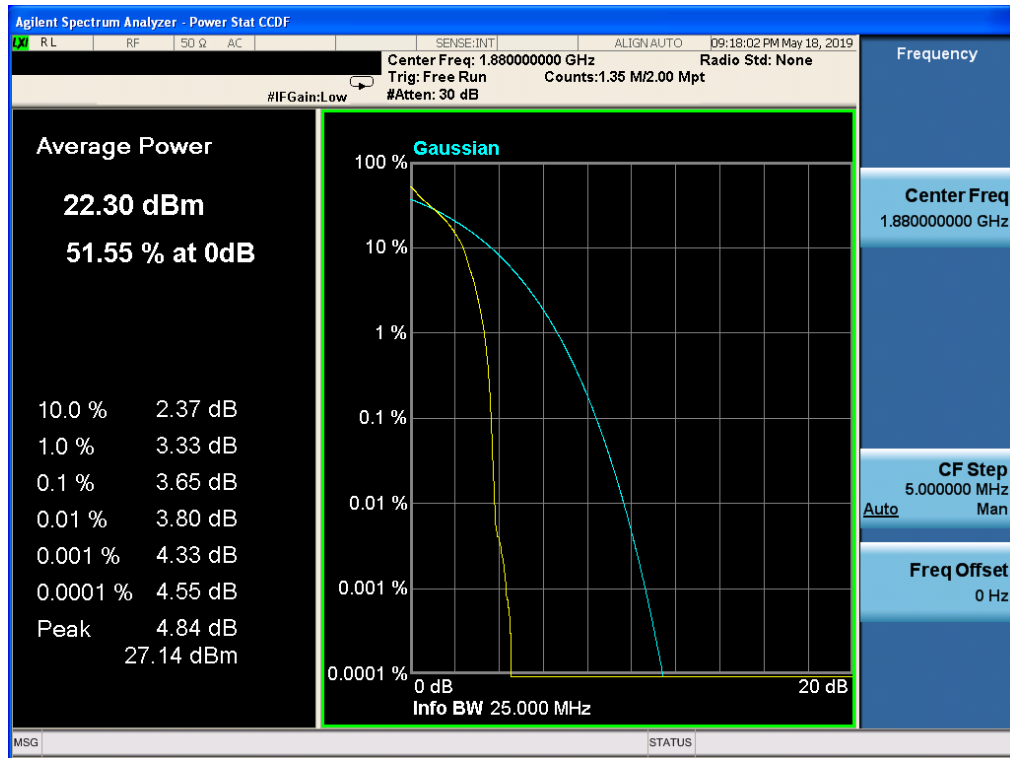

Band 2, UL Channel 18900, UL Frequency 1880.0, BW 20.0, NO. RB 1, RB POS. Low, 16-QAM

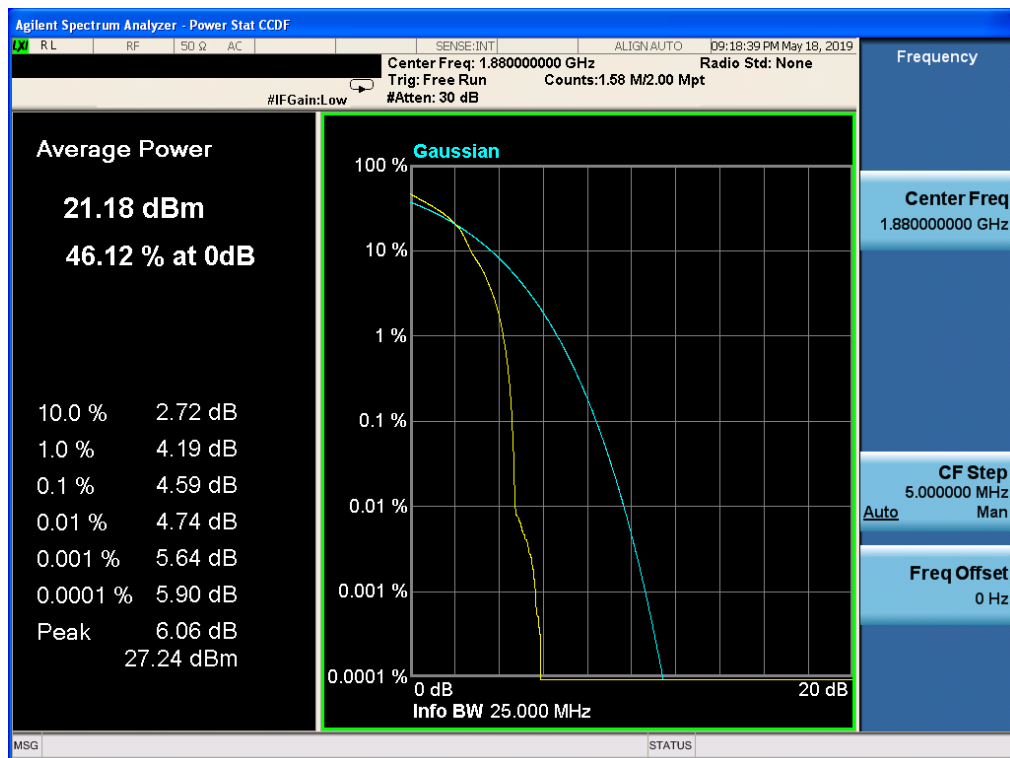

11.6 LTE BAND 4

Band 4, UL Channel 20175, UL Frequency 1732.5, BW 1.4, NO. RB 1, RB POS. Low, QPSK

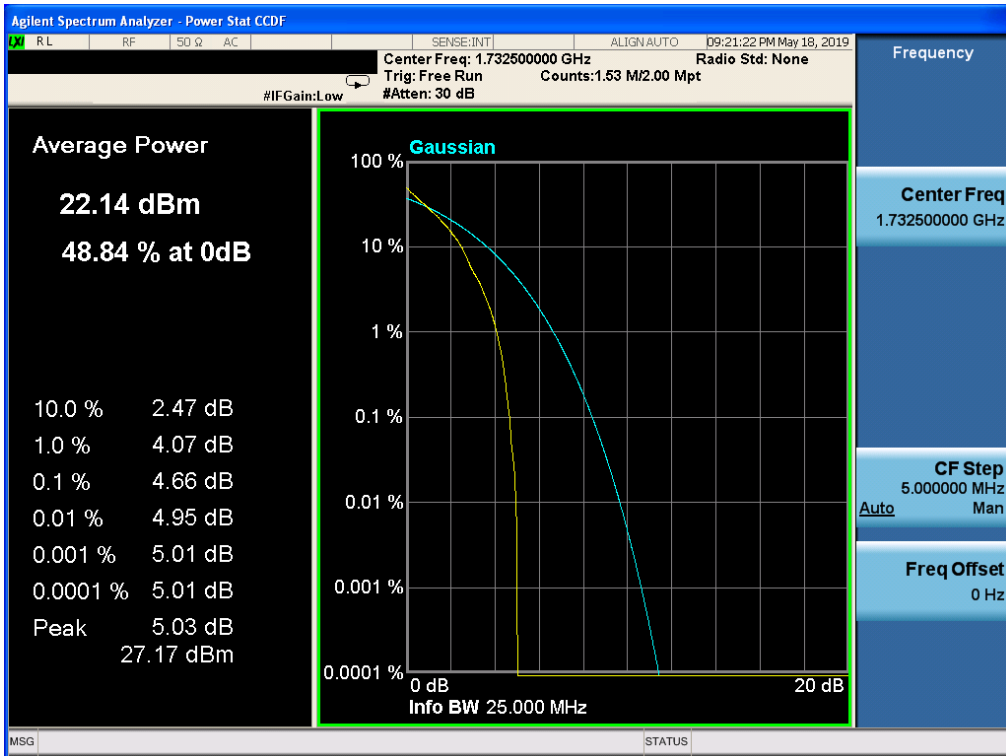

Band 4, UL Channel 20175, UL Frequency 1732.5, BW 1.4, NO. RB 1, RB POS. Low, 16-QAM

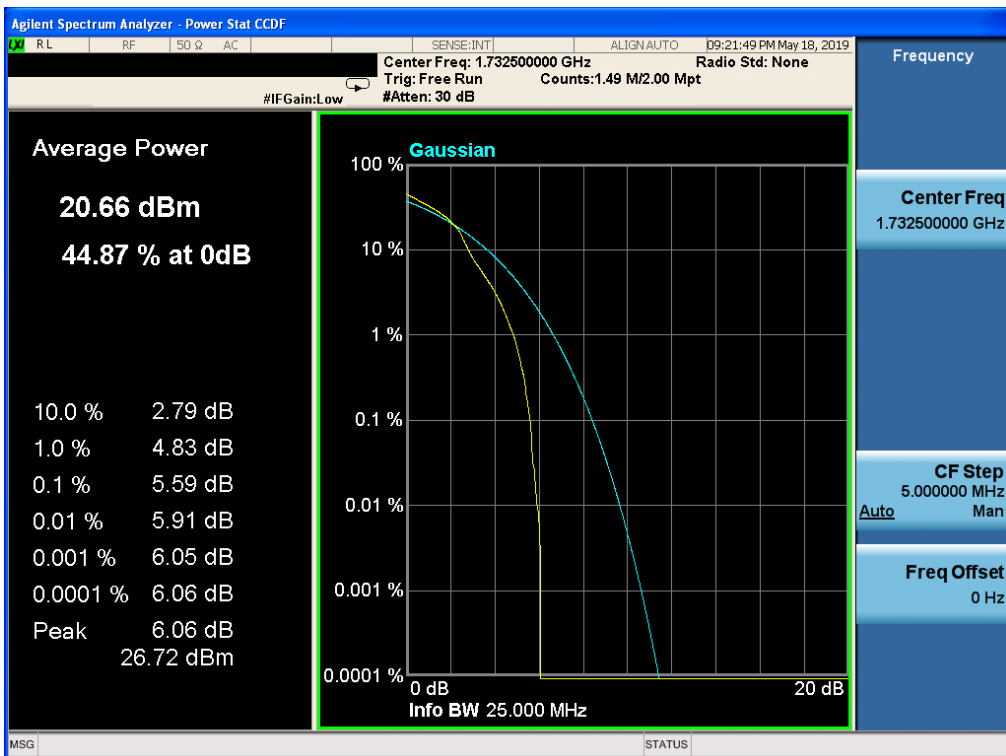

Band 4, UL Channel 20175, UL Frequency 1732.5, BW 3.0, NO. RB 1, RB POS. Low, QPSK

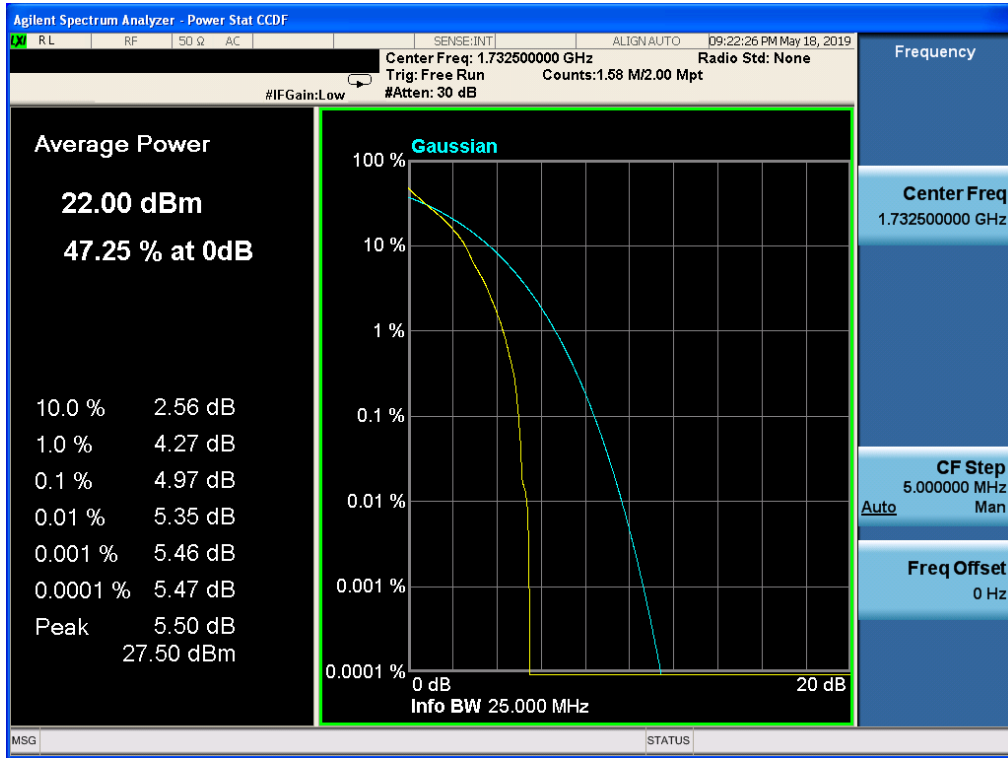

Band 4, UL Channel 20175, UL Frequency 1732.5, BW 3.0, NO. RB 1, RB POS. Low, 16-QAM

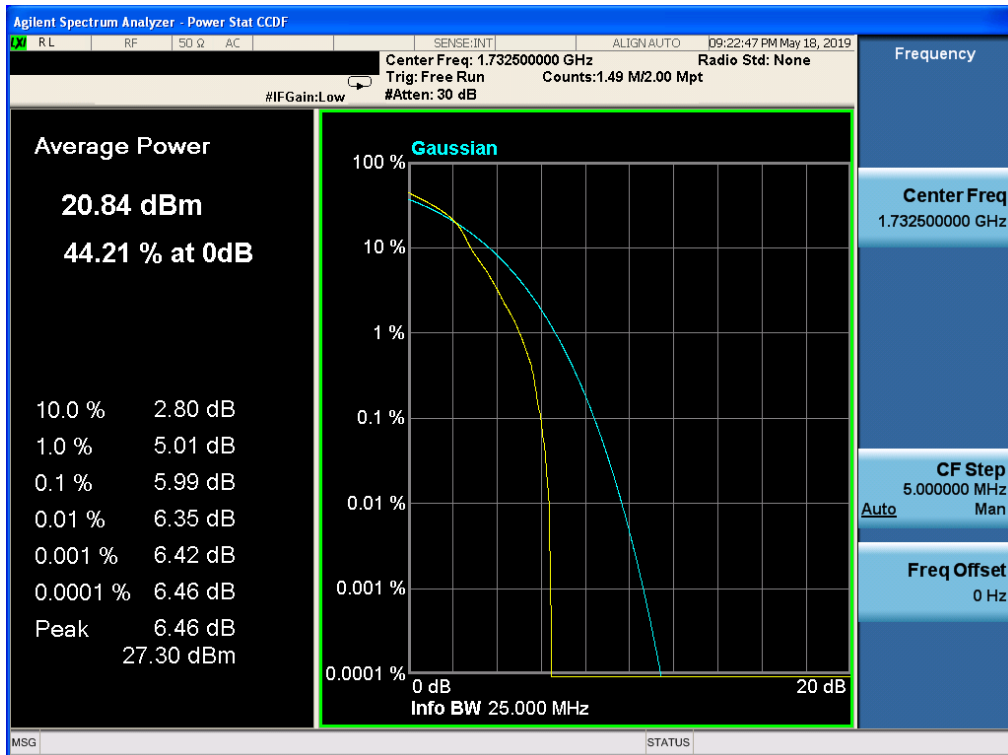

Band 4, UL Channel 20175, UL Frequency 1732.5, BW 5.0, NO. RB 1, RB POS. Low, QPSK

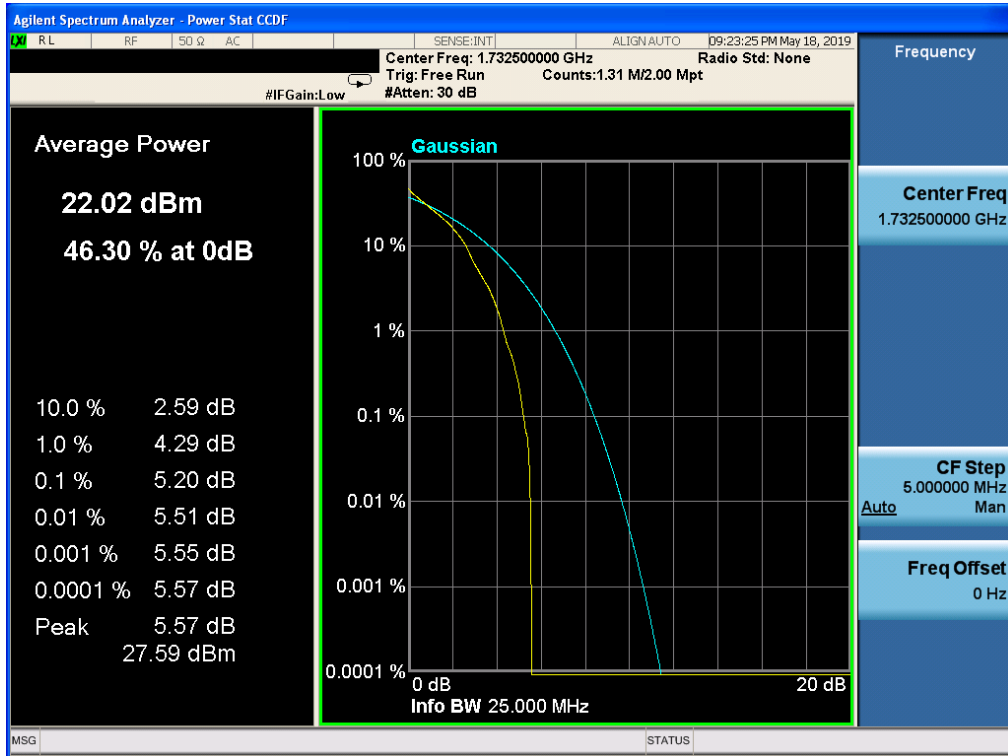

Band 4, UL Channel 20175, UL Frequency 1732.5, BW 5.0, NO. RB 1, RB POS. Low, 16-QAM

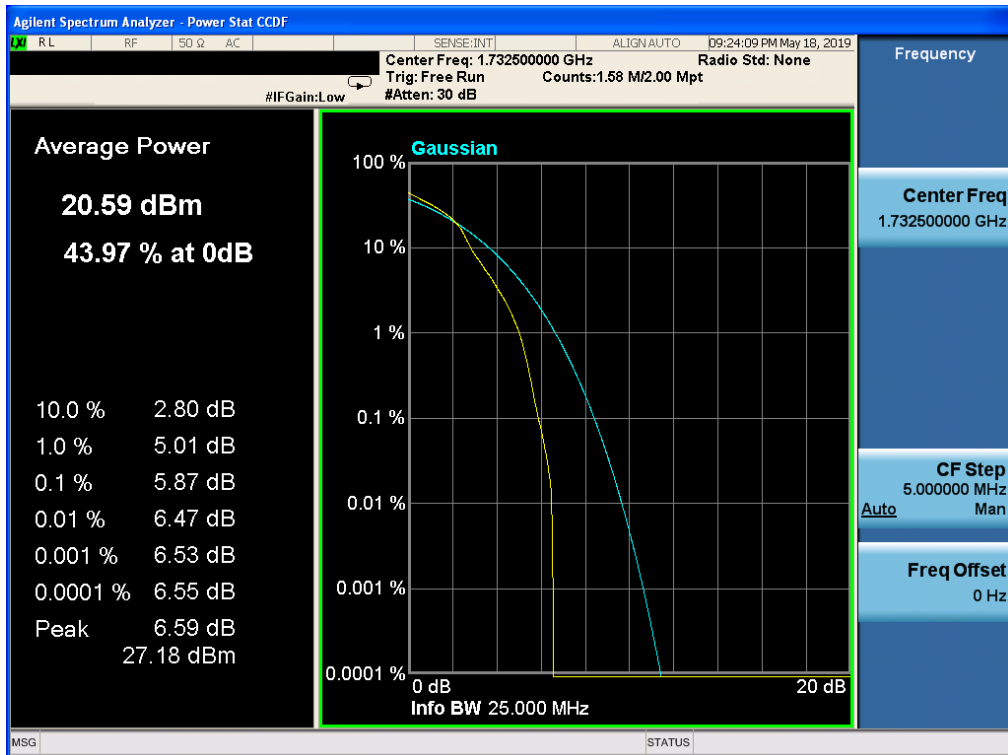

Band 4, UL Channel 20175, UL Frequency 1732.5, BW 10.0, NO. RB 1, RB POS. Low, QPSK

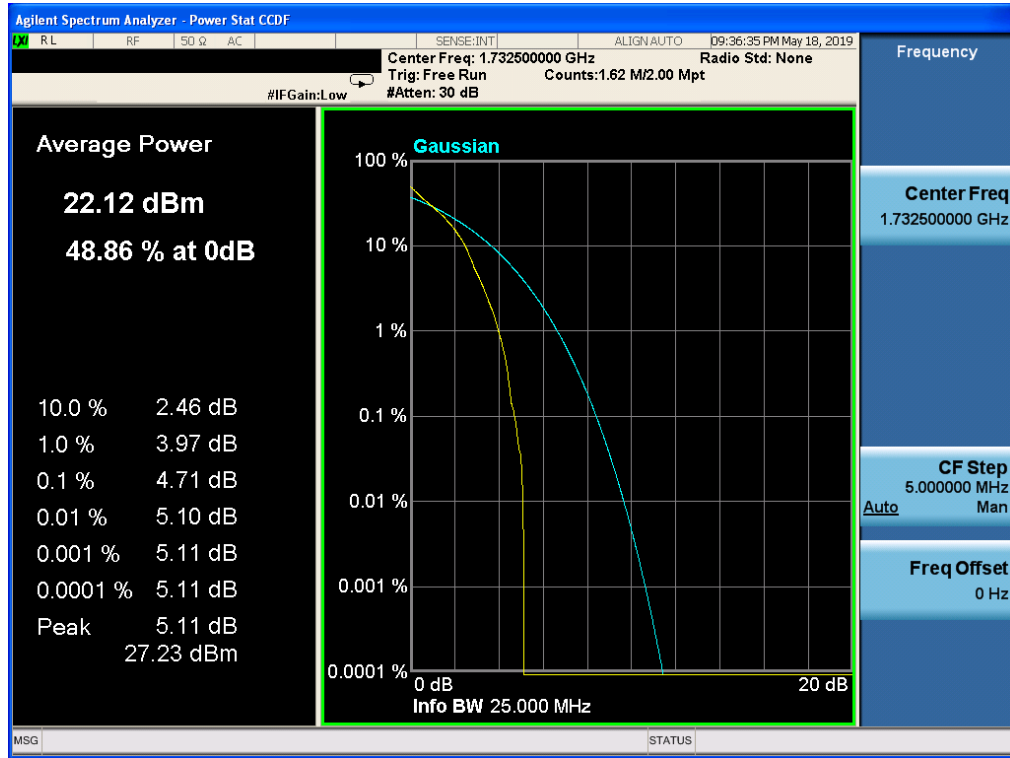

Band 4, UL Channel 20175, UL Frequency 1732.5, BW 10.0, NO. RB 1, RB POS. Low, 16-QAM

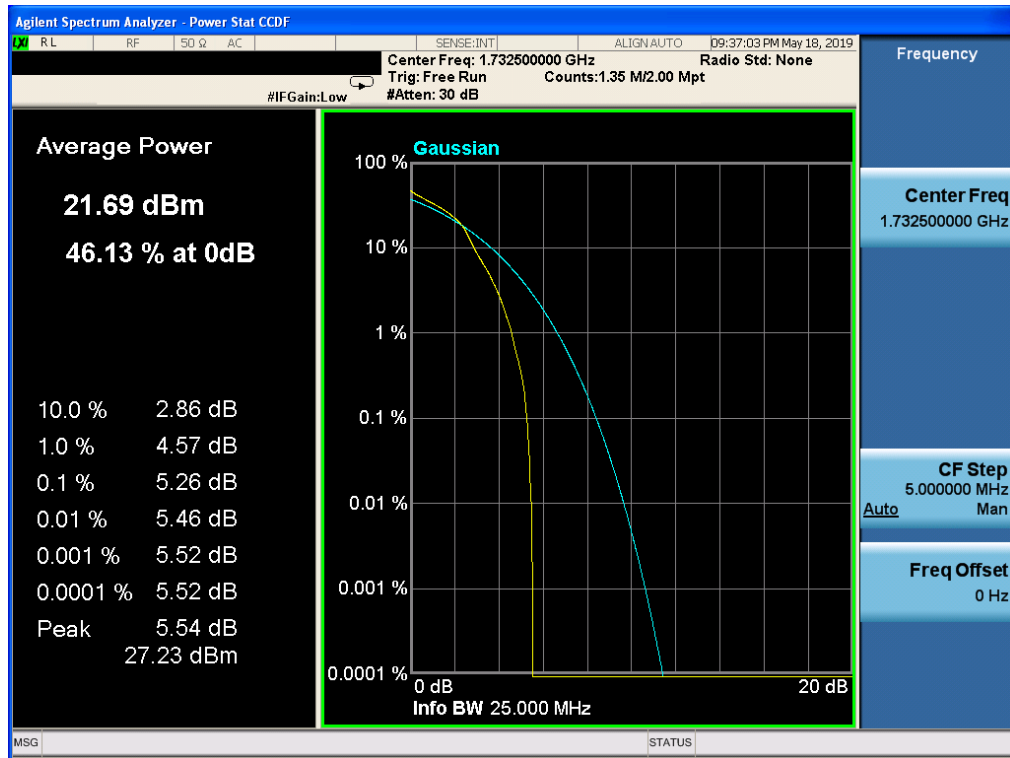

Band 4, UL Channel 20175, UL Frequency 1732.5, BW 15.0, NO. RB 1, RB POS. Low, QPSK

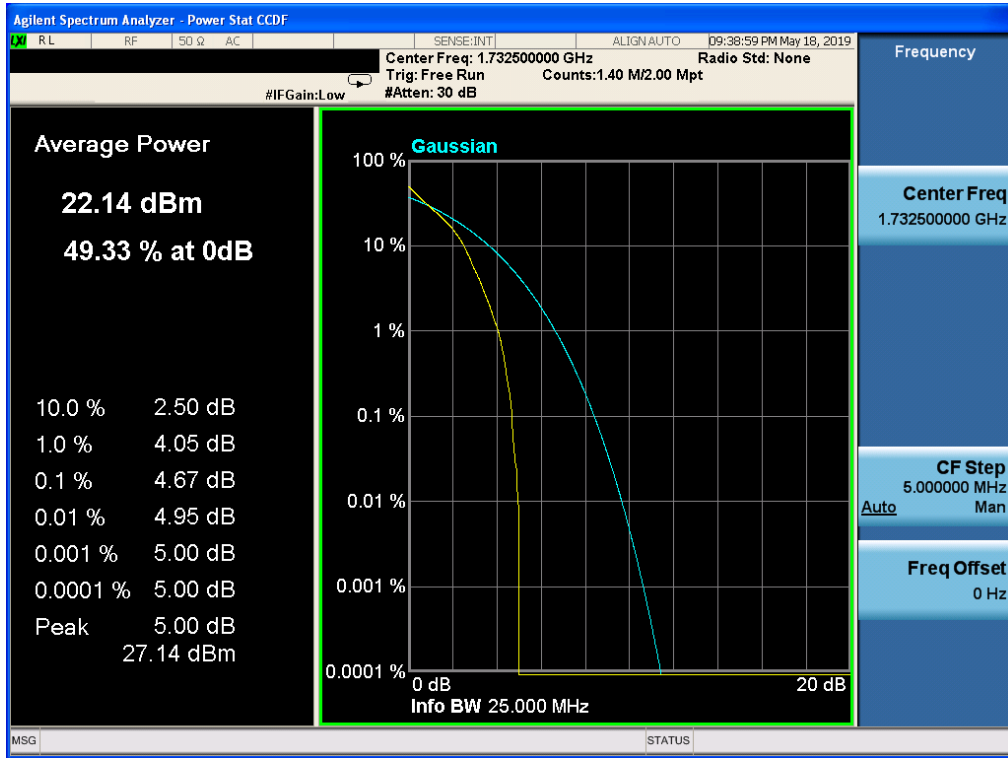

Band 4, UL Channel 20175, UL Frequency 1732.5, BW 15.0, NO. RB 1, RB POS. Low, 16-QAM

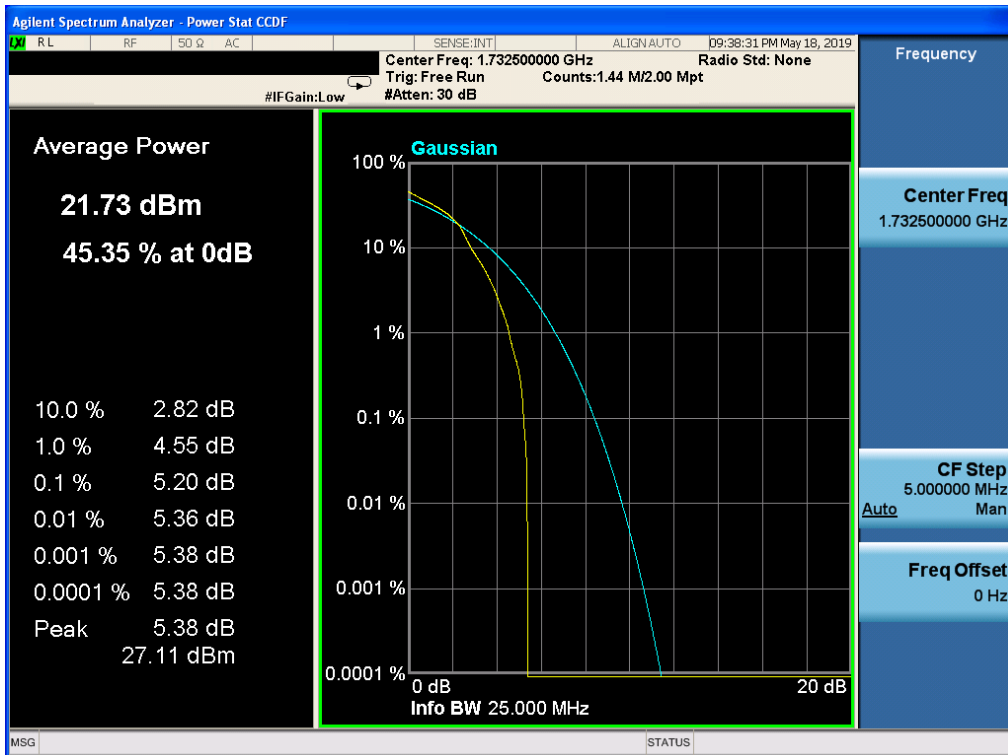

Band 4, UL Channel 20175, UL Frequency 1732.5, BW 20.0, NO. RB 1, RB POS. Low, QPSK

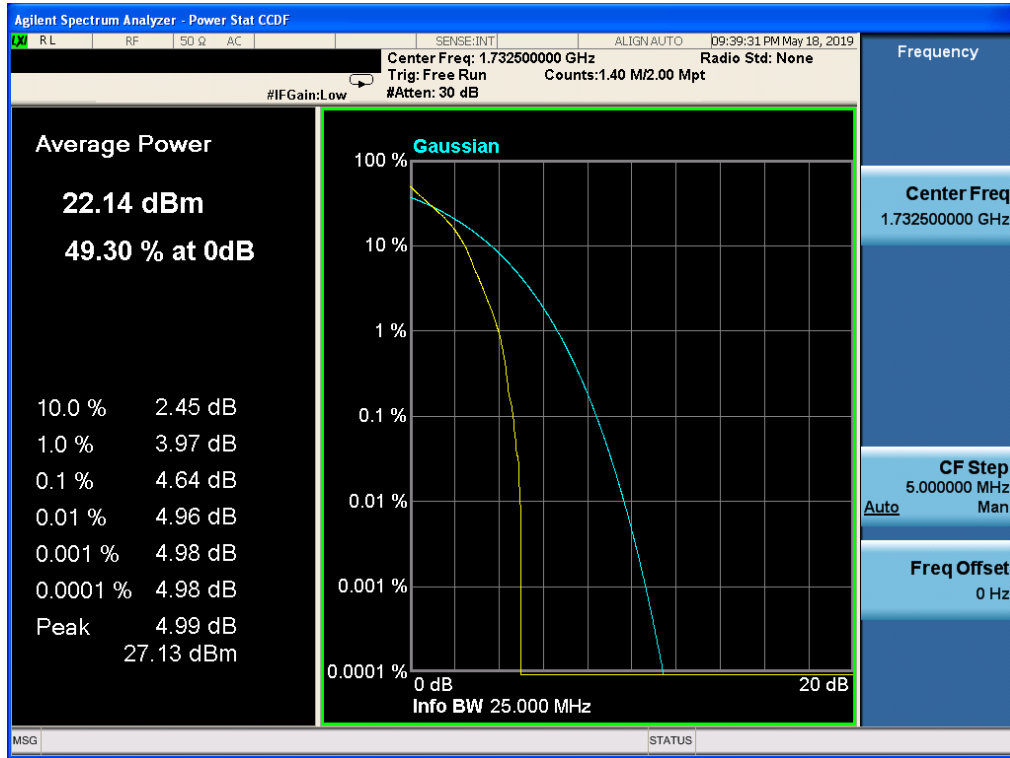

Band 4, UL Channel 20175, UL Frequency 1732.5, BW 20.0, NO. RB 1, RB POS. Low, 16-QAM

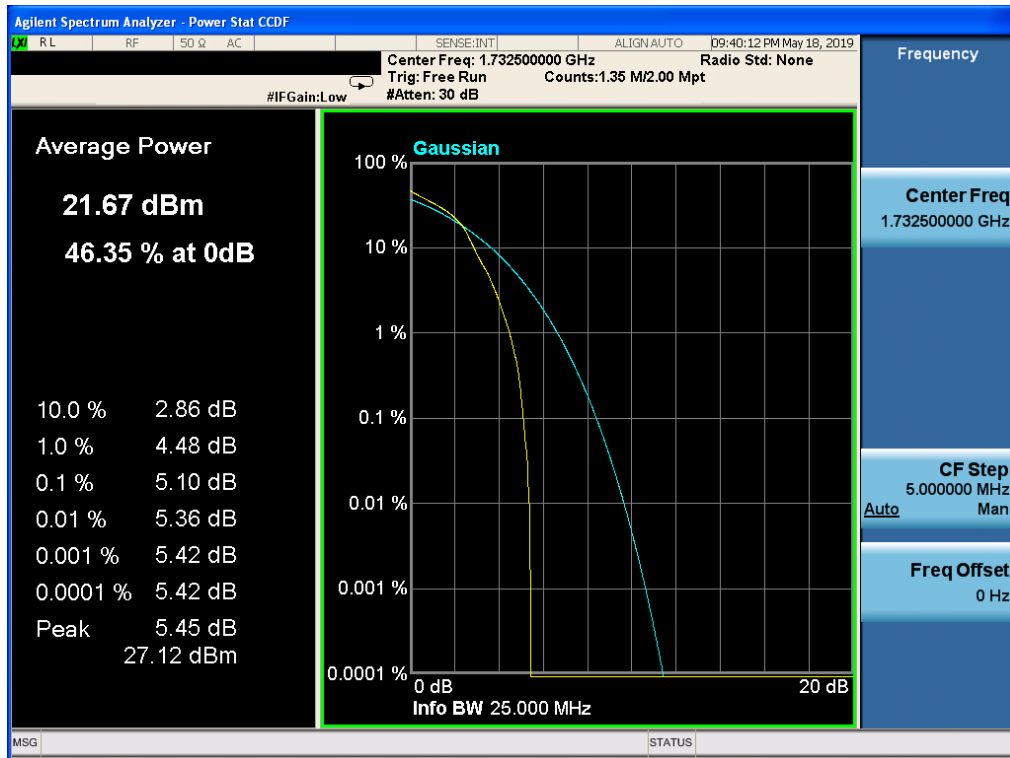

11.7 LTE BAND 5

Band 5, UL Channel 20525, UL Frequency 836.5, BW 1.4, NO. RB 1, RB POS. Low, QPSK

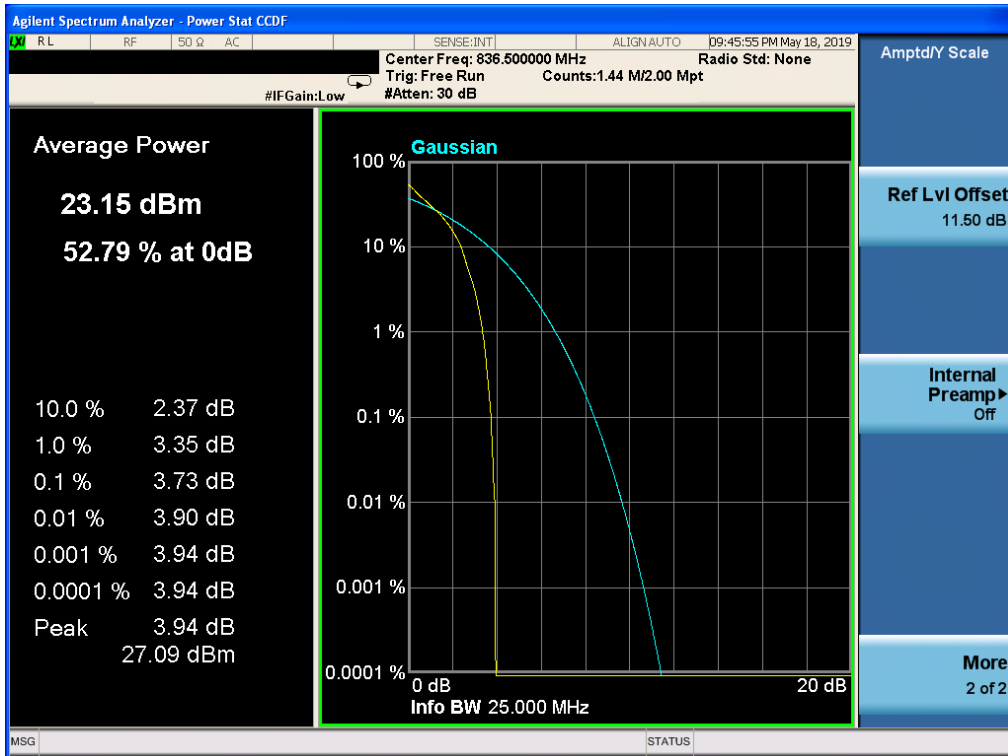

Band 5, UL Channel 20525, UL Frequency 836.5, BW 1.4, NO. RB 1, RB POS. Low, 16-QAM

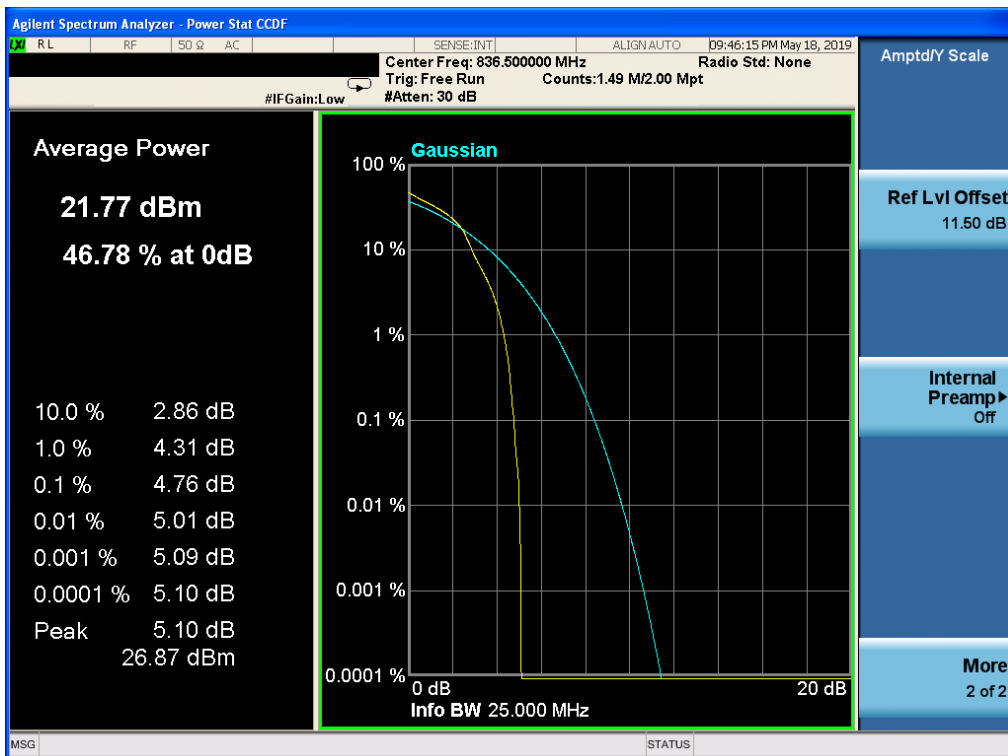

Band 5, UL Channel 20525, UL Frequency 836.5, BW 3.0, NO. RB 1, RB POS. Low, QPSK

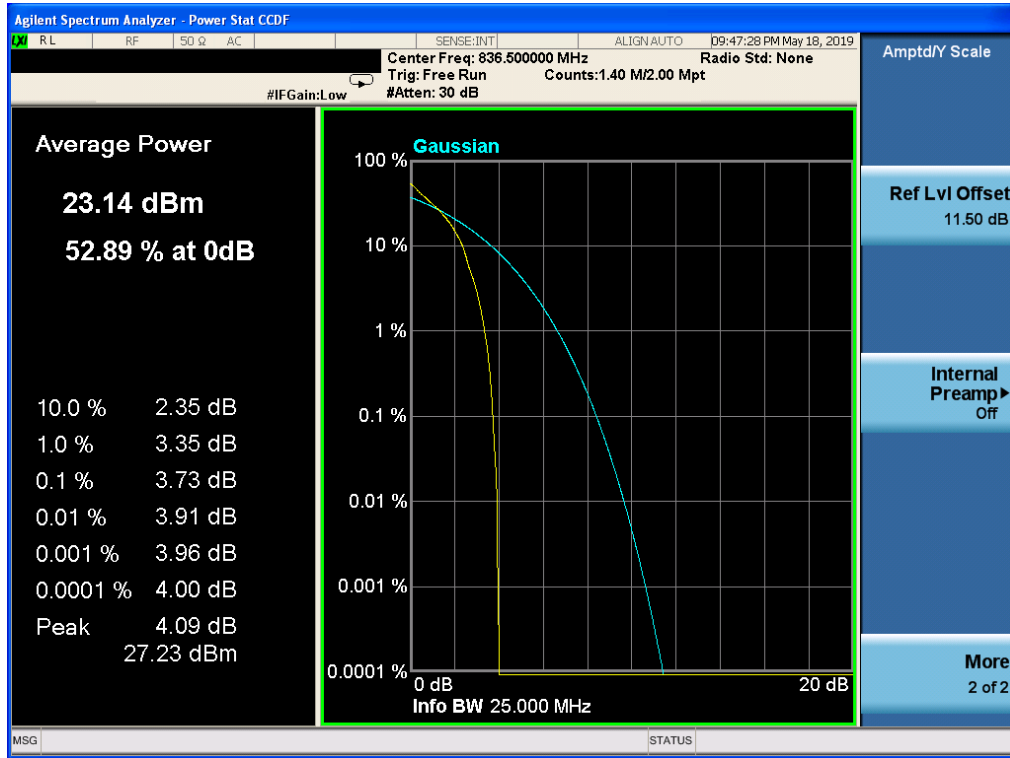

Band 5, UL Channel 20525, UL Frequency 836.5, BW 3.0, NO. RB 1, RB POS. Low, 16-QAM

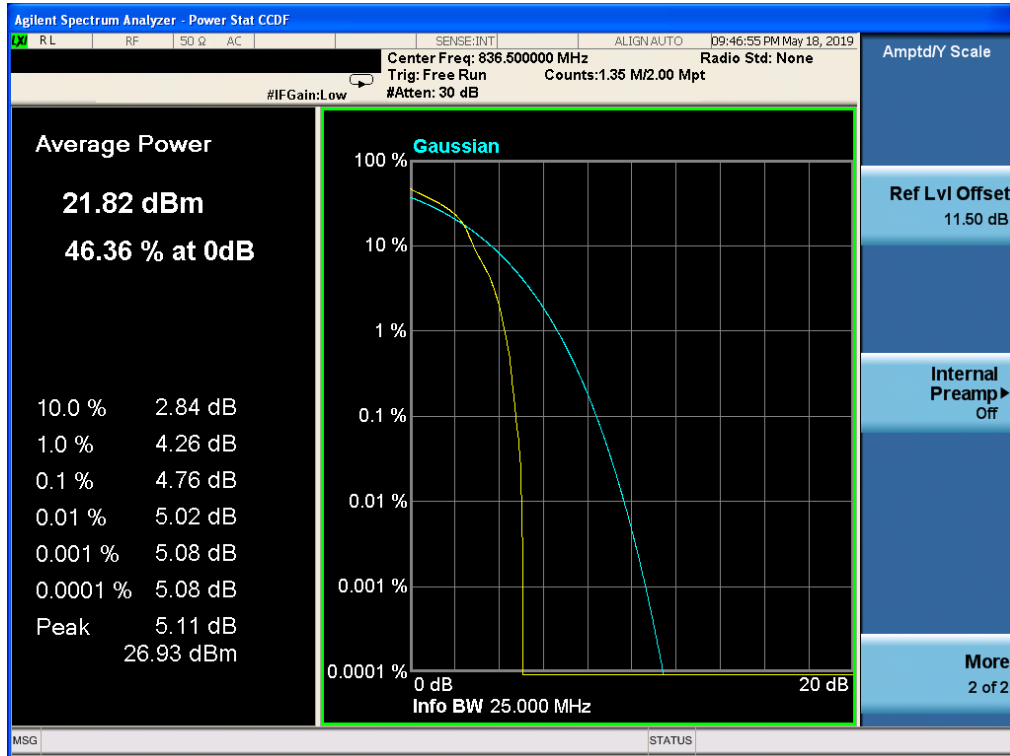

Band 5, UL Channel 20525, UL Frequency 836.5, BW 5.0, NO. RB 1, RB POS. Low, QPSK

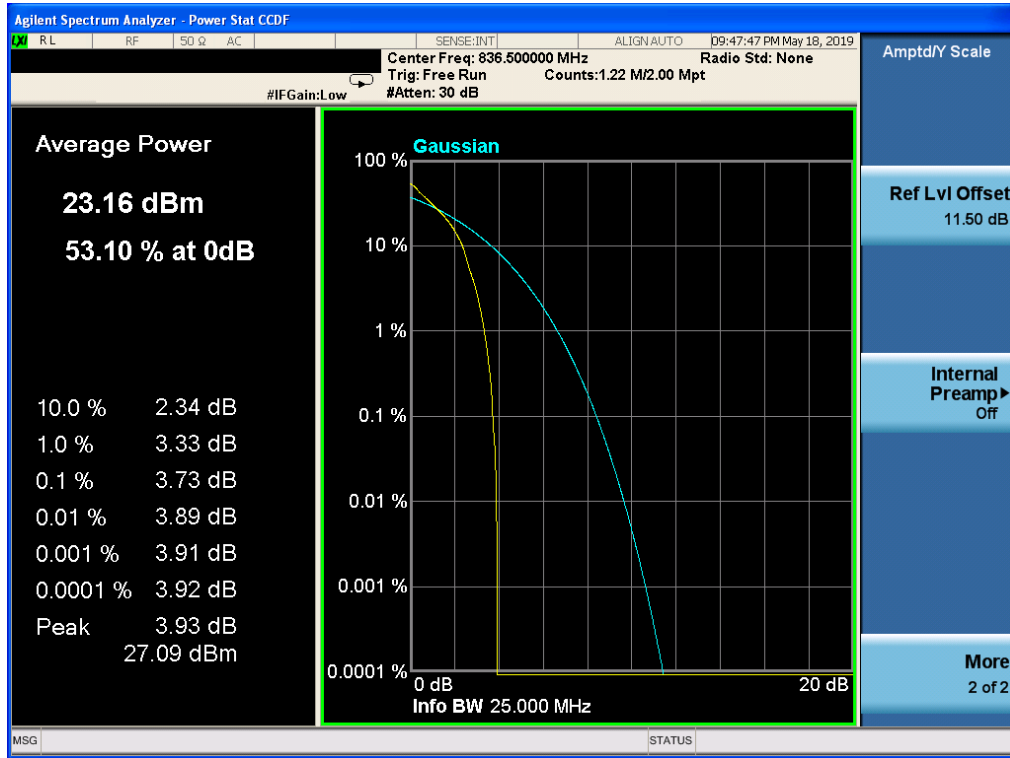

Band 5, UL Channel 20525, UL Frequency 836.5, BW 5.0, NO. RB 1, RB POS. Low, 16-QAM

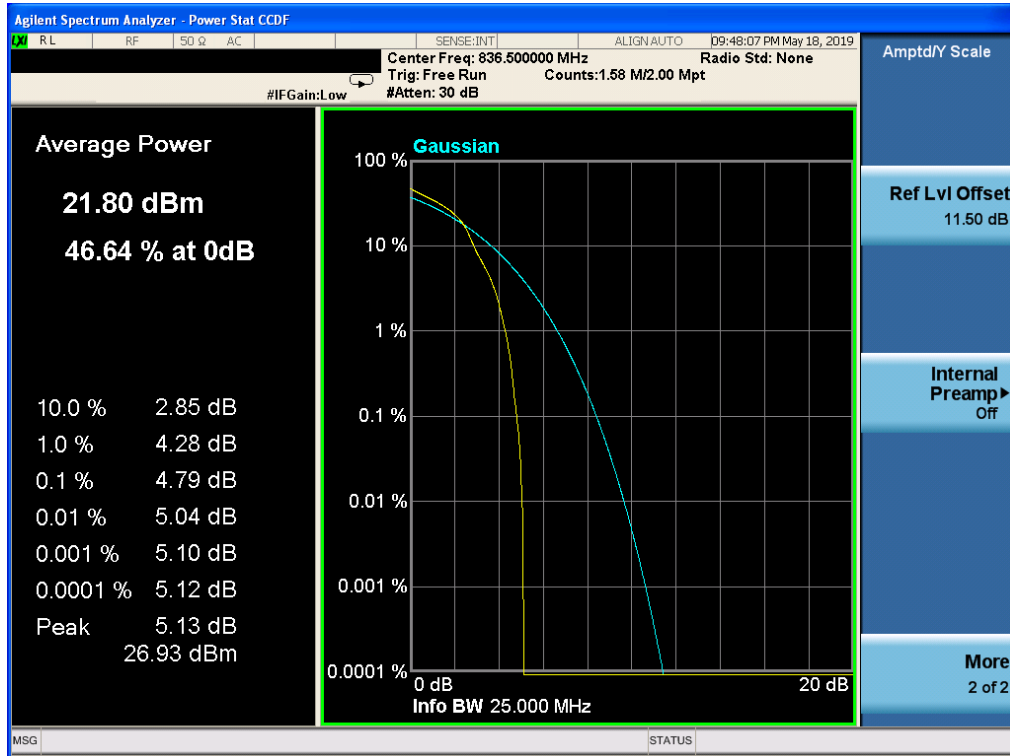

Band 5, UL Channel 20525, UL Frequency 836.5, BW 10.0, NO. RB 1, RB POS. Low, QPSK

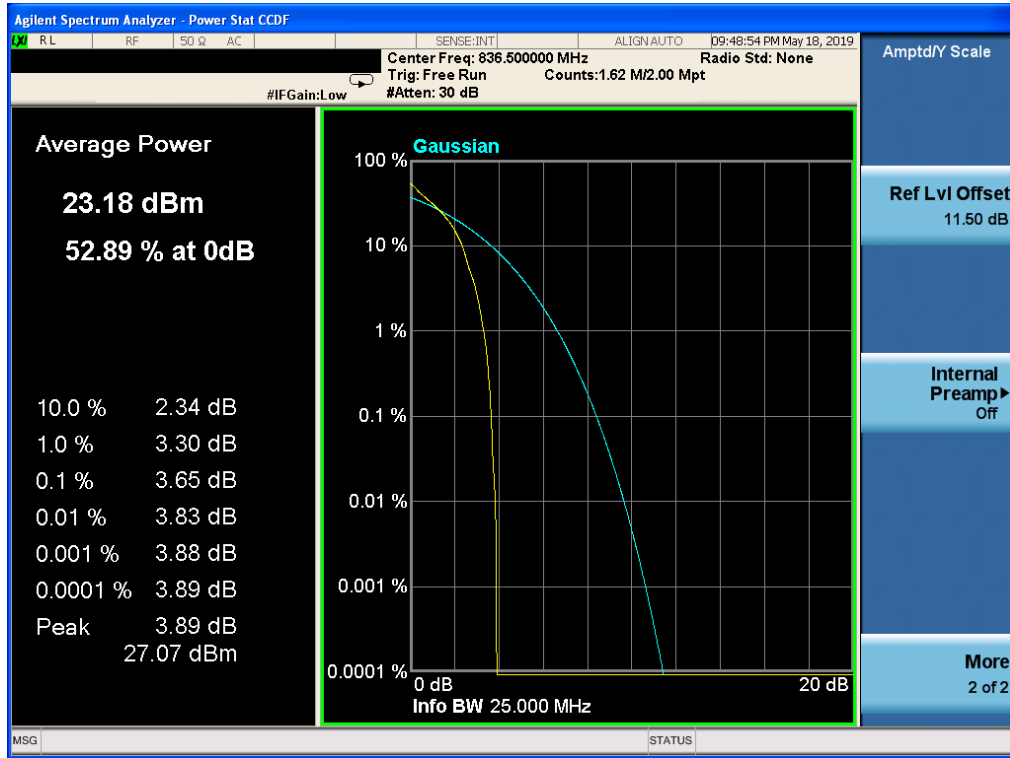

Band 5, UL Channel 20525, UL Frequency 836.5, BW 10.0, NO. RB 1, RB POS. Low, 16-QAM

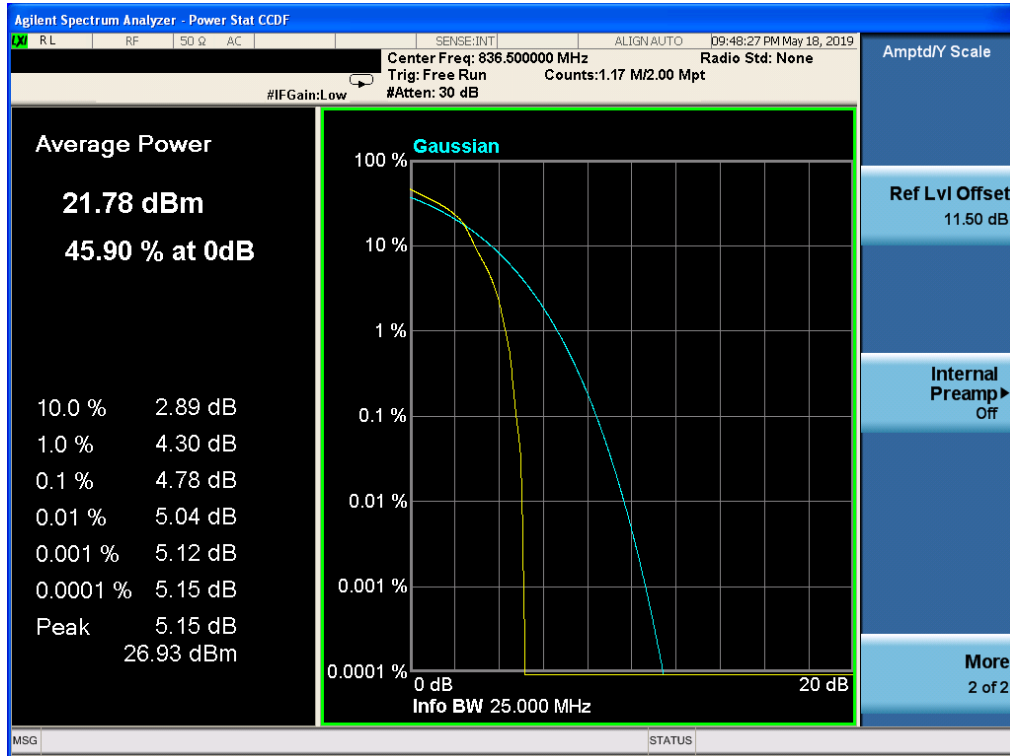

11.8 LTE BAND 7

Band 7, UL Channel 21100, UL Frequency 2535.0, BW 5.0, NO. RB 25, RB POS. Low, QPSK

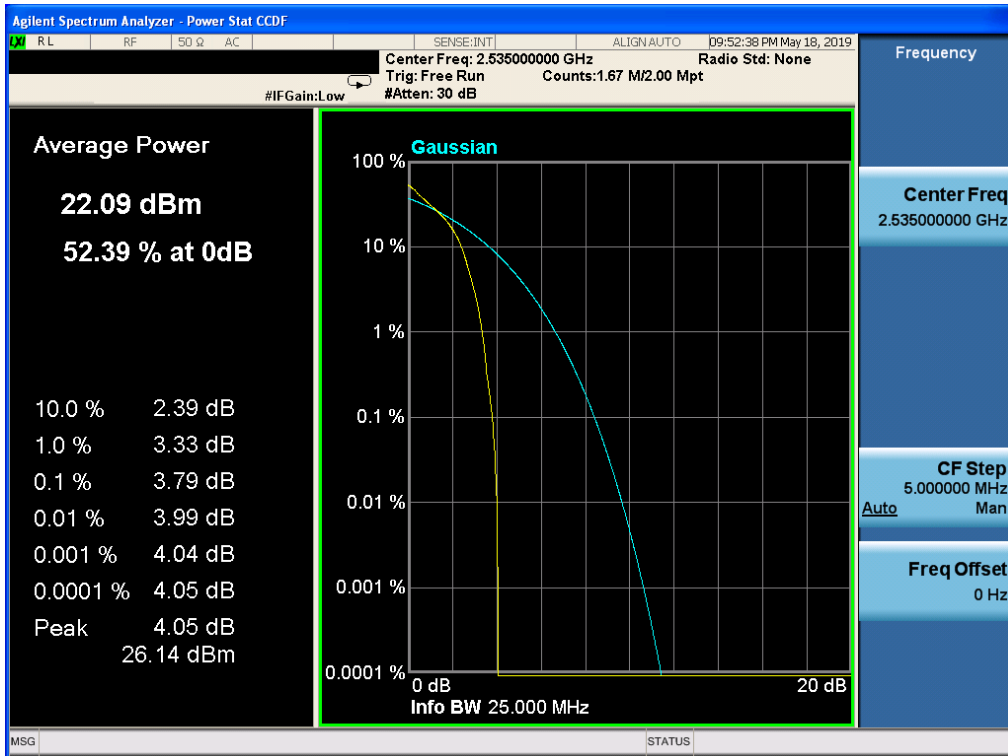

Band 7, UL Channel 21100, UL Frequency 2535.0, BW 5.0, NO. RB 25, RB POS. Low, 16-QAM

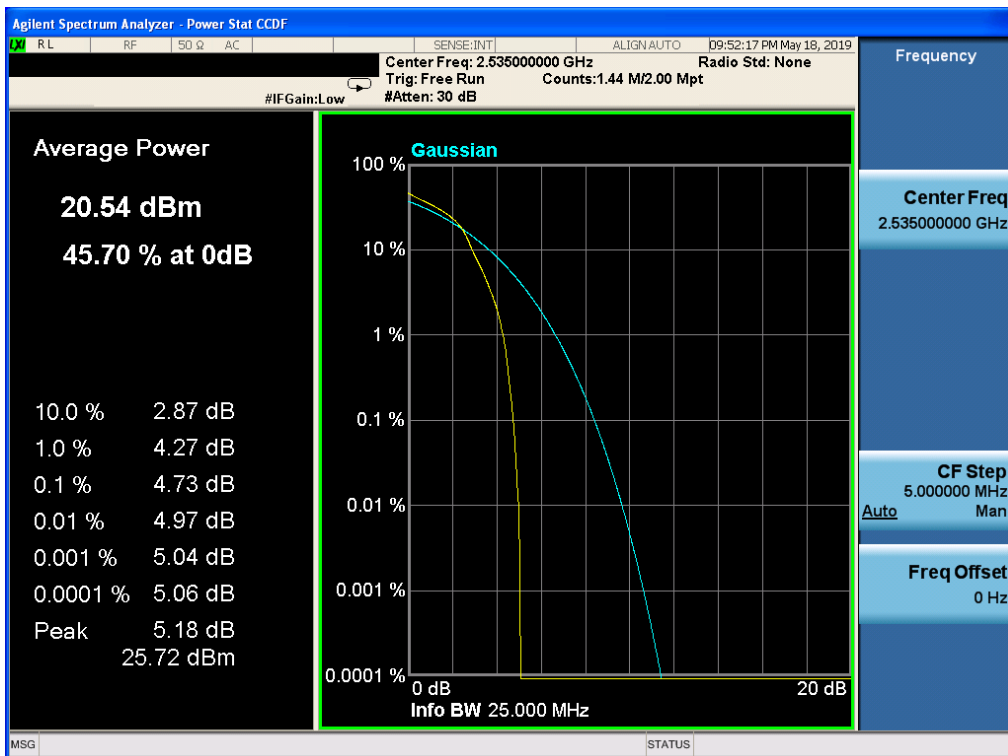

Band 7, UL Channel 21100, UL Frequency 2535.0, BW 10.0, NO. RB 50, RB POS. Low, QPSK

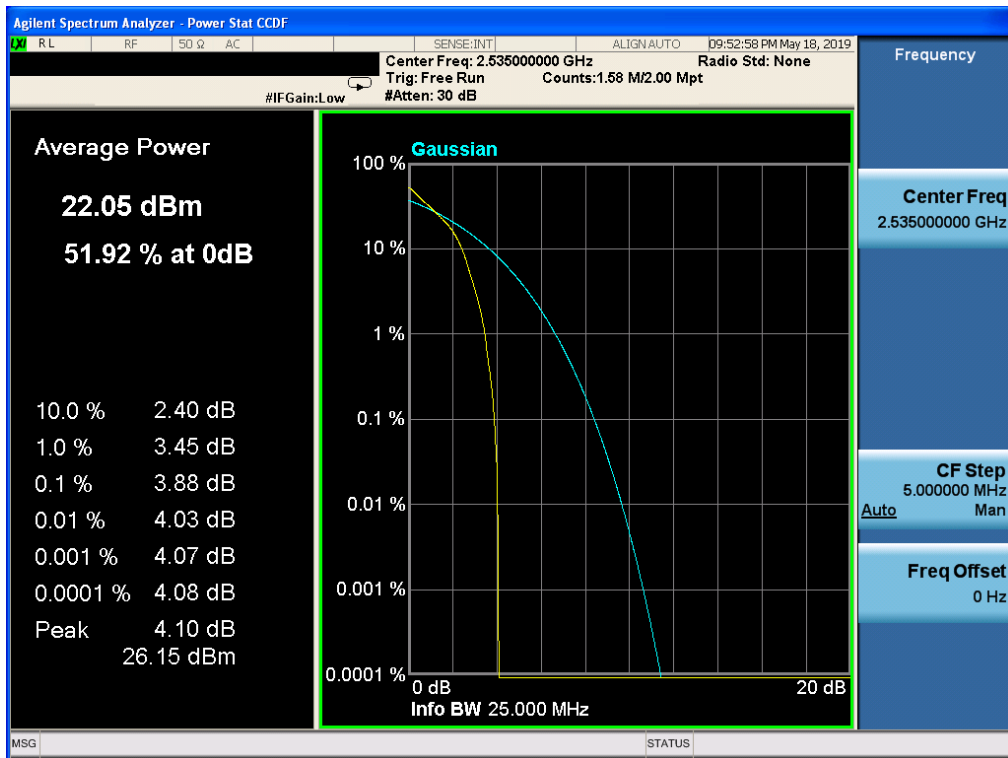

Band 7, UL Channel 21100, UL Frequency 2535.0, BW 10.0, NO. RB 1, RB POS. Low, 16-QAM

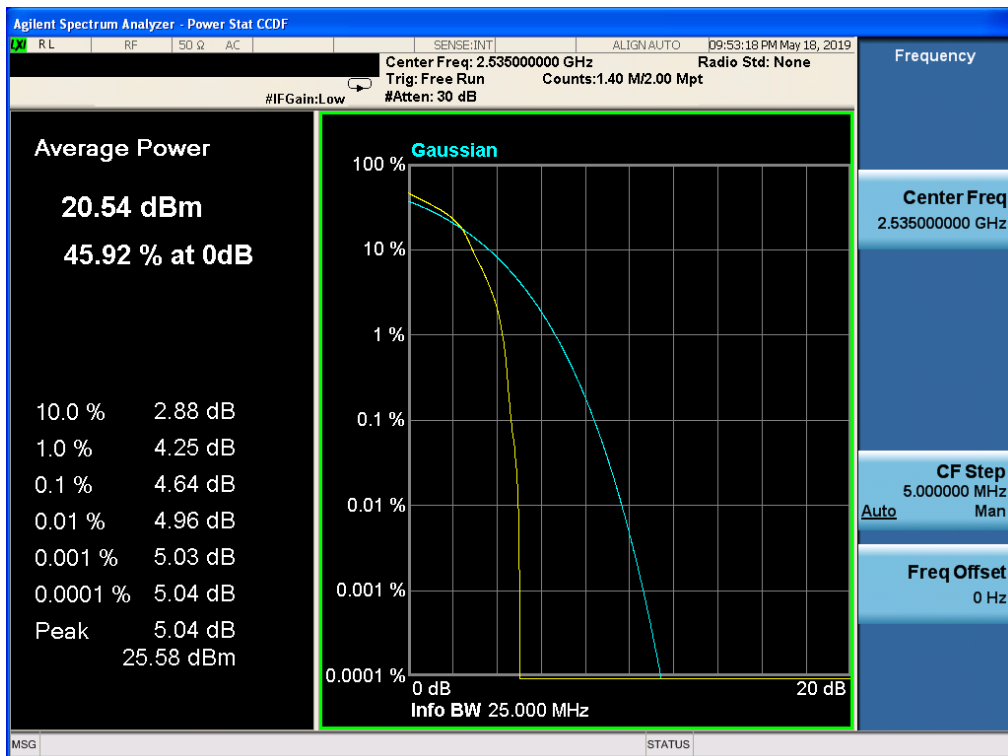

Band 7,UL Channel 21100,UL Frequency 2535.0,BW 15.0,NO. RB 1,RB POS. Low,QPSK

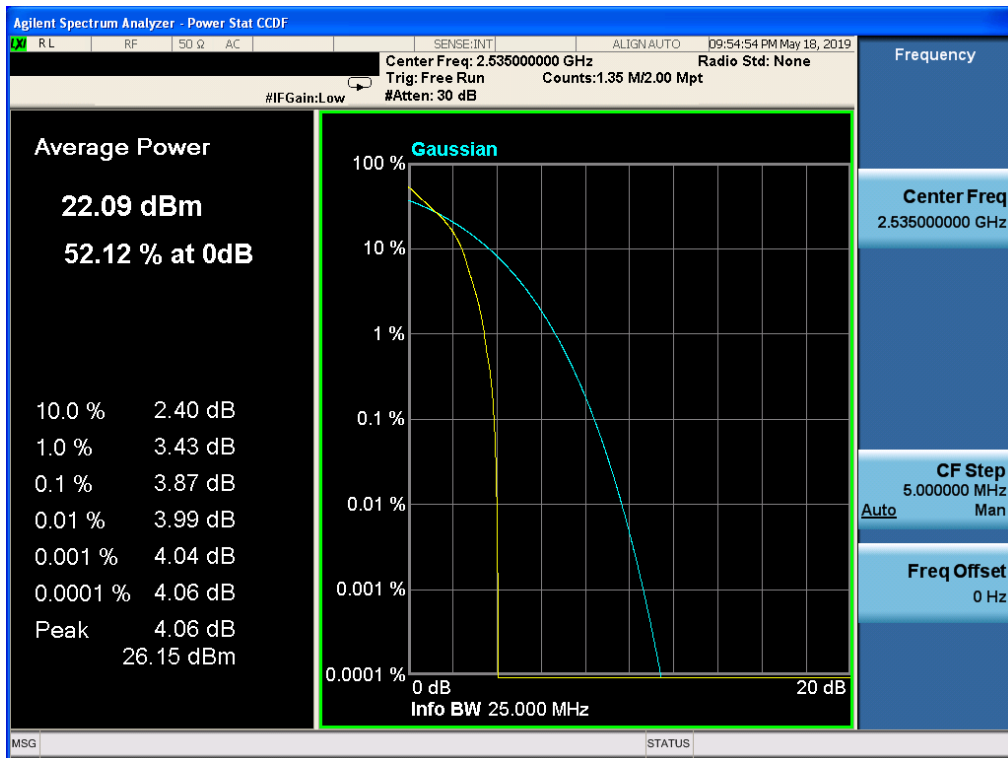

Band 7,UL Channel 21100,UL Frequency 2535.0,BW 15.0,NO. RB 1,RB POS. Low,16-QAM

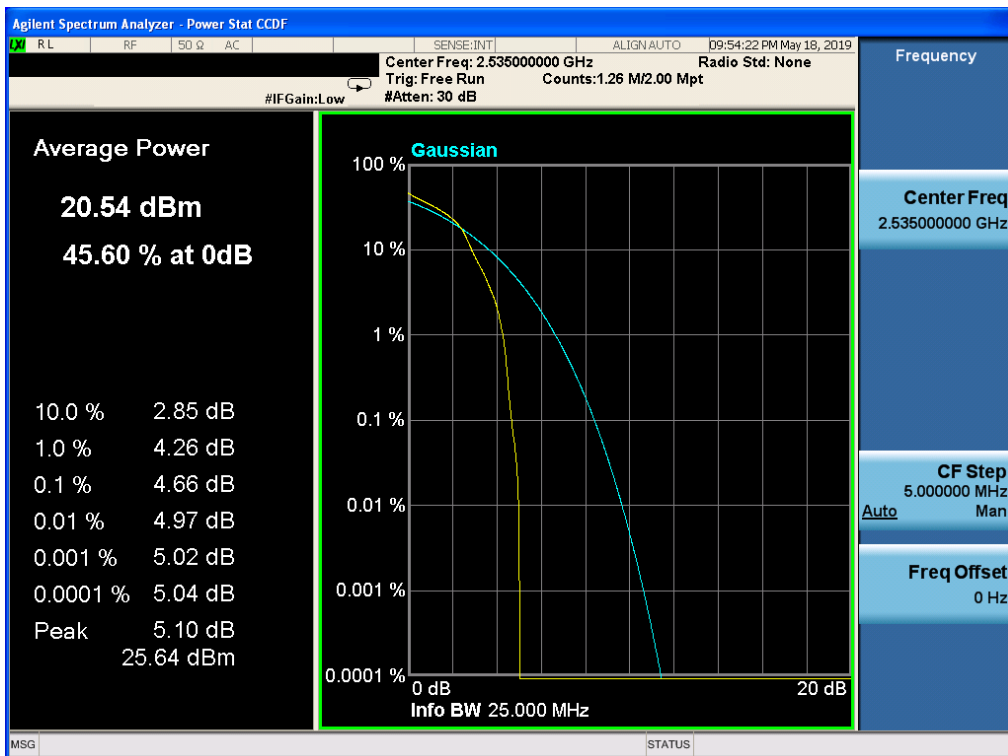

Band 7, UL Channel 21100, UL Frequency 2535.0, BW 20.0, NO. RB 1, RB POS. Low, QPSK

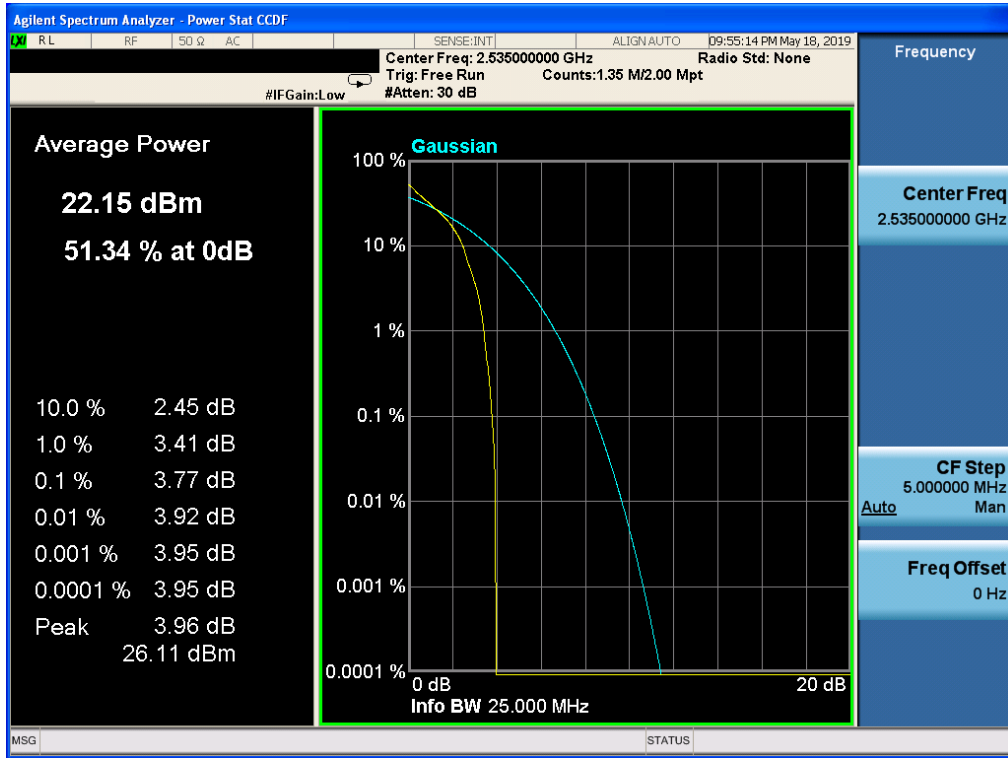

Band 7, UL Channel 21100, UL Frequency 2535.0, BW 20.0, NO. RB 1, RB POS. Low, 16-QAM

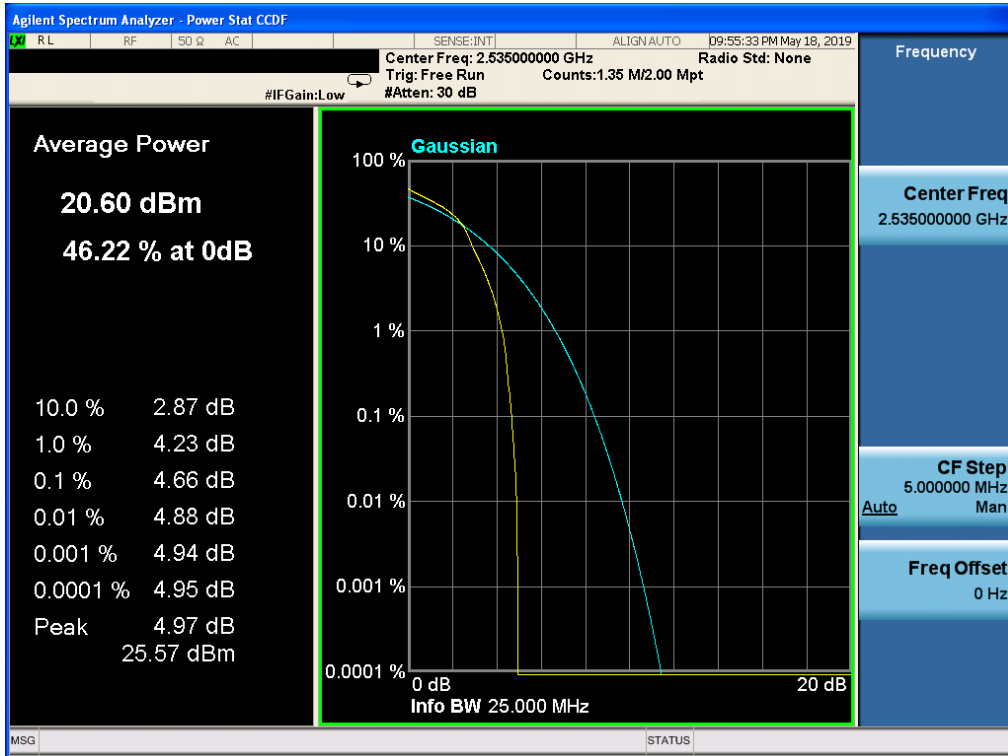

----END OF REPORT----