

### 7.4 LTE BAND 7

Band 7, UL Channel 20775, UL Frequency 2502.5, BW 5.0, NO. RB 25, RB POS. Low, QPSK

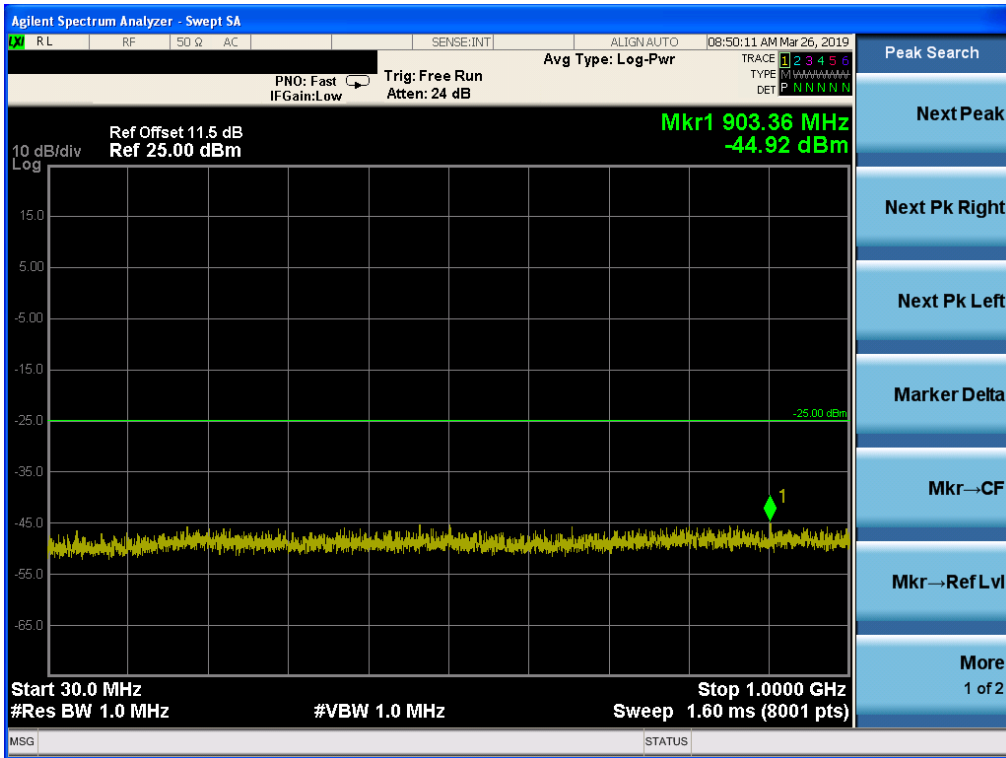

Band 7, UL Channel 20775, UL Frequency 2502.5, BW 5.0, NO. RB 25, RB POS. Low, QPSK

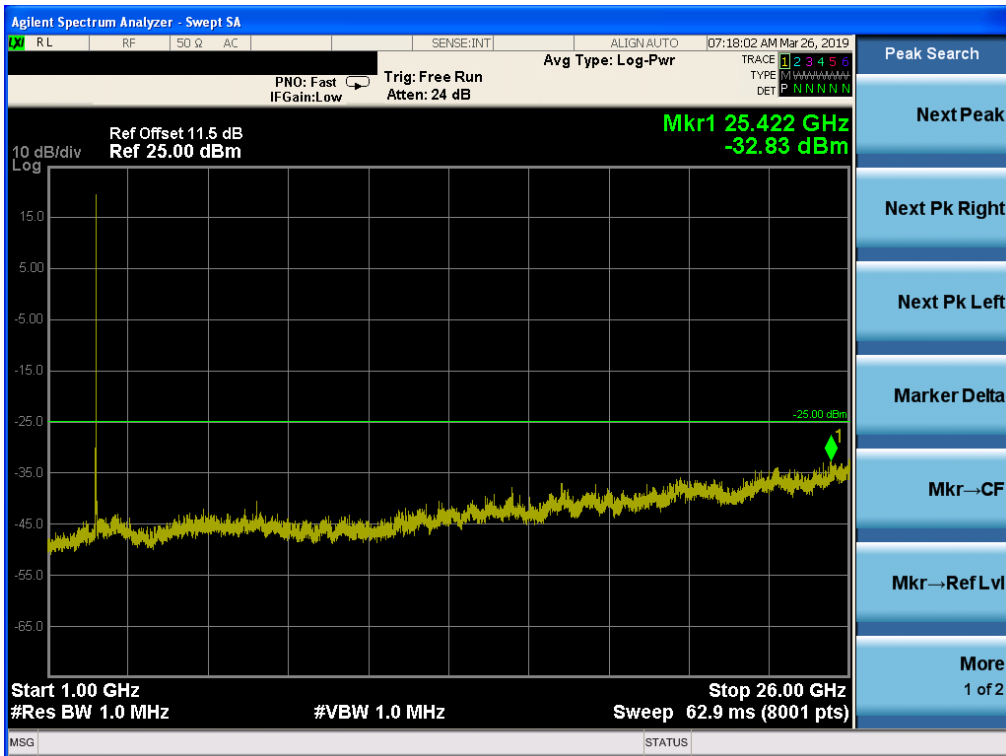

Band 7, UL Channel 20775, UL Frequency 2502.5, BW 5.0, NO. RB 25, RB POS. Low, 16-QAM

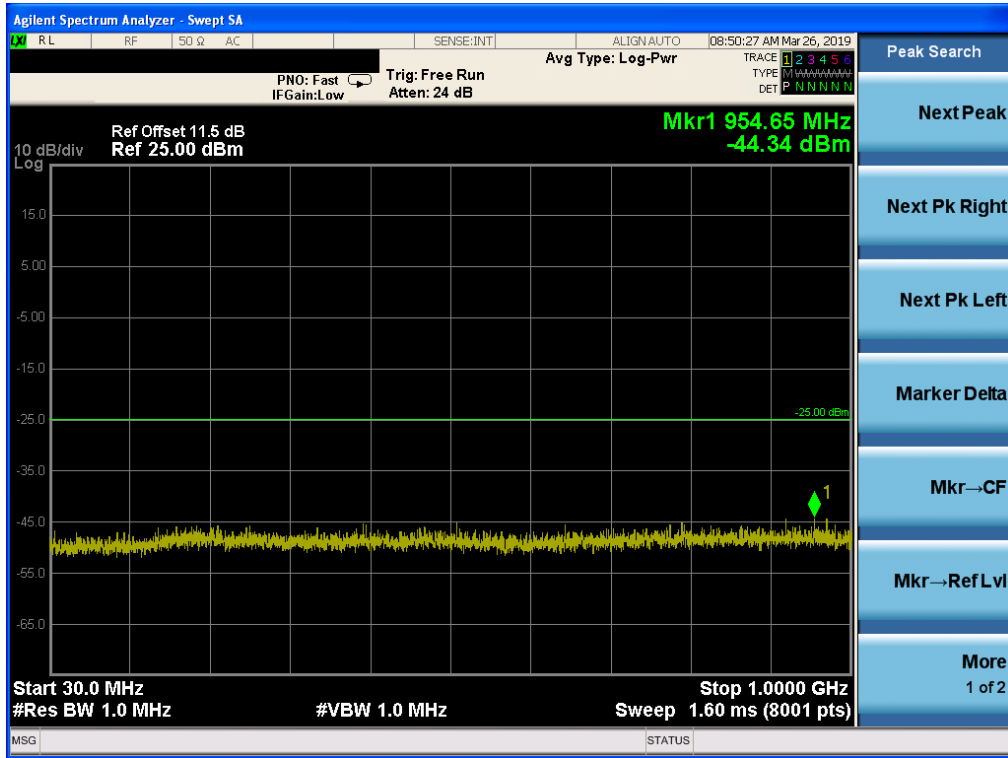

Band 7, UL Channel 20775, UL Frequency 2502.5, BW 5.0, NO. RB 25, RB POS. Low, 16-QAM

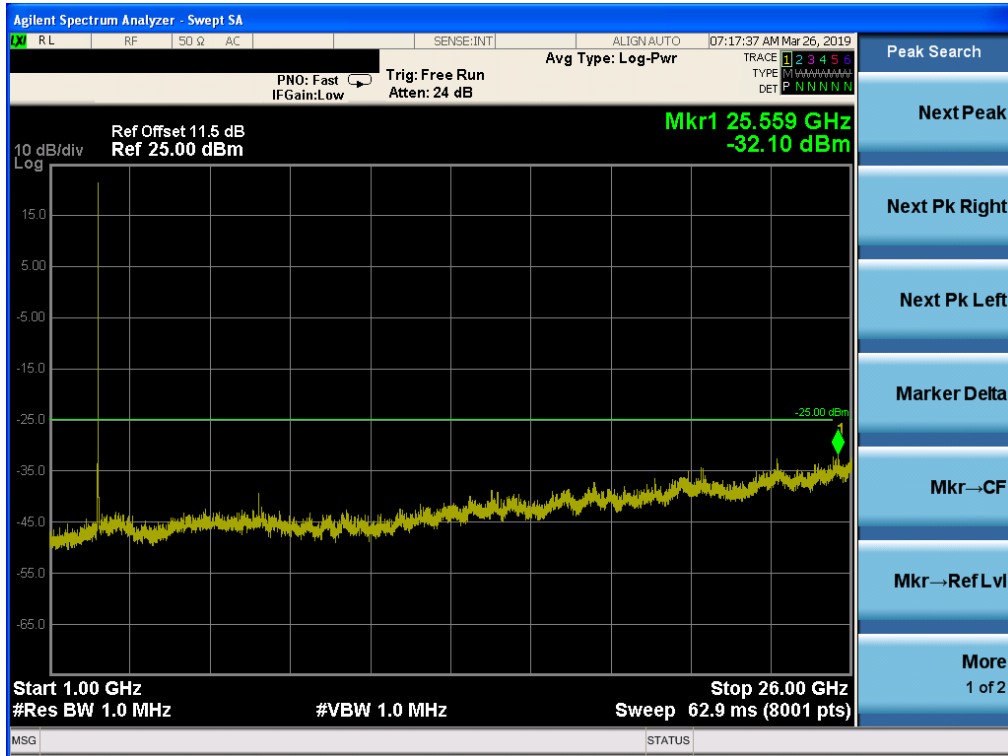

Band 7, UL Channel 21425, UL Frequency 2567.5, BW 5.0, NO. RB 25, RB POS. Low, QPSK

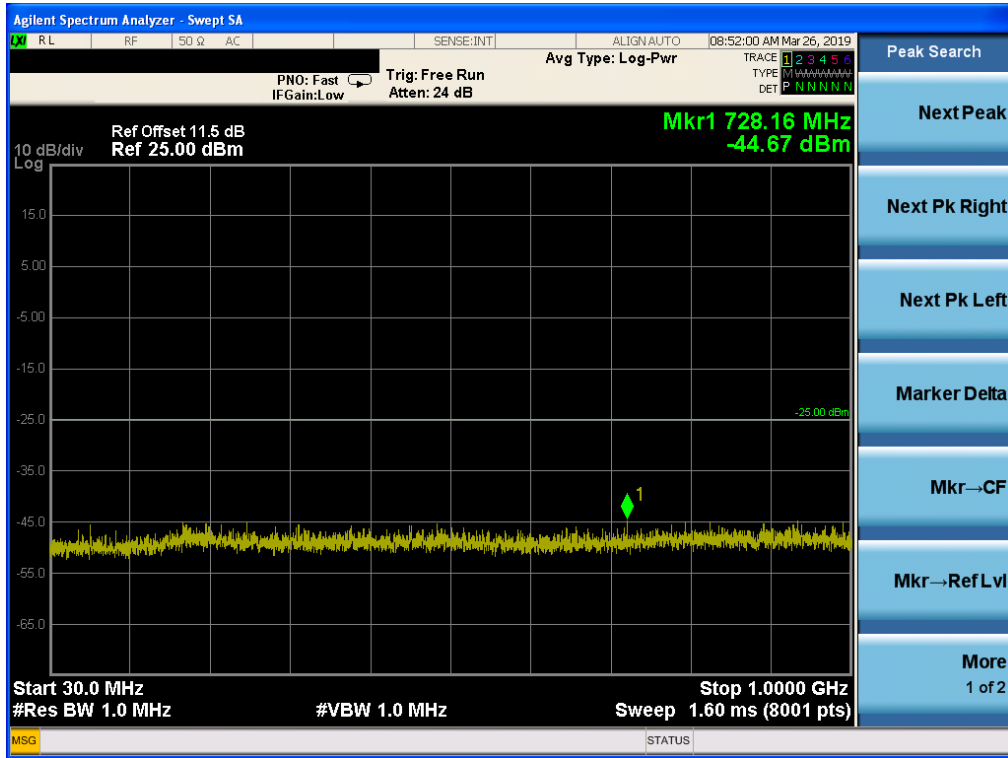

Band 7, UL Channel 21425, UL Frequency 2567.5, BW 5.0, NO. RB 25, RB POS. Low, QPSK

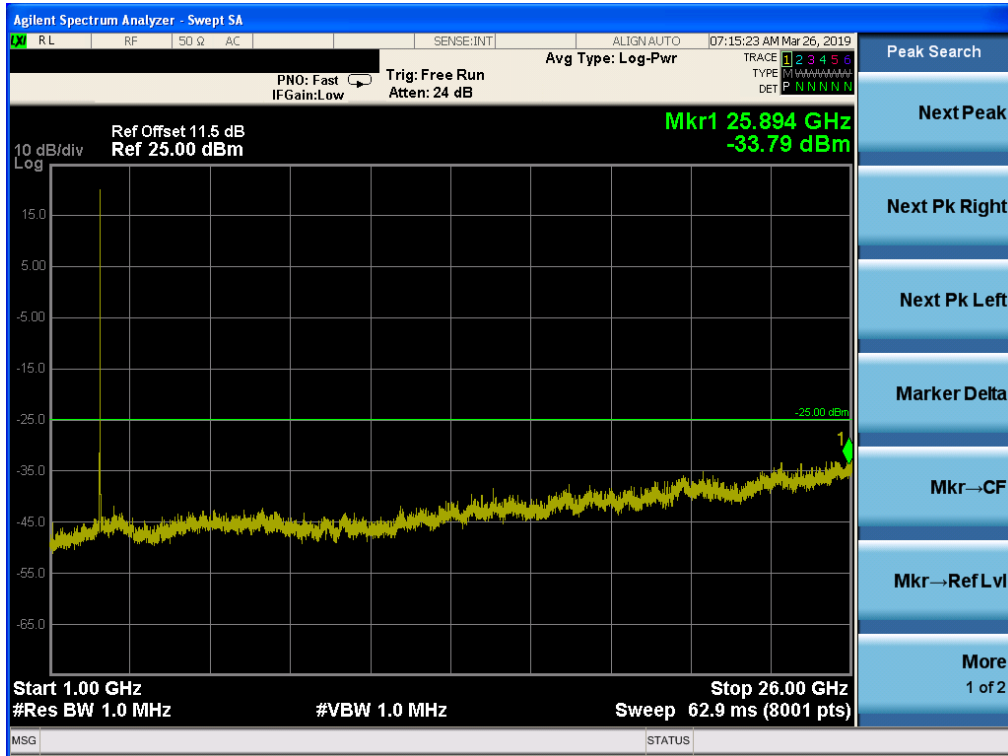

Band 7, UL Channel 21425, UL Frequency 2567.5, BW 5.0, NO. RB 25, RB POS. Low, 16-QAM

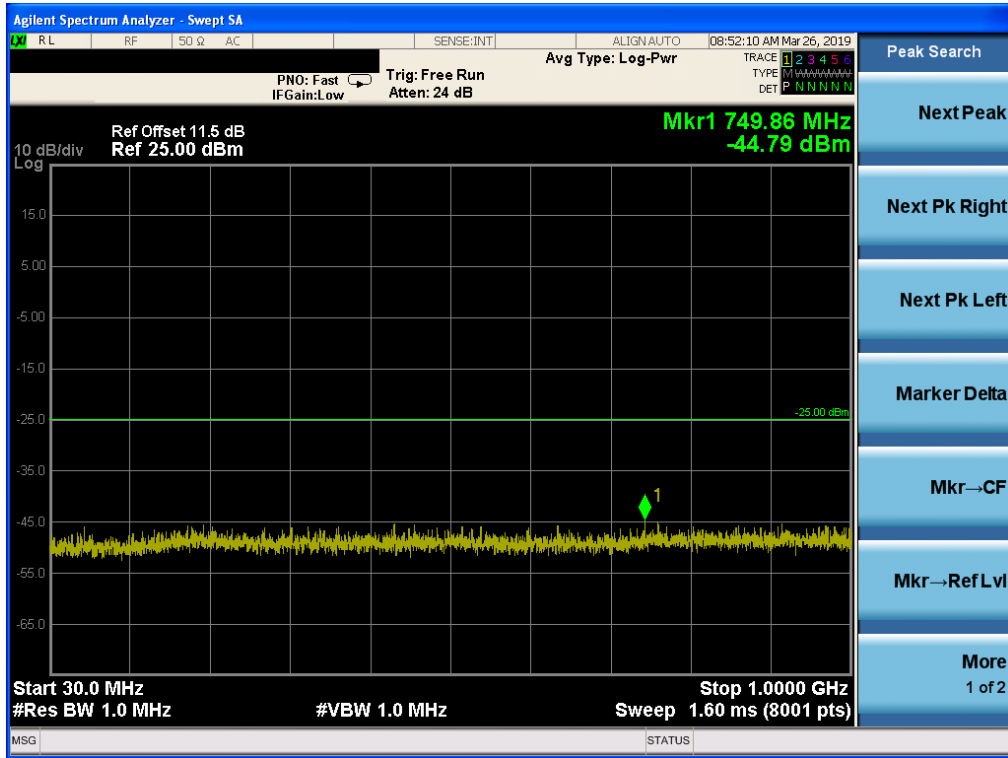

Band 7, UL Channel 21425, UL Frequency 2567.5, BW 5.0, NO. RB 25, RB POS. Low, 16-QAM

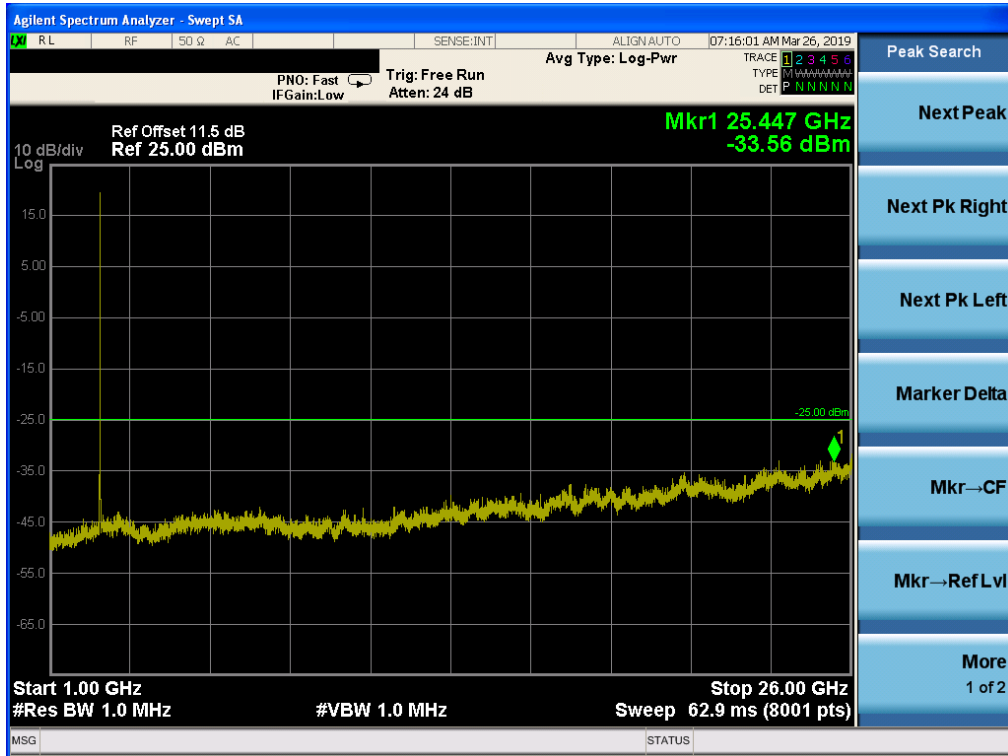

Band 7, UL Channel 20800, UL Frequency 2505.0, BW 10.0, NO. RB 50, RB POS. Low, QPSK

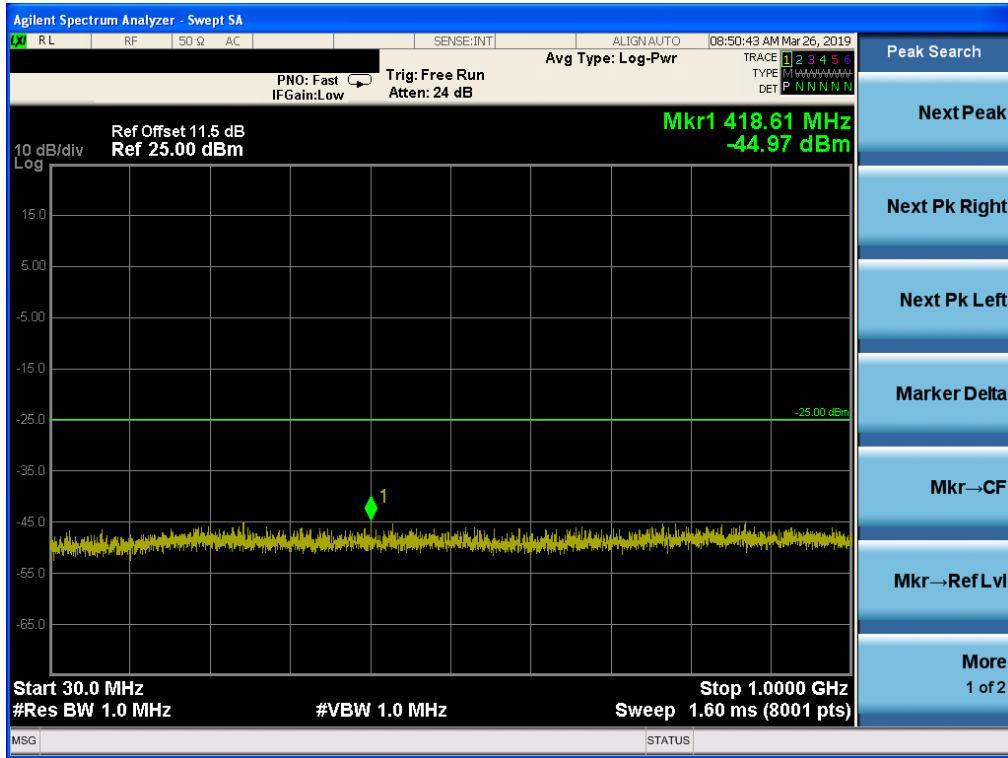

Band 7, UL Channel 20800, UL Frequency 2505.0, BW 10.0, NO. RB 50, RB POS. Low, QPSK

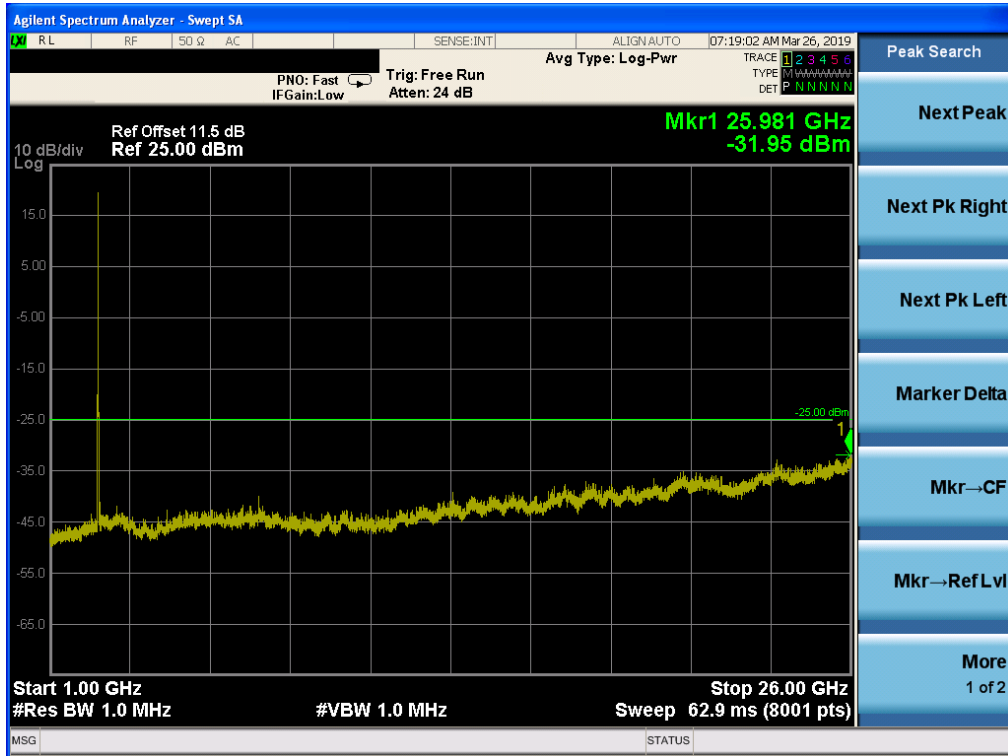

Band 7, UL Channel 20800, UL Frequency 2505.0, BW 10.0, NO. RB 50, RB POS. Low, 16-QAM

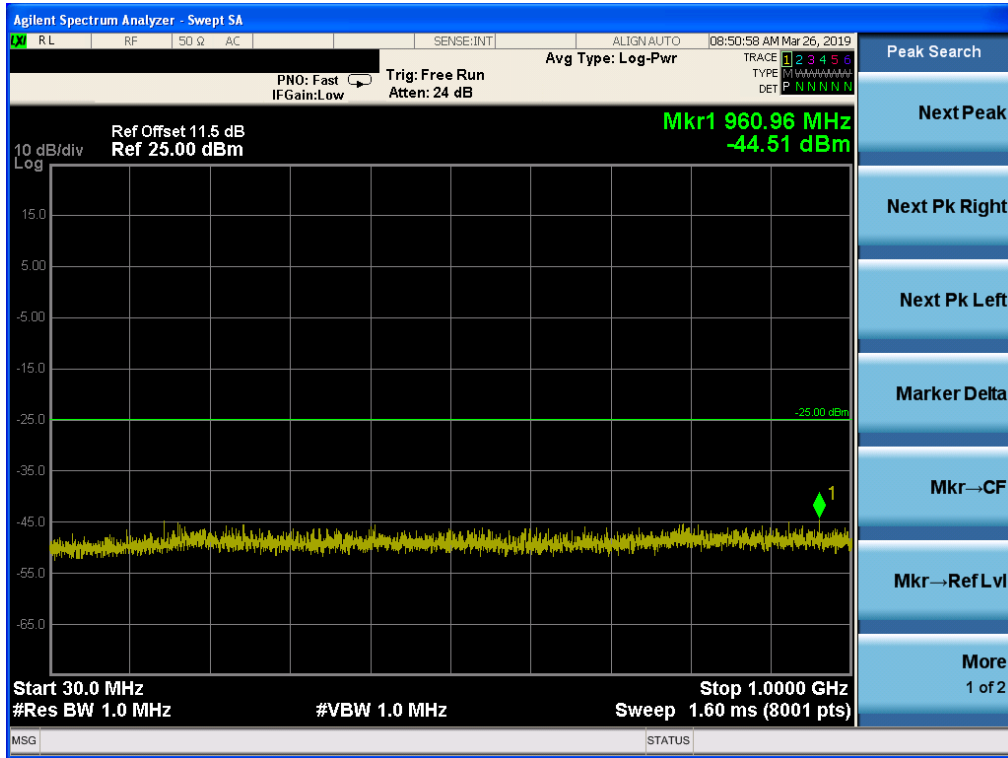

Band 7, UL Channel 20800, UL Frequency 2505.0, BW 10.0, NO. RB 50, RB POS. Low, 16-QAM

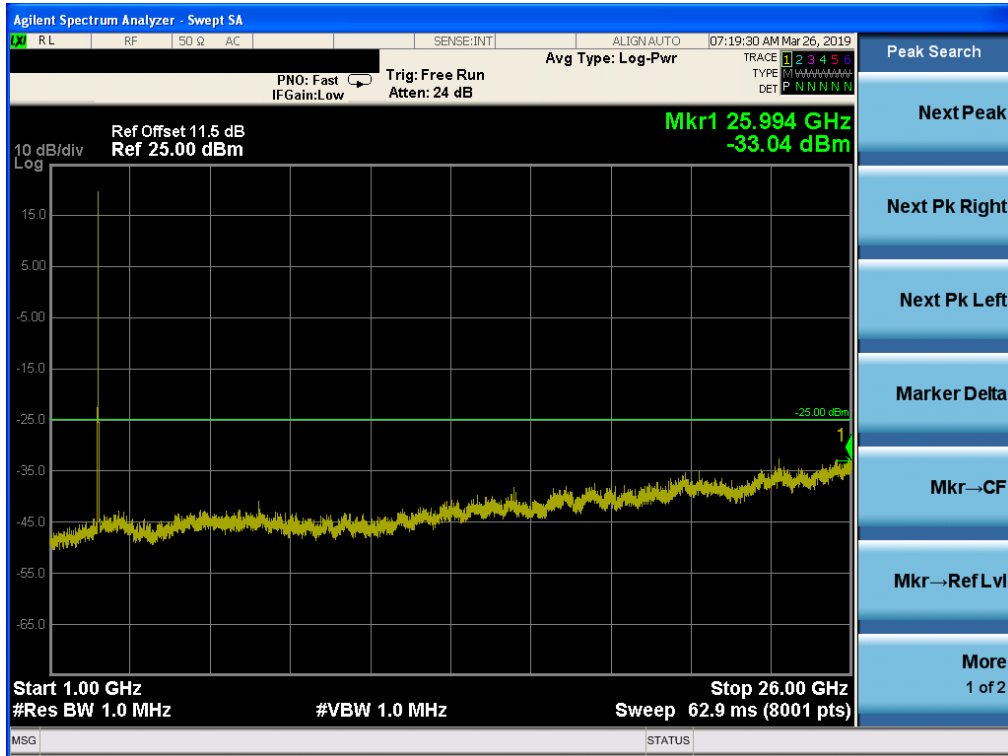

Band 7, UL Channel 21400, UL Frequency 2565.0, BW 10.0, NO. RB 50, RB POS. Low, QPSK

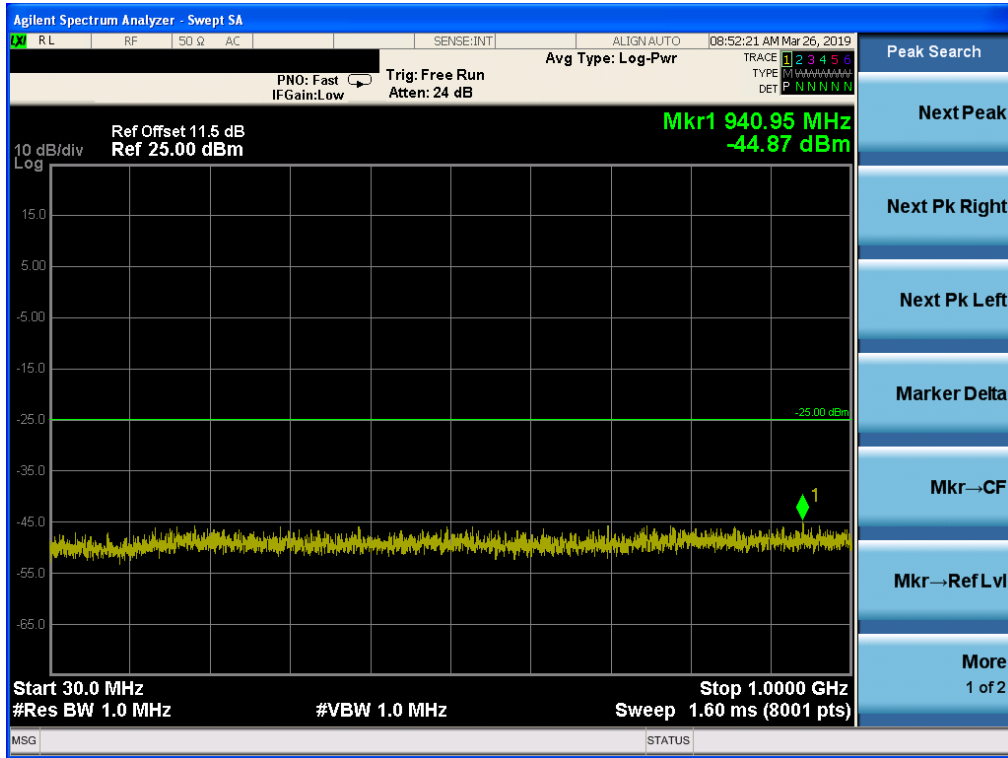

Band 7, UL Channel 21400, UL Frequency 2565.0, BW 10.0, NO. RB 50, RB POS. Low, QPSK

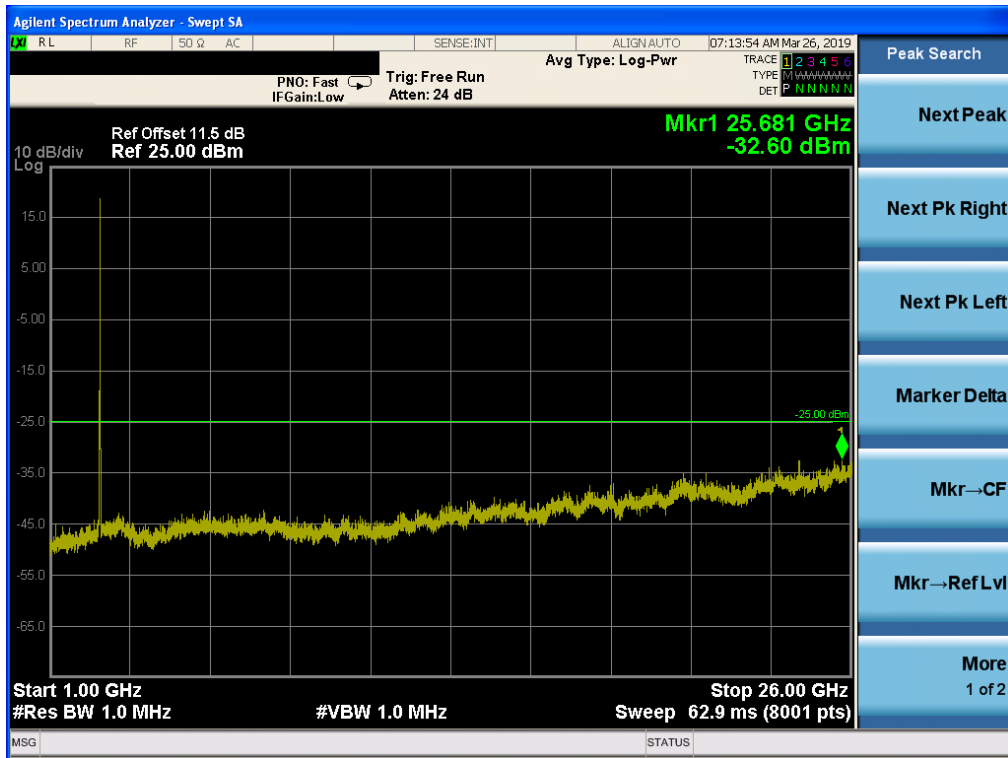

Band 7, UL Channel 21400, UL Frequency 2565.0, BW 10.0, NO. RB 50, RB POS. Low, 16-QAM

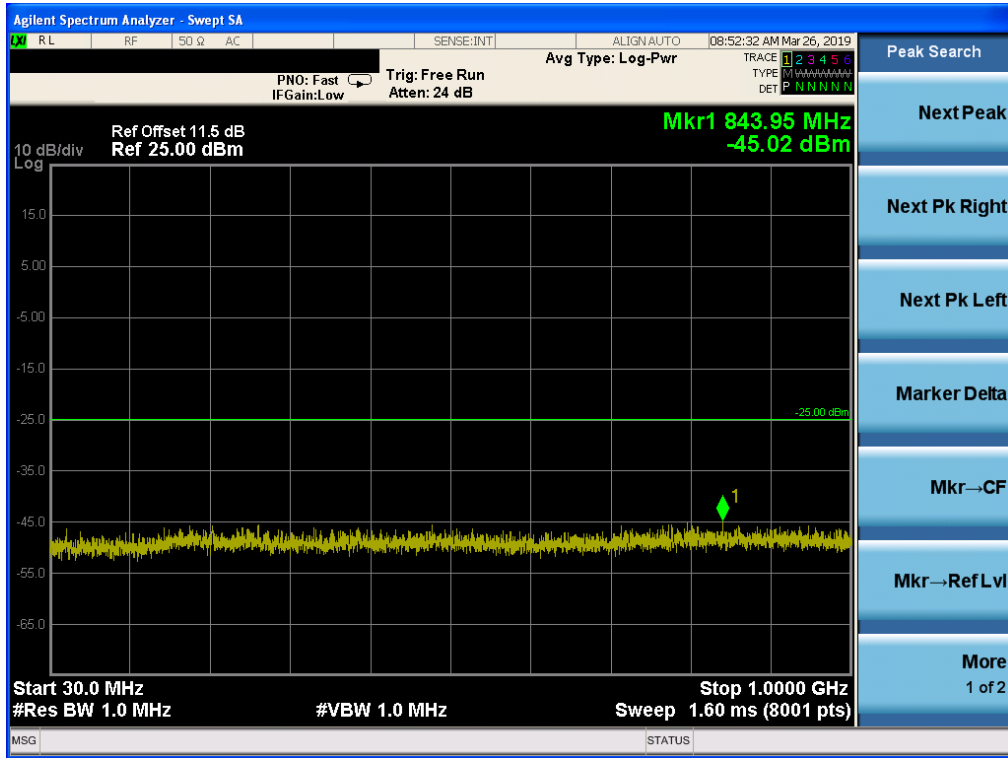

Band 7, UL Channel 21400, UL Frequency 2565.0, BW 10.0, NO. RB 50, RB POS. Low, 16-QAM

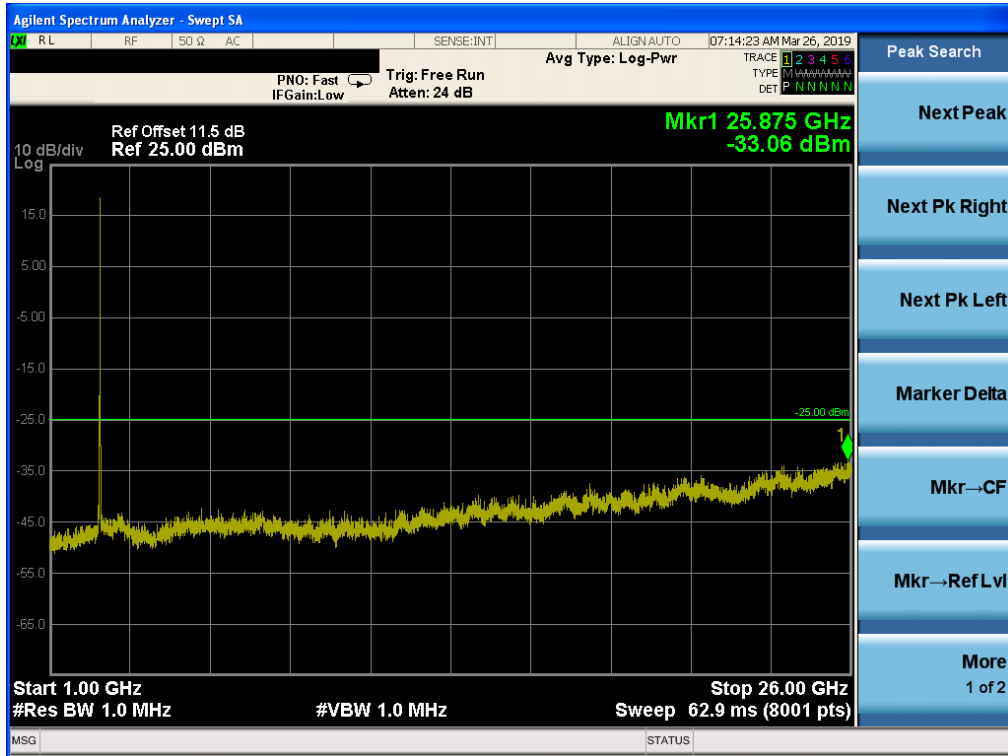



Band 7, UL Channel 20825, UL Frequency 2507.5, BW 15.0, NO. RB 75, RB POS. Low, QPSK

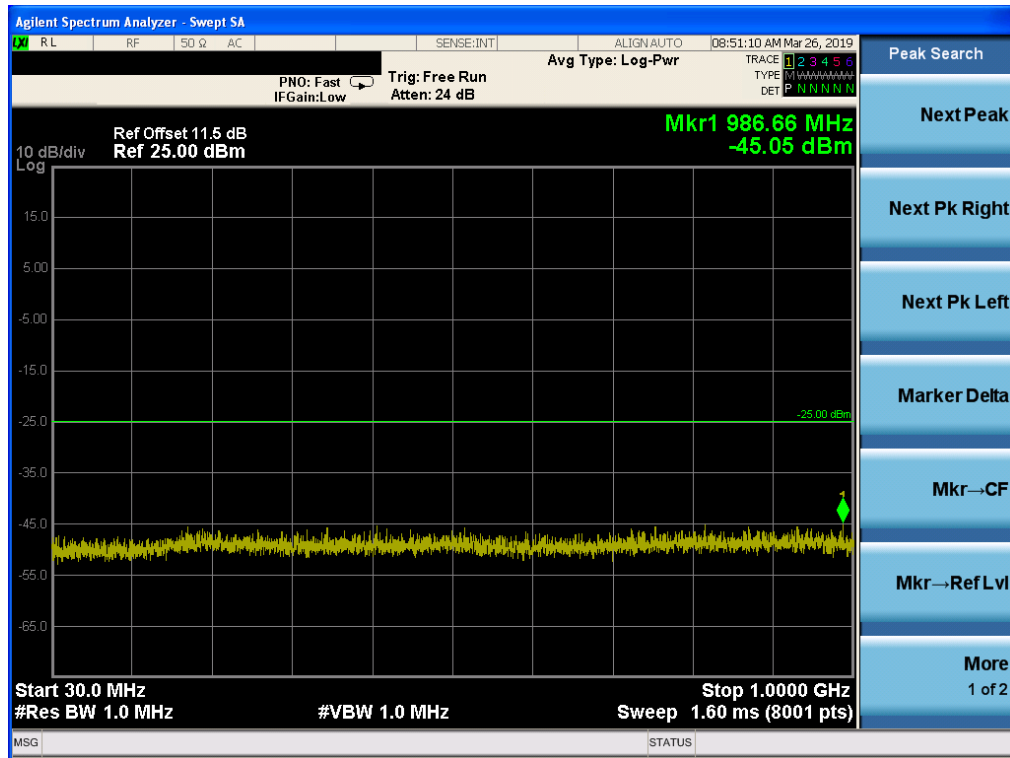

Band 7, UL Channel 20825, UL Frequency 2507.5, BW 15.0, NO. RB 75, RB POS. Low, QPSK

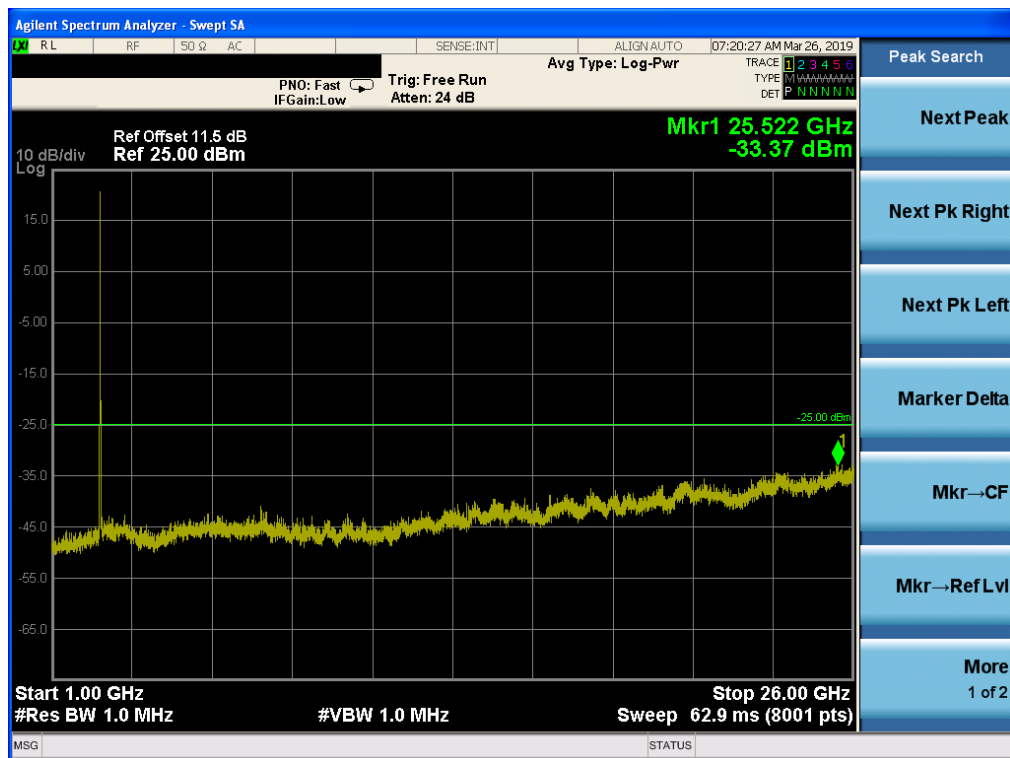

Band 7, UL Channel 20825, UL Frequency 2507.5, BW 15.0, NO. RB 75, RB POS. Low, 16-QAM

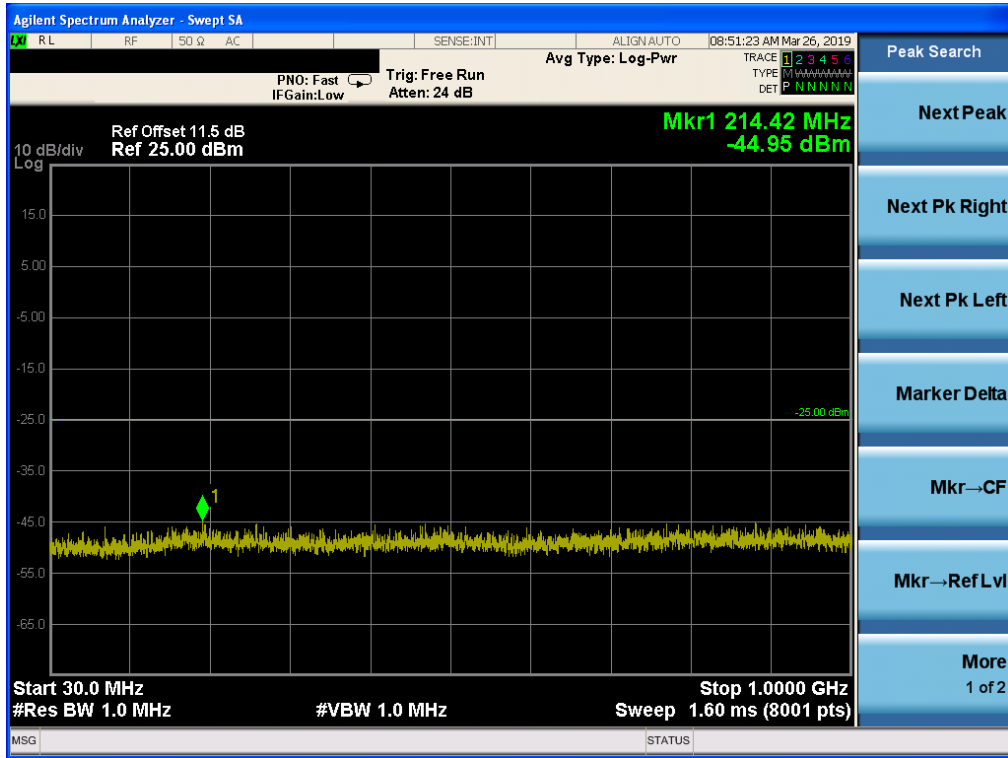

Band 7, UL Channel 20825, UL Frequency 2507.5, BW 15.0, NO. RB 75, RB POS. Low, 16-QAM

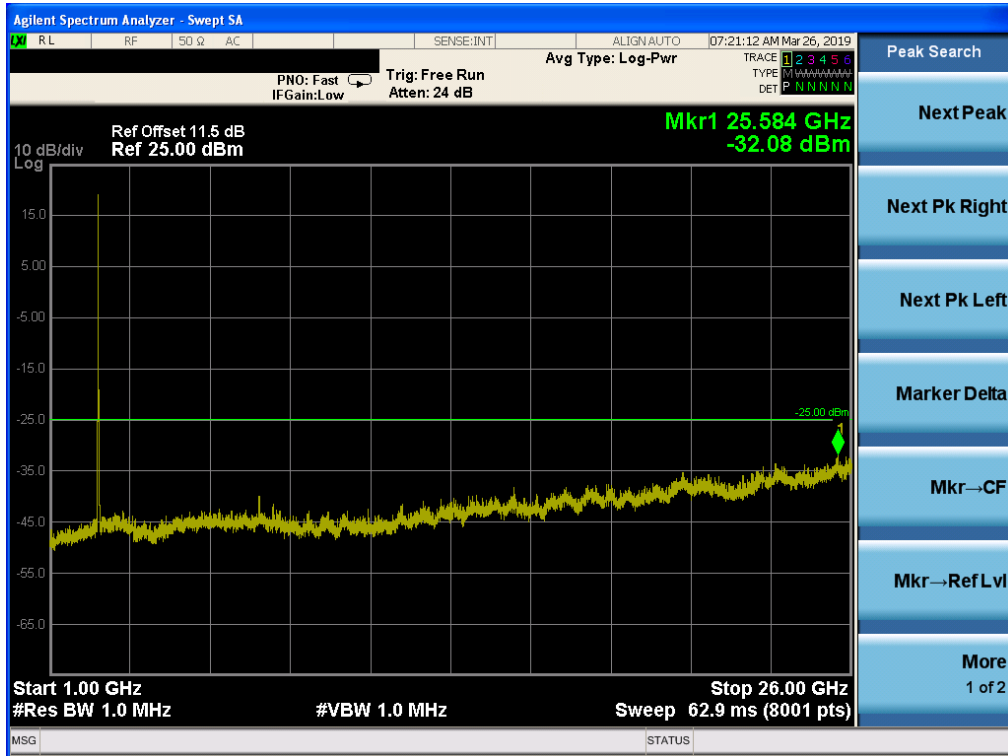

Band 7, UL Channel 21375, UL Frequency 2562.5, BW 15.0, NO. RB 75, RB POS. Low, QPSK

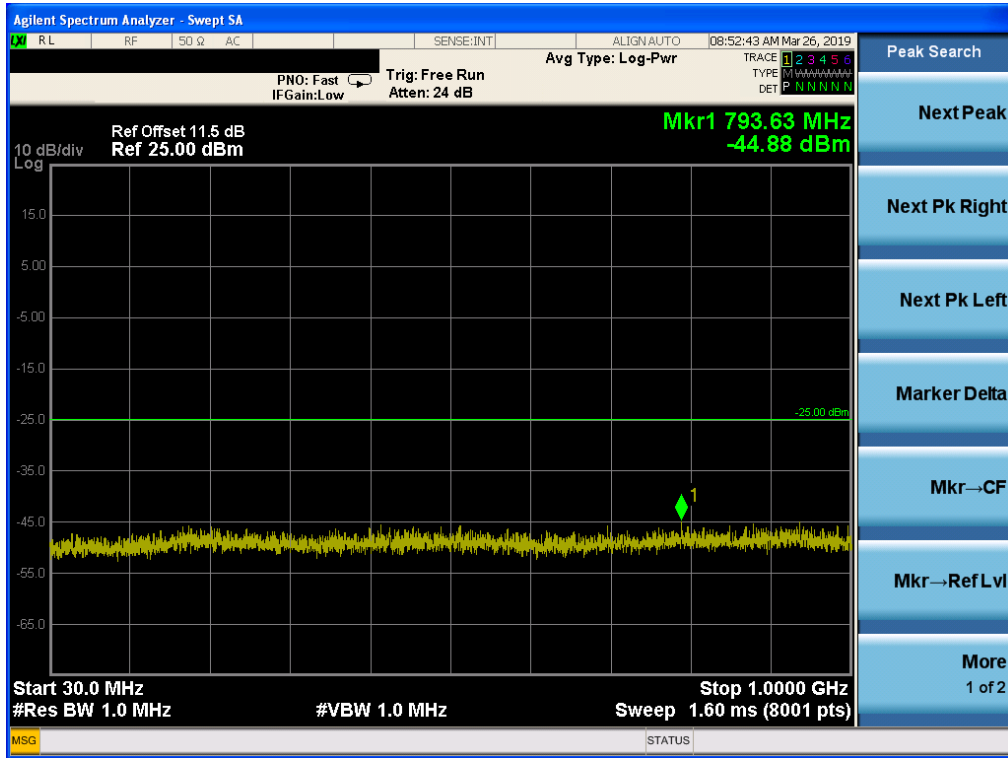

Band 7, UL Channel 21375, UL Frequency 2562.5, BW 15.0, NO. RB 75, RB POS. Low, QPSK

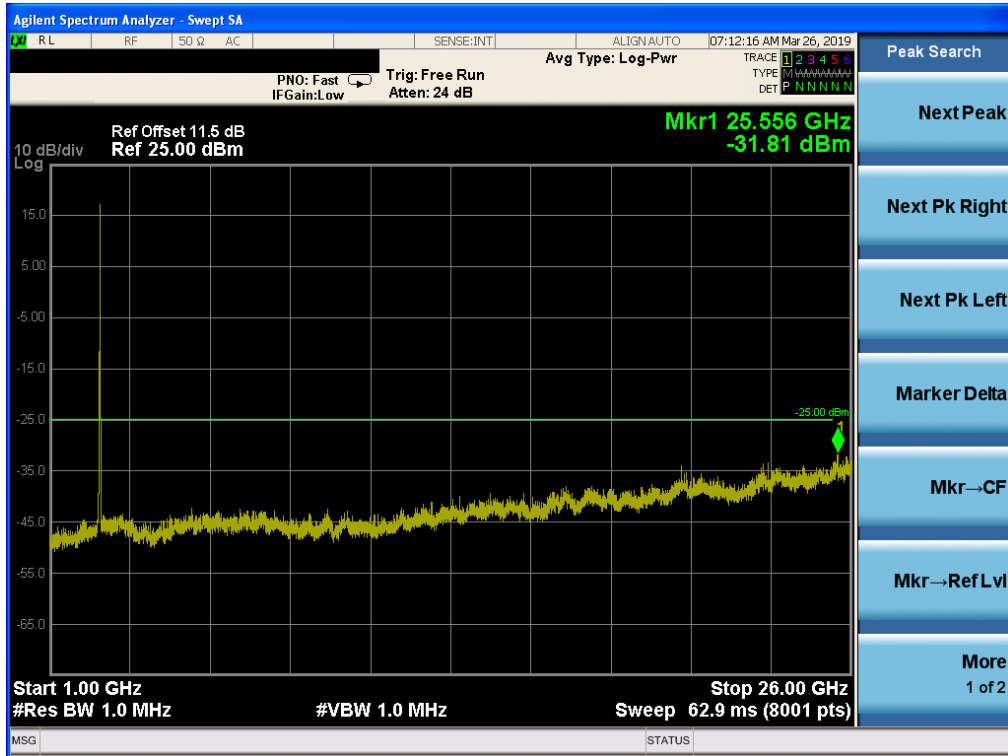

Band 7, UL Channel 21375, UL Frequency 2562.5, BW 15.0, NO. RB 75, RB POS. Low, 16-QAM

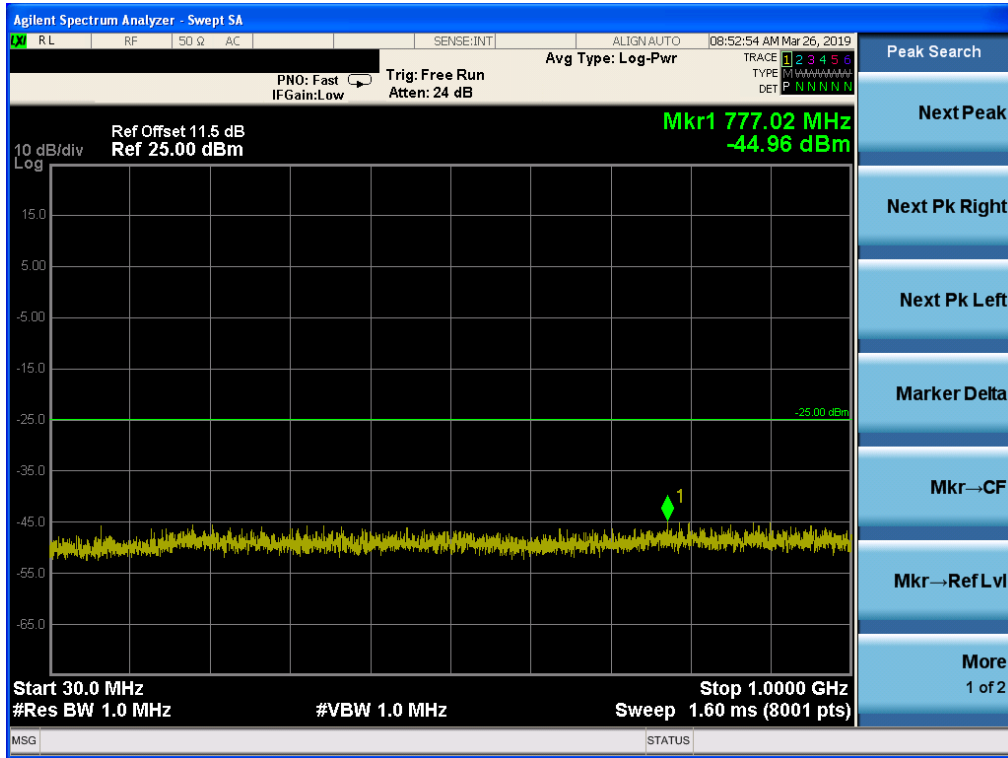

Band 7, UL Channel 21375, UL Frequency 2562.5, BW 15.0, NO. RB 75, RB POS. Low, 16-QAM

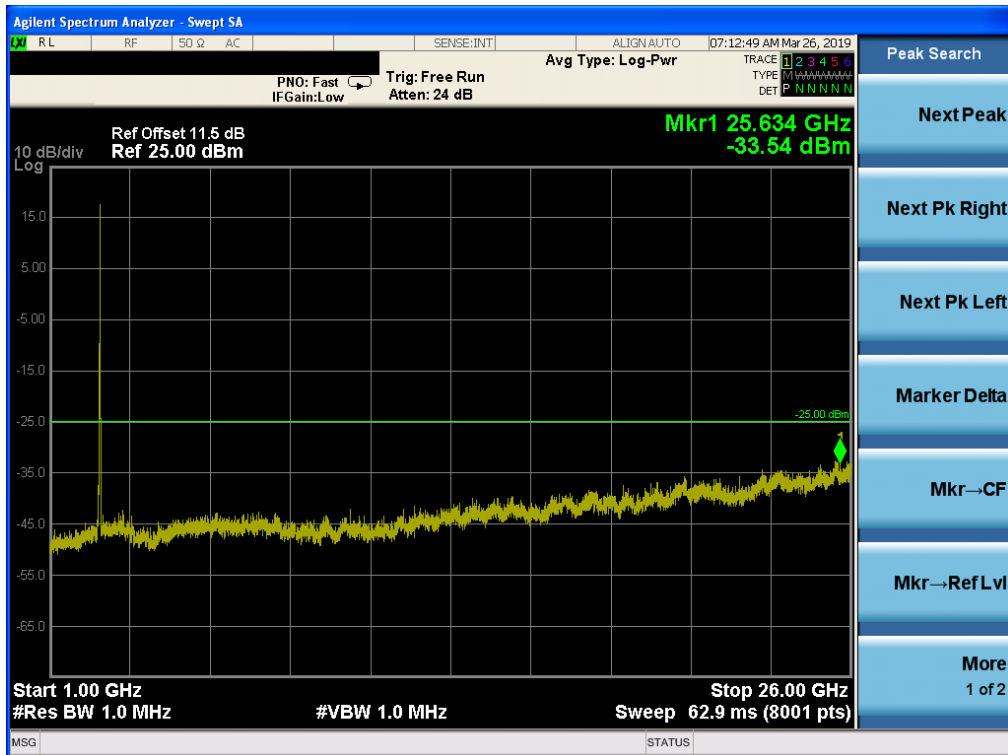

Band 7, UL Channel 20850, UL Frequency 2510.0, BW 20.0, NO. RB 100, RB POS. Low, QPSK

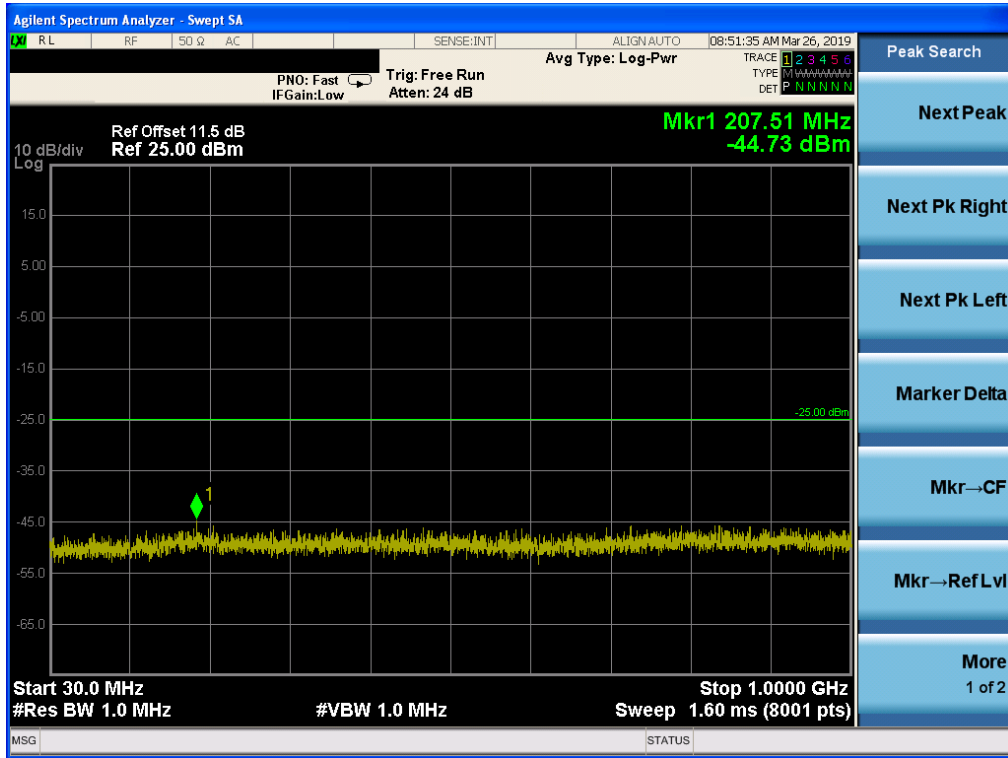

Band 7, UL Channel 20850, UL Frequency 2510.0, BW 20.0, NO. RB 100, RB POS. Low, QPSK

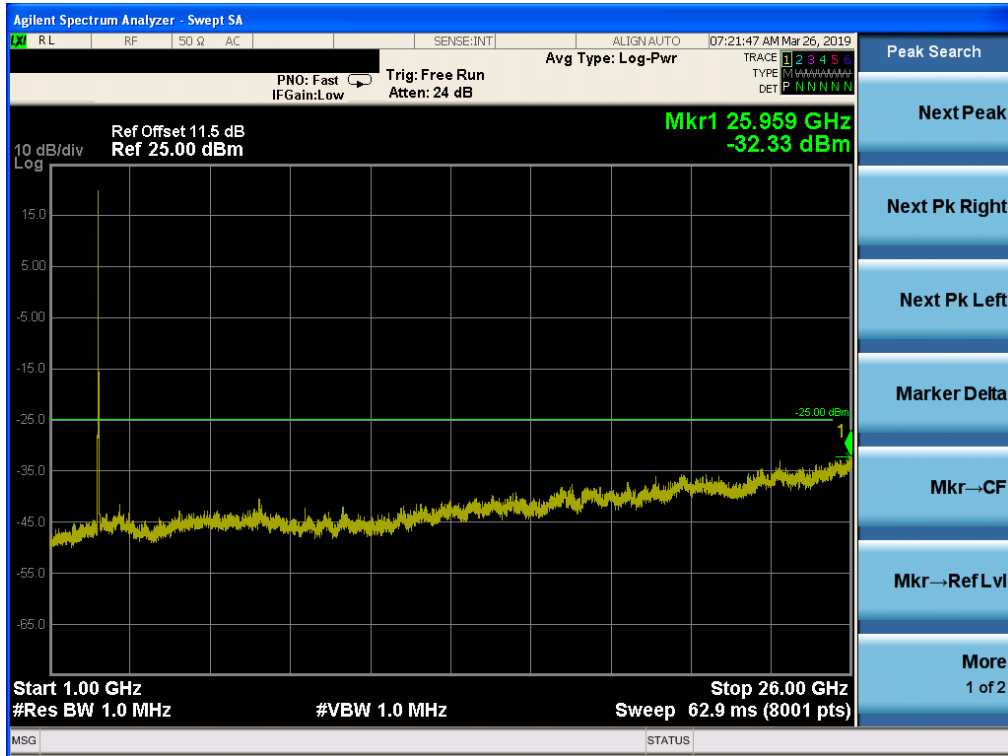

Band 7, UL Channel 20850, UL Frequency 2510.0, BW 20.0, NO. RB 100, RB POS. Low, 16-QAM

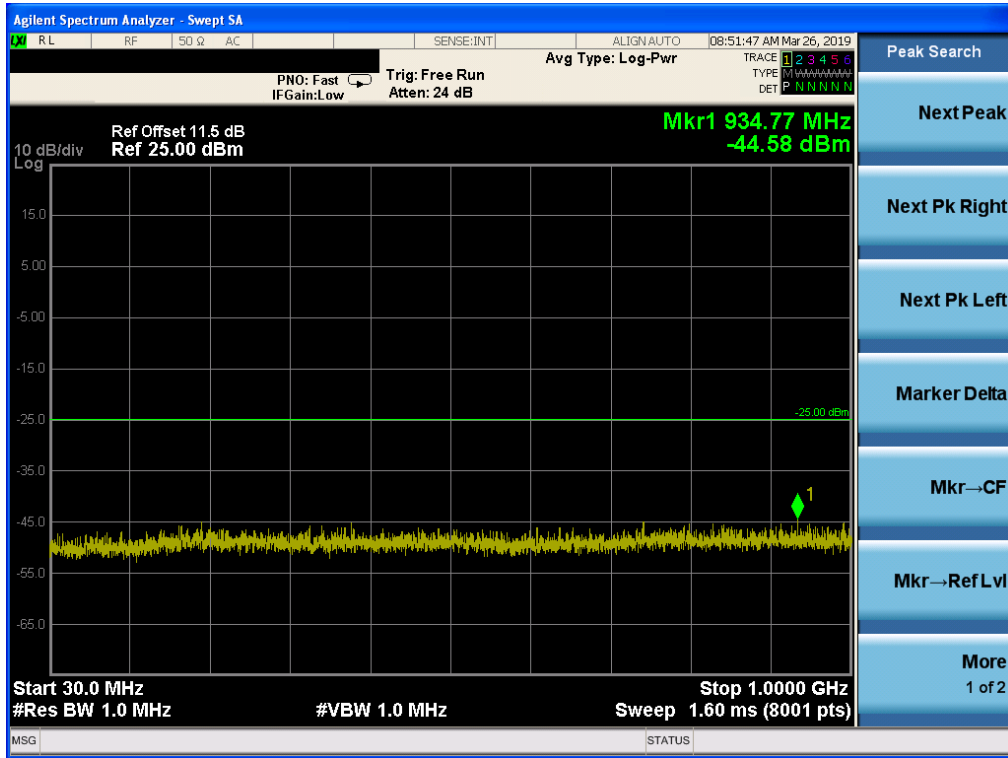

Band 7, UL Channel 20850, UL Frequency 2510.0, BW 20.0, NO. RB 100, RB POS. Low, 16-QAM

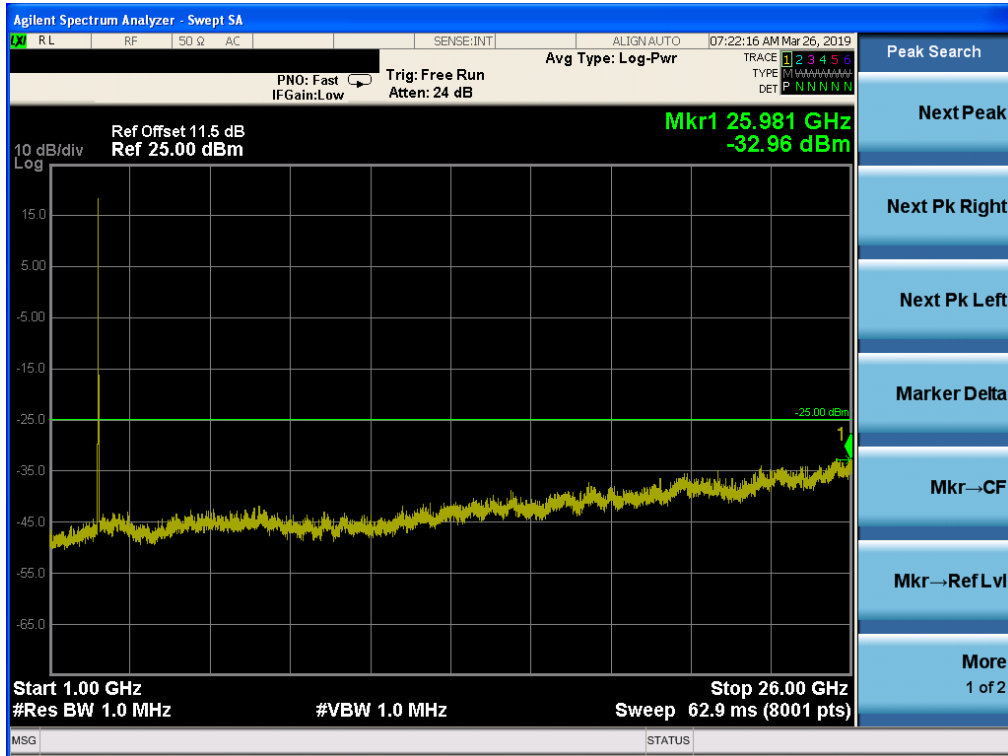

Band 7, UL Channel 21350, UL Frequency 2560.0, BW 20.0, NO. RB 100, RB POS. Low, QPSK

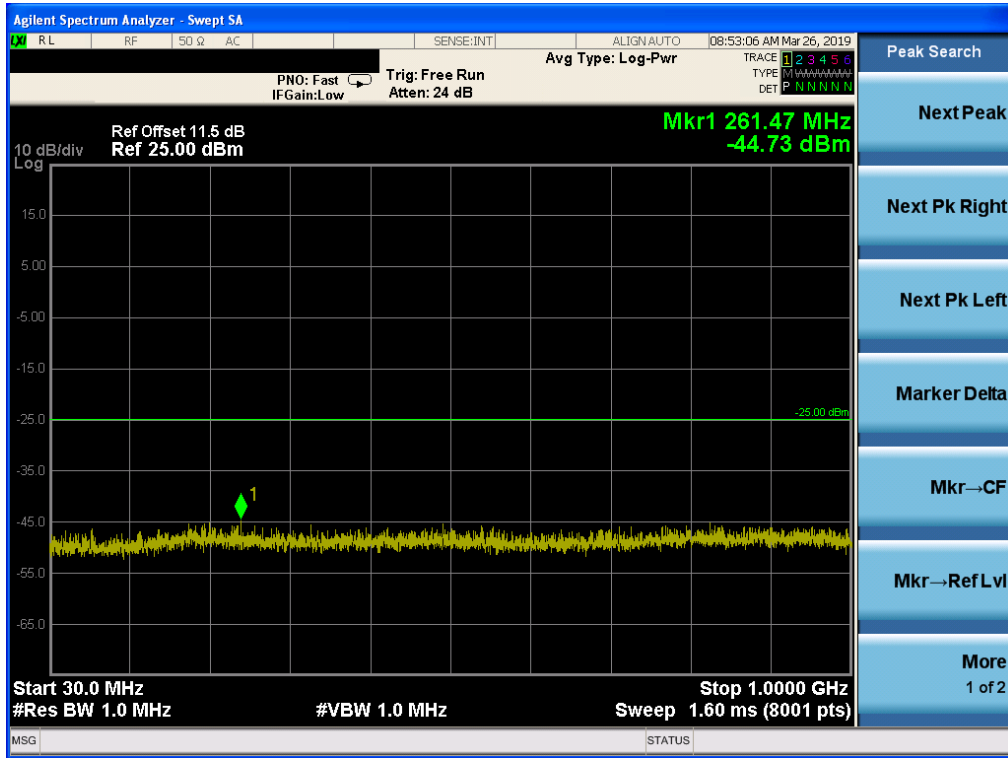

Band 7, UL Channel 21350, UL Frequency 2560.0, BW 20.0, NO. RB 100, RB POS. Low, QPSK

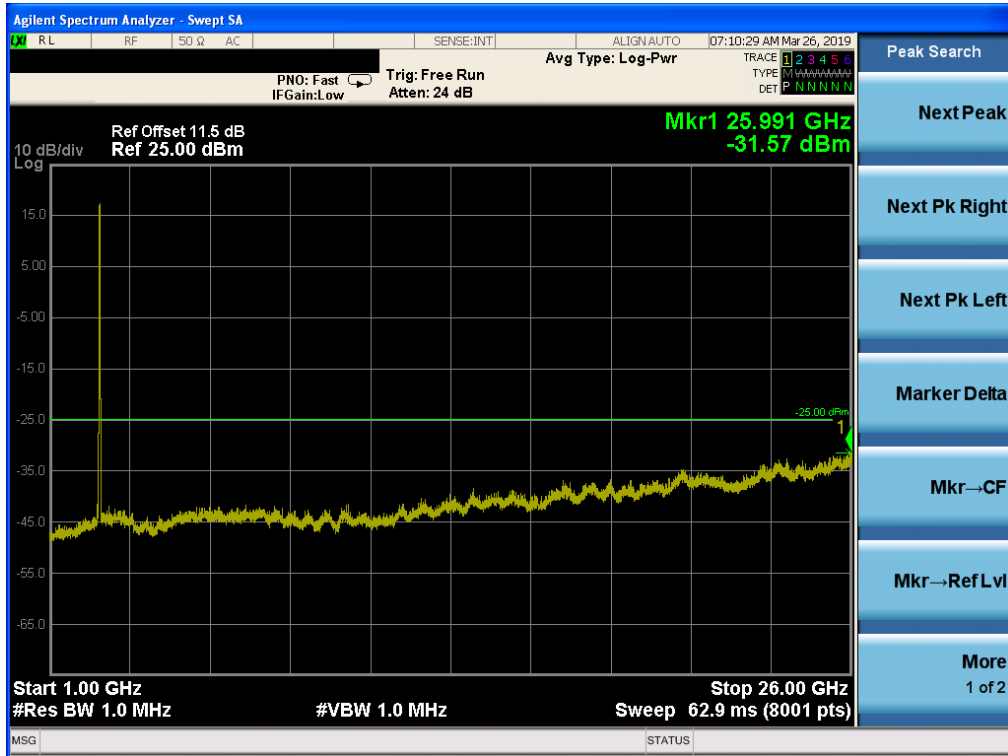

Band 7, UL Channel 21350, UL Frequency 2560.0, BW 20.0, NO. RB 100, RB POS. Low, 16-QAM

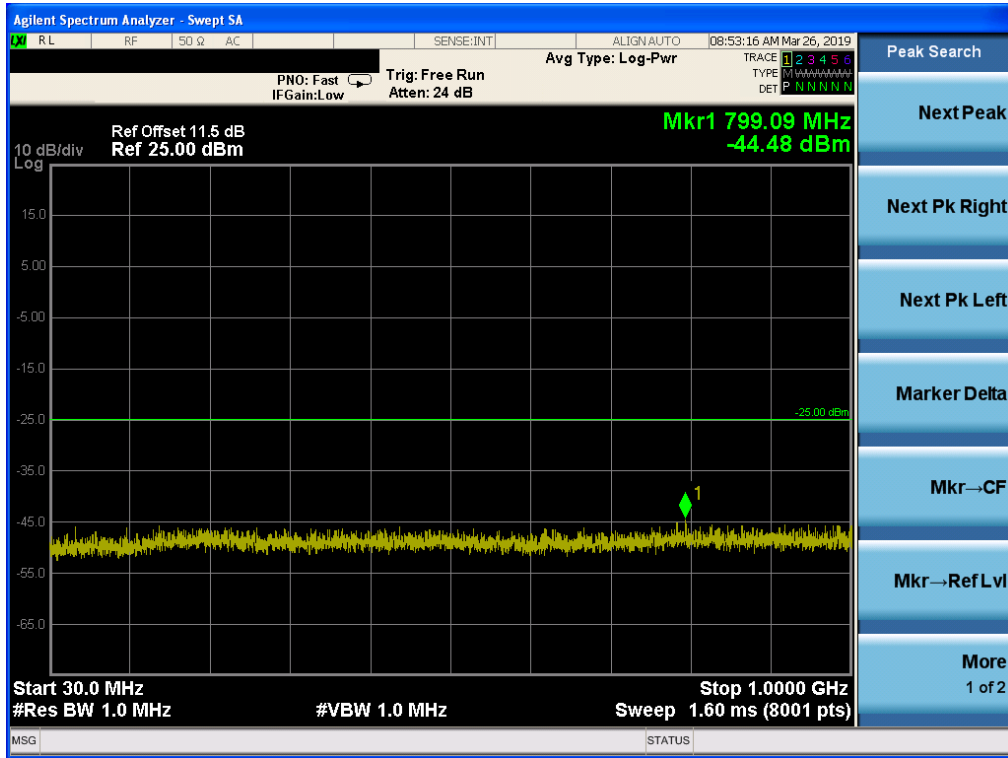

Band 7, UL Channel 21350, UL Frequency 2560.0, BW 20.0, NO. RB 100, RB POS. Low, 16-QAM

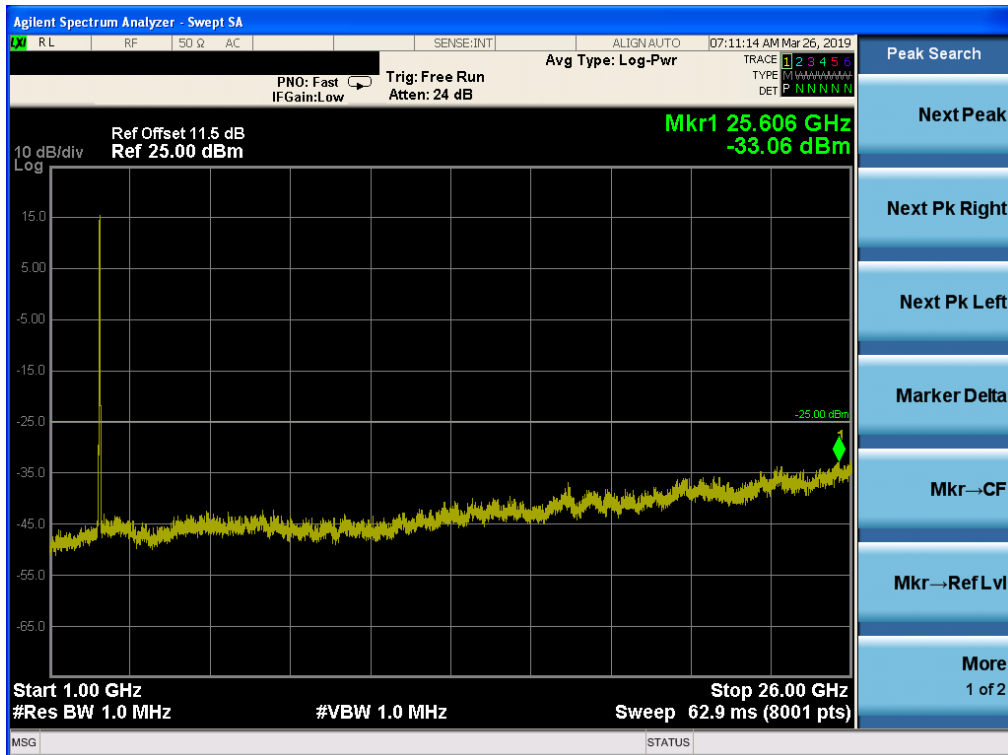



## 8. RADIATED MEASUREMENT

### 8.1. RADIATED POWER (ERP & EIRP)

#### RULE PART(S)

FCC: §2.1046, §22.913, §24.232 and §27.50

#### LIMITS:

22.913(a) - The ERP of mobile transmitters and auxiliary test transmitters must not exceed 7 Watts.

27.50 (c) (10) the following power and antenna height requirements apply to stations transmitting in the 698–746 MHz band, the portable stations (hand-held devices) are limited to 3 watts ERP.

27.50 (b)(10) Portable stations (hand-held devices) transmitting in the 746–757 MHz, 758–763 MHz, 776–793 MHz, and 805–806 MHz bands are limited to 3 watts ERP.

27.50 (d)(4) The following power and antenna height requirements apply to stations transmitting in the 1710–1755 MHz and 2110–2155 MHz bands: Fixed, mobile, and portable (hand-held) stations operating in the 1710–1755 MHz band are limited to 1 watt EIRP.

#### TEST PROCEDURE

ANSI/TIA-603-E Clause 2.2.17

KDB 971168 v02r01 RF power output using broadband peak and average power meter method.

KDB 971168 D01 Power Meas License Digital Systems v02r01, “Measurement Guidance for Certification of Licensed Digital Transmitters”

#### MODES TESTED

- LTE Band 2  
LTE Band 4
- LTE Band5  
LTE Band 7

#### RESULTS

Pass

8.2 LTE BAND 2

Radiated Power (EIRP) for Band 2										
Mode	RB/ RB SIZE	Frequency	Result						Polarizati on Of Max. ERP	Conclusio n
			SG Level (dBm )	Cable Loss (dBm)	Antenn a Gain (dB)	Max. EIRP Avera ge (dBm)	Max. EIRP			
							Average (mW)			
1.4MHz Band QPSK	6/0	1850.7	-3.91	3.76	28.24	20.57	114.12	Vertical	Pass	
		1880	-4.47	3.91	28.22	19.84	96.38	Vertical	Pass	
		1909.3	-4.61	3.93	28.20	19.66	92.37	Vertical	Pass	
1.4MHz Band 16 QAM	6/0	1850.7	-5.59	3.76	28.24	18.89	77.38	Vertical	Pass	
		1880	-5.01	3.91	28.22	19.30	85.02	Vertical	Pass	
		1909.3	-4.64	3.93	28.20	19.63	91.85	Vertical	Pass	
3.0MHz Band QPSK	15/0	1851.5	-5.53	3.77	28.23	18.93	78.20	Vertical	Pass	
		1880	-4.53	3.91	28.24	19.80	95.56	Vertical	Pass	
		1908.5	-5.04	3.94	28.25	19.27	84.54	Vertical	Pass	
3.0MHz Band 16 QAM	15/0	1851.5	-5.02	3.77	28.23	19.44	87.82	Vertical	Pass	
		1880	-6.48	3.91	28.24	17.85	61.00	Vertical	Pass	
		1908.5	-6.32	3.94	28.25	17.99	62.96	Vertical	Pass	
5.0MHz Band QPSK	25/0	1852.5	-4.95	3.77	28.31	19.59	91.02	Vertical	Pass	
		1880	-5.37	3.91	28.22	18.94	78.35	Vertical	Pass	
		1907.5	-5.29	3.94	28.20	18.97	78.89	Vertical	Pass	
5.0MHz Band 16 QAM	25/0	1852.5	-6.53	3.77	28.31	18.01	63.27	Vertical	Pass	
		1880	-5.74	3.91	28.22	18.57	71.87	Vertical	Pass	
		1907.5	-6.54	3.94	28.20	17.72	59.15	Vertical	Pass	
10.0MH z Band QPSK	50/0	1855	-5.46	3.79	28.33	19.08	80.88	Vertical	Pass	
		1880	-4.79	3.95	28.22	19.48	88.62	Vertical	Pass	
		1905	-4.96	3.97	28.19	19.26	84.26	Vertical	Pass	
10.0MH z Band 16 QAM	50/0	1855	-5.15	3.79	28.33	19.39	86.81	Vertical	Pass	
		1880	-5.59	3.95	28.22	18.68	73.84	Vertical	Pass	
		1905	-6.79	3.97	28.19	17.43	55.31	Vertical	Pass	
15.0MH z Band QPSK	75/0	1857.5	-5.38	3.79	28.34	19.17	82.59	Vertical	Pass	
		1880	-5.31	3.95	28.22	18.96	78.69	Vertical	Pass	
		1902.5	-5.67	3.97	28.18	18.54	71.47	Vertical	Pass	
15.0MH z Band 16 QAM	75/0	1857.5	-5.84	3.79	28.34	18.71	74.25	Vertical	Pass	
		1880	-6.37	3.95	28.22	17.90	61.59	Vertical	Pass	
		1902.5	-5.65	3.97	28.18	18.56	71.70	Vertical	Pass	

20.0MH z Band QPSK	100/ 0	1860	-5.03	3.81	28.35	19.51	89.31	Vertical	Pass
		1880	-5.28	3.96	28.22	18.98	79.05	Vertical	Pass
		1900	-5.03	4.00	28.16	19.13	81.76	Vertical	Pass
20.0MH z Band 16 QAM	100/ 0	1860	-6.24	3.81	28.35	18.30	67.66	Vertical	Pass
		1880	-6.20	3.96	28.22	18.06	64.03	Vertical	Pass
		1900	-5.55	4.00	28.16	18.61	72.64	Vertical	Pass

Note:

SG Level= Signal generator output

Max. EIRP Average (dBm)= Antenna Gain(dB)+ SG Level (dBm)- Cable Loss(dBm)

Radiated Power (EIRP) for Band 2									
Mode	RB/ RB SIZE	Frequency	Result						Conclusion
			SG Level (dBm )	Cable Loss (dBm)	Anten na Gain (dB)	Max. EIRP Average (dBm)	Max. EIRP Averag e (mW)	Polarizati on Of Max. ERP	
1.4MHz Band QPSK	6/0	1850.7	-3.81	3.76	28.24	20.67	116.68	Horizontal	Pass
		1880	-4.45	3.91	28.22	19.86	96.83	Horizontal	Pass
		1909.3	-4.52	3.93	28.20	19.75	94.41	Horizontal	Pass
1.4MHz Band 16 QAM	6/0	1850.7	-4.74	3.76	28.24	19.74	94.19	Horizontal	Pass
		1880	-4.65	3.91	28.22	19.66	92.47	Horizontal	Pass
		1909.3	-4.46	3.93	28.20	19.81	95.72	Horizontal	Pass
3.0MHz Band QPSK	15/0	1851.5	-4.63	3.77	28.23	19.83	96.16	Horizontal	Pass
		1880	-4.49	3.91	28.24	19.84	96.38	Horizontal	Pass
		1908.5	-4.50	3.94	28.25	19.81	95.72	Horizontal	Pass
3.0MHz Band 16 QAM	15/0	1851.5	-4.91	3.77	28.23	19.55	90.16	Horizontal	Pass
		1880	-5.92	3.91	28.24	18.41	69.34	Horizontal	Pass
		1908.5	-6.12	3.94	28.25	18.19	65.92	Horizontal	Pass
5.0MHz Band QPSK	25/0	1852.5	-4.52	3.77	28.31	20.02	100.46	Horizontal	Pass
		1880	-4.98	3.91	28.22	19.33	85.70	Horizontal	Pass
		1907.5	-4.98	3.94	28.20	19.28	84.72	Horizontal	Pass
5.0MHz Band 16 QAM	25/0	1852.5	-5.70	3.77	28.31	18.84	76.56	Horizontal	Pass
		1880	-5.44	3.91	28.22	18.87	77.09	Horizontal	Pass
		1907.5	-6.07	3.94	28.20	18.19	65.92	Horizontal	Pass
10.0MH z Band QPSK	50/0	1855	-4.73	3.79	28.33	19.81	95.72	Horizontal	Pass
		1880	-4.78	3.95	28.22	19.49	88.92	Horizontal	Pass
		1905	-4.84	3.97	28.19	19.38	86.70	Horizontal	Pass
10.0MH z Band 16 QAM	50/0	1855	-4.65	3.79	28.33	19.89	97.50	Horizontal	Pass
		1880	-5.29	3.95	28.22	18.98	79.07	Horizontal	Pass
		1905	-5.83	3.97	28.19	18.39	69.02	Horizontal	Pass
15.0MH z Band QPSK	75/0	1857.5	-4.56	3.79	28.34	19.99	99.77	Horizontal	Pass
		1880	-5.28	3.95	28.22	18.99	79.25	Horizontal	Pass
		1902.5	-5.19	3.97	28.18	19.02	79.80	Horizontal	Pass
15.0MH z Band 16 QAM	75/0	1857.5	-5.71	3.79	28.34	18.84	76.56	Horizontal	Pass
		1880	-5.40	3.95	28.22	18.87	77.09	Horizontal	Pass
		1902.5	-5.30	3.97	28.18	18.91	77.80	Horizontal	Pass
20.0MH z Band	100/ 0	1860	-4.79	3.81	28.35	19.75	94.41	Horizontal	Pass
		1880	-4.44	3.96	28.22	19.82	95.94	Horizontal	Pass

QPSK		1900	-4.25	4.00	28.16	19.91	97.95	Horizontal	Pass
20.0MHz Band 16 QAM	100/0	1860	-5.62	3.81	28.35	18.92	77.98	Horizontal	Pass
		1880	-5.30	3.96	28.22	18.96	78.70	Horizontal	Pass
		1900	-5.34	4.00	28.16	18.82	76.21	Horizontal	Pass

Note:

SG Level= Signal generator output

Max. EIRP Average (dBm)= Antenna Gain(dB)+ SG Level (dBm)- Cable Loss(dBm)

8.3 LTE BAND 4

Radiated Power (EIRP) for Band 4									
Mode	RB/RB SIZE	Frequency	Result						Conclusion
			SG Level (dBm)	Cable Loss (dBm)	Antenna Gain (dB)	Max. EIRP Average (dBm)	Max. EIRP Average (mW)	Polarization Of Max. ERP	
1.4MHz Band QPSK	6/0	1710.7	-5.10	3.12	27.58	19.36	86.36	Vertical	Pass
		1732.5	-5.02	3.27	27.61	19.32	85.60	Vertical	Pass
		1754.3	-4.87	3.29	27.63	19.47	88.54	Vertical	Pass
1.4MHz Band 16 QAM	6/0	1710.7	-6.30	3.12	27.58	18.16	65.50	Vertical	Pass
		1732.5	-5.67	3.27	27.61	18.67	73.62	Vertical	Pass
		1754.3	-6.32	3.29	27.63	18.02	63.34	Vertical	Pass
3.0MHz Band QPSK	15/0	1711.5	-5.52	3.13	27.61	18.96	78.74	Vertical	Pass
		1732.5	-5.27	3.27	27.61	19.07	80.78	Vertical	Pass
		1753.5	-4.98	3.30	27.62	19.34	85.89	Vertical	Pass
3.0MHz Band 16 QAM	15/0	1711.5	-6.27	3.13	27.61	18.21	66.19	Vertical	Pass
		1732.5	-6.20	3.27	27.61	18.14	65.16	Vertical	Pass
		1753.5	-6.40	3.30	27.62	17.92	61.90	Vertical	Pass
5.0MHz Band QPSK	25/0	1712.5	-6.24	3.13	27.63	18.26	67.02	Vertical	Pass
		1732.5	-5.30	3.27	27.61	19.04	80.18	Vertical	Pass
		1752.5	-5.75	3.30	27.60	18.55	71.63	Vertical	Pass
5.0MHz Band 16 QAM	25/0	1712.5	-6.51	3.13	27.63	17.99	62.89	Vertical	Pass
		1732.5	-6.74	3.27	27.61	17.60	57.54	Vertical	Pass
		1752.5	-6.80	3.30	27.60	17.50	56.21	Vertical	Pass
10.0MHz Band QPSK	50/0	1715	-5.57	3.15	27.64	18.92	77.96	Vertical	Pass
		1732.5	-4.46	3.31	27.61	19.84	96.36	Vertical	Pass
		1750	-4.73	3.33	27.59	19.53	89.79	Vertical	Pass
10.0MHz Band 16 QAM	50/0	1715	-7.00	3.15	27.64	17.49	56.05	Vertical	Pass
		1732.5	-6.70	3.31	27.61	17.60	57.56	Vertical	Pass
		1750	-5.53	3.33	27.59	18.73	74.71	Vertical	Pass
15.0MHz Band QPSK	75/0	1717.5	-5.44	3.15	27.65	19.06	80.61	Vertical	Pass
		1732.5	-5.22	3.31	27.61	19.08	80.84	Vertical	Pass
		1747.5	-5.06	3.33	27.57	19.18	82.81	Vertical	Pass
15.0MHz Band 16 QAM	75/0	1717.5	-6.12	3.15	27.65	18.38	68.94	Vertical	Pass
		1732.5	-6.20	3.31	27.61	18.10	64.50	Vertical	Pass
		1747.5	-5.82	3.33	27.57	18.42	69.47	Vertical	Pass

20.0MH z Band QPSK	100/0	1720	-5.61	3.17	27.66	18.88	77.32	Vertical	Pass
		1732.5	-5.25	3.32	27.61	19.04	80.14	Vertical	Pass
		1745	-5.29	3.36	27.56	18.91	77.74	Vertical	Pass
20.0MH z Band 16 QAM	100/0	1720	-6.48	3.17	27.66	18.01	63.19	Vertical	Pass
		1732.5	-5.57	3.32	27.61	18.72	74.48	Vertical	Pass
		1745	-6.33	3.36	27.56	17.87	61.26	Vertical	Pass

Note:

SG Level= Signal generator output

Max. EIRP Average (dBm)= Antenna Gain(dB)+ SG Level (dBm)- Cable Loss(dBm)

Radiated Power (EIRP) for Band 4									
Mode	RB/RB SIZE	Frequency	Result						Conclusion
			SG Level (dBm)	Cable Loss (dBm)	Antenna Gain (dB)	Max. EIRP Average (dBm)	Max. EIRP Average (mW)	Polarization Of Max. ERP	
1.4MHz Band QPSK	6/0	1710.7	-4.65	3.12	27.58	19.81	95.72	Horizontal	Pass
		1732.5	-4.70	3.27	27.61	19.64	92.04	Horizontal	Pass
		1754.3	-4.39	3.29	27.63	19.95	98.86	Horizontal	Pass
1.4MHz Band 16 QAM	6/0	1710.7	-5.50	3.12	27.58	18.96	78.70	Horizontal	Pass
		1732.5	-5.38	3.27	27.61	18.96	78.70	Horizontal	Pass
		1754.3	-5.43	3.29	27.63	18.91	77.80	Horizontal	Pass
3.0MHz Band QPSK	15/0	1711.5	-4.67	3.13	27.61	19.81	95.72	Horizontal	Pass
		1732.5	-4.50	3.27	27.61	19.84	96.38	Horizontal	Pass
		1753.5	-4.49	3.30	27.62	19.83	96.16	Horizontal	Pass
3.0MHz Band 16 QAM	15/0	1711.5	-6.25	3.13	27.61	18.23	66.53	Horizontal	Pass
		1732.5	-6.13	3.27	27.61	18.21	66.22	Horizontal	Pass
		1753.5	-6.10	3.30	27.62	18.22	66.37	Horizontal	Pass
5.0MHz Band QPSK	25/0	1712.5	-5.33	3.13	27.63	19.17	82.60	Horizontal	Pass
		1732.5	-5.18	3.27	27.61	19.16	82.41	Horizontal	Pass
		1752.5	-5.21	3.30	27.60	19.09	81.10	Horizontal	Pass
5.0MHz Band 16 QAM	25/0	1712.5	-6.43	3.13	27.63	18.07	64.12	Horizontal	Pass
		1732.5	-6.25	3.27	27.61	18.09	64.42	Horizontal	Pass
		1752.5	-6.25	3.30	27.60	18.05	63.83	Horizontal	Pass
10.0MHz Band QPSK	50/0	1715	-5.04	3.15	27.64	19.45	88.10	Horizontal	Pass
		1732.5	-4.39	3.31	27.61	19.91	97.95	Horizontal	Pass
		1750	-4.43	3.33	27.59	19.83	96.16	Horizontal	Pass
10.0MHz Band 16 QAM	50/0	1715	-6.02	3.15	27.64	18.47	70.31	Horizontal	Pass
		1732.5	-5.71	3.31	27.61	18.59	72.28	Horizontal	Pass
		1750	-5.50	3.33	27.59	18.76	75.16	Horizontal	Pass
15.0MHz Band QPSK	75/0	1717.5	-4.76	3.15	27.65	19.74	94.19	Horizontal	Pass
		1732.5	-4.74	3.31	27.61	19.56	90.36	Horizontal	Pass
		1747.5	-4.64	3.33	27.57	19.60	91.20	Horizontal	Pass
15.0MHz Band 16 QAM	75/0	1717.5	-6.01	3.15	27.65	18.49	70.63	Horizontal	Pass
		1732.5	-5.77	3.31	27.61	18.53	71.29	Horizontal	Pass
		1747.5	-5.67	3.33	27.57	18.57	71.94	Horizontal	Pass
20.0MHz Band	100/0	1720	-5.10	3.17	27.66	19.39	86.90	Horizontal	Pass
		1732.5	-4.88	3.32	27.61	19.41	87.30	Horizontal	Pass



QPSK		1745	-4.62	3.36	27.56	19.58	90.78	Horizontal	Pass
20.0MH	100/0	1720	-5.85	3.17	27.66	18.64	73.11	Horizontal	Pass
z Band		1732.5	-5.55	3.32	27.61	18.74	74.82	Horizontal	Pass
16 QAM		1745	-5.68	3.36	27.56	18.52	71.12	Horizontal	Pass

**Note:**

SG Level= Signal generator output

Max. EIRP Average (dBm)= Antenna Gain(dB)+ SG Level (dBm)- Cable Loss(dBm)

8.4 LTE BAND 5

Radiated Power (ERP) for Band 5										
Mode	RB/ RB SIZE	Frequ ncy	Result							Conclu sion
			SG Level (dBm)	Cable Loss (dBm)	Anten na Gain (dB)	Corre ction (dB)	Max. EIRP Averag e (dBm)	Max. EIRP Averag e (mW)	Polarizati on Of Max. ERP	
1.4MHz Band QPSK	6/0	824.7	2.43	2.01	19.68	2.15	17.95	62.32	Vertical	Pass
		836.5	1.98	2.01	19.77	2.15	17.59	57.35	Vertical	Pass
		848.3	2.47	2.02	19.82	2.15	18.12	64.85	Vertical	Pass
1.4MHz Band 16 QAM	6/0	824.7	2.35	2.01	19.68	2.15	17.87	61.29	Vertical	Pass
		836.5	2.46	2.01	19.77	2.15	18.07	64.10	Vertical	Pass
		848.3	1.95	2.02	19.82	2.15	17.60	57.48	Vertical	Pass
3.0MHz Band QPSK	15/0	825.5	2.37	2.01	19.70	2.15	17.91	61.74	Vertical	Pass
		836.5	1.93	2.01	19.77	2.15	17.54	56.81	Vertical	Pass
		847.5	2.54	2.02	19.81	2.15	18.18	65.70	Vertical	Pass
3.0MHz Band 16 QAM	15/0	825.5	1.27	2.01	19.70	2.15	16.81	47.99	Vertical	Pass
		836.5	1.43	2.01	19.77	2.15	17.04	50.54	Vertical	Pass
		847.5	1.01	2.02	19.81	2.15	16.65	46.19	Vertical	Pass
5.0MHz Band QPSK	25/0	826.5	1.73	2.01	19.71	2.15	17.28	53.50	Vertical	Pass
		836.5	2.30	2.01	19.77	2.15	17.91	61.86	Vertical	Pass
		846.5	2.12	2.02	19.79	2.15	17.74	59.49	Vertical	Pass
5.0MHz Band 16 QAM	25/0	826.5	1.31	2.01	19.71	2.15	16.86	48.51	Vertical	Pass
		836.5	1.05	2.01	19.77	2.15	16.66	46.34	Vertical	Pass
		846.5	1.24	2.02	19.79	2.15	16.86	48.57	Vertical	Pass
10.0MH z Band QPSK	50/0	829	3.29	2.01	19.73	2.15	18.86	76.91	Vertical	Pass
		836.5	3.09	2.01	19.77	2.15	18.70	74.06	Vertical	Pass
		844	3.14	2.02	19.78	2.15	18.75	74.93	Vertical	Pass
10.0MH z Band 16 QAM	50/0	829	2.21	2.01	19.73	2.15	17.78	59.97	Vertical	Pass
		836.5	2.38	2.01	19.77	2.15	17.99	62.96	Vertical	Pass
		844	2.01	2.02	19.78	2.15	17.62	57.82	Vertical	Pass

Note:

SG Level= Signal generator output

Max. EIRP Average (dBm)= Antenna Gain(dB)+ SG Level (dBm)- Cable Loss(dBm)

Radiated Power (ERP) for Band 5										
Mode	RB/ RB SIZE	Freque ncy	Result							Conclu sion
			SG Level (dBm)	Cable Loss (dBm)	Anten na Gain (dB)	Corre ction (dB)	Max. EIRP Averag e (dBm)	Max. EIRP Averag e (mW)	Polarizati on Of Max. ERP	
1.4MHz Band QPSK	6/0	824.7	2.74	2.01	19.68	2.15	18.26	66.99	Horizontal	Pass
		836.5	2.77	2.01	19.77	2.15	18.38	68.87	Horizontal	Pass
		848.3	2.63	2.02	19.82	2.15	18.28	67.30	Horizontal	Pass
1.4MHz Band 16 QAM	6/0	824.7	2.61	2.01	19.68	2.15	18.13	65.01	Horizontal	Pass
		836.5	2.55	2.01	19.77	2.15	18.16	65.46	Horizontal	Pass
		848.3	2.61	2.02	19.82	2.15	18.26	66.99	Horizontal	Pass
3.0MHz Band QPSK	15/0	825.5	2.73	2.01	19.70	2.15	18.27	67.14	Horizontal	Pass
		836.5	2.68	2.01	19.77	2.15	18.29	67.45	Horizontal	Pass
		847.5	2.58	2.02	19.81	2.15	18.22	66.37	Horizontal	Pass
3.0MHz Band 16 QAM	15/0	825.5	1.83	2.01	19.70	2.15	17.37	54.58	Horizontal	Pass
		836.5	1.72	2.01	19.77	2.15	17.33	54.08	Horizontal	Pass
		847.5	1.54	2.02	19.81	2.15	17.18	52.24	Horizontal	Pass
5.0MHz Band QPSK	25/0	826.5	2.49	2.01	19.71	2.15	18.04	63.68	Horizontal	Pass
		836.5	2.54	2.01	19.77	2.15	18.15	65.31	Horizontal	Pass
		846.5	2.49	2.02	19.79	2.15	18.11	64.71	Horizontal	Pass
5.0MHz Band 16 QAM	25/0	826.5	1.73	2.01	19.71	2.15	17.28	53.46	Horizontal	Pass
		836.5	1.74	2.01	19.77	2.15	17.35	54.33	Horizontal	Pass
		846.5	1.65	2.02	19.79	2.15	17.27	53.33	Horizontal	Pass
10.0MH z Band QPSK	50/0	829	3.60	2.01	19.73	2.15	19.17	82.60	Horizontal	Pass
		836.5	3.55	2.01	19.77	2.15	19.16	82.41	Horizontal	Pass
		844	3.56	2.02	19.78	2.15	19.17	82.60	Horizontal	Pass
10.0MH z Band 16 QAM	50/0	829	2.85	2.01	19.73	2.15	18.42	69.50	Horizontal	Pass
		836.5	2.75	2.01	19.77	2.15	18.36	68.55	Horizontal	Pass
		844	2.80	2.02	19.78	2.15	18.41	69.34	Horizontal	Pass

Note:

SG Level= Signal generator output

Max. EIRP Average (dBm)= Antenna Gain(dB)+ SG Level (dBm)- Cable Loss(dBm)

8.5 LTE BAND 7

Radiated Power (EIRP) for Band 7									
Mode	RB/ RB SIZE	Frequency	Result						Conclusion
			SG Level (dBm )	Cabl e Loss (dBm )	Antenn a Gain (dB)	Max. EIRP Averag e (dBm)	Max. EIRP Averag e (mW)	Polarizati on Of Max. ERP	
5.0MHz Band QPSK	25/0	2502.5	-4.10	4.54	27.75	19.11	81.49	Vertical	Pass
		2535	-3.77	4.69	27.72	19.26	84.41	Vertical	Pass
		2567.5	-3.75	4.71	27.71	19.25	84.13	Vertical	Pass
5.0MHz Band 16 QAM	25/0	2502.5	-4.98	4.54	27.75	18.23	66.47	Vertical	Pass
		2535	-5.30	4.69	27.72	17.73	59.24	Vertical	Pass
		2567.5	-4.79	4.71	27.71	18.21	66.24	Vertical	Pass
10.0MH z Band QPSK	50/0	2505	-3.93	4.55	27.76	19.28	84.71	Vertical	Pass
		2535	-3.83	4.69	27.72	19.20	83.14	Vertical	Pass
		2565	-3.92	4.72	27.70	19.06	80.52	Vertical	Pass
10.0MH z Band 16 QAM	50/0	2505	-5.16	4.55	27.76	18.05	63.78	Vertical	Pass
		2535	-4.70	4.69	27.72	18.33	68.12	Vertical	Pass
		2565	-4.92	4.72	27.70	18.06	63.97	Vertical	Pass
15.0MH z Band QPSK	75/0	2507.5	-4.28	4.55	27.77	18.94	78.27	Vertical	Pass
		2535	-3.74	4.69	27.72	19.29	84.92	Vertical	Pass
		2562.5	-4.29	4.72	27.69	18.68	73.78	Vertical	Pass
15.0MH z Band 16 QAM	75/0	2507.5	-4.85	4.55	27.77	18.37	68.67	Vertical	Pass
		2535	-5.32	4.69	27.72	17.71	59.07	Vertical	Pass
		2562.5	-4.52	4.72	27.69	18.45	70.00	Vertical	Pass
20.0MH z Band QPSK	100/ 0	2510	-4.23	4.57	27.78	18.98	79.15	Vertical	Pass
		2535	-3.90	4.73	27.72	19.09	81.18	Vertical	Pass
		2560	-3.69	4.75	27.68	19.24	83.94	Vertical	Pass
20.0MH z Band 16 QAM	100/ 0	2510	-5.55	4.57	27.78	17.66	58.37	Vertical	Pass
		2535	-4.99	4.73	27.72	18.00	63.05	Vertical	Pass
		2560	-4.88	4.75	27.68	18.05	63.80	Vertical	Pass

Note:

SG Level= Signal generator output

Max. EIRP Average (dBm)= Antenna Gain(dB)+ SG Level (dBm)- Cable Loss(dBm)

Radiated Power (EIRP) for Band 7									
Mode	RB/ RB SIZE	Frequency	Result						Conclusion
			SG Level (dBm )	Cabl e Loss (dBm )	Antenn a Gain (dB)	Max. EIRP Averag e (dBm)	Max. EIRP Averag e (mW)	Polarizati on Of Max. ERP	
5.0MHz Band QPSK	25/0	2502.5	-3.56	4.54	27.75	19.65	92.257	Horizontal	Pass
		2535	-3.44	4.69	27.72	19.59	90.991	Horizontal	Pass
		2567.5	-3.53	4.71	27.71	19.47	88.512	Horizontal	Pass
5.0MHz Band 16 QAM	25/0	2502.5	-4.70	4.54	27.75	18.51	70.958	Horizontal	Pass
		2535	-4.51	4.69	27.72	18.52	71.121	Horizontal	Pass
		2567.5	-4.47	4.71	27.71	18.53	71.285	Horizontal	Pass
10.0MH z Band QPSK	50/0	2505	-3.55	4.55	27.76	19.66	92.470	Horizontal	Pass
		2535	-3.24	4.69	27.72	19.79	95.280	Horizontal	Pass
		2565	-3.37	4.72	27.7	19.61	91.411	Horizontal	Pass
10.0MH z Band 16 QAM	50/0	2505	-4.48	4.55	27.76	18.73	74.645	Horizontal	Pass
		2535	-4.26	4.69	27.72	18.77	75.336	Horizontal	Pass
		2565	-4.35	4.72	27.7	18.63	72.946	Horizontal	Pass
15.0MH z Band QPSK	75/0	2507.5	-3.38	4.55	27.77	19.84	96.383	Horizontal	Pass
		2535	-3.27	4.69	27.72	19.76	94.624	Horizontal	Pass
		2562.5	-3.45	4.72	27.69	19.52	89.536	Horizontal	Pass
15.0MH z Band 16 QAM	75/0	2507.5	-4.59	4.55	27.77	18.63	72.946	Horizontal	Pass
		2535	-4.46	4.69	27.72	18.57	71.945	Horizontal	Pass
		2562.5	-4.49	4.72	27.69	18.48	70.469	Horizontal	Pass
20.0MH z Band QPSK	100/ 0	2510	-3.82	4.57	27.78	19.39	86.896	Horizontal	Pass
		2535	-3.71	4.73	27.72	19.28	84.723	Horizontal	Pass
		2560	-3.49	4.75	27.68	19.44	87.902	Horizontal	Pass
20.0MH z Band 16 QAM	100/ 0	2510	-4.79	4.57	27.78	18.42	69.502	Horizontal	Pass
		2535	-4.53	4.73	27.72	18.46	70.146	Horizontal	Pass
		2560	-4.65	4.75	27.68	18.28	67.298	Horizontal	Pass

Note:

SG Level= Signal generator output

Max. EIRP Average (dBm)= Antenna Gain(dB)+ SG Level (dBm)- Cable Loss(dBm)

## 9. SPURIOUS RADIATION EMISSION

### RULE PART(S)

FCC: §2.1053, §22.917, §24.238 and §27.53

### LIMIT

§22.917 (e) and §24.238 (a): Out of band emissions. The power of any emission outside of the authorized operating frequency ranges must be attenuated below the transmitting power (P) by a factor of at least  $43 + 10 \log (P)$  dB.

§27.53 (g) For operations in the 698–746 MHz band, the power of any emission outside a licensee's frequency band(s) of operation shall be attenuated below the transmitter power (P) within the licensed band(s) of operation, measured in watts, by at least  $43 + 10 \log (P)$  dB.

§27.53 (h) For operations in the 1710–1755 MHz and 2110–2155 MHz bands, the power of any emission outside a licensee's frequency block shall be attenuated below the transmitter power (P) by at least  $43 + 10 \log_{10}(P)$  dB.

### TEST PROCEDURE

For Cellular equipment - Compliance with these rules is based on the use of measurement instrumentation employing a resolution bandwidth of 100 kHz or greater. In the 1 MHz bands immediately outside and adjacent to the frequency block a resolution bandwidth of at least one percent of the emission bandwidth of the fundamental emission of the transmitter may be employed. A narrower resolution bandwidth is permitted in all cases to improve measurement accuracy provided the measured power is integrated over the full required measurement bandwidth (i.e. 100 kHz or 1 percent of emission bandwidth, as specified). The emission bandwidth is defined as the width of the signal between two points, one below the carrier center frequency and one above the carrier center frequency, outside of which all emissions are attenuated at least 26 dB below the transmitter power.

For PCS equipment - Compliance with these rules is based on the use of measurement instrumentation employing a resolution bandwidth of 1 MHz or greater. However, in the 1 MHz bands immediately outside and adjacent to the frequency block a resolution bandwidth of at least one percent of the emission bandwidth of the fundamental emission of the transmitter may be employed. A narrower resolution bandwidth is permitted in all cases to improve measurement accuracy provided the measured power is integrated over the full required measurement bandwidth ( i.e. 1 MHz or 1 percent of emission bandwidth, as specified). The emission bandwidth is defined as the width of the signal between two points, one below the carrier center frequency and one above the carrier center frequency, outside of which all emissions are attenuated at least 26 dB below the transmitter power.

The unwanted emission power shall be measured with a resolution bandwidth of at least 1% of the occupied bandwidth in the 1 MHz band immediately outside and adjacent to the channel edge of the equipment. Beyond the 1 MHz band immediately outside the channel edge of the equipment, a resolution bandwidth of 1 MHz shall be employed. A narrower resolution bandwidth is allowed to be used provided that the measured power is integrated over the full required measurement bandwidth of 1 MHz or 1% of the occupied bandwidth as applicable.

The power of any unwanted emissions measured from the channel edge of the equipment shall be attenuated below the transmitter power, P (dBW), as follows:

- a. for base station and subscriber equipment, other than mobile subscriber equipment, the attenuation shall not be less than  $43 + 10 \text{ Log}_{10}(p)$ , dB; and
- b. for mobile subscriber equipment, the attenuation shall not be less than  $43 + 10 \text{ Log}_{10}(p)$ , dB at the channel edges and  $55 + 10 \text{ Log}_{10}(p)$  at 5.5 MHz away and beyond the channel edges where p in (a) and (b) is the transmitter power measured in watts.

#### MODES TESTED

- LTE Band 2  
LTE Band 4
- LTE Band 5  
LTE Band 7

#### RESULTS

PASS

9.1 LTE BAND 2

**QPSK EIRP POWER FOR LTE BAND 2 (1.4MHZ BANDWIDTH)**

Test Results for Low Channel 1850.7MHz							
Frequency(MHz)	SG Level(dBm)	Cable Loss(dB)	Antenna Gain(dB)	Absolute Level(dBm)	Limit (dBm)	Margin(dBm)	Polarity
3701.4	-51.82	4.04	33.51	-22.35	-13	-9.35	Horizontal
3701.4	-46.88	4.04	33.51	-17.41	-13	-4.41	Vertical
5552.1	-49.39	5.24	35.84	-18.79	-13	-5.79	Vertical
5552.1	-57.12	5.24	35.84	-26.52	-13	-13.52	Horizontal
Test Results for Mid Channel 1880MHz							
3760	-52.90	4.04	33.56	-23.38	-13	-10.38	Horizontal
3760	-53.99	4.04	33.56	-24.47	-13	-11.47	Vertical
5640	-54.47	5.24	35.91	-23.80	-13	-10.80	Vertical
5640	-56.15	5.24	35.91	-25.48	-13	-12.48	Horizontal
Test Results for High Channel 1909.3MHz							
3818.6	-53.24	4.04	34.00	-23.28	-13	-10.28	Horizontal
3818.6	-55.32	4.04	34.00	-25.36	-13	-12.36	Vertical
5727.9	-56.94	5.24	36.04	-26.14	-13	-13.14	Vertical
5727.9	-56.35	5.24	36.04	-25.55	-13	-12.55	Horizontal

**QPSK EIRP POWER FOR LTE BAND 2 (20.0MHZ BANDWIDTH)**

Test Results for Low Channel 1860MHz							
Frequency(MHz)	SG Level(dBm)	Cable Loss(dB)	Antenna Gain(dB)	Absolute Level(dBm)	Limit (dBm)	Margin(dBm)	Polarity
3720	-47.10	4.07	33.54	-17.63	-13	-4.63	Horizontal
3720	-51.51	4.07	33.54	-22.04	-13	-9.04	Vertical
5580	-48.57	5.28	35.86	-17.99	-13	-4.99	Vertical
5580	-49.37	5.28	35.86	-18.79	-13	-5.79	Horizontal
Test Results for Mid Channel 1880MHz							
3760	-46.79	4.04	33.56	-17.27	-13	-4.27	Horizontal
3760	-53.52	4.04	33.56	-24.00	-13	-11.00	Vertical
5640	-47.58	5.24	35.91	-16.91	-13	-3.91	Vertical
5640	-48.44	5.24	35.91	-17.77	-13	-4.77	Horizontal
Test Results for High Channel 1900MHz							
3800	-55.25	4.04	34.00	-25.29	-13	-12.29	Horizontal
3800	-56.22	4.04	34.00	-26.26	-13	-13.26	Vertical
5700	-57.50	5.24	36.04	-26.70	-13	-13.70	Vertical
5700	-56.10	5.24	36.04	-25.30	-13	-12.30	Horizontal

Note: P<sub>Mea</sub>(dBm)= Power(dBm)+ ARpl (dBm)  
 . Over Limit= : P<sub>Mea</sub>(dBm)-Limit(dBm)  
 . We test both H direction and V direction, recorded worst case direction.



9.2 LTE BAND 4

**QPSK EIRP POWER FOR LTE BAND 4 (1.4MHZ BANDWIDTH)**

Test Results for Low Channel 1710.7MHz							
Frequency(MHz)	SG Level(dBm)	Cable Loss(dB)	Antenna Gain(dB)	Absolute Level(dBm)	Limit (dBm)	Margin(dBm)	Polarity
3421.4	-49.41	4.02	29.80	-23.63	-13	-10.63	Horizontal
3421.4	-46.79	4.02	29.80	-21.01	-13	-8.01	Vertical
5132.1	-51.07	5.24	35.84	-20.47	-13	-7.47	Vertical
5132.1	-52.12	5.24	35.84	-21.52	-13	-8.52	Horizontal
Test Results for Mid Channel 1732.5MHz							
3465	-50.88	4.03	30.00	-24.91	-13	-11.91	Horizontal
3465	-44.66	4.03	30.00	-18.69	-13	-5.69	Vertical
5197.5	-48.14	5.25	35.86	-17.53	-13	-4.53	Vertical
5197.5	-55.99	5.25	35.86	-25.38	-13	-12.38	Horizontal
Test Results for High Channel 1754.3MHz							
3508.6	-51.11	4.05	30.01	-25.15	-13	-12.15	Horizontal
3508.6	-47.02	4.05	30.01	-21.06	-13	-8.06	Vertical
5262.9	-57.21	5.26	35.86	-26.61	-13	-13.61	Vertical
5262.9	-54.67	5.26	35.86	-24.07	-13	-11.07	Horizontal

**QPSK EIRP POWER FOR LTE BAND 4 (20.0MHZ BANDWIDTH)**

Test Results for Low Channel 1720MHz							
Frequency(MHz)	SG Level(dBm)	Cable Loss(dB)	Antenna Gain(dB)	Absolute Level(dBm)	Limit (dBm)	Margin(dBm)	Polarity
3440	-46.61	4.02	29.80	-20.83	-13	-7.83	Horizontal
3440	-47.27	4.02	29.80	-21.49	-13	-8.49	Vertical
5160	-49.72	5.24	35.84	-19.12	-13	-6.12	Vertical
5160	-52.14	5.24	35.84	-21.54	-13	-8.54	Horizontal
Test Results for Mid Channel 1732.5MHz							
3465	-50.20	4.03	30.00	-24.23	-13	-11.23	Horizontal
3465	-44.18	4.03	30.00	-18.21	-13	-5.21	Vertical
5197.5	-49.81	5.25	35.86	-19.20	-13	-6.20	Vertical
5197.5	-48.94	5.25	35.86	-18.33	-13	-5.33	Horizontal
Test Results for High Channel 1745MHz							
3490	-43.49	2.91	27.68	-18.72	-13	-5.72	Horizontal
3490	-44.65	2.91	27.68	-19.88	-13	-6.88	Vertical
5235	-48.45	5.26	35.86	-17.85	-13	-4.85	Vertical
5235	-47.71	5.26	35.86	-17.11	-13	-4.11	Horizontal

Note: P<sub>Mea</sub>(dBm)= Power(dBm)+ ARpl (dBm)

Over Limit= : P<sub>Mea</sub>(dBm)-Limit(dBm)

We test both H direction and V direction, recorded worst case direction.

9.3 LTE BAND 5

**QPSK EIRP POWER FOR LTE BAND 5 (1.4MHZ BANDWIDTH)**

Test Results for Low Channel 824.7MHz							
Frequency(MHz)	SG Level(dBm)	Cable Loss(dB)	Antenna Gain(dB)	Absolute Level(dBm)	Limit (dBm)	Margin(dBm)	Polarity
1649.4	-45.54	2.78	27.50	-20.82	-13	-7.82	Horizontal
1649.4	-47.12	2.78	27.50	-22.40	-13	-9.40	Vertical
2474.1	-43.26	2.90	27.80	-18.36	-13	-5.36	Vertical
2474.1	-44.47	2.90	27.80	-19.57	-13	-6.57	Horizontal
Test Results For Mid Channel 836.5MHz							
1673	-46.52	2.80	27.48	-21.84	-13	-8.84	Horizontal
1673	-44.48	2.80	27.48	-19.80	-13	-6.80	Vertical
2509.5	-46.92	2.91	27.70	-22.13	-13	-9.13	Vertical
2509.5	-42.85	2.91	27.70	-18.06	-13	-5.06	Horizontal
Test Results for High Channel 848.3MHz							
1696.6	-44.41	2.82	27.43	-19.80	-13	-6.80	Horizontal
1696.6	-44.48	2.82	27.43	-19.87	-13	-6.87	Vertical
2544.9	-49.98	2.92	27.74	-25.16	-13	-12.16	Vertical
2544.9	-46.53	2.92	27.74	-21.71	-13	-8.71	Horizontal

**QPSK EIRP POWER FOR LTE BAND 5 (10MHZ BANDWIDTH)**

Test Results for Low Channel 829MHz							
Frequency(MHz)	SG Level(dBm)	Cable Loss(dB)	Antenna Gain(dB)	Absolute Level(dBm)	Limit (dBm)	Margin(dBm)	Polarity
1658	-44.47	2.78	27.50	-19.75	-13	-6.75	Horizontal
1658	-46.59	2.78	27.50	-21.87	-13	-8.87	Vertical
2487	-46.86	2.90	27.80	-21.96	-13	-8.96	Vertical
2487	-49.97	2.90	27.80	-25.07	-13	-12.07	Horizontal
Test Results For Mid Channel 836.5MHz							
1673	-43.65	2.80	27.48	-18.97	-13	-5.97	Horizontal
1673	-46.65	2.80	27.48	-21.97	-13	-8.97	Vertical
2509.5	-47.74	2.91	27.70	-22.95	-13	-9.95	Vertical
2509.5	-46.58	2.91	27.70	-21.79	-13	-8.79	Horizontal
Test Results for High Channel 844MHz							
1688	-45.58	2.82	27.43	-20.97	-13	-7.97	Horizontal
1688	-46.59	2.82	27.43	-21.98	-13	-8.98	Vertical
2532	-45.58	2.92	27.74	-20.76	-13	-7.76	Vertical
2532	-46.63	2.92	27.74	-21.81	-13	-8.81	Horizontal

Note: P<sub>Mea</sub>(dBm)= Power(dBm)+ AR<sub>pl</sub> (dBm)

. Over Limit= : P<sub>Mea</sub>(dBm)-Limit(dBm)

. We test both H direction and V direction, recorded worst case direction.

9.4 LTE BAND 7

**QPSK EIRP POWER FOR LTE BAND 7 (5.0MHZ BANDWIDTH)**

Test Results for Low Channel 2502.5MHz							
Frequency(MHz)	SG Level(dBm)	Cable Loss(dB)	Antenna Gain(dB)	Absolute Level(dBm)	Limit (dBm)	Margin(dBm)	Polarity
5005	-62.84	5.36	35.81	-32.39	-25	-7.39	Horizontal
5005	-64.94	5.36	35.81	-34.49	-25	-9.49	Vertical
7507.5	-66.56	5.87	36.85	-35.58	-25	-10.58	Vertical
7507.5	-62.95	5.87	36.85	-31.97	-25	-6.97	Horizontal
Test Results for Mid Channel 2535MHz							
5070	-64.43	5.35	35.82	-33.96	-25	-8.96	Horizontal
5070	-66.80	5.35	35.82	-36.33	-25	-11.33	Vertical
7605	-63.70	5.93	36.85	-32.78	-25	-7.78	Vertical
7605	-62.71	5.93	36.85	-31.79	-25	-6.79	Horizontal
Test Results for High Channel 2567.5MHz							
5135	-62.09	5.43	35.83	-31.69	-25	-6.69	Horizontal
5135	-61.92	5.43	35.83	-31.52	-25	-6.52	Vertical
7702.5	-64.52	6.01	36.87	-33.66	-25	-8.66	Vertical
7702.5	-63.39	6.01	36.87	-32.53	-25	-7.53	Horizontal

**QPSK EIRP POWER FOR LTE BAND 7 (20.0MHZ BANDWIDTH)**

Test Results for Low Channel 2510MHz							
Frequency(MHz)	SG Level(dBm)	Cable Loss(dB)	Antenna Gain(dB)	Absolute Level(dBm)	Limit (dBm)	Margin(dBm)	Polarity
5020	-61.77	5.36	35.82	-31.31	-25	-6.31	Horizontal
5020	-63.89	5.36	35.82	-33.43	-25	-8.43	Vertical
7530	-65.18	5.87	36.86	-34.19	-25	-9.19	Vertical
7530	-62.86	5.87	36.86	-31.87	-25	-6.87	Horizontal
Test Results for Mid Channel 2535MHz							
5070	-65.16	5.35	35.82	-34.69	-25	-9.69	Horizontal
5070	-63.83	5.35	35.82	-33.36	-25	-8.36	Vertical
7605	-61.97	5.93	36.85	-31.05	-25	-6.05	Vertical
7605	-62.78	5.93	36.85	-31.86	-25	-6.86	Horizontal
Test Results for High Channel 2560MHz							
5120	-63.51	5.43	35.83	-33.11	-25	-8.11	Horizontal
5120	-63.81	5.43	35.83	-33.41	-25	-8.41	Vertical
7680	-63.89	6.01	36.88	-33.02	-25	-8.02	Vertical
7680	-65.40	6.01	36.88	-34.53	-25	-9.53	Horizontal

Note: P<sub>Mea</sub>(dBm)= Power(dBm)+ ARpl (dBm)  
 Over Limit= : P<sub>Mea</sub>(dBm)-Limit(dBm)  
 We test both H direction and V direction, recorded worst case direction.

## 10. FREQUENCY STABILITY

### RULE PART(S)

FCC: §2.1055, §22.355, §24.235, §27.54

### LIMITS

§22.355 - The carrier frequency shall not depart from the reference frequency in excess of  $\pm 2.5$  ppm for mobile stations.

§24.235 - The frequency stability shall be sufficient to ensure that the fundamental emission stays within the authorized frequency block.

### TEST PROCEDURE

Use CMW 500 with Frequency Error measurement capability.

- Temp. =  $-30^{\circ}$  to  $+50^{\circ}\text{C}$
- Voltage = low voltage, DC 3.7V, Normal, DC 3.8V and High voltage, DC DC 5V.

### Frequency Stability vs Temperature:

The EUT is placed inside a temperature chamber. The temperature is set to  $-30^{\circ}\text{C}$  and allowed to stabilize. After sufficient soak time, the transmitting frequency error is measured. The temperature is increased by 10 degrees, allowed to stabilize and soak, and then the measurement is repeated. This is repeated until  $+50^{\circ}\text{C}$  is reached.

### Frequency Stability vs Voltage:

The peak frequency error is recorded (worst-case).

### MODES TESTED

- LTE Band 2  
LTE Band 4
- LTE Band 5  
LTE Band 7

## RESULTS

See the following pages.

10.1 LTE BAND 2

QPSK, (20MHz BANDWIDTH)

**Frequency error vs. Voltage**

Voltage [Vdc]	Frequency [MHz]	Frequency* Error[Hz]	Frequency Error[ppm]	Limit [ppm]
<b>BAND 2 QPSK, (CH 18900 RB size 100 RB Offset 0 20MHz BANDWIDTH)</b>				
3.2	1880	-17.7	-0.009415	2.5
3.8	1880	-17.8	-0.009468	2.5
4.3	1880	-17.3	-0.009202	2.5

**Frequency error vs. Temperature**

Temperature [° C]	Frequency [MHz]	Frequency* Error[Hz]	Frequency Error[ppm]	Limit [ppm]
<b>BAND 2 QPSK, (CH 18900 RB size 100 RB Offset 0 20MHz BANDWIDTH)</b>				
Normal (25C)	1880	-17.7	-0.009415	2.5
Extreme (50C)	1880	-15.6	-0.008298	2.5
Extreme (40C)	1880	-15.7	-0.008351	2.5
Extreme (30C)	1880	-17.8	-0.009468	2.5
Extreme (10C)	1880	-18.3	-0.009734	2.5
Extreme (0C)	1880	-18.2	-0.009681	2.5
Extreme (-10C)	1880	-19.9	-0.010585	2.5
Extreme (-20C)	1880	-19.1	-0.010160	2.5
Extreme (-30C)	1880	-19.8	-0.010532	2.5

**16QAM, (20MHz BANDWIDTH)**

**Frequency error vs. Voltage**

Voltage [Vdc]	Frequency [MHz]	Frequency* Error[Hz]	Frequency Error[ppm]	Limit [ppm]
<b>BAND 2 16QAM, (CH 18900 RB size 100 RB Offset 0 20MHz BANDWIDTH)</b>				
3.2	1880	-23.6	-0.012553	2.5
3.8	1880	-20.0	-0.010638	2.5
4.3	1880	-23.2	-0.012340	2.5

**Frequency error vs. Temperature**

Temperature [° C]	Frequency [MHz]	Frequency* Error[Hz]	Frequency Error[ppm]	Limit [ppm]
<b>BAND 2 16QAM, (CH 18900 RB size 100 RB Offset 0 20MHz BANDWIDTH)</b>				
Normal (25C)	1880	-23.9	-0.012713	2.5
Extreme (50C)	1880	-25.1	-0.013351	2.5
Extreme (40C)	1880	-24.7	-0.013138	2.5
Extreme (30C)	1880	-23.2	-0.012340	2.5
Extreme (10C)	1880	-23.8	-0.012660	2.5
Extreme (0C)	1880	-22.7	-0.012074	2.5
Extreme (-10C)	1880	-22.1	-0.011755	2.5
Extreme (-20C)	1880	-21.9	-0.011649	2.5
Extreme (-30C)	1880	-21.2	-0.011277	2.5

\*Note: Frequency error measurements were made by using the build-in capability of the Wireless Communication Test Set.

10.2 LTE BAND 4

QPSK, (10MHz BANDWIDTH)

**Frequency error vs. Voltage**

Voltage [Vdc]	Frequency [MHz]	Frequency* Error[Hz]	Frequency Error[ppm]	Limit [ppm]
<b>BAND 4 QPSK, (CH 20175 RB size 100 RB Offset 0 20MHz BANDWIDTH)</b>				
3.2	1732.5	-16.3	-0.009408	2.5
3.8	1732.5	-16.3	-0.009408	2.5
4.3	1732.5	-16.4	-0.009466	2.5

**Frequency error vs. Temperature**

Temperature [°C]	Frequency [MHz]	Frequency* Error[Hz]	Frequency Error[ppm]	Limit [ppm]
<b>BAND 4 QPSK, (CH 20175 RB size 100 RB Offset 0 20MHz BANDWIDTH)</b>				
Normal (25C)	1732.5	-16.4	-0.009466	2.5
Extreme (50C)	1732.5	-18.1	-0.010447	2.5
Extreme (40C)	1732.5	-17.8	-0.010274	2.5
Extreme (30C)	1732.5	-17.8	-0.010274	2.5
Extreme (10C)	1732.5	-16.1	-0.009293	2.5
Extreme (0C)	1732.5	-15.3	-0.008831	2.5
Extreme (-10C)	1732.5	-15.6	-0.009004	2.5
Extreme (-20C)	1732.5	-19.8	-0.011429	2.5
Extreme (-30C)	1732.5	-18.2	-0.010505	2.5

**16QAM, (20MHz BANDWIDTH)**

**Frequency error vs. Voltage**

Voltage [Vdc]	Frequency [MHz]	Frequency* Error[Hz]	Frequency Error[ppm]	Limit [ppm]
<b>BAND 4 16QAM, (CH 20175 RB size 100 RB Offset 0 20MHz BANDWIDTH)</b>				
3.2	1732.5	-17.2	-0.009928	2.5
3.8	1732.5	-17.9	-0.010332	2.5
4.3	1732.5	-17.7	-0.010216	2.5

**Frequency error vs. Temperature**

Temperature [°C]	Frequency [MHz]	Frequency* Error[Hz]	Frequency Error[ppm]	Limit [ppm]
<b>BAND 4 16QAM, (CH 20175 RB size 100 RB Offset 0 20MHz BANDWIDTH)</b>				
Normal (25C)	1732.5	-17.8	-0.010274	2.5
Extreme (50C)	1732.5	-14.8	-0.008543	2.5
Extreme (40C)	1732.5	-15.3	-0.008831	2.5
Extreme (30C)	1732.5	-16.6	-0.009582	2.5
Extreme (10C)	1732.5	-17.2	-0.009928	2.5
Extreme (0C)	1732.5	-16.9	-0.009755	2.5
Extreme (-10C)	1732.5	-15.1	-0.008716	2.5
Extreme (-20C)	1732.5	-16.7	-0.009639	2.5
Extreme (-30C)	1732.5	-16.6	-0.009582	2.5

**\*Note:** Frequency error measurements were made by using the build-in capability of the Wireless Communication Test Set.



10.3 LTE BAND 5

QPSK, (10MHz BANDWIDTH)

**Frequency error vs. Voltage**

Voltage [Vdc]	Frequency [MHz]	Frequency* Error[Hz]	Frequency Error[ppm]	Limit [ppm]
<b>BAND 5 QPSK, (CH 20525 RB size 50 RB Offset 0 10MHz BANDWIDTH)</b>				
3.2	836.5	-13.9	-0.016617	2.5
3.8	836.5	-13.5	-0.016139	2.5
4.3	836.5	-14.1	-0.016856	2.5

**Frequency error vs. Temperature**

Temperature [° C]	Frequency [MHz]	Frequency* Error[Hz]	Frequency Error[ppm]	Limit [ppm]
<b>BAND 5 QPSK, (CH 20525 RB size 50 RB Offset 0 10MHz BANDWIDTH)</b>				
Normal (25C)	836.5	-13.6	-0.016258	2.5
Extreme (50C)	836.5	-14.6	-0.017454	2.5
Extreme (40C)	836.5	-14.1	-0.016856	2.5
Extreme (30C)	836.5	-13.9	-0.016617	2.5
Extreme (10C)	836.5	-13.8	-0.016497	2.5
Extreme (0C)	836.5	-12.7	-0.015182	2.5
Extreme (-10C)	836.5	-14.3	-0.017095	2.5
Extreme (-20C)	836.5	-17.1	-0.020442	2.5
Extreme (-30C)	836.5	-18.3	-0.021877	2.5

**16QAM, (10MHz BANDWIDTH)**

**Frequency error vs. Voltage**

Voltage [Vdc]	Frequency [MHz]	Frequency* Error[Hz]	Frequency Error[ppm]	Limit [ppm]
<b>BAND 5 16QAM, (CH 20525 RB size 50 RB Offset 0 10MHz BANDWIDTH)</b>				
3.2	836.5	-14.3	-0.017095	2.5
3.8	836.5	-14.5	-0.017334	2.5
4.3	836.5	-14.9	-0.017812	2.5

**Frequency error vs. Temperature**

Temperature [° C]	Frequency [MHz]	Frequency* Error[Hz]	Frequency Error[ppm]	Limit [ppm]
<b>BAND 5 16QAM, (CH 20525 RB size 50 RB Offset 0 10MHz BANDWIDTH)</b>				
Normal (25C)	836.5	-14.8	-0.017693	2.5
Extreme (50C)	836.5	-15.9	-0.019008	2.5
Extreme (40C)	836.5	-15.9	-0.019008	2.5
Extreme (30C)	836.5	-15.1	-0.018051	2.5
Extreme (10C)	836.5	-14.3	-0.017095	2.5
Extreme (0C)	836.5	-13.3	-0.015900	2.5
Extreme (-10C)	836.5	-15.1	-0.018051	2.5
Extreme (-20C)	836.5	-14.9	-0.017812	2.5
Extreme (-30C)	836.5	-13.8	-0.016497	2.5

\*Note: Frequency error measurements were made by using the build-in capability of the Wireless Communication Test Set.

10.4 LTE BAND 7

QPSK, (20MHz BANDWIDTH)

**Frequency error vs. Voltage**

Voltage [Vdc]	Frequency [MHz]	Frequency* Error[Hz]	Frequency Error[ppm]	Limit [ppm]
<b>BAND 7 QPSK, (CH 21100 RB size 100 RB Offset 0 20MHz BANDWIDTH)</b>				
3.2	2535	-26.6	-0.010493	2.5
3.8	2535	-27.0	-0.010651	2.5
4.3	2535	-27.4	-0.010809	2.5

**Frequency error vs. Temperature**

Temperature [° C]	Frequency [MHz]	Frequency* Error[Hz]	Frequency Error[ppm]	Limit [ppm]
<b>BAND 7 QPSK, (CH 21100 RB size 100 RB Offset 0 20MHz BANDWIDTH)</b>				
Normal (25C)	2535	-27.3	-0.010769	2.5
Extreme (50C)	2535	-30.1	-0.011874	2.5
Extreme (40C)	2535	-32.2	-0.012702	2.5
Extreme (30C)	2535	-27.2	-0.010730	2.5
Extreme (10C)	2535	-26.8	-0.010572	2.5
Extreme (0C)	2535	-25.9	-0.010217	2.5
Extreme (-10C)	2535	-29.1	-0.011479	2.5
Extreme (-20C)	2535	-27.6	-0.010888	2.5
Extreme (-30C)	2535	-30.7	-0.012110	2.5

**16QAM, (20MHz BANDWIDTH)**

**Frequency error vs. Voltage**

Voltage [Vdc]	Frequency [MHz]	Frequency* Error[Hz]	Frequency Error[ppm]	Limit [ppm]
<b>BAND 7 16QAM, (CH 21100 RB size 100 RB Offset 0 20MHz BANDWIDTH)</b>				
3.2	2535	-28.5	-0.011243	2.5
3.8	2535	-28.9	-0.011400	2.5
4.3	2535	-28.9	-0.011400	2.5

**Frequency error vs. Temperature**

Temperature [° C]	Frequency [MHz]	Frequency* Error[Hz]	Frequency Error[ppm]	Limit [ppm]
<b>BAND 7 16QAM, (CH 21100 RB size 100 RB Offset 0 20MHz BANDWIDTH)</b>				
Normal (25C)	2535	-28.2	-0.011124	2.5
Extreme (50C)	2535	-29.7	-0.011716	2.5
Extreme (40C)	2535	-31.2	-0.012308	2.5
Extreme (30C)	2535	-28.3	-0.011164	2.5
Extreme (10C)	2535	-28.4	-0.011203	2.5
Extreme (0C)	2535	-29.1	-0.011479	2.5
Extreme (-10C)	2535	-29.9	-0.011795	2.5
Extreme (-20C)	2535	-29.5	-0.011637	2.5
Extreme (-30C)	2535	-30.2	-0.011913	2.5

\***Note:** Frequency error measurements were made by using the build-in capability of the Wireless Communication Test Set.

## 11. Peak-to-Average Ratio

### 11.1 Description of the PAR Measurement

The peak-to-average ratio (PAR) of the transmission may not exceed 13 dB.

### 11.2 Measuring Instruments

See list of measuring instruments of this test report.

### 11.3 Test Procedures

1. The EUT was connected to Spectrum Analyzer and Base Station via power divider.
2. The RF output of EUT was connected to the spectrum analyzer by RF cable and attenuator. The path loss was compensated to the results for each measurement.
3. For GSM/EGPRS operating modes:
  - a. Set the RBW = 1MHz, VBW = 1MHz, Peak detector in spectrum analyzer.
  - b. Set EUT in maximum power output, and triggered the burst signal.
  - c. Measured respectively the Peak level and Mean level, and the deviation was recorded as Peak to Average Ratio.
4. For UMTS operating modes:
  - a. Set the CCDF (Complementary Cumulative Distribution Function) option in spectrum analyzer.
  - b. The highest RF powers were measured and recorded the maximum PAPR level associated with a probability of 0.1 %.

### 11.4 Test Setup

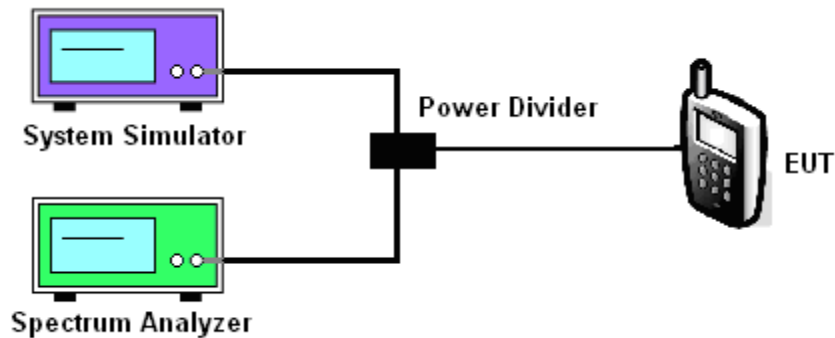

#### MODES TESTED

- LTE Band2
- LTE Band 4
- LTE Band5
- LTE Band 7

BAND	CHANNEL	Frequency [MHz]	BANDWIDTH	NO. RB	RB POS.	MODULATION	PAR [dB]
2	18900	1880.0	1.4	1	Low	QPSK	5.63
2	18900	1880.0	1.4	1	Low	16-QAM	6.40
2	18900	1880.0	3.0	1	Low	QPSK	5.69
2	18900	1880.0	3.0	1	Low	16-QAM	6.51
2	18900	1880.0	5.0	1	Low	QPSK	5.82
2	18900	1880.0	5.0	1	Low	16-QAM	6.58
2	18900	1880.0	10.0	1	Low	QPSK	5.85
2	18900	1880.0	10.0	1	Low	16-QAM	6.60
2	18900	1880.0	15.0	1	Low	QPSK	6.18
2	18900	1880.0	15.0	1	Low	16-QAM	6.65
2	18900	1880.0	20.0	1	Low	QPSK	5.79
2	18900	1880.0	20.0	1	Low	16-QAM	6.59
4	20175	1732.5	1.4	1	Low	QPSK	5.37
4	20175	1732.5	1.4	1	Low	16-QAM	6.13
4	20175	1732.5	3.0	1	Low	QPSK	5.50
4	20175	1732.5	3.0	1	Low	16-QAM	6.34
4	20175	1732.5	5.0	1	Low	QPSK	5.55
4	20175	1732.5	5.0	1	Low	16-QAM	6.29
4	20175	1732.5	10.0	1	Low	QPSK	5.58
4	20175	1732.5	10.0	1	Low	16-QAM	6.34

4	20175	1732.5	15.0	1	Low	QPSK	5.90
4	20175	1732.5	15.0	1	Low	16-QAM	6.45
4	20175	1732.5	20.0	1	Low	QPSK	5.59
4	20175	1732.5	20.0	1	Low	16-QAM	6.39
5	20525	836.5	1.4	1	Low	QPSK	5.72
5	20525	836.5	1.4	1	Low	16-QAM	6.56
5	20525	836.5	3.0	1	Low	QPSK	5.75
5	20525	836.5	3.0	1	Low	16-QAM	6.56
5	20525	836.5	5.0	1	Low	QPSK	5.83
5	20525	836.5	5.0	1	Low	16-QAM	6.48
5	20525	836.5	10.0	1	Low	QPSK	5.79
5	20525	836.5	10.0	1	Low	16-QAM	6.46
7	21100	2535.0	5.0	1	Low	QPSK	5.34
7	21100	2535.0	5.0	1	Low	16-QAM	6.18
7	21100	2535.0	10.0	1	Low	QPSK	5.34
7	21100	2535.0	10.0	1	Low	16-QAM	6.19
7	21100	2535.0	15.0	1	Low	QPSK	5.67
7	21100	2535.0	15.0	1	Low	16-QAM	6.38
7	21100	2535.0	20.0	1	Low	QPSK	5.51
7	21100	2535.0	20.0	1	Low	16-QAM	6.33

11.5 LTE BAND 2

Band 2, UL Channel 18900, UL Frequency 1880.0, BW 1.4, NO. RB 1, RB POS. Low, QPSK

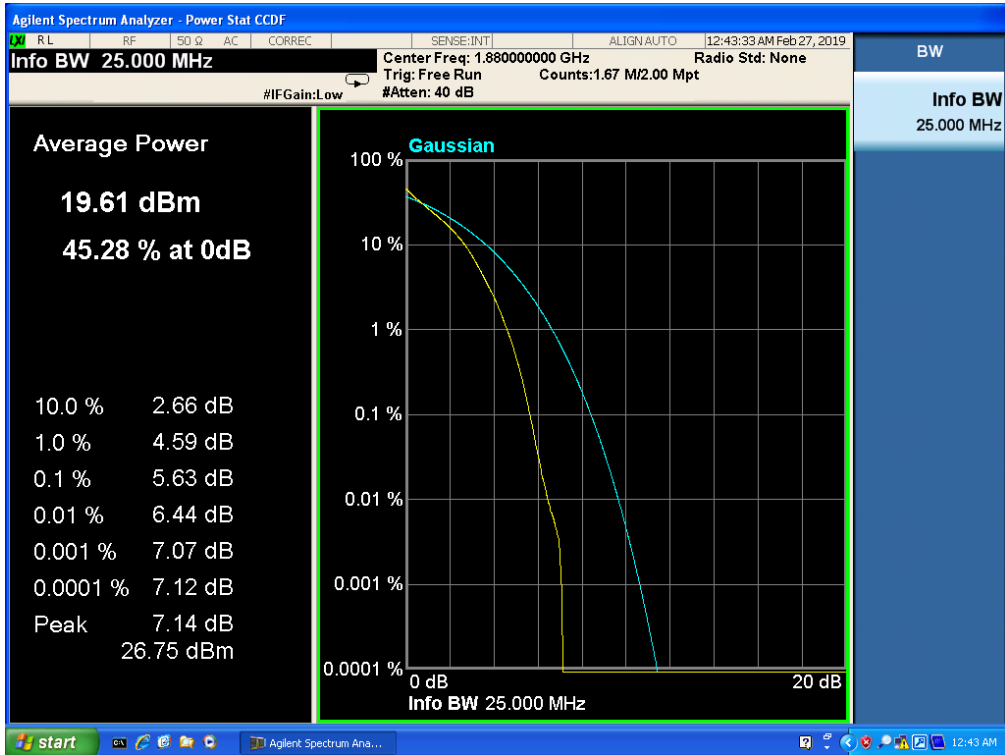

Band 2, UL Channel 18900, UL Frequency 1880.0, BW 1.4, NO. RB 1, RB POS. Low, 16-QAM

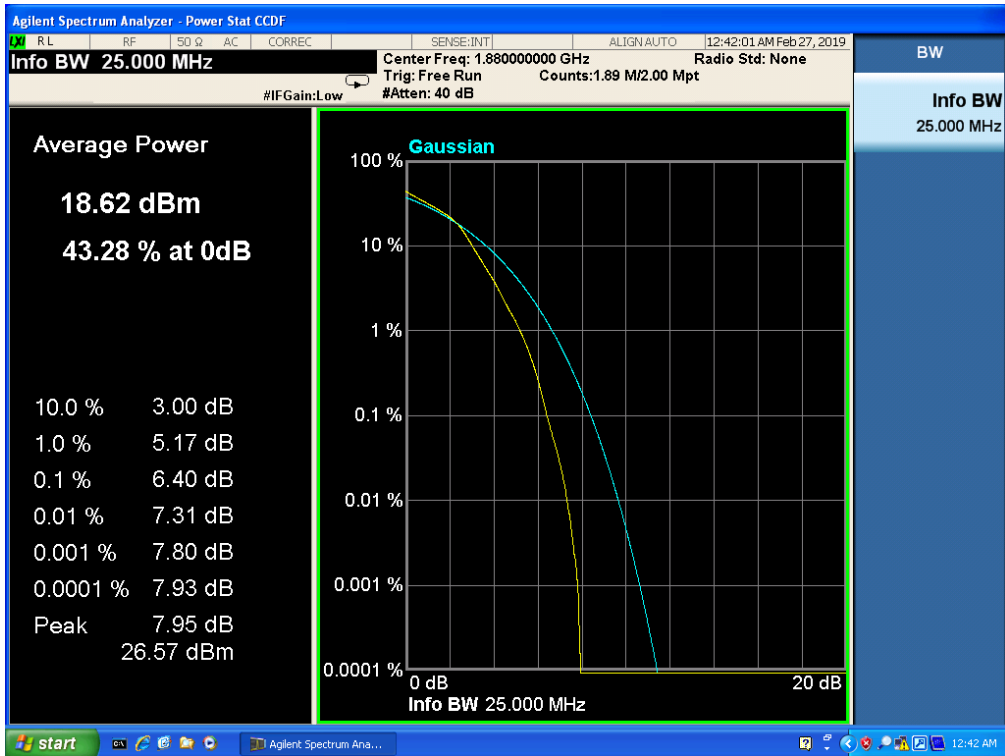



Band 2, UL Channel 18900, UL Frequency 1880.0, BW 3.0, NO. RB 1, RB POS. Low, QPSK

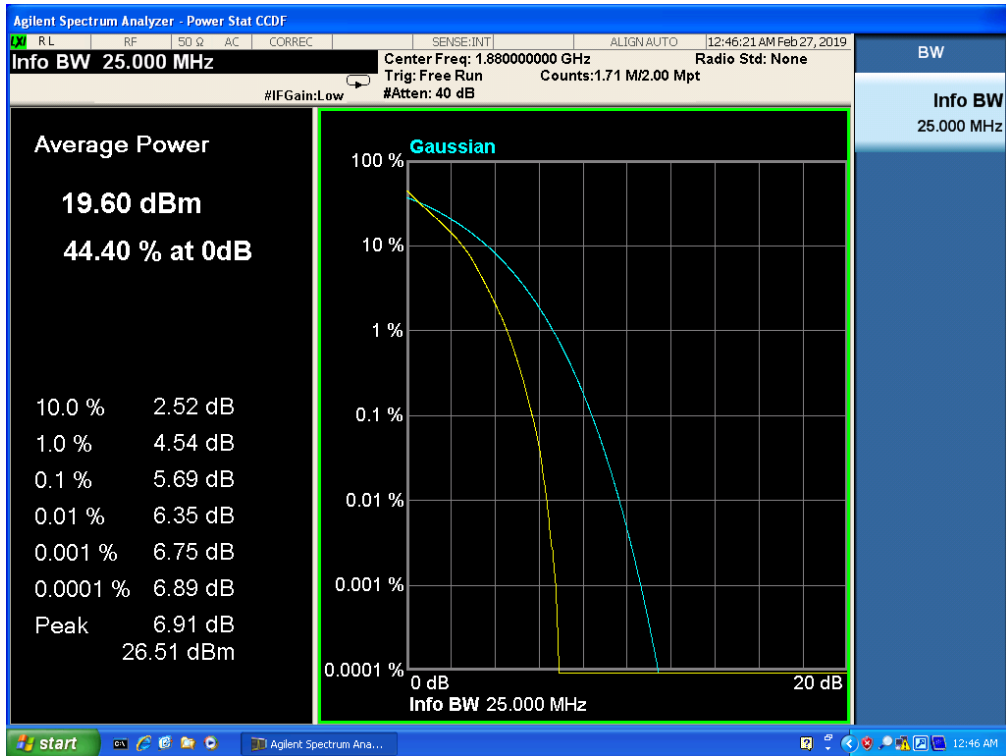

Band 2, UL Channel 18900, UL Frequency 1880.0, BW 3.0, NO. RB 1, RB POS. Low, 16-QAM

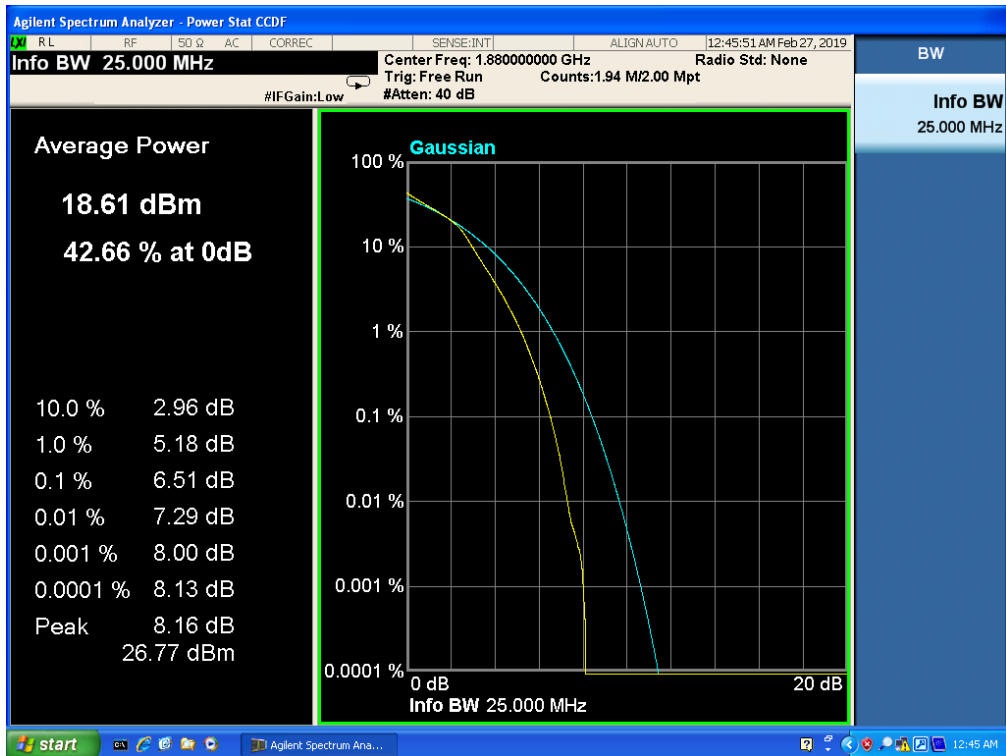

Band 2, UL Channel 18900, UL Frequency 1880.0, BW 5.0, NO. RB 1, RB POS. Low, QPSK



Band 2, UL Channel 18900, UL Frequency 1880.0, BW 5.0, NO. RB 1, RB POS. Low, 16-QAM

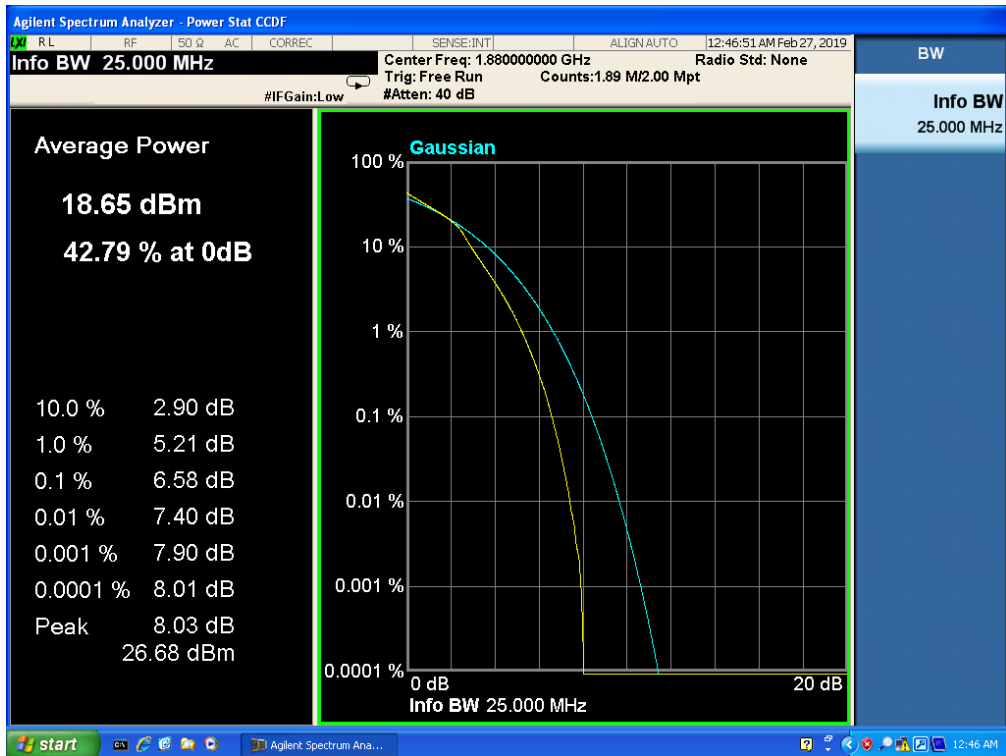

Band 2, UL Channel 18900, UL Frequency 1880.0, BW 10.0, NO. RB 1, RB POS. Low, QPSK

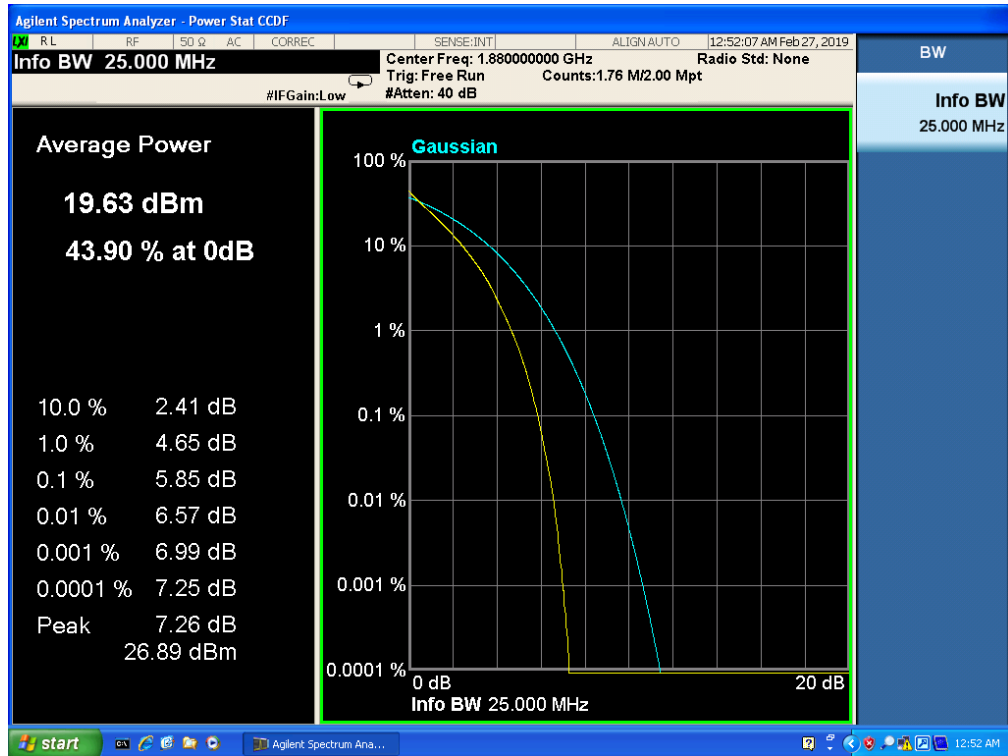

Band 2, UL Channel 18900, UL Frequency 1880.0, BW 10.0, NO. RB 1, RB POS. Low, 16-QAM

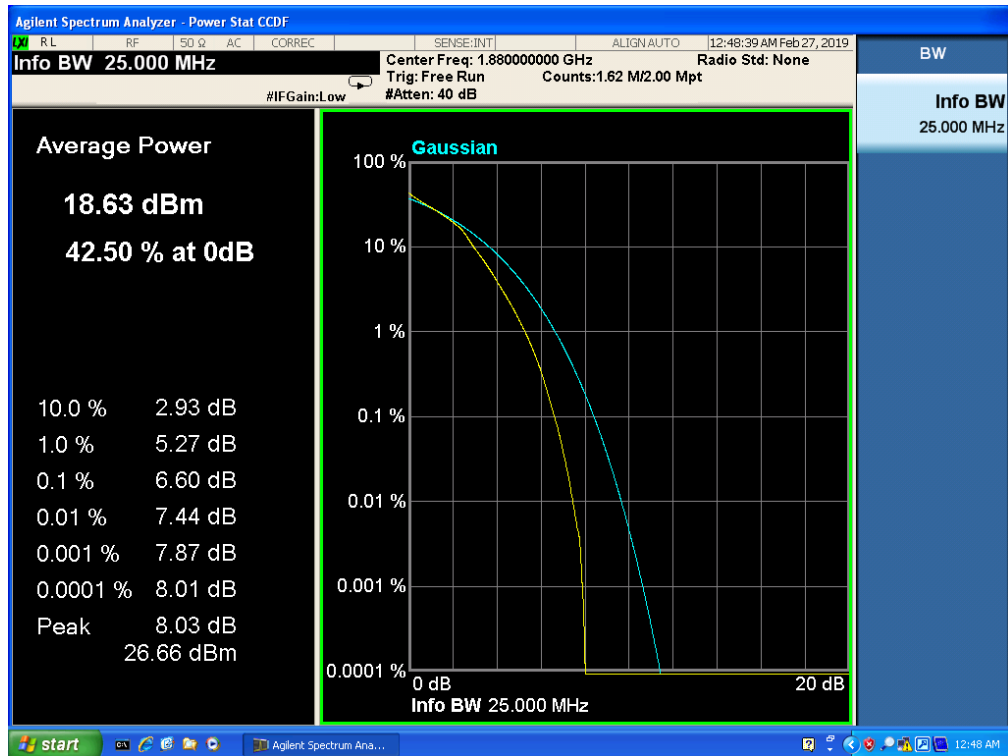

Band 2, UL Channel 18900, UL Frequency 1880.0, BW 15.0, NO. RB 1, RB POS. Low, QPSK

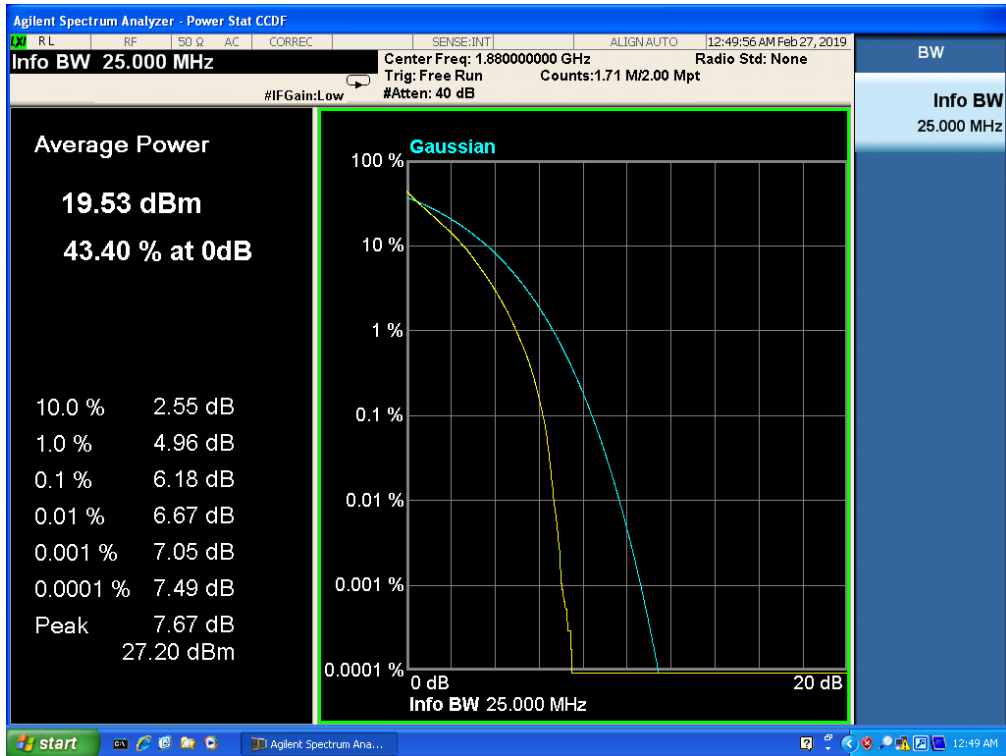

Band 2, UL Channel 18900, UL Frequency 1880.0, BW 15.0, NO. RB 1, RB POS. Low, 16-QAM

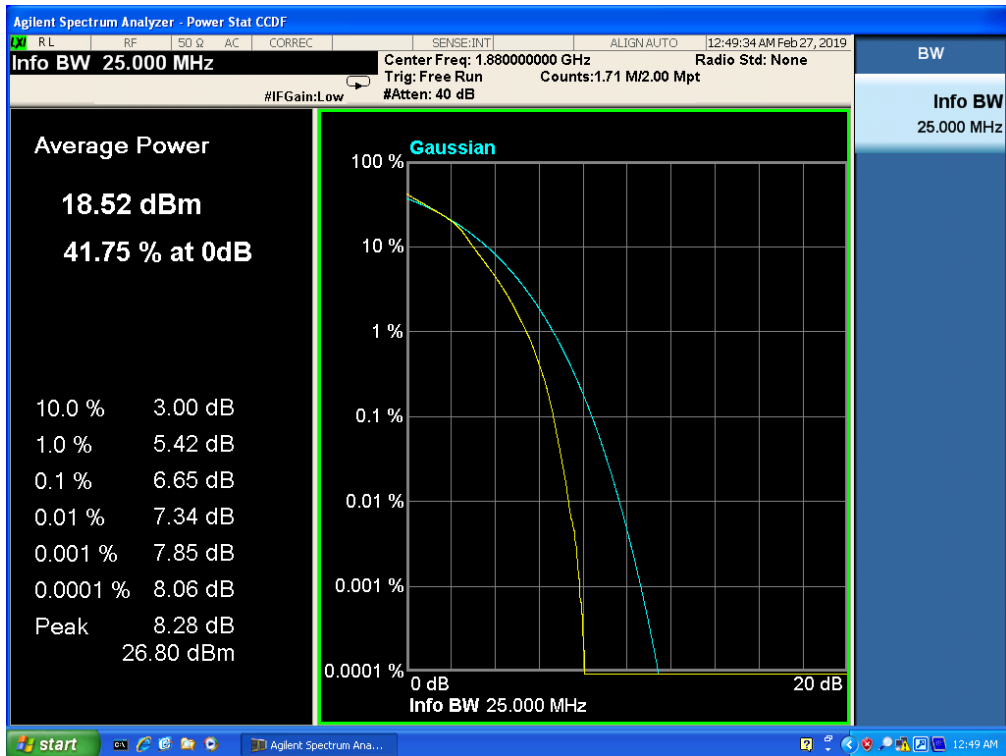

Band 2, UL Channel 18900, UL Frequency 1880.0, BW 20.0, NO. RB 1, RB POS. Low, QPSK



Band 2, UL Channel 18900, UL Frequency 1880.0, BW 20.0, NO. RB 1, RB POS. Low, 16-QAM

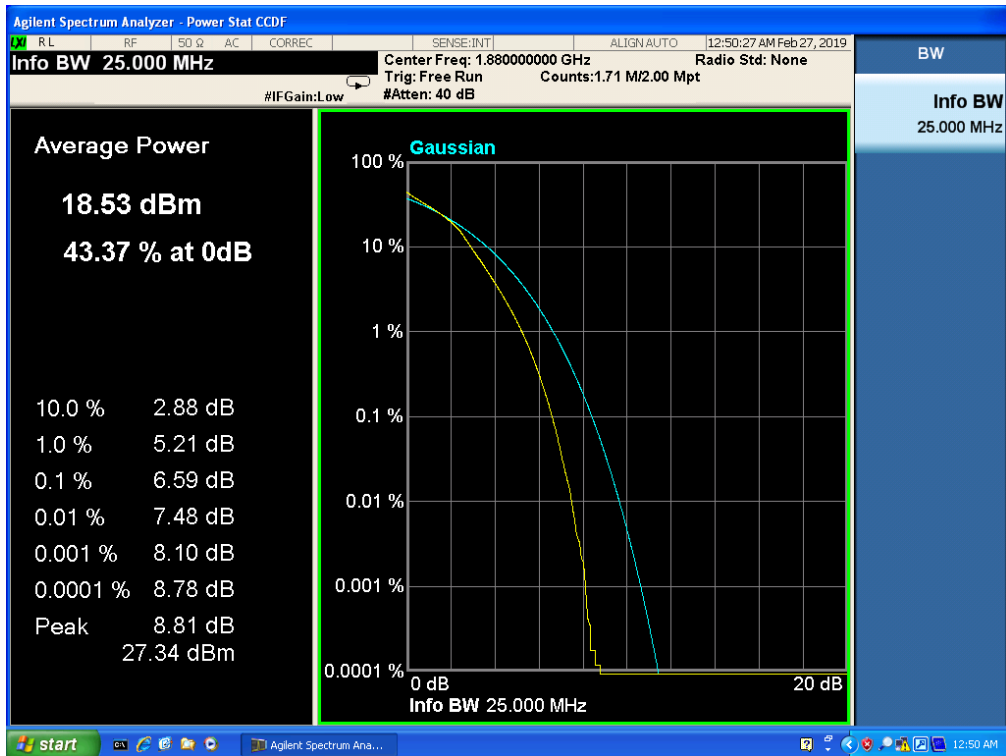

### 11.6 LTE BAND 4

*Band 4, UL Channel 20175, UL Frequency 1732.5, BW 1.4, NO. RB 1, RB POS. Low, QPSK*

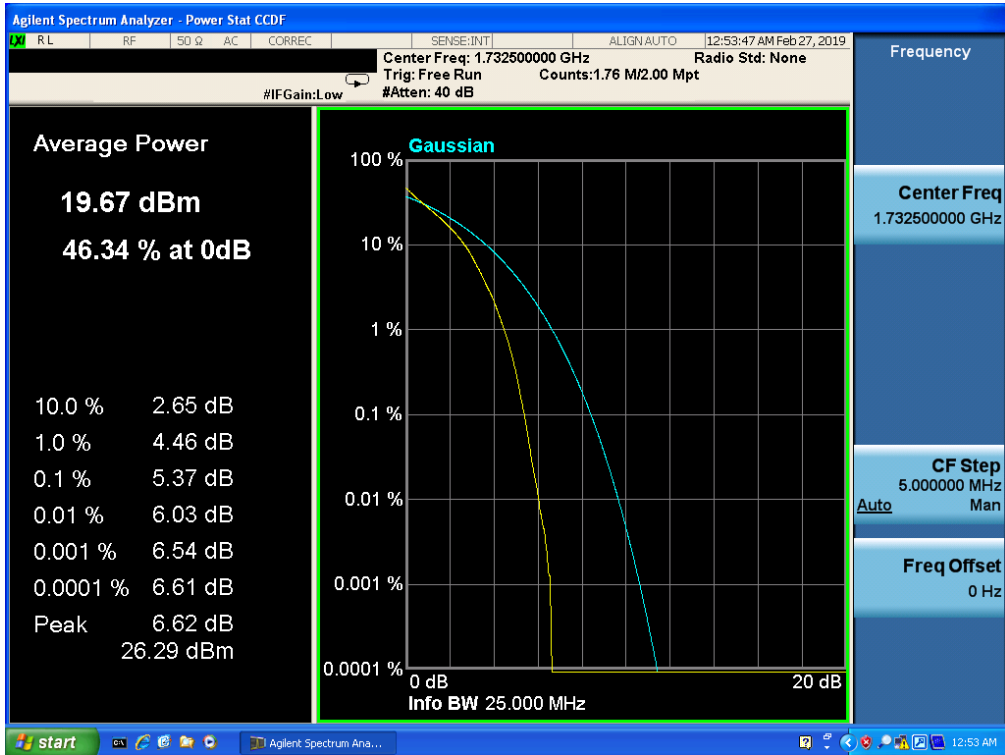

*Band 4, UL Channel 20175, UL Frequency 1732.5, BW 1.4, NO. RB 1, RB POS. Low, 16-QAM*



Band 4, UL Channel 20175, UL Frequency 1732.5, BW 3.0, NO. RB 1, RB POS. Low, QPSK

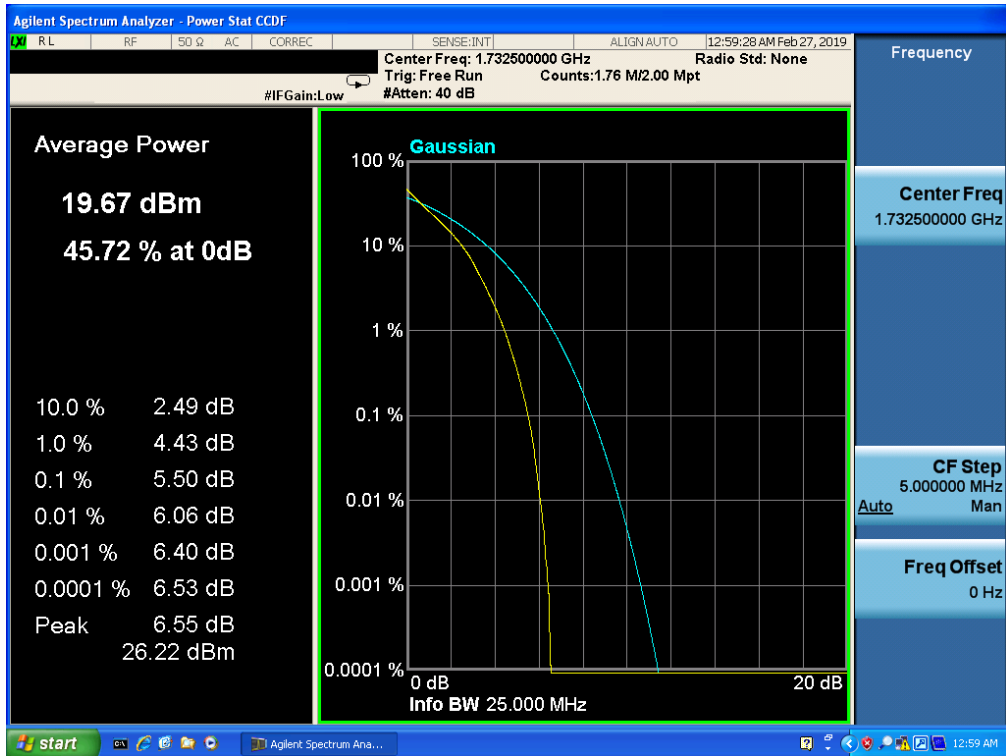

Band 4, UL Channel 20175, UL Frequency 1732.5, BW 3.0, NO. RB 1, RB POS. Low, 16-QAM

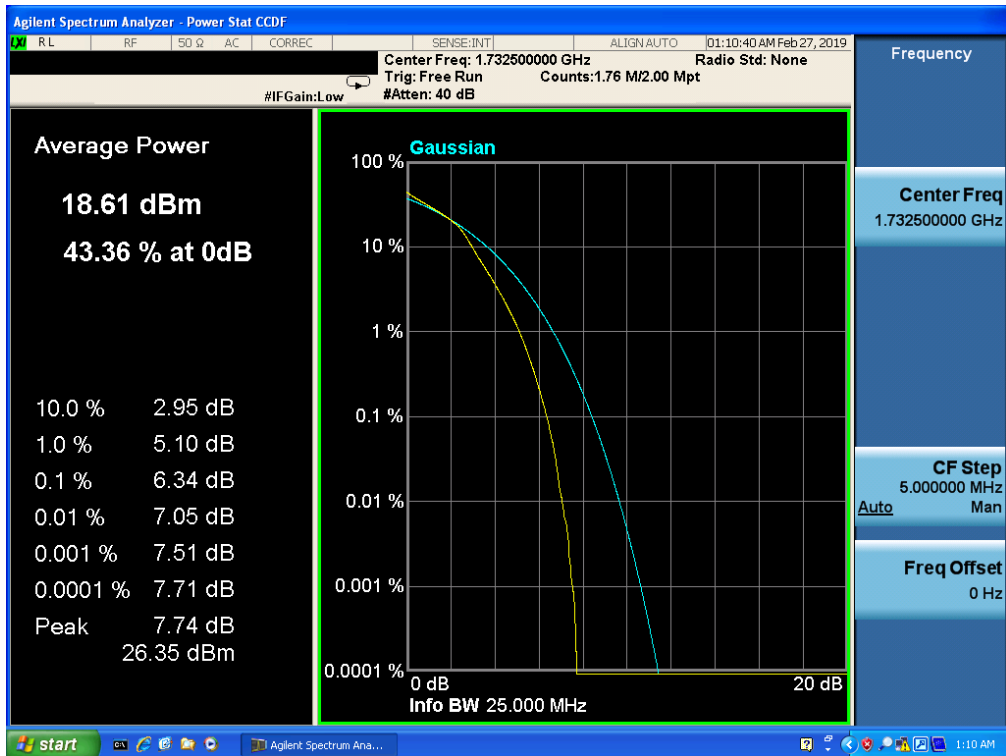

Band 4, UL Channel 20175, UL Frequency 1732.5, BW 5.0, NO. RB 1, RB POS. Low, QPSK

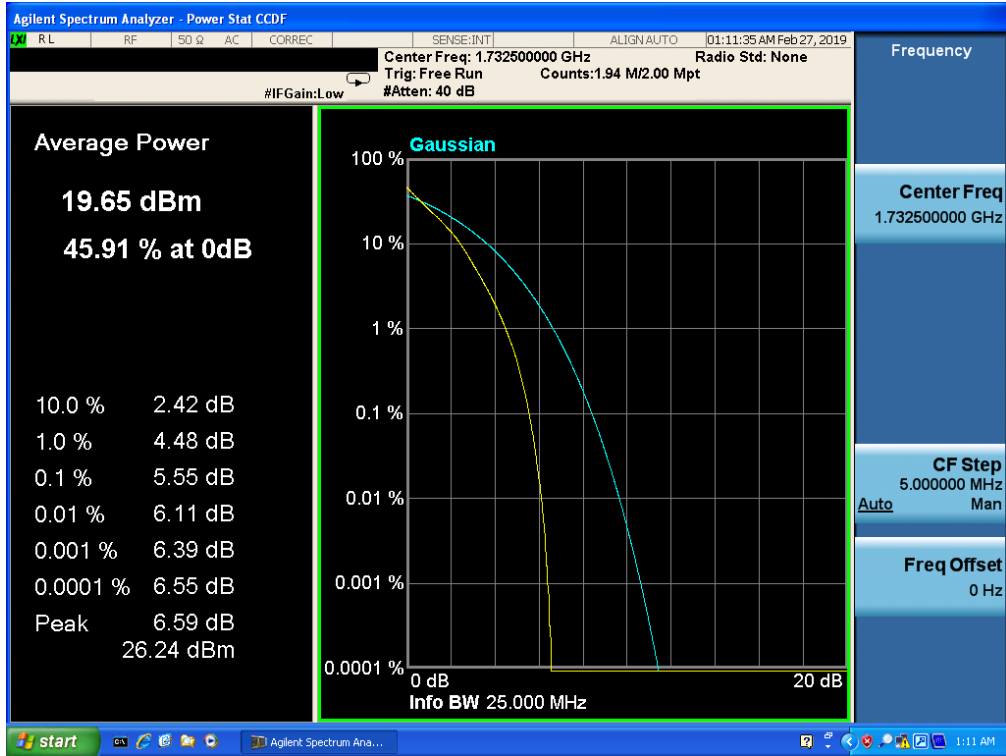

Band 4, UL Channel 20175, UL Frequency 1732.5, BW 5.0, NO. RB 1, RB POS. Low, 16-QAM

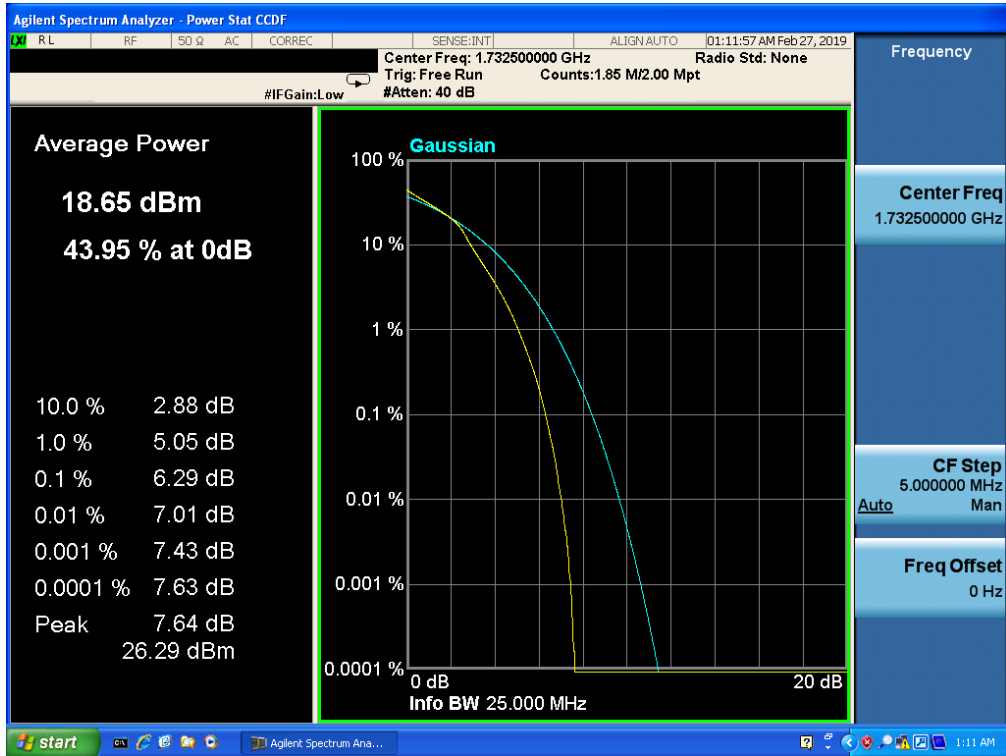



Band 4, UL Channel 20175, UL Frequency 1732.5, BW 10.0, NO. RB 1, RB POS. Low, QPSK

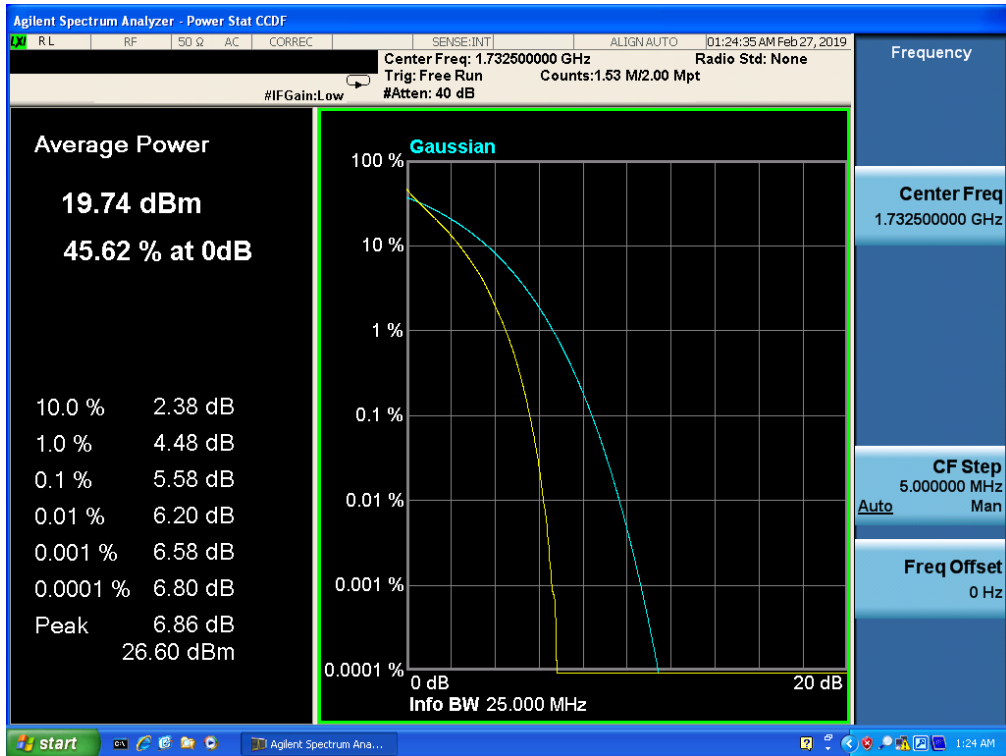

Band 4, UL Channel 20175, UL Frequency 1732.5, BW 10.0, NO. RB 1, RB POS. Low, 16-QAM

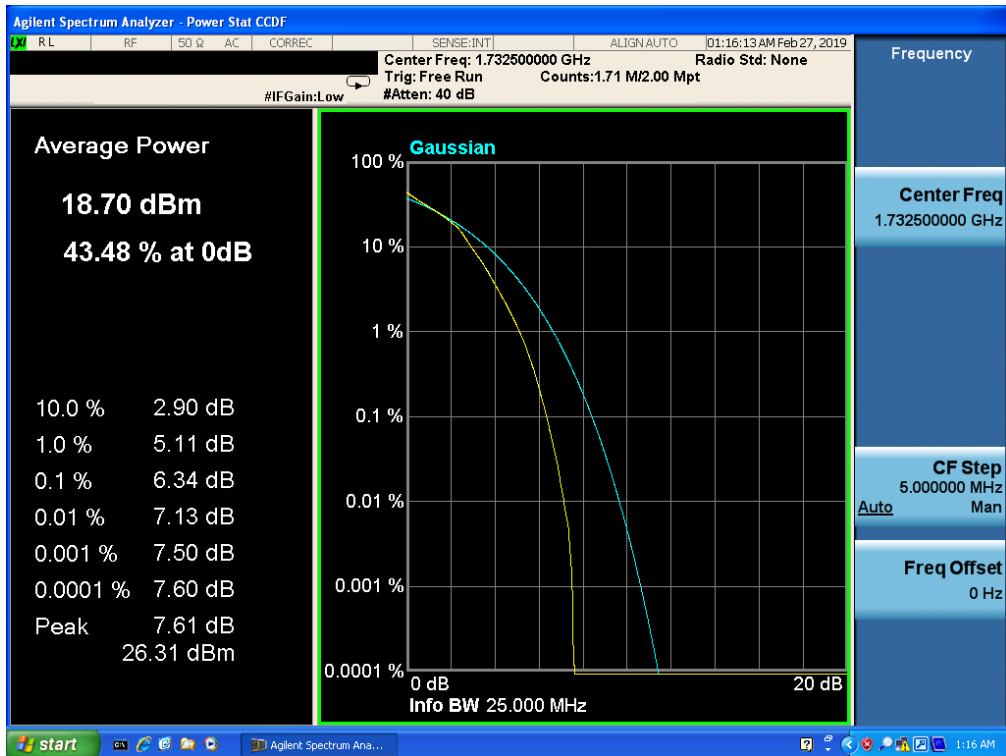

Band 4, UL Channel 20175, UL Frequency 1732.5, BW 15.0, NO. RB 1, RB POS. Low, QPSK

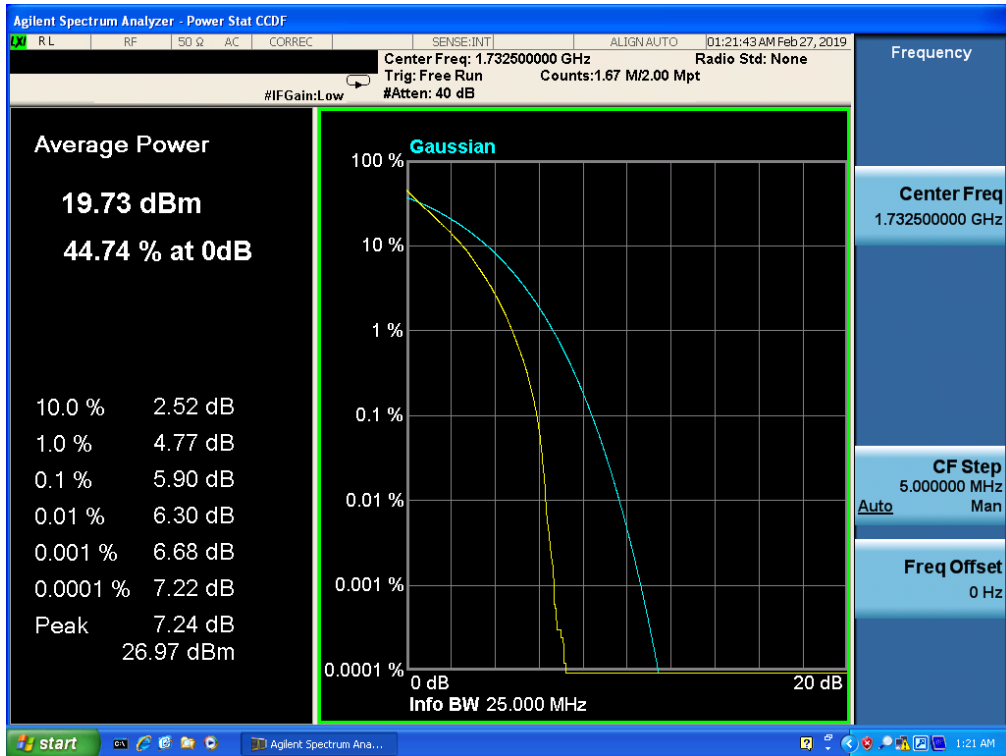

Band 4, UL Channel 20175, UL Frequency 1732.5, BW 15.0, NO. RB 1, RB POS. Low, 16-QAM

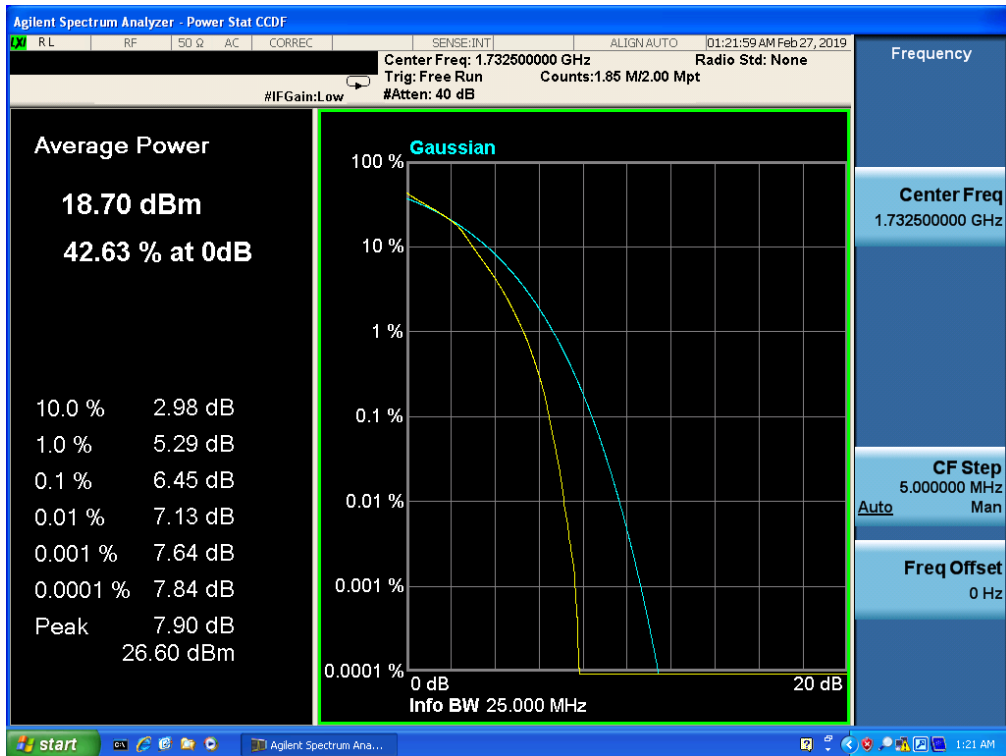

Band 4, UL Channel 20175, UL Frequency 1732.5, BW 20.0, NO. RB 1, RB POS. Low, QPSK

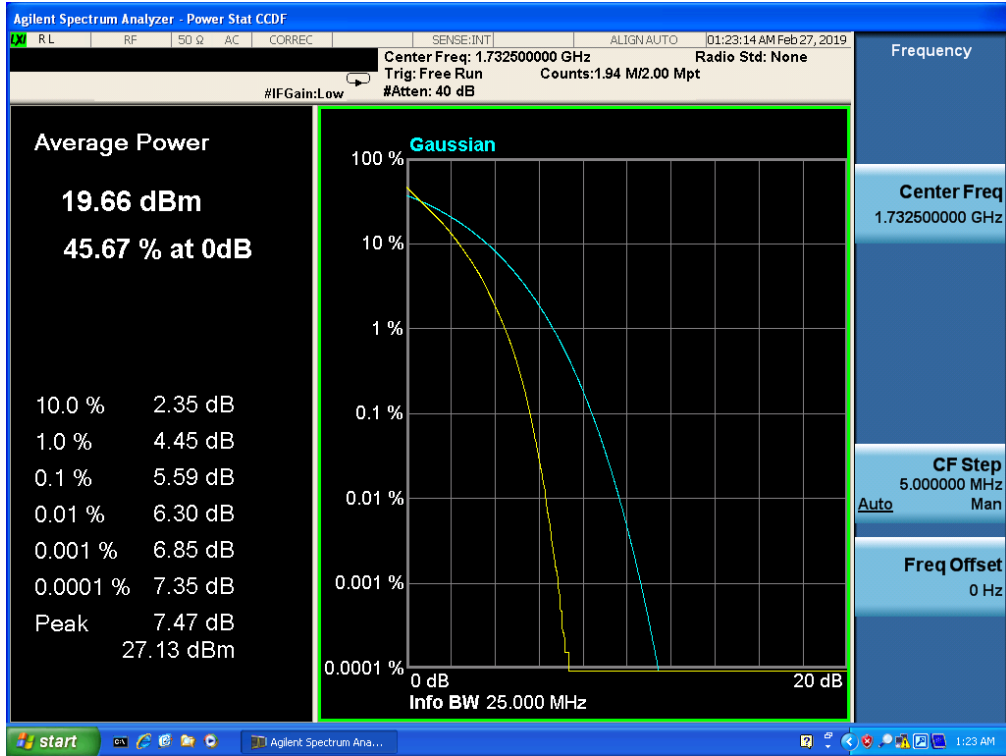

Band 4, UL Channel 20175, UL Frequency 1732.5, BW 20.0, NO. RB 1, RB POS. Low, 16-QAM

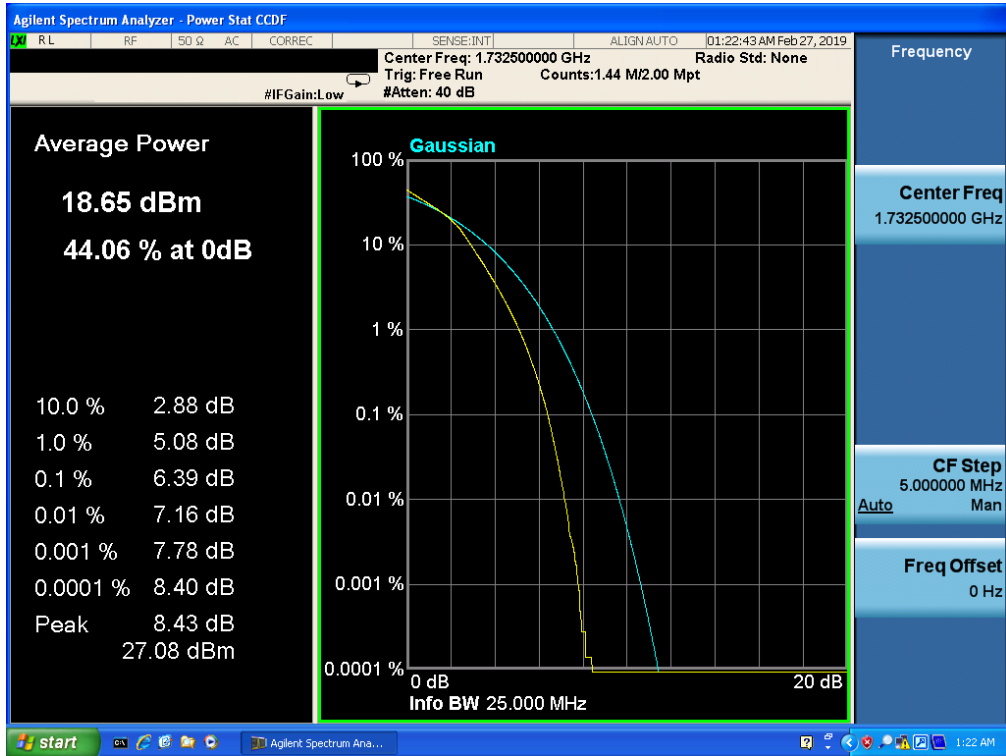

**11.7 LTE BAND 5**

*Band 5, UL Channel 20525, UL Frequency 836.5, BW 1.4, NO. RB 1, RB POS. Low, QPSK*

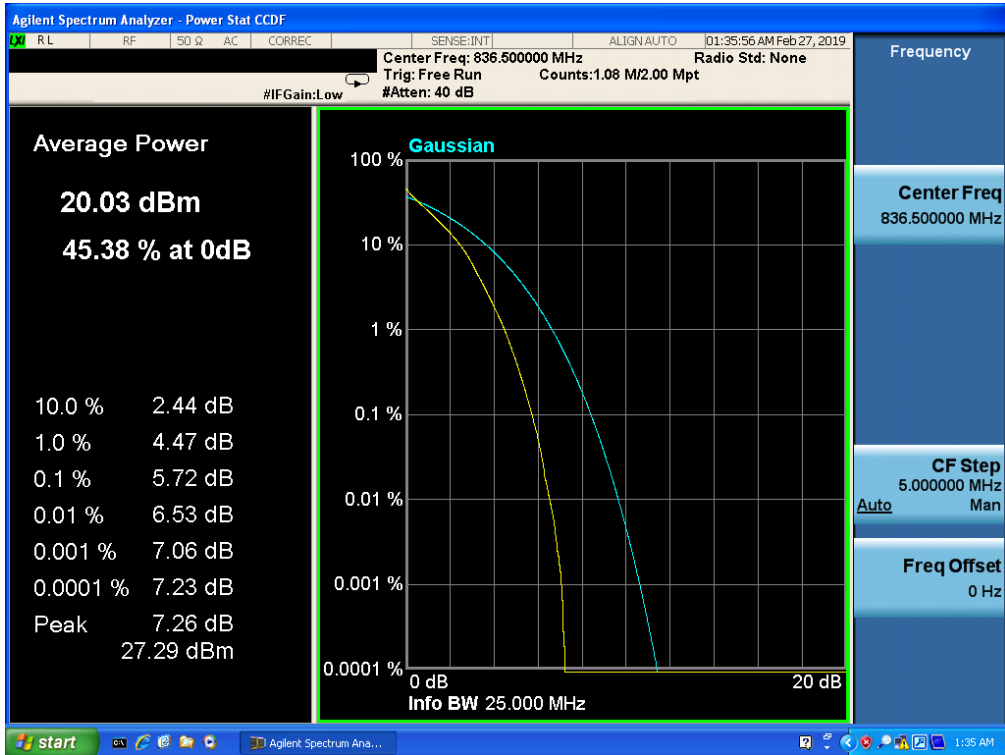

*Band 5, UL Channel 20525, UL Frequency 836.5, BW 1.4, NO. RB 1, RB POS. Low, 16-QAM*



Band 5, UL Channel 20525, UL Frequency 836.5, BW 3.0, NO. RB 1, RB POS. Low, QPSK

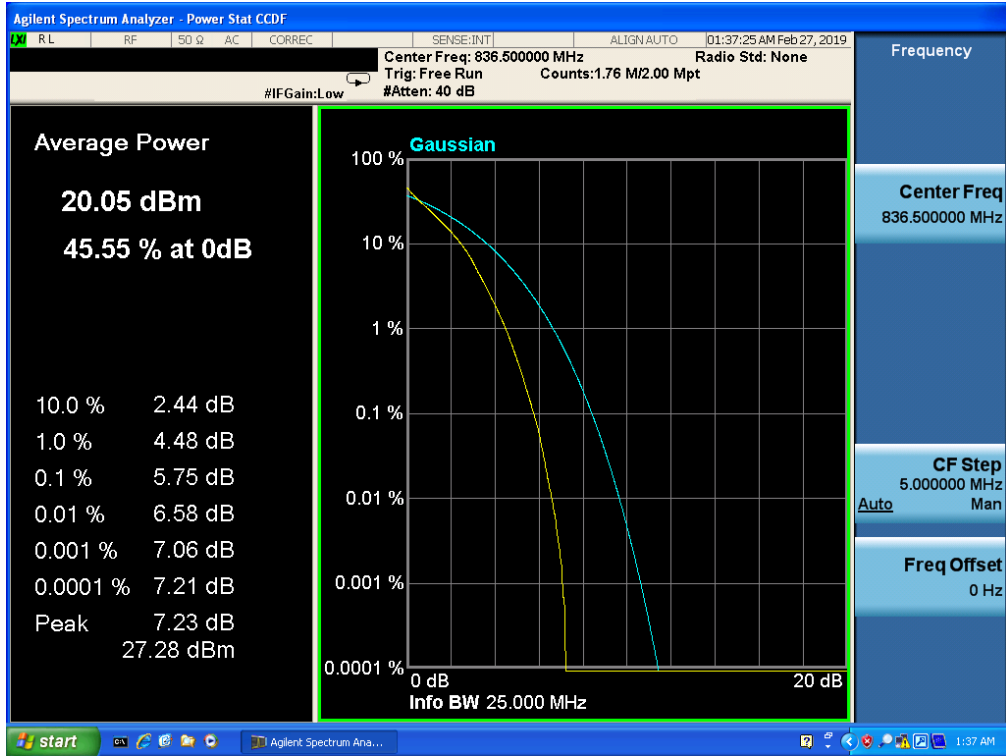

Band 5, UL Channel 20525, UL Frequency 836.5, BW 3.0, NO. RB 1, RB POS. Low, 16-QAM

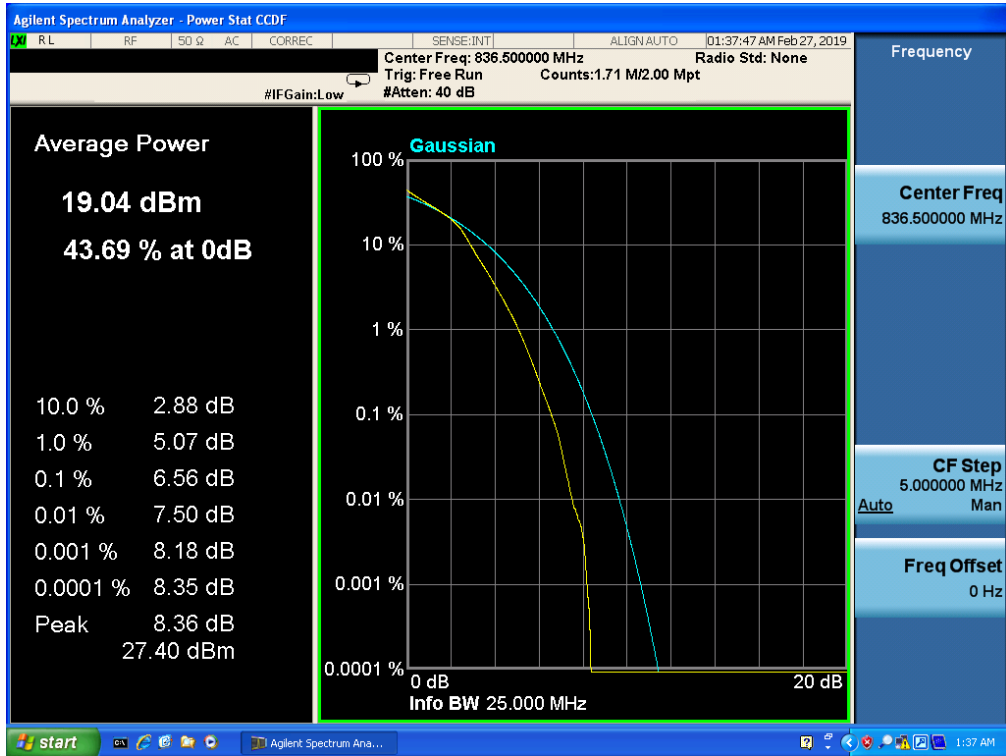

Band 5, UL Channel 20525, UL Frequency 836.5, BW 5.0, NO. RB 1, RB POS. Low, QPSK

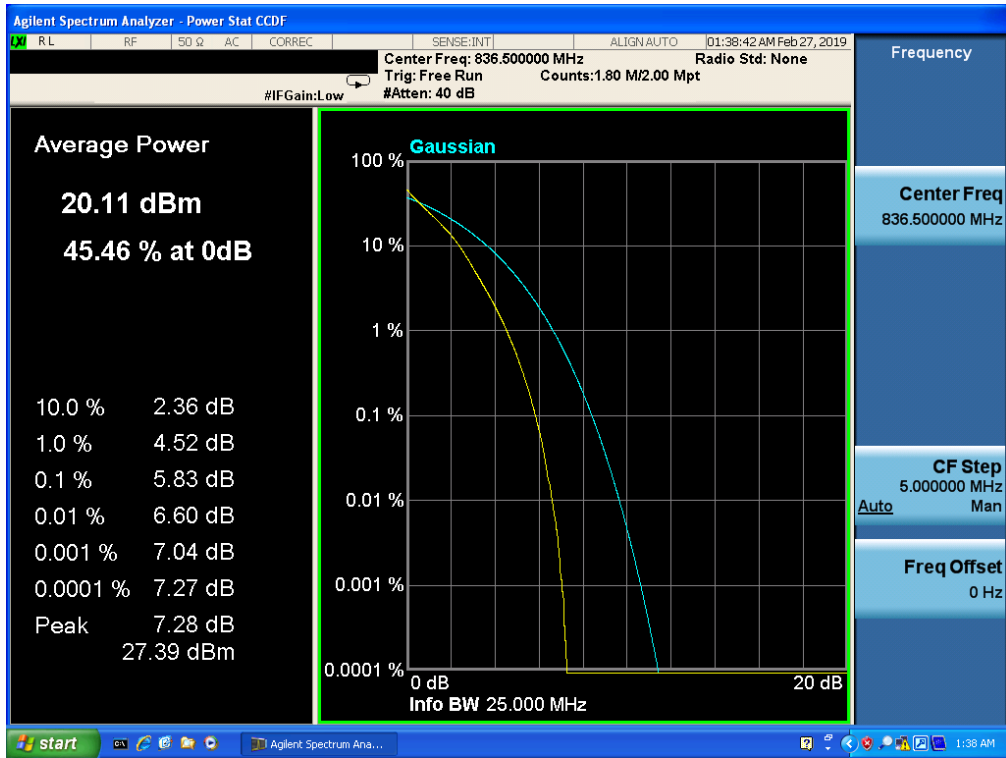

Band 5, UL Channel 20525, UL Frequency 836.5, BW 5.0, NO. RB 1, RB POS. Low, 16-QAM

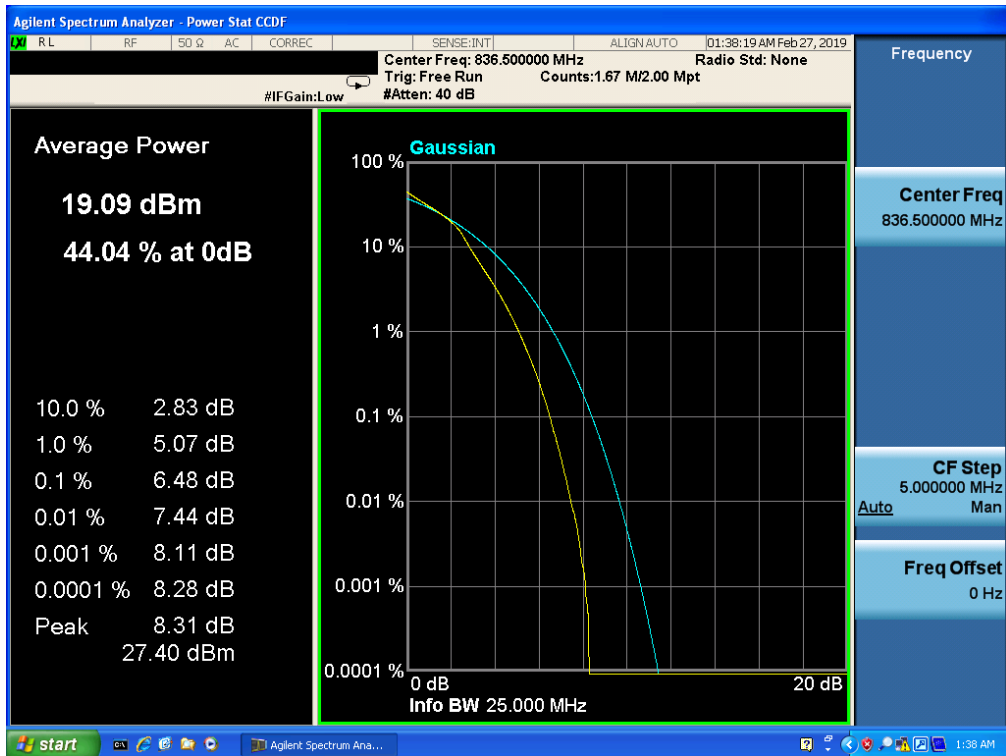

Band 5, UL Channel 20525, UL Frequency 836.5, BW 10.0, NO. RB 1, RB POS. Low, QPSK

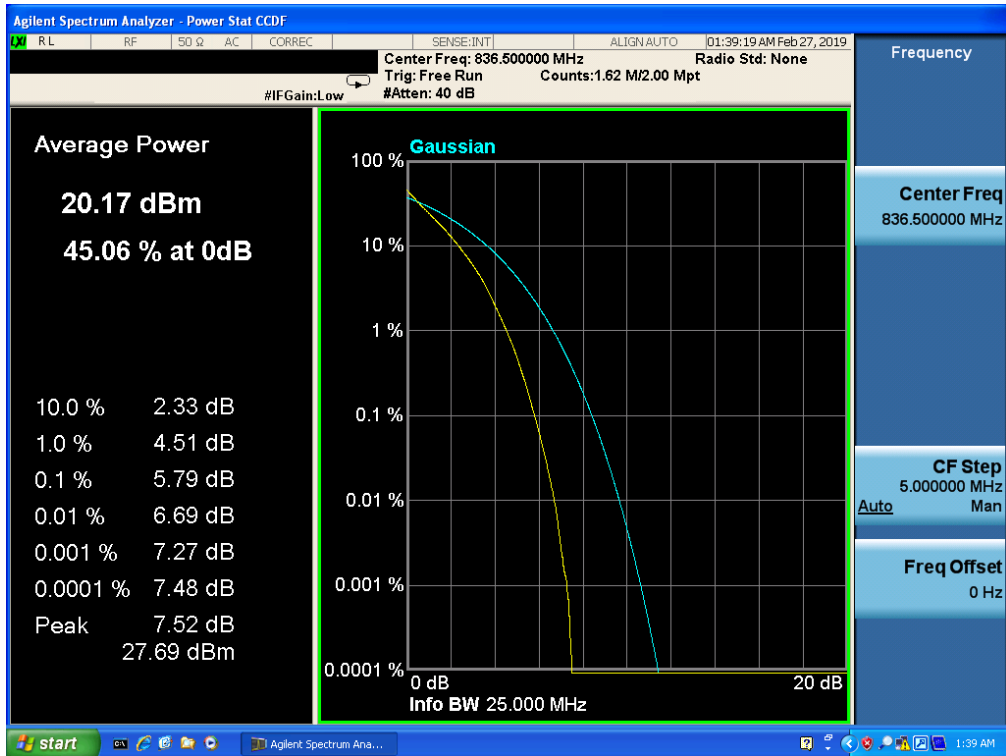

Band 5, UL Channel 20525, UL Frequency 836.5, BW 10.0, NO. RB 1, RB POS. Low, 16-QAM

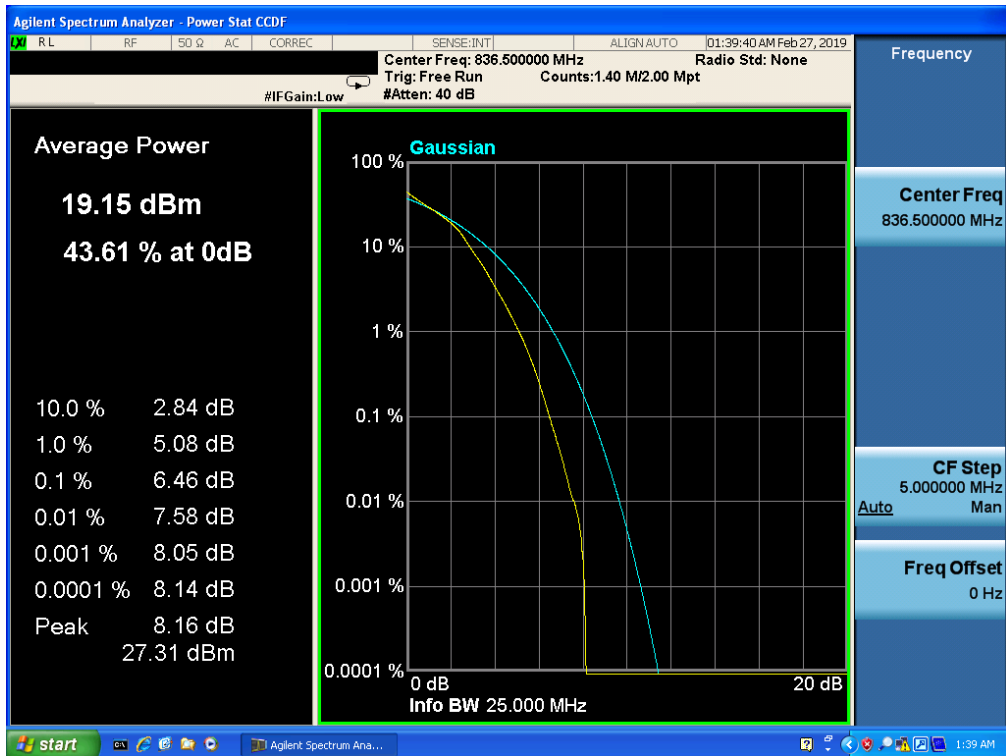

### 11.8 LTE BAND 7

*Band 7, UL Channel 21100, UL Frequency 2535.0, BW 5.0, NO. RB 25, RB POS. Low, QPSK*

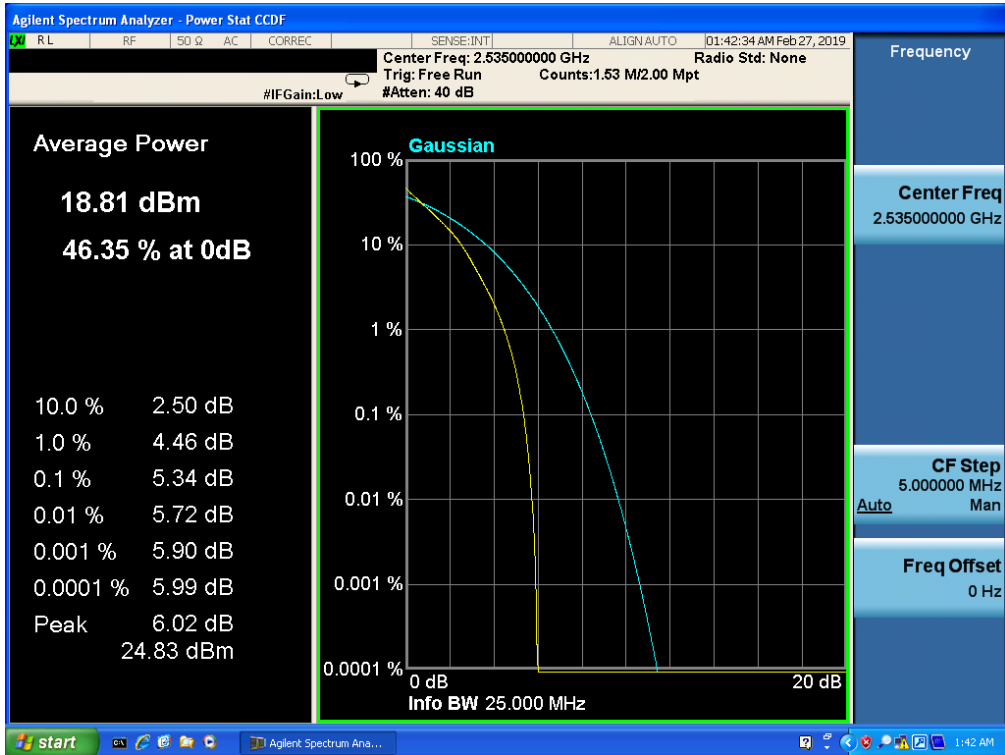

*Band 7, UL Channel 21100, UL Frequency 2535.0, BW 5.0, NO. RB 25, RB POS. Low, 16-QAM*





Band 7, UL Channel 21100, UL Frequency 2535.0, BW 10.0, NO. RB 1, RB POS. Low, QPSK

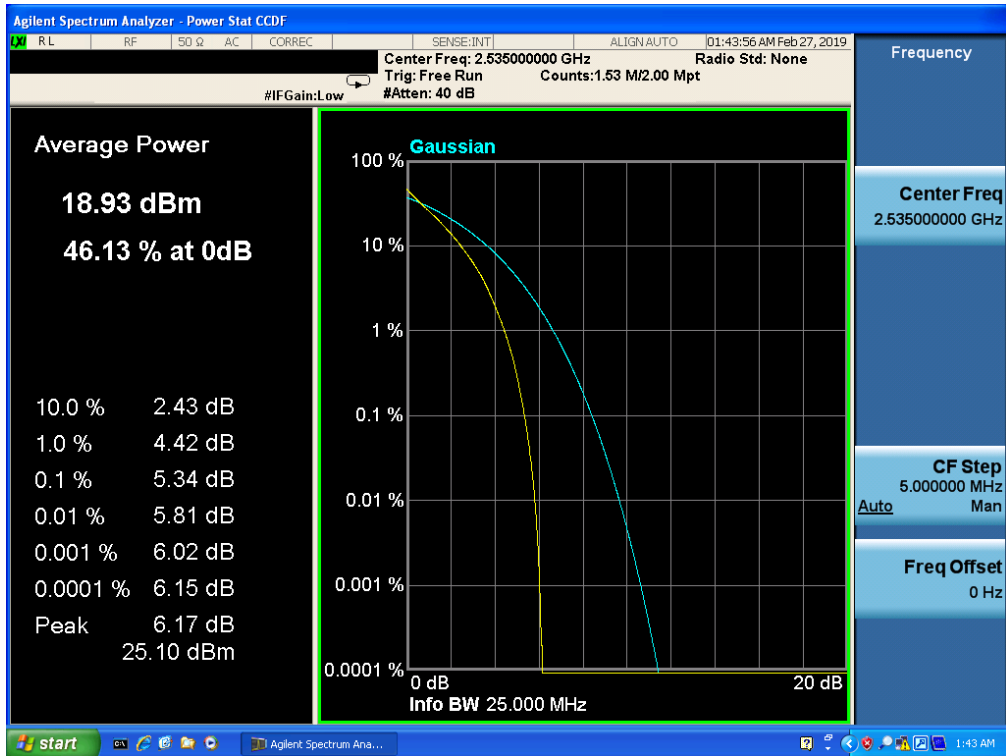

Band 7, UL Channel 21100, UL Frequency 2535.0, BW 10.0, NO. RB 1, RB POS. Low, 16-QAM

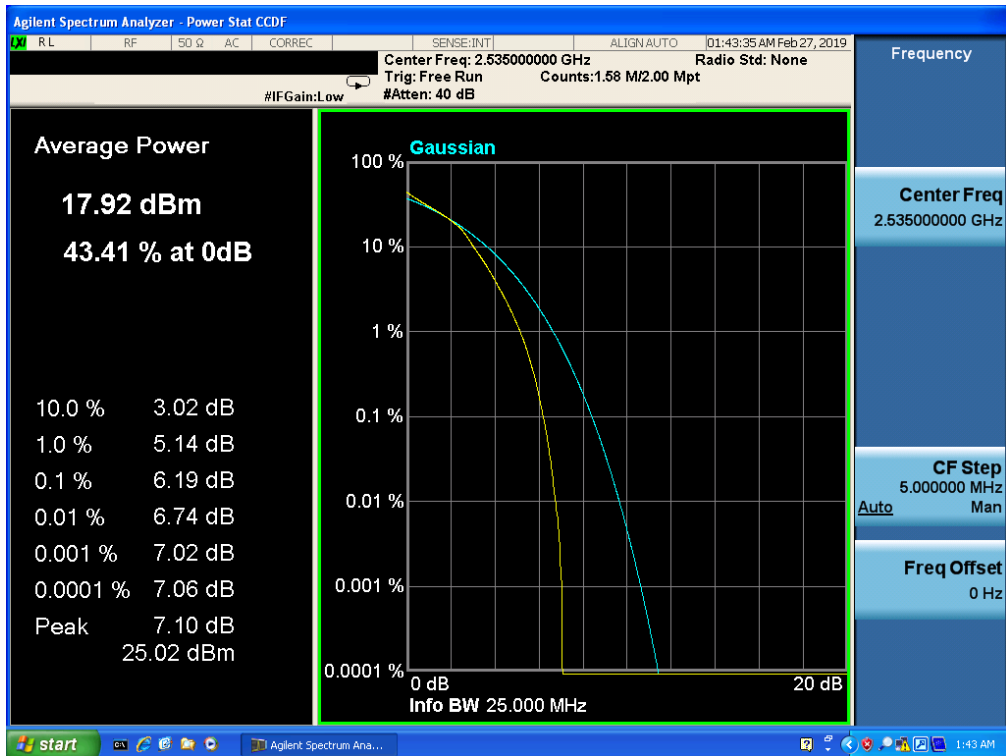

Band 7, UL Channel 21100, UL Frequency 2535.0, BW 15.0, NO. RB 1, RB POS. Low, QPSK

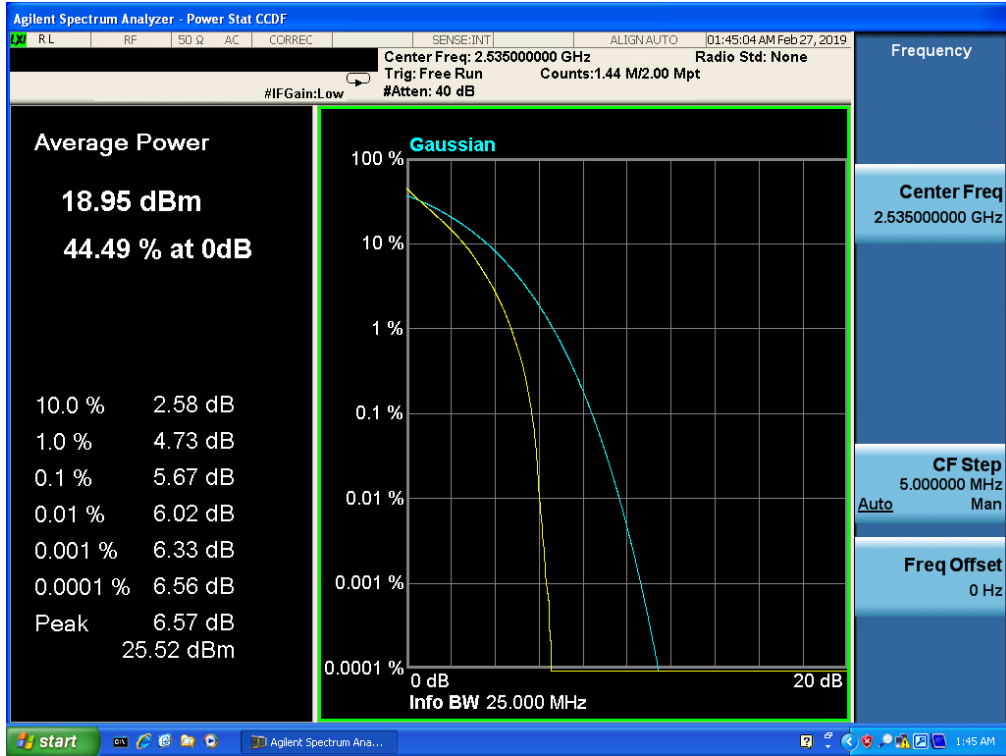

Band 7, UL Channel 21100, UL Frequency 2535.0, BW 15.0, NO. RB 1, RB POS. Low, 16-QAM

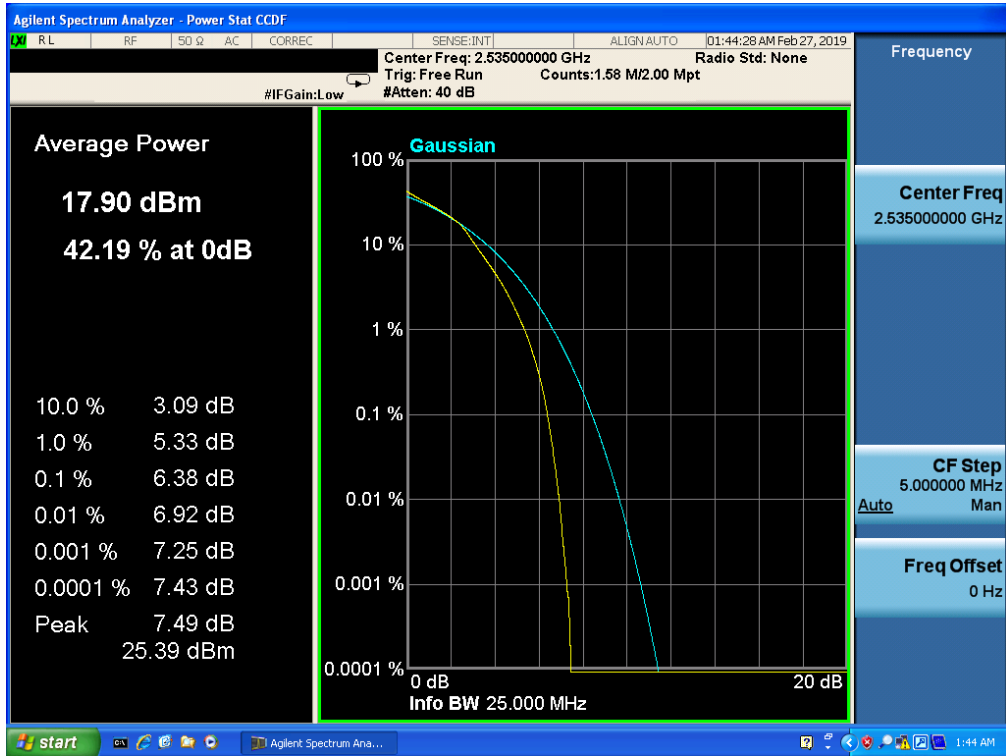

Band 7, UL Channel 21100, UL Frequency 2535.0, BW 20.0, NO. RB 1, RB POS. Low, QPSK

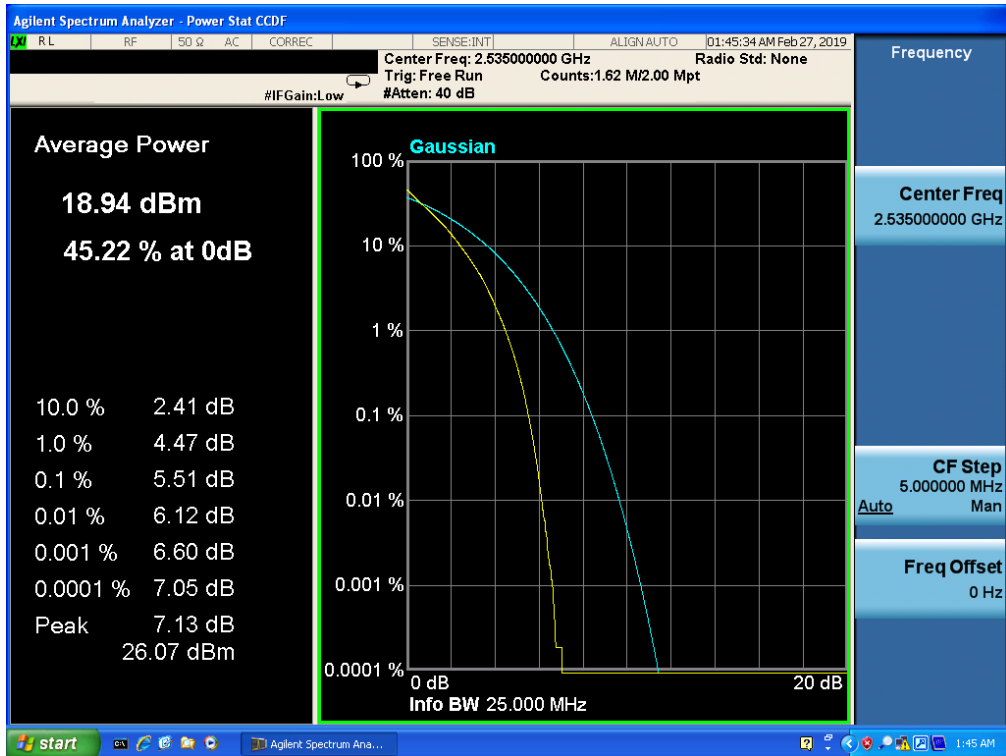

Band 7, UL Channel 21100, UL Frequency 2535.0, BW 20.0, NO. RB 1, RB POS. Low, 16-QAM

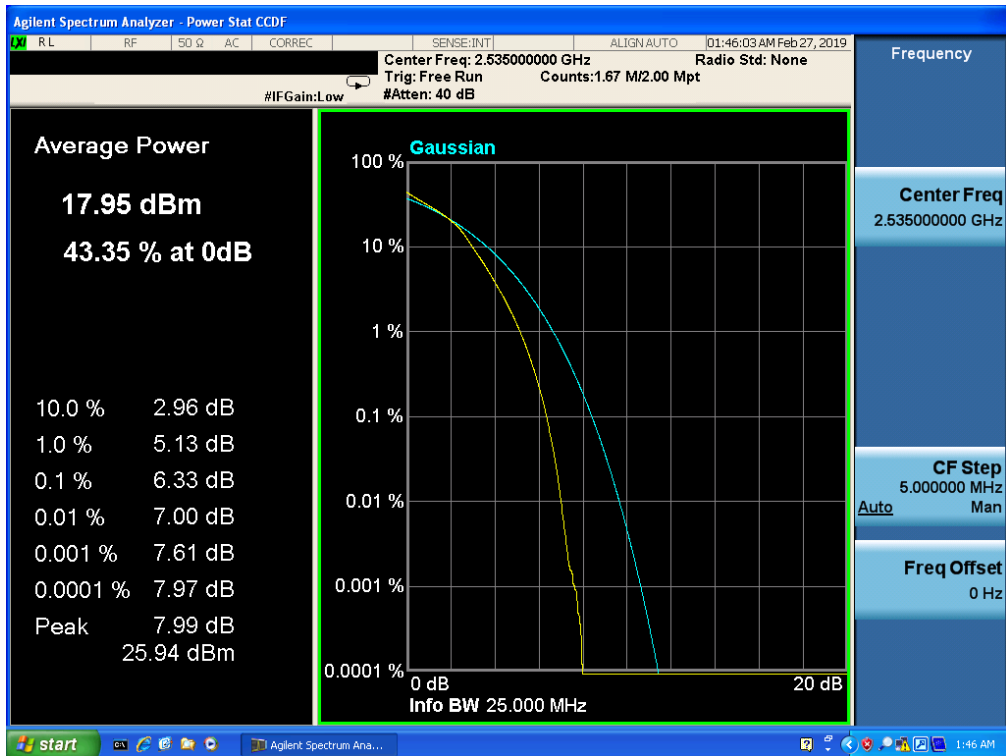

----END OF REPORT----