

FCC CFR47 PART 22H, 24E, 27 CERTIFICATION TEST REPORT

FCC ID: ZSW-30-085

Product: Mobile phone

Trade Mark: Bmobile

Model Number: AX1080

Family Model: N/A

Report No.: S19012403603005

Prepared for

b mobile HK Limited

Flat 18; 14/F Block 1; Golden Industrial Building; 16-26 KwaiTak Street;
Kwai Chung; New Territories; Hong Kong, China

Prepared by

Shenzhen NTEK Testing Technology Co., Ltd.

1/F, Building E, Fenda Science Park, Sanwei Community, Xixiang Street

Bao'an District, Shenzhen 518126 P.R. China

Tel.: +86-755-6115 9388 Fax.: +86-755-6115 6599

Website: <http://www.ntek.org.cn>

TEST RESULT CERTIFICATION

Applicant's name : b mobile HK Limited
Address : Flat 18; 14/F Block 1; Golden Industrial Building;16-26 KwaiTak Street; Kwai Chung;New Territories; Hong Kong, China
Manufacturer's Name : b mobile HK Limited
Address : Flat 18; 14/F Block 1; Golden Industrial Building;16-26 KwaiTak Street; Kwai Chung;New Territories; Hong Kong, China
Product name : Mobile phone
Model and/or type reference : AX1080
Family Model: N/A
Standards : FCC CFR 47 Part 22H, Part 24E, Part 27
Test procedure : ANSI C63.26:2015
ANSI/TIA-603-E-2016

This device described above has been tested by NTEK, and the test results show that the equipment under test (EUT) is in compliance with the FCC requirements. And it is applicable only to the tested sample identified in the report.

This report shall not be reproduced except in full, without the written approval of NTEK, this document may be altered or revised by NTEK, personal only, and shall be noted in the revision of the document.

Date of Test :
Date (s) of performance of tests : Jan. 26, 2019 ~ Mar. 26, 2019
Date of Issue : May. 10, 2019
Test Result : Pass

Testing Engineer : [Signature: Cheng Jiawen]
(Cheng Jiawen)

Technical Manager : [Signature: Jason Chen]
(Jason Chen)

Authorized Signatory : [Signature: Sam Chen]
(Sam Chen)

TABLE OF CONTENTS

1.1 PRODUCT DESCRIPTION	6
1.2 RELATED SUBMITTAL(S) / GRANT (S)	7
1.3 TEST METHODOLOGY	7
1.4 TEST FACILITY	7
MEASUREMENT UNCERTAINTY	7
1.5 SPECIAL ACCESSORIES.....	7
1.6 WORST-CASE CONFIGURATION AND MODE.....	7
2. SYSTEM TEST CONFIGURATION	8
2.1 EUT CONFIGURATION.....	8
2.2 EUT EXERCISE	8
2.3 CONFIGURATION OF EUT SYSTEM.....	8
2.4 TEST SETUP	9
3.TEST AND MEASUREMENT EQUIPMENT	10
4. OUTPUT POWER.....	11
4.1 OUTPUT POWER MEASUREMENT	11
4.2 LTE BAND 2.....	13
4.3 LTE BAND 4.....	19
4.4 LTE BAND 5.....	25
4.5 LTE BAND 7.....	29
5. OCCUPIED BANDWIDTH	33
5.1 LTE BAND 2.....	36
5.2 LTE BAND 4.....	42
5.3 LTE BAND 5.....	48
5.4 LTE BAND 7.....	52

6. BANDEDGE AND EMISSION MASK	56
6.1 LTE BAND 2.....	57
6.2 LTE BAND 4.....	81
6.3 LTE BAND 5.....	105
6.4 LTE BAND 7.....	121
7. OUT OF BAND EMISSIONS	137
7.1 MEASUREMENT METHOD	137
7.1 LTE BAND 2.....	138
7.2 LTE BAND 4.....	162
7.3 LTE BAND 5.....	186
7.4 LTE BAND 7.....	202
8. RADIATED MEASUREMENT	218
8.1. RADIATED POWER (ERP & EIRP).....	218
8.2 LTE BAND 2.....	219
8.3 LTE BAND 4.....	223
8.4 LTE BAND 5.....	227
8.5 LTE BAND 7.....	229
9. SPURIOUS RADIATION EMISSION	231
9.1 LTE BAND 2.....	233
9.2 LTE BAND 4.....	234
9.3 LTE BAND 5.....	235
9.4 LTE BAND 7.....	236
10. FREQUENCY STABILITY	237
10.1 LTE BAND 2	238
10.2 LTE BAND 4	240
10.3 LTE BAND 5	242
10.4 LTE BAND 7	244
11. PEAK-TO-AVERAGE RATIO	246

11.1 Description of the PAR Measurement 246

11.2 Measuring Instruments 246

11.3 Test Procedures 246

11.4 Test Setup 246

11.5 LTE BAND 2 249

11.6 LTE BAND 4 255

11.7 LTE BAND 5 261

11.8 LTE BAND 7 265

1. GENERAL INFORMATION

1.1 PRODUCT DESCRIPTION

A major technical description of EUT is described as following:

Product Designation:	Mobile phone
Trade Mark	Bmobile
Model Name	AX1080
FCC ID:	ZSW-30-085
Frequency Bands:	U.S. Bands: <input checked="" type="checkbox"/> LTE FDD Band 2,4,5,7
Frequency Range:	LTE FDD Band 2 Uplink: 1850MHz-1910MHz, Downlink: 1930MHz-1990MHz; LTE FDD Band 4 Uplink: 1710MHz-1755MHz, Downlink: 2110MHz-2155MHz; LTE FDD Band 5 Uplink: 824MHz-849MHz, Downlink: 869MHz-894MHz; LTE FDD Band 7 Uplink: 2500MHz-2570MHz, Downlink: 2620MHz-2690MHz;
Type of Modulation:	QPSK/16QAM
Antenna:	PIFA Antenna
Antenna gain:	-1dBi
Power Supply:	DC 3.8V from Battery or DC 5V from USB port
Battery parameter:	DC 3.8V/2000mAh
Adapter:	Input: 100-240V~50-60Hz 0.2A Output: 5V---1A
Extreme Vol. Limits:	DC 3.2V to DC 4.3V (Nominal DC 3.8V) _{Note}
HW Version	S130TF_MMI_V00
SW Version	Bmobile_AX1080_OM_V005_20190514
** Note: The High Voltage DC 4.3V and Low Voltage 3.2V was declared by manufacturer, The EUT couldn't be operate normally with higher or lower voltage.	

1.2 RELATED SUBMITTAL(S) / GRANT (S)

This submittal(s) (test report) is intended for **FCC ID: ZSW-30-085** filing to comply with the FCC Part 22H&24E &27.

1.3 TEST METHODOLOGY

The tests documented in this report were performed in accordance with ANSI/TIA-603-E-2016, FCC CFR 47 Part 2, Part 22, Part 24, Part 27, ANSI C63.26:2015.

1.4 TEST FACILITY

The test site used to collect the radiated data is located at:

ShenZhen NTEK Testing Technology Co., Ltd.

1/F, Building E, Fenda Science Park, Sanwei Community, Xixiang Street, Bao'an District, Shenzhen 518126 P.R.China.

The test site is constructed and calibrated to meet the FCC requirements in documents ANSI C63.26:2015& ANSI C63.4: 2014.

FCC Registration No.:463705

IC Registration No.:9270A-1,

CNAS Registration No.:L5516

MEASUREMENT UNCERTAINTY

The reported uncertainty of measurement, where expended uncertainty U is based on a standard uncertainty multiplied by a coverage factor of k=2, providing a level of confidence of approximately 95 %.

No.	Item	Uncertainty
1	Measuring Uncertainty for a Level of Confidence of 95% (U = 2Uc(y))	2.5dB

1.5 SPECIAL ACCESSORIES

The battery and the charger, earphone supplied by the applicant were used as accessories and being tested with EUT intended for FCC grant together.

1.6 WORST-CASE CONFIGURATION AND MODE

The worst-case scenario for all measurements is based on the investigation results.

The device has LTE Bands of: Band 2, Band 4, Band 5, Band 7.

The RB Size was selected to measure for peak or average ERP and EIRP, which was based on the conducted power verification baseline data.

For the fundamental investigation of radiated emissions, the EUT is investigated for vertical and horizontal antenna orientations and X Y and Z orientations of the EUT alone. After the investigations the worst case was determined to be at X orientation for all LTE bands.

2. SYSTEM TEST CONFIGURATION

2.1 EUT CONFIGURATION

The EUT configuration for testing is installed on RF field strength measurement to meet the Commission’s requirement and operating in a manner which intends to maximize its emission characteristics in a continuous normal application.

2.2 EUT EXERCISE

The Transmitter was operated in the maximum output power mode through Communication Tester. The TX frequency was fixed which was for the purpose of the measurements.

2.3 CONFIGURATION OF EUT SYSTEM

Table 2-1 Equipment Used in EUT System

Item	Equipment	Model No.	ID or Specification	Note
1	Mobile phone	AX1080	FCC ID: ZSW-30-085	EUT

*Note: All the accessories have been used during the test.
the following “EUT” in setup diagram means EUT system.*

2.4 TEST SETUP

CONDUCTED SETUP DIAGRAM FOR TESTS

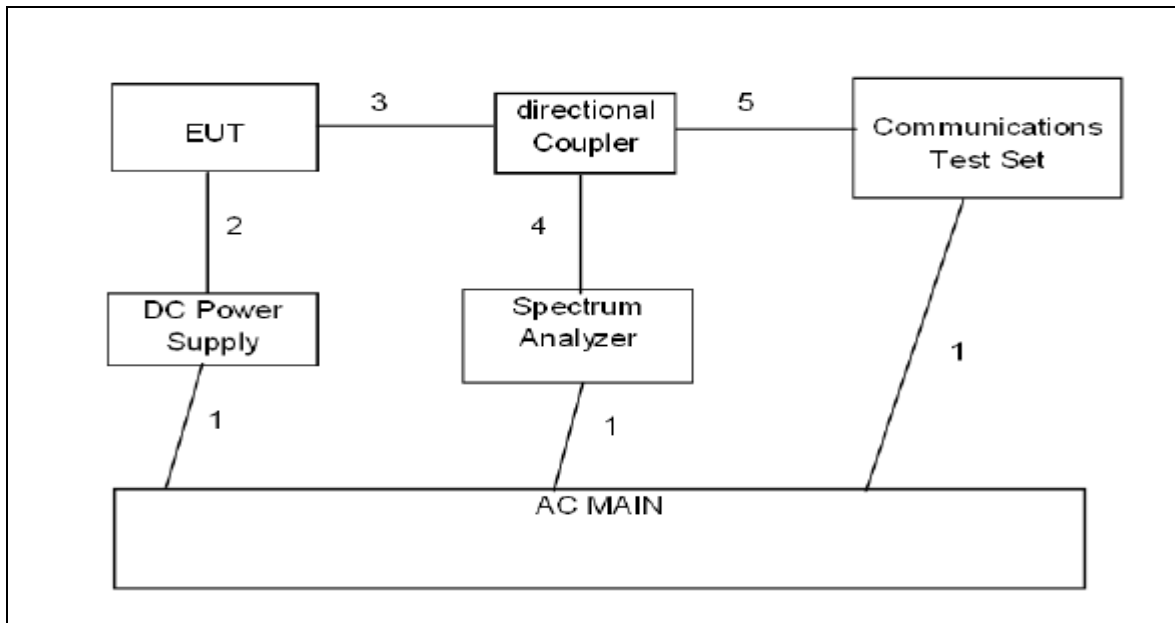

RADIATED SETUP DIAGRAM FOR TESTS

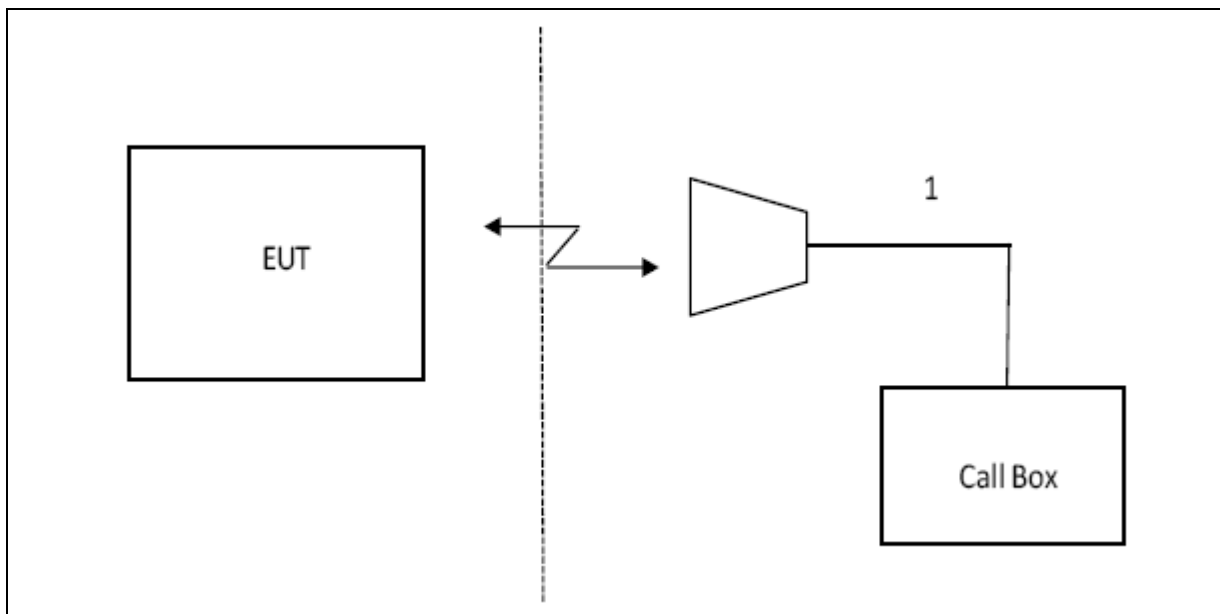

3. TEST AND MEASUREMENT EQUIPMENT

The following test and measurement equipment was utilized for the tests documented in this report:

NAME OF EQUIPMENT	MANUFACTURER	MODEL	SERIAL NUMBER	NEXT CAL. DATE
SPECTRUM ANALYZER	AGILENT	N9020A	MY49100060	2019.10.07
TEST RECEIVER	R&S	ESCI	101318	2019.05.18
COMMUNICATION TESTER	R&S	CMU200	117858	2019.05.18
COMMUNICATION TESTER	R&S	CMW500	148500	2019.05.18
TEST RECEIVER	R&S	FCKL1528	A0304230	2019.05.18
LISN	SCHWARZBECK	NSLK8127	A0304233	2019.05.18
CLIMATE CHAMBER	ALBATROSS	--	--	2019.05.18
Loop Antenna	Daze	ZN30900N	SEL0097	2019.05.18
Biological Antenna	A.H. Systems Inc.	SAS-521-4	N/A	2019.05.18
Horn Antenna	EM	EM-AH-10180	2011071402	2019.05.18
Broadband Horn Antenna	SCHWARZBECK	BBHA 9170	803	2019.11.02
DC Power Source	N/A	PS-6005D	20170402923	2019.05.18

4. OUTPUT POWER

4.1 OUTPUT POWER MEASUREMENT

LTE Measurement Procedure:

All LTE bands conducted power peak and average are obtained from the CMW500 telecommunication test set. The following tests were conducted according to the test requirements outlined in section 6.2 of the 3GPP TS36.101 specification.

UE Power Class: 3 (23 +/- 2dBm). The allowed Maximum Power Reduction (MPR) for the maximum output power due to higher order modulation and transmit bandwidth configuration (resource blocks) is specified in Table 6.2.3-1 of the 3GPP TS36.101.

Table 6.2.3-1: Maximum Power Reduction (MPR) for Power Class 3

Modulation	Channel bandwidth / Transmission bandwidth (RB)						MPR (dB)
	1.4 MHz	3.0 MHz	5 MHz	10 MHz	15 MHz	20 MHz	
QPSK	> 5	> 4	> 8	> 12	> 16	> 18	≤ 1
16 QAM	≤ 5	≤ 4	≤ 8	≤ 12	≤ 16	≤ 18	≤ 1
16 QAM	> 5	> 4	> 8	> 12	> 16	> 18	≤ 2

The allowed A-MPR values specified below in Table 6.2.4.-1 of 3GPP TS36.101 are in addition to the allowed MPR requirements. All the measurements below were performed with A-MPR disabled, by using Network Signaling Value of "NS_01".3

Table 6.2.4-1: Additional Maximum Power Reduction (A-MPR)

Network Signalling value	Requirements (sub-clause)	E-UTRA Band	Channel bandwidth (MHz)	Resources Blocks (N_{RB})	A-MPR (dB)
NS_01	6.6.2.1.1	Table 5.5-1	1.4, 3, 5, 10, 15, 20	Table 5.6-1	NA
NS_03	6.6.2.2.1	2, 4, 10, 23, 25, 35, 36	3	>5	≤ 1
			5	>6	≤ 1
			10	>6	≤ 1
			15	>8	≤ 1
			20	>10	≤ 1
NS_04	6.6.2.2.2	41	5	>6	≤ 1
			10, 15, 20	See Table 6.2.4-4	
NS_05	6.6.3.3.1	1	10, 15, 20	≥ 50	≤ 1
NS_06	6.6.2.2.3	12, 13, 14, 17	1.4, 3, 5, 10	Table 5.6-1	n/a
NS_07	6.6.2.2.3	13	10	Table 6.2.4-2	Table 6.2.4-2
	6.6.3.3.2				
NS_08	6.6.3.3.3	19	10, 15	> 44	≤ 3
NS_09	6.6.3.3.4	21	10, 15	> 40	≤ 1
				> 55	≤ 2
NS_10		20	15, 20	Table 6.2.4-3	Table 6.2.4-3
NS_11	6.6.2.2.1	23 ¹	1.4, 3, 5, 10	Table 6.2.4-5	Table 6.2.4-5
..					
NS_32	-	-	-	-	-

Note 1: Applies to the lower block of Band 23, i.e. a carrier placed in the 2000-2010 MHz region.

4.2 LTE BAND 2

OUTPUT POWER FOR LTE BAND 2 (1.4MHZ)

Band	Band Width	Channel	Frequency (MHz)	Modulation	RB Configuration		Average Power(dBm)	Peak Power(dBm)
					RB Size	RB Offset		
Band 2	1.4MHz	18607	1850.7	QPSK	1	Low	22.26	27.21
					1	Mid	22.45	27.23
					1	High	22.22	27.15
					3	Low	22.34	27.50
					3	High	22.33	27.46
					6	Low	21.67	27.05
				16QAM	1	Low	21.64	26.31
					1	Mid	21.71	26.60
					1	High	21.70	26.29
					3	Low	21.69	27.58
					3	High	21.75	27.50
					6	Low	20.33	27.25
	1.4MHz	18900	1880.0	QPSK	1	Low	22.41	27.05
					1	Mid	22.40	27.35
					1	High	22.42	26.97
					3	Low	22.58	27.38
					3	High	22.46	27.42
					6	Low	20.89	27.02
				16QAM	1	Low	20.87	26.51
					1	Mid	20.85	26.84
					1	High	20.81	26.48
					3	Low	20.82	27.01
					3	High	20.71	27.09
					6	Low	20.01	27.00
	1.4MHz	19193	1909.3	QPSK	1	Low	22.21	25.94
					1	Mid	22.23	25.97
					1	High	22.26	25.75
3					Low	22.23	26.44	
3					High	22.21	26.35	
6					Low	20.85	26.23	
16QAM				1	Low	20.84	25.53	
				1	Mid	20.87	25.64	
				1	High	20.89	25.35	
				3	Low	20.83	26.40	
				3	High	20.84	26.32	
				6	Low	20.09	26.25	

OUTPUT POWER FOR LTE BAND 2 (3.0MHZ)

Band	Band Width	Channel	Frequency (MHz)	Modulation	RB Configuration		Average Power(dBm)	Peak Power(dBm)
					RB Size	RB Offset		
Band 2	3.0 MHz	18615	1851.5	QPSK	1	Low	21.96	26.83
					1	Mid	21.93	26.82
					1	High	21.98	26.72
					8	Low	20.98	26.95
					8	High	20.97	27.00
					15	Low	20.96	27.25
				16QAM	1	Low	21.75	27.39
					1	Mid	21.58	27.28
					1	High	21.54	27.35
					8	Low	20.38	27.13
					8	High	20.32	27.19
					15	Low	20.27	27.28
	3.0 MHz	18900	1880.0	QPSK	1	Low	21.43	26.60
					1	Mid	21.37	26.66
					1	High	21.32	26.54
					8	Low	20.44	26.88
					8	High	20.35	26.99
					15	Low	20.41	27.23
				16QAM	1	Low	20.52	26.01
					1	Mid	20.39	26.04
					1	High	20.36	25.93
					8	Low	19.48	26.51
					8	High	19.41	26.10
					15	Low	19.47	26.68
	3.0 MHz	19185	1908.5	QPSK	1	Low	20.96	26.09
					1	Mid	21.24	26.03
					1	High	20.78	25.72
8					Low	20.27	26.36	
8					High	20.24	26.18	
15					Low	20.28	26.41	
16QAM				1	Low	20.39	25.41	
				1	Mid	20.36	25.37	
				1	High	20.36	25.18	
				8	Low	19.23	25.95	
				8	High	19.21	25.91	
				15	Low	19.22	25.89	

OUTPUT POWER FOR LTE BAND 2 (5.0MHZ)

Band	Band Width	Channel	Frequency (MHz)	Modulation	RB Configuration		Average Power(dBm)	Peak Power(dBm)
					RB Size	RB Offset		
Band 2	5.0 MHz	18625	1852.5	QPSK	1	Low	21.98	27.37
					1	Mid	21.96	27.34
					1	High	21.87	27.27
					12	Low	20.98	27.04
					12	High	20.94	26.92
					25	Low	21.00	27.58
				16QAM	1	Low	20.98	26.65
					1	Mid	20.96	26.66
					1	High	20.79	26.51
					12	Low	19.98	27.28
					12	High	19.93	27.30
					25	Low	19.96	27.67
	5.0 MHz	18900	1880.0	QPSK	1	Low	21.34	26.75
					1	Mid	21.41	26.89
					1	High	21.17	26.66
					12	Low	20.46	26.71
					12	High	20.42	26.62
					25	Low	20.43	27.04
				16QAM	1	Low	20.48	26.88
					1	Mid	20.50	26.98
					1	High	20.34	26.79
					12	Low	19.45	26.59
					12	High	19.39	26.71
					25	Low	19.51	27.56
	5.0 MHz	19175	1907.5	QPSK	1	Low	20.82	26.02
					1	Mid	20.84	25.96
					1	High	20.84	25.67
12					Low	20.28	26.74	
12					High	20.26	26.52	
25					Low	20.31	26.98	
16QAM				1	Low	20.49	26.19	
				1	Mid	20.60	26.13	
				1	High	20.44	25.81	
				12	Low	19.36	26.23	
				12	High	19.35	26.11	
				25	Low	19.29	26.50	

OUTPUT POWER FOR LTE BAND 2 (10.0MHZ)

Band	Band Width	Channel	Frequency (MHz)	Modulation	RB Configuration		Average Power(dBm)	Peak Power(dBm)
					RB Size	RB Offset		
Band 2	10.0 MHz	18650	1855.0	QPSK	1	Low	21.96	26.80
					1	Mid	21.95	26.71
					1	High	21.65	26.47
					25	Low	20.92	27.34
					25	High	20.96	27.18
					50	Low	20.97	27.52
				16QAM	1	Low	21.71	27.32
					1	Mid	21.67	27.31
					1	High	21.34	27.14
					25	Low	20.23	27.31
					25	High	20.11	27.26
					50	Low	20.14	27.76
	10.0 MHz	18900	1880.0	QPSK	1	Low	21.44	26.60
					1	Mid	21.28	26.57
					1	High	21.17	26.49
					25	Low	20.55	27.43
					25	High	20.45	27.40
					50	Low	20.51	27.07
				16QAM	1	Low	20.53	26.05
					1	Mid	20.58	26.20
					1	High	20.23	25.88
					25	Low	19.67	27.15
					25	High	19.60	27.12
					50	Low	19.57	27.55
	10.0 MHz	19150	1905.0	QPSK	1	Low	20.80	26.20
					1	Mid	20.80	26.15
					1	High	20.82	25.94
25					Low	20.43	26.73	
25					High	20.34	26.57	
50					Low	20.42	26.93	
16QAM				1	Low	20.43	25.48	
				1	Mid	20.58	25.64	
				1	High	20.39	25.31	
				25	Low	19.48	26.96	
				25	High	19.41	26.80	
				50	Low	19.44	26.81	

OUTPUT POWER FOR LTE BAND 2 (15.0MHZ)

Band	Band Width	Channel	Frequency (MHz)	Modulation	RB Configuration		Average Power(dBm)	Peak Power(dBm)
					RB Size	RB Offset		
Band 2	15.0 MHz	18675	1857.5	QPSK	1	Low	22.00	26.86
					1	Mid	21.90	26.73
					1	High	21.60	26.51
					36	Low	20.99	27.23
					36	High	20.85	27.14
					75	Low	21.00	27.96
				16QAM	1	Low	20.98	27.37
					1	Mid	20.99	27.34
					1	High	20.96	27.19
					36	Low	19.94	27.54
					36	High	19.90	27.47
					75	Low	19.95	27.55
	15.0 MHz	18900	1880.0	QPSK	1	Low	21.49	26.48
					1	Mid	21.42	26.49
					1	High	21.03	26.17
					36	Low	20.57	27.14
					36	High	20.35	27.08
					75	Low	20.51	27.64
				16QAM	1	Low	21.00	26.27
					1	Mid	20.85	26.22
					1	High	20.50	25.92
					36	Low	19.56	27.26
					36	High	19.37	27.16
					75	Low	19.45	27.28
	15.0 MHz	19125	1902.5	QPSK	1	Low	21.08	26.46
					1	Mid	21.02	26.24
					1	High	21.12	25.94
36					Low	20.35	26.78	
36					High	20.28	26.57	
75					Low	20.36	27.51	
16QAM				1	Low	20.26	25.44	
				1	Mid	20.47	25.51	
				1	High	20.29	25.16	
				36	Low	19.37	27.31	
				36	High	19.35	27.00	
				75	Low	19.35	27.10	

OUTPUT POWER FOR LTE BAND 2 (20.0MHZ)

Band	Band Width	Channel	Frequency (MHz)	Modulation	RB Configuration		Average Power(dBm)	Peak Power(dBm)
					RB Size	RB Offset		
Band 2	20.0 MHz	18700	1860.0	QPSK	1	Low	22.00	26.84
					1	Mid	21.66	26.67
					1	High	20.97	26.34
					50	Low	20.98	27.29
					50	High	20.72	27.19
					100	Low	20.85	27.43
				16QAM	1	Low	20.95	26.94
					1	Mid	20.99	26.91
					1	High	20.84	26.67
					50	Low	20.00	27.64
					50	High	19.76	27.55
					100	Low	19.97	28.14
	20.0 MHz	18900	1880.0	QPSK	1	Low	21.18	26.49
					1	Mid	21.23	26.53
					1	High	20.78	26.32
					50	Low	20.65	27.20
					50	High	20.37	27.16
					100	Low	20.45	27.37
				16QAM	1	Low	20.93	26.45
					1	Mid	20.95	26.57
					1	High	20.46	26.25
					50	Low	19.67	27.31
					50	High	19.35	27.19
					100	Low	19.50	27.54
	20.0 MHz	19100	1900.0	QPSK	1	Low	20.90	26.10
					1	Mid	20.39	25.61
					1	High	20.72	25.45
50					Low	20.30	26.84	
50					High	20.28	26.79	
100					Low	20.29	26.96	
16QAM				1	Low	20.19	26.40	
				1	Mid	20.56	26.31	
				1	High	20.24	25.82	
				50	Low	19.36	26.88	
				50	High	19.31	26.62	
				100	Low	19.34	27.05	

4.3 LTE BAND 4

OUTPUT POWER FOR LTE BAND 4 (1.4MHz)

Band	Band Width	Channel	Frequency (MHz)	Modulation	RB Configuration		Average Power(dBm)	Peak Power(dBm)
					RB Size	RB Offset		
Band 4	1.4MHz	19957	1710.7	QPSK	1	Low	21.15	26.52
					1	Mid	21.45	26.95
					1	High	21.14	26.51
					3	Low	21.26	26.99
					3	High	21.26	27.04
					6	Low	20.27	26.82
				16QAM	1	Low	20.21	26.04
					1	Mid	20.48	26.50
					1	High	20.24	26.08
					3	Low	20.53	26.68
					3	High	20.57	26.69
					6	Low	19.28	26.89
	1.4MHz	20175	1732.5	QPSK	1	Low	21.36	26.23
					1	Mid	21.60	26.52
					1	High	21.38	26.36
					3	Low	21.45	26.98
					3	High	21.51	27.01
					6	Low	20.57	26.38
				16QAM	1	Low	20.43	25.68
					1	Mid	20.60	25.95
					1	High	20.41	25.76
					3	Low	20.59	26.92
					3	High	20.58	26.88
					6	Low	19.39	26.41
	1.4MHz	20393	1754.3	QPSK	1	Low	21.54	26.71
					1	Mid	21.82	26.98
					1	High	21.47	26.65
					3	Low	21.67	27.01
					3	High	21.49	26.91
					6	Low	20.74	26.59
16QAM				1	Low	20.74	25.77	
				1	Mid	21.00	26.12	
				1	High	20.82	25.81	
				3	Low	20.79	27.21	
				3	High	20.86	27.24	
				6	Low	19.76	26.81	

OUTPUT POWER FOR LTE BAND 4 (3.0MHZ)

Band	Band Width	Channel	Frequency (MHz)	Modulation	RB Configuration		Average Power(dBm)	Peak Power(dBm)
					RB Size	RB Offset		
Band 4	3.0 MHz	19965	1711.5	QPSK	1	Low	21.19	26.15
					1	Mid	21.26	26.30
					1	High	21.30	26.27
					8	Low	20.28	26.34
					8	High	20.31	26.26
					15	Low	20.32	26.41
				16QAM	1	Low	20.89	27.08
					1	Mid	20.86	27.03
					1	High	20.95	27.31
					8	Low	19.45	26.31
					8	High	19.48	26.53
					15	Low	19.37	26.85
	3.0 MHz	20175	1732.5	QPSK	1	Low	21.43	26.37
					1	Mid	21.43	26.35
					1	High	21.45	26.35
					8	Low	20.47	26.58
					8	High	20.44	26.68
					15	Low	20.48	27.62
				16QAM	1	Low	20.51	25.85
					1	Mid	20.52	25.89
					1	High	20.47	25.81
					8	Low	19.47	26.17
					8	High	19.50	25.98
					15	Low	19.50	26.75
	3.0 MHz	20385	1753.5	QPSK	1	Low	21.64	26.83
					1	Mid	21.66	26.92
					1	High	21.37	26.67
8					Low	20.72	26.98	
8					High	20.75	26.91	
15					Low	20.74	26.68	
16QAM				1	Low	20.85	25.99	
				1	Mid	20.88	25.98	
				1	High	20.85	25.85	
				8	Low	19.73	26.60	
				8	High	19.72	26.27	
				15	Low	19.72	27.27	

OUTPUT POWER FOR LTE BAND 4 (5.0MHZ)

Band	Band Width	Channel	Frequency (MHz)	Modulation	RB Configuration		Average Power(dBm)	Peak Power(dBm)
					RB Size	RB Offset		
Band 4	5.0 MHz	19975	1712.5	QPSK	1	Low	21.15	26.98
					1	Mid	21.32	27.20
					1	High	21.24	27.07
					12	Low	20.29	26.31
					12	High	20.35	26.23
					25	Low	20.34	26.91
				16QAM	1	Low	20.09	26.02
					1	Mid	20.27	26.21
					1	High	20.14	26.05
					12	Low	19.27	26.63
					12	High	19.36	26.78
					25	Low	19.39	27.05
	5.0 MHz	20175	1732.5	QPSK	1	Low	21.37	26.55
					1	Mid	21.48	26.64
					1	High	21.38	26.56
					12	Low	20.42	26.09
					12	High	20.48	26.32
					25	Low	20.47	26.82
				16QAM	1	Low	20.47	26.53
					1	Mid	20.60	26.65
					1	High	20.49	26.57
					12	Low	19.48	26.33
					12	High	19.48	26.38
					25	Low	19.52	26.67
	5.0 MHz	20375	1752.5	QPSK	1	Low	21.60	26.71
					1	Mid	21.71	26.87
					1	High	21.57	26.66
12					Low	20.71	27.24	
12					High	20.69	27.18	
25					Low	20.73	27.07	
16QAM				1	Low	20.93	26.69	
				1	Mid	21.00	26.80	
				1	High	20.98	26.70	
				12	Low	19.79	26.80	
				12	High	19.75	26.77	
				25	Low	19.73	27.93	

OUTPUT POWER FOR LTE BAND 4 (10.0MHZ)

Band	Band Width	Channel	Frequency (MHz)	Modulation	RB Configuration		Average Power(dBm)	Peak Power(dBm)
					RB Size	RB Offset		
Band 4	10.0 MHz	20000	1715.0	QPSK	1	Low	21.19	26.17
					1	Mid	21.44	26.44
					1	High	21.31	26.24
					25	Low	20.38	26.61
					25	High	20.46	26.76
					50	Low	20.45	26.79
				16QAM	1	Low	20.83	26.92
					1	Mid	20.98	27.13
					1	High	20.94	26.97
					25	Low	19.45	26.75
					25	High	19.51	26.83
					50	Low	19.47	27.21
	10.0 MHz	20175	1732.5	QPSK	1	Low	21.41	26.35
					1	Mid	21.60	26.51
					1	High	21.44	26.54
					25	Low	20.56	26.84
					25	High	20.54	27.05
					50	Low	20.54	26.50
				16QAM	1	Low	20.43	25.78
					1	Mid	20.61	26.06
					1	High	20.48	25.95
					25	Low	19.64	26.81
					25	High	19.61	26.76
					50	Low	19.56	27.33
	10.0 MHz	20350	1750.0	QPSK	1	Low	21.50	26.69
					1	Mid	21.74	26.86
					1	High	21.62	26.81
25					Low	20.71	27.08	
25					High	20.70	27.07	
50					Low	20.74	27.21	
16QAM				1	Low	20.69	25.78	
				1	Mid	20.92	26.07	
				1	High	20.87	25.93	
				25	Low	19.75	27.26	
				25	High	19.75	27.18	
				50	Low	19.73	26.88	

OUTPUT POWER FOR LTE BAND 4 (15.0MHZ)

Band	Band Width	Channel	Frequency (MHz)	Modulation	RB Configuration		Average Power(dBm)	Peak Power(dBm)
					RB Size	RB Offset		
Band 4	15.0 MHz	20025	1717.5	QPSK	1	Low	21.16	26.18
					1	Mid	21.30	26.30
					1	High	21.29	26.16
					36	Low	20.39	26.61
					36	High	20.50	26.68
					75	Low	20.44	27.48
				16QAM	1	Low	20.81	26.92
					1	Mid	20.98	27.05
					1	High	20.88	26.84
					36	Low	19.41	26.93
					36	High	19.51	26.92
					75	Low	19.44	26.92
	15.0 MHz	20175	1732.5	QPSK	1	Low	21.30	26.14
					1	Mid	21.49	26.28
					1	High	21.40	26.19
					36	Low	20.51	26.72
					36	High	20.54	26.69
					75	Low	20.57	27.32
				16QAM	1	Low	20.75	25.91
					1	Mid	20.93	26.06
					1	High	20.84	26.01
					36	Low	19.47	26.82
					36	High	19.51	26.93
					75	Low	19.49	27.00
	15.0 MHz	20325	1747.5	QPSK	1	Low	21.40	26.58
					1	Mid	21.62	26.79
					1	High	21.60	26.80
36					Low	20.68	26.90	
36					High	20.62	27.02	
75					Low	20.70	27.62	
16QAM				1	Low	20.58	25.68	
				1	Mid	20.83	25.91	
				1	High	20.81	25.89	
				36	Low	19.70	27.37	
				36	High	19.67	27.51	
				75	Low	19.66	27.34	

OUTPUT POWER FOR LTE BAND 4 (20.0MHZ)

Band	Band Width	Channel	Frequency (MHz)	Modulation	RB Configuration		Average Power(dBm)	Peak Power(dBm)
					RB Size	RB Offset		
Band 4	20.0 MHz	20050	1720.0	QPSK	1	Low	21.02	26.43
					1	Mid	21.51	26.66
					1	High	21.19	26.37
					50	Low	20.37	26.80
					50	High	20.47	26.69
					100	Low	20.43	26.92
				16QAM	1	Low	20.41	26.37
					1	Mid	20.85	26.62
					1	High	20.53	26.30
					50	Low	19.36	27.18
					50	High	19.48	27.13
					100	Low	19.44	27.77
	20.0 MHz	20175	1732.5	QPSK	1	Low	21.10	26.43
					1	Mid	21.56	26.56
					1	High	21.24	26.54
					50	Low	20.49	26.70
					50	High	20.45	26.74
					100	Low	20.43	27.13
				16QAM	1	Low	20.71	26.31
					1	Mid	20.92	26.53
					1	High	20.90	26.53
					50	Low	19.49	26.75
					50	High	19.46	26.99
					100	Low	19.46	27.07
	20.0 MHz	20300	1745.0	QPSK	1	Low	21.21	26.29
					1	Mid	21.80	26.63
					1	High	21.50	26.62
50					Low	20.64	26.96	
50					High	20.55	27.01	
100					Low	20.62	27.35	
16QAM				1	Low	20.50	26.77	
				1	Mid	20.99	27.07	
				1	High	20.75	27.11	
				50	Low	19.63	27.06	
				50	High	19.53	27.03	
				100	Low	19.60	27.31	

4.4 LTE BAND 5

OUTPUT POWER FOR LTE BAND 5 (1.4MHZ)

Band	Band Width	Channel	Frequency (MHz)	Modulation	RB Configuration		Average Power(dBm)	Peak Power(dBm)
					RB Size	RB Offset		
Band 5	1.4MHz	20407	824.7	QPSK	1	Low	20.87	26.48
					1	Mid	20.96	26.73
					1	High	20.92	26.56
					3	Low	20.93	26.79
					3	High	20.91	26.85
					6	Low	19.98	25.86
				16QAM	1	Low	20.00	25.18
					1	Mid	20.21	25.45
					1	High	20.01	25.20
					3	Low	19.98	26.86
					3	High	19.96	26.95
					6	Low	19.00	26.10
	1.4MHz	20525	836.5	QPSK	1	Low	20.89	27.10
					1	Mid	20.97	27.16
					1	High	20.51	26.71
					3	Low	20.78	27.13
					3	High	20.68	27.05
					6	Low	19.99	26.73
				16QAM	1	Low	20.15	26.50
					1	Mid	20.36	26.68
					1	High	20.14	26.50
					3	Low	20.42	27.02
					3	High	20.38	26.96
					6	Low	19.22	27.02
	1.4MHz	20643	848.3	QPSK	1	Low	20.62	26.09
					1	Mid	20.80	26.23
					1	High	20.56	26.00
3					Low	20.68	26.85	
3					High	20.68	26.84	
6					Low	19.70	25.79	
16QAM				1	Low	19.65	25.29	
				1	Mid	19.87	25.56	
				1	High	19.67	25.21	
				3	Low	19.85	26.65	
				3	High	19.83	26.70	
				6	Low	18.64	25.94	

OUTPUT POWER FOR LTE BAND 5 (3.0MHZ)

Band	Band Width	Channel	Frequency (MHz)	Modulation	RB Configuration		Average Power(dBm)	Peak Power(dBm)
					RB Size	RB Offset		
Band 5	3.0 MHz	20415	825.5	QPSK	1	Low	20.90	26.15
					1	Mid	20.86	26.20
					1	High	20.88	26.29
					8	Low	19.96	26.29
					8	High	19.95	26.24
					15	Low	19.95	26.69
				16QAM	1	Low	20.54	27.22
					1	Mid	20.53	27.19
					1	High	20.57	27.33
					8	Low	18.97	26.33
					8	High	18.93	26.33
					15	Low	18.98	26.46
	3.0 MHz	20525	836.5	QPSK	1	Low	20.98	26.64
					1	Mid	20.99	26.64
					1	High	20.34	25.98
					8	Low	19.98	26.88
					8	High	19.93	26.85
					15	Low	19.99	26.91
				16QAM	1	Low	20.23	25.93
					1	Mid	20.18	25.90
					1	High	20.12	25.81
					8	Low	19.00	25.84
					8	High	18.97	26.12
					15	Low	18.95	26.54
	3.0 MHz	20635	847.5	QPSK	1	Low	20.75	26.46
					1	Mid	20.65	26.33
					1	High	20.60	26.28
8					Low	19.73	26.13	
8					High	19.69	26.14	
15					Low	19.71	26.08	
16QAM				1	Low	19.95	25.14	
				1	Mid	19.83	25.05	
				1	High	19.83	25.00	
				8	Low	18.71	25.69	
				8	High	18.61	25.28	
				15	Low	18.64	26.36	

OUTPUT POWER FOR LTE BAND 5 (5.0MHZ)

Band	Band Width	Channel	Frequency (MHz)	Modulation	RB Configuration		Average Power(dBm)	Peak Power(dBm)
					RB Size	RB Offset		
Band 5	5.0 MHz	20425	826.5	QPSK	1	Low	20.85	27.28
					1	Mid	21.00	27.49
					1	High	20.94	27.62
					12	Low	19.95	26.34
					12	High	19.98	26.08
					25	Low	19.99	26.65
				16QAM	1	Low	19.79	25.92
					1	Mid	19.94	26.13
					1	High	19.90	26.16
					12	Low	18.96	26.77
					12	High	18.96	26.85
					25	Low	19.00	26.91
	5.0 MHz	20525	836.5	QPSK	1	Low	20.99	27.01
					1	Mid	20.68	26.67
					1	High	20.49	26.45
					12	Low	19.98	26.52
					12	High	19.96	26.40
					25	Low	19.97	26.51
				16QAM	1	Low	19.97	27.07
					1	Mid	19.86	27.14
					1	High	19.95	26.95
					12	Low	18.85	26.41
					12	High	18.97	26.56
					25	Low	18.99	27.53
	5.0 MHz	20625	846.5	QPSK	1	Low	20.80	26.38
					1	Mid	20.78	26.41
					1	High	20.58	26.19
12					Low	19.86	26.85	
12					High	19.70	26.67	
25					Low	19.80	26.84	
16QAM				1	Low	19.99	26.25	
				1	Mid	19.97	26.25	
				1	High	19.93	26.01	
				12	Low	18.89	25.92	
				12	High	18.75	25.74	
				25	Low	18.76	26.47	

OUTPUT POWER FOR LTE BAND 5 (10.0MHZ)

Band	Band Width	Channel	Frequency (MHz)	Modulation	RB Configuration		Average Power(dBm)	Peak Power(dBm)
					RB Size	RB Offset		
Band 5	10.0 MHz	20450	829.0	QPSK	1	Low	20.91	26.16
					1	Mid	20.98	26.66
					1	High	20.96	26.49
					25	Low	20.17	26.85
					25	High	20.14	26.97
					50	Low	20.15	26.63
				16QAM	1	Low	20.53	27.13
					1	Mid	20.73	27.67
					1	High	20.72	27.61
					25	Low	19.23	26.85
					25	High	19.19	26.94
					50	Low	19.20	27.29
	10.0 MHz	20525	836.5	QPSK	1	Low	21.00	26.73
					1	Mid	20.62	26.27
					1	High	20.75	26.27
					25	Low	20.20	27.59
					25	High	20.22	27.37
					50	Low	20.23	26.90
				16QAM	1	Low	20.19	25.98
					1	Mid	20.29	26.03
					1	High	19.99	25.69
					25	Low	19.35	27.14
					25	High	19.26	26.94
					50	Low	19.27	27.44
	10.0 MHz	20600	844.0	QPSK	1	Low	20.73	26.50
					1	Mid	20.96	26.68
					1	High	20.63	26.38
					25	Low	19.99	26.52
					25	High	19.80	26.35
					50	Low	19.92	26.35
16QAM				1	Low	20.12	25.36	
				1	Mid	20.16	25.47	
				1	High	19.82	25.03	
				25	Low	19.02	26.94	
				25	High	18.80	26.50	
				50	Low	18.91	26.41	

4.5 LTE BAND 7

OUTPUT POWER FOR LTE BAND 7 (5.0MHZ)

Band	Band Width	Channel	Frequency (MHz)	Modulation	RB Configuration		Average Power(dBm)	Peak Power(dBm)
					RB Size	RB Offset		
Band 7	5.0MHz	20775	2502.5	QPSK	1	Low	21.76	26.21
					1	Mid	21.82	26.17
					1	High	21.70	26.10
					12	Low	20.78	26.71
					12	High	20.78	26.86
					25	Low	20.80	26.85
				16QAM	1	Low	20.97	26.10
					1	Mid	20.96	26.17
					1	High	20.93	26.15
					12	Low	19.78	26.25
					12	High	19.81	26.51
					25	Low	19.73	27.65
	5.0MHz	21100	2535.0	QPSK	1	Low	21.44	26.40
					1	Mid	21.49	26.30
					1	High	21.42	26.17
					12	Low	20.45	26.22
					12	High	20.46	26.26
					25	Low	20.46	26.75
				16QAM	1	Low	20.28	25.93
					1	Mid	20.41	25.99
					1	High	20.30	25.85
					12	Low	19.47	26.48
					12	High	19.53	26.42
					25	Low	19.54	26.53
	5.0MHz	21425	2567.5	QPSK	1	Low	21.88	26.33
					1	Mid	22.00	26.07
					1	High	21.96	25.87
12					Low	20.80	26.39	
12					High	20.98	26.21	
25					Low	20.93	26.81	
16QAM				1	Low	20.94	25.89	
				1	Mid	20.89	25.58	
				1	High	20.87	25.38	
				12	Low	19.98	26.43	
				12	High	19.93	26.31	
				25	Low	20.00	26.76	

OUTPUT POWER FOR LTE BAND 7 (10.0MHZ)

Band	Band Width	Channel	Frequency (MHz)	Modulation	RB Configuration		Average Power(dBm)	Peak Power(dBm)
					RB Size	RB Offset		
Band 7	10.0 MHz	20800	2505.0	QPSK	1	Low	21.85	25.81
					1	Mid	21.94	25.89
					1	High	21.58	25.94
					25	Low	20.78	26.46
					25	High	20.78	26.65
					50	Low	20.82	26.91
				16QAM	1	Low	20.97	26.11
					1	Mid	20.98	26.19
					1	High	20.95	26.34
					25	Low	19.79	26.39
					25	High	19.84	26.47
					50	Low	19.75	27.18
	10.0 MHz	21100	2535.0	QPSK	1	Low	21.52	26.07
					1	Mid	21.71	25.90
					1	High	21.49	25.75
					25	Low	20.49	26.65
					25	High	20.59	26.51
					50	Low	20.57	26.45
				16QAM	1	Low	20.49	25.74
					1	Mid	20.64	25.72
					1	High	20.50	25.57
					25	Low	19.60	26.54
					25	High	19.69	26.49
					50	Low	19.62	27.07
	10.0 MHz	21400	2565.0	QPSK	1	Low	21.85	26.45
					1	Mid	21.82	26.11
					1	High	21.84	25.80
25					Low	20.96	26.80	
25					High	20.98	26.48	
50					Low	21.00	26.88	
16QAM				1	Low	20.94	25.67	
				1	Mid	20.95	25.71	
				1	High	20.93	25.41	
				25	Low	19.96	26.90	
				25	High	19.97	26.61	
				50	Low	19.85	26.86	

OUTPUT POWER FOR LTE BAND 7 (15.0MHZ)

Band	Band Width	Channel	Frequency (MHz)	Modulation	RB Configuration		Average Power(dBm)	Peak Power(dBm)
					RB Size	RB Offset		
Band 7	15.0 MHz	20825	2507.5	QPSK	1	Low	21.77	25.84
					1	Mid	21.65	25.86
					1	High	21.39	25.98
					36	Low	20.77	26.45
					36	High	20.62	26.49
					75	Low	20.70	27.48
				16QAM	1	Low	20.96	26.16
					1	Mid	20.93	26.27
					1	High	20.94	26.46
					36	Low	19.78	26.73
					36	High	19.66	26.72
					75	Low	19.67	26.62
	15.0 MHz	21100	2535.0	QPSK	1	Low	21.52	25.98
					1	Mid	21.50	25.65
					1	High	21.43	25.59
					36	Low	20.54	26.60
					36	High	20.61	26.46
					75	Low	20.62	27.09
				16QAM	1	Low	20.86	25.91
					1	Mid	20.89	25.77
					1	High	20.90	25.68
					36	Low	19.54	26.72
					36	High	19.56	26.50
					75	Low	19.56	26.86
	15.0 MHz	21375	2562.5	QPSK	1	Low	21.65	26.34
					1	Mid	21.93	26.42
					1	High	21.97	25.73
36					Low	20.94	26.85	
36					High	20.96	26.67	
75					Low	20.95	27.49	
16QAM				1	Low	20.94	25.59	
				1	Mid	20.99	25.66	
				1	High	20.94	25.40	
				36	Low	19.96	27.14	
				36	High	19.87	26.85	
				75	Low	19.95	27.22	

OUTPUT POWER FOR LTE BAND 7 (20.0MHZ)

Band	Band Width	Channel	Frequency (MHz)	Modulation	RB Configuration		Average Power(dBm)	Peak Power(dBm)
					RB Size	RB Offset		
Band 7	20.0 MHz	20850	2510.0	QPSK	1	Low	21.64	25.84
					1	Mid	21.73	26.09
					1	High	21.22	26.08
					50	Low	20.64	26.52
					50	High	20.58	26.62
					100	Low	20.61	26.86
				16QAM	1	Low	20.88	25.80
					1	Mid	20.91	26.05
					1	High	20.53	26.15
					50	Low	19.63	26.78
					50	High	19.53	26.82
					100	Low	19.65	27.32
	20.0 MHz	21100	2535.0	QPSK	1	Low	21.38	26.22
					1	Mid	21.56	25.83
					1	High	21.27	25.54
					50	Low	20.54	26.56
					50	High	20.62	26.38
					100	Low	20.57	26.92
				16QAM	1	Low	20.93	26.07
					1	Mid	20.94	25.82
					1	High	20.83	25.69
					50	Low	19.52	26.64
					50	High	19.60	26.44
					100	Low	19.62	27.00
	20.0 MHz	21350	2560.0	QPSK	1	Low	21.46	25.82
					1	Mid	21.89	26.23
					1	High	21.80	25.64
50					Low	20.88	26.79	
50					High	20.92	26.67	
100					Low	20.94	27.26	
16QAM				1	Low	20.66	25.91	
				1	Mid	20.95	26.27	
				1	High	20.98	25.63	
				50	Low	19.89	26.84	
				50	High	19.96	26.67	
				100	Low	19.98	27.18	

5. OCCUPIED BANDWIDTH

RULE PART(S)

FCC: §2.1049

LIMITS

For reporting purposes only

TEST PROCEDURE

The transmitter output was connected to a calibrated coaxial cable and coupler, the other end of which was connected to a spectrum analyzer. The occupied bandwidth was measured with the spectrum analyzer at the low, middle and high channel in each band. The -26dB bandwidth was also measured and recorded.

MODES TESTED

- LTE Band 2
- LTE Band 4
- LTE Band 5
- LTE Band 7

RESULTS

PASS

Test results:

Band	Mode	RB Size/RB Offset	Frequency (MHz)	99% Occupied Bandwidth (MHz)	-26dBc Occupied Bandwidth (MHz)
LTE Band 2	1.4MHz BAND QPSK	6/0	1880.0	1.08	1.25
	1.4MHz BAND 16QAM	6/0	1880.0	1.09	1.24
	3.0MHz BAND QPSK	15/0	1880.0	2.69	2.87
	3.0MHz BAND 16QAM	15/0	1880.0	2.69	2.86
	5.0MHz BAND QPSK	25/0	1880.0	4.49	4.90
	5.0MHz BAND 16QAM	25/0	1880.0	4.49	4.86
	10.0MHz BAND QPSK	50/0	1880.0	8.98	9.55
	10.0MHz BAND 16QAM	50/0	1880.0	8.97	9.55
	15.0MHz BAND QPSK	75/0	1880.0	13.46	14.28
	15.0MHz BAND 16QAM	75/0	1880.0	13.46	14.27
	20.0MHz BAND QPSK	100/0	1880.0	17.96	19.04
20.0MHz BAND 16QAM	100/0	1880.0	17.96	19.04	

Band	Mode	RB Size/RB Offset	Frequency (MHz)	99% Occupied Bandwidth (MHz)	-26dBc Occupied Bandwidth (MHz)
LTE Band 4	1.4MHz BAND QPSK	6/0	1732.5	1.08	1.25
	1.4MHz BAND 16QAM	6/0	1732.5	1.08	1.26
	3.0MHz BAND QPSK	15/0	1732.5	2.69	2.87
	3.0MHz BAND 16QAM	15/0	1732.5	2.69	2.87
	5.0MHz BAND QPSK	25/0	1732.5	4.50	4.93
	5.0MHz BAND 16QAM	25/0	1732.5	4.49	4.86
	10.0MHz BAND QPSK	50/0	1732.5	8.98	9.57
	10.0MHz BAND 16QAM	50/0	1732.5	8.97	9.55
	15.0MHz BAND QPSK	75/0	1732.5	13.46	14.27
	15.0MHz BAND 16QAM	75/0	1732.5	13.46	14.26
	20.0MHz BAND QPSK	100/0	1732.5	17.95	19.03
	20.0MHz BAND 16QAM	100/0	1732.5	17.95	19.03

Band	Mode	RB Size/RB Offset	Frequency (MHz)	99% Occupied Bandwidth (MHz)	-26dBc Occupied Bandwidth (MHz)
LTE Band 5	1.4MHz BAND QPSK	6/0	836.5	1.08	1.25
	1.4MHz BAND 16QAM	6/0	836.5	1.08	1.25
	3.0MHz BAND QPSK	15/0	836.5	2.69	2.87
	3.0MHz BAND 16QAM	15/0	836.5	2.69	2.86
	5.0MHz BAND QPSK	25/0	836.5	4.49	4.90
	5.0MHz BAND 16QAM	25/0	836.5	4.49	4.85
	10.0MHz BAND QPSK	50/0	836.5	8.98	9.54
	10.0MHz BAND 16QAM	50/0	836.5	8.98	9.54

Band	Mode	RB Size/RB Offset	Frequency (MHz)	99% Occupied Bandwidth (MHz)	-26dBc Occupied Bandwidth (MHz)
LTE Band 7	5.0MHz BAND QPSK	25/0	2535.0	4.49	4.90
	5.0MHz BAND 16QAM	25/0	2535.0	4.49	4.85
	10.0MHz BAND QPSK	50/0	2535.0	8.97	9.53
	10.0MHz BAND 16QAM	50/0	2535.0	8.97	9.54
	15.0MHz BAND QPSK	75/0	2535.0	13.45	14.26
	15.0MHz BAND 16QAM	75/0	2535.0	13.46	14.26
	20.0MHz BAND QPSK	100/0	2535.0	17.96	19.03
	20.0MHz BAND 16QAM	100/0	2535.0	17.97	19.03

Note: This test was only measured at maximum RB allocation and at CENTER of band for each LTE BW

5.1 LTE BAND 2

Band 2, UL Channel 18900, UL Frequency 1880.0, BW 1.4, NO. RB 6, RB POS. Low, QPSK

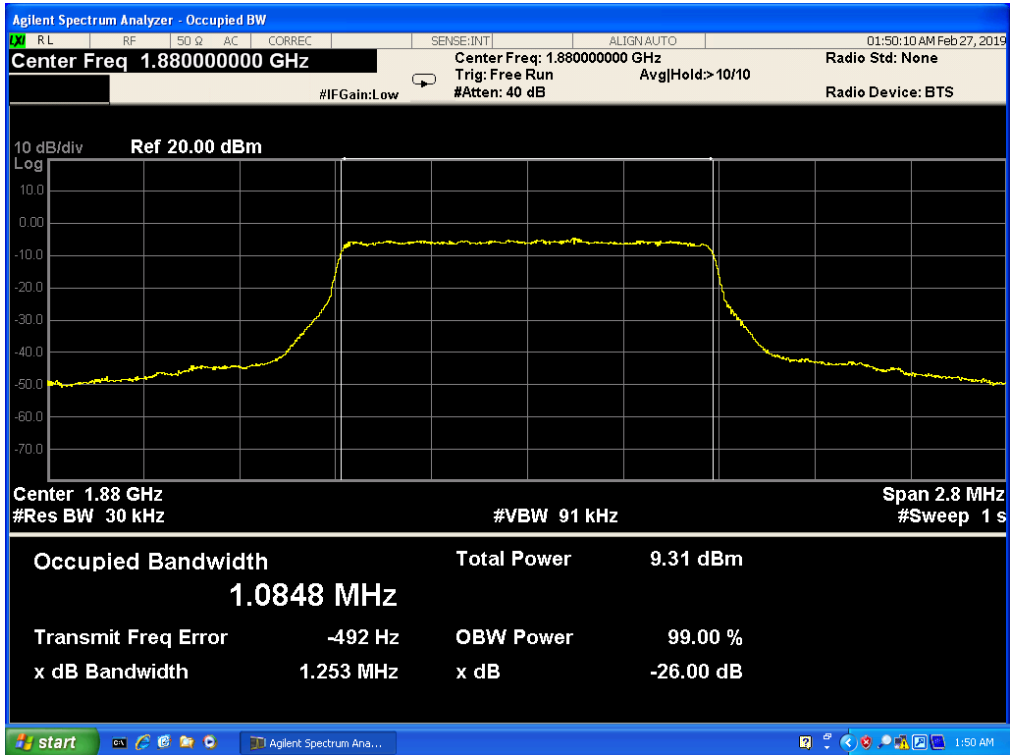

Band 2, UL Channel 18900, UL Frequency 1880.0, BW 1.4, NO. RB 6, RB POS. Low, 16-QAM

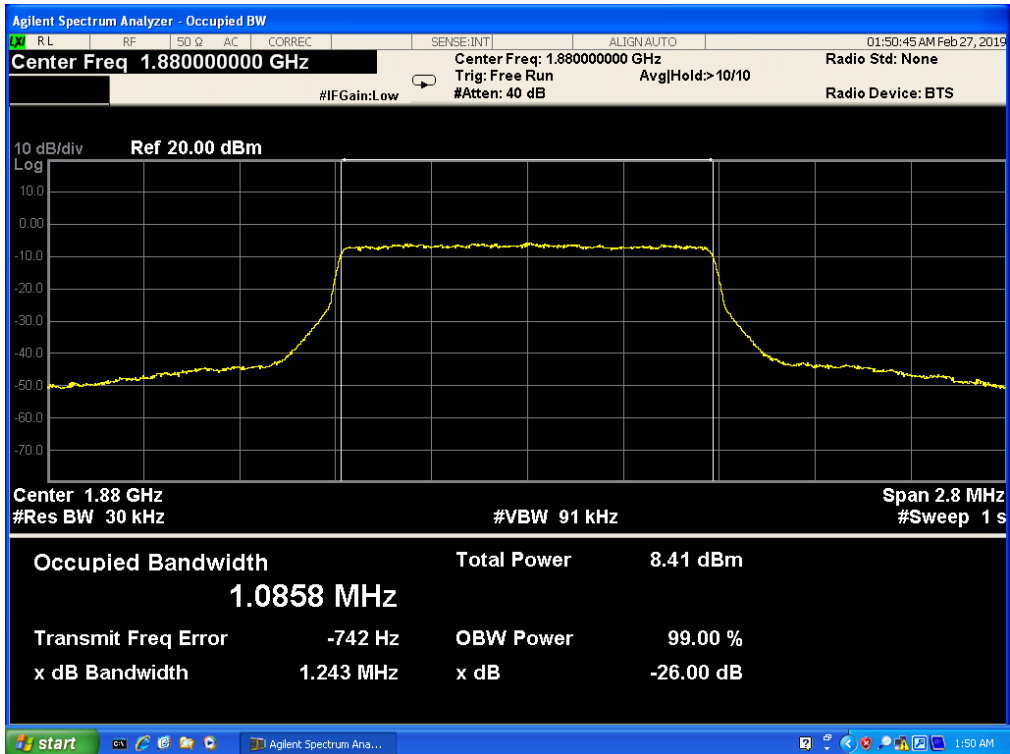

Band 2, UL Channel 18900, UL Frequency 1880.0, BW 3.0, NO. RB 15, RB POS. Low, QPSK

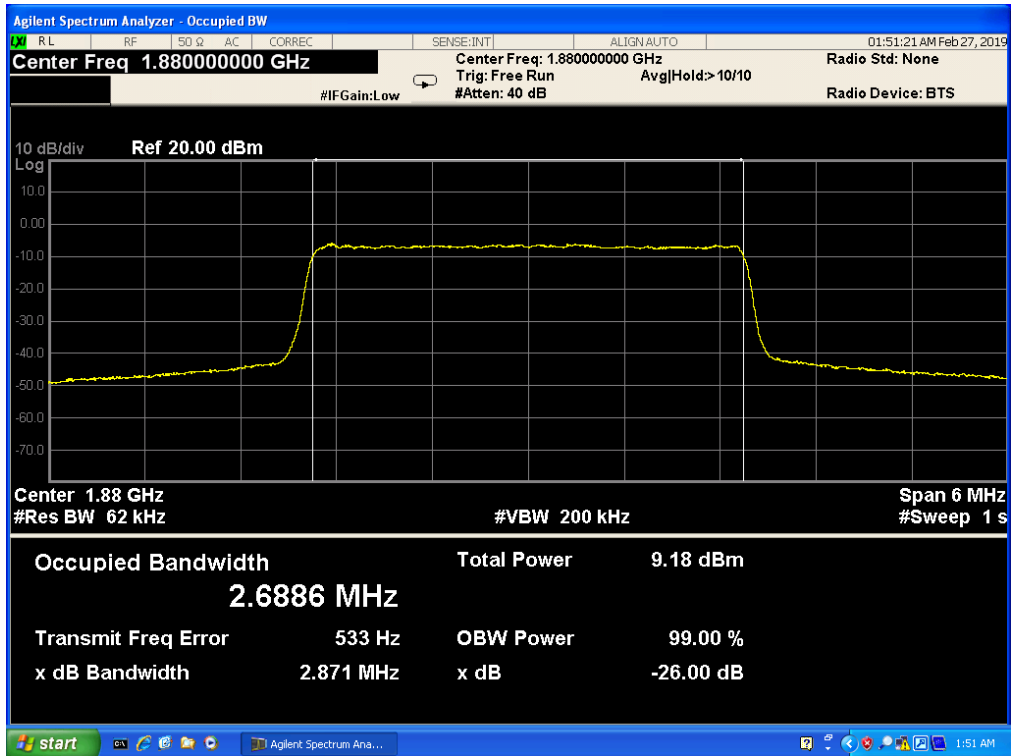

Band 2, UL Channel 18900, UL Frequency 1880.0, BW 3.0, NO. RB 15, RB POS. Low, 16-QAM

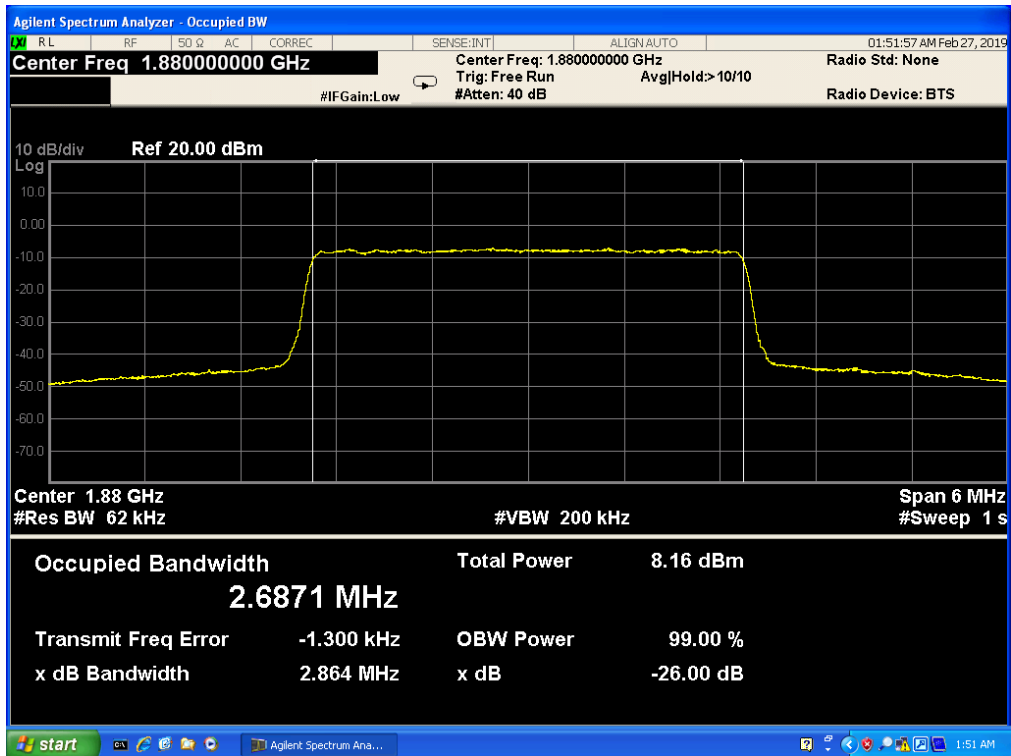

Band 2, UL Channel 18900, UL Frequency 1880.0, BW 5.0, NO. RB 25, RB POS. Low, QPSK

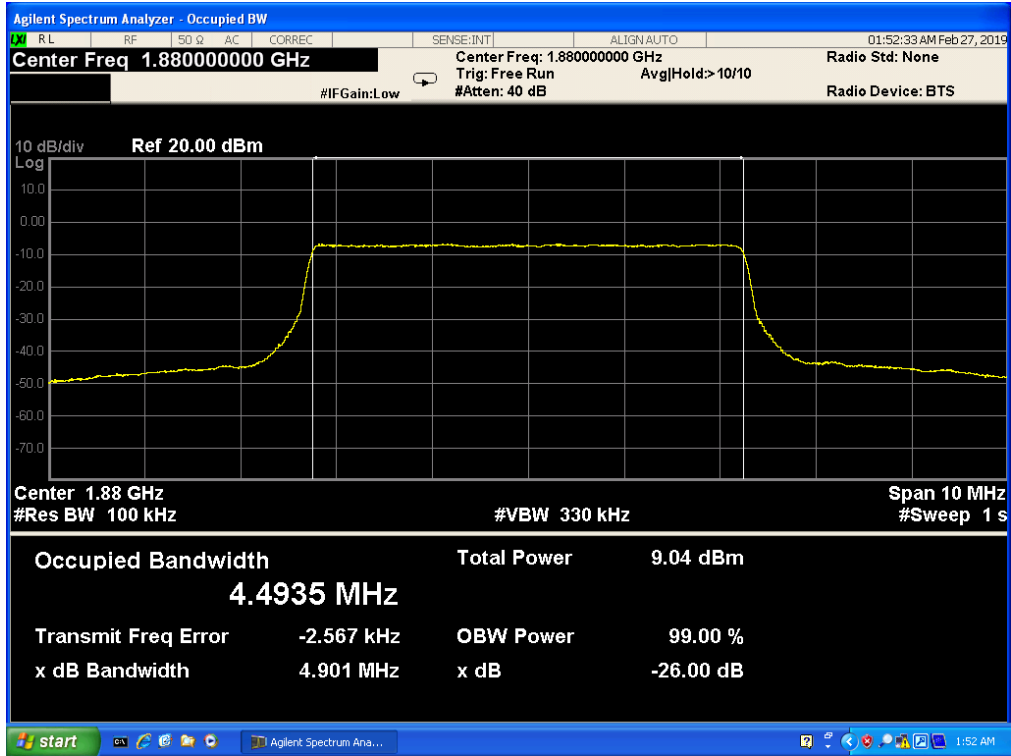

Band 2, UL Channel 18900, UL Frequency 1880.0, BW 5.0, NO. RB 25, RB POS. Low, 16-QAM

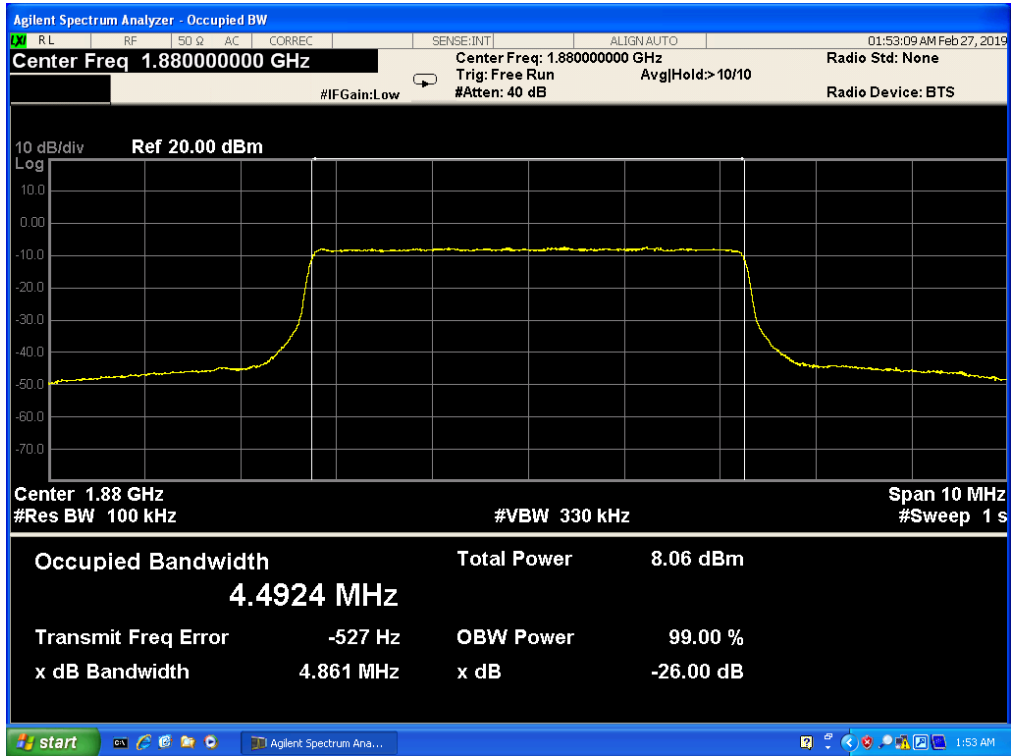

Band 2, UL Channel 18900, UL Frequency 1880.0, BW 10.0, NO. RB 50, RB POS. Low, QPSK

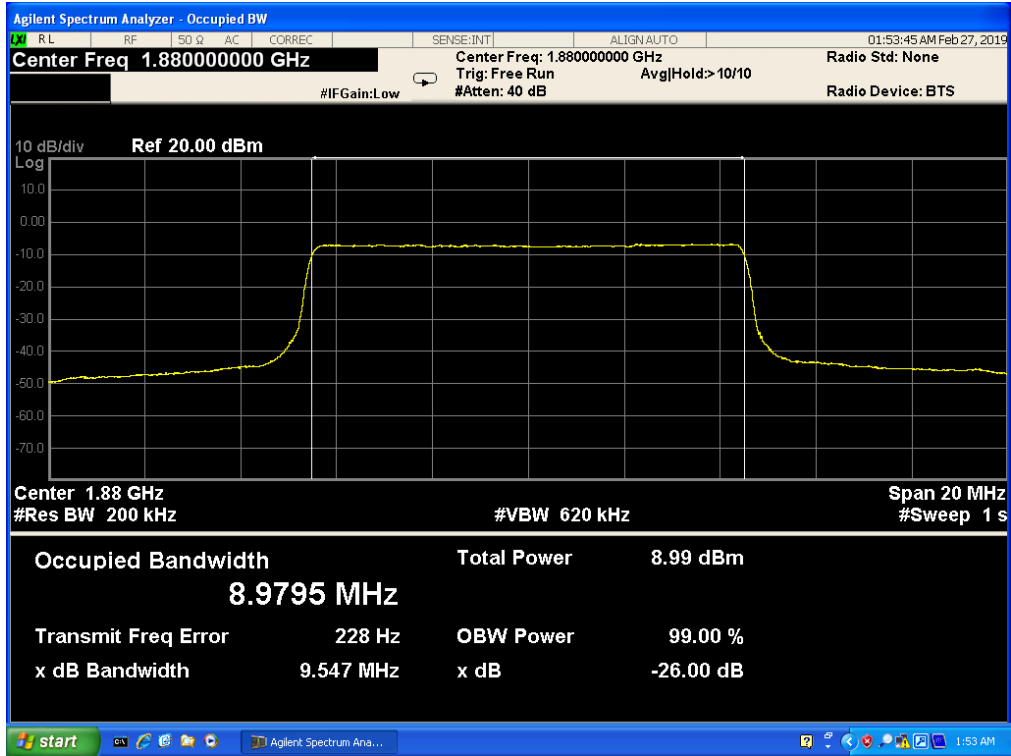

Band 2, UL Channel 18900, UL Frequency 1880.0, BW 10.0, NO. RB 50, RB POS. Low, 16-QAM

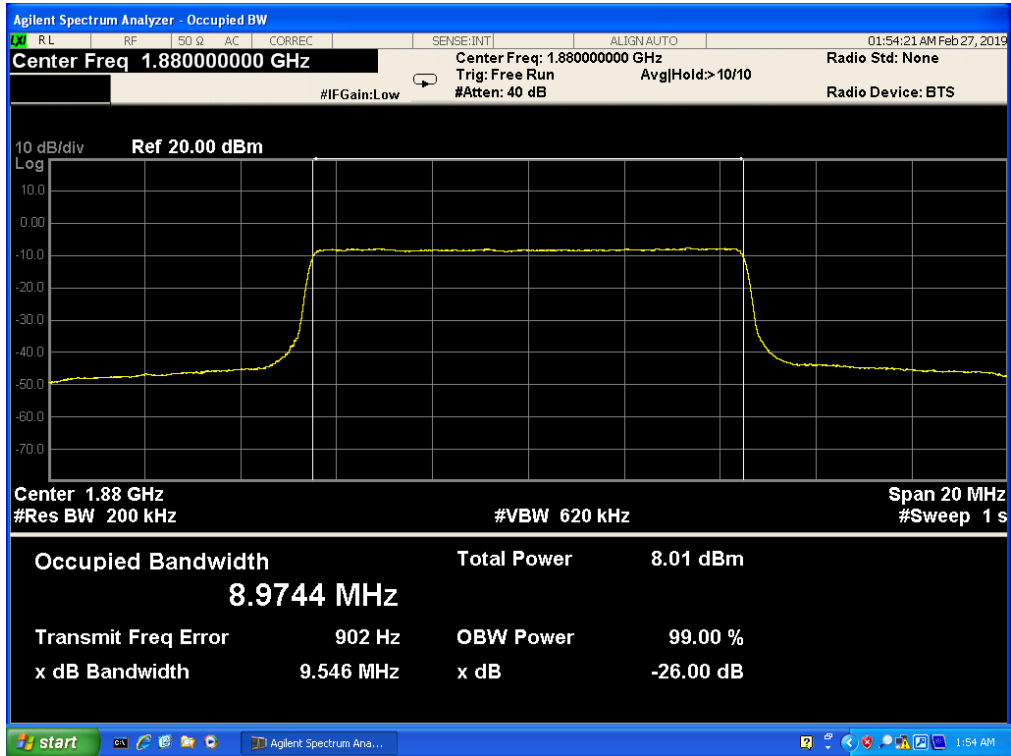

Band 2, UL Channel 18900, UL Frequency 1880.0, BW 15.0, NO. RB 75, RB POS. Low, QPSK

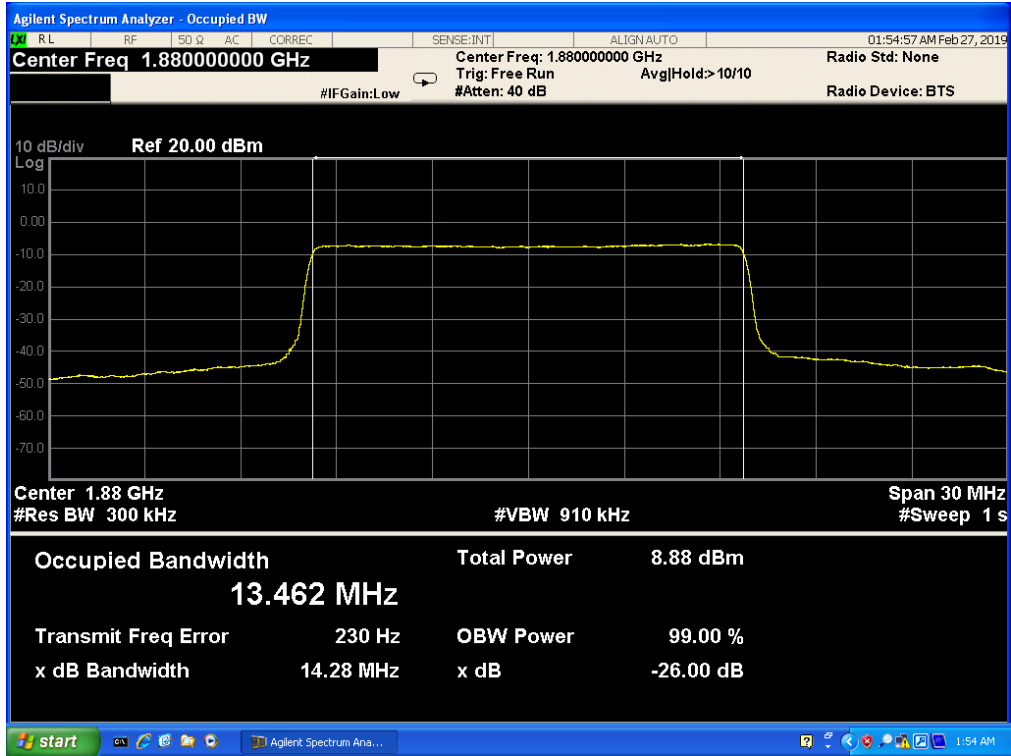

Band 2, UL Channel 18900, UL Frequency 1880.0, BW 15.0, NO. RB 75, RB POS. Low, 16-QAM

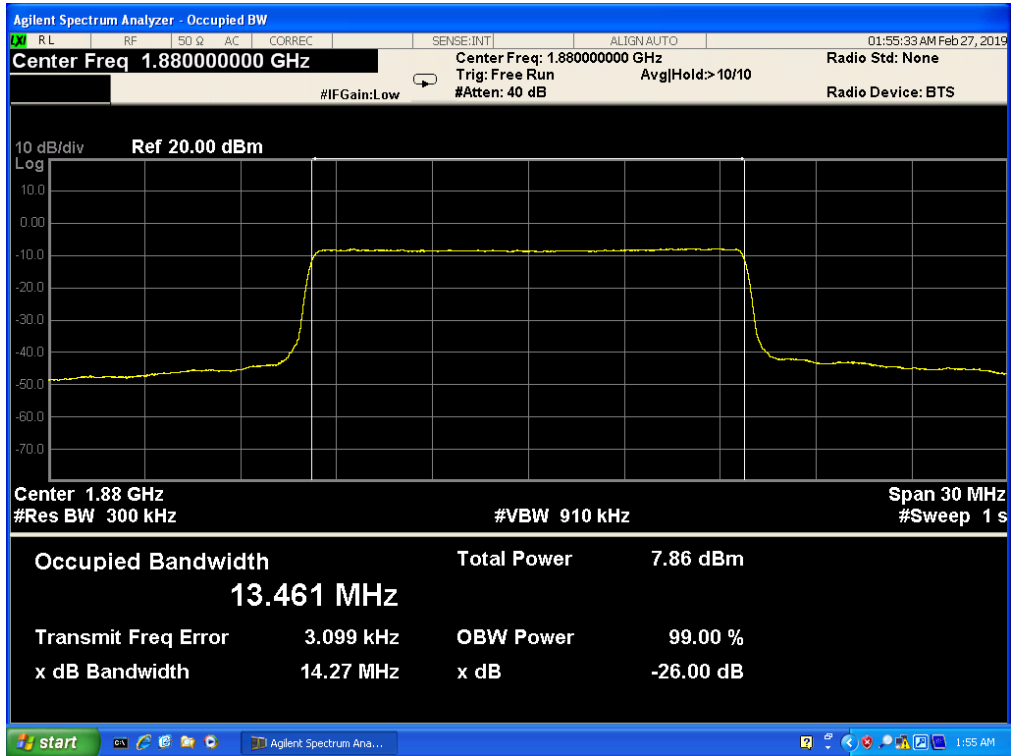

Band 2, UL Channel 18900, UL Frequency 1880.0, BW 20.0, NO. RB 100, RB POS. Low, QPSK

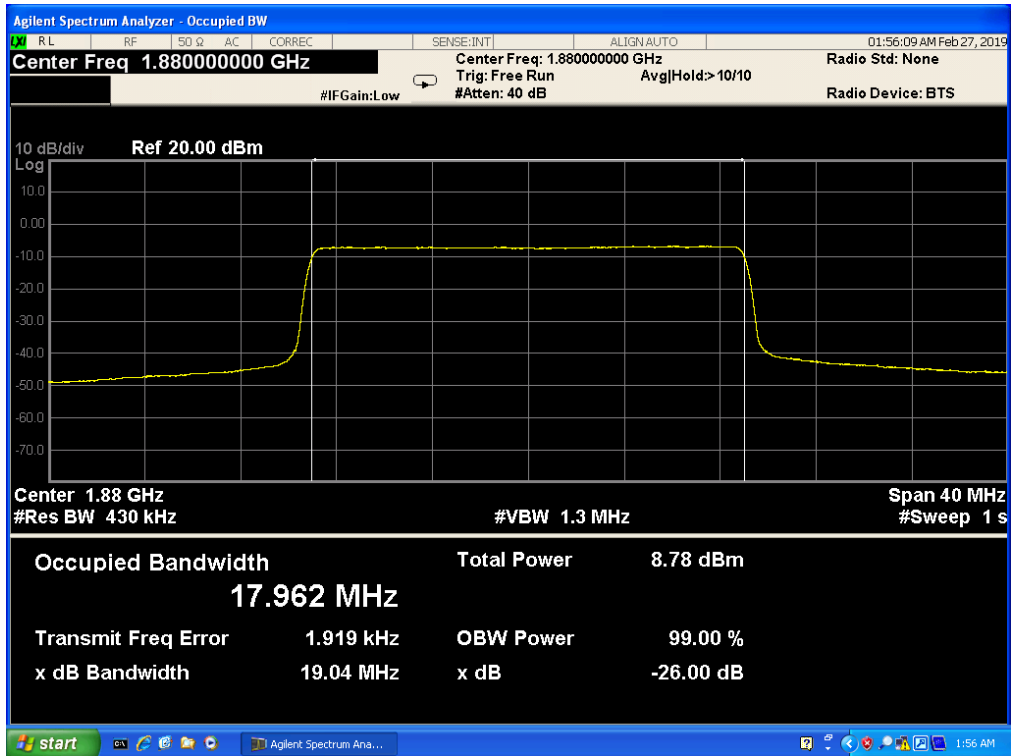

Band 2, UL Channel 18900, UL Frequency 1880.0, BW 20.0, NO. RB 100, RB POS. Low, 16-QAM

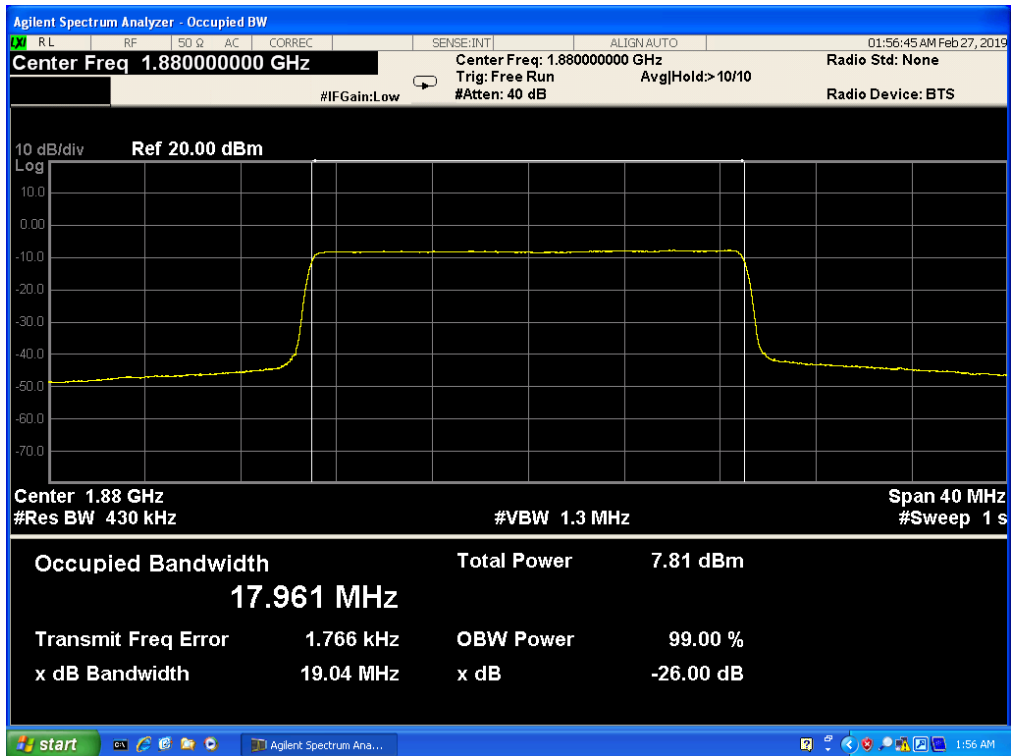

5.2 LTE BAND 4

Band 4, UL Channel 20175, UL Frequency 1732.5, BW 1.4, NO. RB 6, RB POS. Low, QPSK

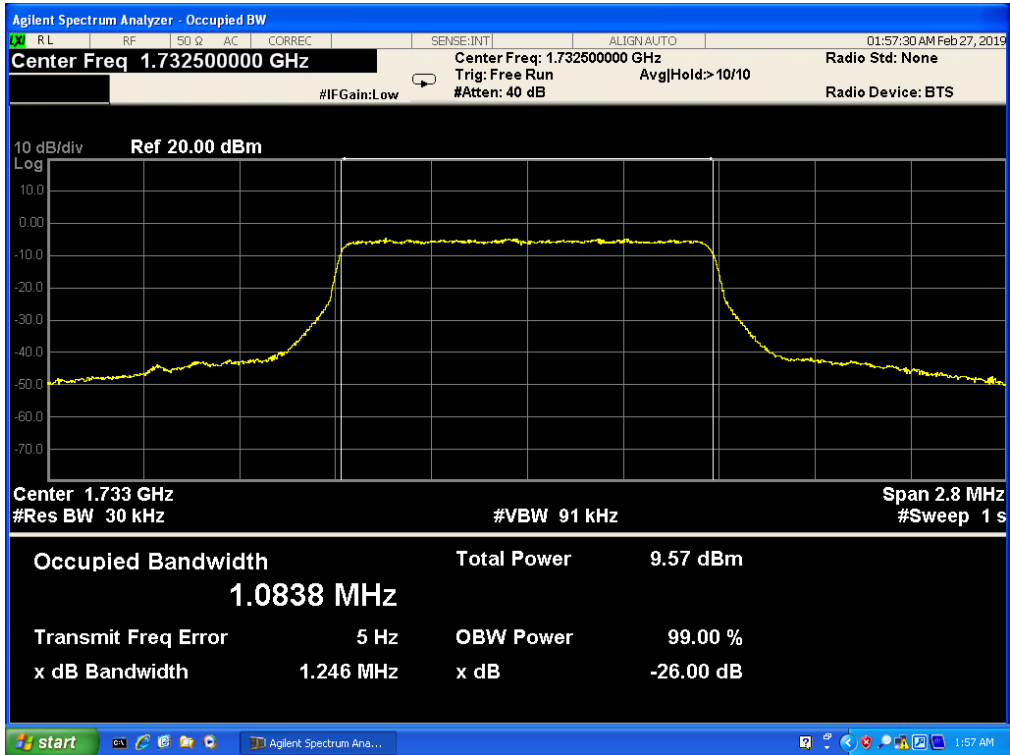

Band 4, UL Channel 20175, UL Frequency 1732.5, BW 1.4, NO. RB 6, RB POS. Low, 16-QAM

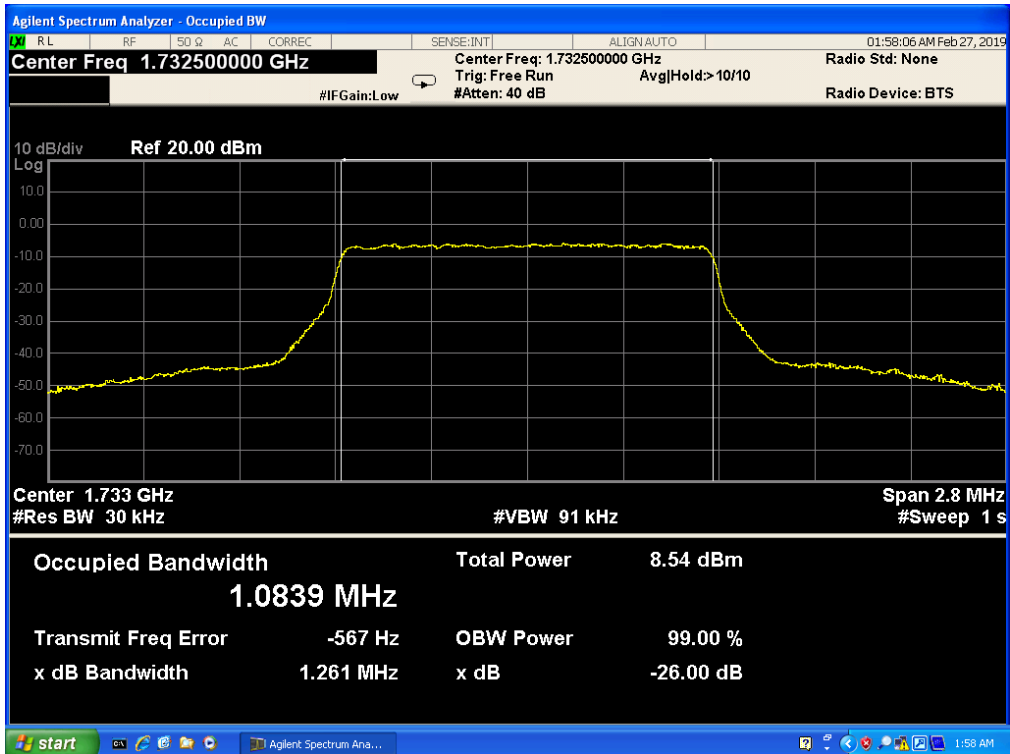

Band 4, UL Channel 20175, UL Frequency 1732.5, BW 3.0, NO. RB 15, RB POS. Low, QPSK

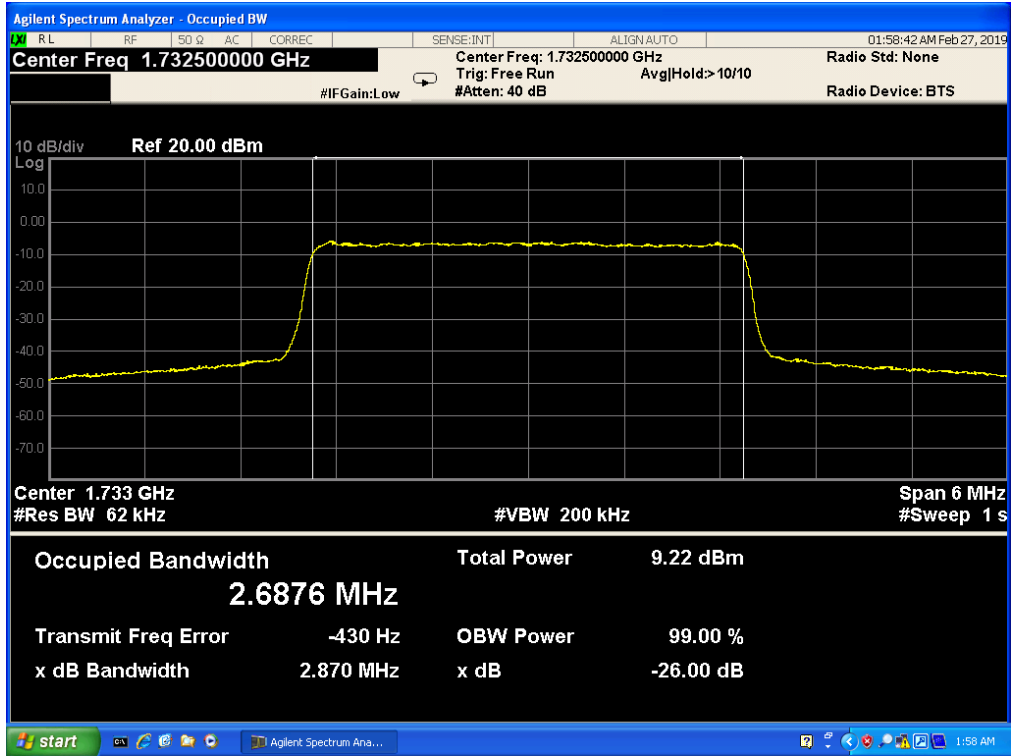

Band 4, UL Channel 20175, UL Frequency 1732.5, BW 3.0, NO. RB 15, RB POS. Low, 16-QAM

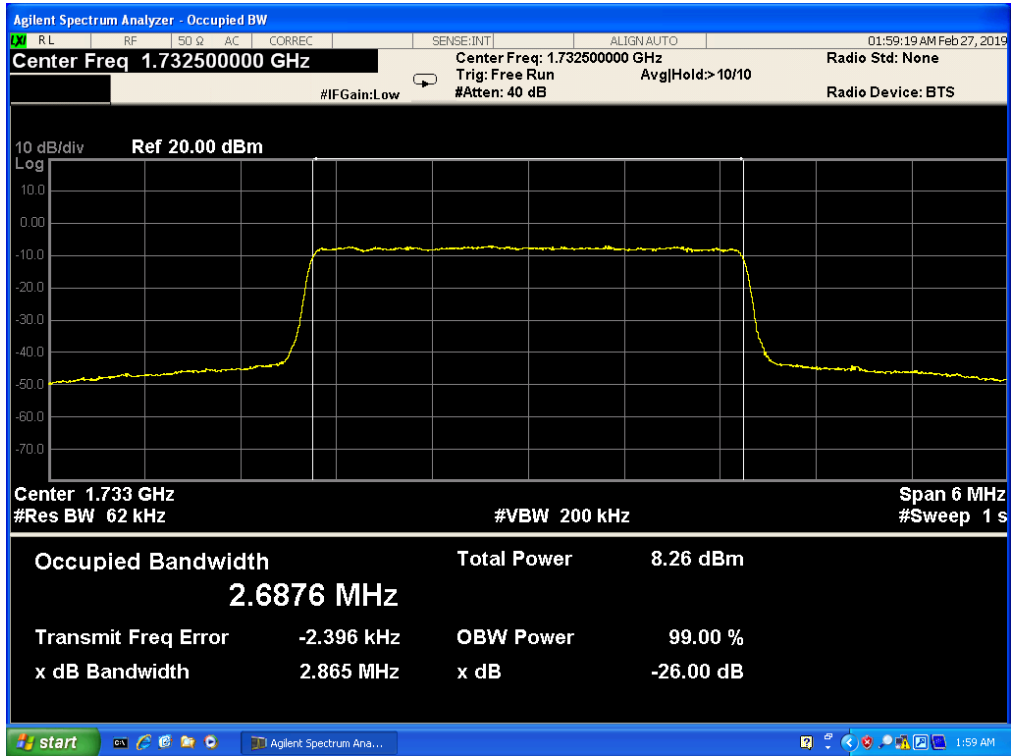

Band 4, UL Channel 20175, UL Frequency 1732.5, BW 5.0, NO. RB 25, RB POS. Low, QPSK

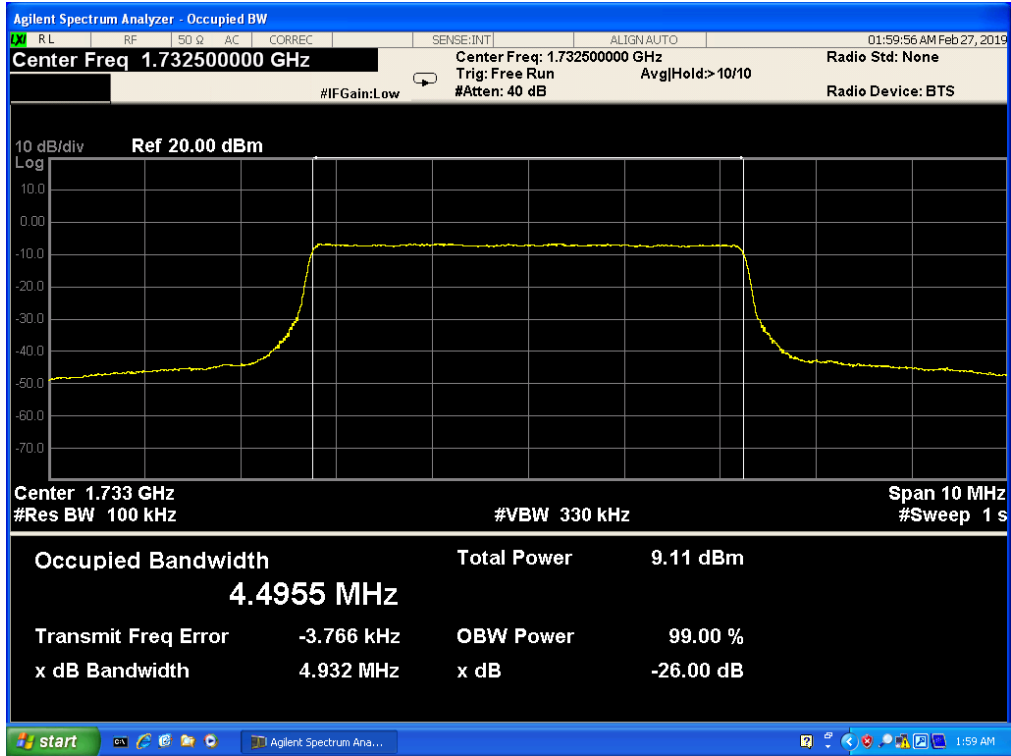

Band 4, UL Channel 20175, UL Frequency 1732.5, BW 5.0, NO. RB 25, RB POS. Low, 16-QAM

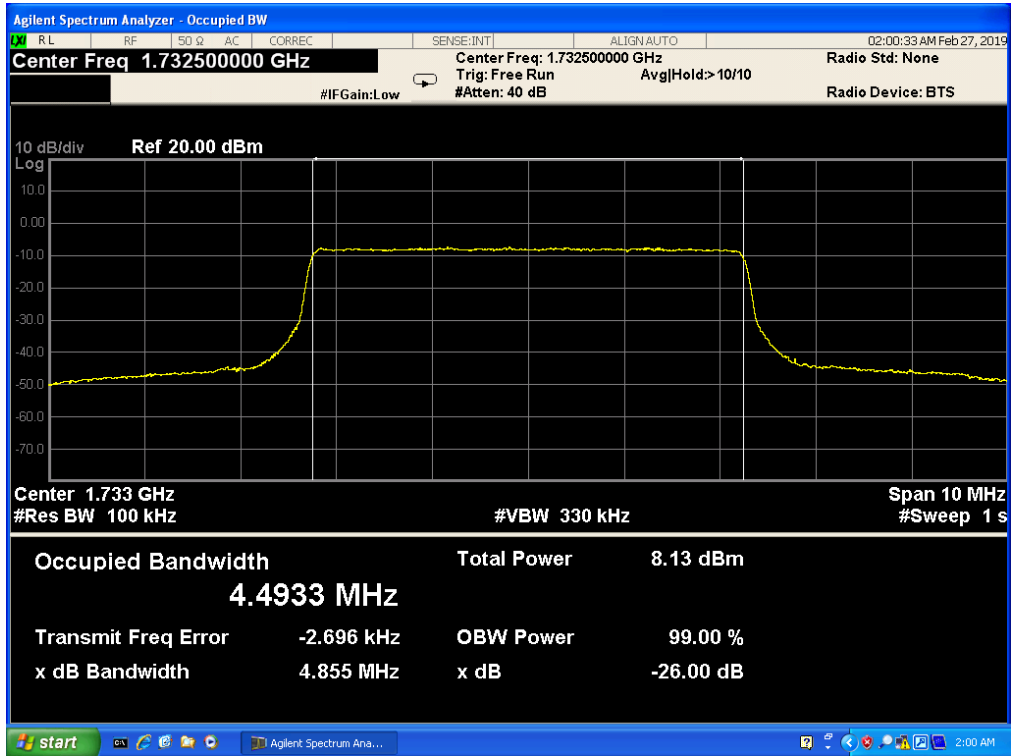

Band 4, UL Channel 20175, UL Frequency 1732.5, BW 10.0, NO. RB 50, RB POS. Low, QPSK

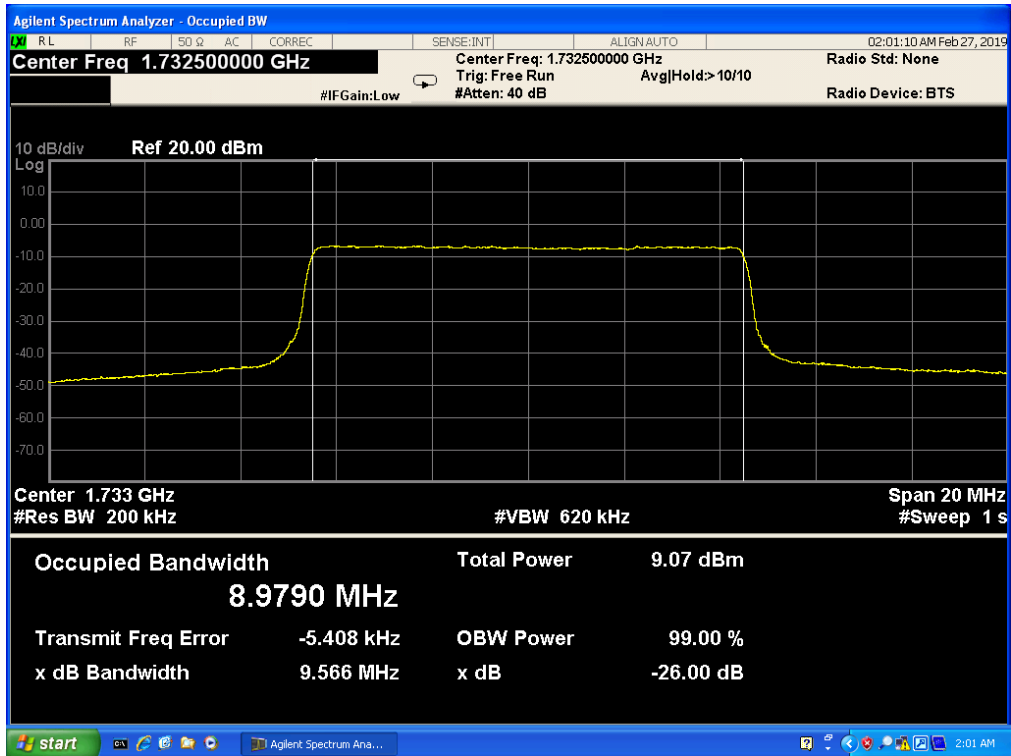

Band 4, UL Channel 20175, UL Frequency 1732.5, BW 10.0, NO. RB 50, RB POS. Low, 16-QAM

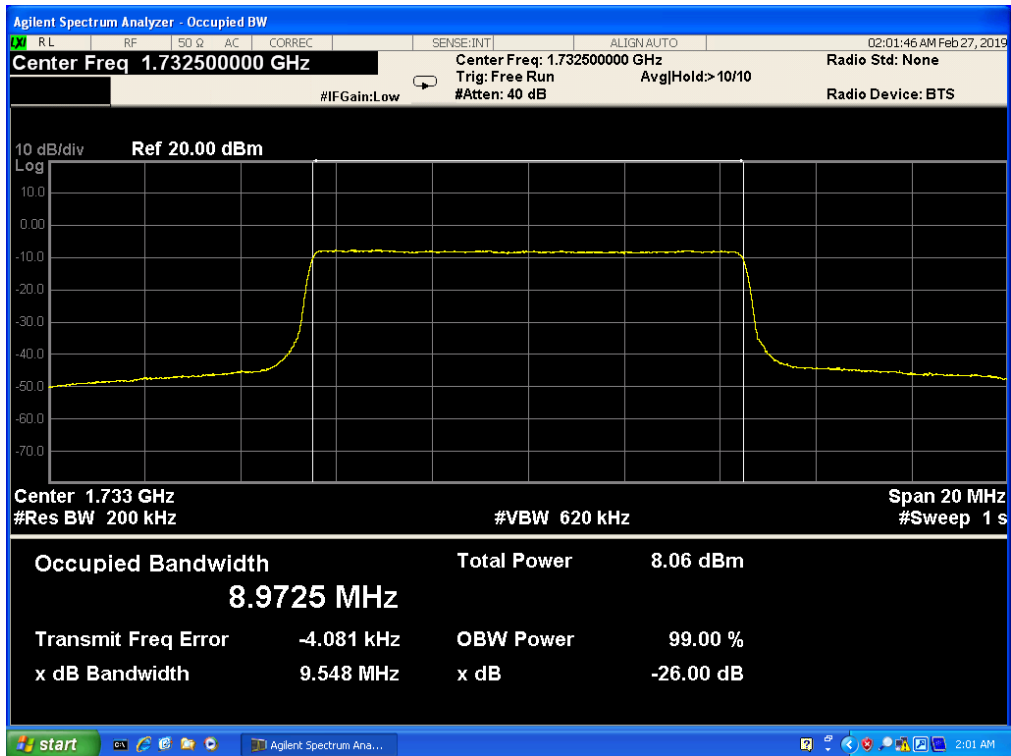

Band 4, UL Channel 20175, UL Frequency 1732.5, BW 15.0, NO. RB 75, RB POS. Low, QPSK

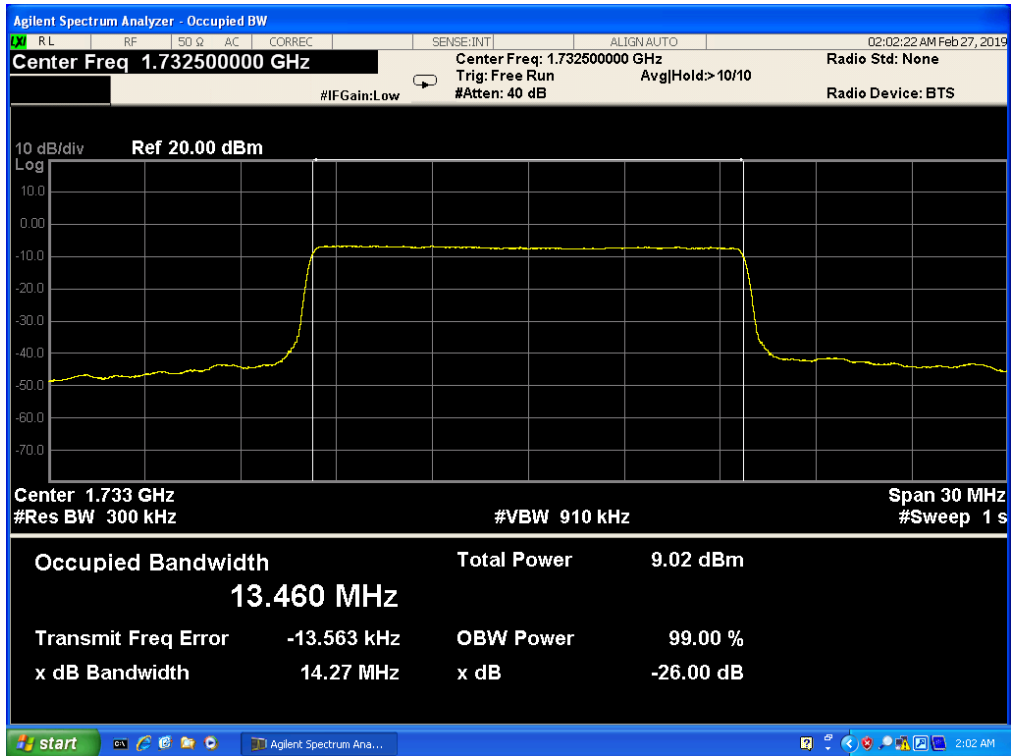

Band 4, UL Channel 20175, UL Frequency 1732.5, BW 15.0, NO. RB 75, RB POS. Low, 16-QAM

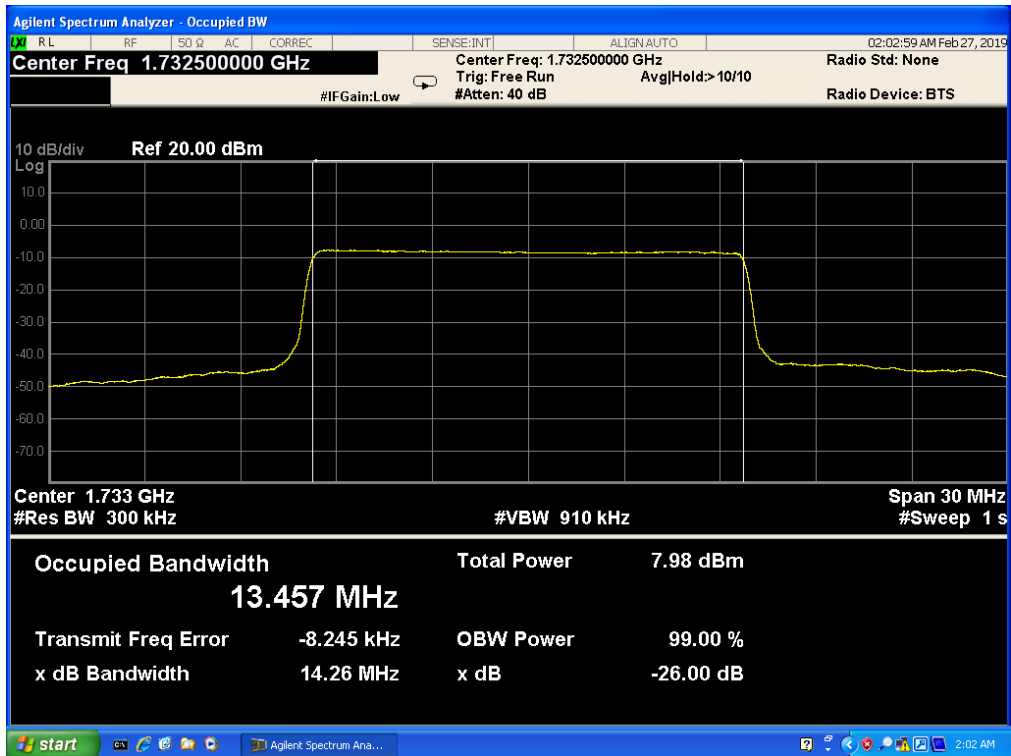

Band 4, UL Channel 20175, UL Frequency 1732.5, BW 20.0, NO. RB 100, RB POS. Low, QPSK

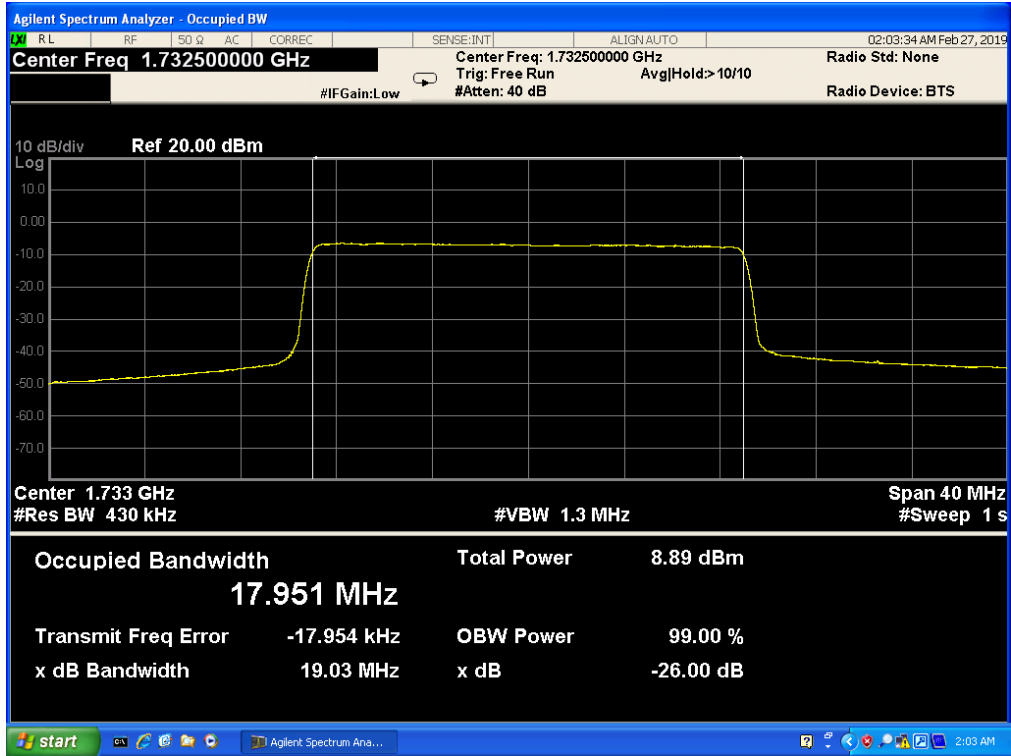

Band 4, UL Channel 20175, UL Frequency 1732.5, BW 20.0, NO. RB 100, RB POS. Low, 16-QAM

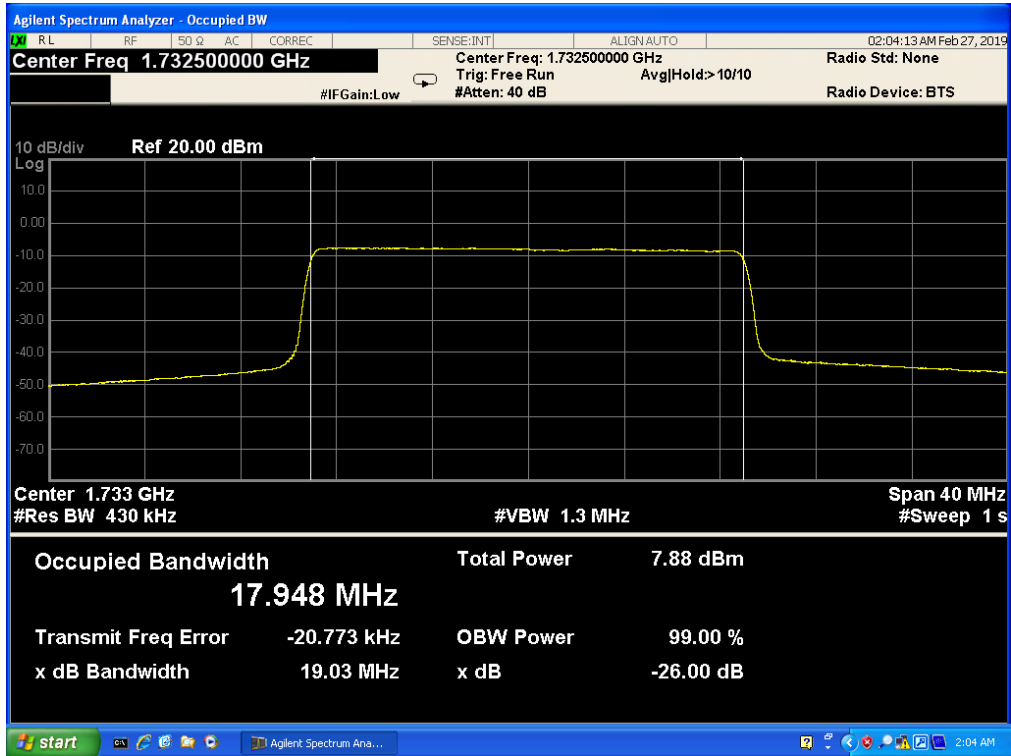

5.3 LTE BAND 5

Band 5, UL Channel 20525, UL Frequency 836.5, BW 1.4, NO. RB 6, RB POS. Low, QPSK

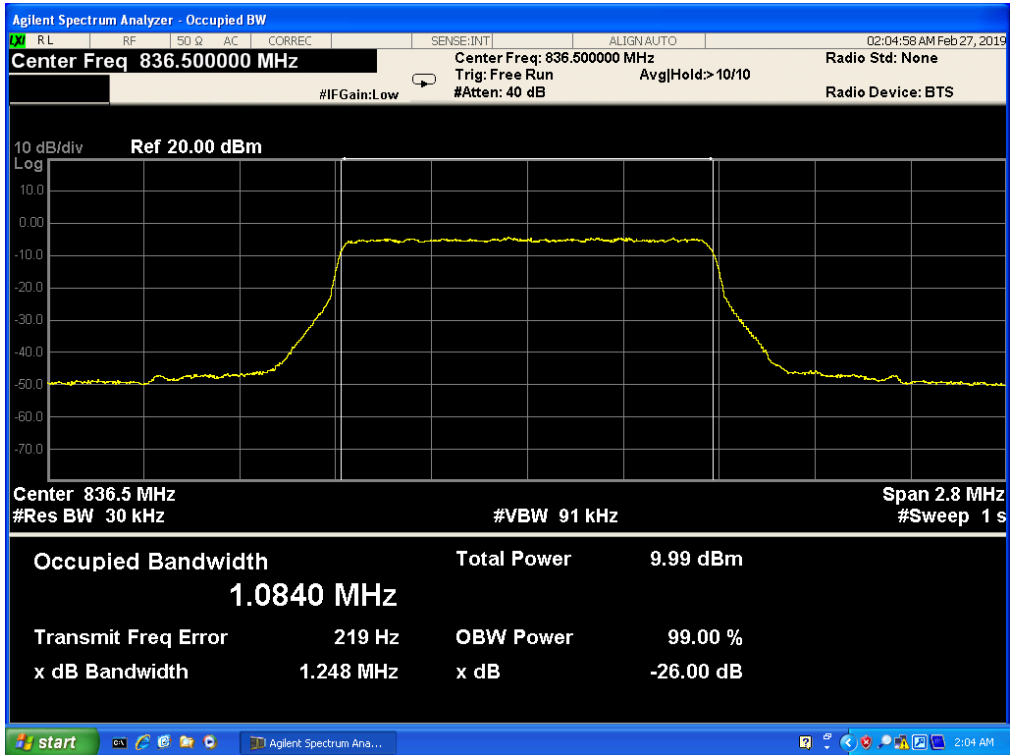

Band 5, UL Channel 20525, UL Frequency 836.5, BW 1.4, NO. RB 6, RB POS. Low, 16-QAM

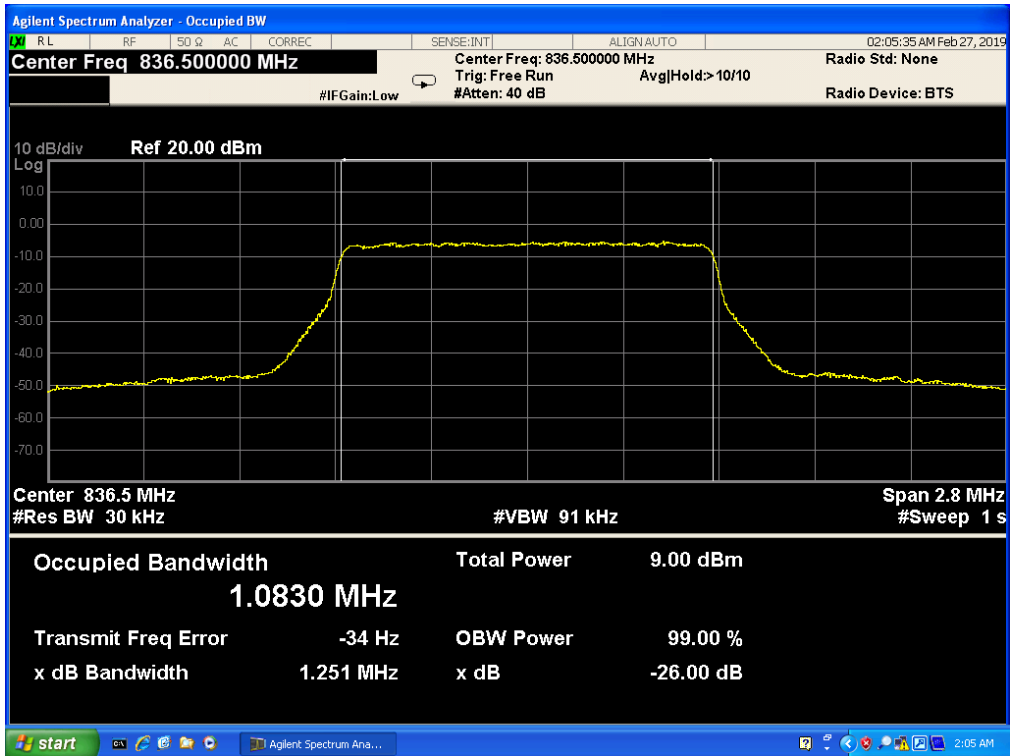

Band 5, UL Channel 20525, UL Frequency 836.5, BW 3.0, NO. RB 15, RB POS. Low, QPSK

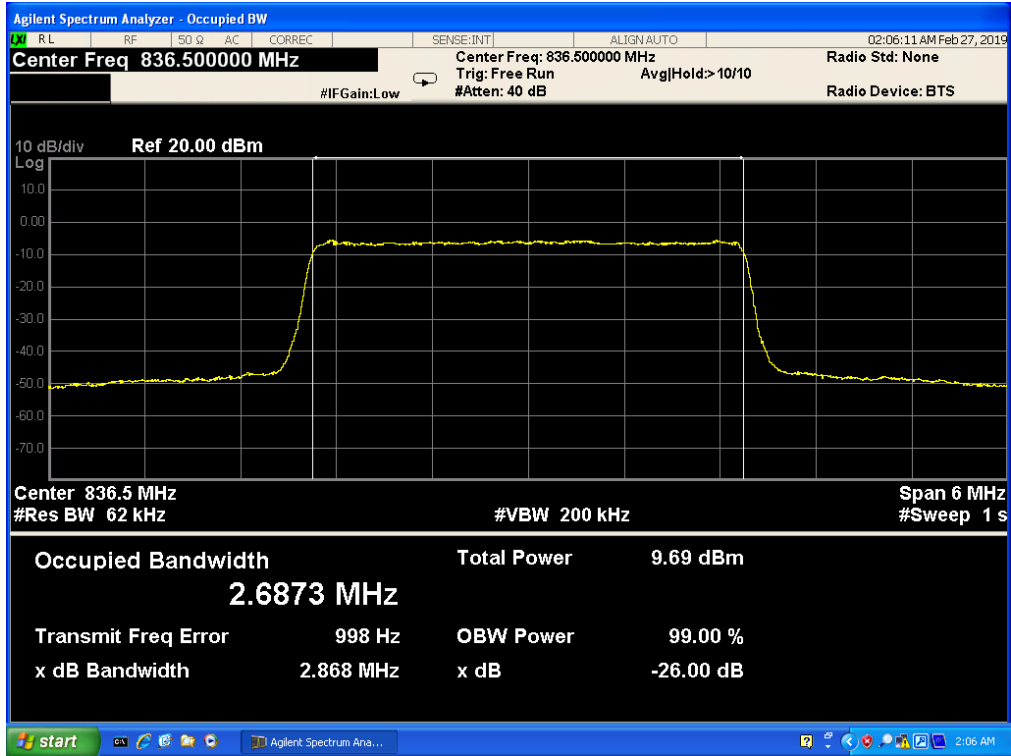

Band 5, UL Channel 20525, UL Frequency 836.5, BW 3.0, NO. RB 15, RB POS. Low, 16-QAM

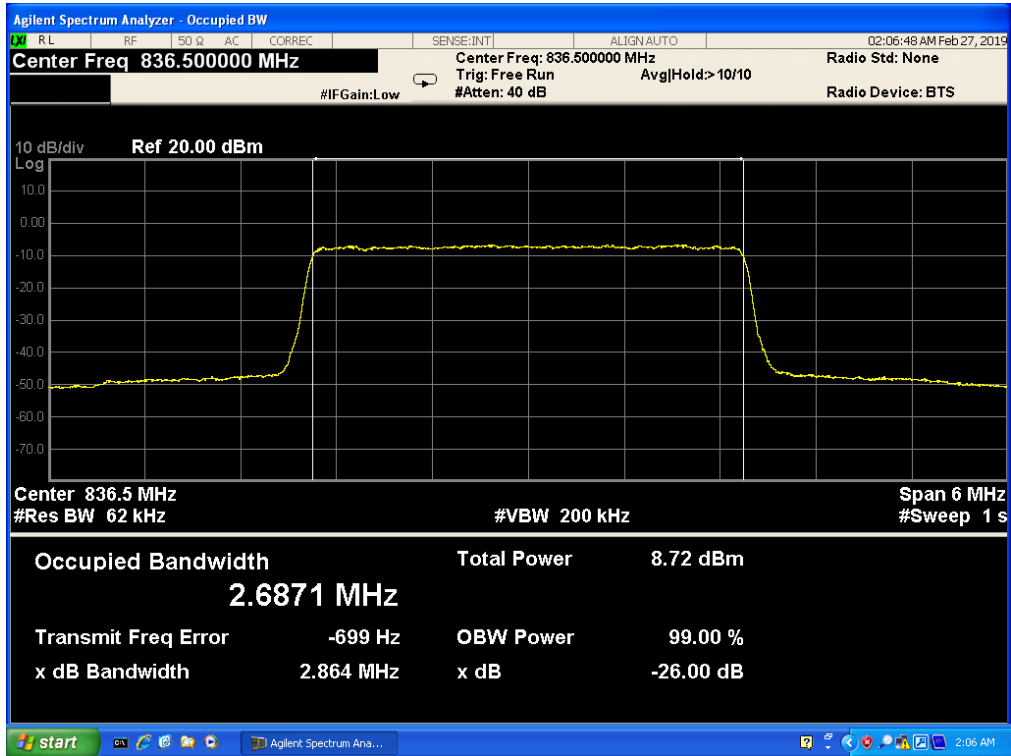

Band 5, UL Channel 20525, UL Frequency 836.5, BW 5.0, NO. RB 25, RB POS. Low, QPSK

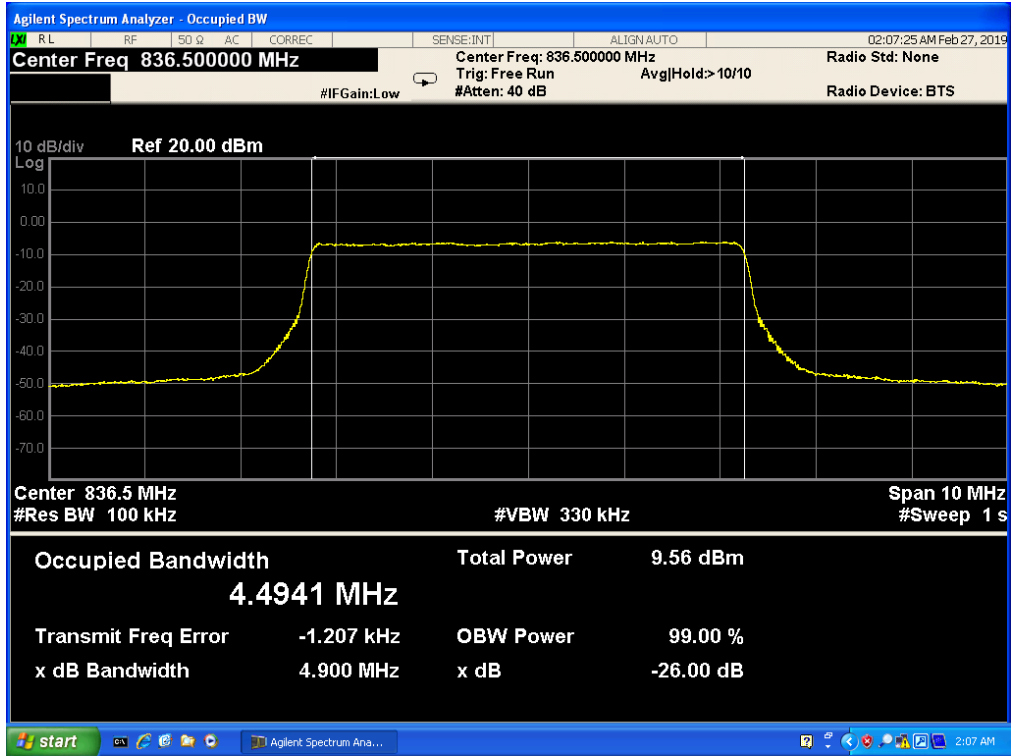

Band 5, UL Channel 20525, UL Frequency 836.5, BW 5.0, NO. RB 25, RB POS. Low, 16-QAM

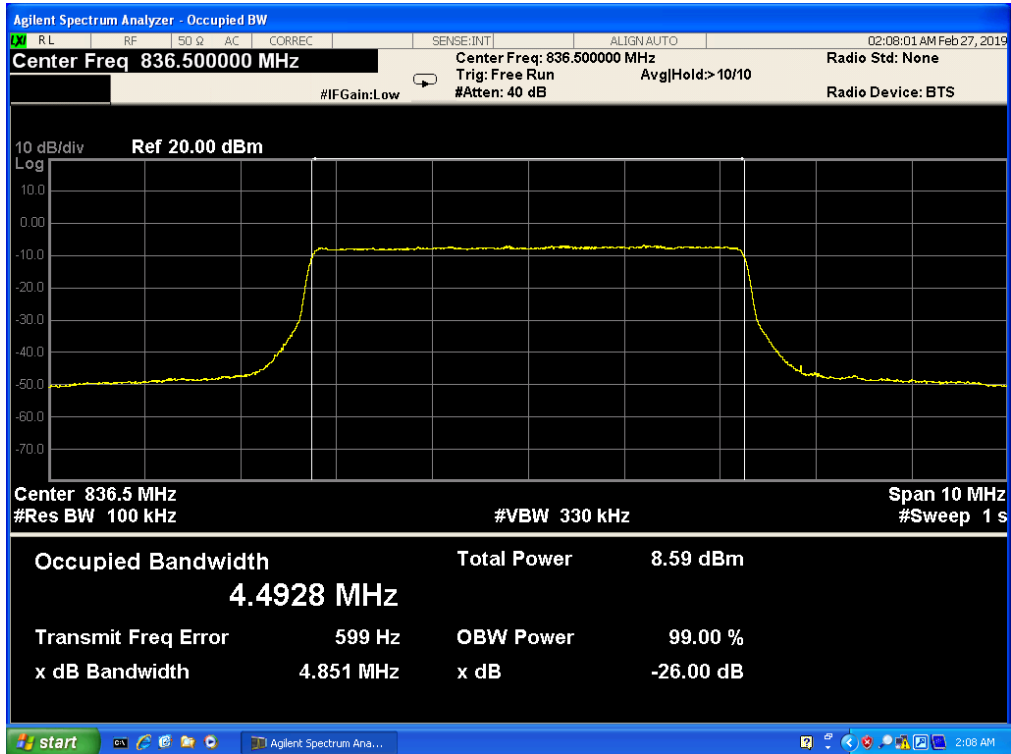

Band 5, UL Channel 20525, UL Frequency 836.5, BW 10.0, NO. RB 50, RB POS. Low, QPSK

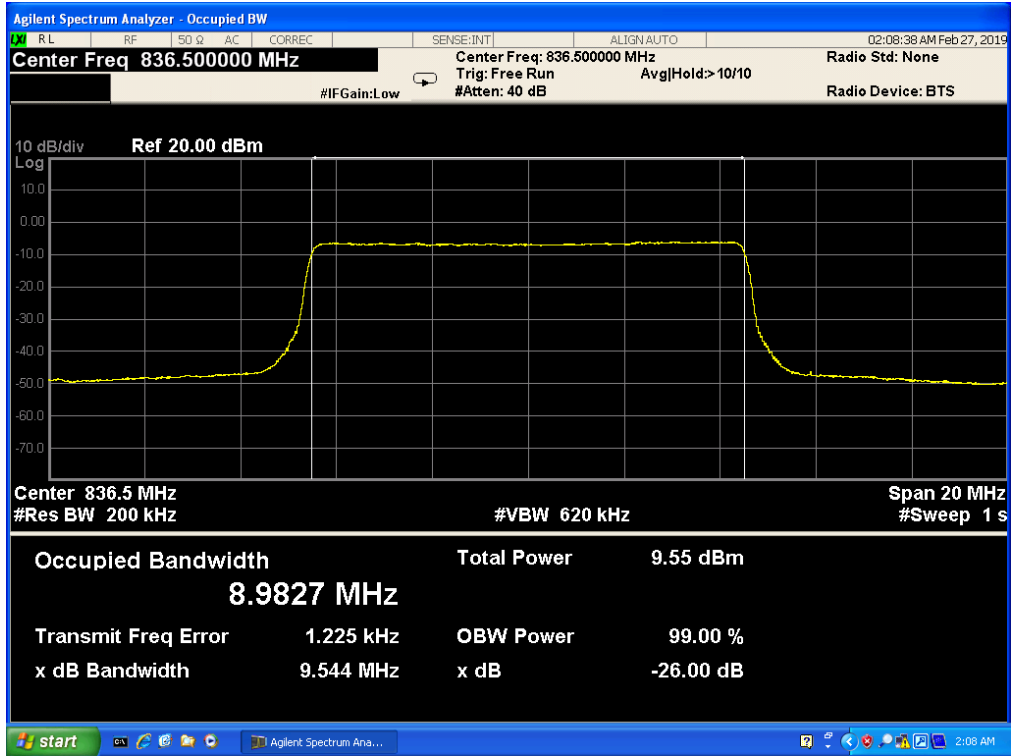

Band 5, UL Channel 20525, UL Frequency 836.5, BW 10.0, NO. RB 50, RB POS. Low, 16-QAM

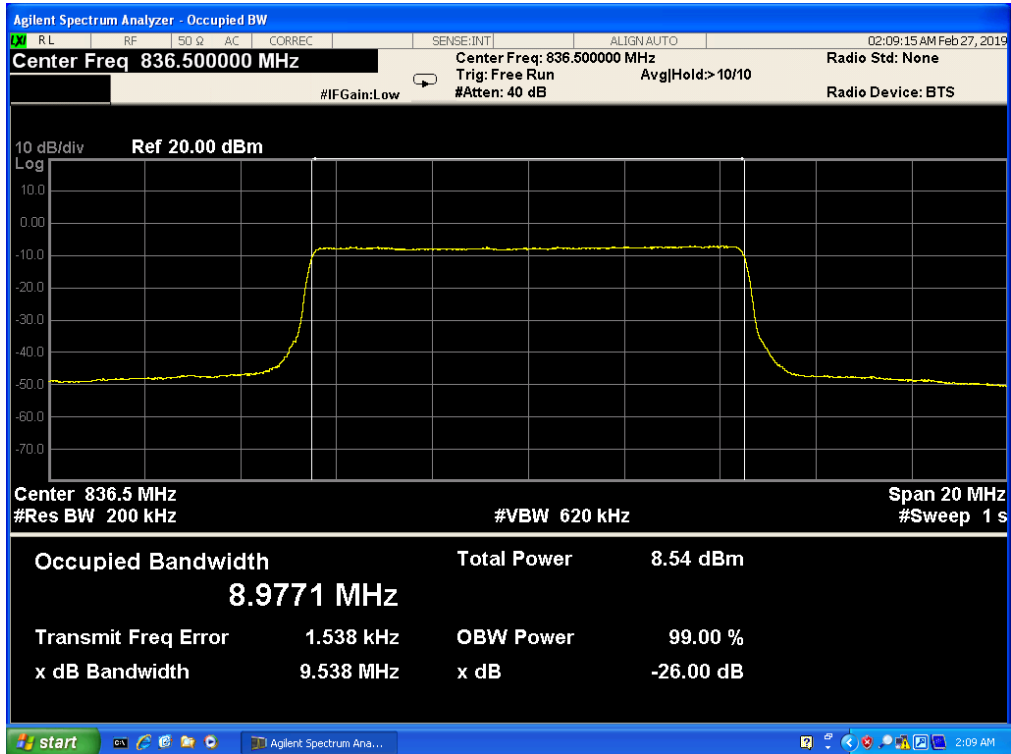

5.4 LTE BAND 7

Band 7, UL Channel 21100, UL Frequency 2535.0, BW 5.0, NO. RB 25, RB POS. Low, QPSK

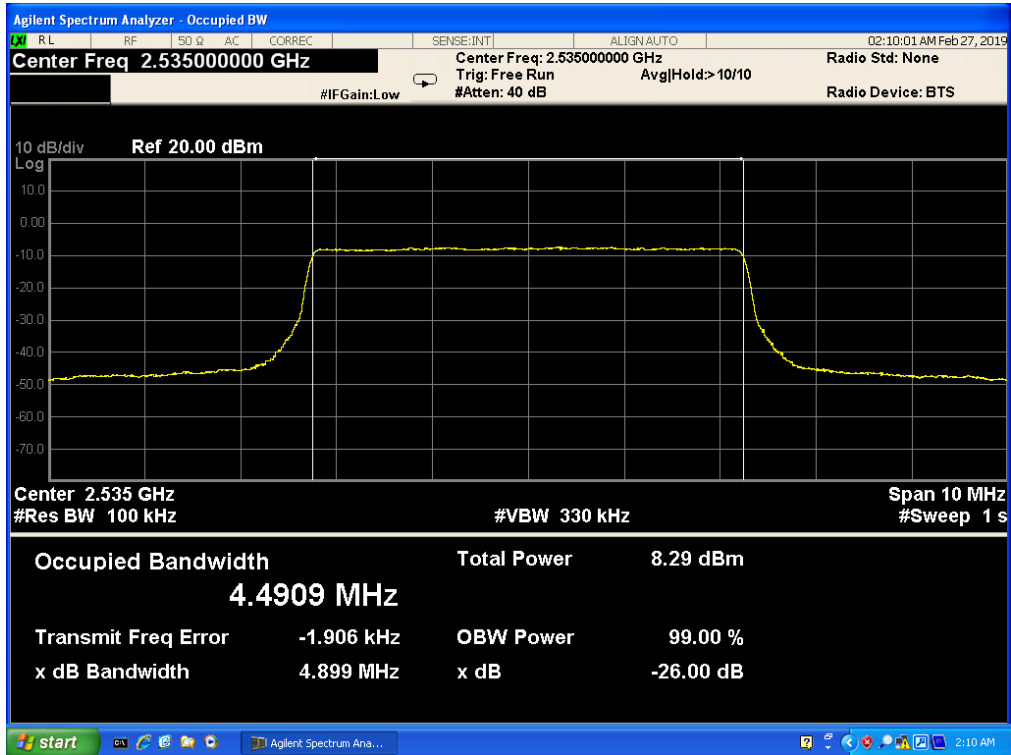

Band 7, UL Channel 21100, UL Frequency 2535.0, BW 5.0, NO. RB 25, RB POS. Low, 16-QAM

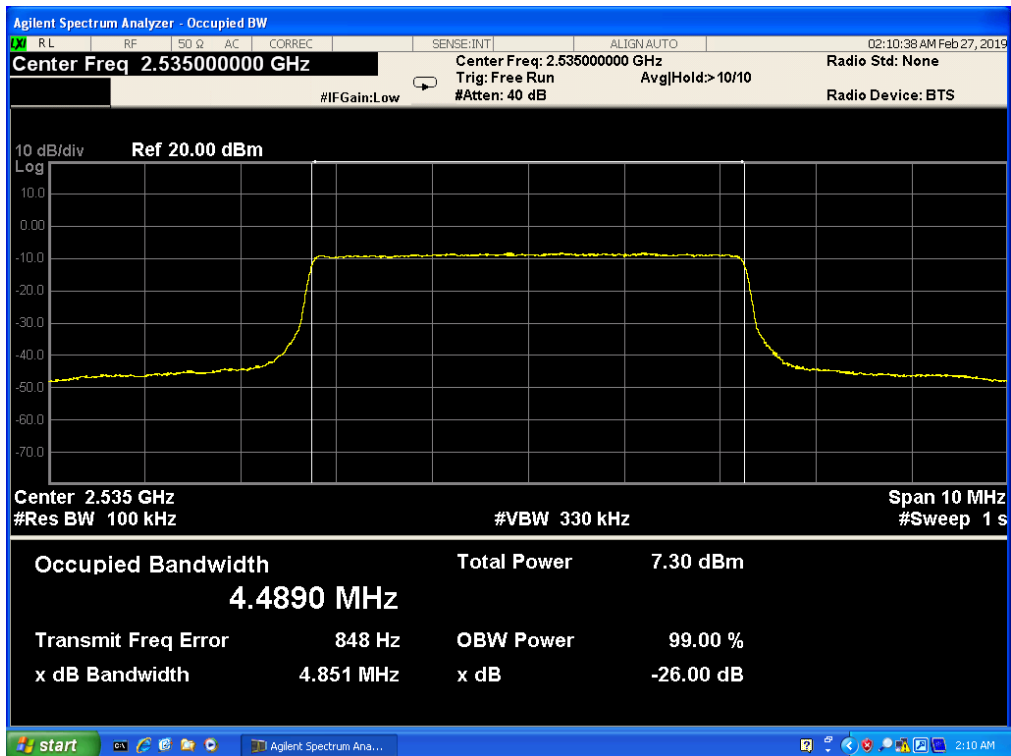

Band 7, UL Channel 21100, UL Frequency 2535.0, BW 10.0, NO. RB 50, RB POS. Low, QPSK

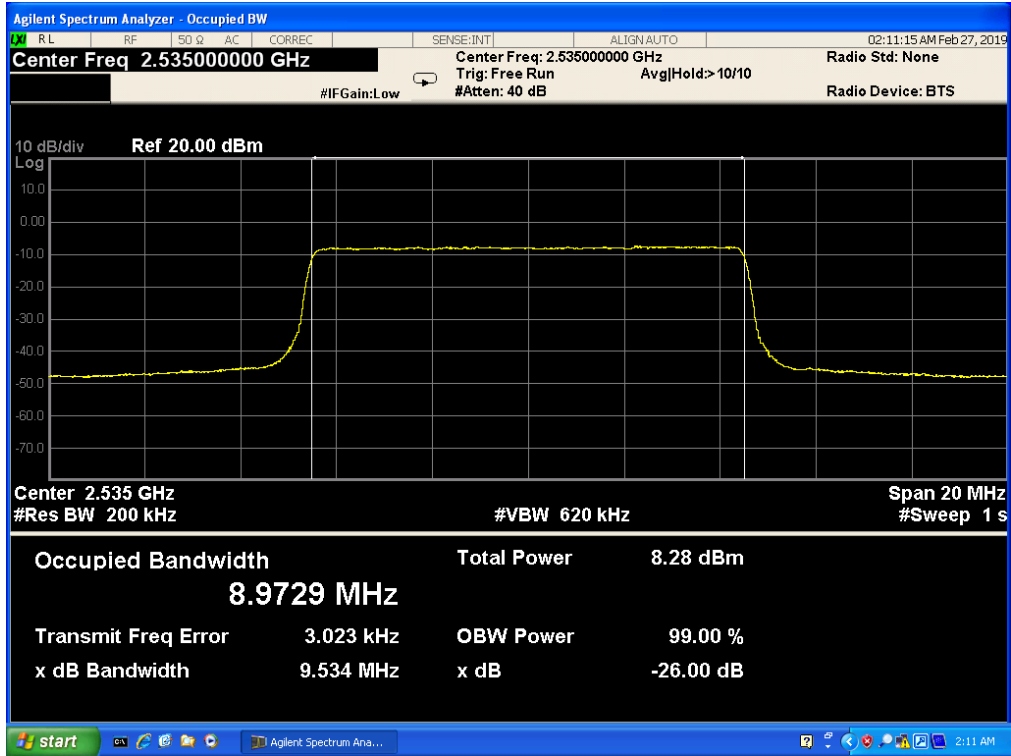

Band 7, UL Channel 21100, UL Frequency 2535.0, BW 10.0, NO. RB 50, RB POS. Low, 16-QAM

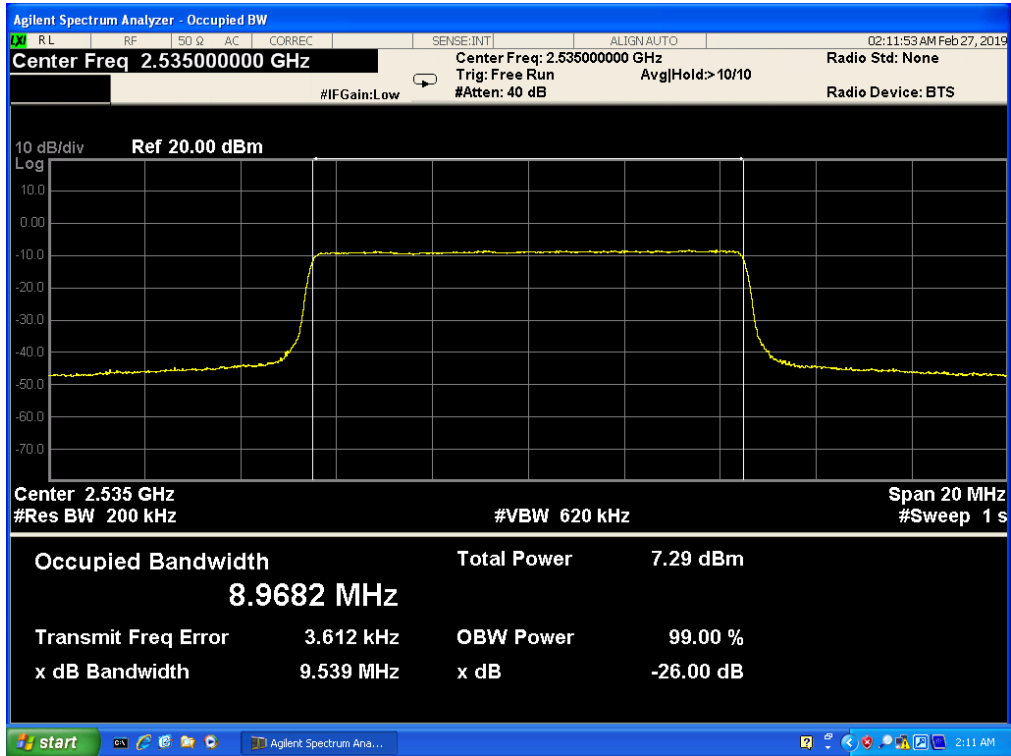

Band 7, UL Channel 21100, UL Frequency 2535.0, BW 15.0, NO. RB 75, RB POS. Low, QPSK

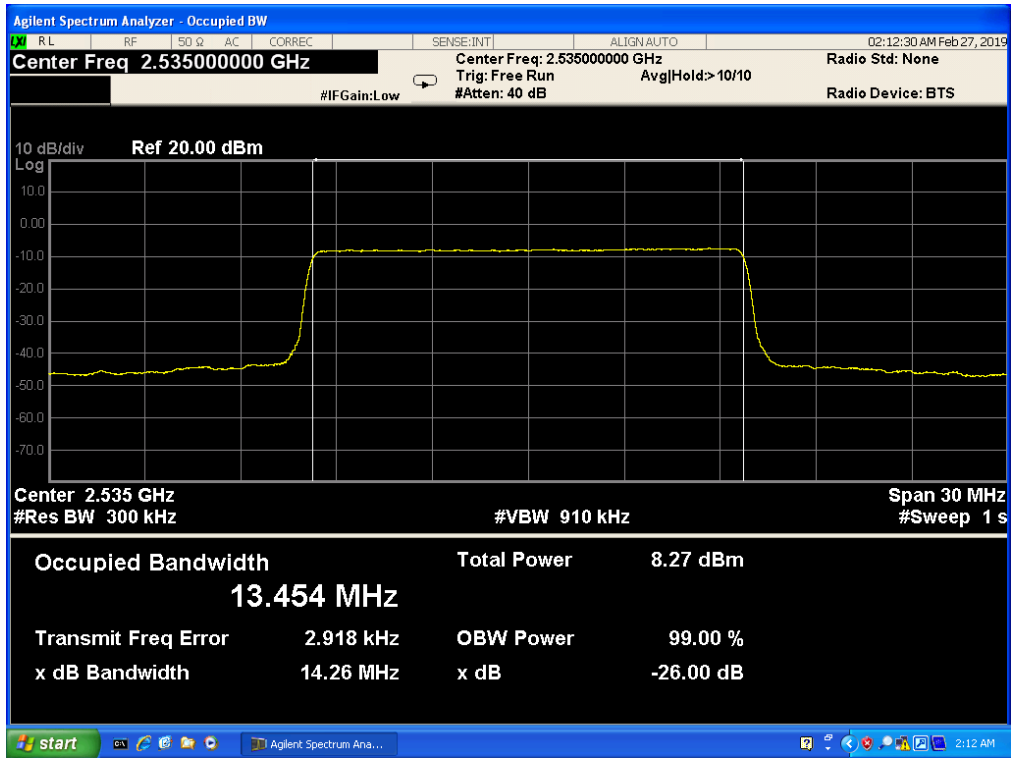

Band 7, UL Channel 21100, UL Frequency 2535.0, BW 15.0, NO. RB 75, RB POS. Low, 16-QAM

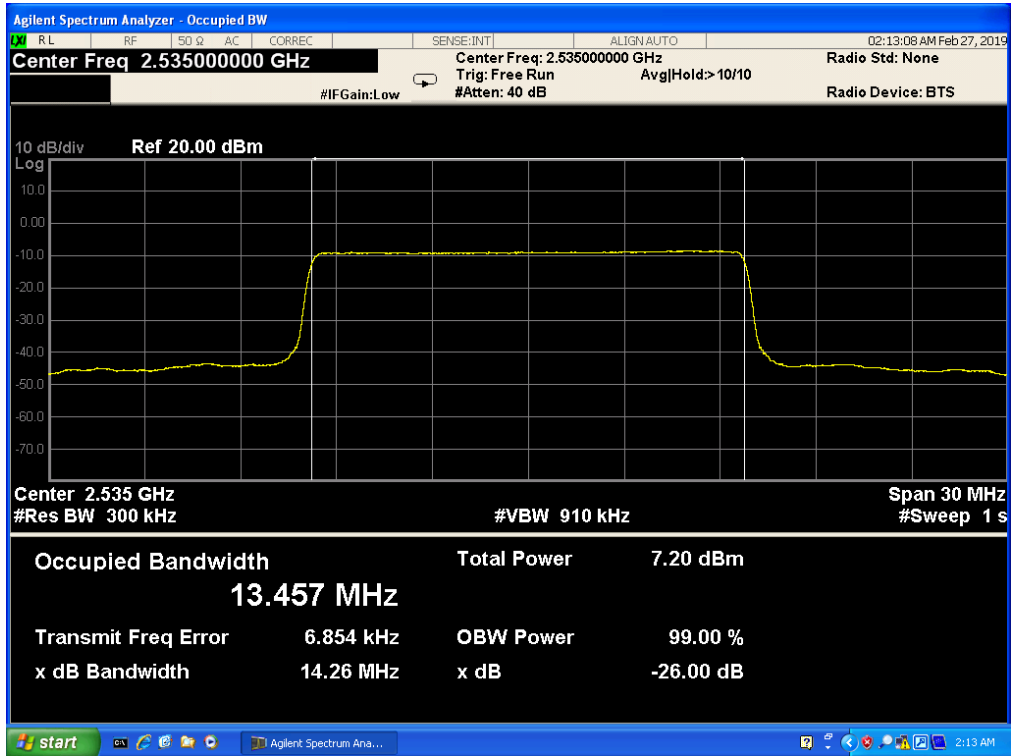

Band 7, UL Channel 21100, UL Frequency 2535.0, BW 20.0, NO. RB 100, RB POS. Low, QPSK

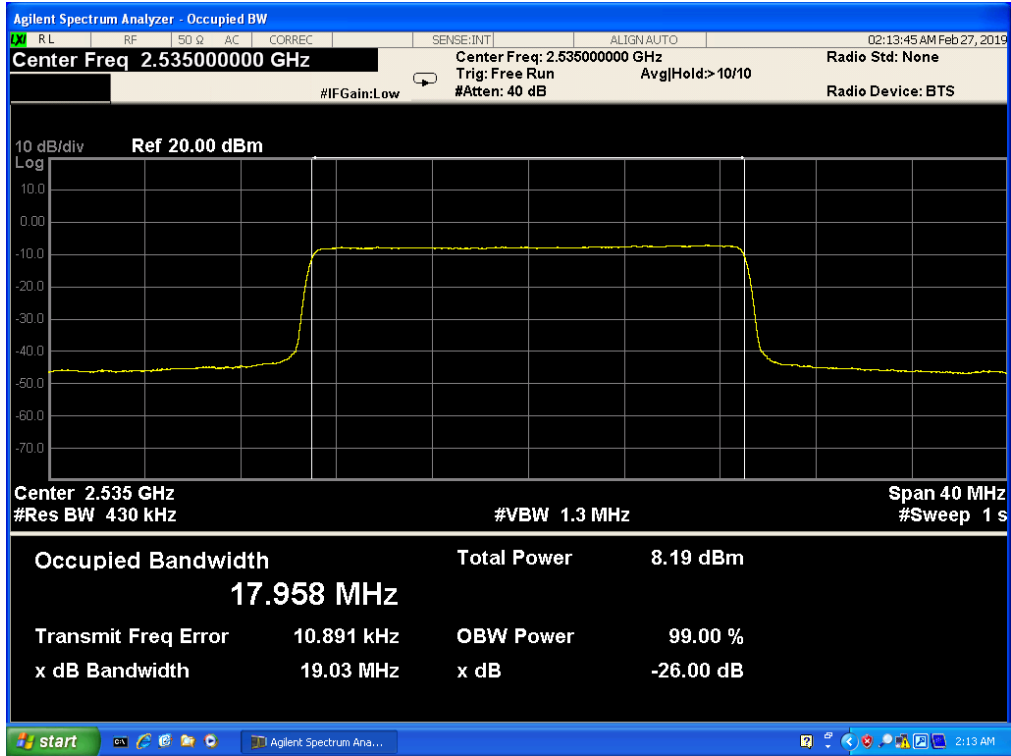

Band 7, UL Channel 21100, UL Frequency 2535.0, BW 20.0, NO. RB 100, RB POS. Low, 16-QAM

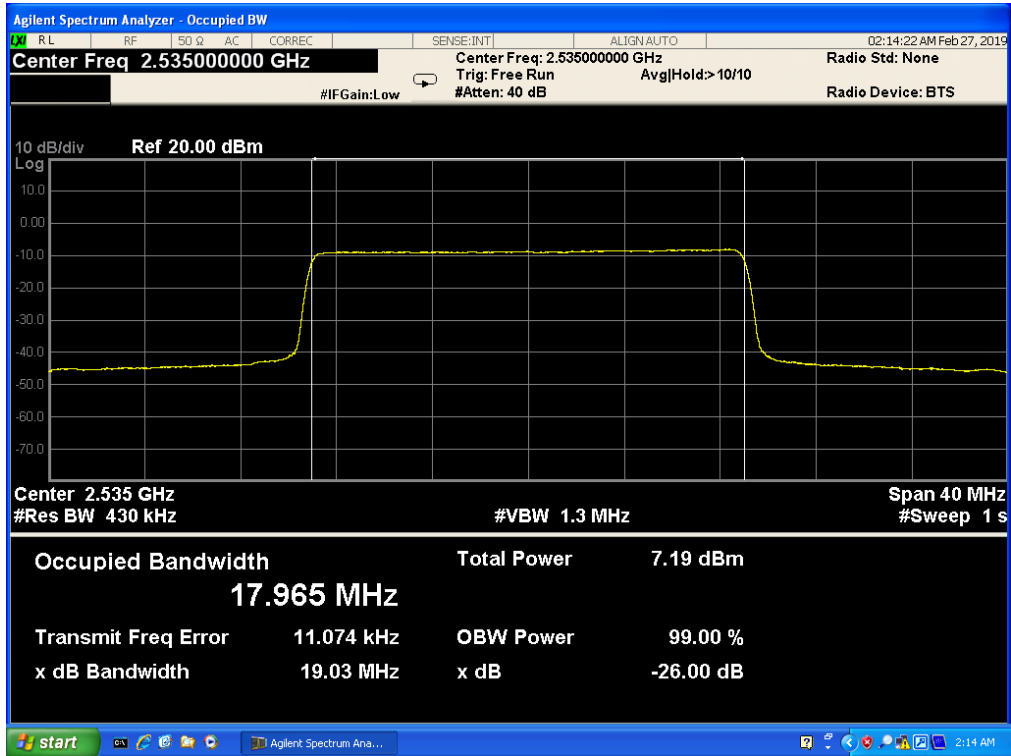

6. BANDEDGE AND EMISSION MASK

RULE PART(S)

FCC: §2.1051, §22.901, §22.917, §24.238, §27.53, and §90.691

FCC: §22.359

LIMITS

FCC: §22.359, §24.238, §27.53

The power of any emission outside of the authorized operating frequency ranges must be attenuated below the transmitting power (P) by a factor of at least $43 + 10 \log (P)$ dB.

(m)(4) For mobile digital stations, the attenuation factor shall be not less than $40 + 10 \log (P)$ dB on all frequencies between the channel edge and 5 megahertz from the channel edge, $43 + 10 \log (P)$ dB on all frequencies between 5 megahertz and X megahertz from the channel edge, and $55 + 10 \log (P)$ dB on all frequencies more than X megahertz from the channel edge, where X is the greater of 6 megahertz or the actual emission bandwidth as defined in paragraph (m)(6) of this section. In addition, the attenuation factor shall not be less that $43 + 10 \log (P)$ dB on all frequencies between 2490.5 MHz and 2496 MHz and $55 + 10 \log (P)$ dB at or below 2490.5 MHz. Mobile Satellite Service licensees operating on frequencies below 2495 MHz may also submit a documented interference complaint against BRS licensees operating on channel BRS Channel 1 on the same terms and conditions as adjacent channel BRS or EBS licensees. Show citation box.

TEST PROCEDURE

The transmitter output was connected to a CMW500 Test Set and configured to operate at maximum power. The band edge emissions were measured at the required operating frequencies in each band on the Spectrum Analyzer.

For each band edge measurement:

Set the spectrum analyzer span to include the block edge frequency.

Set a marker to point the corresponding band edge frequency in each test case.

Set display line at -13 dBm

Set resolution bandwidth to at least 1% of emission bandwidth.

MODES TESTED

- LTE Band 2
- LTE Band 4
- LTE Band 5
- LTE Band 7

RESULTS

Pass

6.1 LTE BAND 2

Band 2, UL Channel 18607, UL Frequency 1850.7, BW 1.4, NO. RB 6, RB POS. Low, QPSK

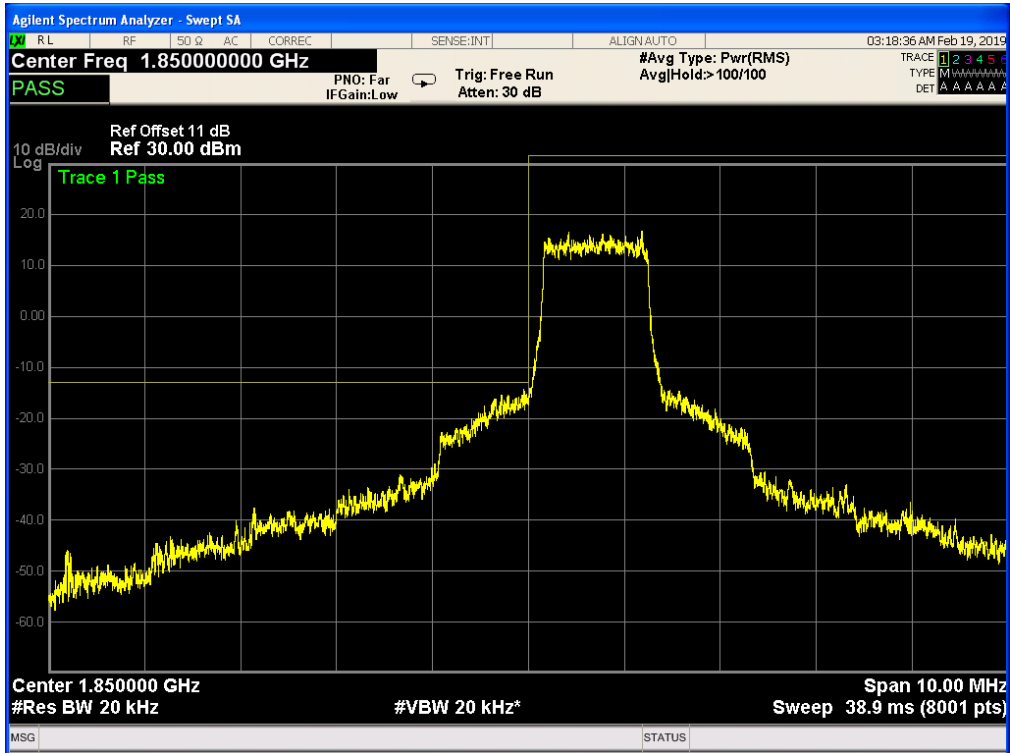

Band 2, UL Channel 18607, UL Frequency 1850.7, BW 1.4, NO. RB 6, RB POS. Low, QPSK

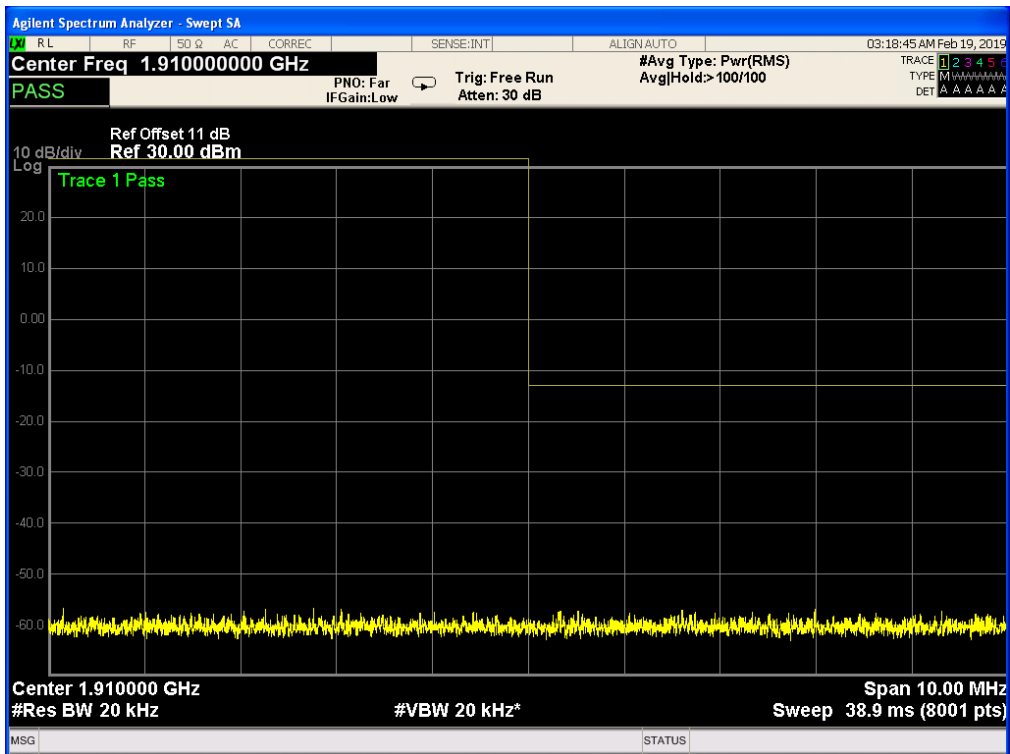

Band 2, UL Channel 18607, UL Frequency 1850.7, BW 1.4, NO. RB 6, RB POS. Low, 16QAM

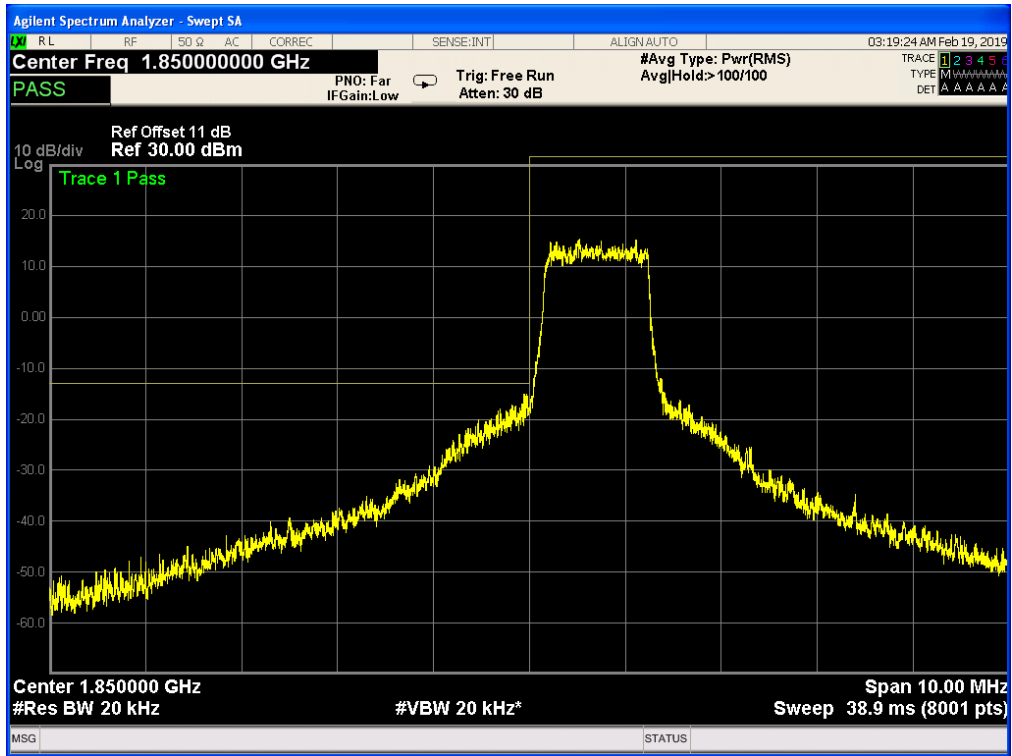

Band 2, UL Channel 18607, UL Frequency 1850.7, BW 1.4, NO. RB 6, RB POS. Low, 16QAM

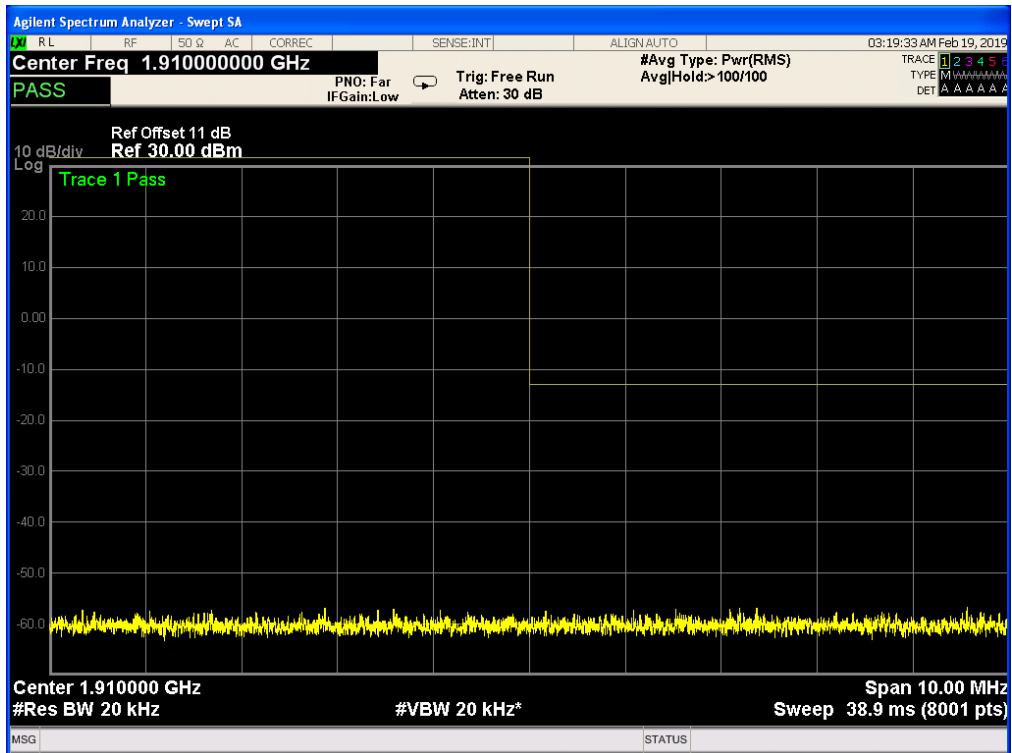

Band 2, UL Channel 19193, UL Frequency 1909.3, BW 1.4, NO. RB 6, RB POS. Low, QPSK

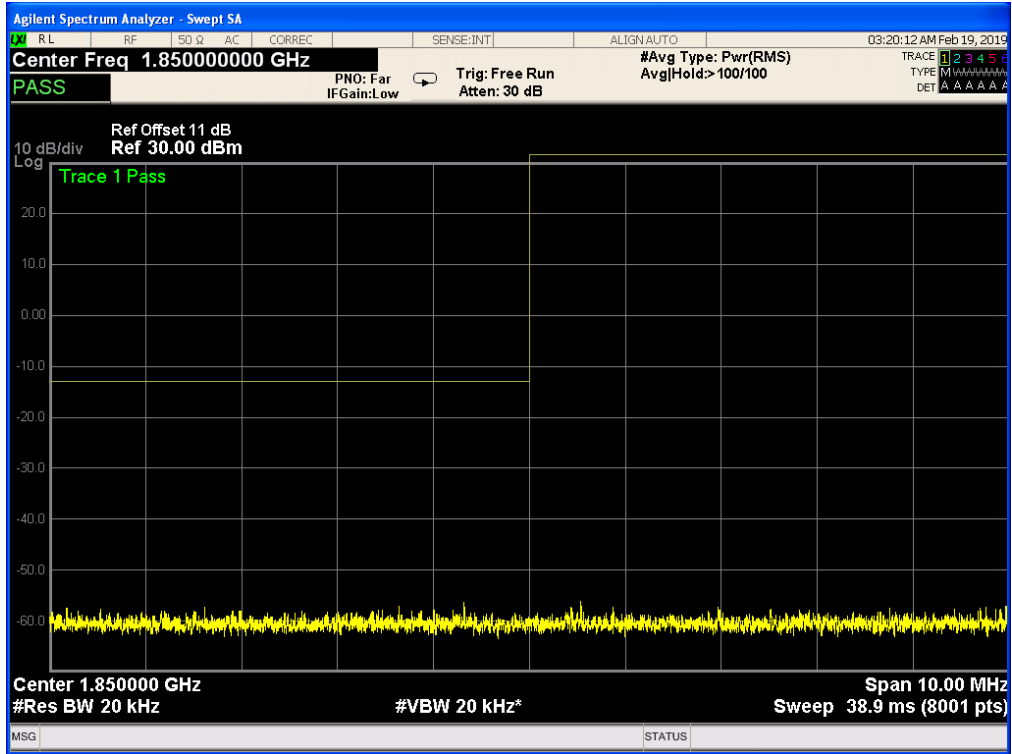

Band 2, UL Channel 19193, UL Frequency 1909.3, BW 1.4, NO. RB 6, RB POS. Low, QPSK

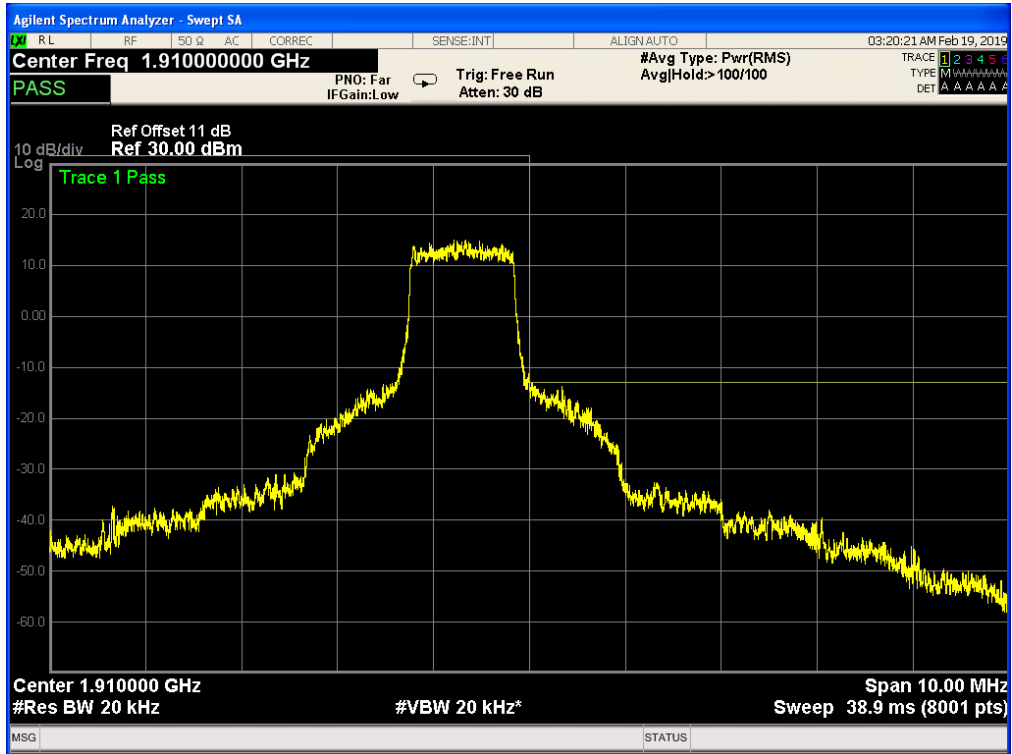

Band 2, UL Channel 19193, UL Frequency 1909.3, BW 1.4, NO. RB 6, RB POS. Low, 16QAM

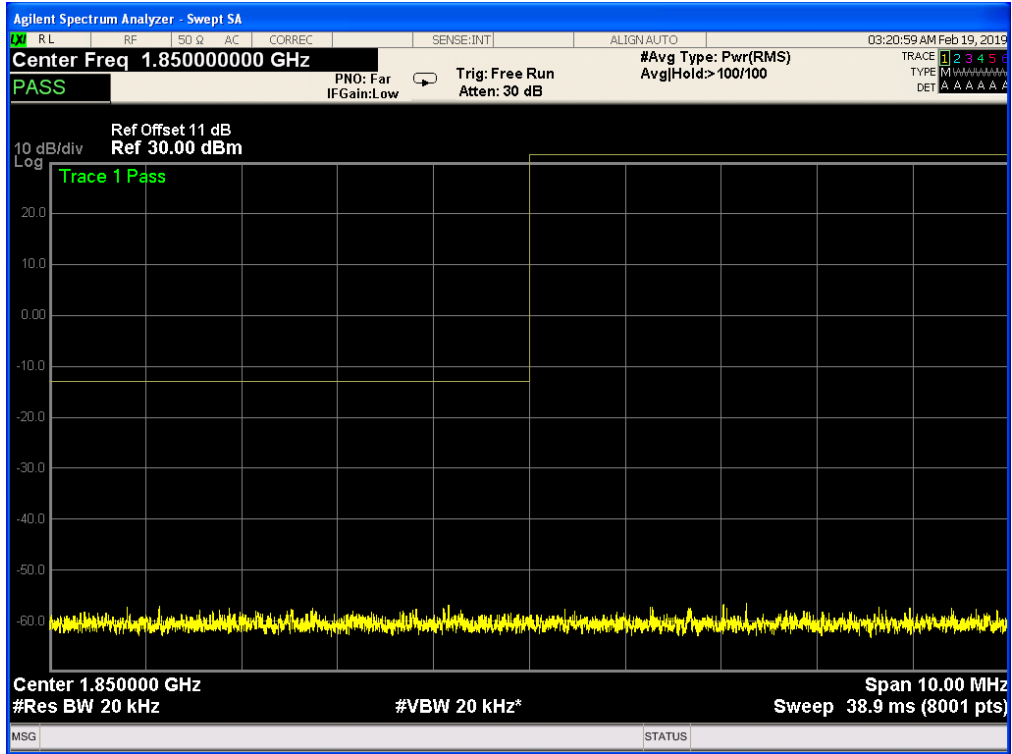

Band 2, UL Channel 19193, UL Frequency 1909.3, BW 1.4, NO. RB 6, RB POS. Low, 16QAM

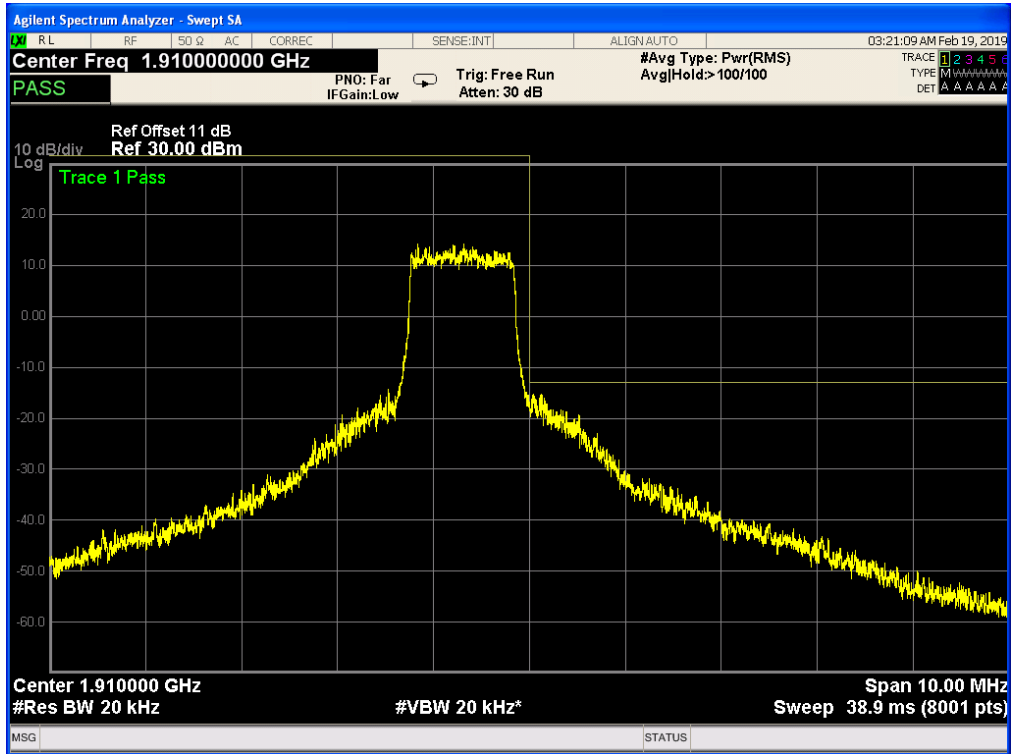

Band 2, UL Channel 18615, UL Frequency 1851.5, BW 3.0, NO. RB 15, RB POS. Low, QPSK

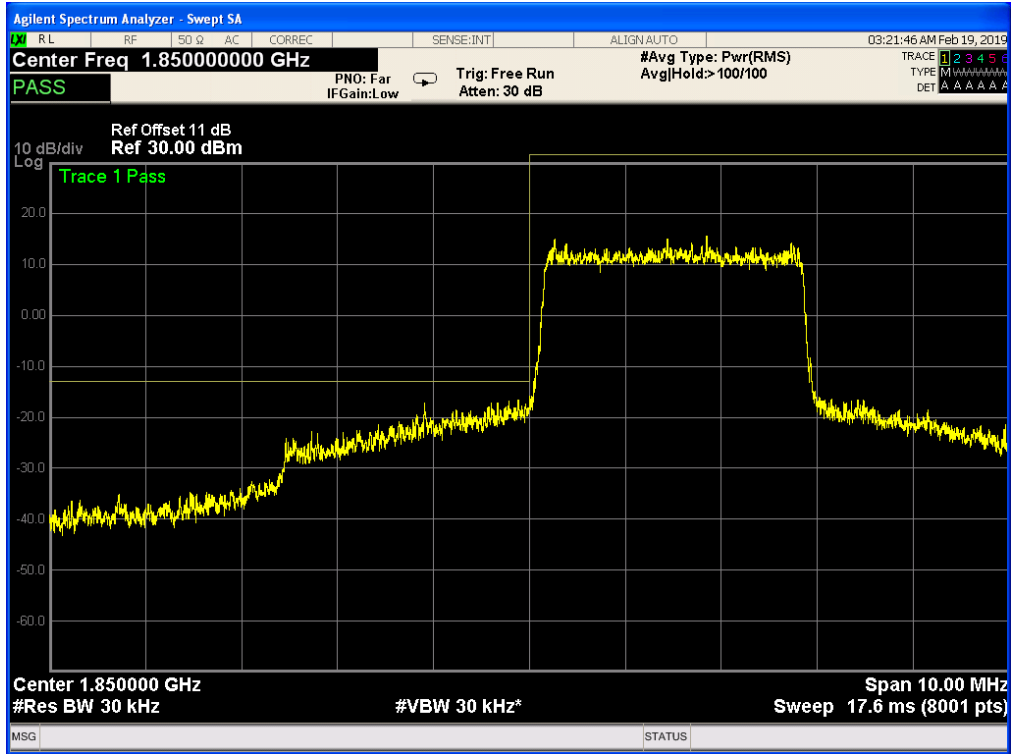

Band 2, UL Channel 18615, UL Frequency 1851.5, BW 3.0, NO. RB 15, RB POS. Low, QPSK

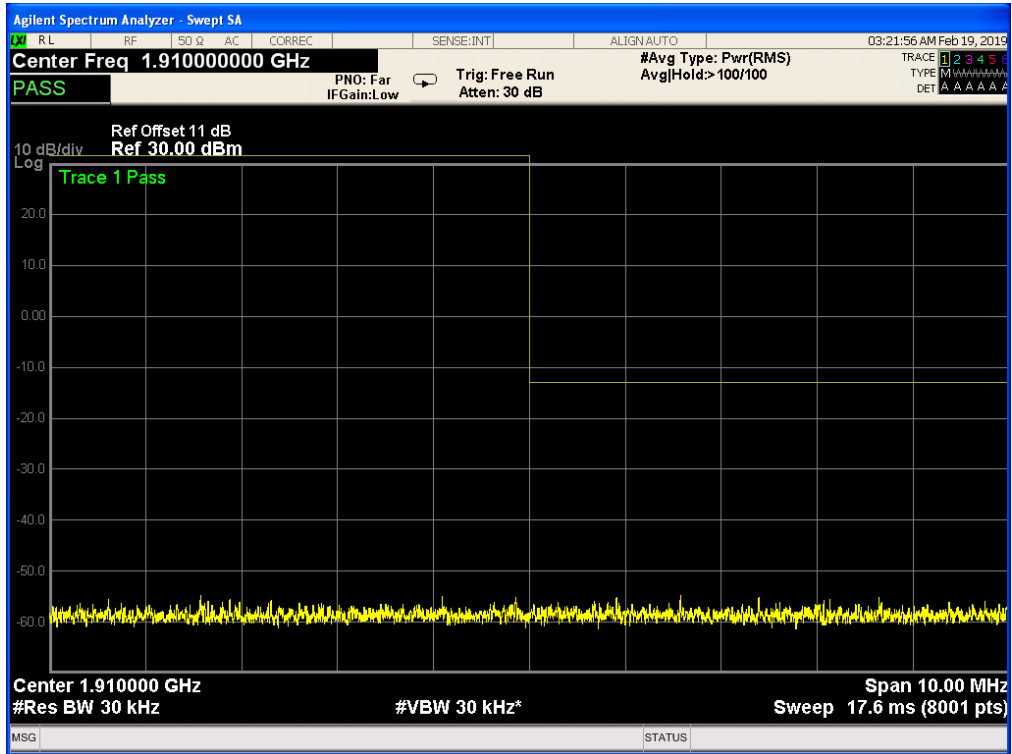

Band 2, UL Channel 18615, UL Frequency 1851.5, BW 3.0, NO. RB 15, RB POS. Low, 16QAM

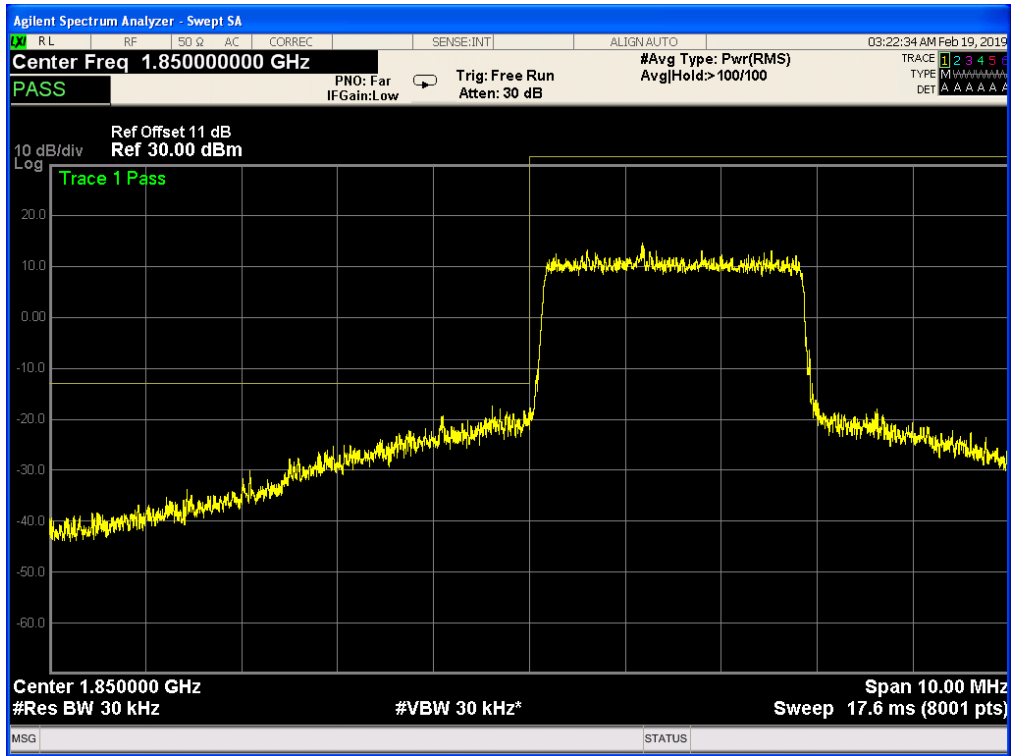

Band 2, UL Channel 18615, UL Frequency 1851.5, BW 3.0, NO. RB 15, RB POS. Low, 16QAM

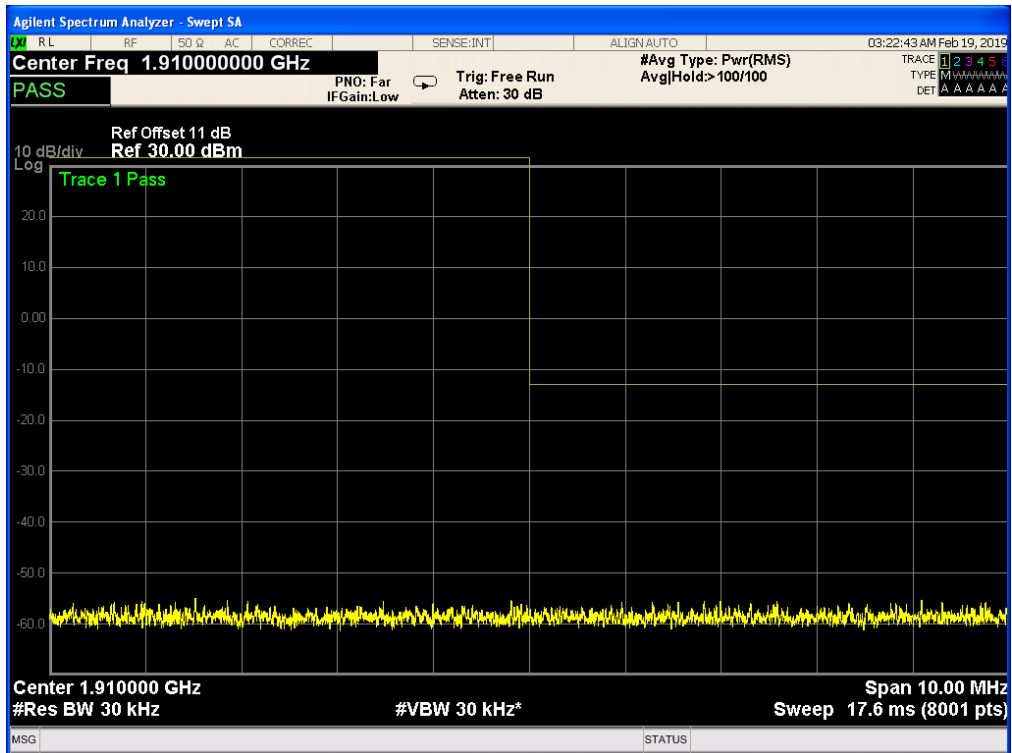

Band 2, UL Channel 19185, UL Frequency 1908.5, BW 3.0, NO. RB 15, RB POS. Low, QPSK

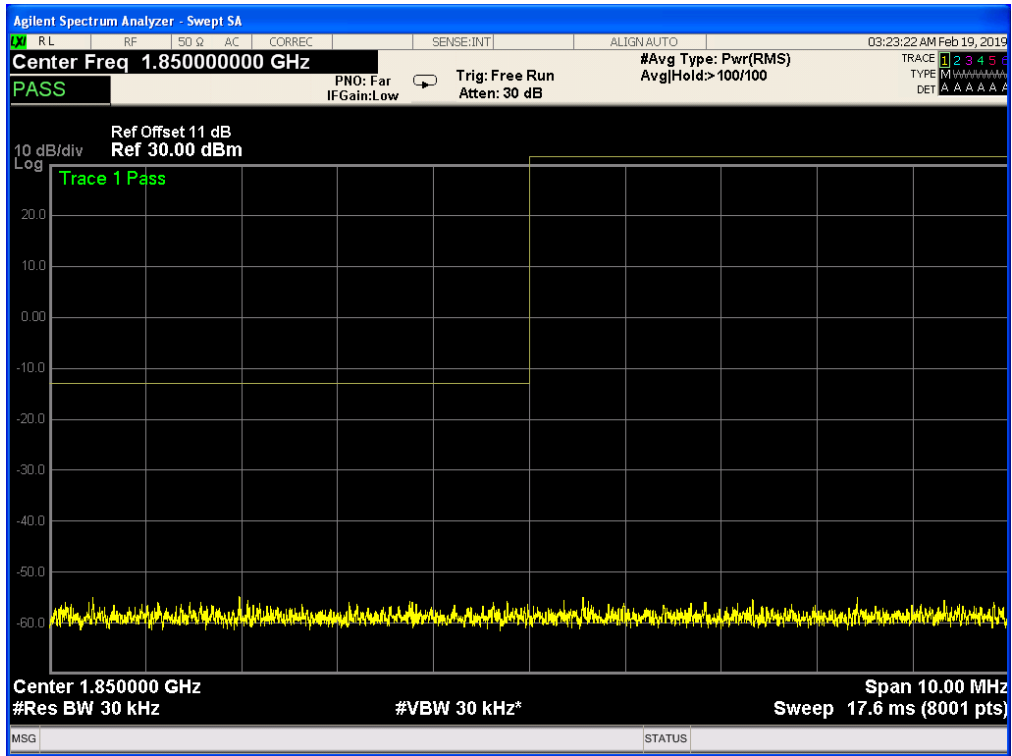

Band 2, UL Channel 19185, UL Frequency 1908.5, BW 3.0, NO. RB 15, RB POS. Low, QPSK

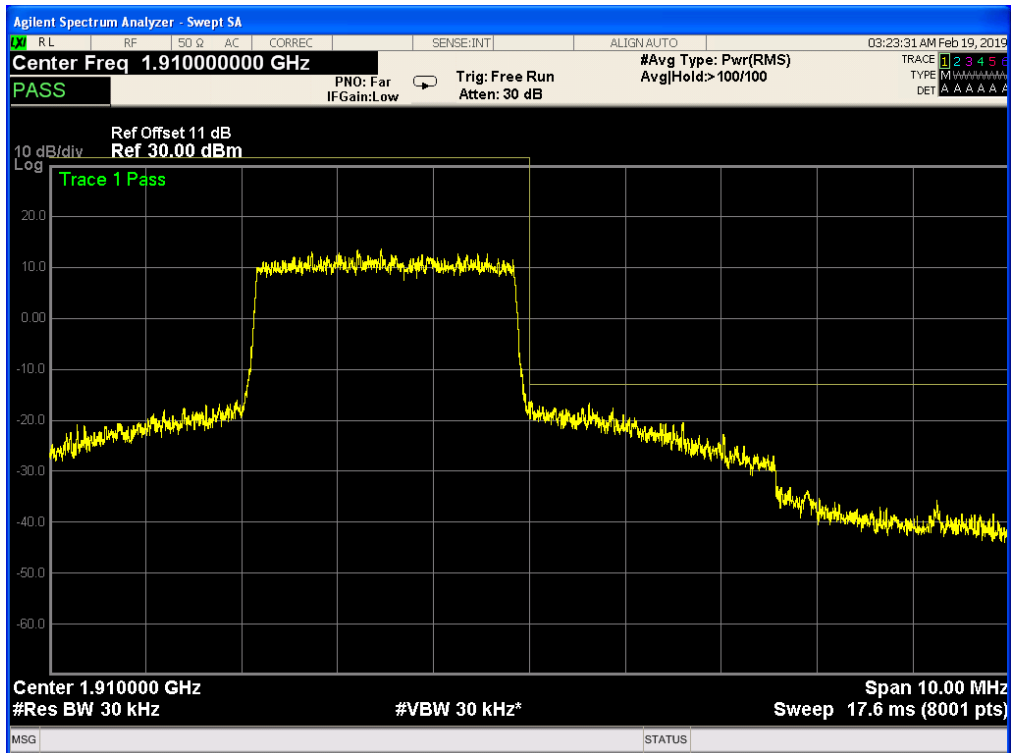

Band 2, UL Channel 19185, UL Frequency 1908.5, BW 3.0, NO. RB 15, RB POS. Low, 16QAM

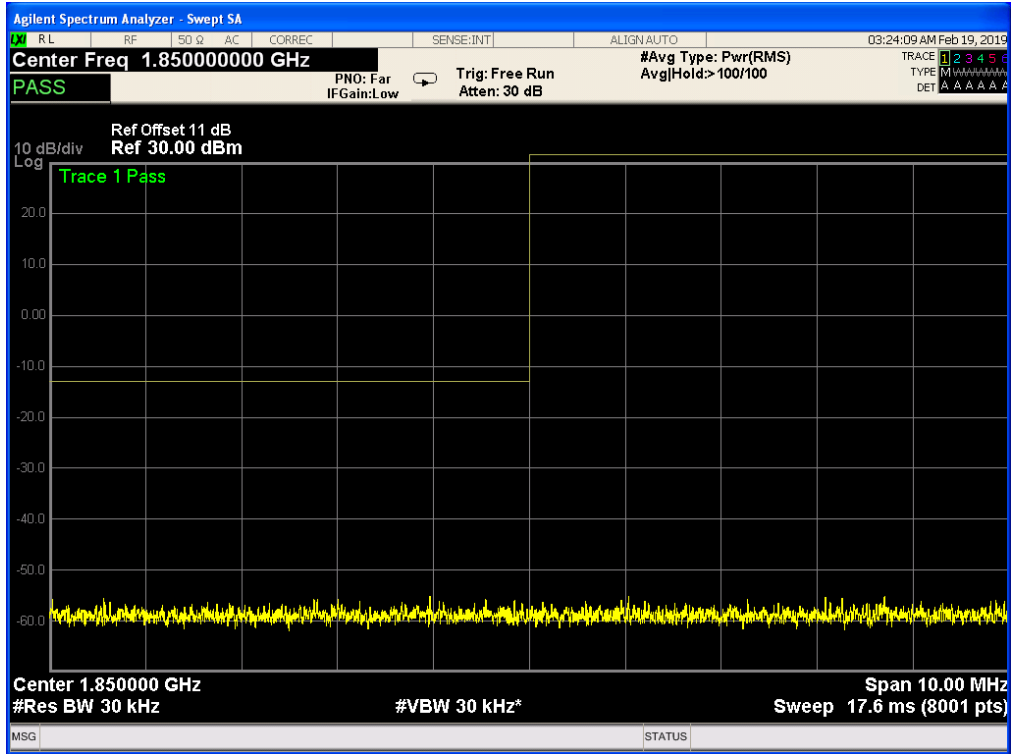

Band 2, UL Channel 19185, UL Frequency 1908.5, BW 3.0, NO. RB 15, RB POS. Low, 16QAM

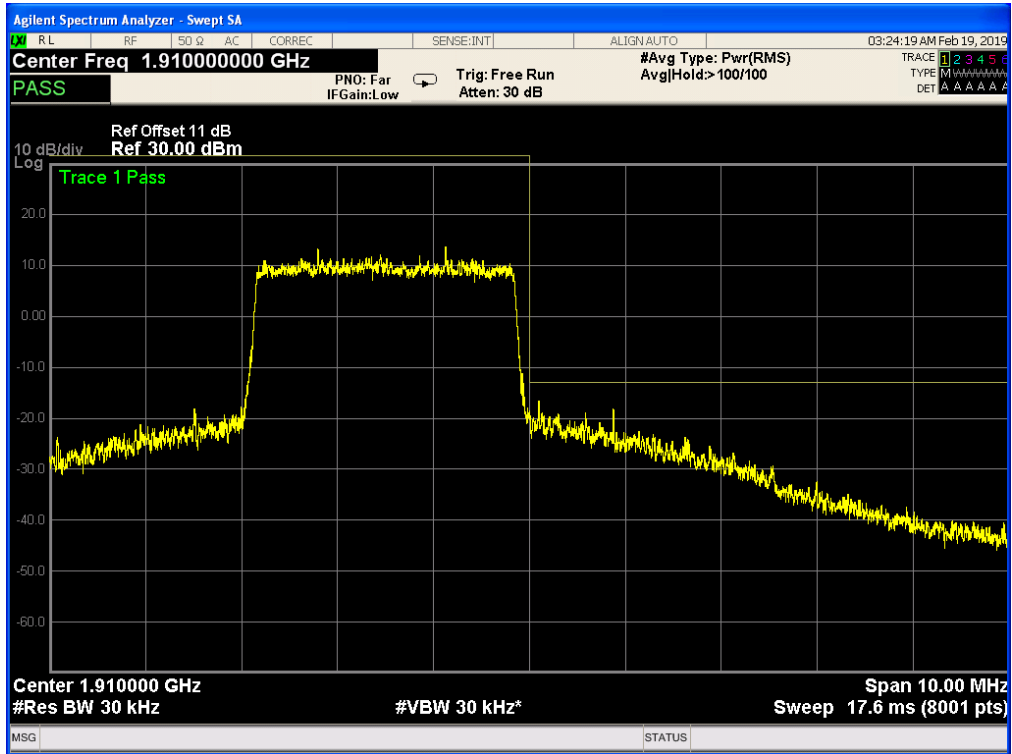

Band 2, UL Channel 18625, UL Frequency 1852.5, BW 5.0, NO. RB 25, RB POS. Low, QPSK

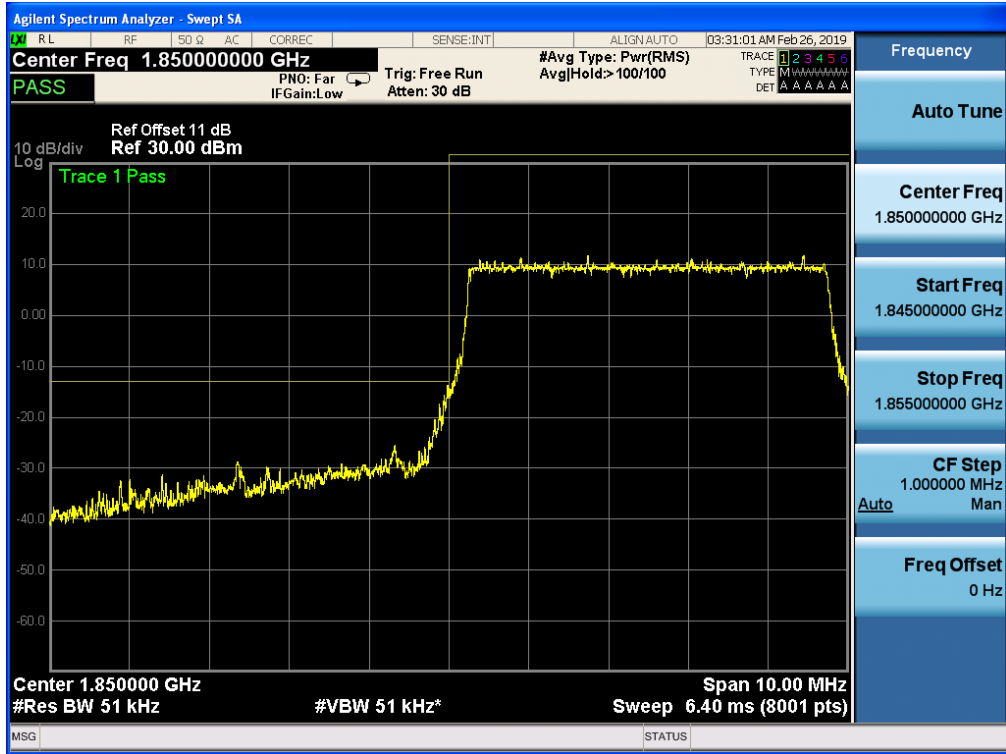

Band 2, UL Channel 18625, UL Frequency 1852.5, BW 5.0, NO. RB 25, RB POS. Low, QPSK

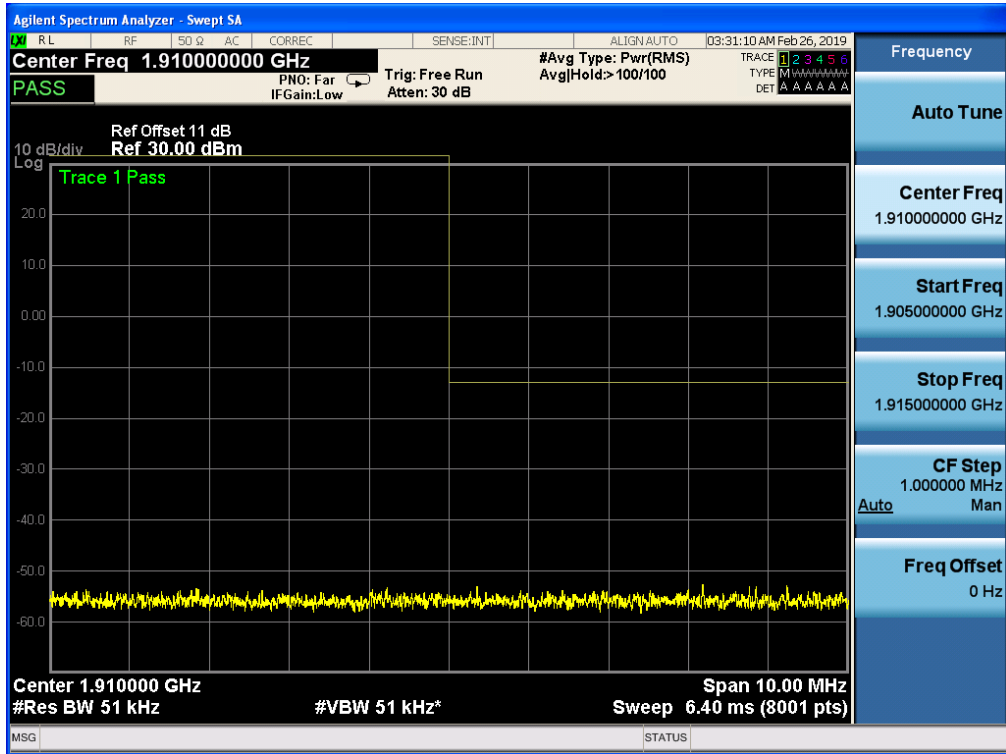

Band 2, UL Channel 18625, UL Frequency 1852.5, BW 5.0, NO. RB 25, RB POS. Low, 16QAM

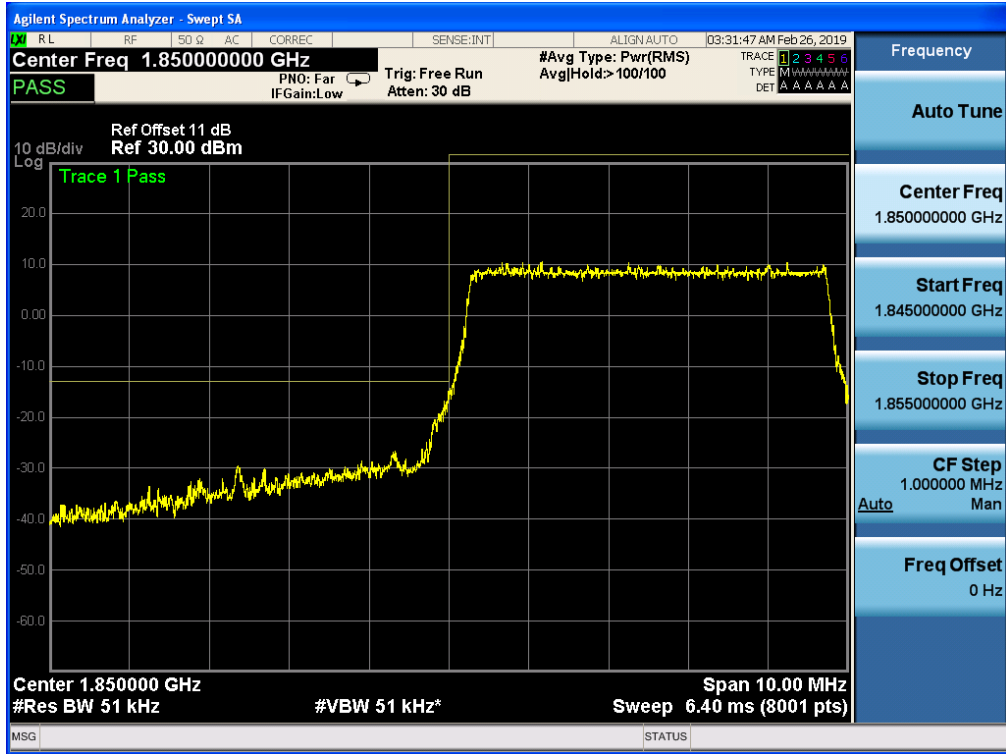

Band 2, UL Channel 18625, UL Frequency 1852.5, BW 5.0, NO. RB 25, RB POS. Low, 16QAM

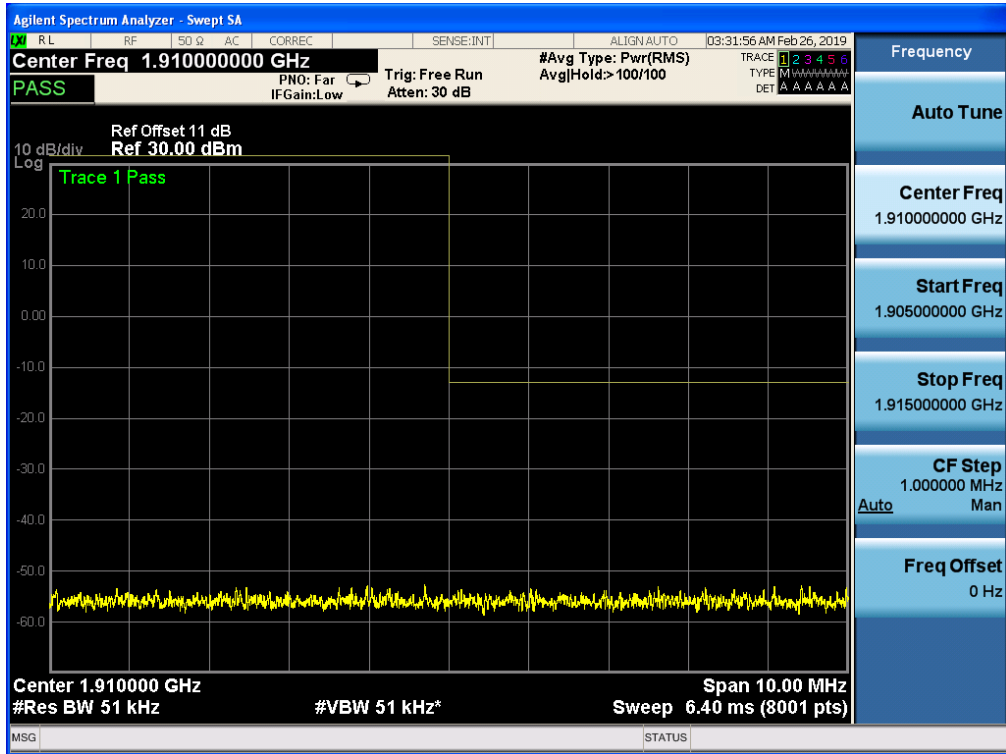

Band 2, UL Channel 19175, UL Frequency 1907.5, BW 5.0, NO. RB 25, RB POS. Low, QPSK

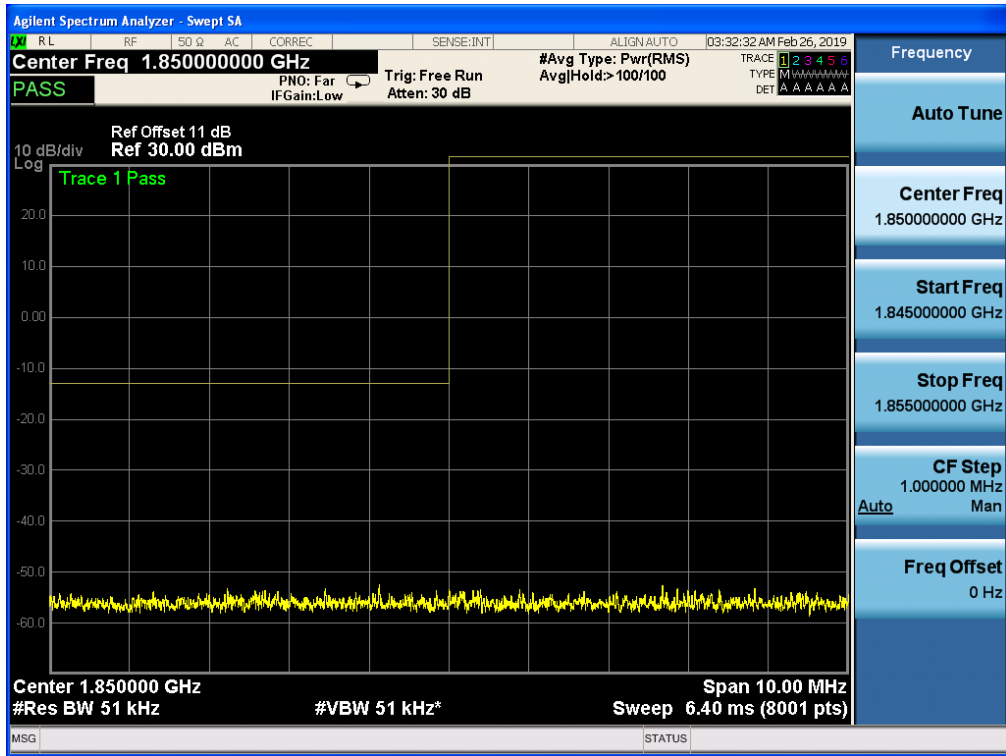

Band 2, UL Channel 19175, UL Frequency 1907.5, BW 5.0, NO. RB 25, RB POS. Low, QPSK

