

FCC SAR EVALUATION REPORT

In accordance with the requirements of
FCC 47 CFR Part 2(2.1093), ANSI/IEEE C95.1-1992 and
IEEE Std 1528-2013

Product Name : Mobile phone

Trademark : Bmobile

Model Name : AX1082

Family Model : N/A

Report No. : S18121903401001

FCC ID : ZSW-30-081

Prepared for

b mobile HK Limited

Flat 18; 14/F Block 1; Golden Industrial Building; 16-26 KwaiTak Street; Kwai Chung;
New Territories; Hong Kong, China

Prepared by

Shenzhen NTEK Testing Technology Co., Ltd.

1/F, Building E, Fenda Science Park, Sanwei Community, Xixiang Street,
Bao'an District, Shenzhen 518126 P.R.China.

Tel.: +86-755-6115 6588 Fax.: +86-755-6115 6599

Website: <http://www.ntek.org.cn>

TEST RESULT CERTIFICATION

Applicant's name: b mobile HK Limited
 Address.....: Flat 18; 14/F Block 1; Golden Industrial Building;16-26 KwaiTak
 Street; Kwai Chung; New Territories; Hong Kong, China
Manufacturer's Name.....: b mobile HK Limited
 Address.....: Flat 18; 14/F Block 1; Golden Industrial Building;16-26 KwaiTak
 Street; Kwai Chung; New Territories; Hong Kong, China

Product description

Product name.....: Mobile phone
 Trademark: Bmobile
 Model Name: AX1082
 Family Model.....: N/A
 FCC 47 CFR Part 2(2.1093)

Standards: ANSI/IEEE C95.1-1992
 IEEE Std 1528-2013
 Published RF exposure KDB procedures

This device described above has been tested by Shenzhen NTEK. In accordance with the measurement methods and procedures specified in IEEE Std 1528-2013 and KDB 865664 D01. Testing has shown that this device is capable of compliance with localized specific absorption rate (SAR) specified in FCC 47 CFR Part 2(2.1093) and ANSI/IEEE C95.1-1992. The test results in this report apply only to the tested sample of the stated device/equipment. Other similar device/equipment will not necessarily produce the same results due to production tolerance and measurement uncertainties.

This report shall not be reproduced except in full, without the written approval of Shenzhen NTEK, this document may be altered or revised by Shenzhen NTEK, personal only, and shall be noted in the revision of the document.

Date of Test

Date (s) of performance of tests: Dec. 25, 2018 ~ Jan. 08, 2019
 Date of Issue: Jan. 08, 2019
 Test Result.....: **Pass**

Prepared By : Cheng Jiawen
 (Test Engineer) :
 (Cheng Jiawen)

Approved By : Sam Chen
 (Lab Manager) :
 (Sam Chen)

※ ※ Revision History ※ ※

REV.	DESCRIPTION	ISSUED DATE	REMARK
Rev.1.0	Initial Test Report Release	Jan. 08, 2019	Cheng Jiawen

TABLE OF CONTENTS

1.	General Information	6
1.1.	RF exposure limits	6
1.2.	Statement of Compliance.....	7
1.3.	EUT Description	8
1.4.	Test specification(s)	10
1.5.	Ambient Condition	10
2.	SAR Measurement System	11
2.1.	SATIMO SAR Measurement Set-up Diagram	11
2.2.	Robot	12
2.3.	E-Field Probe.....	13
2.3.1.	E-Field Probe Calibration.....	13
2.4.	SAM phantoms	14
2.4.1.	Technical Data	15
2.5.	Device Holder	16
2.6.	Test Equipment List	17
3.	SAR Measurement Procedures	19
3.1.	Power Reference.....	19
3.2.	Area scan & Zoom scan	19
3.3.	Description of interpolation/extrapolation scheme	21
3.4.	Volumetric Scan	21
3.5.	Power Drift	21
4.	System Verification Procedure.....	22
4.1.	Tissue Verification.....	22
4.1.1.	Tissue Dielectric Parameter Check Results	23
4.2.	System Verification Procedure	24
4.2.1.	System Verification Results	25
5.	SAR Measurement variability and uncertainty	26
5.1.	SAR measurement variability	26
5.2.	SAR measurement uncertainty.....	26
6.	RF Exposure Positions	27
6.1.	Ear and handset reference point.....	27
6.2.	Definition of the cheek position	27
6.3.	Definition of the tilt position.....	29
6.4.	Body Worn Accessory	29
6.5.	Wireless Router Devices.....	30
7.	RF Output Power	31
7.1.	Maximum Tune-up Limit	31
7.2.	GSM Conducted Power	32
7.3.	WCDMA Conducted Power.....	32

- 7.4. LTE Conducted Power..... 33
- 7.5. WLAN & Bluetooth Output Power..... 43
 - 7.5.1. Output Power Results Of WLAN 43
 - 7.5.2. Output Power Results Of Bluetooth 43
- 8. Antenna Location..... 44
- 9. Stand-alone SAR test exclusion..... 45
- 10. SAR Results 46
 - 10.1. SAR measurement results 46
 - 10.1.1. SAR measurement Result of GSM850..... 46
 - 10.1.2. SAR measurement Result of GSM1900..... 46
 - 10.1.3. SAR measurement Result of WCDMA Band V..... 47
 - 10.1.4. SAR measurement Result of WCDMA Band II..... 48
 - 10.1.5. SAR measurement Result of LTE Band V 49
 - 10.1.6. SAR measurement Result of LTE Band IV 50
 - 10.1.7. SAR measurement Result of LTE Band II 52
 - 10.1.8. SAR measurement Result of LTE Band VII 54
 - 10.1.9. SAR measurement Result of WLAN 2.4G..... 55
 - 10.2. SAR Summation Scenario 56
- 11. Appendix A. Photo documentation..... 63
- 12. Appendix B. System Check Plots 64
- 13. Appendix C. Plots of High SAR Measurement 85
- 14. Appendix D. Calibration Certificate..... 122

1. General Information

1.1. RF exposure limits

(A).Limits for Occupational/Controlled Exposure (W/kg)

Whole-Body	Partial-Body	Hands, Wrists, Feet and Ankles
0.4	8.0	20.0

(B).Limits for General Population/Uncontrolled Exposure (W/kg)

Whole-Body	Partial-Body	Hands, Wrists, Feet and Ankles
0.08	1.6	4.0

NOTE: **Whole-Body SAR** is averaged over the entire body, **partial-body SAR** is averaged over any 1 gram of tissue defined as a tissue volume in the shape of a cube. **SAR for hands, wrists, feet and ankles** is averaged over any 10 grams of tissue defined as a tissue volume in the shape of a cube.

Occupational/Controlled Environments:

Are defined as locations where there is exposure that may be incurred by people who are aware of the potential for exposure, (i.e. as a result of employment or occupation).

General Population/Uncontrolled Environments:

Are defined as locations where there is the exposure of individuals who have no knowledge or control of their exposure.

NOTE
 HEAD AND TRUNK LIMIT
 1.6 W/kg
 APPLIED TO THIS EUT

1.2. Statement of Compliance

The maximum results of Specific Absorption Rate (SAR) found during testing for AX1082 are as follows.

Band	Max Reported SAR Value(W/kg)			Max Simultaneous Tx
	1-g Head	1-g Body-Worn (Separation distance of 10mm)	1-g Hotspot (Separation distance of 10mm)	
GSM 850	0.198	0.230	0.230	0.669
GSM 1900	0.107	0.323	0.323	
WCDMA Band V	0.166	0.187	0.187	
WCDMA Band II	0.184	0.545	0.545	
LTE Band V	0.200	0.210	0.210	
LTE Band IV	0.209	0.455	0.455	
LTE Band II	0.189	0.511	0.517	
LTE Band VII	0.173	0.276	0.590	
WLAN 2.4G	0.302	0.124	0.124	

Note: The Max Simultaneous Tx is calculated based on the same configuration and test position. This device is in compliance with Specific Absorption Rate (SAR) for general population/uncontrolled exposure limits (1.6 W/kg) specified in FCC 47 CFR Part 2(2.1093) and ANSI/IEEE C95.1-1992, and had been tested in accordance with the measurement methods and procedures specified in IEEE Std 1528-2013 & KDB 865664 D01.

1.3. EUT Description

Device Information			
Product Name	Mobile phone		
Trade Name	Bmobile		
Model Name	AX1082		
Family Model	N/A		
FCC ID	ZSW-30-081		
Device Phase	Identical Prototype		
Exposure Category	General population / Uncontrolled environment		
Antenna	FPCB Antenna		
Battery Information	DC 3.8V, 2500mAh		
Device Operating Configurations			
Supporting Mode(s)	GSM 850/1900, WCDMA Band V/II, LTE Band V/IV/III/VII, WLAN 2.4G, Bluetooth		
Test Modulation	GSM(GMSK/8PSK), WCDMA(QPSK), LTE(QPSK/16QAM), WLAN(DSSSS/OFDM), Bluetooth(GFSK, $\pi/4$ -DQPSK, 8DPSK)		
Device Class	B		
Operating Frequency Range(s)	Band	Tx (MHz)	Rx (MHz)
	GSM 850	824-849	869-894
	GSM 1900	1850-1910	1930-1990
	WCDMA Band V	824-849	869-894
	WCDMA Band II	1850-1910	1930-1990
	LTE Band V	824-849	869-894
	LTE Band IV	1710-1755	2110-2155
	LTE Band II	1850-1910	1930-1990
	LTE Band VII	2500-2570	2620-2690
	WLAN 2.4G	2412-2462	
	Bluetooth	2402-2480	
	GPRS Multislot Class(12)	Max Number of Timeslots in Uplink	
Max Number of Timeslots in Downlink		4	
Max Total Timeslot		5	
EDGE Multislot Class(12)	Max Number of Timeslots in Uplink		4
	Max Number of Timeslots in Downlink		4
	Max Total Timeslot		5
Power Class	4, tested with power level 5(GSM 850)		
	1, tested with power level 0(GSM 1900)		
	3, tested with power control -all 1"(WCDMA Band V)		
	3, tested with power control -all 1"(WCDMA Band II)		
	3, tested with power control all Max.(LTE Band V)		

	3, tested with power control all Max.(LTE Band IV)
	3, tested with power control all Max.(LTE Band II)
	3, tested with power control all Max.(LTE Band VII)
Test Channels (low-mid-high)	128-189-251(GSM 850)
	512-661-810(GSM 1900)
	4132-4182-4233(WCDMA Band V)
	9262-9400-9538(WCDMA Band II)
	20407-20525-20643(LTE Band V BW=1.4MHz)
	20415-20525-20635(LTE Band V BW=3MHz)
	20425-20525-20625(LTE Band V BW=5MHz)
	20450-20525-20600(LTE Band V BW=10MHz)
	19957-20175-20393(LTE Band IV BW=1.4MHz)
	19965-20175-20385(LTE Band IV BW=3MHz)
	19975-20175-20375(LTE Band IV BW=5MHz)
	20000-20175-20350(LTE Band IV BW=10MHz)
	20025-20175-20325(LTE Band IV BW=15MHz)
	20050-20175-20300(LTE Band IV BW=20MHz)
	18607-18900-19193(LTE Band II BW=1.4MHz)
	18615-18900-19185(LTE Band II BW=3MHz)
	18625-18900-19175(LTE Band II BW=5MHz)
	18650-18900-19150(LTE Band II BW=10MHz)
	18675-18900-19125(LTE Band II BW=15MHz)
	18700-18900-19100(LTE Band II BW=20MHz)
	20775-21100-21425(LTE Band VII BW=5MHz)
	20800-21100-21400(LTE Band VII BW=10MHz)
	20825-21100-21375(LTE Band VII BW=15MHz)
20850-21100-21350(LTE Band VII BW=20MHz)	
1-6-11(WLAN 2.4G)	

1.4. Test specification(s)

FCC 47 CFR Part 2(2.1093)
ANSI/IEEE C95.1-1992
IEEE Std 1528-2013
KDB 865664 D01 SAR measurement 100 MHz to 6 GHz
KDB 865664 D02 RF Exposure Reporting
KDB 447498 D01 General RF Exposure Guidance
KDB 248227 D01 802.11 Wi-Fi SAR
KDB 941225 D01 3G SAR Procedures
KDB 941225 D05 SAR for LTE Devices
KDB 941225 D06 Hotspot SAR
KDB 648474 D04 Handset SAR

1.5. Ambient Condition

Ambient temperature	20°C – 24°C
Relative Humidity	30% – 70%

2. SAR Measurement System

2.1. SATIMO SAR Measurement Set-up Diagram

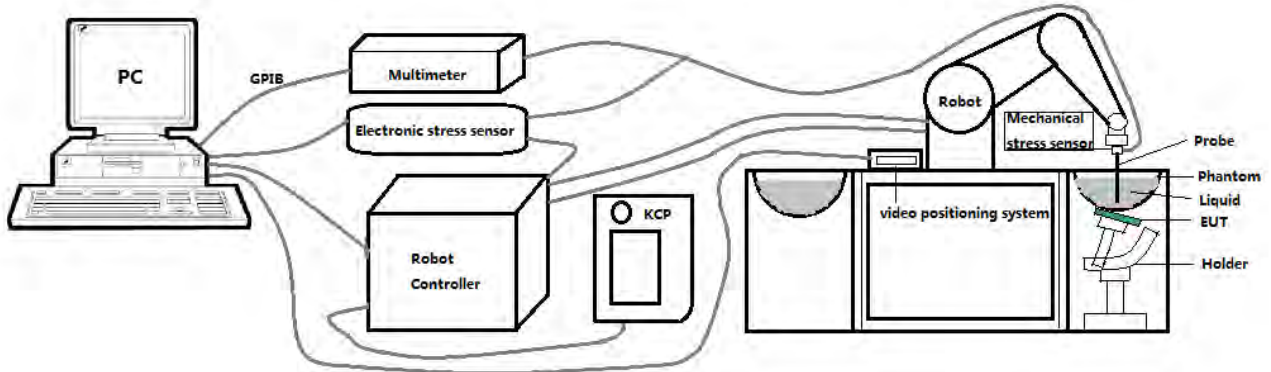

These measurements were performed with the automated near-field scanning system OPENSAR from SATIMO. The system is based on a high precision robot (working range: 901 mm), which positions the probes with a positional repeatability of better than ± 0.03 mm. The SAR measurements were conducted with dosimetric probe (manufactured by SATIMO), designed in the classical triangular configuration and optimized for dosimetric evaluation.

The first step of the field measurement is the evaluation of the voltages induced on the probe by the device under test. Probe diode detectors are nonlinear. Below the diode compression point, the output voltage is proportional to the square of the applied E-field; above the diode compression point, it is linear to the applied E-field. The compression point depends on the diode, and a calibration procedure is necessary for each sensor of the probe.

The Keithley multimeter reads the voltage of each sensor and send these three values to the PC. The corresponding E field value is calculated using the probe calibration factors, which are stored in the working directory. This evaluation includes linearization of the diode characteristics. The field calculation is done separately for each sensor. Each component of the E field is displayed on the "Dipole Area Scan Interface" and the total E field is displayed on the "3D Interface"

2.2. Robot

The SATIMO SAR system uses the high precision robots from KUKA. For the 6-axis controller system, the robot controller version (KUKA) from KUKA is used. The KUKA robot series have many features that are important for our application:



- High precision (repeatability ± 0.03 mm)
- High reliability (industrial design)
- Jerk-free straight movements
- Low ELF interference (the closed metallic construction shields against motor control fields)

2.3. E-Field Probe

This E-field detection probe is composed of three orthogonal dipoles linked to special Schottky diodes with low detection thresholds. The probe allows the measurement of electric fields in liquids such as the one defined in the IEEE and CENELEC standards.

For the measurements the Specific Dosimetric E-Field Probe SN 08/16 EPGO287 with following specifications is used



- Dynamic range: 0.01-100 W/kg
 - Tip Diameter: 2.5 mm
 - Distance between probe tip and sensor center: 1 mm
 - Distance between sensor center and the inner phantom surface: 2 mm (repeatability better than ± 1 mm).
 - Probe linearity: ± 0.08 dB
 - Axial isotropy: 0.06 dB
 - Hemispherical Isotropy: 0.08 dB
 - Calibration range: 650MHz to 5900MHz for head & body simulating liquid.
 - Lower detection limit: 7mW/kg
- Angle between probe axis (evaluation axis) and surface normal line: less than 30° .

2.3.1. E-Field Probe Calibration

Each probe needs to be calibrated according to a dosimetric assessment procedure with accuracy better than $\pm 10\%$. The spherical isotropy shall be evaluated and within ± 0.25 dB. The sensitivity parameters (Norm X, Norm Y, and Norm Z), the diode compression parameter (DCP) and the conversion factor (Conv F) of the probe are tested. The calibration data can be referred to appendix D of this report.

2.4. SAM phantoms

Photo of SAM phantom SN 16/15 SAM119



The SAM phantom is used to measure the SAR relative to people exposed to electro-magnetic field radiated by mobile phones.

2.4.1. Technical Data

Serial Number	Shell thickness	Filling volume	Dimensions	Positionner Material	Permittivity	Loss Tangent
SN 16/15 SAM119	2 mm ±0.2 mm	27 liters	Length:1000 mm Width:500 mm Height:200 mm	Gelcoat with fiberglass	3.4	0.02

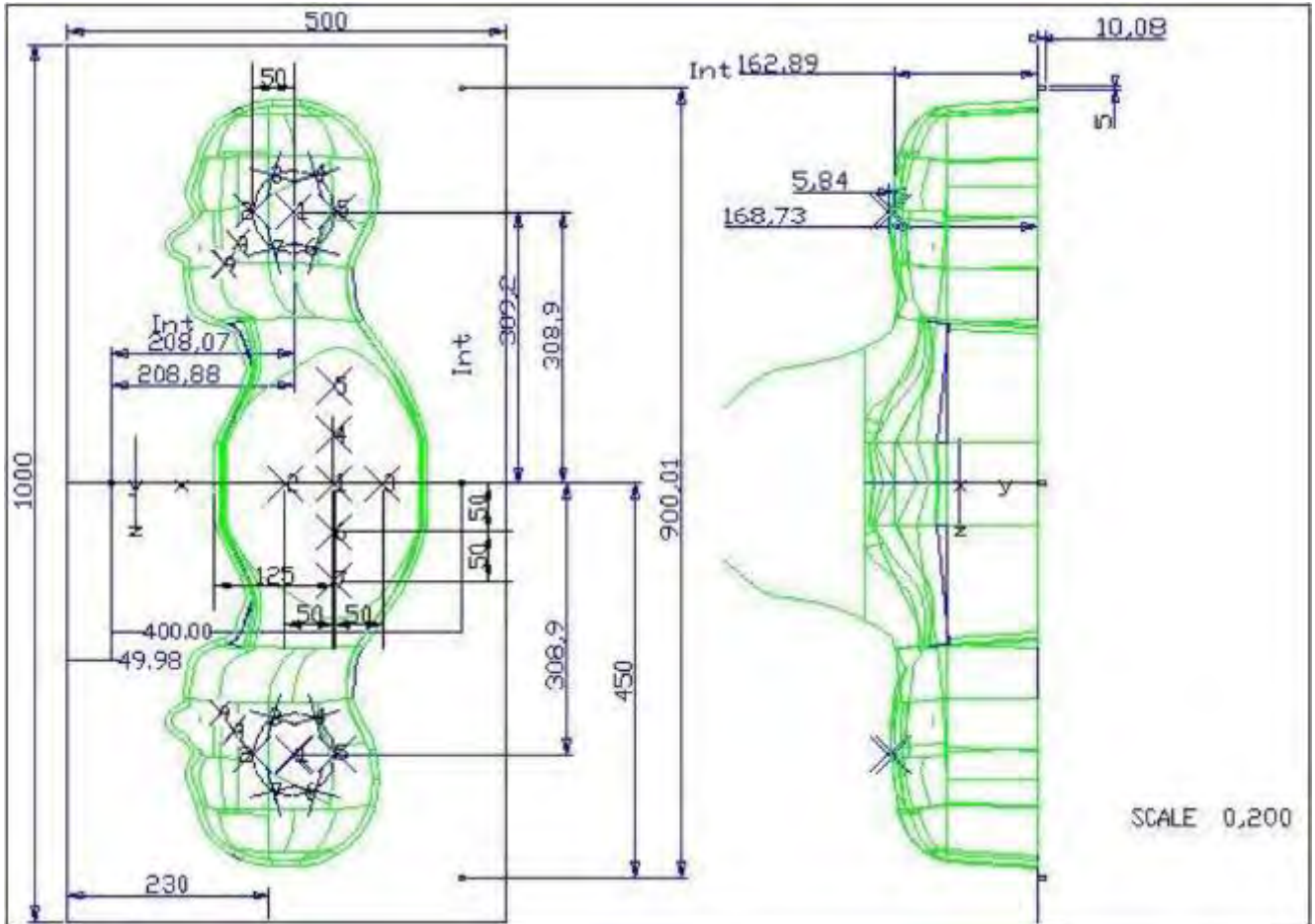

Serial Number	Left Head(mm)		Right Head(mm)		Flat Part(mm)	
	1	2	1	2	1	2
SN 16/15 SAM119	2	2.02	2	2.08	1	2.09
	3	2.05	3	2.06	2	2.06
	4	2.07	4	2.07	3	2.08
	5	2.08	5	2.08	4	2.10
	6	2.05	6	2.07	5	2.10
	7	2.05	7	2.05	6	2.07
	8	2.07	8	2.06	7	2.07
	9	2.08	9	2.06	-	-

The test, based on ultrasonic system, allows measuring the thickness with an accuracy of 10 µm.

2.5. Device Holder

The positioning system allows obtaining cheek and tilting position with a very good accuracy. In compliance with CENELEC, the tilt angle uncertainty is lower than 1 degree.

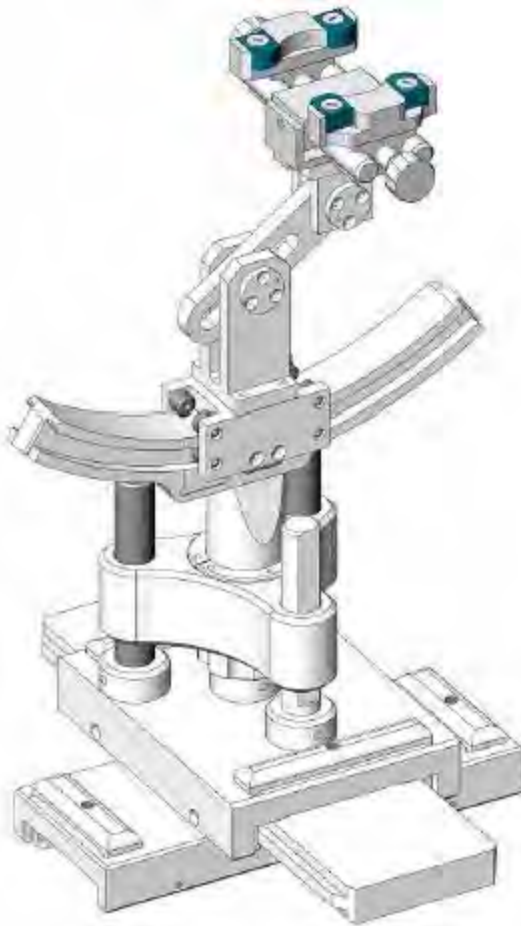

Serial Number	Holder Material	Permittivity	Loss Tangent
SN 16/15 MSH100	Delrin	3.7	0.005

2.6. Test Equipment List

This table gives a complete overview of the SAR measurement equipment.

Devices used during the test described are marked

	Manufacturer	Name of Equipment	Type/Model	Serial Number	Calibration	
					Last Cal.	Due Date
<input checked="" type="checkbox"/>	MVG	E FIELD PROBE	SSE2	SN 08/16 EPGO287	Sep. 17, 2018	Sep. 16, 2019
<input type="checkbox"/>	MVG	750 MHz Dipole	SID750	SN 03/15 DIP 0G750-355	Apr. 19, 2018	Apr. 18, 2021
<input checked="" type="checkbox"/>	MVG	835 MHz Dipole	SID835	SN 03/15 DIP 0G835-347	Apr. 19, 2018	Apr. 18, 2021
<input type="checkbox"/>	MVG	900 MHz Dipole	SID900	SN 03/15 DIP 0G900-348	Apr. 19, 2018	Apr. 18, 2021
<input checked="" type="checkbox"/>	MVG	1800 MHz Dipole	SID1800	SN 03/15 DIP 1G800-349	Apr. 19, 2018	Apr. 18, 2021
<input checked="" type="checkbox"/>	MVG	1900 MHz Dipole	SID1900	SN 03/15 DIP 1G900-350	Apr. 19, 2018	Apr. 18, 2021
<input type="checkbox"/>	MVG	2000 MHz Dipole	SID2000	SN 03/15 DIP 2G000-351	Apr. 19, 2018	Apr. 18, 2021
<input checked="" type="checkbox"/>	MVG	2450 MHz Dipole	SID2450	SN 03/15 DIP 2G450-352	Apr. 19, 2018	Apr. 18, 2021
<input checked="" type="checkbox"/>	MVG	2600 MHz Dipole	SID2600	SN 03/15 DIP 2G600-356	Apr. 19, 2018	Apr. 18, 2021
<input type="checkbox"/>	MVG	5000 MHz Dipole	SWG5500	SN 13/14 WGA 33	Apr. 19, 2018	Apr. 18, 2021
<input checked="" type="checkbox"/>	MVG	Liquid measurement Kit	SCLMP	SN 21/15 OCPG 72	NCR	NCR
<input checked="" type="checkbox"/>	MVG	Power Amplifier	N.A	AMPLISAR_28/14_003	NCR	NCR
<input checked="" type="checkbox"/>	KEITHLEY	Millivoltmeter	2000	4072790	NCR	NCR
<input checked="" type="checkbox"/>	R&S	Universal radio communication tester	CMU200	117858	Aug. 05, 2018	Aug. 04, 2019
<input checked="" type="checkbox"/>	R&S	Wideband radio communication tester	CMW500	103917	Oct. 08, 2018	Oct. 07, 2019
<input checked="" type="checkbox"/>	HP	Network Analyzer	8753D	3410J01136	Aug. 05, 2018	Aug. 04, 2019
<input checked="" type="checkbox"/>	Agilent	PSG Analog Signal Generator	E8257D	MY51110112	Aug. 05, 2018	Aug. 04, 2019

<input checked="" type="checkbox"/>	Agilent	Power meter	E4419B	MY45102538	Aug. 05, 2018	Aug. 04, 2019
<input checked="" type="checkbox"/>	Agilent	Power sensor	E9301A	MY41495644	Aug. 05, 2018	Aug. 04, 2019
<input checked="" type="checkbox"/>	Agilent	Power sensor	E9301A	US39212148	Aug. 05, 2018	Aug. 04, 2019
<input checked="" type="checkbox"/>	MCLI/USA	Directional Coupler	CB11-20	0D2L51502	Aug. 05, 2018	Aug. 04, 2019

3. SAR Measurement Procedures

The measurement procedures are as follows:

<Conducted power measurement>

- (a) For WWAN power measurement, use base station simulator to configure EUT WWAN transmission in conducted connection with RF cable, at maximum power in each supported wireless interface and frequency band.
- (b) Read the WWAN RF power level from the base station simulator.
- (c) For WLAN/Bluetooth power measurement, use engineering software to configure EUT WLAN/Bluetooth continuously transmission, at maximum RF power in each supported wireless interface and frequency band.
- (d) Connect EUT RF port through RF cable to the power meter, and measure WLAN/Bluetooth output power.

<SAR measurement>

- (a) Use base station simulator to configure EUT WWAN transmission in radiated connection, and engineering software to configure EUT WLAN/Bluetooth continuously transmission, at maximum RF power, in the highest power channel.
- (b) Place the EUT in the positions as Appendix A demonstrates.
- (c) Set scan area, grid size and other setting on the OPENSAR software.
- (d) Measure SAR results for the highest power channel on each testing position.
- (e) Find out the largest SAR result on these testing positions of each band.
- (f) Measure SAR results for other channels in worst SAR testing position if the reported SAR of highest power channel is larger than 0.8 W/kg.

According to the test standard, the recommended procedure for assessing the peak spatial-average SAR value consists of the following steps:

- (a) Power reference measurement
- (b) Area scan
- (c) Zoom scan
- (d) Power drift measurement

3.1. Power Reference

The Power Reference Measurement and Power Drift Measurements are for monitoring the power drift of the device under test in the batch process. The minimum distance of probe sensors to surface determines the closest measurement point to phantom surface. This distance cannot be smaller than the distance of sensor calibration points to probe tip as defined in the probe properties.

3.2. Area scan & Zoom scan

The area scan is a 2D scan to find the hot spot location on the DUT. The zoom scan is a 3D scan above the hot spot to calculate the 1g and 10g SAR value.

Measurement of the SAR distribution with a grid of 8 to 16 mm * 8 to 16 mm and a constant distance to the inner surface of the phantom. Since the sensors cannot directly measure at the inner phantom surface, the values between the sensors and the inner phantom surface are extrapolated. With these values the area of the maximum SAR is calculated by an interpolation scheme. Around this point, a cube of 30 * 30 * 30 mm or 32 * 32 * 32 mm is assessed by measuring 5 or 8 * 5 or 8 * 4 or 5 mm. With these data, the peak spatial-average SAR value can be calculated.

From the scanned SAR distribution, identify the position of the maximum SAR value, in addition identify the positions of any local maxima with SAR values within 2 dB of the maximum value that will not be within the zoom scan of other peaks; additional peaks shall be measured only when the primary peak is within 2 dB of the SAR compliance limit (e.g., 1 W/kg for 1,6 W/kg 1 g limit, or 1,26 W/kg for 2 W/kg, 10 g limit).

Area scan & Zoom scan scan parameters extracted from FCC KDB 865664 D01 SAR measurement 100 MHz to 6 GHz.

		≤ 3 GHz	> 3 GHz	
Maximum distance from closest measurement point (geometric center of probe sensors) to phantom surface		5 ± 1 mm	½·δ·ln(2) ± 0.5 mm	
Maximum probe angle from probe axis to phantom surface normal at the measurement location		30° ± 1°	20° ± 1°	
Maximum area scan spatial resolution: Δx _{Area} , Δy _{Area}		≤ 2 GHz: ≤ 15 mm 2 – 3 GHz: ≤ 12 mm	3 – 4 GHz: ≤ 12 mm 4 – 6 GHz: ≤ 10 mm	
		When the x or y dimension of the test device, in the measurement plane orientation, is smaller than the above, the measurement resolution must be ≤ the corresponding x or y dimension of the test device with at least one measurement point on the test device.		
Maximum zoom scan spatial resolution: Δx _{Zoom} , Δy _{Zoom}		≤ 2 GHz: ≤ 8 mm 2 – 3 GHz: ≤ 5 mm*	3 – 4 GHz: ≤ 5 mm* 4 – 6 GHz: ≤ 4 mm*	
Maximum zoom scan spatial resolution, normal to phantom surface	uniform grid: Δz _{Zoom} (n)	≤ 5 mm	3 – 4 GHz: ≤ 4 mm 4 – 5 GHz: ≤ 3 mm 5 – 6 GHz: ≤ 2 mm	
	graded grid	Δz _{Zoom} (1): between 1 st two points closest to phantom surface	≤ 4 mm	3 – 4 GHz: ≤ 3 mm 4 – 5 GHz: ≤ 2.5 mm 5 – 6 GHz: ≤ 2 mm
		Δz _{Zoom} (n>1): between subsequent points	≤ 1.5·Δz _{Zoom} (n-1)	
Minimum zoom scan volume	x, y, z	≥ 30 mm	3 – 4 GHz: ≥ 28 mm 4 – 5 GHz: ≥ 25 mm 5 – 6 GHz: ≥ 22 mm	

Note: δ is the penetration depth of a plane-wave at normal incidence to the tissue medium; see draft standard IEEE P1528-2011 for details.

* When zoom scan is required and the *reported* SAR from the *area scan based 1-g SAR estimation* procedures of KDB 447498 is ≤ 1.4 W/kg, ≤ 8 mm, ≤ 7 mm and ≤ 5 mm zoom scan resolution may be applied, respectively, for 2 GHz to 3 GHz, 3 GHz to 4 GHz and 4 GHz to 6 GHz.

3.3. Description of interpolation/extrapolation scheme

The local SAR inside the phantom is measured using small dipole sensing elements inside a probe body. The probe tip must not be in contact with the phantom surface in order to minimise measurements errors, but the highest local SAR will occur at the surface of the phantom.

An extrapolation is used to determine these highest local SAR values. The extrapolation is based on a fourth-order least-square polynomial fit of measured data. The local SAR value is then extrapolated from the liquid surface with a 1 mm step.

The measurements have to be performed over a limited time (due to the duration of the battery) so the step of measurement is high. It could vary between 5 and 8 mm. To obtain an accurate assessment of the maximum SAR averaged over 10 grams and 1 gram requires a very fine resolution in the three dimensional scanned data array.

3.4. Volumetric Scan

The volumetric scan consists of a full 3D scan over a specific area. This 3D scan is useful for multi Tx SAR measurement. Indeed, it is possible with OpenSAR to add, point by point, several volumetric scans to calculate the SAR value of the combined measurement as it is defined in the standard IEEE1528 and IEC62209.

3.5. Power Drift

All SAR testing is under the EUT installed with a full charged battery and transmit maximum output power. In OpenSAR measurement software, the power reference measurement and power drift measurement procedures are used for monitoring the power drift of EUT during SAR test. Both these procedures measure the field at a specified reference position before and after the SAR testing. The software will calculate the field difference in V/m. If the power drifts more than $\pm 5\%$, the SAR will be retested.

4. System Verification Procedure

4.1. Tissue Verification

The following tissue formulations are provided for reference only as some of the parameters have not been thoroughly verified. The composition of ingredients may be modified accordingly to achieve the desired target tissue parameters required for routine SAR evaluation.

Ingredients (% of weight)	Head Tissue									
	750	835	900	1800	1900	2000	2450	2600	5200	5800
Frequency Band (MHz)										
Water	34.40	34.40	34.40	55.36	55.36	57.87	57.87	57.87	65.53	65.53
NaCl	0.79	0.79	0.79	0.35	0.35	0.16	0.16	0.16	0.00	0.00
1,2-Propanediol	64.81	64.81	64.81	0.00	0.00	0.00	0.00	0.00	0.00	0.00
Triton X-100	0.00	0.00	0.00	30.45	30.45	19.97	19.97	19.97	24.24	24.24
DGBE	0.00	0.00	0.00	13.84	13.84	22.00	22.00	22.00	10.23	10.23
Ingredients (% of weight)	Body Tissue									
	750	835	900	1800	1900	2000	2450	2600	5200	5800
Frequency Band (MHz)										
Water	50.30	50.30	50.30	69.91	69.91	71.88	71.88	71.88	79.54	79.54
NaCl	0.60	0.60	0.60	0.13	0.13	0.16	0.16	0.16	0.00	0.00
1,2-Propanediol	49.10	49.10	49.10	0.00	0.00	0.00	0.00	0.00	0.00	0.00
Triton X-100	0.00	0.00	0.00	9.99	9.99	19.97	19.97	19.97	11.24	11.24
DGBE	0.00	0.00	0.00	19.97	19.97	7.99	7.99	7.99	9.22	9.22

4.1.1. Tissue Dielectric Parameter Check Results

The simulating liquids should be checked at the beginning of a series of SAR measurements to determine if the dielectric parameters are within the tolerances of the specified target values. The measured conductivity and relative permittivity should be within $\pm 5\%$ of the target values.

Tissue Type	Measured Frequency (MHz)	Target Tissue		Measured Tissue		Liquid Temp.	Test Date
		ϵ_r ($\pm 5\%$)	σ (S/m) ($\pm 5\%$)	ϵ_r	σ (S/m)		
Head 850	835	41.50 (39.43~43.57)	0.90 (0.86~0.94)	41.62	0.90	21.7 °C	Dec. 29, 2018
Body 850	835	55.20 (52.44~57.96)	0.97 (0.92~1.01)	54.89	1.00	21.5 °C	Dec. 25, 2018
Head 1800	1800	40.00 (38.00~42.00)	1.40 (1.33~1.47)	39.49	1.40	21.6 °C	Jan. 02, 2019
Body 1800	1800	53.30 (50.64~55.96)	1.52 (1.44~1.59)	53.80	1.52	21.3 °C	Jan. 02, 2019
Head 1900	1900	40.00 (38.00~42.00)	1.40 (1.33~1.47)	40.01	1.41	21.6 °C	Jan. 02, 2019
Body 1900	1900	53.30 (50.64~55.96)	1.52 (1.44~1.59)	53.18	1.54	21.5 °C	Jan. 02, 2019
Head 2450	2450	39.20 (37.24~41.16)	1.80 (1.71~1.89)	39.99	1.79	21.7 °C	Dec. 29, 2018
Body 2450	2450	52.70 (50.07~55.33)	1.95 (1.85~2.04)	52.70	1.97	21.3 °C	Dec. 28, 2018
Head 2600	2600	39.00 (37.05~40.95)	1.96 (1.86~2.05)	39.02	1.96	21.7 °C	Dec. 29, 2018
Body 2600	2600	52.50 (49.88~55.13)	2.16 (2.05~2.27)	53.08	2.16	21.4 °C	Dec. 29, 2018

NOTE: The dielectric parameters of the tissue-equivalent liquid should be measured under similar ambient conditions and within 2 °C of the conditions expected during the SAR evaluation to satisfy protocol requirements.

4.2. System Verification Procedure

The system verification is performed for verifying the accuracy of the complete measurement system and performance of the software. The dipole is connected to the signal source consisting of signal generator and amplifier via a directional coupler, N-connector cable and adaption to SMA. It is fed with a power of 100mW (below 5GHz) or 100mW (above 5GHz). To adjust this power a power meter is used. The power sensor is connected to the cable before the system verification to measure the power at this point and do adjustments at the signal generator. At the outputs of the directional coupler both return loss as well as forward power are controlled during the system verification to make sure that emitted power at the dipole is kept constant. This can also be checked by the power drift measurement after the test (result on plot).

The system verification is shown as below picture:

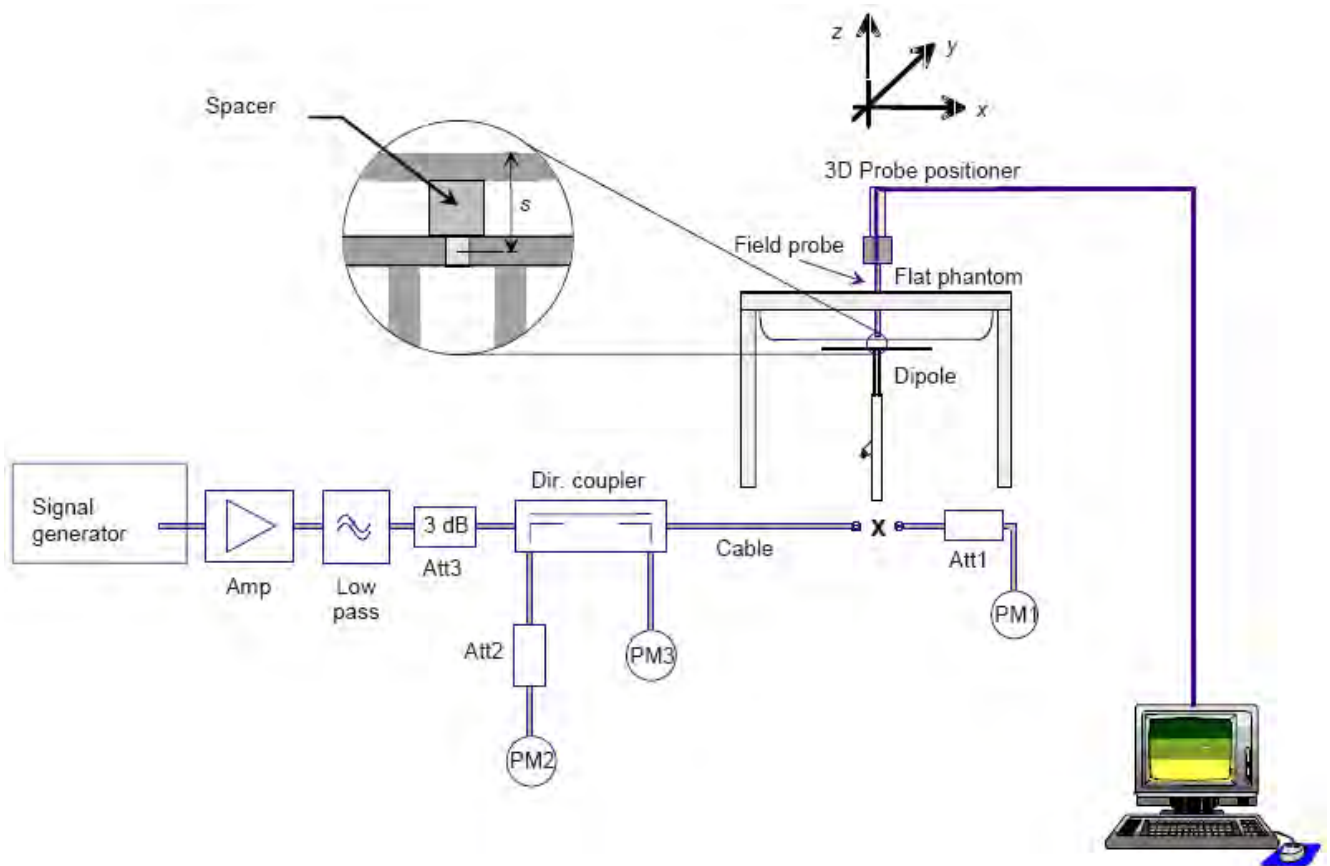

4.2.1. System Verification Results

Comparing to the original SAR value provided by SATIMO, the verification data should be within its specification of $\pm 10\%$. Below table shows the target SAR and measured SAR after normalized to 1W input power. The table below indicates the system performance verification can meet the variation criterion and the plots can be referred to Appendix B of this report.

System Verification	Target SAR (1W) ($\pm 10\%$)		Measured SAR (Normalized to 1W)		Liquid Temp.	Test Date
	1-g (W/Kg)	10-g (W/Kg)	1-g (W/Kg)	10-g (W/Kg)		
835MHz Head	9.56 (8.60~10.51)	6.22 (5.60~6.84)	9.56	6.11	21.7 °C	Dec. 29, 2018
835MHz Body	9.48 (8.53~10.42)	6.29 (5.66~6.91)	10.21	5.99	21.5 °C	Dec. 25, 2018
1800MHz Head	38.40 (34.56~42.24)	20.10 (18.09~22.11)	40.84	21.21	21.6 °C	Jan. 02, 2019
1800MHz Body	37.04 (33.34~40.74)	20.26 (18.23~22.29)	40.11	21.00	21.3 °C	Jan. 02, 2019
1900MHz Head	39.70 (35.73~43.67)	20.50 (18.45~22.55)	37.05	19.14	21.6 °C	Jan. 02, 2019
1900MHz Body	38.43 (34.59~42.27)	20.34 (18.31~22.37)	40.60	20.45	21.5 °C	Jan. 02, 2019
2450MHz Head	52.40 (47.16~57.64)	24.00 (21.60~26.40)	51.57	24.78	21.7 °C	Dec. 29, 2018
2450MHz Body	49.32 (44.39~54.25)	22.89 (20.60~25.17)	50.27	24.16	21.3 °C	Dec. 28, 2018
2600MHz Head	55.30 (49.77~60.83)	24.60 (22.14~27.06)	50.13	25.73	21.7 °C	Dec. 29, 2018
2600MHz Body	52.95 (47.66~58.25)	23.64 (21.28~26.00)	55.41	24.12	21.4 °C	Dec. 29, 2018

5. SAR Measurement variability and uncertainty

5.1. SAR measurement variability

Per KDB865664 D01 SAR measurement 100 MHz to 6 GHz, SAR measurement variability must be assessed for each frequency band, which is determined by the SAR probe calibration point and tissue-equivalent medium used for the device measurements. The additional measurements are repeated after the completion of all measurements requiring the same head or body tissue-equivalent medium in a frequency band. The test device should be returned to ambient conditions (normal room temperature) with the battery fully charged before it is re-mounted on the device holder for the repeated measurement(s) to minimize any unexpected variations in the repeated results.

- 1) Repeated measurement is not required when the original highest measured SAR is < 0.80 W/kg; steps 2) through 4) do not apply.
- 2) When the original highest measured SAR is ≥ 0.80 W/kg, repeat that measurement once.
- 3) Perform a second repeated measurement only if the ratio of largest to smallest SAR for the original and first repeated measurements is > 1.20 or when the original or repeated measurement is ≥ 1.45 W/kg (~ 10% from the 1-g SAR limit).
- 4) Perform a third repeated measurement only if the original, first or second repeated measurement is ≥ 1.5 W/kg and the ratio of largest to smallest SAR for the original, first and second repeated measurements is > 1.20 .

5.2. SAR measurement uncertainty

Per KDB865664 D01 SAR Measurement 100 MHz to 6 GHz, when the highest measured 1-g SAR within a frequency band is < 1.5 W/kg, the extensive SAR measurement uncertainty analysis described in IEEE Std 1528-2013 is not required in SAR reports submitted for equipment approval. The equivalent ratio (1.5/1.6) is applied to extremity and occupational exposure conditions.

6. RF Exposure Positions

6.1. Ear and handset reference point

Figure 6.1.1 shows the front, back, and side views of the SAM phantom. The center-of-mouth reference point is labeled "M", the left ear reference point (ERP) is marked "LE", and the right ERP is marked "RE".



Fig 6.1.1 Front, back, and side views of SAM phantom

6.2. Definition of the cheek position

1. Define two imaginary lines on the handset, the vertical centerline and the horizontal line. The vertical centerline passes through two points on the front side of the handset: the midpoint of the width w_t of the handset at the level of the acoustic output (point A in Figure 6.2.1 and Figure 6.2.2), and the midpoint of the width w_b of the bottom of the handset (point B). The horizontal line is perpendicular to the vertical centerline and passes through the center of the acoustic output (see Figure 6.2.1). The two lines intersect at point A. Note that for many handsets, point A coincides with the center of the acoustic output; however, the acoustic output may be located elsewhere on the horizontal line. Also note that the vertical centerline is not necessarily parallel to the front face of the handset (see Figure 6.2.2), especially for clamshell handsets, handsets with flip covers, and other irregularly-shaped handsets.
2. Position the handset close to the surface of the phantom such that point A is on the (virtual) extension of the line passing through points RE and LE on the phantom (see Figure 6.2.3), such that the plane defined by the vertical centerline and the horizontal line of the handset is approximately parallel to the sagittal plane of the phantom.
3. Translate the handset towards the phantom along the line passing through RE and LE until handset point A touches the pinna at the ERP
4. While maintaining the handset in this plane, rotate it around the LE-RE line until the vertical centerline is in the plane normal to the plane containing B-M and N-F lines, i.e., the Reference Plane.
5. Rotate the handset around the vertical centerline until the handset (horizontal line) is parallel to the N-F line.

6. While maintaining the vertical centerline in the Reference Plane, keeping point A on the line passing through RE and LE, and maintaining the handset contact with the pinna, rotate the handset about the N-F line until any point on the handset is in contact with a phantom point below the pinna on the cheek. See Figure 6.2.3. The actual rotation angles should be documented in the test report.

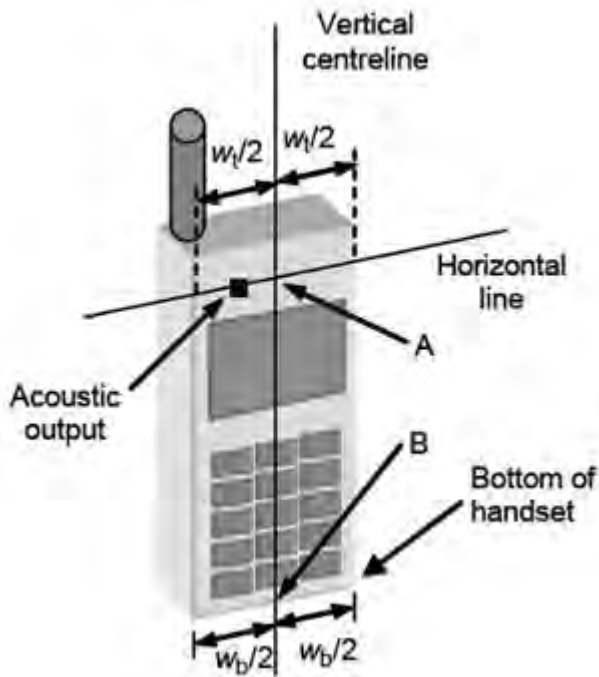

Fig 6.2.1 Handset vertical and horizontal reference lines—fixed case

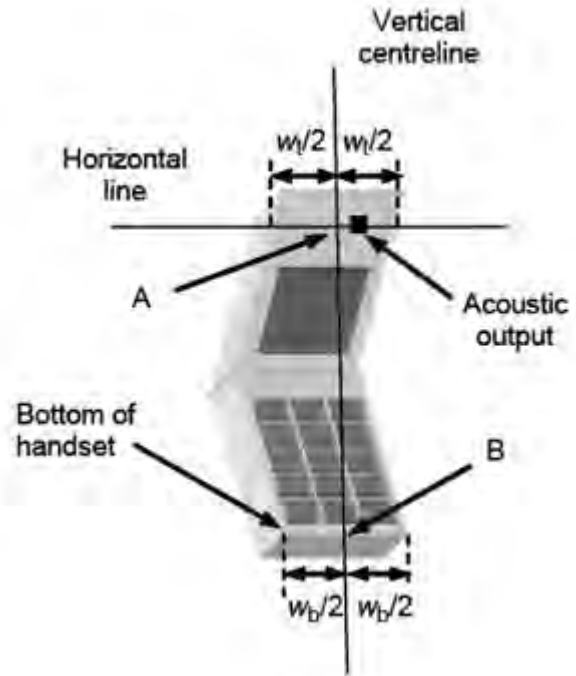

Fig 6.2.2 Handset vertical and horizontal reference lines—“clam-shell case”

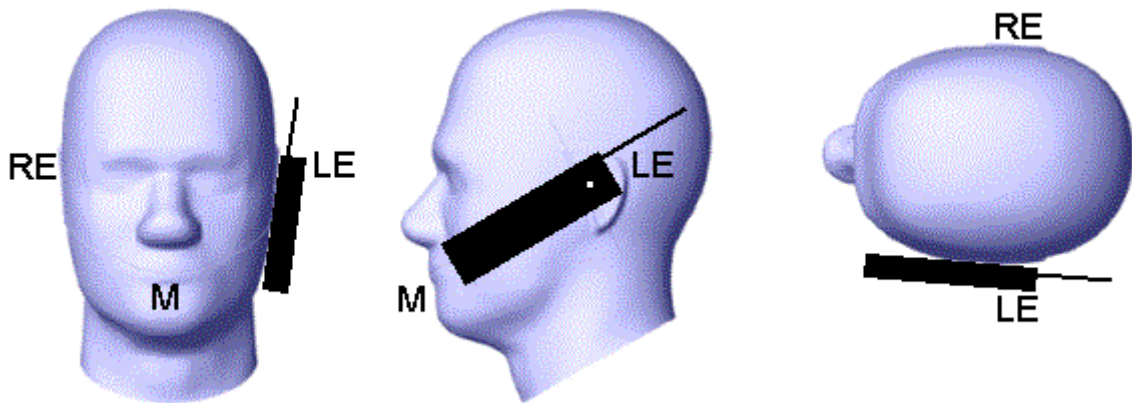

Fig 6.2.3 cheek or touch position. The reference points for the right ear (RE), left ear (LE), and mouth (M), which establish the Reference Plane for handset positioning, are indicated.

6.3. Definition of the tilt position

1. While maintaining the orientation of the handset, retract the handset parallel to the reference plane far enough away from the phantom to enable a rotation of the device by 15 degree.
2. Rotate the Handset around the horizontal line by 15 degree (see Figure 6.3.1).
3. While maintaining the orientation of the handset, move the handset towards the phantom on a line passing through RE and LE until any part of the handset touches the ear. The tilt position is obtained when the contact is on the pinna. If the contact is at any location other than the pinna, e.g., the antenna with the back of the phantom head, the angle of the handset shall be reduced. In this case, the tilt position is obtained if any part of the handset is in contact with the pinna as well as a second part of the handset is in contact with the phantom, e.g., the antenna with the back of the head.

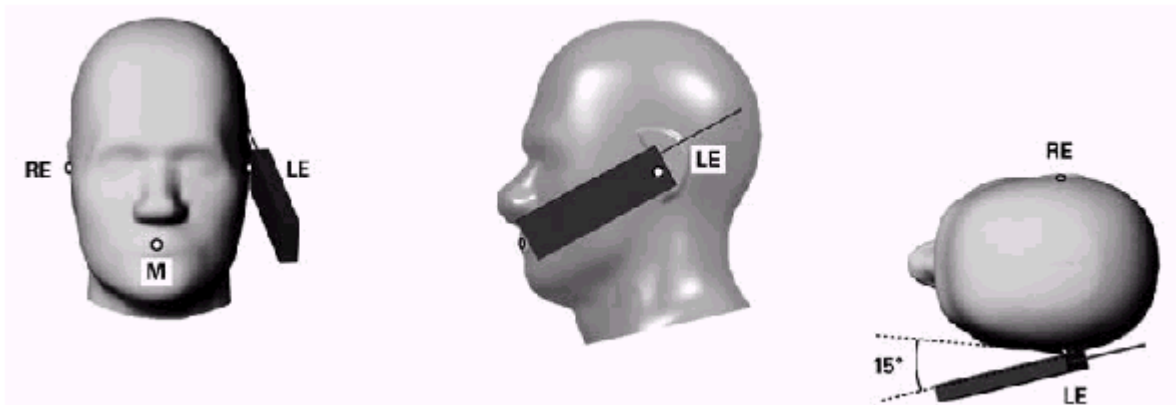

Figure 6.3.1 – Tilt position of the wireless device on the left side of SAM

6.4. Body Worn Accessory

1. Body-worn operating configurations are tested with the belt-clips and holsters attached to the device and positioned against a flat phantom in a normal use configuration (see Figure 6.4.1). Per KDB 648474 D04, body-worn accessory exposure is typically related to voice mode operations when handsets are carried in body-worn accessories. The body-worn accessory procedures in FCC KDB 447498 D01 should be used to test for body-worn accessory SAR compliance, without a headset connected to it. This enables the test results for such configuration to be compatible with that required for hotspot mode when the body-worn accessory test separation distance is greater than or equal to that required for hotspot mode, when applicable. When the reported SAR for body-worn accessory, measured without a headset connected to the handset is < 1.2 W/kg, the highest reported SAR configuration for that wireless mode and frequency band should be repeated for that body-worn accessory with a handset attached to the handset.
2. Accessories for body-worn operation configurations are divided into two categories: those that do not contain metallic components and those that do contain metallic components and those that do contain metallic components. When multiple accessories that do not contain metallic components are supplied with the device, the device is tested with only the accessory that dictates the closest

spacing to the body. Then multiple accessories that contain metallic components are test with the device with each accessory. If multiple accessories share an identical metallic component (i.e. the same metallic belt-clip used with different holsters with no other metallic components) only the accessory that dictates the closest spacing to the body is tested.

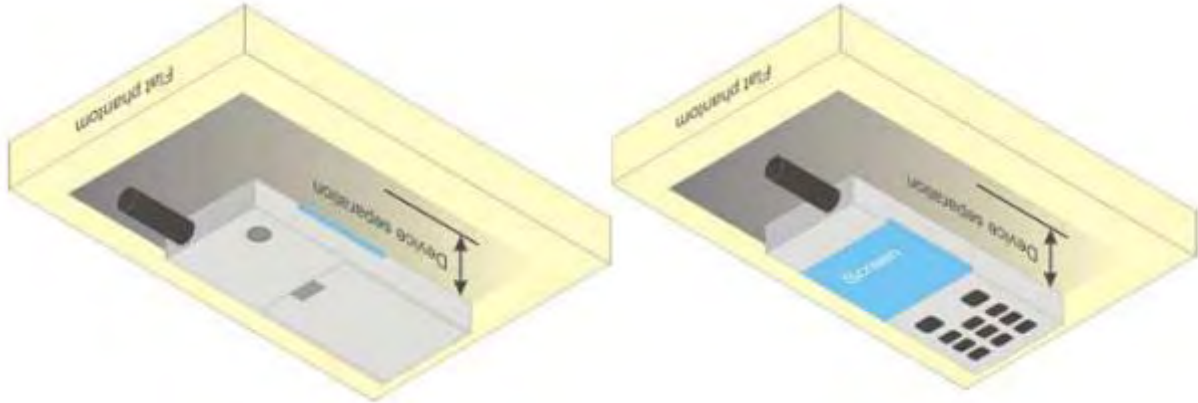

Figure 6.4.1 – Test positions for body-worn devices

6.5. Wireless Router Devices

Some battery-operated handsets have the capability to transmit and receive user through simultaneous transmission of WLAN simultaneously with a separate licensed transmitter. The FCC has provided guidance in FCC KDB Publication 941225 D06 where SAR test considerations for handsets ($L \times W \geq 9 \text{ cm} \times 5 \text{ cm}$) are based on a composite test separation distance of 10mm from the front, back and edges of the device containing transmitting antennas within 2.5cm of their edges, determined from general mixed use conditions for this type of devices. Since the hotspot SAR results may overlap with the body-worn accessory SAR requirements, the more conservative configurations can be considered, thus excluding some body-worn accessory SAR tests.

When the user enables the personal wireless router functions for the handset, actual operations include simultaneous transmission of both the WLAN transmitter and another licensed transmitter. Both transmitters often do not transmit at the same transmitting frequency and thus cannot be evaluated for SAR under actual use conditions due to the limitations of the SAR assessment probes. Therefore, SAR must be evaluated for each frequency transmission and mode separately and spatially summed with the WLAN transmitter according to FCC KDB Publication 447498 D01 publication procedures. The “Portable Hotspot” feature on the handset was NOT activated during SAR assessments, to ensure the SAR measurements were evaluated for a single transmission frequency RF signal at a time.

7. RF Output Power

7.1. Maximum Tune-up Limit

Band	Mode	The Tune-up Maximum Power (Customer Declared)(dBm)	Range	Measured Maximum Output Power(dBm)
GSM 850	GSM Voice	31±1	30~32	31.81
	GPRS	31±1	30~32	31.80
	EDGE	26±1	25~27	26.89
GSM 1900	GSM Voice	29±1	28~30	29.51
	GPRS	29±1	28~30	29.40
	EDGE	25±1	24~26	25.95
WCDMA Band V	RMC 12.2Kbps	21.5±1	20.5~22.5	22.39
	HSDPA	20.5±1	19.5~21.5	21.49
	HSUPA	20.5±1	19.5~21.5	21.43
	HSPA ⁺	21±1	20~22	21.52
WCDMA Band II	RMC 12.2Kbps	21.5±1	20.5~22.5	22.49
	HSDPA	20.5±1	19.5~21.5	21.46
	HSUPA	20.5±1	19.5~21.5	21.48
	HSPA ⁺	20.5±1	19.5~21.5	21.47
LTE Band V	QPSK	22.5±1	21.5~23.5	23.42
	16QAM	21.5±1	20.5~22.5	22.50
LTE Band IV	QPSK	21.5±1	20.5~22.5	22.50
	16QAM	20.5±1	19.5~21.5	21.50
LTE Band II	QPSK	22.5±1	21.5~23.5	23.46
	16QAM	21.5±1	20.5~22.5	22.50
LTE Band VII	QPSK	22.5±1	21.5~23.5	23.50
	16QAM	21.5±1	20.5~22.5	22.50
WLAN 2.4G	802.11b	13±1	12~14	13.8
	802.11g	13±1	12~14	13.3
	802.11n20	13±1	12~14	13.2
Bluetooth	EDR	6.5±1	5.5~7.5	7.45
	BLE	-1±1	-2~0	0.00

7.2. GSM Conducted Power

Band GSM850		Burst-Averaged output Power (dBm)			Frame-Averaged output Power (dBm)			
Tx Channel	Tune-up	128	189	251	Tune-up	128	189	251
Frequency (MHz)	(dBm)	824.2	836.4	848.8	(dBm)	824.2	836.4	848.8
GSM (GMSK)	32.00	31.71	31.81	31.79	22.97	22.68	22.78	22.76
GPRS(GMSK, 1 TS)	32.00	31.73	31.80	31.79	22.97	22.70	22.77	22.76
GPRS(GMSK, 2 TS)	30.00	29.65	29.83	29.95	23.98	23.63	23.81	23.93
GPRS(GMSK, 3 TS)	29.00	28.69	28.75	28.63	24.74	24.43	24.49	24.37
GPRS(GMSK, 4 TS)	28.00	27.95	27.82	27.89	24.99	24.94	24.81	24.88
EDGE(GMSK, 1 TS)	27.00	26.89	26.88	26.75	17.97	17.86	17.85	17.72
EDGE(GMSK, 2 TS)	26.00	25.96	25.96	25.87	19.98	19.94	19.94	19.85
EDGE(GMSK, 3 TS)	26.00	25.65	25.41	25.41	21.74	21.39	21.15	21.15
EDGE(GMSK, 4 TS)	25.00	24.87	24.89	24.96	21.99	21.86	21.88	21.95
Band GSM1900		Burst-Averaged output Power (dBm)			Frame-Averaged output Power (dBm)			
Tx Channel	Tune-up	512	661	810	Tune-up	512	661	810
Frequency (MHz)	(dBm)	1850.2	1880.0	1909.8	(dBm)	1850.2	1880.0	1909.8
GSM (GMSK)	30.00	29.51	29.21	29.18	20.97	20.48	20.18	20.15
GPRS(GMSK, 1 TS)	30.00	29.40	29.10	29.21	20.97	20.37	20.07	20.18
GPRS(GMSK, 2 TS)	29.00	28.92	28.59	28.61	22.98	22.90	22.57	22.59
GPRS(GMSK, 3 TS)	28.00	27.42	27.62	27.59	23.74	23.16	23.36	23.33
GPRS(GMSK, 4 TS)	27.00	26.81	26.72	26.77	23.99	23.80	23.71	23.76
EDGE(GMSK, 1 TS)	26.00	25.95	25.88	25.76	16.97	16.92	16.85	16.73
EDGE(GMSK, 2 TS)	25.00	24.92	24.88	24.95	18.98	18.90	18.86	18.93
EDGE(GMSK, 3 TS)	24.00	23.69	23.58	23.74	19.74	19.43	19.32	19.48
EDGE(GMSK, 4 TS)	23.00	22.86	22.64	22.51	19.99	19.85	19.63	19.50

Note: The frame-averaged power is linearly scaled the maximum burst averaged power over 8 time slots.

The calculated method are shown as below:

Frame-averaged power = Maximum burst averaged power (1 TS) - 9.03 dB

Frame-averaged power = Maximum burst averaged power (2 TS) - 6.02 dB

Frame-averaged power = Maximum burst averaged power (3 TS) - 4.26 dB

Frame-averaged power = Maximum burst averaged power (4 TS) - 3.01 dB

7.3. WCDMA Conducted Power

Band	WCDMA Band V			
Tx Channel	Tune-up	4132	4182	4233
Frequency (MHz)		826.4	836.4	846.6
RMC 12.2Kbps	22.50	22.34	22.33	22.39
HSDPA Subtest-1	21.50	21.49	21.45	21.47

HSDPA Subtest-2	21.50	20.75	20.78	20.62
HSDPA Subtest-3	21.50	20.69	20.65	20.58
HSDPA Subtest-4	21.50	20.47	20.60	20.58
HSUPA Subtest-1	21.50	20.68	20.54	20.46
HSUPA Subtest-2	21.50	20.58	20.48	20.52
HSUPA Subtest-3	21.50	20.64	20.46	20.62
HSUPA Subtest-4	21.50	20.49	20.53	20.67
HSUPA Subtest-5	21.50	21.43	21.40	21.39
HSPA ⁺	22.00	21.40	21.52	21.38
Band	WCDMA Band II			
Tx Channel	Tune-up	9262	9400	9538
Frequency (MHz)		1852.4	1880	1907.6
RMC 12.2Kbps	22.50	22.24	22.49	22.45
HSDPA Subtest-1	21.50	21.38	21.46	21.41
HSDPA Subtest-2	21.50	20.82	21.11	21.09
HSDPA Subtest-3	21.50	20.98	20.70	21.14
HSDPA Subtest-4	21.50	20.92	21.19	21.08
HSUPA Subtest-1	21.50	21.16	21.16	21.18
HSUPA Subtest-2	21.50	21.09	21.09	21.12
HSUPA Subtest-3	21.50	21.12	21.08	21.14
HSUPA Subtest-4	21.50	21.14	21.15	21.09
HSUPA Subtest-5	21.50	21.48	21.45	21.39
HSPA ⁺	21.50	21.25	21.33	21.47

7.4. LTE Conducted Power

Band	Band Width	Modulation	RB Configuration		Tune-up	Channel/Frequency(MHz)		
			RB Size	RB Offset		20407/824.7	20525/836.5	20643/848.3
LTE Band V	1.4MHz	QPSK	1	0	23.50	22.50	22.95	23.19
			1	2	23.50	22.52	22.78	23.07
			1	5	23.50	22.49	22.76	23.09
			3	0	23.50	22.55	22.72	23.42
			3	1	23.50	22.55	22.70	23.25
			3	2	23.50	22.56	22.69	23.17
		16QAM	6	0	22.50	21.61	21.77	22.31
			1	0	22.50	21.98	21.18	22.50
			1	2	22.50	21.99	21.30	22.47
			1	5	22.50	21.93	21.32	22.44

Band	Band Width	Modulation	RB Configuration		Tune-up	Channel/Frequency(MHz)		
			RB Size	RB Offset		20415/825.5	20525/836.5	20635/847.5
			3	0	21.50	21.45	21.49	21.41
			3	1	21.50	21.46	21.46	21.48
			3	2	21.50	21.48	21.39	21.39
			6	0	21.50	20.46	20.95	21.14
LTE Band V	3MHz	QPSK	1	0	23.50	22.53	22.96	23.25
			1	7	23.50	22.49	22.76	23.30
			1	14	23.50	22.55	22.78	23.11
			8	0	22.50	21.60	21.64	22.22
			8	4	22.50	21.58	21.69	22.33
			8	7	22.50	21.55	21.73	22.50
			15	0	22.50	21.62	21.69	22.24
		16QAM	1	0	22.50	21.82	21.21	22.50
			1	7	22.50	21.81	21.29	22.49
			1	14	22.50	21.81	21.33	22.48
			8	0	21.50	20.59	20.79	21.48
			8	4	21.50	20.65	20.81	21.47
			8	7	21.50	21.50	20.89	21.24
			15	0	21.50	20.30	20.72	21.43
			RB Configuration		Tune-up	Channel/Frequency(MHz)		
			RB Size	RB Offset		20425/826.5	20525/836.5	20625/846.5
LTE Band V	5MHz	QPSK	1	0	23.50	22.52	22.84	23.29
			1	12	23.50	22.50	22.65	23.42
			1	24	23.50	22.69	22.95	23.24
			12	0	22.50	21.61	21.69	22.27
			12	6	22.50	21.61	21.67	22.26
			12	11	22.50	21.61	21.66	22.26
			25	0	22.50	21.51	21.76	22.28
		16QAM	1	0	22.50	20.76	21.23	22.39
			1	12	22.50	20.70	21.30	22.40
			1	24	22.50	20.83	21.42	22.42
			12	0	21.50	20.26	20.49	21.21
			12	6	21.50	20.30	20.51	21.32
			12	11	21.50	20.61	20.61	21.43
			25	0	21.50	20.69	20.63	21.47

Band	Band Width	Modulation	RB Configuration		Tune-up	Channel/Frequency(MHz)		
			RB Size	RB Offset		20450/829	20525/836.5	20600/844
LTE Band V	10MHz	QPSK	1	0	23.50	22.43	22.65	23.05
			1	24	23.50	22.62	22.61	23.22
			1	49	23.50	22.69	23.11	23.20
			25	0	22.50	21.55	21.60	21.80
			25	12	22.50	21.60	21.64	21.95
			25	24	22.50	21.78	21.74	22.19
			50	0	22.50	21.63	21.79	22.28
		16QAM	1	0	22.50	21.68	21.22	22.01
			1	24	22.50	21.75	21.19	22.43
			1	49	22.50	21.96	21.34	22.38
			25	0	21.50	20.64	20.71	20.95
			25	12	21.50	20.72	20.70	21.21
			25	24	21.50	20.89	20.89	21.50
			50	0	21.50	20.68	20.72	21.14

Band	Band Width	Modulation	RB Configuration		Tune-up	Channel/Frequency(MHz)		
			RB Size	RB Offset		19957/1710.7	20175/1732.5	20393/1754.3
LTE Band IV	1.4MHz	QPSK	1	0	22.50	22.50	22.49	22.48
			1	2	22.50	22.48	22.48	22.37
			1	5	22.50	22.49	22.47	22.04
			3	0	22.50	22.47	22.49	22.31
			3	1	22.50	22.48	22.49	22.18
			3	2	22.50	22.50	22.46	22.15
			6	0	21.50	21.50	21.48	21.49
		16QAM	1	0	21.50	21.46	21.41	21.46
			1	2	21.50	21.43	21.28	21.35
			1	5	21.50	21.35	21.31	21.30
			3	0	21.50	21.49	21.45	21.47
			3	1	21.50	21.49	21.48	21.48
			3	2	21.50	21.48	21.50	21.50
			6	0	21.50	20.69	21.02	21.02

Band	Band Width	Modulation	RB Configuration		Tune-up	Channel/Frequency(MHz)		
			RB	RB		19965/1711.5	20175/1732.5	20385/1753.5

Band	Band Width	Modulation	RB Configuration		Tune-up	Channel/Frequency(MHz)		
			RB Size	RB Offset		19975/1712.5	20175/1732.5	20375/1752.5
LTE Band IV	3MHz	QPSK	1	0	22.50	22.46	22.47	22.49
			1	7	22.50	22.48	22.48	22.48
			1	14	22.50	22.50	22.45	22.02
			8	0	21.50	21.50	21.49	21.50
			8	4	21.50	21.48	21.48	21.48
			8	7	21.50	21.47	21.48	21.49
		16QAM	15	0	21.50	21.50	21.50	21.48
			1	0	21.50	21.41	21.46	21.46
			1	7	21.50	21.41	21.42	21.44
			1	14	21.50	21.41	21.45	21.43
			8	0	21.50	21.19	20.99	20.91
			8	4	21.50	21.24	20.90	20.91
			8	7	21.50	21.20	21.04	20.91
			15	0	21.50	21.10	21.21	21.15
LTE Band IV	5MHz	QPSK	1	0	22.50	22.47	22.48	22.47
			1	12	22.50	22.49	22.46	22.49
			1	24	22.50	22.45	22.47	21.82
			12	0	21.50	21.50	21.46	21.42
			12	6	21.50	21.46	21.49	21.45
			12	11	21.50	21.48	21.48	21.45
			25	0	21.50	21.48	21.50	21.49
		16QAM	1	0	21.50	20.94	21.38	21.49
			1	12	21.50	21.02	21.40	21.48
			1	24	21.50	20.98	21.38	21.50
			12	0	20.50	20.44	20.46	20.48
			12	6	20.50	20.47	20.44	20.47
			12	11	20.50	20.48	20.45	20.49
			25	0	20.50	20.50	20.45	20.44
LTE Band IV	10MHz	QPSK	1	0	22.50	22.49	22.46	22.43
			1	24	22.50	22.47	22.48	22.45
			1	49	22.50	22.41	22.46	22.47

			25	0	21.50	21.49	21.46	21.47
			25	12	21.50	21.48	21.45	21.45
			25	24	21.50	21.48	21.44	21.49
			50	0	21.50	21.50	21.48	21.43
		16QAM	1	0	21.50	21.46	21.22	21.45
			1	24	21.50	21.48	21.20	21.41
			1	49	21.50	21.44	21.13	21.48
			25	0	20.50	20.50	20.44	20.48
			25	12	20.50	20.45	20.49	20.46
			25	24	20.50	20.46	20.48	20.47
			50	0	20.50	20.43	20.45	20.43
				50	0	20.50	20.43	20.45
Band	Band Width	Modulation	RB Configuration		Tune-up	Channel/Frequency(MHz)		
			RB Size	RB Offset		20025/1717.5	20175/1732.5	20325/1747.5
LTE Band IV	15MHz	QPSK	1	0	22.50	22.50	22.46	22.43
			1	37	22.50	22.41	22.48	22.44
			1	74	22.50	22.47	22.49	22.27
			36	0	21.50	21.47	21.50	21.47
			36	18	21.50	21.46	21.48	21.45
			36	37	21.50	21.45	21.46	21.43
			75	0	21.50	21.41	21.43	21.44
		16QAM	1	0	21.50	21.49	21.48	21.42
			1	37	21.50	21.41	21.45	21.45
			1	74	21.50	21.40	21.40	21.39
			36	0	20.50	20.46	20.49	20.48
			36	18	20.50	20.45	20.43	20.47
			36	37	20.50	20.50	20.45	20.46
			75	0	20.50	20.45	20.48	20.48
Band	Band Width	Modulation	RB Configuration		Tune-up	Channel/Frequency(MHz)		
			RB Size	RB Offset		20050/1720	20175/1732.5	20300/1745
LTE Band IV	20MHz	QPSK	1	0	22.50	22.47	22.48	22.46
			1	49	22.50	22.48	22.46	22.45
			1	99	22.50	22.47	22.50	22.44
			50	0	21.50	21.49	21.45	21.46
			50	24	21.50	21.43	21.44	21.46
			50	49	21.50	21.48	21.43	21.47
			100	0	21.50	21.45	21.48	21.48

16QAM	1	0	21.50	21.37	21.48	21.38
	1	49	21.50	21.45	21.41	21.35
	1	99	21.50	21.33	21.42	21.35
	50	0	20.50	20.49	20.45	20.46
	50	24	20.50	20.48	20.45	20.47
	50	49	20.50	20.46	20.45	20.49
	100	0	20.50	20.50	20.45	20.44

Band	Band Width	Modulation	RB Configuration		Tune-up	Channel/Frequency(MHz)		
			RB Size	RB Offset		18607/1850.7	18900/1880	19193/1909.3
LTE Band II	1.4MHz	QPSK	1	0	23.50	23.17	23.23	23.19
			1	2	23.50	23.19	23.32	23.15
			1	5	23.50	23.22	23.26	23.21
			3	0	23.50	23.34	23.34	23.36
			3	1	23.50	23.32	23.34	23.35
			3	2	23.50	23.30	23.35	23.33
		16QAM	6	0	22.50	22.14	22.23	22.31
			1	0	22.50	22.50	22.07	22.47
			1	2	22.50	22.47	22.17	22.48
			1	5	22.50	22.48	22.11	22.49
			3	0	22.50	22.32	22.49	22.26
			3	1	22.50	22.30	22.48	22.24
			3	2	22.50	22.19	22.50	22.22
			6	0	21.50	21.28	21.43	21.46

Band	Band Width	Modulation	RB Configuration		Tune-up	Channel/Frequency(MHz)		
			RB Size	RB Offset		18615/1851.5	18900/1880	19185/1908.5
LTE Band II	3MHz	QPSK	1	0	23.50	23.12	23.28	23.20
			1	7	23.50	23.15	23.31	23.20
			1	14	23.50	23.14	23.23	23.20
			8	0	22.50	22.26	22.34	22.27
			8	4	22.50	22.24	22.33	22.28
			8	7	22.50	22.22	22.33	22.30
			15	0	22.50	22.27	22.17	22.25
		16QAM	1	0	22.50	22.49	22.20	22.50
			1	7	22.50	22.47	22.14	22.48
			1	14	22.50	22.47	22.13	22.48

Band	Band Width	Modulation	RB Configuration		Tune-up	Channel/Frequency(MHz)		
			RB Size	RB Offset		18625/1852.5	18900/1880	19175/1907.5
			8	0	21.50	21.50	21.47	21.45
			8	4	21.50	21.49	21.48	21.46
			8	7	21.50	21.49	21.48	21.47
			15	0	21.50	21.36	21.44	21.34
LTE Band II	5MHz	QPSK	1	0	23.50	23.17	23.17	23.33
			1	12	23.50	23.14	23.27	23.31
			1	24	23.50	23.10	23.23	23.43
			12	0	22.50	22.21	22.34	22.29
			12	6	22.50	22.25	22.28	22.27
			12	11	22.50	22.32	22.26	22.23
			25	0	22.50	22.27	22.27	22.29
		16QAM	1	0	22.50	21.49	22.01	22.49
			1	12	22.50	21.46	21.97	22.48
			1	24	22.50	21.41	22.01	22.50
			12	0	21.50	21.35	21.25	21.40
			12	6	21.50	21.35	21.24	21.38
			12	11	21.50	21.35	21.24	21.37
			25	0	21.50	21.41	21.25	21.38
Band	Band Width	Modulation	RB Configuration		Tune-up	Channel/Frequency(MHz)		
			RB Size	RB Offset		18650/1855	18900/1880	19150/1905
LTE Band II	10MHz	QPSK	1	0	23.50	23.15	23.44	23.27
			1	24	23.50	23.10	23.44	23.25
			1	49	23.50	23.17	23.46	23.29
			25	0	22.50	22.21	22.31	22.24
			25	12	22.50	22.28	22.32	22.25
			25	24	22.50	22.32	22.35	22.26
			50	0	22.50	22.31	22.21	22.30
		16QAM	1	0	22.50	22.50	21.87	22.43
			1	24	22.50	22.48	21.86	22.45
			1	49	22.50	22.49	21.83	22.43
			25	0	21.50	21.40	21.48	21.49
			25	12	21.50	21.40	21.49	21.47
			25	24	21.50	21.40	21.50	21.46
			50	0	21.50	21.35	21.46	21.43

Band	Band Width	Modulation	RB Configuration		Tune-up	Channel/Frequency(MHz)		
			RB Size	RB Offset		18675/1857.5	18900/1880	19125/1902.5
LTE Band II	15MHz	QPSK	1	0	23.50	23.21	23.42	23.33
			1	37	23.50	23.20	23.39	23.27
			1	74	23.50	23.16	23.38	23.27
			36	0	22.50	22.20	22.39	22.32
			36	18	22.50	22.22	22.36	22.28
			36	37	22.50	22.30	22.32	22.23
			75	0	22.50	22.26	22.28	22.30
		16QAM	1	0	22.50	22.47	22.50	22.45
			1	37	22.50	22.45	22.44	22.40
			1	74	22.50	22.48	22.48	22.45
			36	0	21.50	21.36	21.43	21.44
			36	18	21.50	21.39	21.44	21.44
			36	37	21.50	21.48	21.45	21.45
			75	0	21.50	21.38	21.39	21.40

Band	Band Width	Modulation	RB Configuration		Tune-up	Channel/Frequency(MHz)		
			RB Size	RB Offset		18700/1860	18900/1880	19100/1900
LTE Band II	20MHz	QPSK	1	0	23.50	23.43	23.41	23.32
			1	49	23.50	23.35	23.41	23.25
			1	99	23.50	23.43	23.44	23.25
			50	0	22.50	22.24	22.20	22.38
			50	24	22.50	22.23	22.28	22.38
			50	49	22.50	22.22	22.39	22.37
			100	0	22.50	22.21	22.34	22.31
		16QAM	1	0	22.50	22.46	22.46	22.36
			1	49	22.50	22.49	22.41	22.31
			1	99	22.50	22.44	22.45	22.21
			50	0	21.50	21.40	21.34	21.50
			50	24	21.50	21.42	21.35	21.48
			50	49	21.50	21.47	21.37	21.43
			100	0	21.50	21.43	21.47	21.37

Band	Band Width	Modulation	RB Configuration		Tune-up	Channel/Frequency(MHz)		
			RB	RB		20775/2502.5	21100/2535	21425/2567.5

Band	Band Width	Modulation	RB Configuration		Tune-up	Channel/Frequency(MHz)		
			RB Size	RB Offset		20800/2505	21100/2535	21400/2565
LTE Band VII	5MHz	QPSK	1	0	23.50	23.33	23.50	23.44
			1	12	23.50	23.42	23.49	23.35
			1	24	23.50	23.39	23.48	23.40
			12	0	22.50	22.27	22.47	22.50
			12	6	22.50	22.30	22.46	22.47
			12	11	22.50	22.37	22.46	22.49
		16QAM	25	0	22.50	22.30	22.46	22.47
			1	0	22.50	22.45	21.76	22.15
			1	12	22.50	22.44	21.81	22.13
			1	24	22.50	22.50	21.77	22.21
			12	0	21.50	21.47	21.50	21.50
			12	6	21.50	21.49	21.49	21.49
			12	11	21.50	21.48	21.47	21.49
			25	0	21.50	21.45	21.50	21.48
LTE Band VII	10MHz	QPSK	1	0	23.50	23.30	23.47	23.48
			1	24	23.50	23.41	23.48	23.50
			1	49	23.50	23.35	23.45	23.49
			25	0	22.50	22.35	22.50	22.49
			25	12	22.50	22.35	22.48	22.49
			25	24	22.50	22.36	22.47	22.43
			50	0	22.50	22.49	22.48	22.50
		16QAM	1	0	22.50	22.50	22.45	22.46
			1	24	22.50	22.42	22.46	22.45
			1	49	22.50	22.47	22.49	22.48
			25	0	21.50	21.50	21.48	21.48
			25	12	21.50	21.48	21.47	21.45
			25	24	21.50	21.44	21.49	21.48
			50	0	21.50	21.50	21.47	21.49
LTE Band VII	15MHz	QPSK	RB Configuration		Tune-up	Channel/Frequency(MHz)		
			RB Size	RB Offset		20825/2507.5	21100/2535	21375/2562.5
1	0		23.50	23.30	23.49	23.43		
1	37	23.50	23.38	23.50	23.48			
1	74	23.50	23.43	23.48	23.49			

			36	0	22.50	22.50	22.48	22.47
			36	18	22.50	22.49	22.47	22.48
			36	37	22.50	22.41	22.43	22.49
			75	0	22.50	22.49	22.48	22.48
		16QAM	1	0	22.50	22.43	22.38	22.42
			1	37	22.50	22.47	22.35	22.31
			1	74	22.50	22.49	22.45	22.41
			36	0	21.50	21.46	21.50	21.46
			36	18	21.50	21.48	21.47	21.47
			36	37	21.50	21.49	21.49	21.47
		75	0	21.50	21.50	21.48	21.49	
Band	Band Width	Modulation	RB Configuration		Tune-up	Channel/Frequency(MHz)		
			RB Size	RB Offset		20850/2510	21100/2535	21350/2560
LTE Band VII	20MHz	QPSK	1	0	23.50	23.50	23.50	23.49
			1	49	23.50	23.49	23.49	23.47
			1	99	23.50	23.48	23.49	23.48
			50	0	22.50	22.46	22.49	22.49
			50	24	22.50	22.49	22.48	22.47
			50	49	22.50	22.50	22.43	22.49
			100	0	22.50	22.48	22.50	22.48
		16QAM	1	0	22.50	22.35	22.46	22.37
			1	49	22.50	22.36	22.32	22.39
			1	99	22.50	22.46	22.28	22.41
			50	0	21.50	21.47	21.49	21.46
			50	24	21.50	21.49	21.45	21.48
			50	49	21.50	21.50	21.48	21.47
			100	0	21.50	21.50	21.48	21.45

7.5. WLAN & Bluetooth Output Power

7.5.1. Output Power Results Of WLAN

Mode	Channel	Frequency (MHz)	Tune-up	Output Power (dBm)
802.11b	1	2412	14.0	13.8
	6	2437	14.0	12.5
	11	2462	14.0	13.4
802.11g	1	2412	14.0	12.6
	6	2437	14.0	12.7
	11	2462	14.0	13.3
802.11n 20M	1	2412	14.0	12.5
	6	2437	14.0	12.5
	11	2462	14.0	13.2

7.5.2. Output Power Results Of Bluetooth

BR+EDR	Output Power (dBm)				
	Channel	Tune-up	Data Rates		
			1M	2M	3M
	0CH	7.50	7.43	7.13	7.45
	39CH	6.50	5.21	5.73	6.11
	78CH	6.50	5.35	5.86	6.20

BLE	Channel	Tune-up	Output Power (dBm)
	0CH	0.00	0.00
	19CH	0.00	-1.79
	39CH	0.00	-0.93

8. Antenna Location

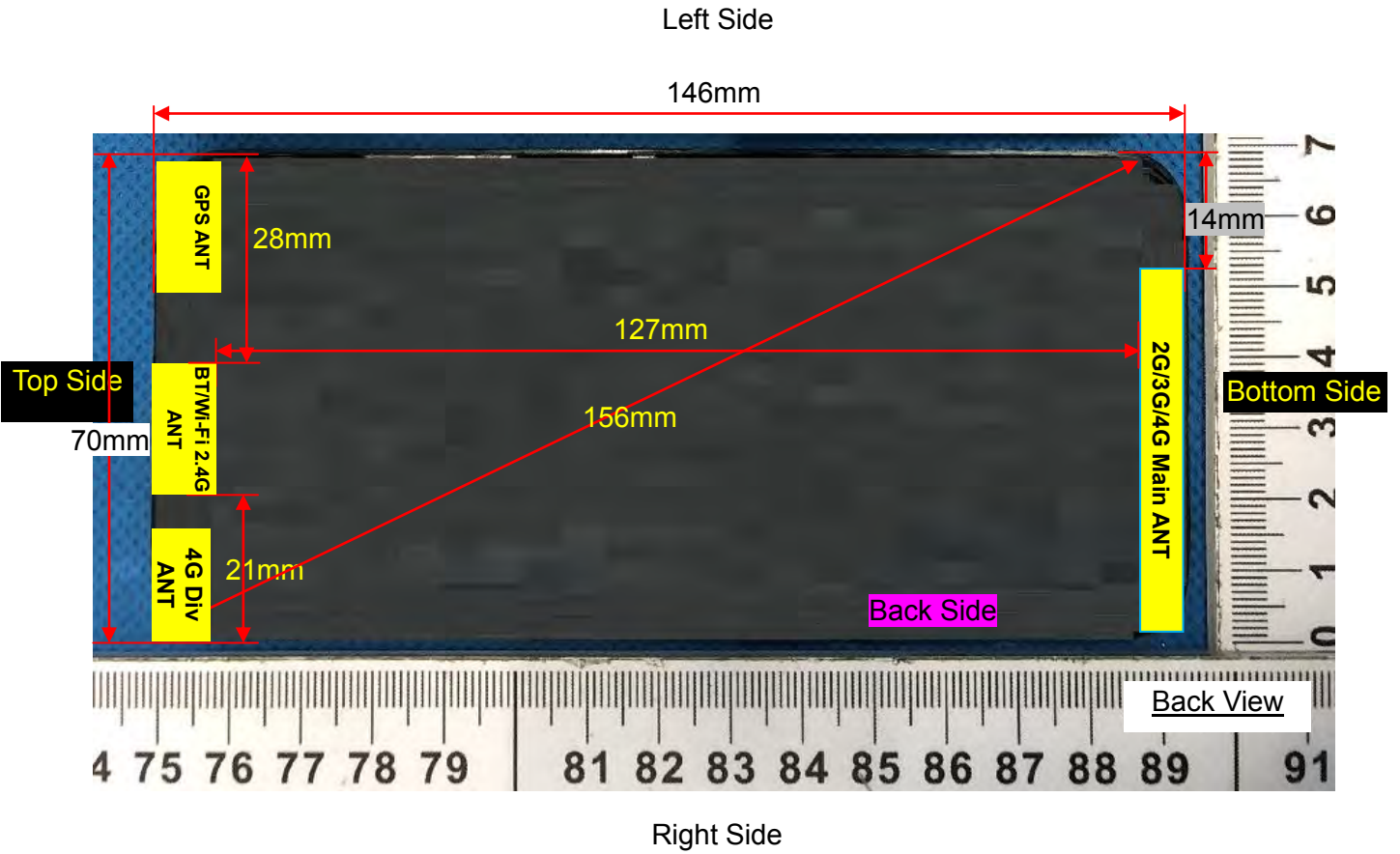

Distance of the Antenna to the EUT surface/edge						
Antennas	Front Side	Back Side	Left Side	Right Side	Top Side	Bottom Side
WWAN Main	≤ 25mm	≤ 25mm	≤ 25mm	≤ 25mm	>25mm	≤ 25mm
WLAN & Bluetooth	≤ 25mm	≤ 25mm	>25mm	≤ 25mm	≤ 25mm	>25mm
Positions for SAR tests						
Antennas	Front Side	Back Side	Left Side	Right Side	Top Side	Bottom Side
WWAN Main	Yes	Yes	Yes	Yes	NO	Yes
WLAN & Bluetooth	Yes	Yes	NO	Yes	Yes	NO

9. Stand-alone SAR test exclusion

Refer to FCC KDB 447498D01, the 1-g SAR and 10-g SAR test exclusion thresholds for 100 MHz to 6 GHz at test separation distances ≤ 50 mm are determined by:

$[(\text{max. power of channel, including tune-up tolerance, mW}) / (\text{min. test separation distance, mm})] \cdot [\sqrt{f_{(\text{GHz})}}] \leq 3.0$ for 1-g SAR and ≤ 7.5 for 10-g extremity SAR, where:

- $f_{(\text{GHz})}$ is the RF channel transmit frequency in GHz
- Power and distance are rounded to the nearest mW and mm before calculation
- The result is rounded to one decimal place for comparison

When the minimum test separation distance is < 5 mm, a distance of 5 mm is applied to determine SAR test exclusion.

Mode	P_{max} (dBm)	P_{max} (mW)	Distance (mm)	f (GHz)	Calculation Result	SAR Exclusion threshold	SAR test exclusion
Bluetooth	7.50	5.62	5	2.480	1.77	3.0	Yes

NOTE: Standalone SAR test exclusion for Bluetooth

When standalone SAR test exclusion applies to an antenna that transmits simultaneously with other antennas, the standalone SAR must be estimated according to following to determine simultaneous transmission SAR test exclusion:

$[(\text{max. power of channel, including tune-up tolerance, mW}) / (\text{min. test separation distance, mm})] \cdot [\sqrt{f_{(\text{GHz})} / x}] \text{ W/kg}$ for test separation distances ≤ 50 mm, where $x = 7.5$ for 1-g SAR and $x = 18.75$ for 10-g SAR.

When the minimum test separation distance is < 5 mm, a distance of 5 mm is applied to determine SAR test exclusion.

Mode	Position	P_{max} (dBm)	P_{max} (mW)	Distance (mm)	f (GHz)	x	Estimated SAR (W/Kg)
Bluetooth	Head	7.50	5.62	5	2.480	7.5	0.236
Bluetooth	Body	7.50	5.62	10	2.480	7.5	0.118
Bluetooth	Hotspot	7.50	5.62	10	2.480	7.5	0.118

NOTE: Estimated SAR calculation for Bluetooth

10. SAR Results

10.1. SAR measurement results

10.1.1. SAR measurement Result of GSM850

Test Position of Head	Test channel /Freq.	Test Mode	SAR Value (W/kg)		Power Drift (±5%)	Conducted power (dBm)	Tune-up power (dBm)	Scaled SAR 1g (W/Kg)
			1g	10g				
Left Cheek	189/836.4	GPRS(GMSK 4TS)	0.190	0.144	1.90	27.82	28.00	0.198
Left Tilt 15 Degree	189/836.4	GPRS(GMSK 4TS)	0.125	0.095	3.21	27.82	28.00	0.130
Right Cheek	189/836.4	GPRS(GMSK 4TS)	0.182	0.138	0.21	27.82	28.00	0.190
Right Tilt 15 Degree	189/836.4	GPRS(GMSK 4TS)	0.116	0.087	1.28	27.82	28.00	0.121

NOTE: Head SAR test results of GSM850.

Test Position of Body-Worn with 10mm	Test channel /Freq.	Test Mode	SAR Value (W/kg)		Power Drift (±5%)	Conducted power (dBm)	Tune-up power (dBm)	Scaled SAR 1g (W/Kg)
			1g	10g				
Front Side	189/836.4	GPRS(GMSK 4TS)	0.186	0.141	0.14	27.82	28.00	0.194
Back Side	189/836.4	GPRS(GMSK 4TS)	0.221	0.168	-2.34	27.82	28.00	0.230

NOTE: Body-Worn SAR test results of GSM850

Test Position of Hotspot with 10mm	Test channel /Freq.	Test Mode	SAR Value (W/kg)		Power Drift (±5%)	Conducted power (dBm)	Tune-up power (dBm)	Scaled SAR 1g (W/Kg)
			1g	10g				
Front Side	189/836.4	GPRS(GMSK 4TS)	0.186	0.141	0.14	27.82	28.00	0.194
Back Side	189/836.4	GPRS(GMSK 4TS)	0.221	0.168	-2.34	27.82	28.00	0.230
Left Side	189/836.4	GPRS(GMSK 4TS)	0.178	0.135	-2.54	27.82	28.00	0.186
Right Side	189/836.4	GPRS(GMSK 4TS)	0.182	0.138	0.65	27.82	28.00	0.190
Bottom Side	189/836.4	GPRS(GMSK 4TS)	0.204	0.155	3.24	27.82	28.00	0.213

NOTE: Hotspot SAR test results of GSM850

10.1.2. SAR measurement Result of GSM1900

Test Position of Head	Test channel /Freq.	Test Mode	SAR Value (W/kg)		Power Drift (±5%)	Conducted power (dBm)	Tune-up power (dBm)	Scaled SAR 1g (W/Kg)
			1g	10g				
Left Cheek	661/1880	GPRS(GMSK 4TS)	0.100	0.062	-2.24	26.72	27.00	0.107

Left Tilt 15 Degree	661/1880	GPRS(GMSK 4TS)	0.075	0.048	0.21	26.72	27.00	0.080
Right Cheek	661/1880	GPRS(GMSK 4TS)	0.097	0.058	1.47	26.72	27.00	0.103
Right Tilt 15 Degree	661/1880	GPRS(GMSK 4TS)	0.071	0.045	-0.65	26.72	27.00	0.076

NOTE: Head SAR test results of GSM1900

Test Position of Body-Worn with 10mm	Test channel /Freq.	Test Mode	SAR Value (W/kg)		Power Drift (±5%)	Conducted power (dBm)	Tune-up power (dBm)	Scaled SAR 1g (W/Kg)
			1g	10g				
Front Side	661/1880	GPRS(GMSK 4TS)	0.287	0.147	0.58	26.72	27.00	0.306
Back Side	661/1880	GPRS(GMSK 4TS)	0.303	0.167	-4.06	26.72	27.00	0.323

NOTE: Body-Worn SAR test results of GSM1900

Test Position of Hotspot with 10mm	Test channel /Freq.	Test Mode	SAR Value (W/kg)		Power Drift (±5%)	Conducted power (dBm)	Tune-up power (dBm)	Scaled SAR 1g (W/Kg)
			1g	10g				
Front Side	661/1880	GPRS(GMSK 4TS)	0.287	0.147	0.58	26.72	27.00	0.306
Back Side	661/1880	GPRS(GMSK 4TS)	0.303	0.167	-4.06	26.72	27.00	0.323
Left Side	661/1880	GPRS(GMSK 4TS)	0.257	0.134	1.47	26.72	27.00	0.274
Right Side	661/1880	GPRS(GMSK 4TS)	0.262	0.141	-0.84	26.72	27.00	0.279
Bottom Side	661/1880	GPRS(GMSK 4TS)	0.297	0.152	-2.33	26.72	27.00	0.317

NOTE: Hotspot SAR test results of GSM1900

10.1.3. SAR measurement Result of WCDMA Band V

Test Position of Head	Test channel /Freq.	Test Mode	SAR Value (W/kg)		Power Drift (±5%)	Conducted power (dBm)	Tune-up power (dBm)	Scaled SAR 1g (W/Kg)
			1g	10g				
Left Cheek	4182/836.4	RMC12.2K	0.160	0.122	-2.77	22.33	22.50	0.166
Left Tilt 15 Degree	4182/836.4	RMC12.2K	0.125	0.101	0.21	22.33	22.50	0.130
Right Cheek	4182/836.4	RMC12.2K	0.152	0.115	1.47	22.33	22.50	0.158
Right Tilt 15 Degree	4182/836.4	RMC12.2K	0.119	0.093	0.47	22.33	22.50	0.124

NOTE: Head SAR test results of WCDMA Band V

Test Position of Body-Worn with 10mm	Test channel /Freq.	Test Mode	SAR Value (W/kg)		Power Drift (±5%)	Conducted power (dBm)	Tune-up power (dBm)	Scaled SAR 1g (W/Kg)
			1g	10g				

Front Side	4182/836.4	RMC12.2K	0.151	0.129	0.23	22.33	22.50	0.157
Back Side	4182/836.4	RMC12.2K	0.180	0.141	0.35	22.33	22.50	0.187

NOTE: Body-Worn SAR test results of WCDMA Band V

Test Position of Hotspot with 10mm	Test channel /Freq.	Test Mode	SAR Value (W/kg)		Power Drift (±5%)	Conducted power (dBm)	Tune-up power (dBm)	Scaled SAR 1g (W/Kg)
			1g	10g				
Front Side	4182/836.4	RMC12.2K	0.151	0.129	0.23	22.33	22.50	0.157
Back Side	4182/836.4	RMC12.2K	0.180	0.141	0.35	22.33	22.50	0.187
Left Side	4182/836.4	RMC12.2K	0.145	0.121	1.04	22.33	22.50	0.151
Right Side	4182/836.4	RMC12.2K	0.142	0.136	1.25	22.33	22.50	0.148
Bottom Side	4182/836.4	RMC12.2K	0.150	0.128	-0.33	22.33	22.50	0.156

NOTE: Hotspot SAR test results of WCDMA Band V

10.1.4. SAR measurement Result of WCDMA Band II

Test Position of Head	Test channel /Freq.	Test Mode	SAR Value (W/kg)		Power Drift (±5%)	Conducted power (dBm)	Tune-up power (dBm)	Scaled SAR 1g (W/Kg)
			1g	10g				
Left Cheek	9400/1880	RMC12.2K	0.184	0.112	-3.04	22.49	22.50	0.184
Left Tilt 15 Degree	9400/1880	RMC12.2K	0.124	0.079	0.25	22.49	22.50	0.124
Right Cheek	9400/1880	RMC12.2K	0.170	0.105	1.47	22.49	22.50	0.170
Right Tilt 15 Degree	9400/1880	RMC12.2K	0.115	0.070	-0.32	22.49	22.50	0.115

NOTE: Head SAR test results of WCDMA Band II

Test Position of Body-Worn with 10mm	Test channel /Freq.	Test Mode	SAR Value (W/kg)		Power Drift (±5%)	Conducted power (dBm)	Tune-up power (dBm)	Scaled SAR 1g (W/Kg)
			1g	10g				
Front Side	9400/1880	RMC12.2K	0.501	0.273	0.27	22.49	22.50	0.502
Back Side	9400/1880	RMC12.2K	0.544	0.302	-0.06	22.49	22.50	0.545

NOTE: Body-Worn SAR test results of WCDMA Band II

Test Position of Hotspot with 10mm	Test channel /Freq.	Test Mode	SAR Value (W/kg)		Power Drift (±5%)	Conducted power (dBm)	Tune-up power (dBm)	Scaled SAR 1g (W/Kg)
			1g	10g				
Front Side	9400/1880	RMC12.2K	0.501	0.273	0.27	22.49	22.50	0.502
Back Side	9400/1880	RMC12.2K	0.544	0.302	-0.06	22.49	22.50	0.545
Left Side	9400/1880	RMC12.2K	0.489	0.263	-3.05	22.49	22.50	0.490
Right Side	9400/1880	RMC12.2K	0.470	0.254	1.28	22.49	22.50	0.471

Bottom Side	9400/1880	RMC12.2K	0.523	0.276	-1.47	22.49	22.50	0.524
-------------	-----------	----------	-------	-------	-------	-------	-------	-------

NOTE: Hotspot SAR test results of WCDMA Band II

10.1.5. SAR measurement Result of LTE Band V

Test Position of Head	Test channel /Freq.	Test Mode	SAR Value (W/kg)		Power Drift (±5%)	Conducted power (dBm)	Tune-up power (dBm)	Scaled SAR 1g (W/Kg)
			1g	10g				
1RB								
Left Cheek	20525/836.5	10M QPSK(1,24)	0.163	0.125	2.27	22.61	23.50	0.200
Left Tilt 15 Degree	20525/836.5	10M QPSK(1,24)	0.123	0.092	0.12	22.61	23.50	0.151
Right Cheek	20525/836.5	10M QPSK(1,24)	0.152	0.113	-4.12	22.61	23.50	0.187
Right Tilt 15 Degree	20525/836.5	10M QPSK(1,24)	0.110	0.082	0.36	22.61	23.50	0.135
50%RB								
Left Cheek	20525/836.5	1.4M QPSK(3,0)	0.150	0.113	2.54	22.72	23.50	0.180
Left Tilt 15 Degree	20525/836.5	1.4M QPSK(3,0)	0.112	0.081	1.05	22.72	23.50	0.134
Right Cheek	20525/836.5	1.4M QPSK(3,0)	0.140	0.102	3.14	22.72	23.50	0.168
Right Tilt 15 Degree	20525/836.5	1.4M QPSK(3,0)	0.092	0.075	-0.54	22.72	23.50	0.110

NOTE: Head SAR test results of LTE Band V

Test Position of Body-Worn with 10mm	Test channel /Freq.	Test Mode	SAR Value (W/kg)		Power Drift (±5%)	Conducted power (dBm)	Tune-up power (dBm)	Scaled SAR 1g (W/Kg)
			1g	10g				
1RB								
Front Side	20525/836.5	10M QPSK(1,24)	0.142	0.111	0.49	22.61	23.50	0.174
Back Side	20525/836.5	10M	0.171	0.134	1.56	22.61	23.50	0.210

		QPSK(1,24)						
50%RB								
Front Side	20525/836.5	1.4M QPSK(3,0)	0.132	0.104	0.23	22.72	23.50	0.158
Back Side	20525/836.5	1.4M QPSK(3,0)	0.163	0.127	2.51	22.72	23.50	0.195

NOTE: Body-Worn SAR test results of LTE Band V

Test Position of Hotspot with 10mm	Test channel /Freq.	Test Mode	SAR Value (W/kg)		Power Drift (±5%)	Conducted power (dBm)	Tune-up power (dBm)	Scaled SAR 1g (W/Kg)
			1g	10g				
1RB								
Front Side	20525/836.5	10M QPSK(1,24)	0.142	0.111	0.49	22.61	23.50	0.174
Back Side	20525/836.5	10M QPSK(1,24)	0.171	0.134	1.56	22.61	23.50	0.210
Left Side	20525/836.5	10M QPSK(1,24)	0.102	0.079	0.25	22.61	23.50	0.125
Right Side	20525/836.5	10M QPSK(1,24)	0.096	0.071	0.72	22.61	23.50	0.118
Bottom Side	20525/836.5	10M QPSK(1,24)	0.098	0.074	-1.47	22.61	23.50	0.120
50%RB								
Front Side	20525/836.5	1.4M QPSK(3,0)	0.132	0.104	0.23	22.72	23.50	0.158
Back Side	20525/836.5	1.4M QPSK(3,0)	0.163	0.127	2.51	22.72	23.50	0.195
Left Side	20525/836.5	1.4M QPSK(3,0)	0.092	0.067	3.54	22.72	23.50	0.110
Right Side	20525/836.5	1.4M QPSK(3,0)	0.086	0.064	-0.24	22.72	23.50	0.103
Bottom Side	20525/836.5	1.4M QPSK(3,0)	0.084	0.060	-1.53	22.72	23.50	0.101

NOTE: Hotspot SAR test results of LTE Band V

10.1.6. SAR measurement Result of LTE Band IV

Test Position of Head	Test channel /Freq.	Test Mode	SAR Value (W/kg)		Power Drift (±5%)	Conducted power (dBm)	Tune-up power (dBm)	Scaled SAR 1g (W/Kg)
			1g	10g				
1RB								

Left Cheek	20175/1732.5	20M QPSK(1,99)	0.209	0.133	-3.89	22.50	22.50	0.209
Left Tilt 15 Degree	20175/1732.5	20M QPSK(1,99)	0.154	0.082	0.54	22.50	22.50	0.154
Right Cheek	20175/1732.5	20M QPSK(1,99)	0.188	0.109	1.42	22.50	22.50	0.188
Right Tilt 15 Degree	20175/1732.5	20M QPSK(1,99)	0.136	0.071	3.01	22.50	22.50	0.136
50%RB								
Left Cheek	20175/1732.5	1.4M QPSK(3,2)	0.195	0.125	0.21	22.46	22.50	0.197
Left Tilt 15 Degree	20175/1732.5	1.4M QPSK(3,2)	0.142	0.075	0.54	22.46	22.50	0.143
Right Cheek	20175/1732.5	1.4M QPSK(3,2)	0.173	0.100	1.27	22.46	22.50	0.175
Right Tilt 15 Degree	20175/1732.5	1.4M QPSK(3,2)	0.120	0.065	-0.36	22.46	22.50	0.121

NOTE: Head SAR test results of LTE Band IV

Test Position of Body-Worn with 10mm	Test channel /Freq.	Test Mode	SAR Value (W/kg)		Power Drift (±5%)	Conducted power (dBm)	Tune-up power (dBm)	Scaled SAR 1g (W/Kg)
			1g	10g				
1RB								
Front Side	20175/1732.5	20M QPSK(1,99)	0.402	0.248	0.25	22.50	22.50	0.402
Back Side	20175/1732.5	20M QPSK(1,99)	0.455	0.276	-1.39	22.50	22.50	0.455
50%RB								
Front Side	20175/1732.5	1.4M QPSK(3,2)	0.392	0.231	0.54	22.46	22.50	0.396
Back Side	20175/1732.5	1.4M QPSK(3,2)	0.421	0.251	4.05	22.46	22.50	0.425

NOTE: Body-Worn SAR test results of LTE Band IV

Test Position of	Test channel /Freq.	Test Mode	SAR Value (W/kg)	Power Drift	Conducted	Tune-up	Scaled SAR 1g
------------------	---------------------	-----------	------------------	-------------	-----------	---------	---------------

Hotspot with 10mm			1g	10g	(±5%)	power (dBm)	power (dBm)	(W/Kg)
1RB								
Front Side	20175/1732.5	20M QPSK(1,99)	0.402	0.248	0.25	22.50	22.50	0.402
Back Side	20175/1732.5	20M QPSK(1,99)	0.455	0.276	-1.39	22.50	22.50	0.455
Left Side	20175/1732.5	20M QPSK(1,99)	0.397	0.240	1.47	22.50	22.50	0.397
Right Side	20175/1732.5	20M QPSK(1,99)	0.375	0.227	3.21	22.50	22.50	0.375
Bottom Side	20175/1732.5	20M QPSK(1,99)	0.284	0.163	-3.08	22.50	22.50	0.284
50%RB								
Front Side	20175/1732.5	1.4M QPSK(3,2)	0.392	0.231	0.54	22.46	22.50	0.396
Back Side	20175/1732.5	1.4M QPSK(3,2)	0.421	0.251	4.05	22.46	22.50	0.425
Left Side	20175/1732.5	1.4M QPSK(3,2)	0.375	0.226	3.18	22.46	22.50	0.378
Right Side	20175/1732.5	1.4M QPSK(3,2)	0.353	0.209	2.64	22.46	22.50	0.356
Bottom Side	20175/1732.5	1.4M QPSK(3,2)	0.268	0.154	-3.07	22.46	22.50	0.270

NOTE: Hotspot SAR test results of LTE Band IV

10.1.7. SAR measurement Result of LTE Band II

Test Position of Head	Test channel /Freq.	Test Mode	SAR Value (W/kg)		Power Drift (±5%)	Conducted power (dBm)	Tune-up power (dBm)	Scaled SAR 1g (W/Kg)
			1g	10g				
1RB								
Left Cheek	18900/1880	20M QPSK(1,99)	0.186	0.113	-2.06	23.44	23.50	0.189
Left Tilt 15 Degree	18900/1880	20M QPSK(1,99)	0.134	0.085	0.54	23.44	23.50	0.136
Right Cheek	18900/1880	20M QPSK(1,99)	0.173	0.102	3.41	23.44	23.50	0.175
Right	18900/1880	20M QPSK(1,99)	0.128	0.079	-0.67	23.44	23.50	0.130

Tilt 15 Degree								
50%RB								
Left Cheek	18900/1880	1.4M QPSK(3,0)	0.179	0.106	0.41	23.34	23.50	0.186
Left Tilt 15 Degree	18900/1880	1.4M QPSK(3,0)	0.131	0.081	1.48	23.34	23.50	0.136
Right Cheek	18900/1880	1.4M QPSK(3,0)	0.165	0.092	3.21	23.34	23.50	0.171
Right Tilt 15 Degree	18900/1880	1.4M QPSK(3,0)	0.114	0.063	-0.57	23.34	23.50	0.118

NOTE: Head SAR test results of LTE Band II

Test Position of Body-Worn with 10mm	Test channel /Freq.	Test Mode	SAR Value (W/kg)		Power Drift (±5%)	Conducted power (dBm)	Tune-up power (dBm)	Scaled SAR 1g (W/Kg)
			1g	10g				
1RB								
Front Side	18900/1880	20M QPSK(1,99)	0.487	0.200	0.51	23.44	23.50	0.494
Back Side	18900/1880	20M QPSK(1,99)	0.504	0.282	-1.94	23.44	23.50	0.511
50%RB								
Front Side	18900/1880	1.4M QPSK(3,0)	0.465	0.187	0.24	23.34	23.50	0.482
Back Side	18900/1880	1.4M QPSK(3,0)	0.491	0.270	0.64	23.34	23.50	0.509

NOTE: Body-Worn SAR test results of LTE Band II

Test Position of Hotspot with 10mm	Test channel /Freq.	Test Mode	SAR Value (W/kg)		Power Drift (±5%)	Conducted power (dBm)	Tune-up power (dBm)	Scaled SAR 1g (W/Kg)
			1g	10g				
1RB								
Front Side	18900/1880	20M QPSK(1,99)	0.487	0.200	0.51	23.44	23.50	0.494
Back Side	18900/1880	20M QPSK(1,99)	0.504	0.282	-1.94	23.44	23.50	0.511
Left Side	18900/1880	20M QPSK(1,99)	0.467	0.189	0.67	23.44	23.50	0.473
Right Side	18900/1880	20M QPSK(1,99)	0.441	0.167	0.47	23.44	23.50	0.447
Bottom	18900/1880	20M	0.510	0.269	0.09	23.44	23.50	0.517

Side		QPSK(1,99)						
50%RB								
Front Side	18900/1880	1.4M QPSK(3,0)	0.465	0.187	0.24	23.34	23.50	0.482
Back Side	18900/1880	1.4M QPSK(3,0)	0.491	0.270	0.64	23.34	23.50	0.509
Left Side	18900/1880	1.4M QPSK(3,0)	0.452	0.171	-1.27	23.34	23.50	0.469
Right Side	18900/1880	1.4M QPSK(3,0)	0.432	0.156	2.51	23.34	23.50	0.448
Bottom Side	18900/1880	1.4M QPSK(3,0)	0.500	0.254	3.42	23.34	23.50	0.519

NOTE: Hotspot SAR test results of LTE Band II

10.1.8. SAR measurement Result of LTE Band VII

Test Position of Head	Test channel /Freq.	Test Mode	SAR Value (W/kg)		Power Drift (±5%)	Conducted power (dBm)	Tune-up power (dBm)	Scaled SAR 1g (W/Kg)
			1g	10g				
1RB								
Left Cheek	21100/2535	20M QPSK(1,0)	0.173	0.108	-4.70	23.50	23.50	0.173
Left Tilt 15 Degree	21100/2535	20M QPSK(1,0)	0.142	0.087	3.04	23.50	23.50	0.142
Right Cheek	21100/2535	20M QPSK(1,0)	0.165	0.094	1.25	23.50	23.50	0.165
Right Tilt 15 Degree	21100/2535	20M QPSK(1,0)	0.130	0.072	-0.47	23.50	23.50	0.130
50%RB								
Left Cheek	21100/2535	20M QPSK(50,49)	0.162	0.091	0.57	22.43	22.50	0.165
Left Tilt 15 Degree	21100/2535	20M QPSK(50,49)	0.132	0.081	2.16	22.43	22.50	0.134
Right Cheek	21100/2535	20M QPSK(50,49)	0.153	0.083	3.51	22.43	22.50	0.155
Right Tilt 15 Degree	21100/2535	20M QPSK(50,49)	0.122	0.063	0.43	22.43	22.50	0.124

NOTE: Head SAR test results of LTE Band VII

Test	Test channel	Test Mode	SAR Value	Power	Conduc	Tune-u	Scaled
------	--------------	-----------	-----------	-------	--------	--------	--------

Position of Body-Worn with 10mm	/Freq.		(W/kg)		Drift (±5%)	Conducted power (dBm)	Tune-up power (dBm)	SAR 1g (W/Kg)
			1g	10g				
1RB								
Front Side	21100/2535	20M QPSK(1,0)	0.256	0.157	0.28	23.50	23.50	0.256
Back Side	21100/2535	20M QPSK(1,0)	0.276	0.168	-2.69	23.50	23.50	0.276
50%RB								
Front Side	21100/2535	20M QPSK(50,49)	0.241	0.143	2.48	22.43	22.50	0.245
Back Side	21100/2535	20M QPSK(50,49)	0.261	0.154	1.40	22.43	22.50	0.265

NOTE: Body-Worn SAR test results of LTE Band VII

Test Position of Hotspot with 10mm	Test channel /Freq.	Test Mode	SAR Value (W/kg)		Power Drift (±5%)	Conducted power (dBm)	Tune-up power (dBm)	Scaled SAR 1g (W/Kg)
			1g	10g				
1RB								
Front Side	21100/2535	20M QPSK(1,0)	0.256	0.157	0.28	23.50	23.50	0.256
Back Side	21100/2535	20M QPSK(1,0)	0.276	0.168	-2.69	23.50	23.50	0.276
Left Side	21100/2535	20M QPSK(1,0)	0.231	0.142	-3.14	23.50	23.50	0.231
Right Side	21100/2535	20M QPSK(1,0)	0.239	0.148	0.37	23.50	23.50	0.239
Bottom Side	21100/2535	20M QPSK(1,0)	0.590	0.308	-1.64	23.50	23.50	0.590
50%RB								
Front Side	21100/2535	20M QPSK(50,49)	0.241	0.143	2.48	22.43	22.50	0.245
Back Side	21100/2535	20M QPSK(50,49)	0.261	0.154	1.40	22.43	22.50	0.265
Left Side	21100/2535	20M QPSK(50,49)	0.220	0.130	-3.67	22.43	22.50	0.224
Right Side	21100/2535	20M QPSK(50,49)	0.214	0.128	4.08	22.43	22.50	0.217
Bottom Side	21100/2535	20M QPSK(50,49)	0.574	0.285	-2.54	22.43	22.50	0.583

NOTE: Hotspot SAR test results of LTE Band VII

10.1.9. SAR measurement Result of WLAN 2.4G

Test Position of Head	Test channel	Test Mode	SAR Value (W/kg)	Power Drift	Conducted power	Tune-up power	Scaled SAR
-----------------------	--------------	-----------	------------------	-------------	-----------------	---------------	------------

	/Freq.		1g	10g	(±5%)	(dBm)	(dBm)	1g (W/Kg)
Left Cheek	6/2437	802.11 b	0.214	0.122	-4.10	12.50	14.00	0.302
Left Tilt 15 Degree	6/2437	802.11 b	0.128	0.072	0.35	12.50	14.00	0.181
Right Cheek	6/2437	802.11 b	0.205	0.116	-0.14	12.50	14.00	0.290
Right Tilt 15 Degree	6/2437	802.11 b	0.112	0.060	2.57	12.50	14.00	0.158

NOTE: Head SAR test results of WLAN 2.4G

Test Position of Body-Worn with 10mm	Test channel /Freq.	Test Mode	SAR Value (W/kg)		Power Drift (±5%)	Conducted power (dBm)	Tune-up power (dBm)	Scaled SAR 1g (W/Kg)
			1g	10g				
Front Side	6/2437	802.11 b	0.084	0.055	1.89	12.50	14.00	0.119
Back Side	6/2437	802.11 b	0.088	0.059	-1.46	12.50	14.00	0.124

NOTE: Body-Worn SAR test results of WLAN 2.4G

Test Position of Hotspot with 10mm	Test channel /Freq.	Test Mode	SAR Value (W/kg)		Power Drift (±5%)	Conducted power (dBm)	Tune-up power (dBm)	Scaled SAR 1g (W/Kg)
			1g	10g				
Front Side	6/2437	802.11 b	0.084	0.055	1.89	12.50	14.00	0.119
Back Side	6/2437	802.11 b	0.088	0.059	-1.46	12.50	14.00	0.124
Right Side	6/2437	802.11 b	0.067	0.041	1.28	12.50	14.00	0.095
Top Side	6/2437	802.11 b	0.055	0.039	-2.77	12.50	14.00	0.078

NOTE: Hotspot SAR test results of WLAN 2.4G

10.2. SAR Summation Scenario

Per KDB 447498 D01, simultaneous transmission SAR is compliant if,

- Scalar SAR summation < 1.6W/kg.
- SPLSR = $(SAR_1 + SAR_2)^{1.5} / (\text{min. separation distance, mm})$, and the peak separation distance is determined from the square root of $[(x_1 - x_2)^2 + (y_1 - y_2)^2 + (z_1 - z_2)^2]$, where (x_1, y_1, z_1) and (x_2, y_2, z_2) are the coordinates of the extrapolated peak SAR locations in the zoom scan. If $SPLSR \leq 0.04$, simultaneously transmission SAR measurement is not necessary.

Test Position		Scaled SAR _{MAX}		Σ 1-g SAR (W/Kg)	SPLSR	Remark
		GSM 850	WLAN 2.4G			
Head	Left Cheek	0.198	0.302	0.500	N/A	N/A
	Left Tilt 15 Degree	0.130	0.181	0.311	N/A	N/A

	Right Cheek	0.190	0.290	0.480	N/A	N/A
	Right Tilt 15 Degree	0.121	0.158	0.279	N/A	N/A
Body-Worn	Front Side	0.194	0.119	0.313	N/A	N/A
	Back Side	0.230	0.124	0.354	N/A	N/A
Hotspot	Front Side	0.194	0.119	0.313	N/A	N/A
	Back Side	0.230	0.124	0.354	N/A	N/A
	Left Side	0.186	N/A	0.186	N/A	N/A
	Right Side	0.190	0.095	0.285	N/A	N/A
	Top Side	N/A	0.078	0.078	N/A	N/A
	Bottom Side	0.213	N/A	0.213	N/A	N/A

NOTE: 1-g SAR Simultaneous Tx Combination of GSM850 and WLAN 2.4G.

Test Position		Scaled SAR _{MAX}		Σ 1-g SAR (W/Kg)	SPLSR	Remark
		GSM 1900	WLAN 2.4G			
Head	Left Cheek	0.107	0.302	0.409	N/A	N/A
	Left Tilt 15 Degree	0.080	0.181	0.261	N/A	N/A
	Right Cheek	0.103	0.290	0.393	N/A	N/A
	Right Tilt 15 Degree	0.076	0.158	0.234	N/A	N/A
Body-Worn	Front Side	0.306	0.119	0.425	N/A	N/A
	Back Side	0.323	0.124	0.447	N/A	N/A
Hotspot	Front Side	0.306	0.119	0.425	N/A	N/A
	Back Side	0.323	0.124	0.447	N/A	N/A
	Left Side	0.274	N/A	0.274	N/A	N/A
	Right Side	0.279	0.095	0.374	N/A	N/A
	Top Side	N/A	0.078	0.078	N/A	N/A
	Bottom Side	0.317	N/A	0.317	N/A	N/A

NOTE: 1-g SAR Simultaneous Tx Combination of GSM1900 and WLAN 2.4G.

Test Position		Scaled SAR _{MAX}		Σ 1-g SAR (W/Kg)	SPLSR	Remark
		WCDMA Band V	WLAN 2.4G			
Head	Left Cheek	0.166	0.302	0.468	N/A	N/A
	Left Tilt 15 Degree	0.130	0.181	0.311	N/A	N/A
	Right Cheek	0.158	0.290	0.448	N/A	N/A
	Right Tilt 15 Degree	0.124	0.158	0.282	N/A	N/A
Body-Worn	Front Side	0.157	0.119	0.276	N/A	N/A
	Back Side	0.187	0.124	0.311	N/A	N/A
Hotspot	Front Side	0.157	0.119	0.276	N/A	N/A
	Back Side	0.187	0.124	0.311	N/A	N/A

	Left Side	0.151	N/A	0.151	N/A	N/A
	Right Side	0.148	0.095	0.243	N/A	N/A
	Top Side	N/A	0.078	0.078	N/A	N/A
	Bottom Side	0.156	N/A	0.156	N/A	N/A

NOTE: 1-g SAR Simultaneous Tx Combination of WCDMA Band V and WLAN 2.4G.

Test Position		Scaled SAR _{MAX}		Σ 1-g SAR (W/Kg)	SPLSR	Remark
		WCDMA Band II	WLAN 2.4G			
Head	Left Cheek	0.184	0.302	0.486	N/A	N/A
	Left Tilt 15 Degree	0.124	0.181	0.305	N/A	N/A
	Right Cheek	0.170	0.290	0.460	N/A	N/A
	Right Tilt 15 Degree	0.115	0.158	0.273	N/A	N/A
Body-Worn	Front Side	0.502	0.119	0.621	N/A	N/A
	Back Side	0.545	0.124	0.669	N/A	N/A
Hotspot	Front Side	0.502	0.119	0.621	N/A	N/A
	Back Side	0.545	0.124	0.669	N/A	N/A
	Left Side	0.490	N/A	0.490	N/A	N/A
	Right Side	0.471	0.095	0.566	N/A	N/A
	Top Side	N/A	0.078	0.078	N/A	N/A
	Bottom Side	0.524	N/A	0.524	N/A	N/A

NOTE: 1-g SAR Simultaneous Tx Combination of WCDMA Band II and WLAN 2.4G.

Test Position		Scaled SAR _{MAX}		Σ 1-g SAR (W/Kg)	SPLSR	Remark
		LTE Band V	WLAN 2.4G			
Head	Left Cheek	0.200	0.302	0.502	N/A	N/A
	Left Tilt 15 Degree	0.151	0.181	0.332	N/A	N/A
	Right Cheek	0.187	0.290	0.477	N/A	N/A
	Right Tilt 15 Degree	0.135	0.158	0.293	N/A	N/A
Body-Worn	Front Side	0.174	0.119	0.293	N/A	N/A
	Back Side	0.210	0.124	0.334	N/A	N/A
Hotspot	Front Side	0.174	0.119	0.293	N/A	N/A
	Back Side	0.210	0.124	0.334	N/A	N/A
	Left Side	0.125	N/A	0.125	N/A	N/A
	Right Side	0.118	0.095	0.213	N/A	N/A
	Top Side	N/A	0.078	0.078	N/A	N/A
	Bottom Side	0.120	N/A	0.120	N/A	N/A

NOTE: 1-g SAR Simultaneous Tx Combination of LTE Band V and WLAN 2.4G.

Test Position	Scaled SAR _{MAX}		Σ 1-g SAR	SPLSR	Remark
---------------	---------------------------	--	-----------	-------	--------

		LTE Band IV	WLAN 2.4G	(W/Kg)		
Head	Left Cheek	0.209	0.302	0.511	N/A	N/A
	Left Tilt 15 Degree	0.154	0.181	0.335	N/A	N/A
	Right Cheek	0.188	0.290	0.478	N/A	N/A
	Right Tilt 15 Degree	0.136	0.158	0.294	N/A	N/A
Body-Worn	Front Side	0.402	0.119	0.521	N/A	N/A
	Back Side	0.455	0.124	0.579	N/A	N/A
Hotspot	Front Side	0.402	0.119	0.521	N/A	N/A
	Back Side	0.455	0.124	0.579	N/A	N/A
	Left Side	0.397	N/A	0.397	N/A	N/A
	Right Side	0.375	0.095	0.470	N/A	N/A
	Top Side	N/A	0.078	0.078	N/A	N/A
	Bottom Side	0.284	N/A	0.284	N/A	N/A

NOTE: 1-g SAR Simultaneous Tx Combination of LTE Band IV and WLAN 2.4G.

Test Position		Scaled SAR _{MAX}		Σ 1-g SAR (W/Kg)	SPLSR	Remark
		LTE Band II	WLAN 2.4G			
Head	Left Cheek	0.189	0.302	0.491	N/A	N/A
	Left Tilt 15 Degree	0.136	0.181	0.317	N/A	N/A
	Right Cheek	0.175	0.290	0.465	N/A	N/A
	Right Tilt 15 Degree	0.130	0.158	0.288	N/A	N/A
Body-Worn	Front Side	0.494	0.119	0.613	N/A	N/A
	Back Side	0.511	0.124	0.635	N/A	N/A
Hotspot	Front Side	0.494	0.119	0.613	N/A	N/A
	Back Side	0.511	0.124	0.635	N/A	N/A
	Left Side	0.473	N/A	0.473	N/A	N/A
	Right Side	0.447	0.095	0.542	N/A	N/A
	Top Side	N/A	0.078	0.078	N/A	N/A
	Bottom Side	0.517	N/A	0.517	N/A	N/A

NOTE: 1-g SAR Simultaneous Tx Combination of LTE Band II and WLAN 2.4G.

Test Position		Scaled SAR _{MAX}		Σ 1-g SAR (W/Kg)	SPLSR	Remark
		LTE Band VII	WLAN 2.4G			
Head	Left Cheek	0.173	0.302	0.475	N/A	N/A
	Left Tilt 15 Degree	0.142	0.181	0.323	N/A	N/A
	Right Cheek	0.165	0.290	0.455	N/A	N/A
	Right Tilt 15 Degree	0.130	0.158	0.288	N/A	N/A

Body-Worn	Front Side	0.256	0.119	0.375	N/A	N/A
	Back Side	0.276	0.124	0.400	N/A	N/A
Hotspot	Front Side	0.256	0.119	0.375	N/A	N/A
	Back Side	0.276	0.124	0.400	N/A	N/A
	Left Side	0.231	N/A	0.231	N/A	N/A
	Right Side	0.239	0.095	0.334	N/A	N/A
	Top Side	N/A	0.078	0.078	N/A	N/A
	Bottom Side	0.590	N/A	0.590	N/A	N/A

NOTE: 1-g SAR Simultaneous Tx Combination of LTE Band VII and WLAN 2.4G.

Test Position		Scaled SAR _{MAX}		Σ 1-g SAR (W/Kg)	SPLSR	Remark
		GSM 850	Bluetooth			
Head	Left Cheek	0.198	0.236	0.434	N/A	N/A
	Left Tilt 15 Degree	0.130	0.236	0.366	N/A	N/A
	Right Cheek	0.190	0.236	0.426	N/A	N/A
	Right Tilt 15 Degree	0.121	0.236	0.357	N/A	N/A
Body-Worn	Front Side	0.194	0.118	0.312	N/A	N/A
	Back Side	0.230	0.118	0.348	N/A	N/A
Hotspot	Front Side	0.194	0.118	0.312	N/A	N/A
	Back Side	0.230	0.118	0.348	N/A	N/A
	Left Side	0.186	N/A	0.186	N/A	N/A
	Right Side	0.190	0.118	0.308	N/A	N/A
	Top Side	N/A	0.118	0.118	N/A	N/A
	Bottom Side	0.213	N/A	0.213	N/A	N/A

NOTE: 1-g SAR Simultaneous Tx Combination of GSM850 and Bluetooth.

Test Position		Scaled SAR _{MAX}		Σ 1-g SAR (W/Kg)	SPLSR	Remark
		GSM 1900	Bluetooth			
Head	Left Cheek	0.107	0.236	0.343	N/A	N/A
	Left Tilt 15 Degree	0.080	0.236	0.316	N/A	N/A
	Right Cheek	0.103	0.236	0.339	N/A	N/A
	Right Tilt 15 Degree	0.076	0.236	0.312	N/A	N/A
Body-Worn	Front Side	0.306	0.118	0.424	N/A	N/A
	Back Side	0.323	0.118	0.441	N/A	N/A
Hotspot	Front Side	0.306	0.118	0.424	N/A	N/A
	Back Side	0.323	0.118	0.441	N/A	N/A
	Left Side	0.274	N/A	0.274	N/A	N/A
	Right Side	0.279	0.118	0.397	N/A	N/A

	Top Side	N/A	0.118	0.118	N/A	N/A
	Bottom Side	0.317	N/A	0.317	N/A	N/A

NOTE: 1-g SAR Simultaneous Tx Combination of GSM1900 and Bluetooth.

Test Position		Scaled SAR _{MAX}		Σ 1-g SAR (W/Kg)	SPLSR	Remark
		WCDMA Band V	Bluetooth			
Head	Left Cheek	0.166	0.236	0.402	N/A	N/A
	Left Tilt 15 Degree	0.130	0.236	0.366	N/A	N/A
	Right Cheek	0.158	0.236	0.394	N/A	N/A
	Right Tilt 15 Degree	0.124	0.236	0.360	N/A	N/A
Body-Worn	Front Side	0.157	0.118	0.275	N/A	N/A
	Back Side	0.187	0.118	0.305	N/A	N/A
Hotspot	Front Side	0.157	0.118	0.275	N/A	N/A
	Back Side	0.187	0.118	0.305	N/A	N/A
	Left Side	0.151	N/A	0.151	N/A	N/A
	Right Side	0.148	0.118	0.266	N/A	N/A
	Top Side	N/A	0.118	0.118	N/A	N/A
	Bottom Side	0.156	N/A	0.156	N/A	N/A

NOTE: 1-g SAR Simultaneous Tx Combination of WCDMA Band V and Bluetooth.

Test Position		Scaled SAR _{MAX}		Σ 1-g SAR (W/Kg)	SPLSR	Remark
		WCDMA Band II	Bluetooth			
Head	Left Cheek	0.184	0.236	0.420	N/A	N/A
	Left Tilt 15 Degree	0.124	0.236	0.360	N/A	N/A
	Right Cheek	0.170	0.236	0.406	N/A	N/A
	Right Tilt 15 Degree	0.115	0.236	0.351	N/A	N/A
Body-Worn	Front Side	0.502	0.118	0.620	N/A	N/A
	Back Side	0.545	0.118	0.663	N/A	N/A
Hotspot	Front Side	0.502	0.118	0.620	N/A	N/A
	Back Side	0.545	0.118	0.663	N/A	N/A
	Left Side	0.490	N/A	0.490	N/A	N/A
	Right Side	0.471	0.118	0.589	N/A	N/A
	Top Side	N/A	0.118	0.118	N/A	N/A
	Bottom Side	0.524	N/A	0.524	N/A	N/A

NOTE: 1-g SAR Simultaneous Tx Combination of WCDMA Band II and Bluetooth.

Test Position		Scaled SAR _{MAX}		Σ 1-g SAR (W/Kg)	SPLSR	Remark
		LTE Band V	Bluetooth			

Head	Left Cheek	0.200	0.236	0.436	N/A	N/A
	Left Tilt 15 Degree	0.151	0.236	0.387	N/A	N/A
	Right Cheek	0.187	0.236	0.423	N/A	N/A
	Right Tilt 15 Degree	0.135	0.236	0.371	N/A	N/A
Body-Worn	Front Side	0.174	0.118	0.292	N/A	N/A
	Back Side	0.210	0.118	0.328	N/A	N/A
Hotspot	Front Side	0.174	0.118	0.292	N/A	N/A
	Back Side	0.210	0.118	0.328	N/A	N/A
	Left Side	0.125	N/A	0.125	N/A	N/A
	Right Side	0.118	0.118	0.236	N/A	N/A
	Top Side	N/A	0.118	0.118	N/A	N/A
	Bottom Side	0.120	N/A	0.120	N/A	N/A

NOTE: 1-g SAR Simultaneous Tx Combination of LTE Band V and Bluetooth.

Test Position		Scaled SAR _{MAX}		Σ 1-g SAR (W/Kg)	SPLSR	Remark
		LTE Band IV	Bluetooth			
Head	Left Cheek	0.209	0.236	0.445	N/A	N/A
	Left Tilt 15 Degree	0.154	0.236	0.390	N/A	N/A
	Right Cheek	0.188	0.236	0.424	N/A	N/A
	Right Tilt 15 Degree	0.136	0.236	0.372	N/A	N/A
Body-Worn	Front Side	0.402	0.118	0.520	N/A	N/A
	Back Side	0.455	0.118	0.573	N/A	N/A
Hotspot	Front Side	0.402	0.118	0.520	N/A	N/A
	Back Side	0.455	0.118	0.573	N/A	N/A
	Left Side	0.397	N/A	0.397	N/A	N/A
	Right Side	0.375	0.118	0.493	N/A	N/A
	Top Side	N/A	0.118	0.118	N/A	N/A
	Bottom Side	0.284	N/A	0.284	N/A	N/A

NOTE: 1-g SAR Simultaneous Tx Combination of LTE Band IV and Bluetooth.

Test Position		Scaled SAR _{MAX}		Σ 1-g SAR (W/Kg)	SPLSR	Remark
		LTE Band II	Bluetooth			
Head	Left Cheek	0.189	0.236	0.425	N/A	N/A
	Left Tilt 15 Degree	0.136	0.236	0.372	N/A	N/A
	Right Cheek	0.175	0.236	0.411	N/A	N/A
	Right Tilt 15 Degree	0.130	0.236	0.366	N/A	N/A
Body-Worn	Front Side	0.494	0.118	0.612	N/A	N/A
	Back Side	0.511	0.118	0.629	N/A	N/A

Hotspot	Front Side	0.494	0.118	0.612	N/A	N/A
	Back Side	0.511	0.118	0.629	N/A	N/A
	Left Side	0.473	N/A	0.473	N/A	N/A
	Right Side	0.447	0.118	0.565	N/A	N/A
	Top Side	N/A	0.118	0.118	N/A	N/A
	Bottom Side	0.517	N/A	0.517	N/A	N/A

NOTE: 1-g SAR Simultaneous Tx Combination of LTE Band II and Bluetooth.

Test Position		Scaled SAR _{MAX}		Σ 1-g SAR (W/Kg)	SPLSR	Remark
		LTE Band VII	Bluetooth			
Head	Left Cheek	0.173	0.236	0.409	N/A	N/A
	Left Tilt 15 Degree	0.142	0.236	0.378	N/A	N/A
	Right Cheek	0.165	0.236	0.401	N/A	N/A
	Right Tilt 15 Degree	0.130	0.236	0.366	N/A	N/A
Body-Worn	Front Side	0.256	0.118	0.374	N/A	N/A
	Back Side	0.276	0.118	0.394	N/A	N/A
Hotspot	Front Side	0.256	0.118	0.374	N/A	N/A
	Back Side	0.276	0.118	0.394	N/A	N/A
	Left Side	0.231	N/A	0.231	N/A	N/A
	Right Side	0.239	0.118	0.357	N/A	N/A
	Top Side	N/A	0.118	0.118	N/A	N/A
	Bottom Side	0.590	N/A	0.590	N/A	N/A

NOTE: 1-g SAR Simultaneous Tx Combination of LTE Band VII and Bluetooth.

11. Appendix A. Photo documentation

Refer to appendix Test Setup photo---SAR

12. Appendix B. System Check Plots

Table of contents
MEASUREMENT 1 System Performance Check - SID835 - Head
MEASUREMENT 2 System Performance Check - SID835 - Body
MEASUREMENT 3 System Performance Check - SID1800 - Head
MEASUREMENT 4 System Performance Check - SID1800 - Body
MEASUREMENT 5 System Performance Check - SID1900 - Head
MEASUREMENT 6 System Performance Check - SID1900 - Body
MEASUREMENT 7 System Performance Check - SID2450 - Head
MEASUREMENT 8 System Performance Check - SID2450 - Body
MEASUREMENT 9 System Performance Check - SID2600 - Head
MEASUREMENT 10 System Performance Check - SID2600 - Body

MEASUREMENT 1

A. Experimental conditions.

Area Scan	<u>dx=15mm dy=15mm, h= 5.00 mm</u>
ZoomScan	<u>5x5x7,dx=8mm dy=8mm dz=5mm</u>
Phantom	<u>Validation plane</u>
Device Position	<u>Dipole</u>
Band	<u>CW835</u>
Channels	<u>Middle</u>
Signal	<u>CW (Crest factor: 1.0)</u>

B. SAR Measurement Results

Frequency (MHz)	835.000000
Relative permittivity (real part)	41.623406
Relative permittivity (imaginary part)	19.493425
Conductivity (S/m)	0.902574
Variation (%)	-0.010000

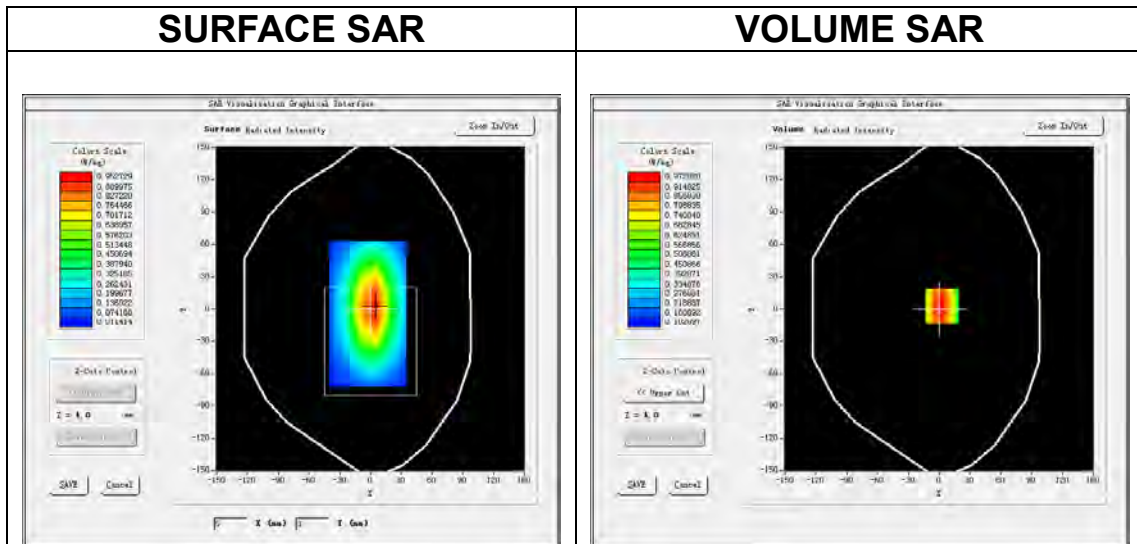

Maximum location: X=3.00, Y=3.00

SAR Peak: 1.31 W/kg

SAR 10g (W/Kg)	0.611228
SAR 1g (W/Kg)	0.956014

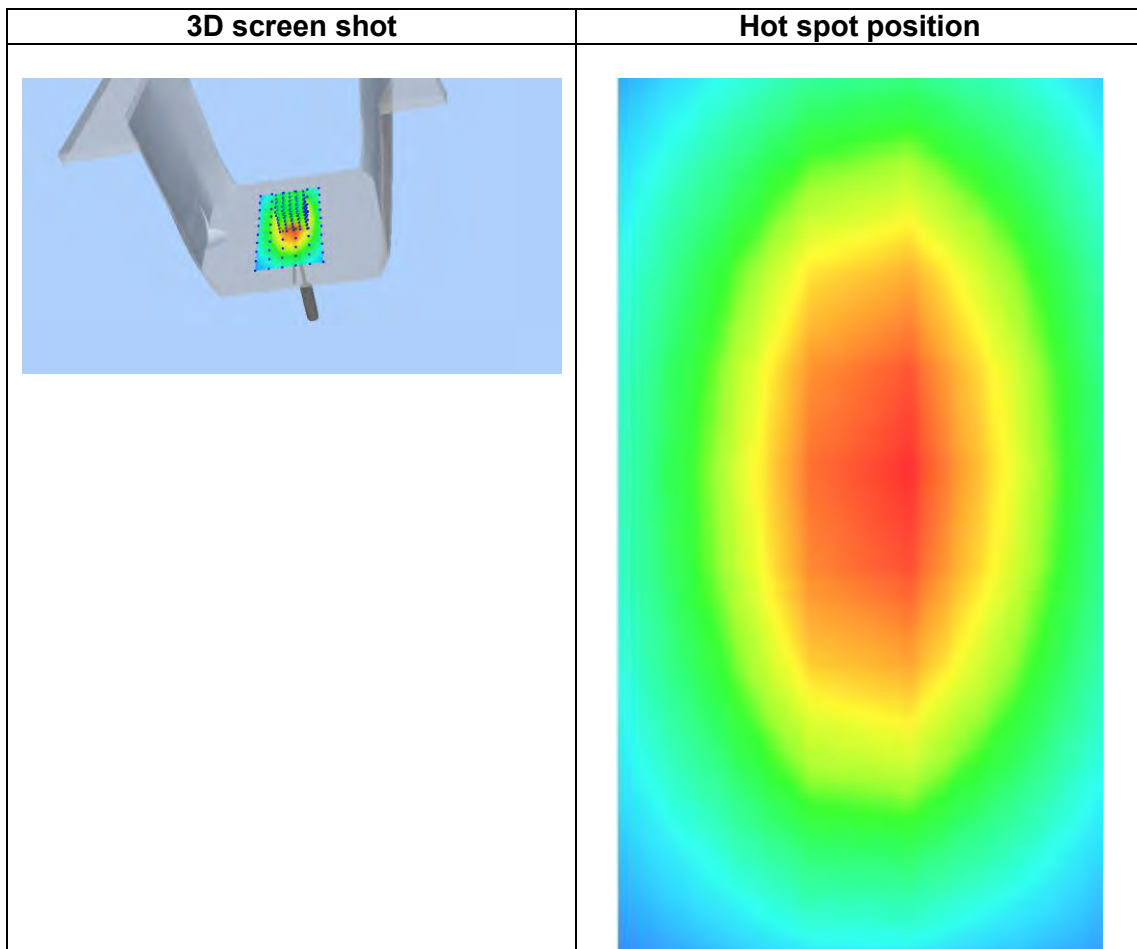
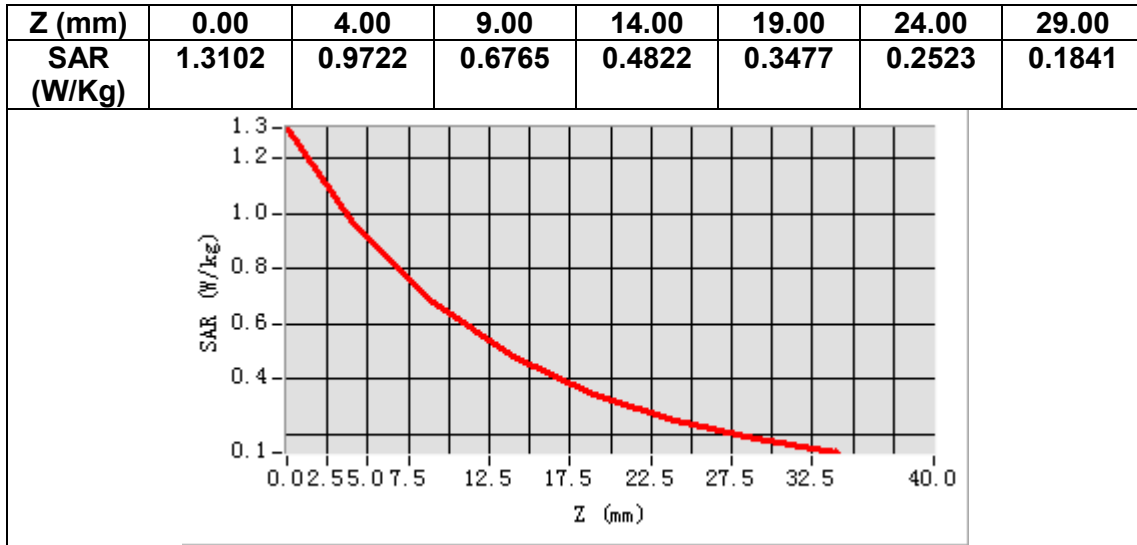

MEASUREMENT 2

A. Experimental conditions.

Area Scan	<u>dx=15mm dy=15mm, h= 5.00 mm</u>
ZoomScan	<u>5x5x7,dx=8mm dy=8mm dz=5mm</u>
Phantom	<u>Validation plane</u>
Device Position	<u>Dipole</u>
Band	<u>CW835</u>
Channels	<u>Middle</u>
Signal	<u>CW (Crest factor: 1.0)</u>

B. SAR Measurement Results

Frequency (MHz)	835.000000
Relative permittivity (real part)	54.890021
Relative permittivity (imaginary part)	21.510010
Conductivity (S/m)	1.001144
Variation (%)	3.820000

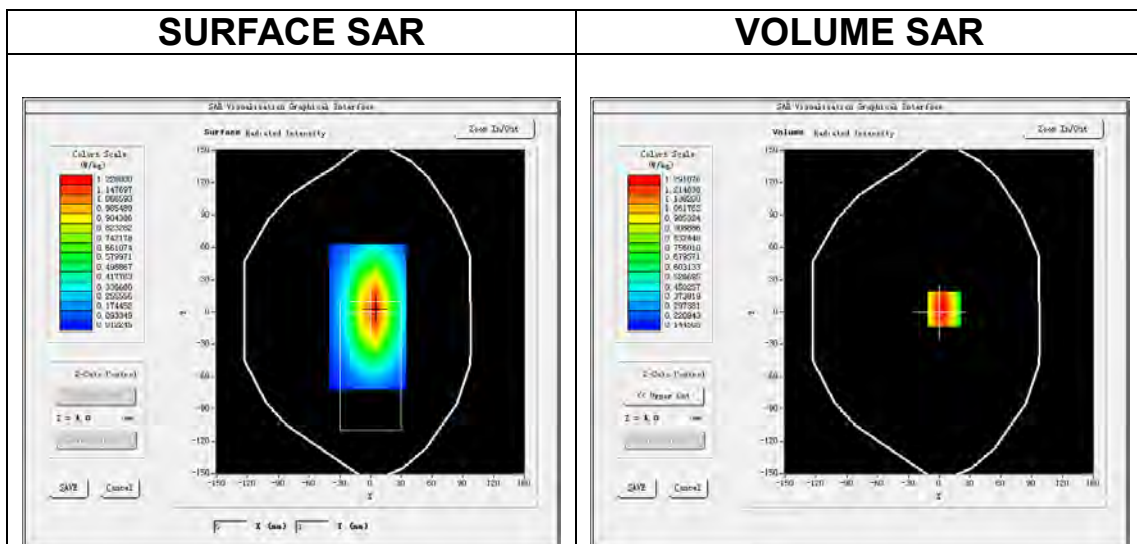

Maximum location: X=5.00, Y=3.00

SAR Peak: 1.73 W/kg

SAR 10g (W/Kg)	0.599365
SAR 1g (W/Kg)	1.021284

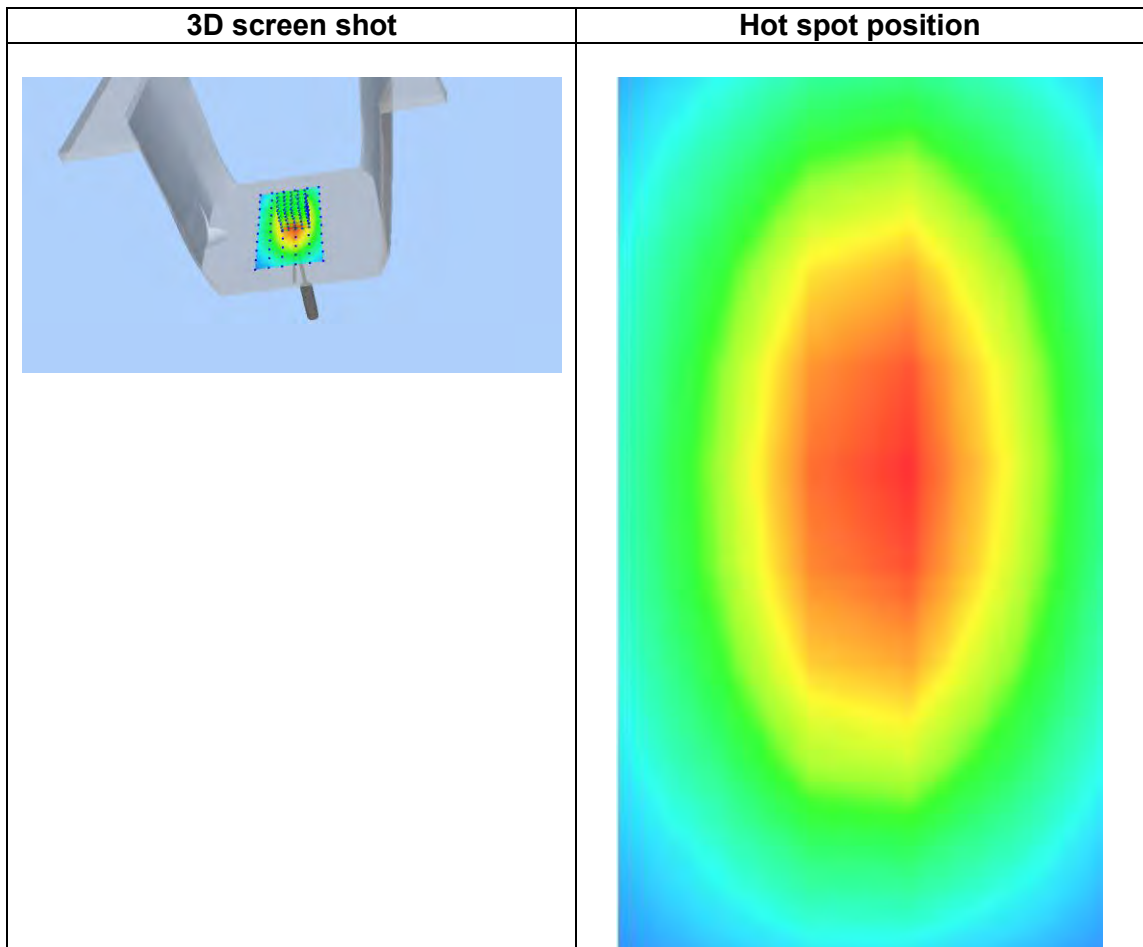
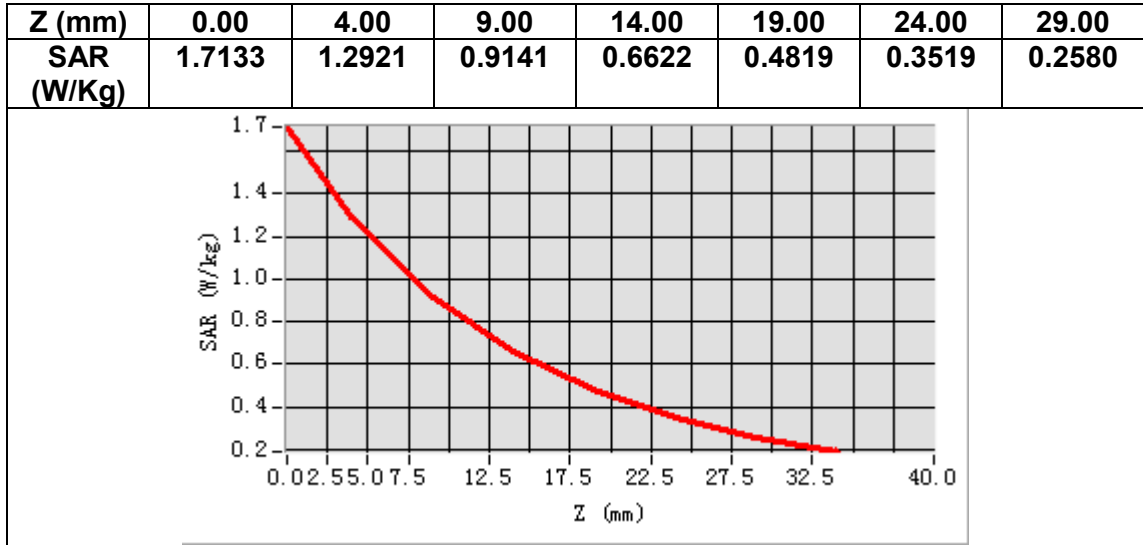

MEASUREMENT 3

A. Experimental conditions.

Area Scan	<u>dx=15mm dy=15mm, h= 5.00 mm</u>
ZoomScan	<u>5x5x7,dx=8mm dy=8mm dz=5mm</u>
Phantom	<u>Validation plane</u>
Device Position	<u>Dipole</u>
Band	<u>CW1800</u>
Channels	<u>Middle</u>
Signal	<u>CW (Crest factor: 1.0)</u>

B. SAR Measurement Results

Frequency (MHz)	1800.000000
Relative permittivity (real part)	39.492657
Relative permittivity (imaginary part)	13.953442
Conductivity (S/m)	1.401324
Variation (%)	-0.190000

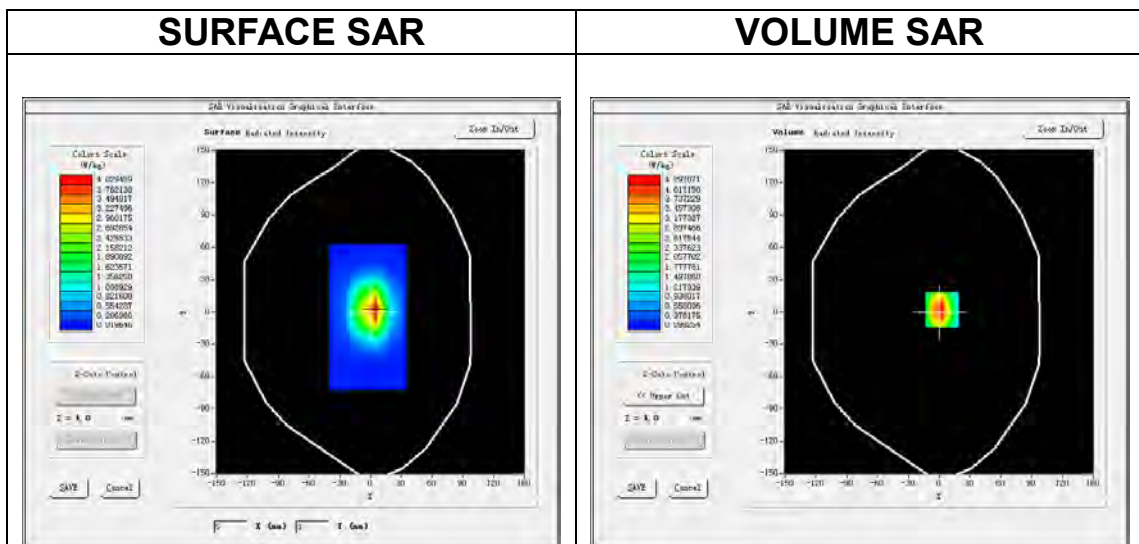

Maximum location: X=3.00, Y=2.00

SAR Peak: 6.78 W/kg

SAR 10g (W/Kg)	2.121427
SAR 1g (W/Kg)	4.084294

Z (mm)	0.00	4.00	9.00	14.00	19.00	24.00	29.00
SAR (W/Kg)	6.7025	4.2970	2.4245	1.4148	0.8487	0.5185	0.3227

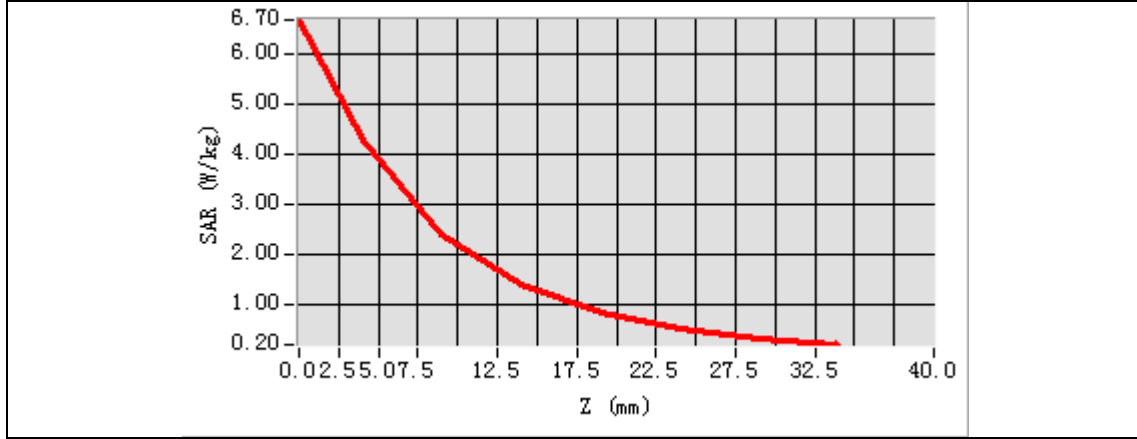

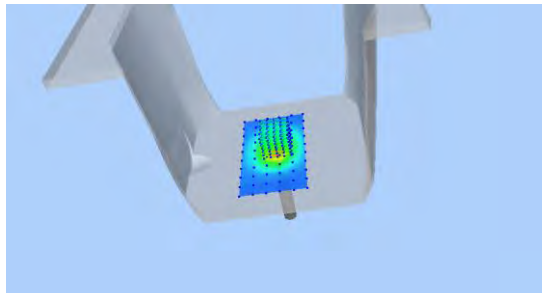
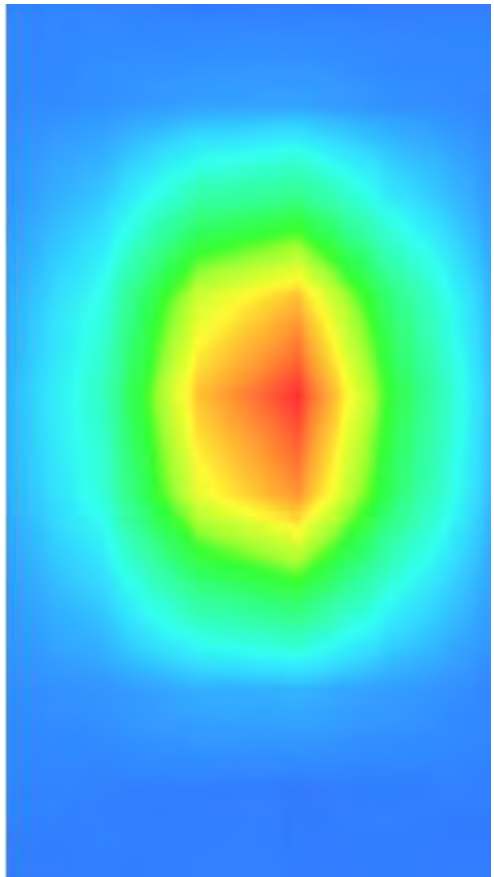
3D screen shot	Hot spot position
	

MEASUREMENT 4

A. Experimental conditions.

Area Scan	<u>dx=15mm dy=15mm, h= 5.00 mm</u>
ZoomScan	<u>5x5x7,dx=8mm dy=8mm dz=5mm</u>
Phantom	<u>Validation plane</u>
Device Position	<u>Dipole</u>
Band	<u>CW1800</u>
Channels	<u>Middle</u>
Signal	<u>CW (Crest factor: 1.0)</u>

B. SAR Measurement Results

Frequency (MHz)	1800.000000
Relative permittivity (real part)	53.801621
Relative permittivity (imaginary part)	15.243432
Conductivity (S/m)	1.521324
Variation (%)	-0.510000

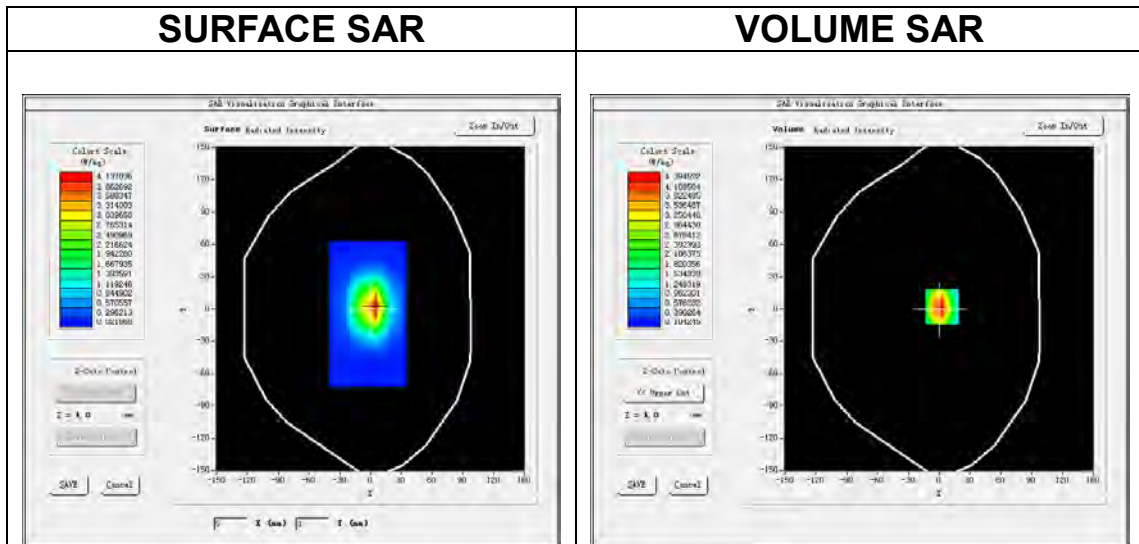

Maximum location: X=3.00, Y=2.00

SAR Peak: 6.91 W/kg

SAR 10g (W/Kg)	2.100162
SAR 1g (W/Kg)	4.011214

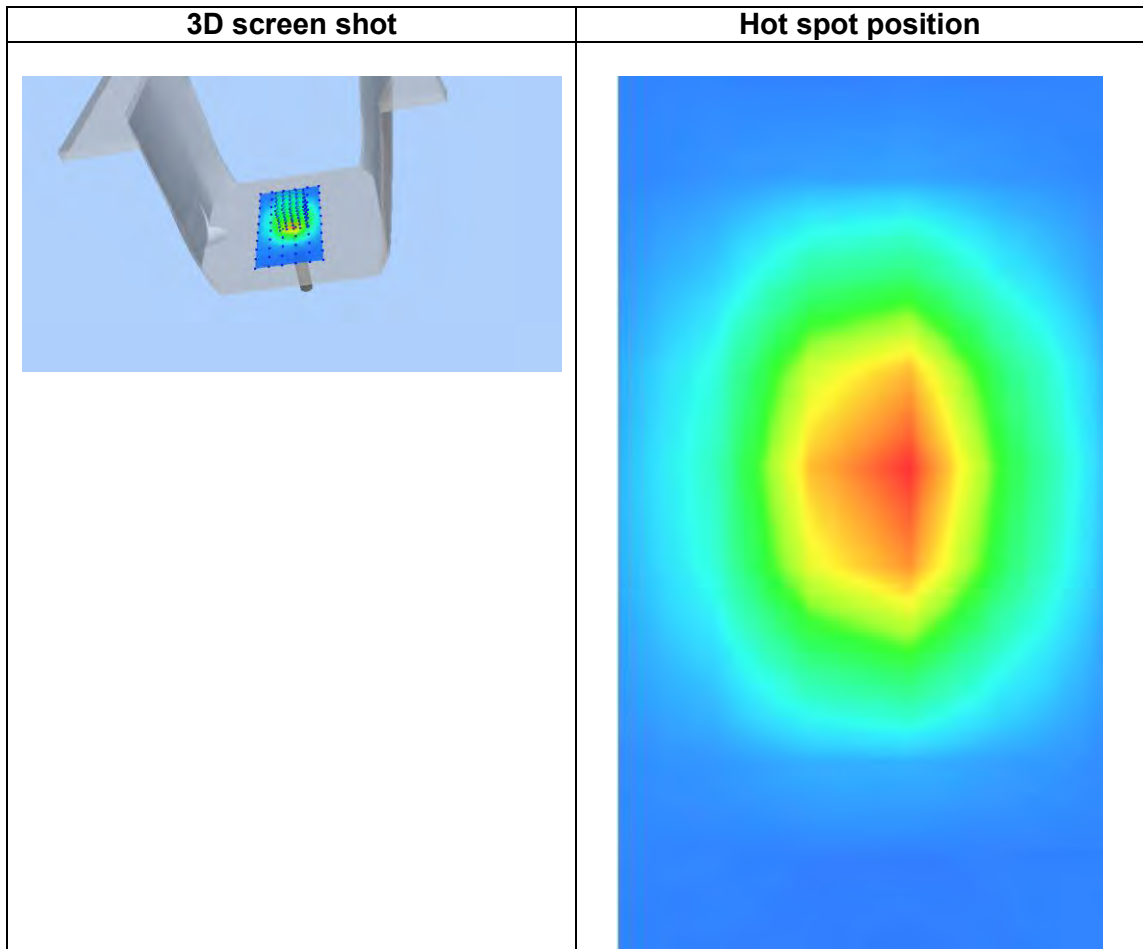
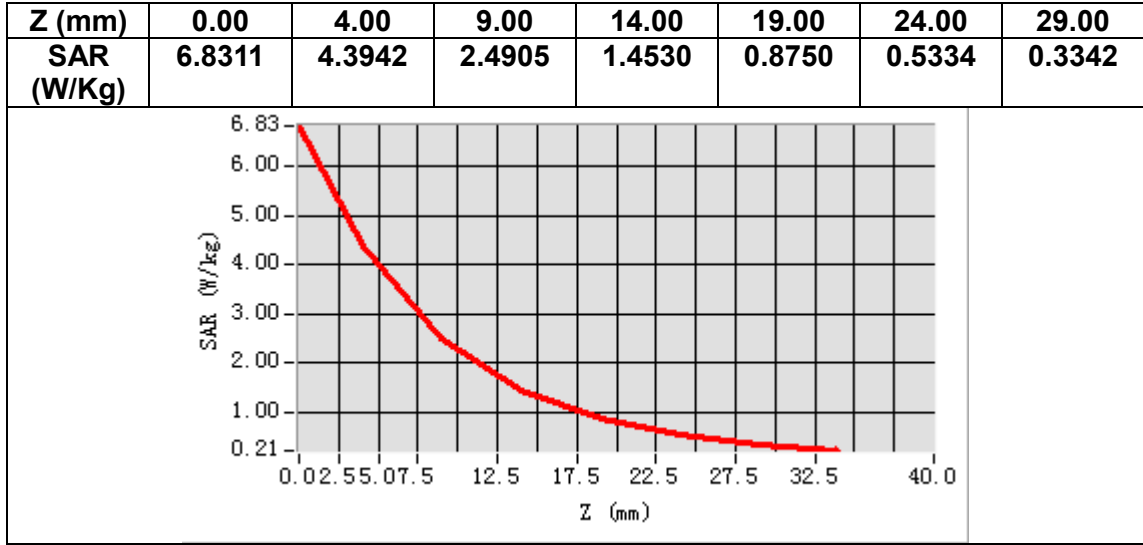

MEASUREMENT 5

A. Experimental conditions.

Area Scan	<u>dx=15mm dy=15mm, h= 5.00 mm</u>
ZoomScan	<u>5x5x7,dx=8mm dy=8mm dz=5mm</u>
Phantom	<u>Validation plane</u>
Device Position	<u>Dipole</u>
Band	<u>CW1900</u>
Channels	<u>Middle</u>
Signal	<u>CW (Crest factor: 1.0)</u>

B. SAR Measurement Results

Frequency (MHz)	1900.000000
Relative permittivity (real part)	40.012892
Relative permittivity (imaginary part)	13.340302
Conductivity (S/m)	1.412587
Variation (%)	-0.460000

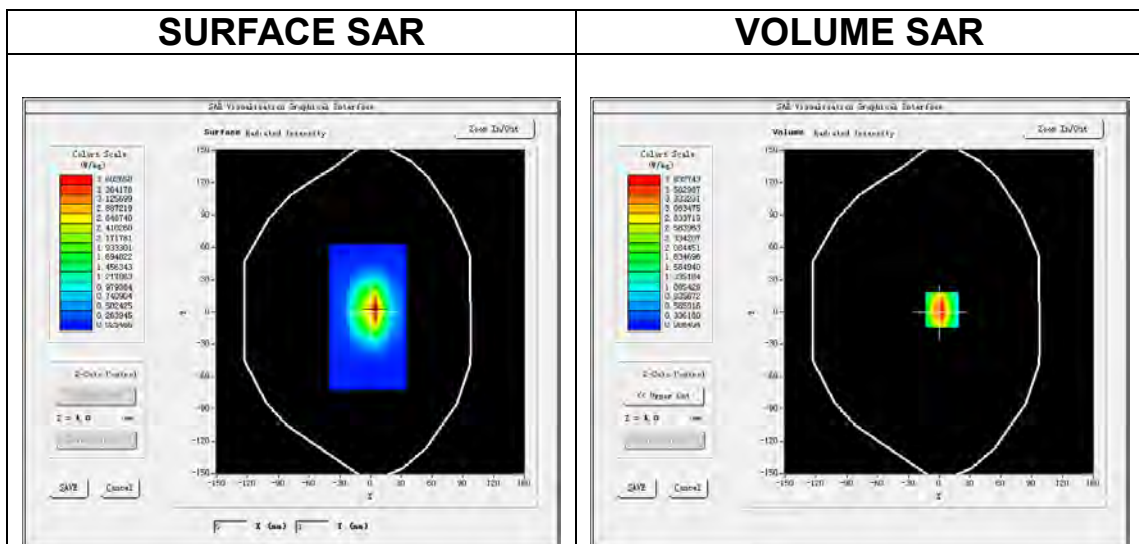

Maximum location: X=3.00, Y=2.00

SAR Peak: 6.03 W/kg

SAR 10g (W/Kg)	1.914262
SAR 1g (W/Kg)	3.705202

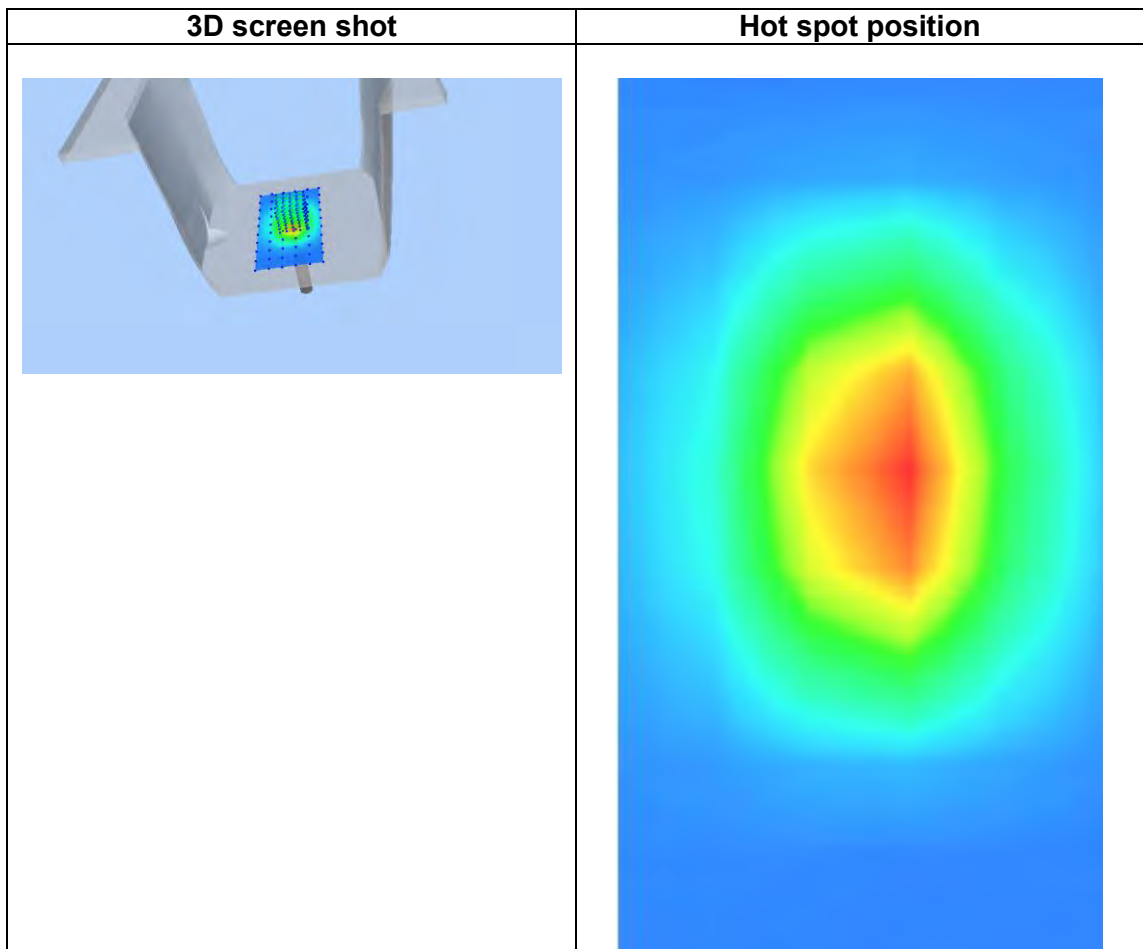
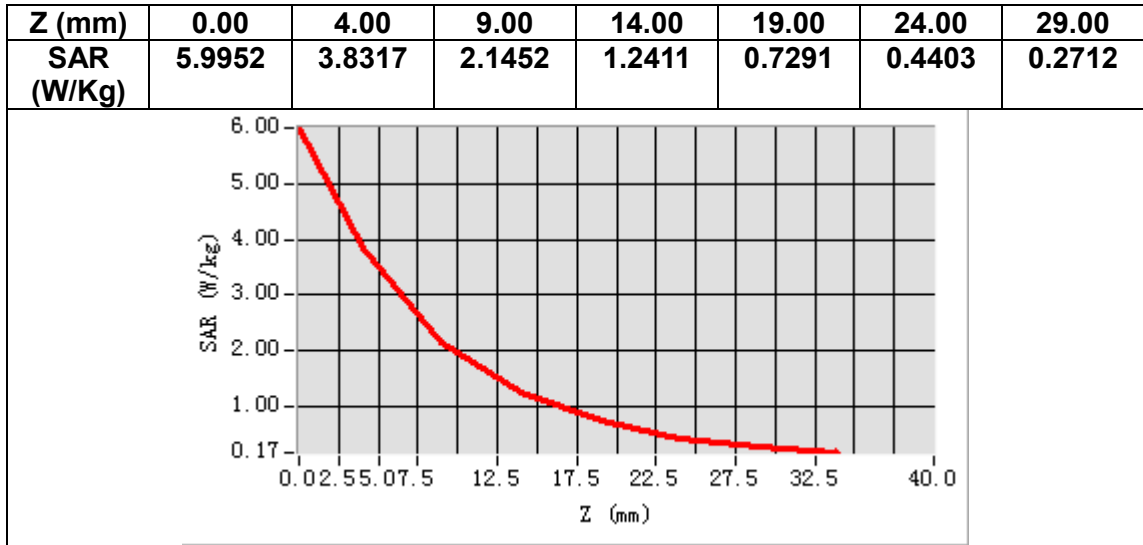

MEASUREMENT 6

A. Experimental conditions.

Area Scan	<u>dx=15mm dy=15mm, h= 5.00 mm</u>
ZoomScan	<u>5x5x7,dx=8mm dy=8mm dz=5mm</u>
Phantom	<u>Validation plane</u>
Device Position	<u>Dipole</u>
Band	<u>CW1900</u>
Channels	<u>Middle</u>
Signal	<u>CW (Crest factor: 1.0)</u>

B. SAR Measurement Results

Frequency (MHz)	1900.000000
Relative permittivity (real part)	53.182829
Relative permittivity (imaginary part)	14.590301
Conductivity (S/m)	1.540587
Variation (%)	-0.150000

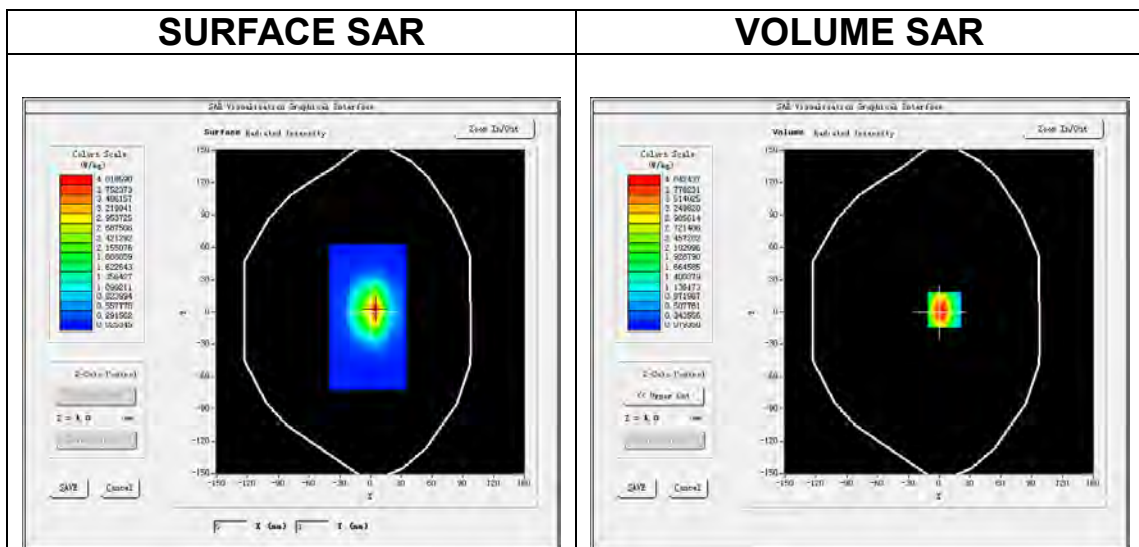

Maximum location: X=5.00, Y=2.00

SAR Peak: 6.70 W/kg

SAR 10g (W/Kg)	2.045028
SAR 1g (W/Kg)	4.060162

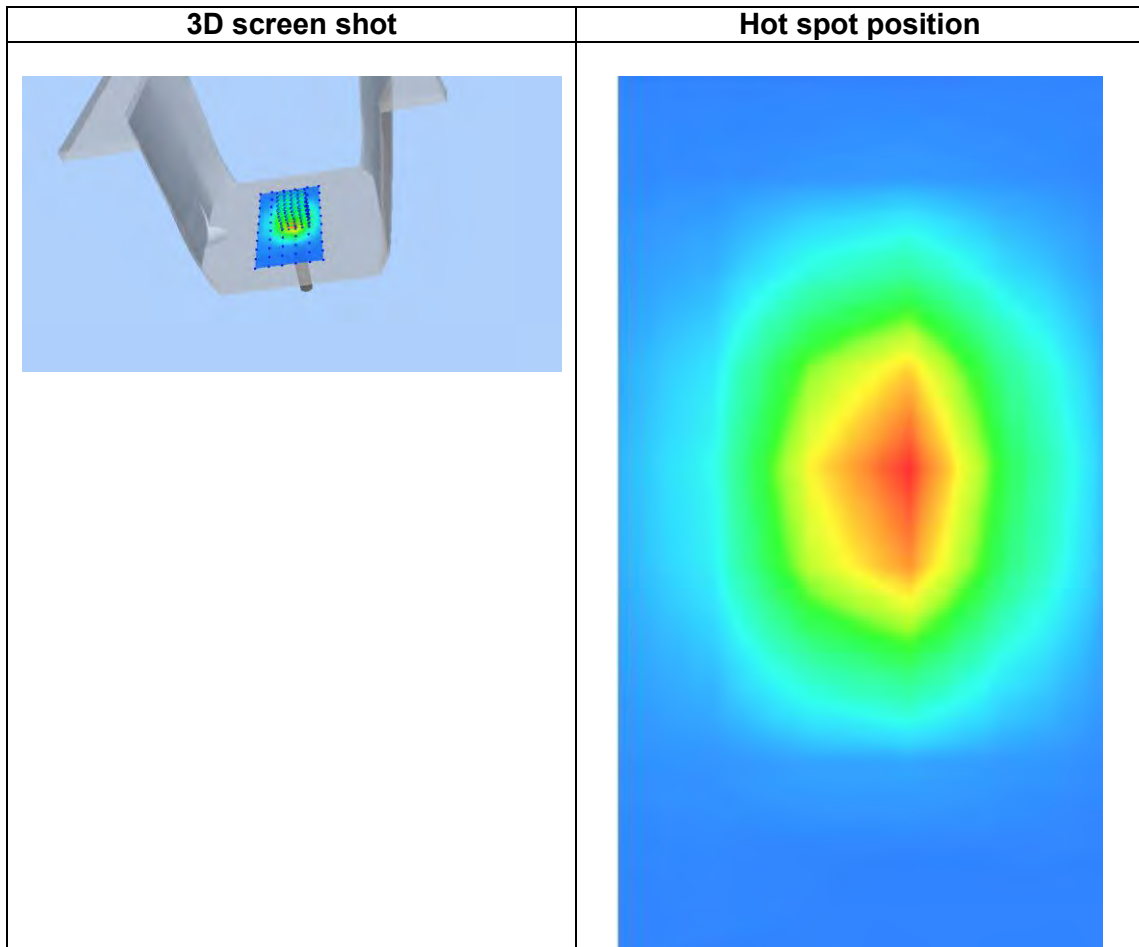
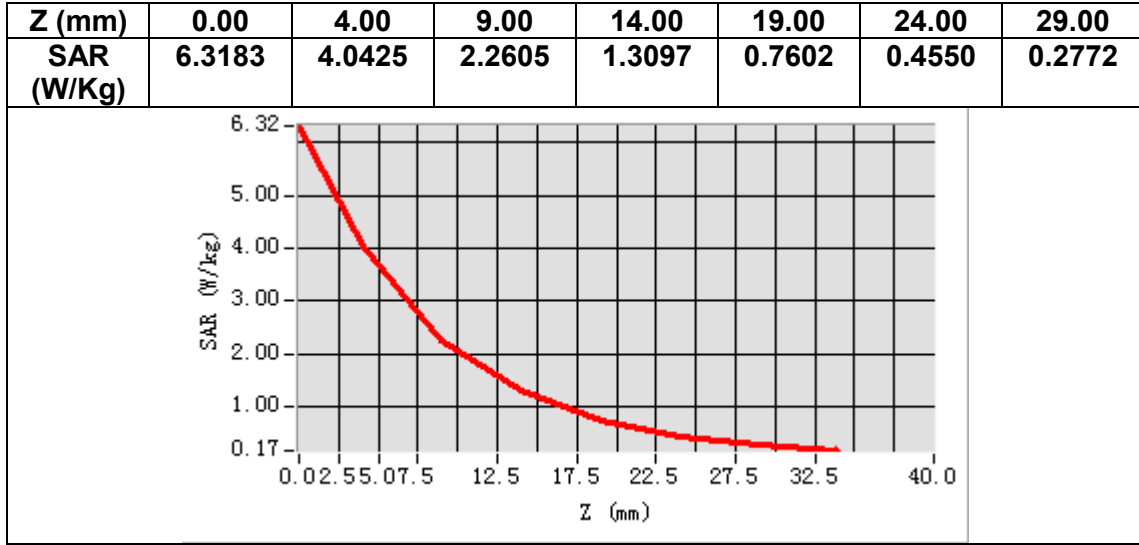

MEASUREMENT 7

A. Experimental conditions.

Area Scan	<u>dx=12mm dy=12mm, h= 5.00 mm</u>
ZoomScan	<u>7x7x7,dx=5mm dy=5mm dz=5mm</u>
Phantom	<u>Validation plane</u>
Device Position	<u>Dipole</u>
Band	<u>CW2450</u>
Channels	<u>Middle</u>
Signal	<u>CW (Crest factor: 1.0)</u>

B. SAR Measurement Results

Frequency (MHz)	2450.000000
Relative permittivity (real part)	39.994057
Relative permittivity (imaginary part)	13.130233
Conductivity (S/m)	1.792738
Variation (%)	-0.220000

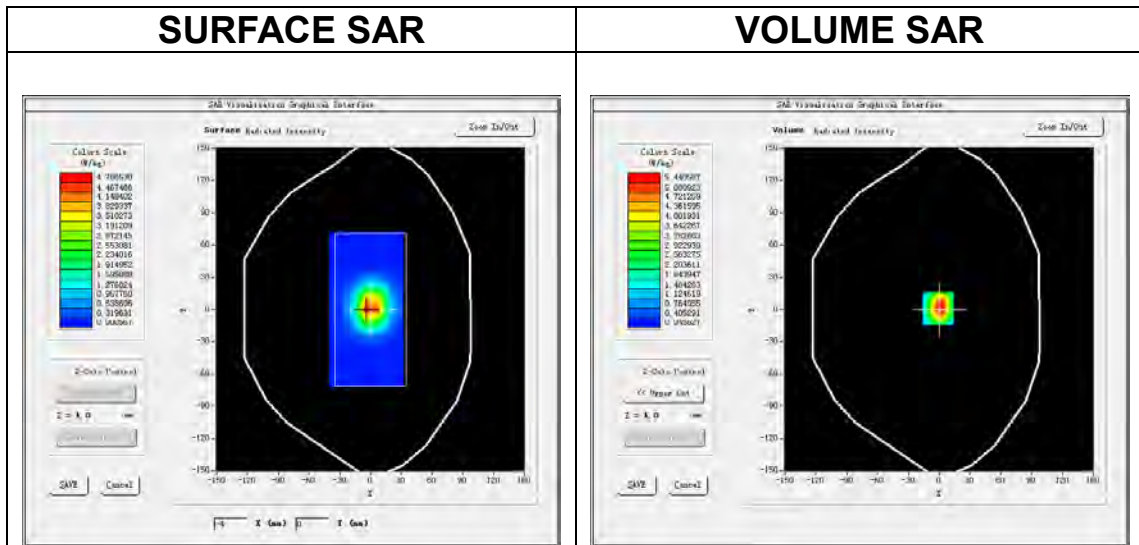

Maximum location: X=-1.00, Y=1.00

SAR Peak: 8.94 W/kg

SAR 10g (W/Kg)	2.478381
SAR 1g (W/Kg)	5.156682

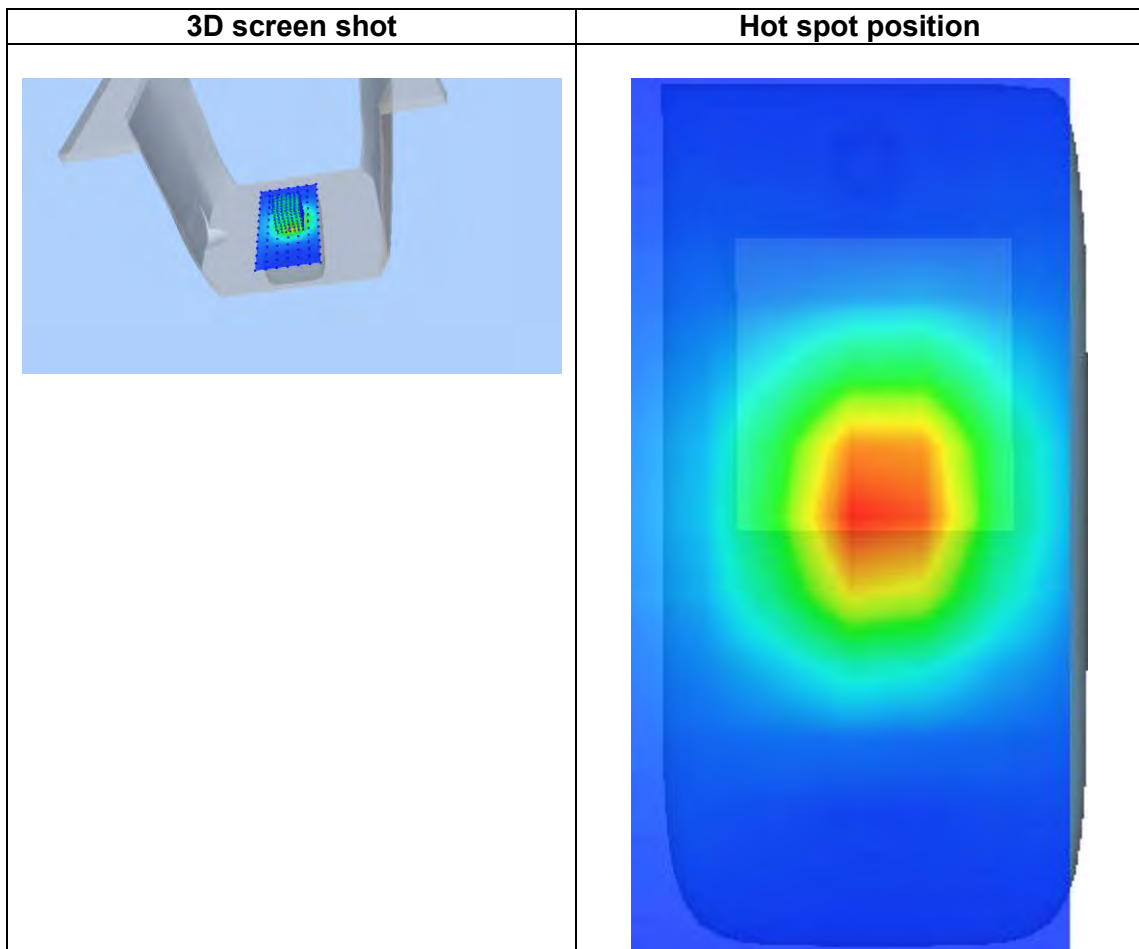
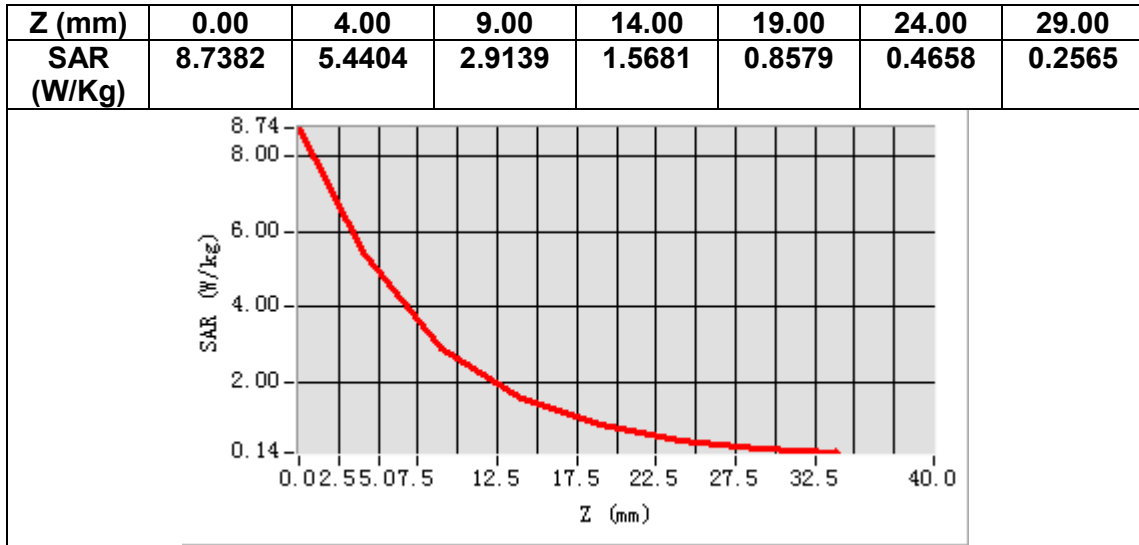

MEASUREMENT 8

A. Experimental conditions.

Area Scan	<u>dx=12mm dy=12mm, h= 5.00 mm</u>
ZoomScan	<u>7x7x7,dx=5mm dy=5mm dz=5mm</u>
Phantom	<u>Validation plane</u>
Device Position	<u>Dipole</u>
Band	<u>CW2450</u>
Channels	<u>Middle</u>
Signal	<u>CW (Crest factor: 1.0)</u>

B. SAR Measurement Results

Frequency (MHz)	2450.000000
Relative permittivity (real part)	52.704027
Relative permittivity (imaginary part)	14.490233
Conductivity (S/m)	1.972738
Variation (%)	-0.200000

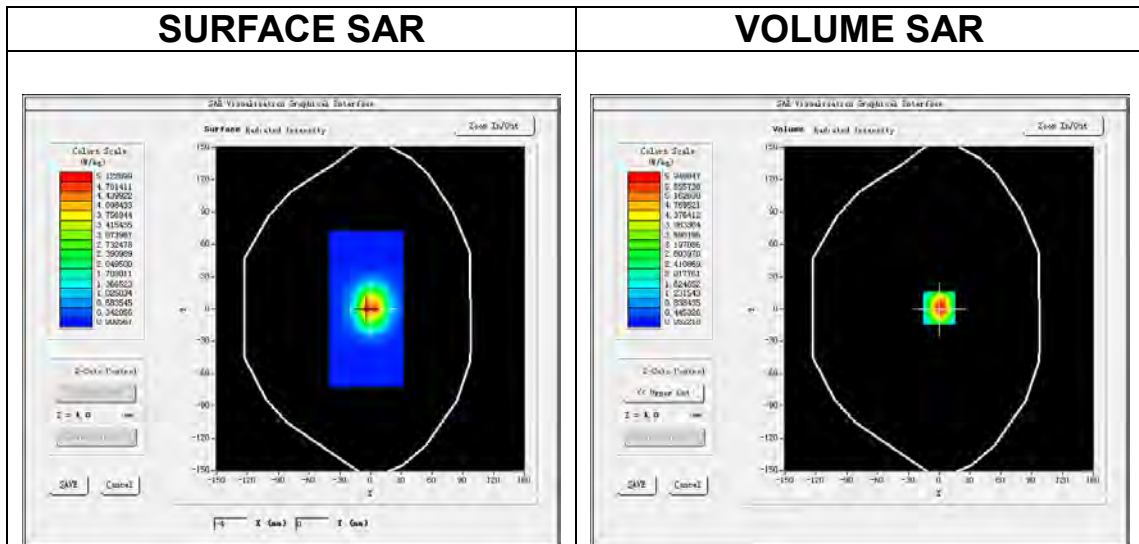

Maximum location: X=0.00, Y=1.00

SAR Peak: 9.64 W/kg

SAR 10g (W/Kg)	2.416498
SAR 1g (W/Kg)	5.027090

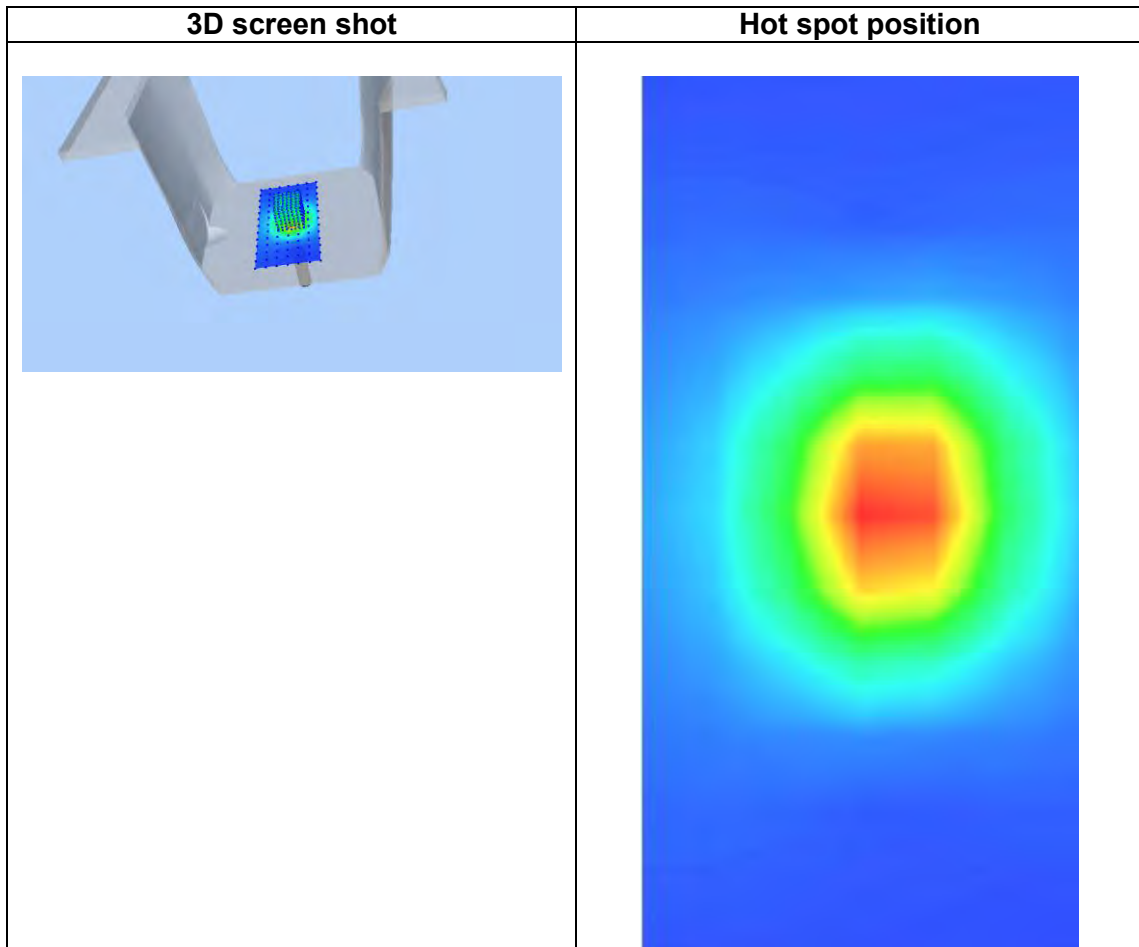
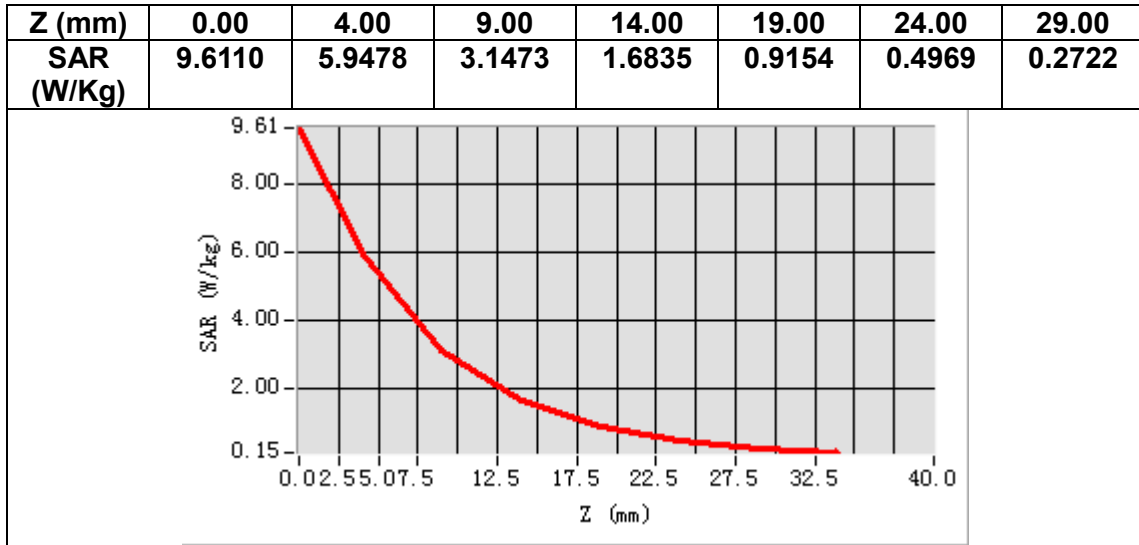

MEASUREMENT 9

A. Experimental conditions.

Area Scan	<u>dx=12mm dy=12mm, h= 5.00 mm</u>
ZoomScan	<u>7x7x7,dx=5mm dy=5mm dz=5mm</u>
Phantom	<u>Validation plane</u>
Device Position	<u>Dipole</u>
Band	<u>CW2600</u>
Channels	<u>Middle</u>
Signal	<u>CW (Crest factor: 1.0)</u>

B. SAR Measurement Results

Frequency (MHz)	2600.000000
Relative permittivity (real part)	39.024017
Relative permittivity (imaginary part)	13.590833
Conductivity (S/m)	1.962738
Variation (%)	0.700000

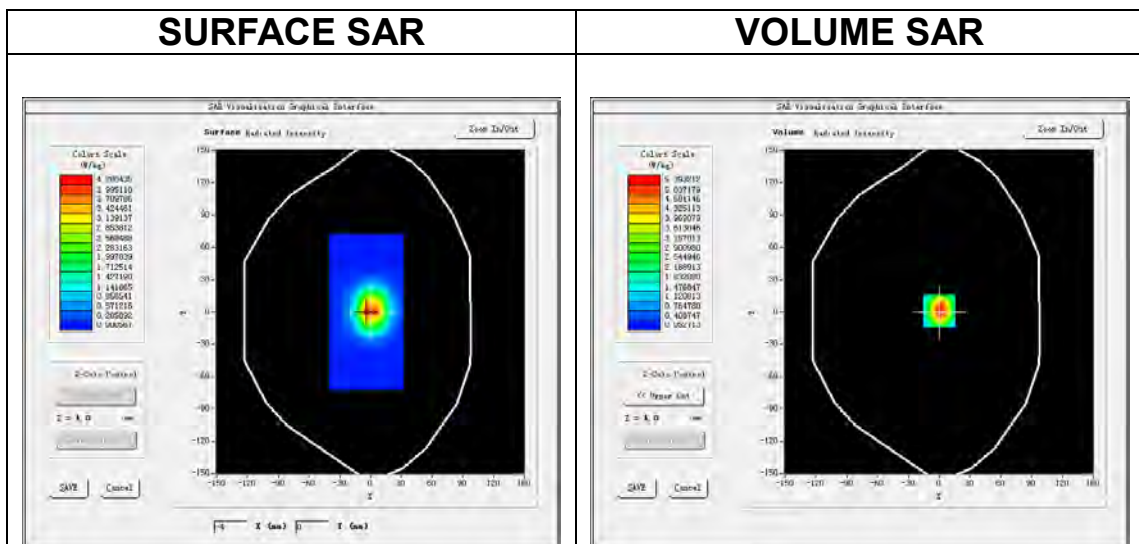

Maximum location: X=0.00, Y=1.00

SAR Peak: 8.52 W/kg

SAR 10g (W/Kg)	2.573473
SAR 1g (W/Kg)	5.013435

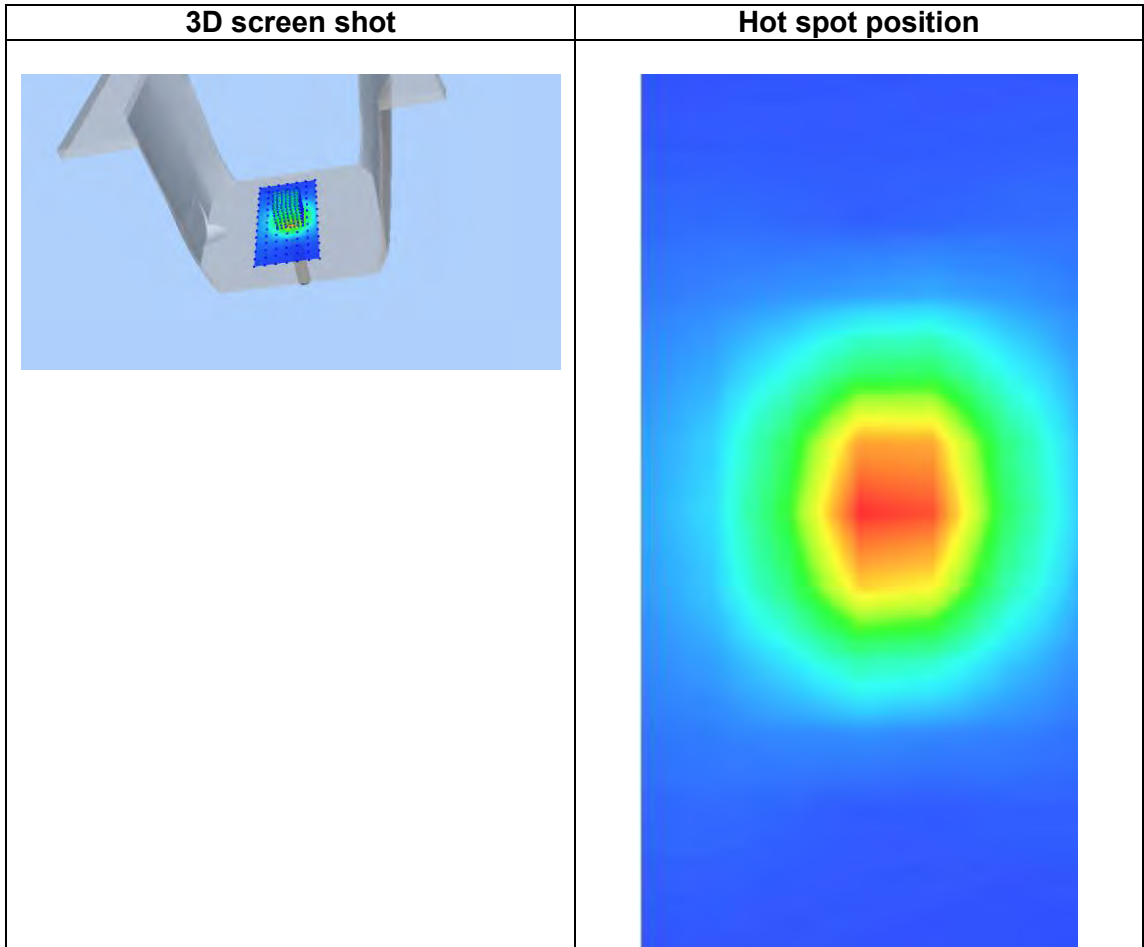
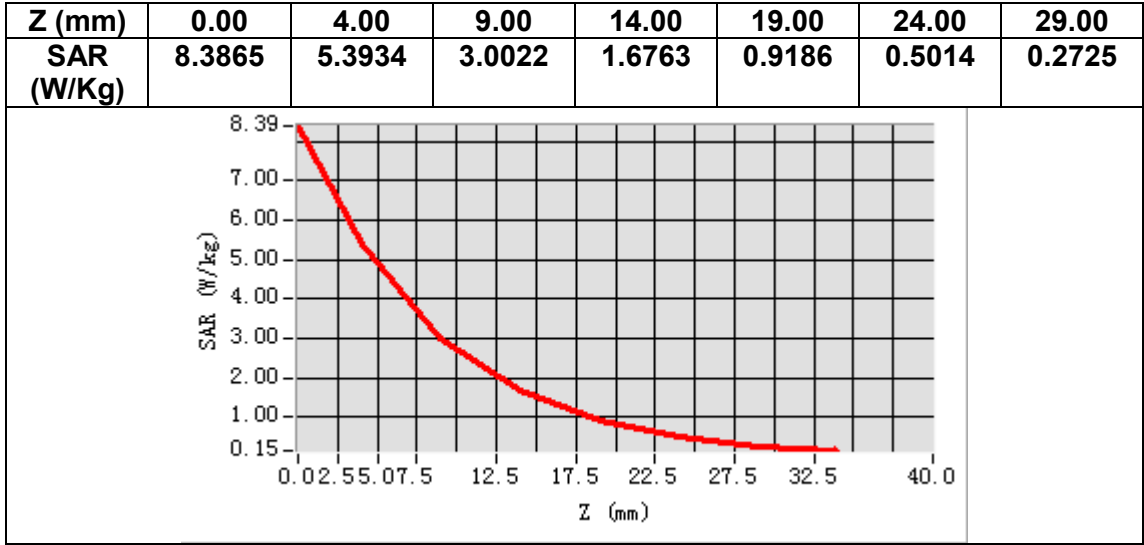

MEASUREMENT 10

A. Experimental conditions.

Area Scan	<u>dx=12mm dy=12mm, h= 5.00 mm</u>
ZoomScan	<u>7x7x7,dx=5mm dy=5mm dz=5mm</u>
Phantom	<u>Validation plane</u>
Device Position	<u>Dipole</u>
Band	<u>CW2600</u>
Channels	<u>Middle</u>
Signal	<u>CW (Crest factor: 1.0)</u>

B. SAR Measurement Results

Frequency (MHz)	2600.000000
Relative permittivity (real part)	53.084067
Relative permittivity (imaginary part)	14.970233
Conductivity (S/m)	2.163730
Variation (%)	0.270000

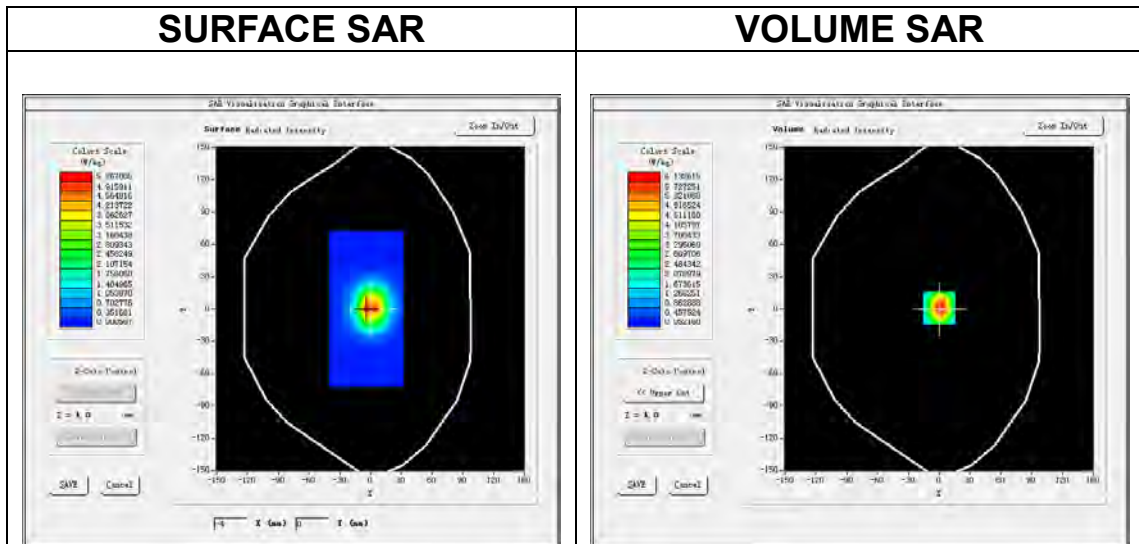

Maximum location: X=0.00, Y=1.00

SAR Peak: 9.97 W/kg

SAR 10g (W/Kg)	2.412422
SAR 1g (W/Kg)	5.541430

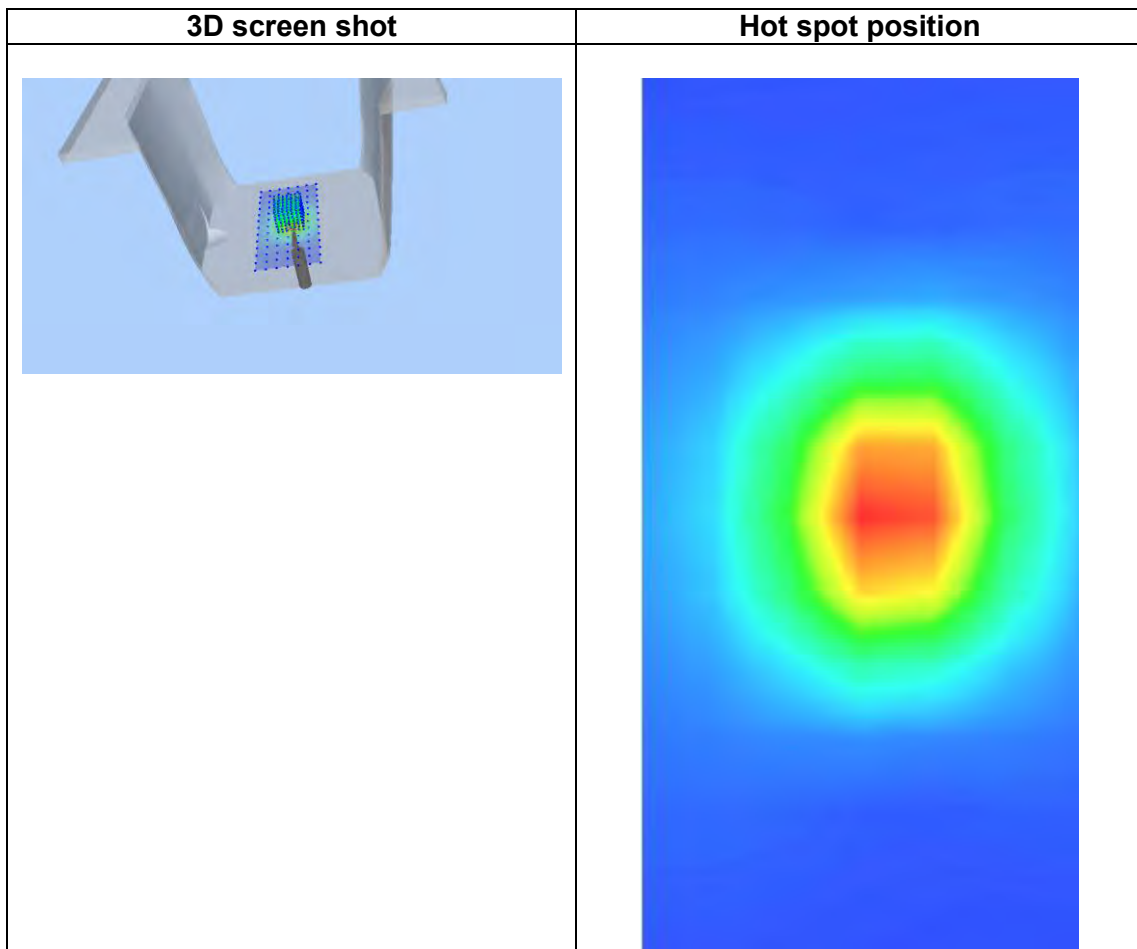
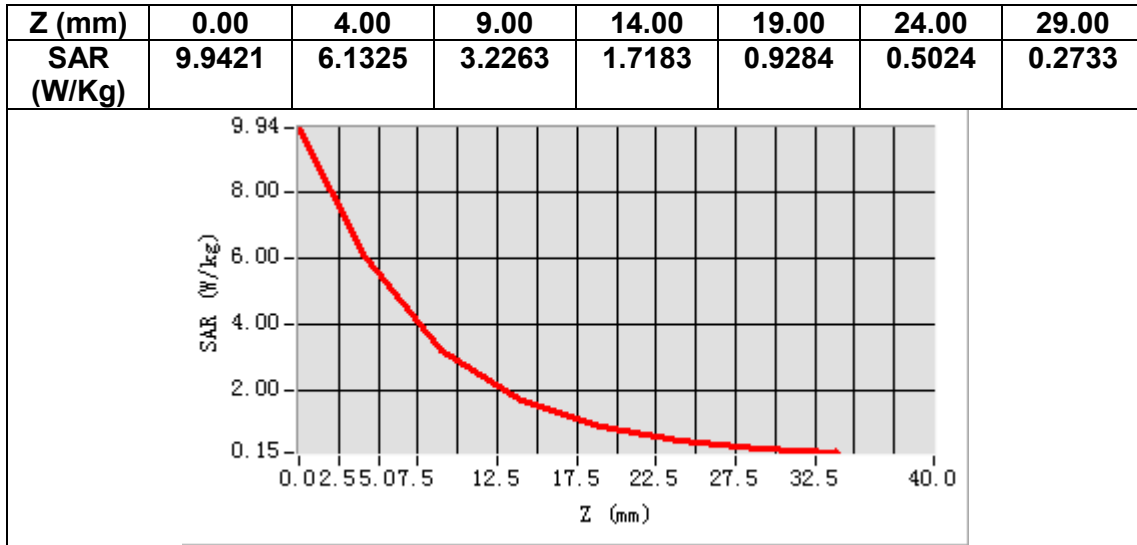

13. Appendix C. Plots of High SAR Measurement

Table of contents
MEASUREMENT 1 GSM 850 Head
MEASUREMENT 2 GSM 850 Body
MEASUREMENT 3 GSM 1900 Head
MEASUREMENT 4 GSM 1900 Body
MEASUREMENT 5 WCDMA Band II Head
MEASUREMENT 6 WCDMA Band II Body
MEASUREMENT 7 WCDMA Band V Head
MEASUREMENT 8 WCDMA Band V Body
MEASUREMENT 9 WLAN 2.4G Head
MEASUREMENT 10 WLAN 2.4G Body
MEASUREMENT 11 LTE Band II Head
MEASUREMENT 12 LTE Band II Body
MEASUREMENT 13 LTE Band IV Head
MEASUREMENT 14 LTE Band IV Body
MEASUREMENT 15 LTE Band V Head
MEASUREMENT 16 LTE Band V Body
MEASUREMENT 17 LTE Band VII Head
MEASUREMENT 18 LTE Band VII Body

MEASUREMENT 1

A. Experimental conditions.

Area Scan	<u>dx=15mm dy=15mm, h= 5.00 mm</u>
ZoomScan	<u>5x5x7,dx=8mm dy=8mm dz=5mm</u>
Phantom	<u>Left head</u>
Device Position	<u>Cheek</u>
Band	<u>GSM850</u>
Channels	<u>Middle</u>
Signal	<u>TDMA (Crest factor: 2.0)</u>

B. SAR Measurement Results

Frequency (MHz)	836.400000
Relative permittivity (real part)	41.530960
Relative permittivity (imaginary part)	19.511539
Conductivity (S/m)	0.906636
Variation (%)	1.900000

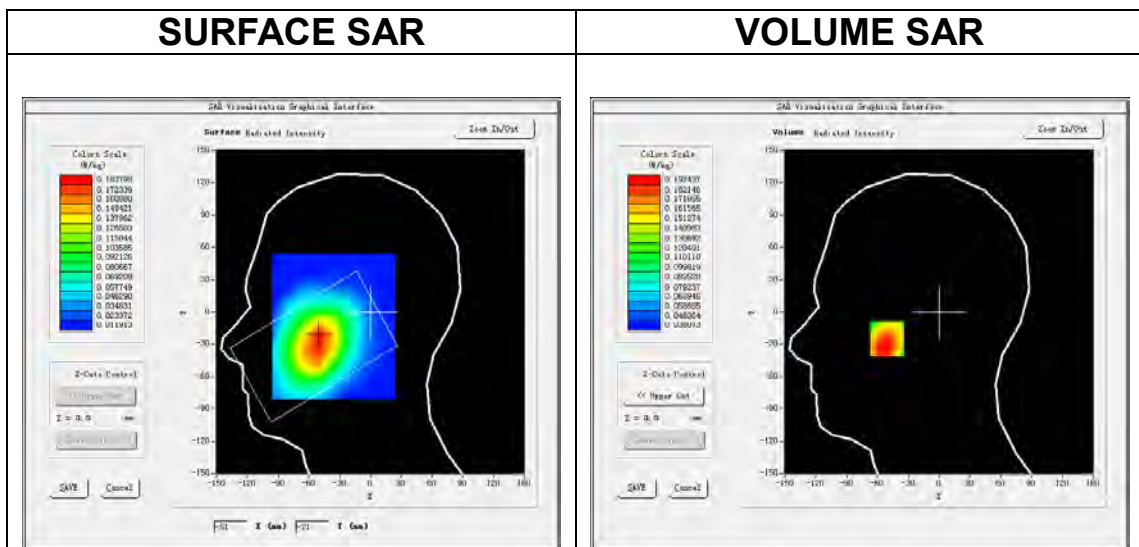

Maximum location: X=-51.00, Y=-25.00

SAR Peak: 0.24 W/kg

SAR 10g (W/Kg)	0.144381
SAR 1g (W/Kg)	0.190027

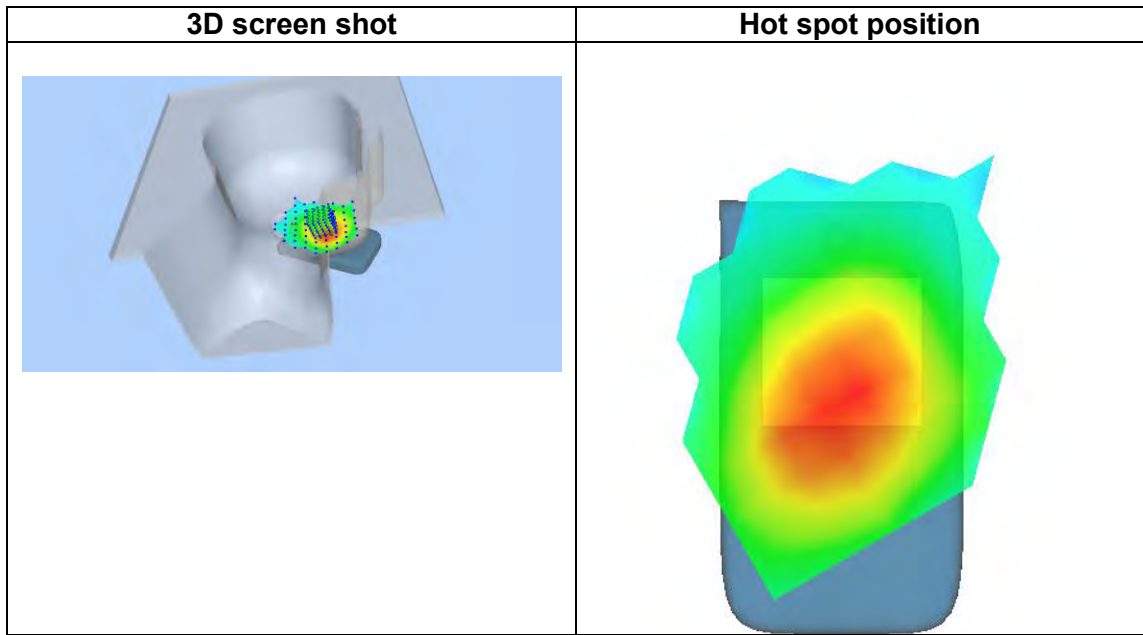
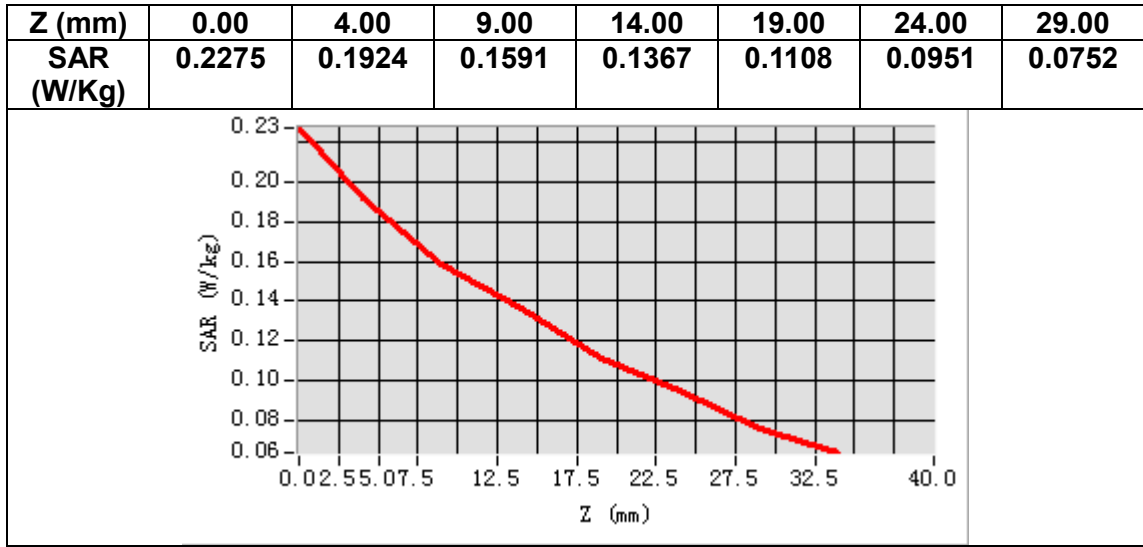

MEASUREMENT 2

A. Experimental conditions.

Area Scan	<u>dx=15mm dy=15mm, h= 5.00 mm</u>
ZoomScan	<u>5x5x7,dx=8mm dy=8mm dz=5mm</u>
Phantom	<u>Validation plane</u>
Device Position	<u>Body</u>
Band	<u>GSM850</u>
Channels	<u>Middle</u>
Signal	<u>TDMA (Crest factor: 2.0)</u>

B. SAR Measurement Results

Frequency (MHz)	836.400000
Relative permittivity (real part)	54.899578
Relative permittivity (imaginary part)	21.492741
Conductivity (S/m)	0.998696
Variation (%)	-2.340000

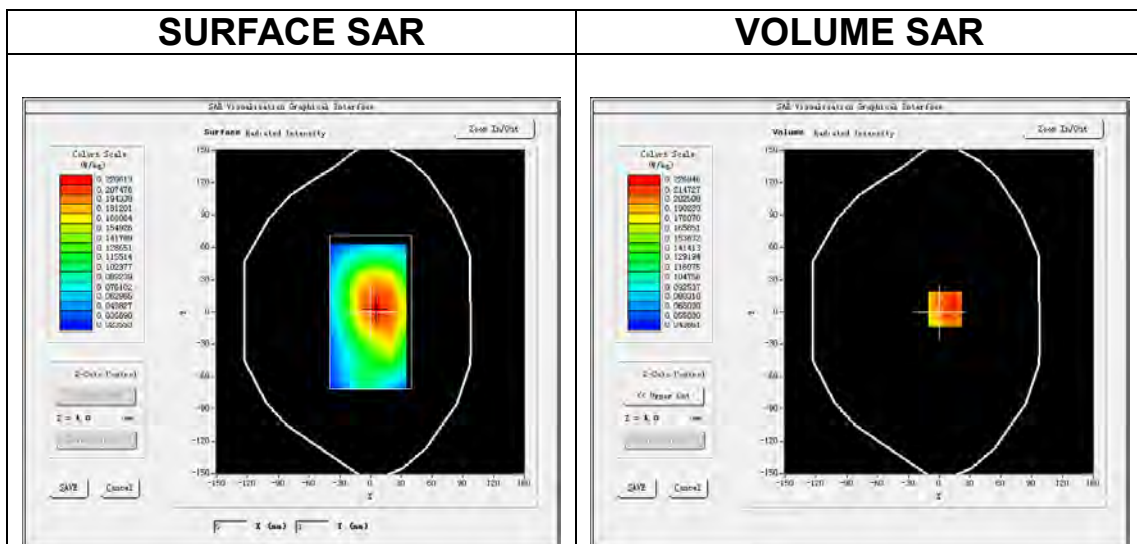

Maximum location: X=6.00, Y=3.00

SAR Peak: 0.29 W/kg

SAR 10g (W/Kg)	0.168444
SAR 1g (W/Kg)	0.221027

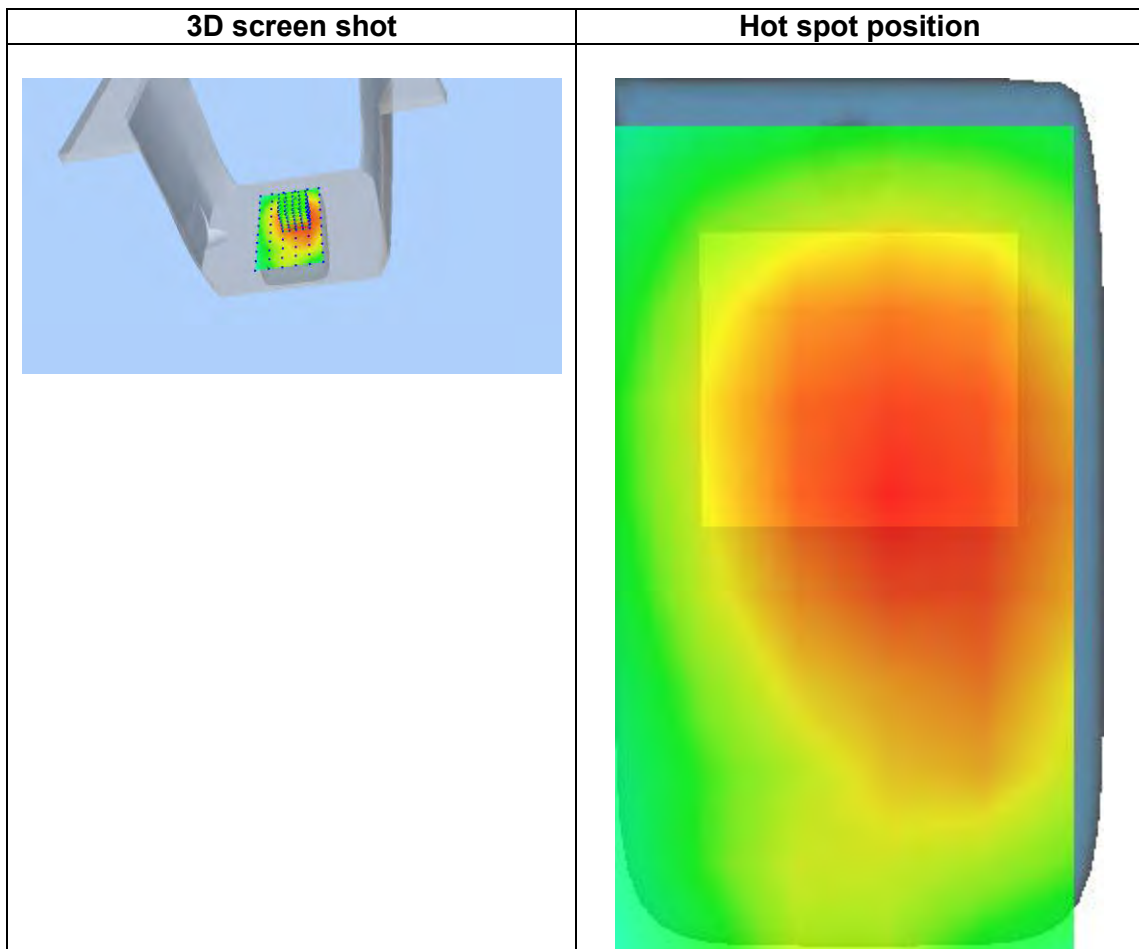
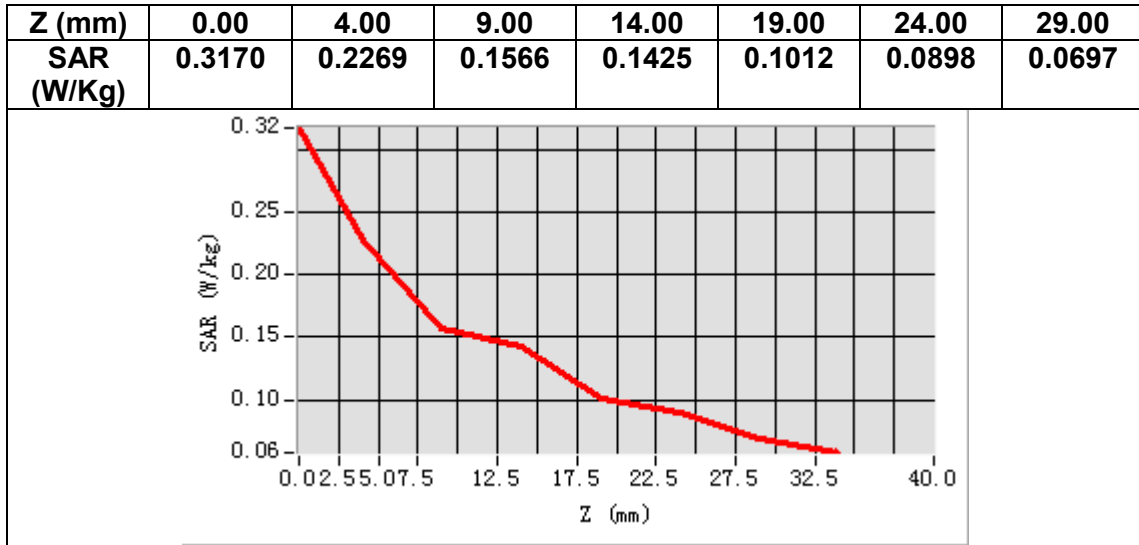

MEASUREMENT 3

A. Experimental conditions.

Area Scan	<u>dx=15mm dy=15mm, h= 5.00 mm</u>
ZoomScan	<u>5x5x7,dx=8mm dy=8mm dz=5mm</u>
Phantom	<u>Left head</u>
Device Position	<u>Cheek</u>
Band	<u>GSM1900</u>
Channels	<u>Middle</u>
Signal	<u>TDMA (Crest factor: 2.0)</u>

B. SAR Measurement Results

Frequency (MHz)	1880.000000
Relative permittivity (real part)	40.080399
Relative permittivity (imaginary part)	13.387800
Conductivity (S/m)	1.398281
Variation (%)	-2.240000

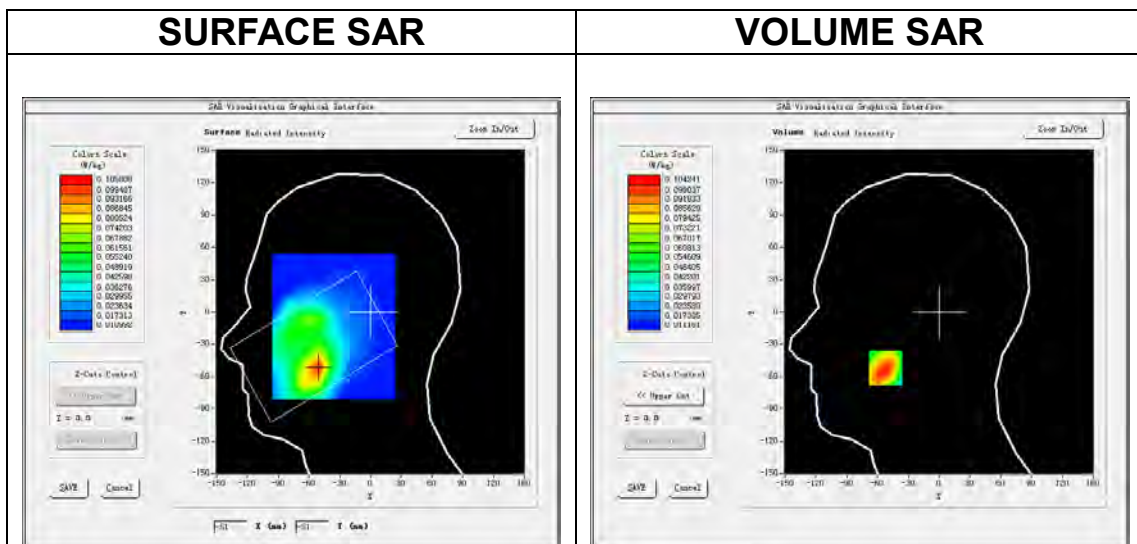

Maximum location: X=-52.00, Y=-52.00

SAR Peak: 0.15 W/kg

SAR 10g (W/Kg)	0.061755
SAR 1g (W/Kg)	0.099768

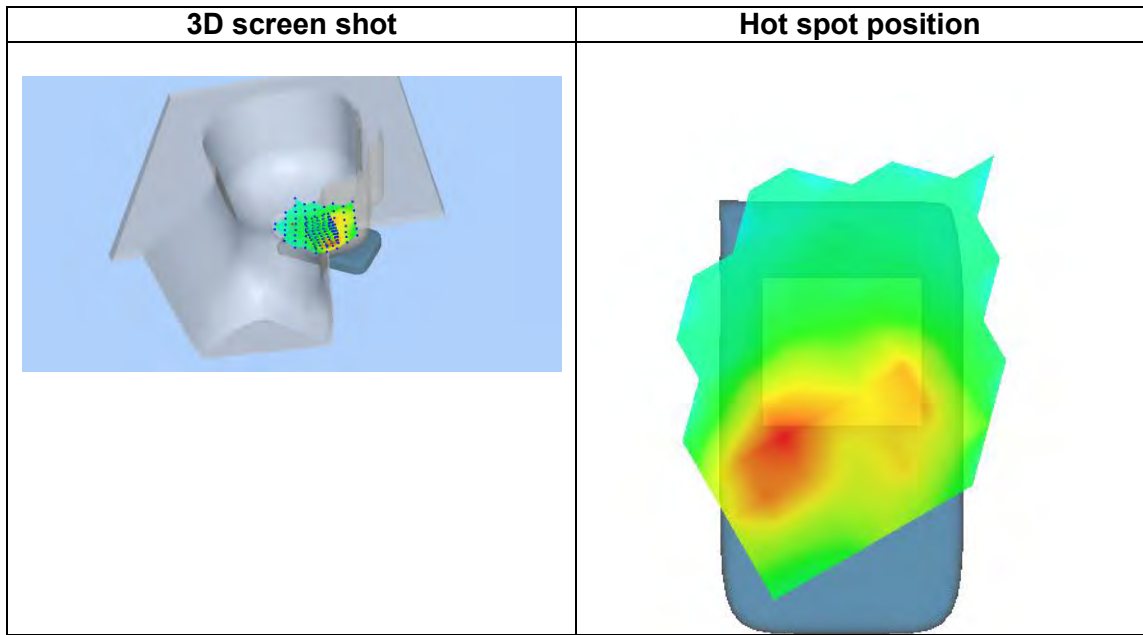
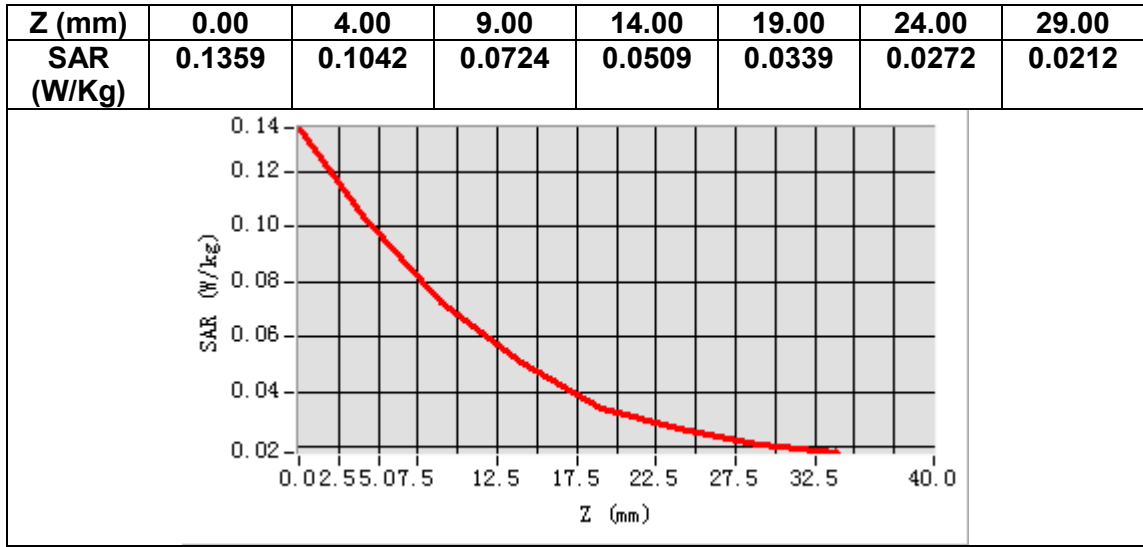

MEASUREMENT 4

A. Experimental conditions.

Area Scan	<u>dx=15mm dy=15mm, h= 5.00 mm</u>
ZoomScan	<u>5x5x7,dx=8mm dy=8mm dz=5mm</u>
Phantom	<u>Validation plane</u>
Device Position	<u>Body</u>
Band	<u>GSM1900</u>
Channels	<u>Middle</u>
Signal	<u>TDMA (Crest factor: 2.0)</u>

B. SAR Measurement Results

Frequency (MHz)	1880.000000
Relative permittivity (real part)	53.258900
Relative permittivity (imaginary part)	14.677700
Conductivity (S/m)	1.533004
Variation (%)	-4.060000

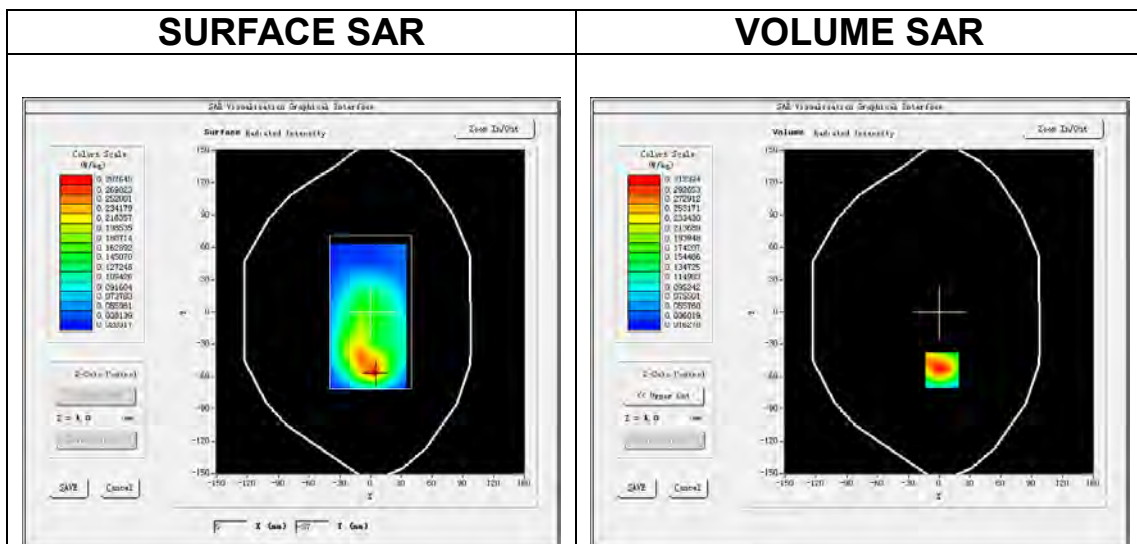

Maximum location: X=3.00, Y=-54.00

SAR Peak: 0.49 W/kg

SAR 10g (W/Kg)	0.167359
SAR 1g (W/Kg)	0.303364

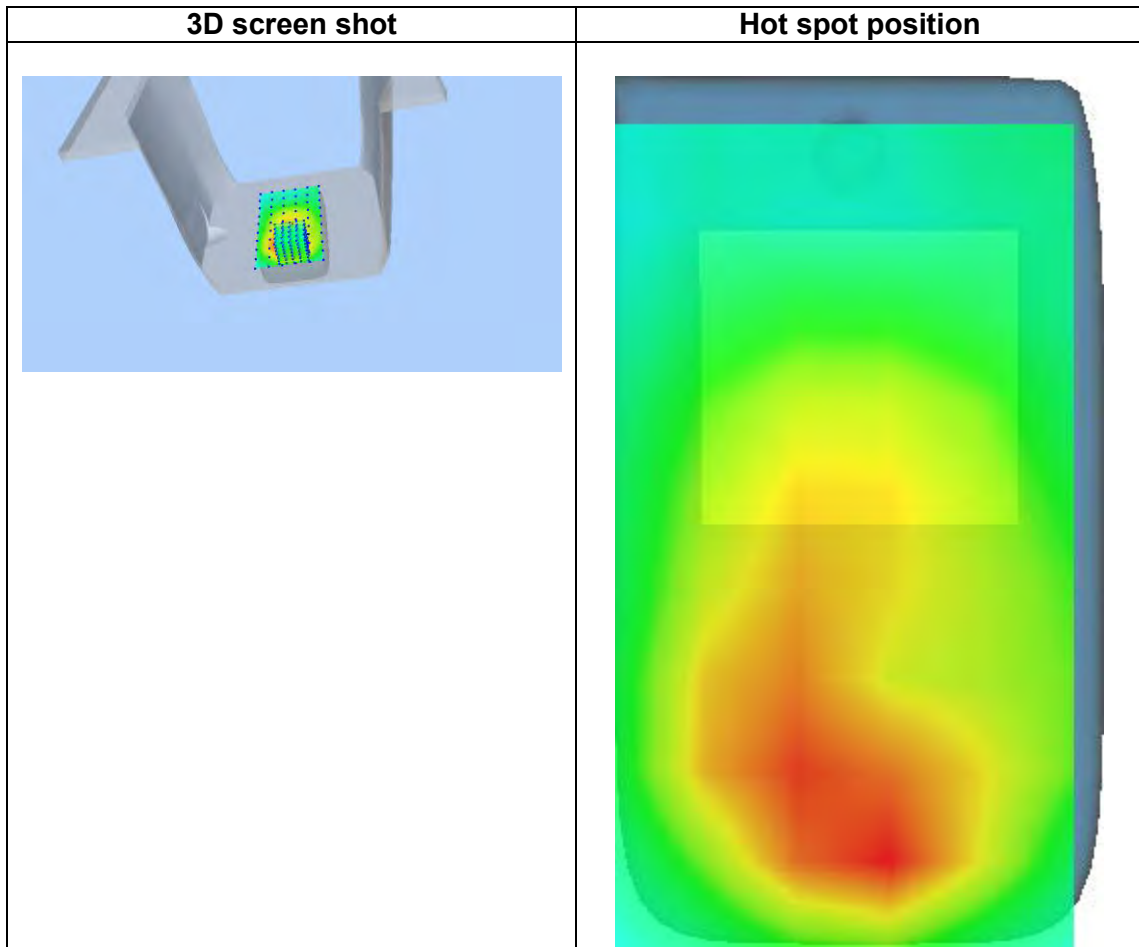
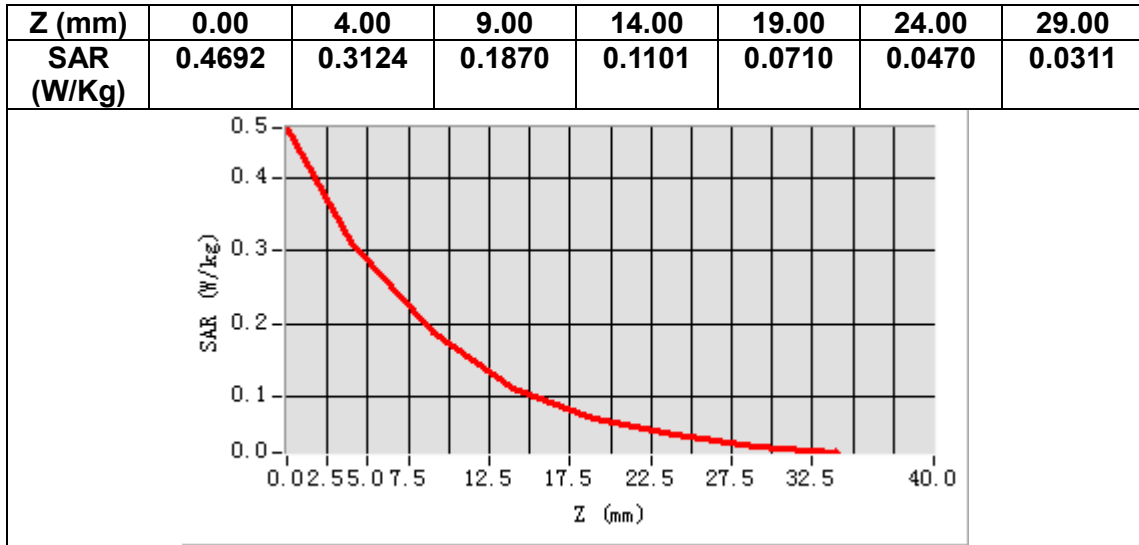

MEASUREMENT 5

A. Experimental conditions.

Area Scan	<u>dx=15mm dy=15mm, h= 5.00 mm</u>
ZoomScan	<u>5x5x7,dx=8mm dy=8mm dz=5mm</u>
Phantom	<u>Left head</u>
Device Position	<u>Cheek</u>
Band	<u>Band2 WCDMA1900</u>
Channels	<u>Middle</u>
Signal	<u>WCDMA (Crest factor: 1.0)</u>

B. SAR Measurement Results

Frequency (MHz)	1880.000000
Relative permittivity (real part)	40.080399
Relative permittivity (imaginary part)	13.387800
Conductivity (S/m)	1.398281
Variation (%)	-3.040000

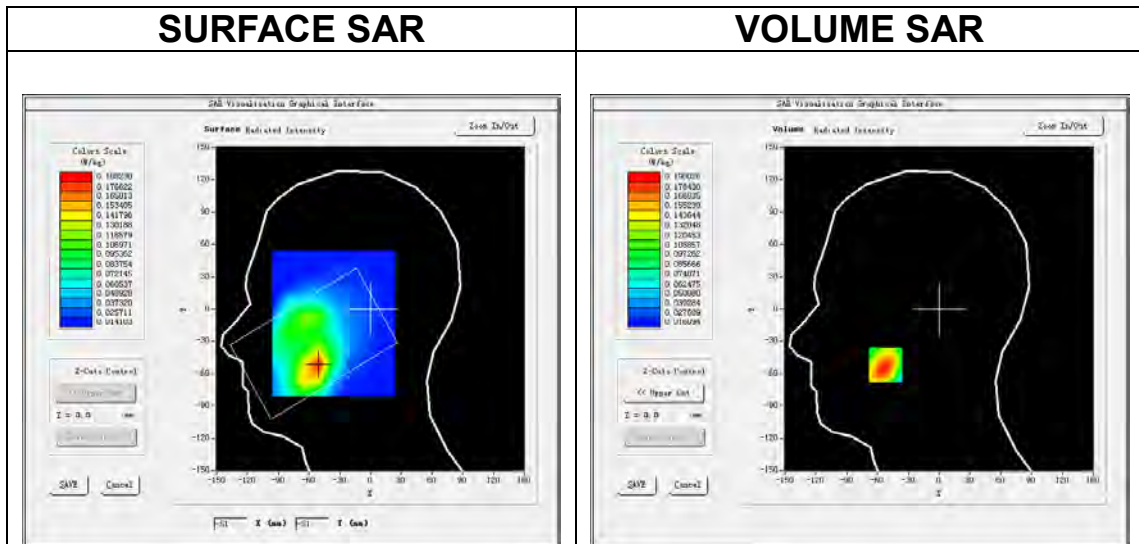

Maximum location: X=-52.00, Y=-52.00

SAR Peak: 0.28 W/kg

SAR 10g (W/Kg)	0.112053
SAR 1g (W/Kg)	0.184318

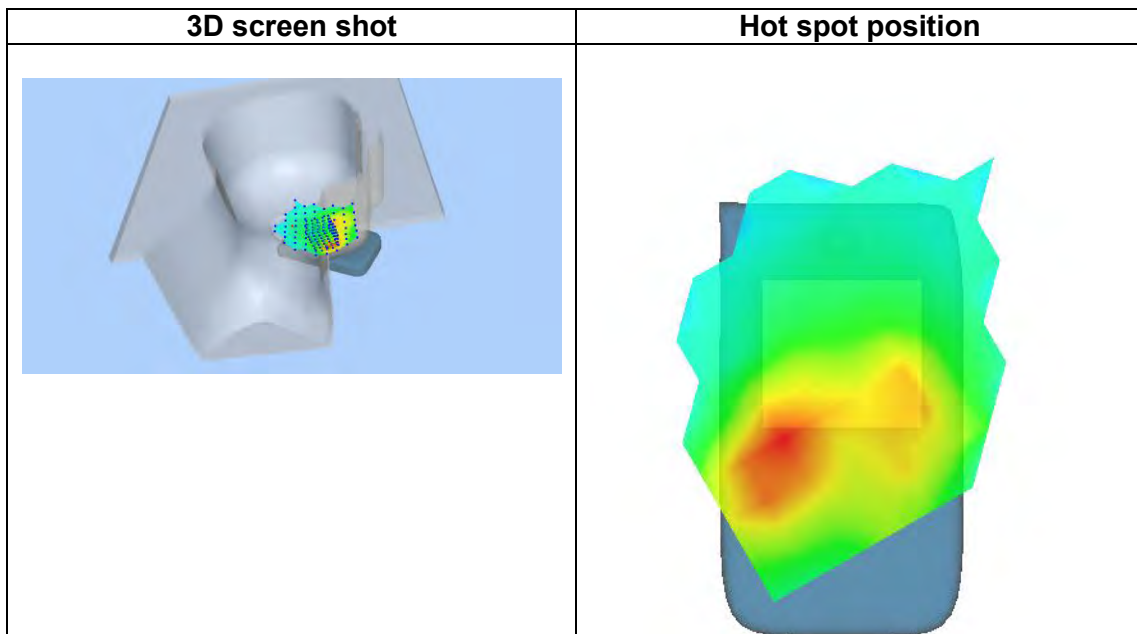
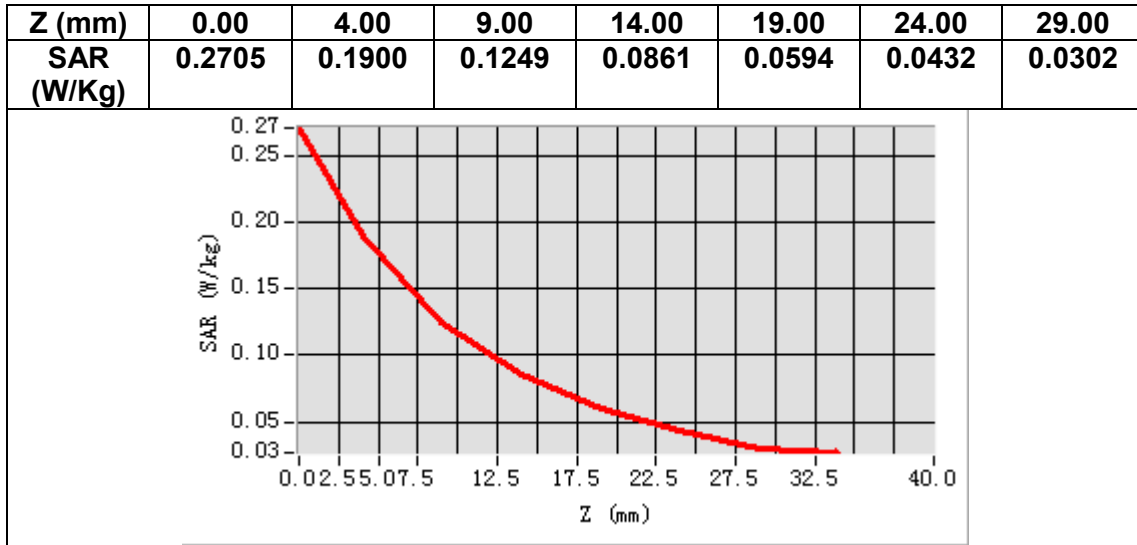

MEASUREMENT 6

A. Experimental conditions.

Area Scan	<u>dx=15mm dy=15mm, h= 5.00 mm</u>
ZoomScan	<u>5x5x7,dx=8mm dy=8mm dz=5mm</u>
Phantom	<u>Validation plane</u>
Device Position	<u>Body</u>
Band	<u>Band2 WCDMA1900</u>
Channels	<u>Middle</u>
Signal	<u>WCDMA (Crest factor: 1.0)</u>

B. SAR Measurement Results

Frequency (MHz)	1880.000000
Relative permittivity (real part)	53.258900
Relative permittivity (imaginary part)	14.677700
Conductivity (S/m)	1.533004
Variation (%)	-0.060000

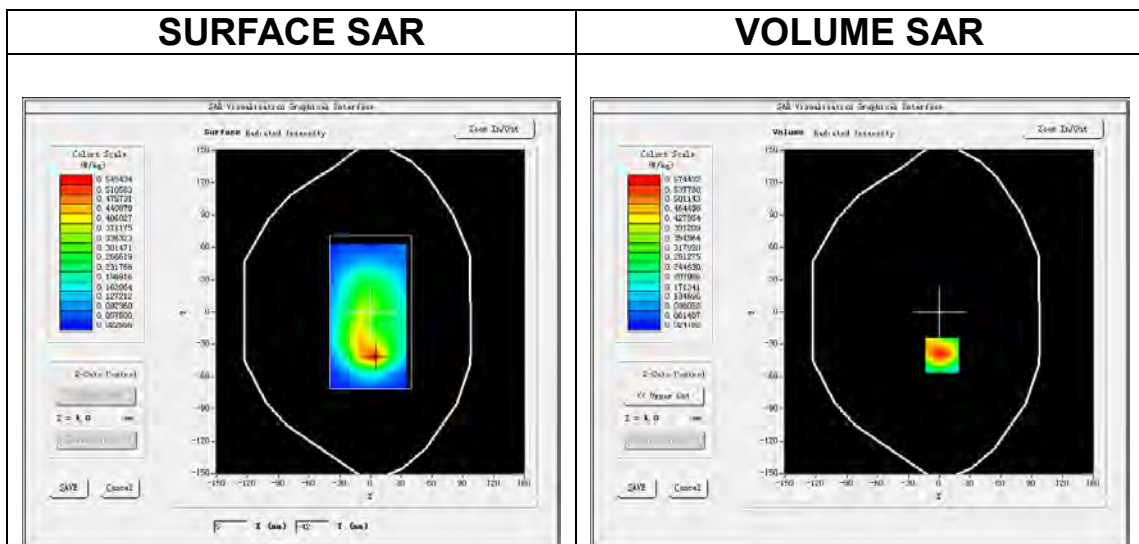

Maximum location: X=3.00, Y=-40.00

SAR Peak: 0.86 W/kg

SAR 10g (W/Kg)	0.302428
SAR 1g (W/Kg)	0.544450

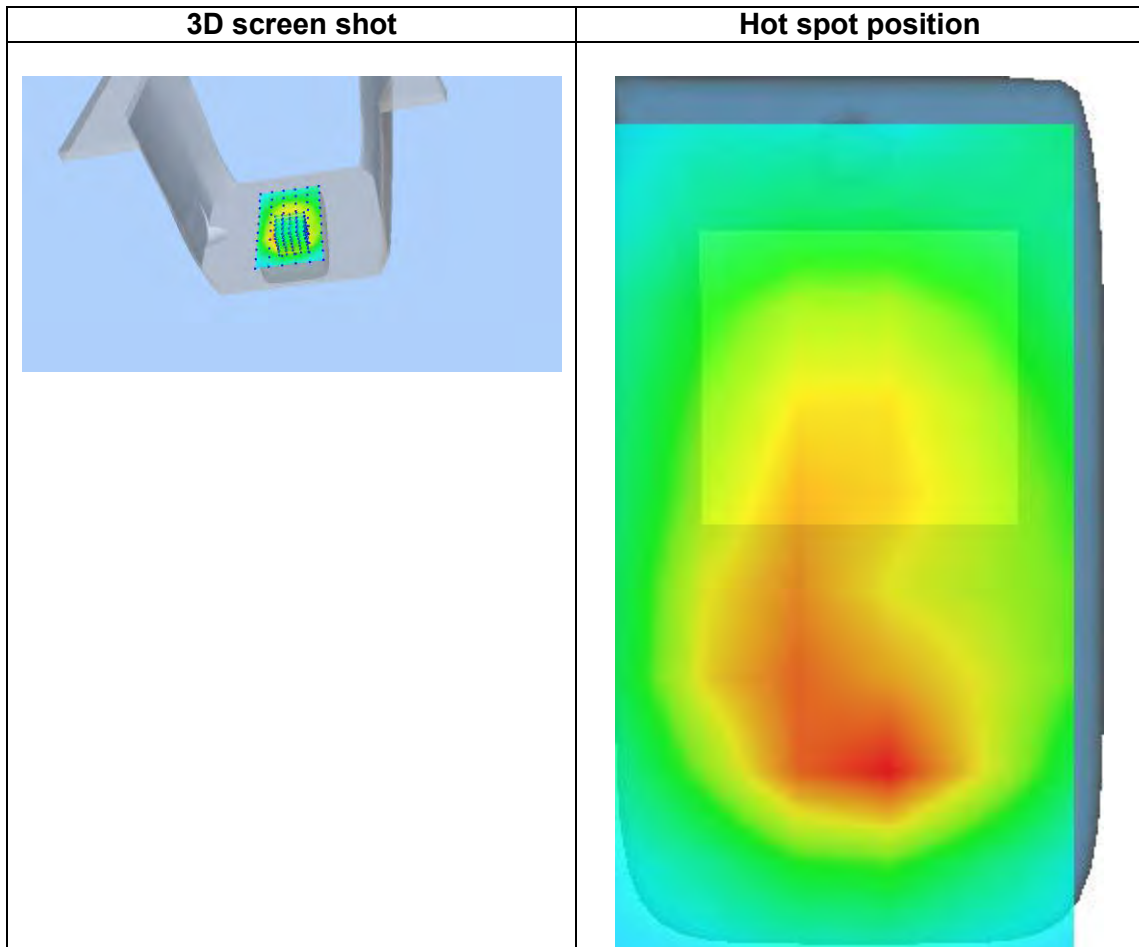
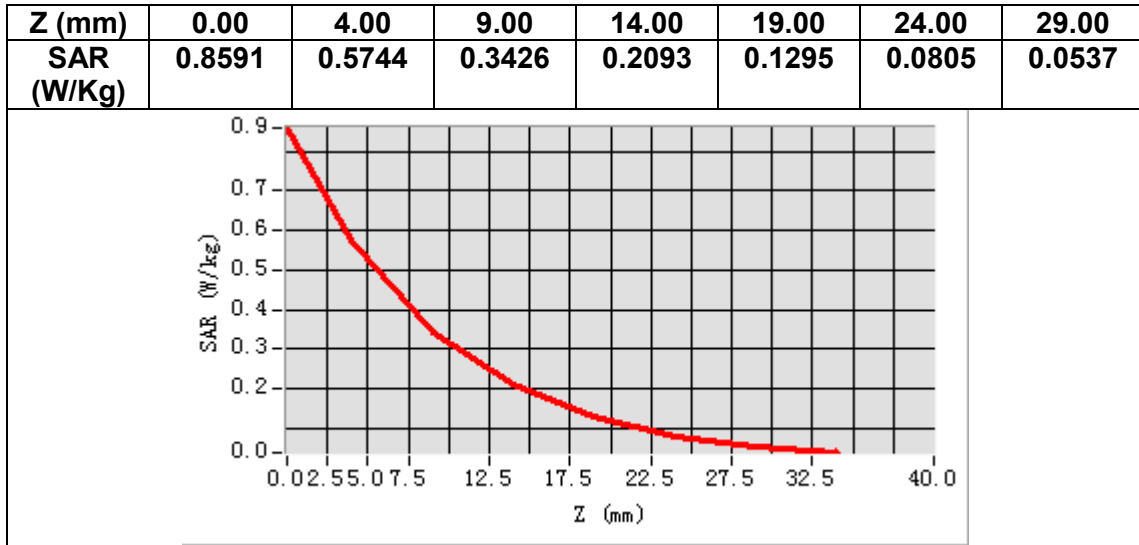

MEASUREMENT 7

A. Experimental conditions.

Area Scan	<u>dx=15mm dy=15mm, h= 5.00 mm</u>
ZoomScan	<u>5x5x7,dx=8mm dy=8mm dz=5mm</u>
Phantom	<u>Left head</u>
Device Position	<u>Cheek</u>
Band	<u>Band5 WCDMA850</u>
Channels	<u>Middle</u>
Signal	<u>WCDMA (Crest factor: 1.0)</u>

B. SAR Measurement Results

Frequency (MHz)	836.400000
Relative permittivity (real part)	41.530960
Relative permittivity (imaginary part)	19.511539
Conductivity (S/m)	0.906636
Variation (%)	-2.770000

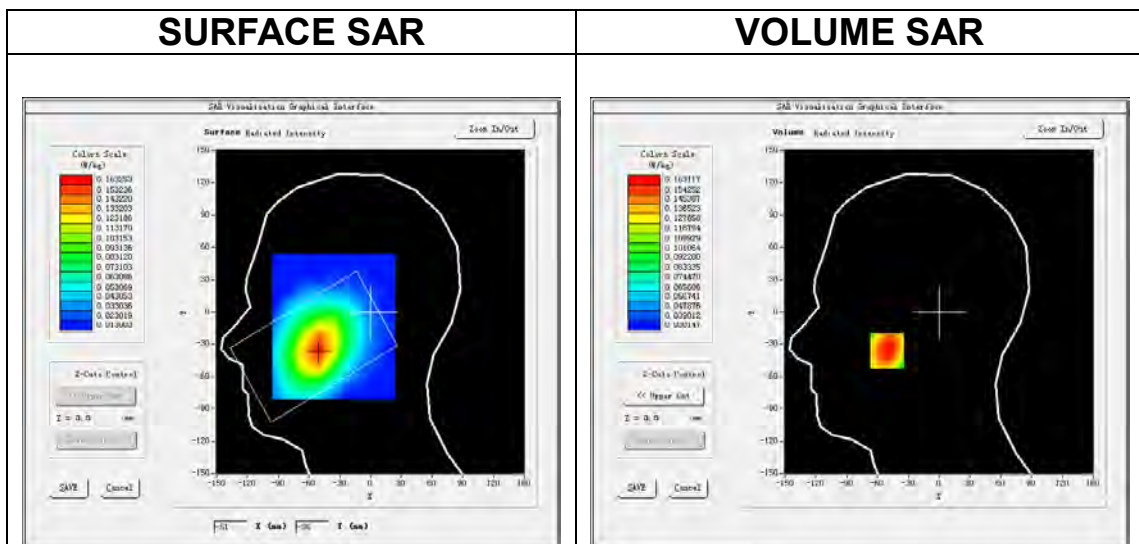

Maximum location: X=-51.00, Y=-36.00

SAR Peak: 0.20 W/kg

SAR 10g (W/Kg)	0.122429
SAR 1g (W/Kg)	0.159822

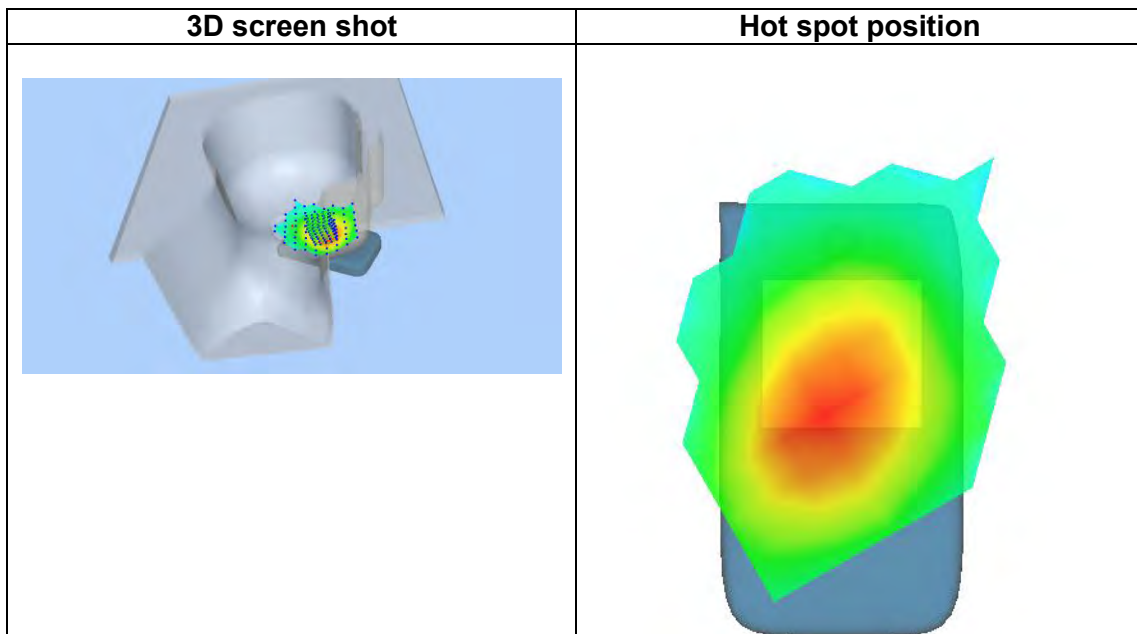
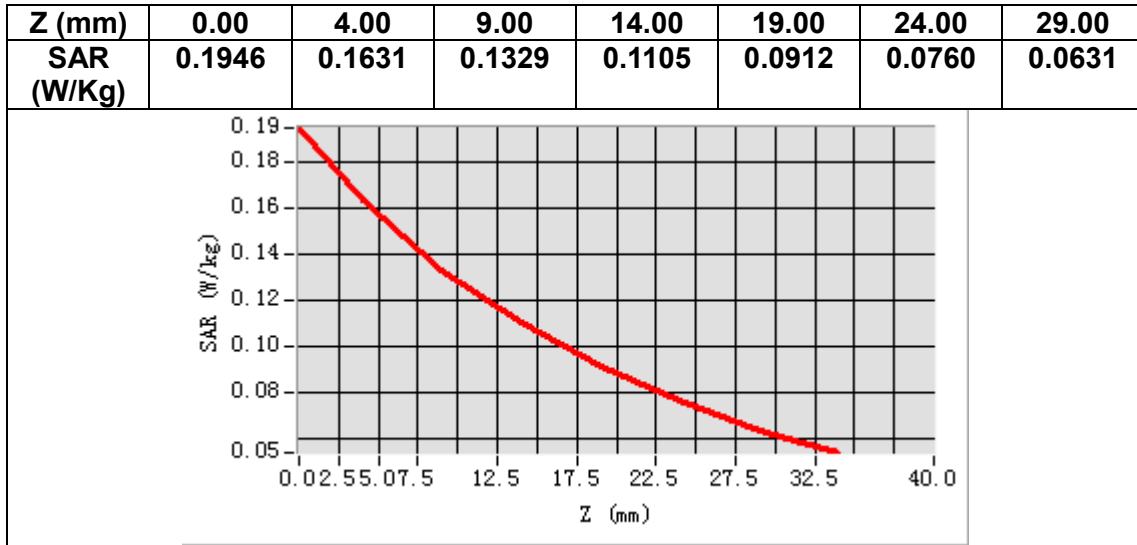

MEASUREMENT 8

A. Experimental conditions.

Area Scan	<u>dx=15mm dy=15mm, h= 5.00 mm</u>
ZoomScan	<u>5x5x7,dx=8mm dy=8mm dz=5mm</u>
Phantom	<u>Validation plane</u>
Device Position	<u>Body</u>
Band	<u>Band5 WCDMA850</u>
Channels	<u>Middle</u>
Signal	<u>WCDMA (Crest factor: 1.0)</u>

B. SAR Measurement Results

Frequency (MHz)	836.400000
Relative permittivity (real part)	54.899578
Relative permittivity (imaginary part)	21.492741
Conductivity (S/m)	0.998696
Variation (%)	0.350000

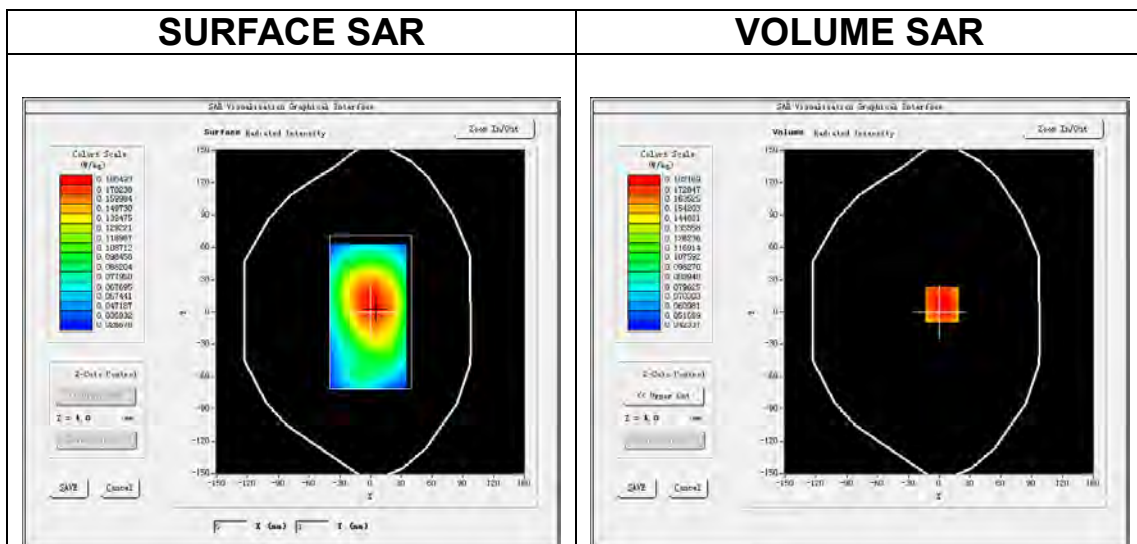

Maximum location: X=3.00, Y=7.00

SAR Peak: 0.21 W/kg

SAR 10g (W/Kg)	0.141440
SAR 1g (W/Kg)	0.180454

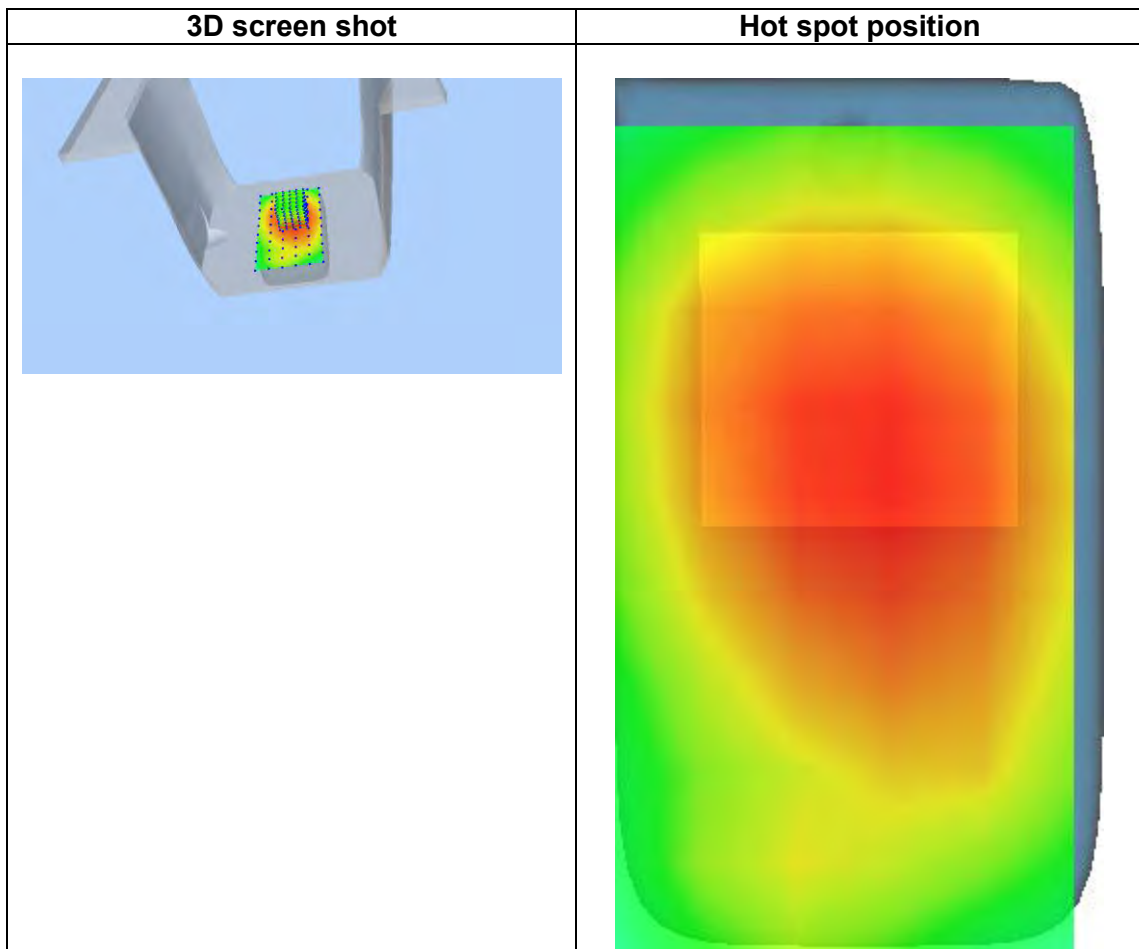
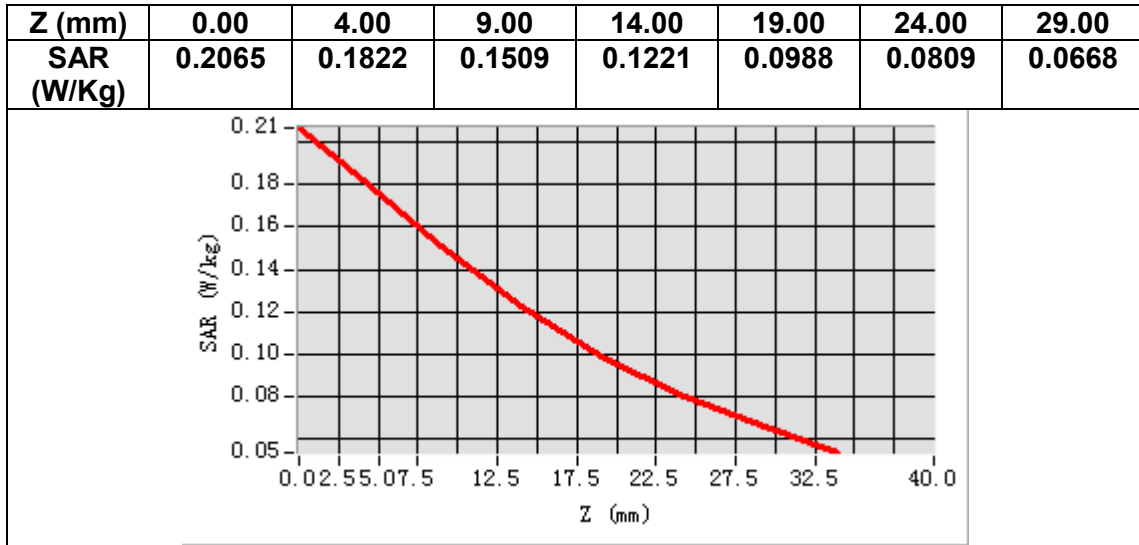

MEASUREMENT 9

A. Experimental conditions.

Area Scan	<u>dx=12mm dy=12mm, h= 5.00 mm</u>
ZoomScan	<u>7x7x7,dx=5mm dy=5mm dz=5mm</u>
Phantom	<u>Left head</u>
Device Position	<u>Cheek</u>
Band	<u>IEEE 802.11b ISM</u>
Channels	<u>Middle</u>
Signal	<u>IEEE802.11b (Crest factor: 1.0)</u>

B. SAR Measurement Results

Frequency (MHz)	2437.000000
Relative permittivity (real part)	40.041000
Relative permittivity (imaginary part)	13.050300
Conductivity (S/m)	1.766866
Variation (%)	-4.100000

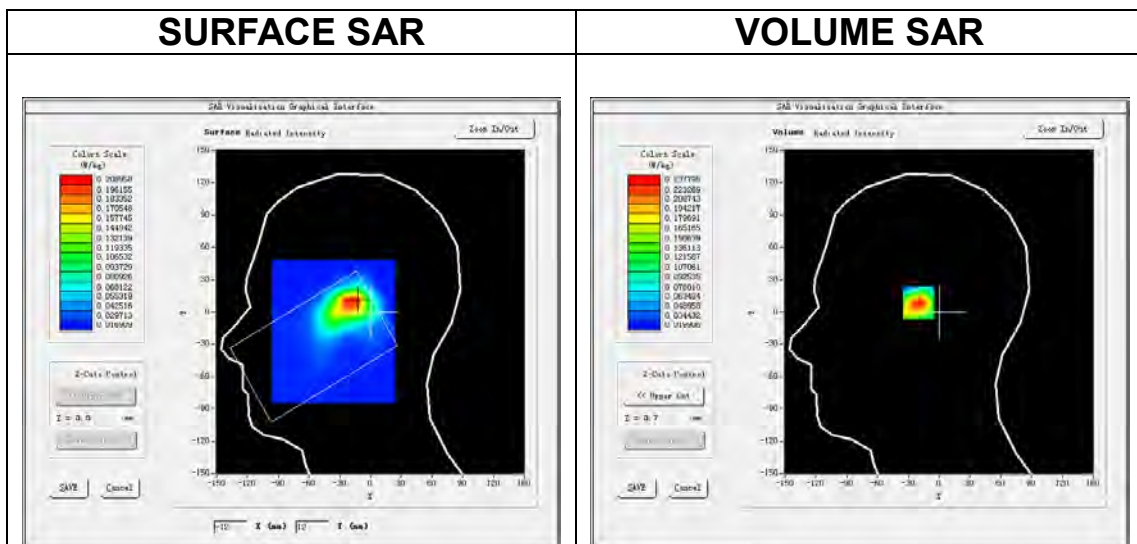

Maximum location: X=-18.00, Y=10.00

SAR Peak: 0.35 W/kg

SAR 10g (W/Kg)	0.122482
SAR 1g (W/Kg)	0.213836

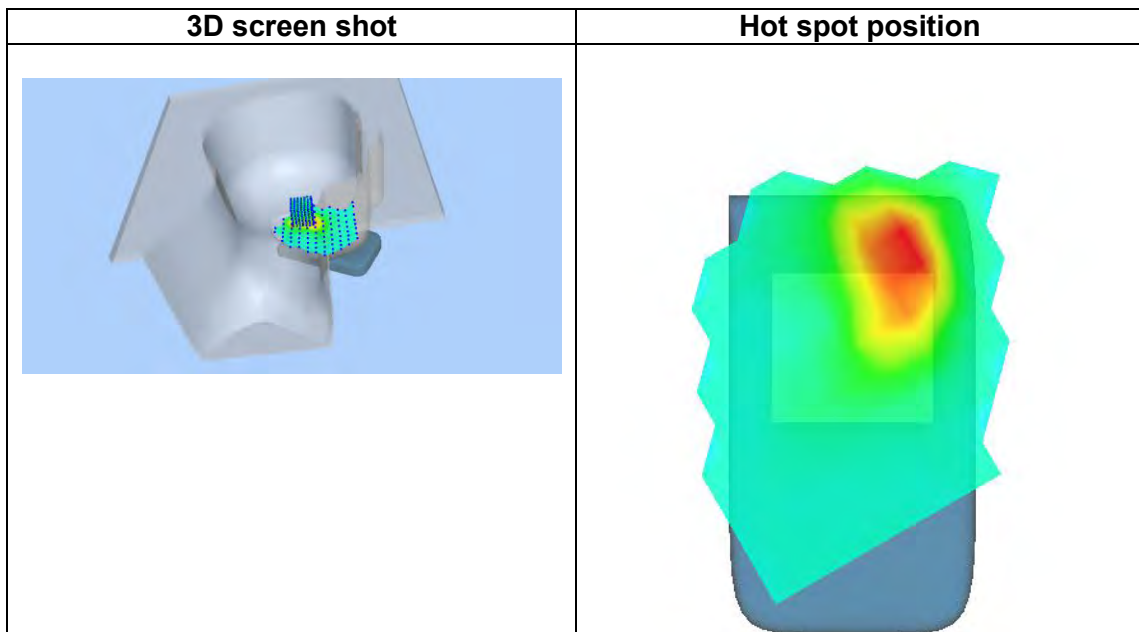
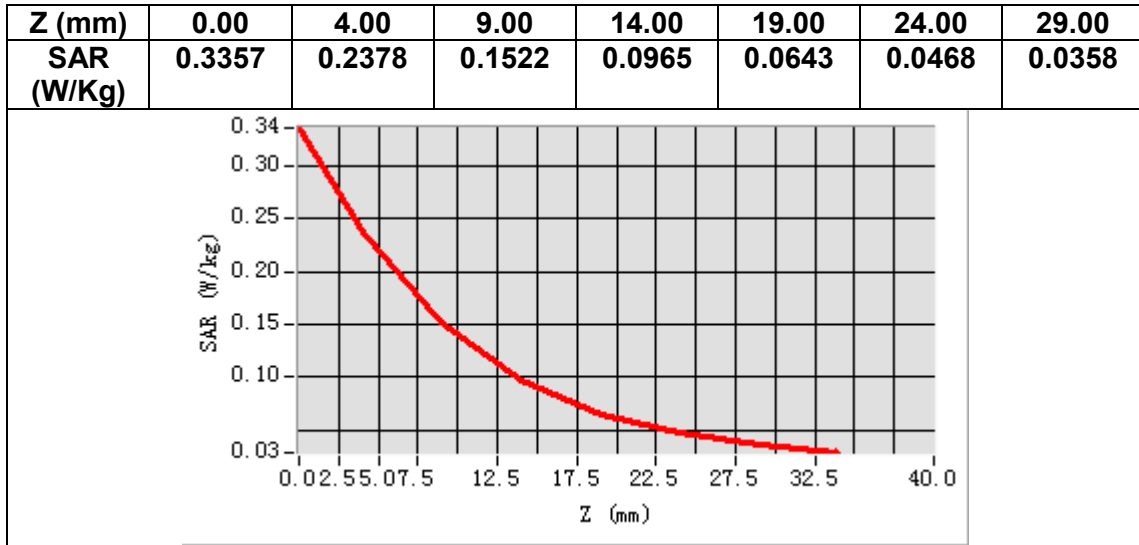

MEASUREMENT 10

A. Experimental conditions.

Area Scan	<u>dx=12mm dy=12mm, h= 5.00 mm</u>
ZoomScan	<u>7x7x7,dx=5mm dy=5mm dz=5mm</u>
Phantom	<u>Validation plane</u>
Device Position	<u>Body</u>
Band	<u>IEEE 802.11b ISM</u>
Channels	<u>Middle</u>
Signal	<u>IEEE802.11b (Crest factor: 1.0)</u>

B. SAR Measurement Results

Frequency (MHz)	2437.000000
Relative permittivity (real part)	52.761600
Relative permittivity (imaginary part)	14.445620
Conductivity (S/m)	1.955776
Variation (%)	-1.460000

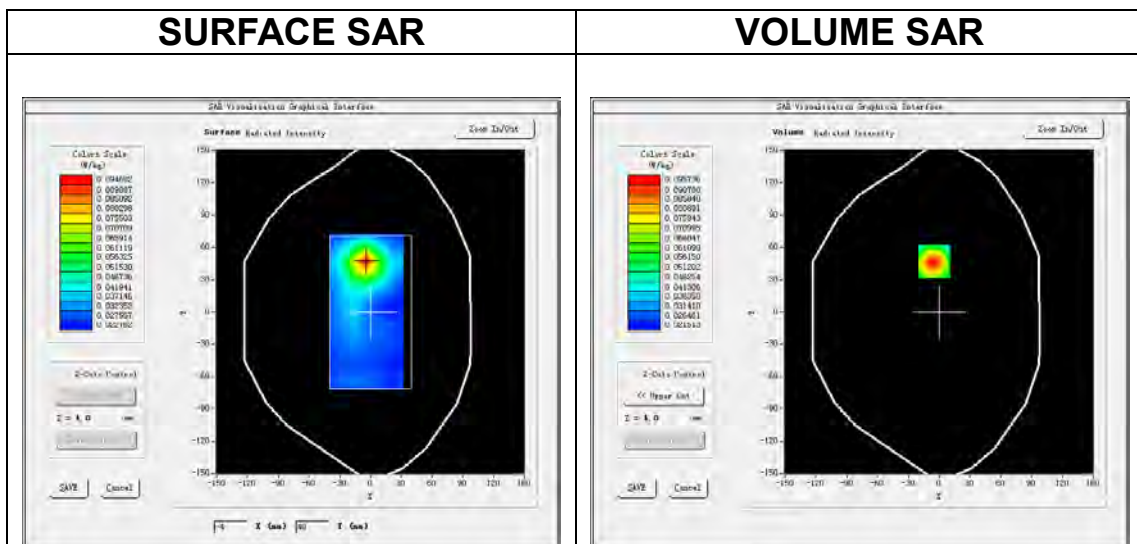

Maximum location: X=-5.00, Y=47.00

SAR Peak: 0.13 W/kg

SAR 10g (W/Kg)	0.058698
SAR 1g (W/Kg)	0.088445

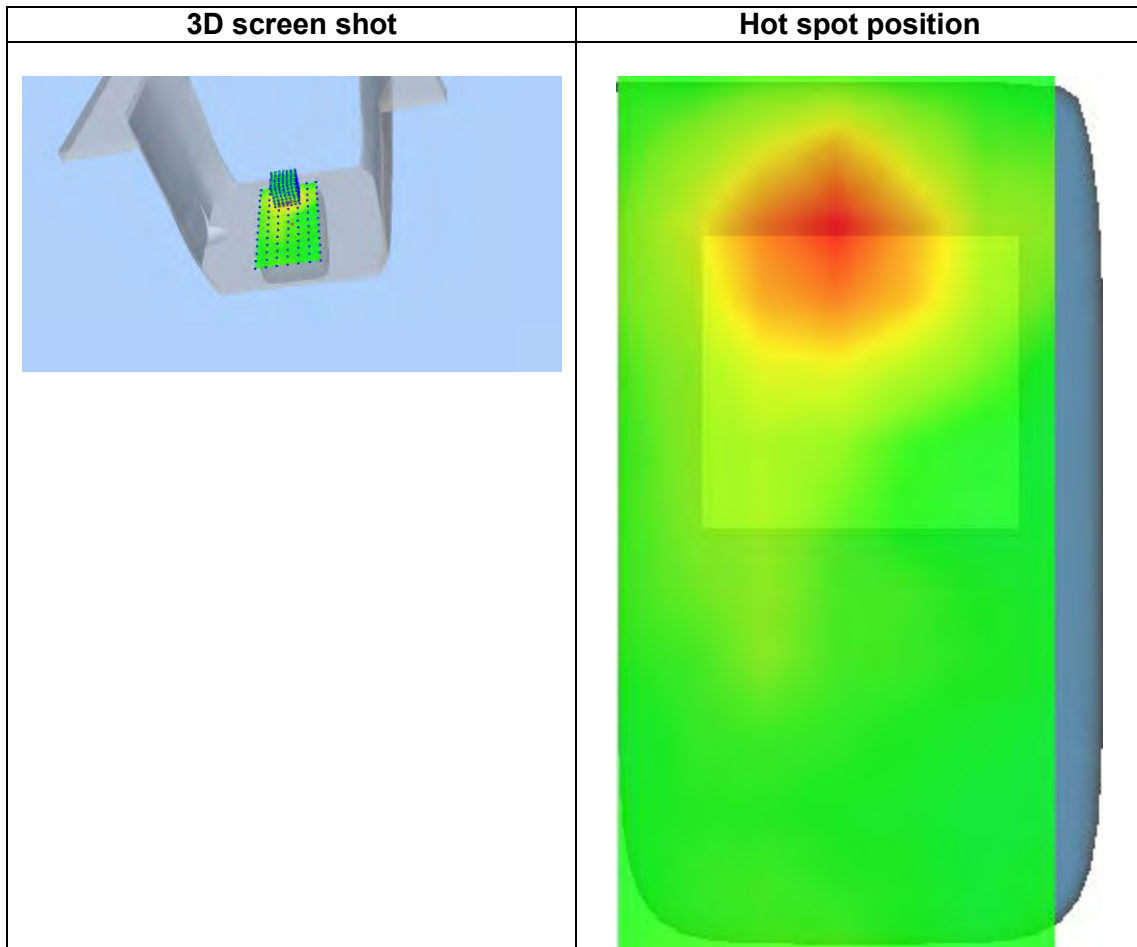
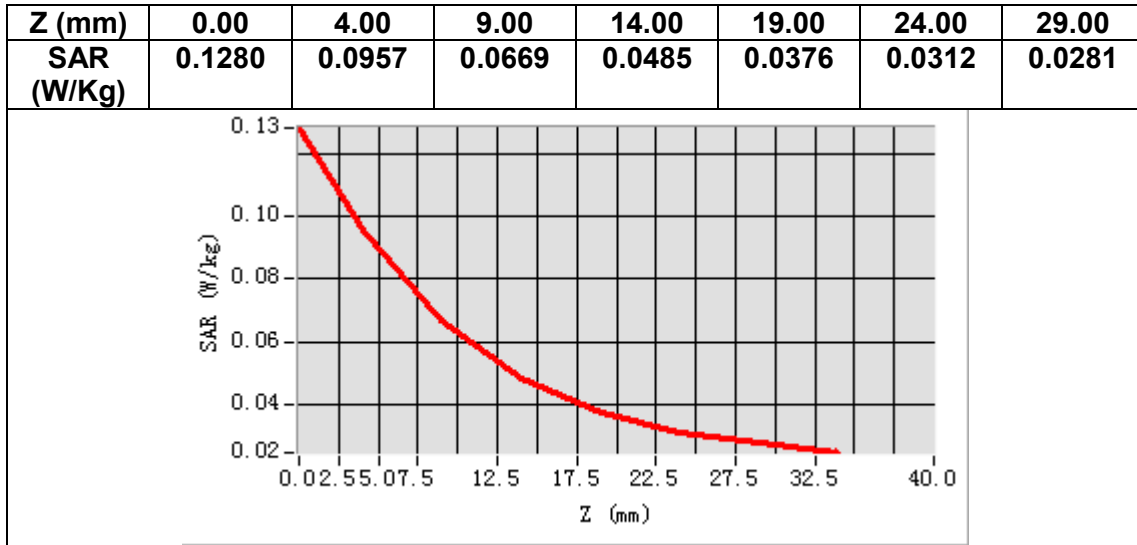

MEASUREMENT 11

A. Experimental conditions.

Area Scan	<u>dx=15mm dy=15mm, h= 5.00 mm</u>
ZoomScan	<u>5x5x7,dx=8mm dy=8mm dz=5mm</u>
Phantom	<u>Left head</u>
Device Position	<u>Cheek</u>
Band	<u>LTE band 2</u>
Channels	<u>Middle</u>
Signal	<u>LTE (Crest factor: 1.0)</u>

B. SAR Measurement Results

Frequency (MHz)	1880.000000
Relative permittivity (real part)	40.086948
Relative permittivity (imaginary part)	13.372750
Conductivity (S/m)	1.396338
Variation (%)	-2.060000

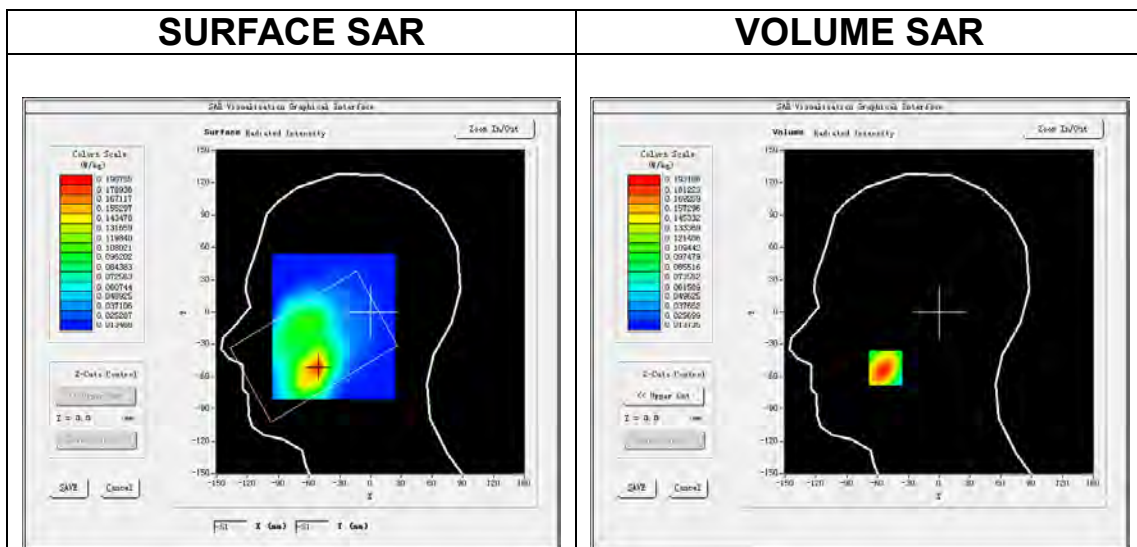

Maximum location: X=-52.00, Y=-52.00

SAR Peak: 0.28 W/kg

SAR 10g (W/Kg)	0.113192
SAR 1g (W/Kg)	0.186136

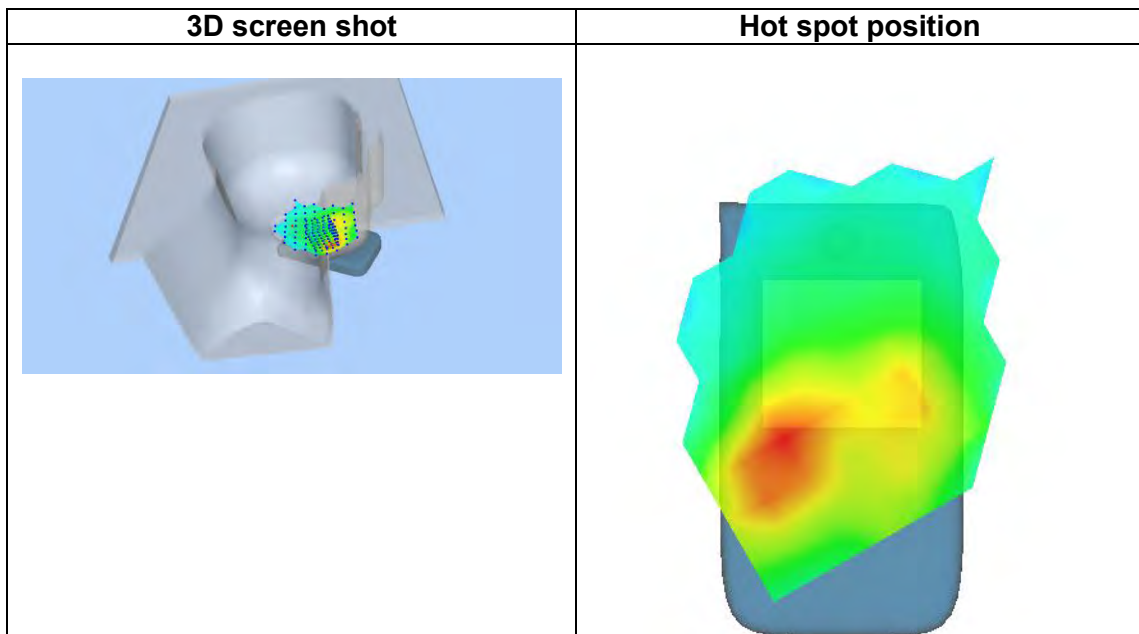
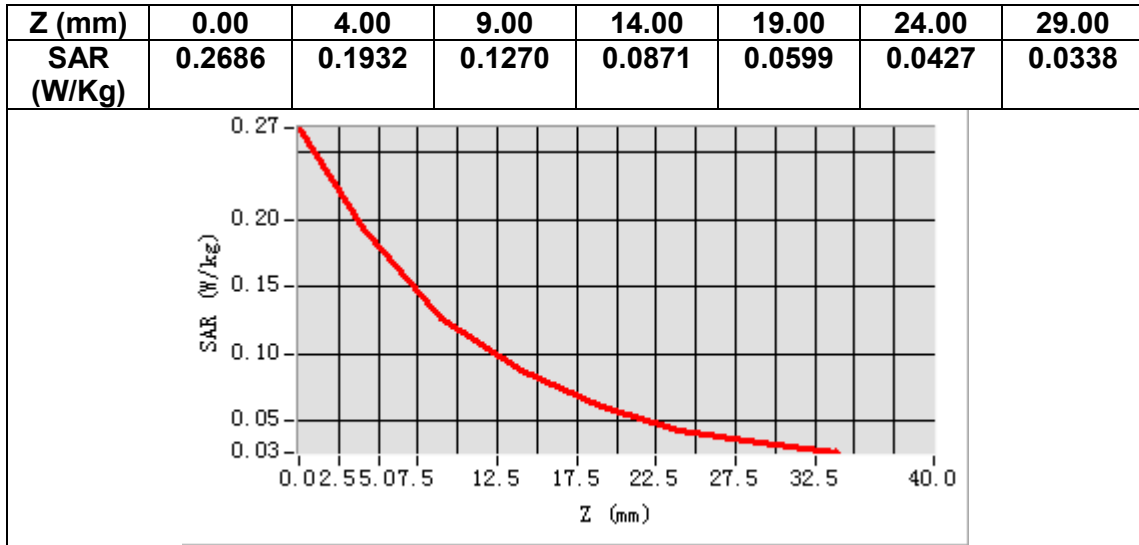

MEASUREMENT 12

A. Experimental conditions.

Area Scan	<u>dx=15mm dy=15mm, h= 5.00 mm</u>
ZoomScan	<u>5x5x7,dx=8mm dy=8mm dz=5mm</u>
Phantom	<u>Validation plane</u>
Device Position	<u>Body</u>
Band	<u>LTE band 2</u>
Channels	<u>Middle</u>
Signal	<u>LTE (Crest factor: 1.0)</u>

B. SAR Measurement Results

Frequency (MHz)	1880.000000
Relative permittivity (real part)	53.265949
Relative permittivity (imaginary part)	14.686150
Conductivity (S/m)	1.533479
Variation (%)	0.090000

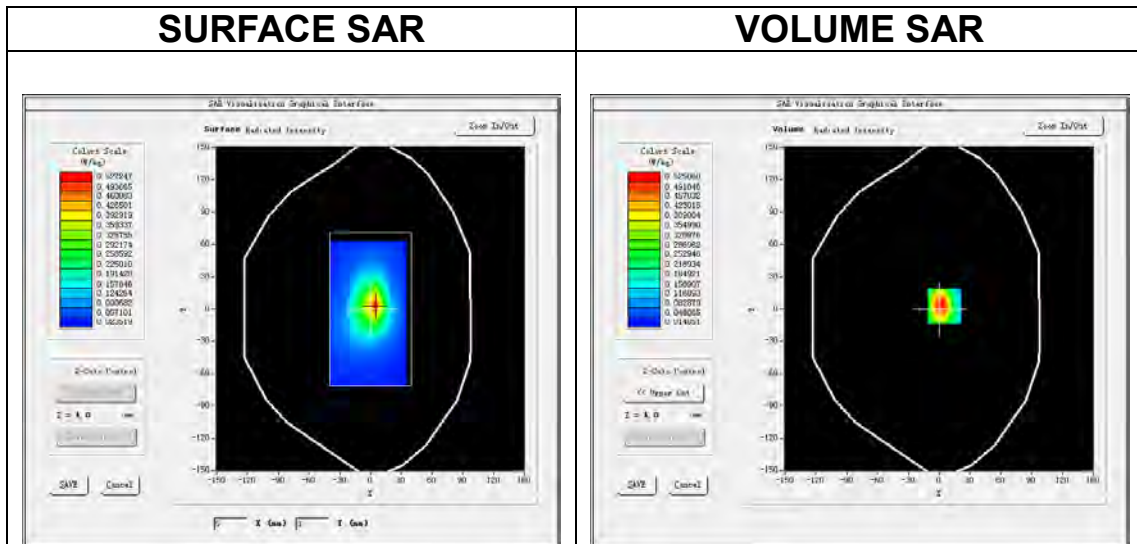

Maximum location: X=5.00, Y=3.00

SAR Peak: 0.82 W/kg

SAR 10g (W/Kg)	0.268848
SAR 1g (W/Kg)	0.509794

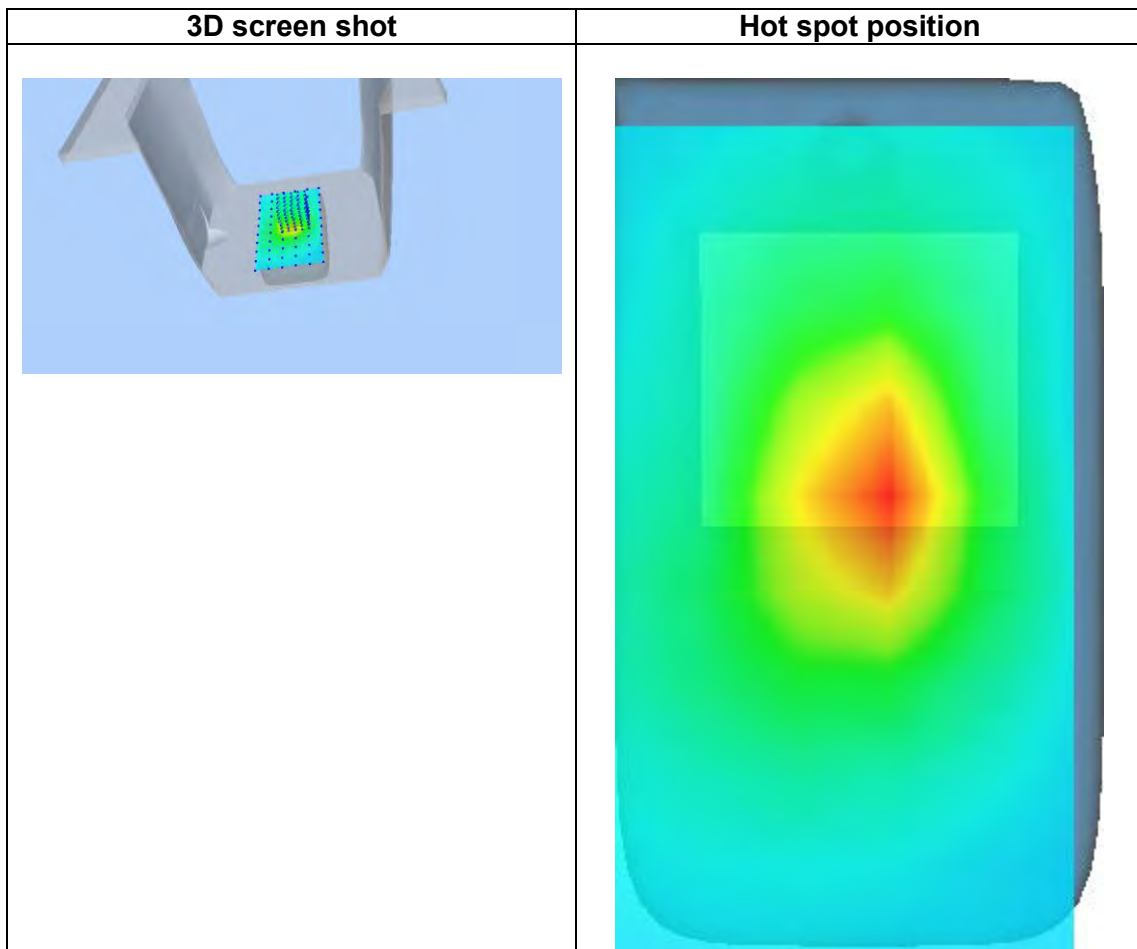
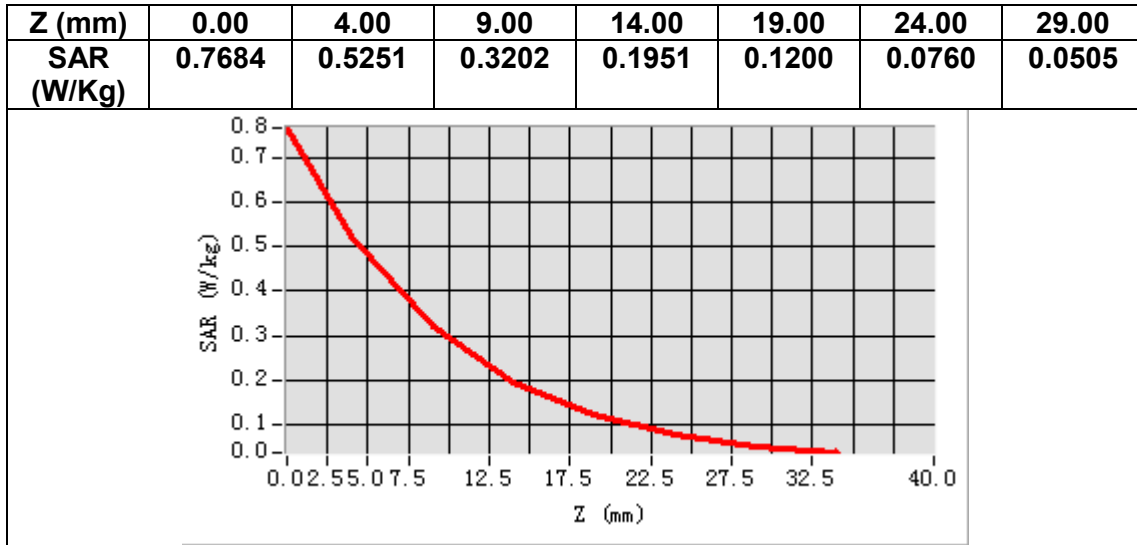

MEASUREMENT 13

A. Experimental conditions.

Area Scan	<u>dx=15mm dy=15mm, h= 5.00 mm</u>
ZoomScan	<u>5x5x7,dx=8mm dy=8mm dz=5mm</u>
Phantom	<u>Left head</u>
Device Position	<u>Cheek</u>
Band	<u>LTE band 4</u>
Channels	<u>Middle</u>
Signal	<u>LTE (Crest factor: 1.0)</u>

B. SAR Measurement Results

Frequency (MHz)	1732.500000
Relative permittivity (real part)	39.955292
Relative permittivity (imaginary part)	13.890592
Conductivity (S/m)	1.336969
Variation (%)	-3.890000

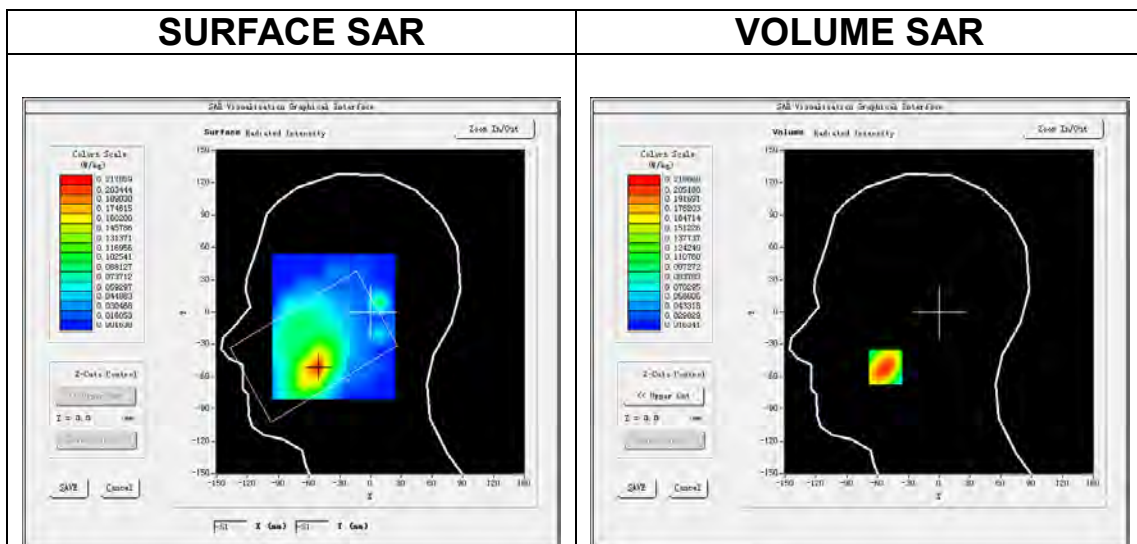

Maximum location: X=-52.00, Y=-51.00

SAR Peak: 0.30 W/kg

SAR 10g (W/Kg)	0.132510
SAR 1g (W/Kg)	0.208602

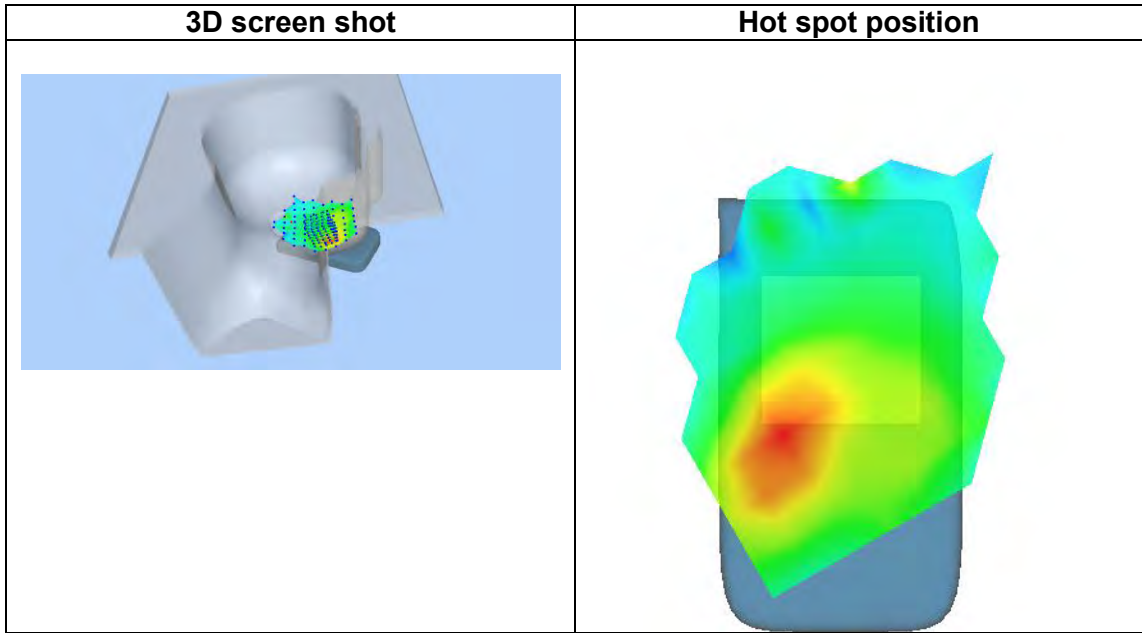
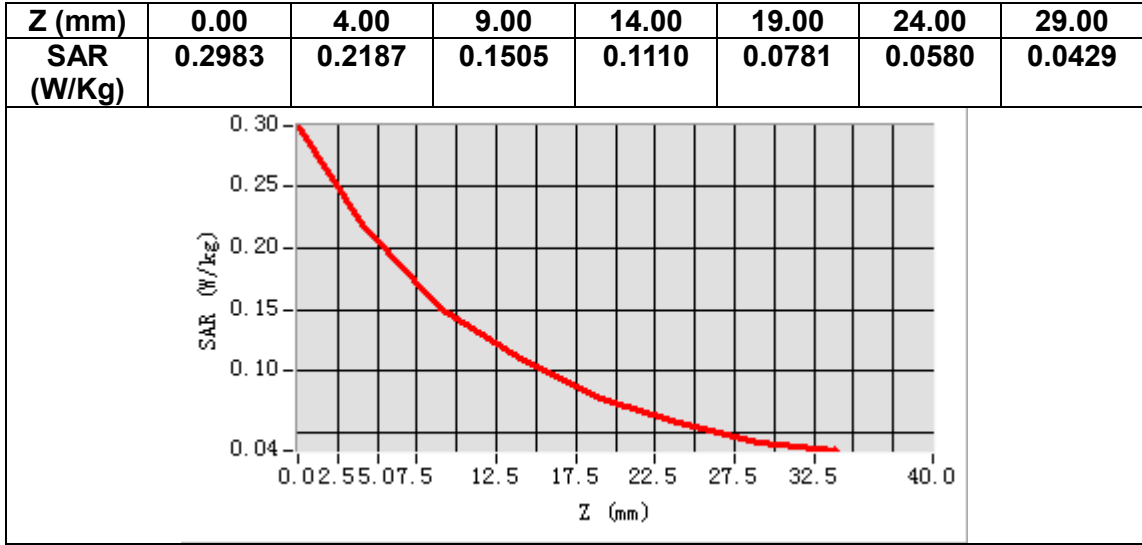

MEASUREMENT 14

A. Experimental conditions.

Area Scan	<u>dx=15mm dy=15mm, h= 5.00 mm</u>
ZoomScan	<u>5x5x7,dx=8mm dy=8mm dz=5mm</u>
Phantom	<u>Validation plane</u>
Device Position	<u>Body</u>
Band	<u>LTE band 4</u>
Channels	<u>Middle</u>
Signal	<u>LTE (Crest factor: 1.0)</u>

B. SAR Measurement Results

Frequency (MHz)	1732.500000
Relative permittivity (real part)	54.183365
Relative permittivity (imaginary part)	15.263220
Conductivity (S/m)	1.469085
Variation (%)	-1.390000

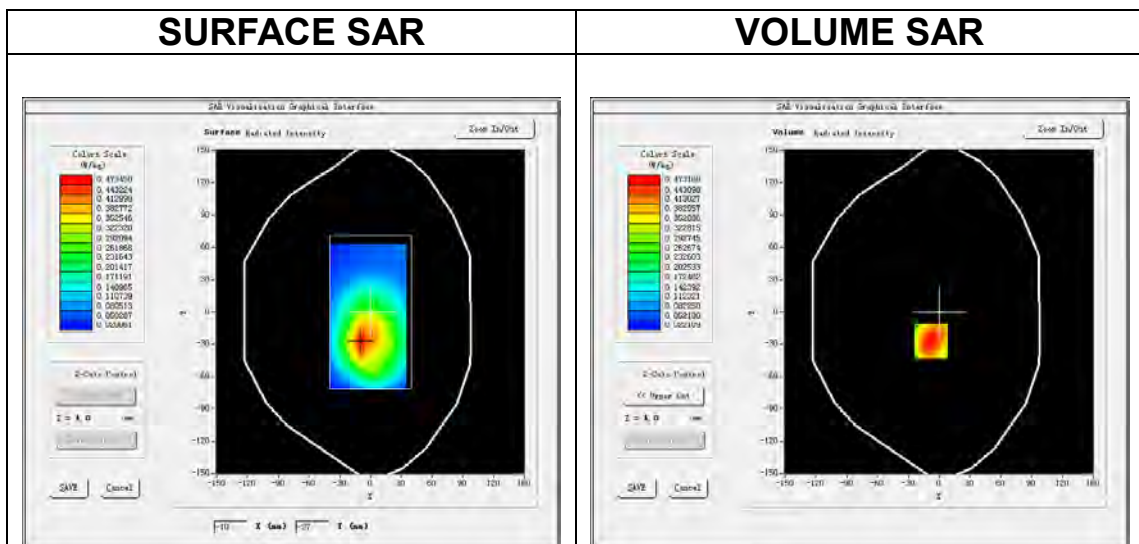

Maximum location: X=-8.00, Y=-27.00

SAR Peak: 0.70 W/kg

SAR 10g (W/Kg)	0.276031
SAR 1g (W/Kg)	0.455375

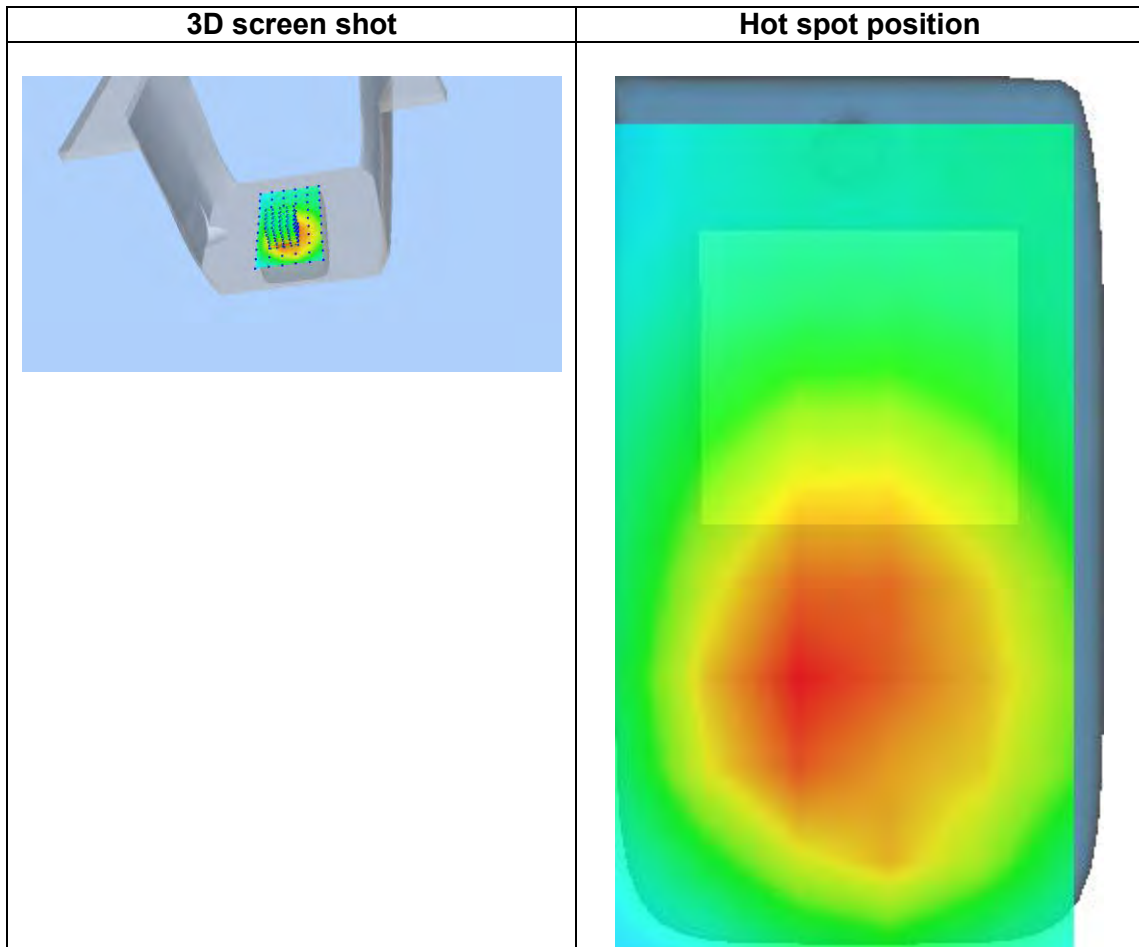
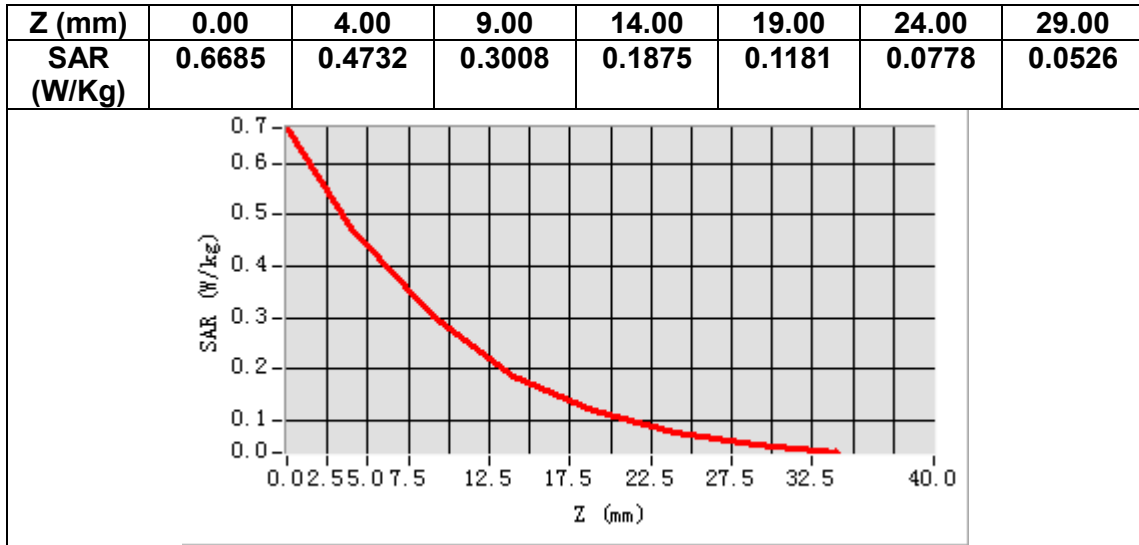

MEASUREMENT 15

A. Experimental conditions.

Area Scan	<u>dx=15mm dy=15mm, h= 5.00 mm</u>
ZoomScan	<u>5x5x7,dx=8mm dy=8mm dz=5mm</u>
Phantom	<u>Left head</u>
Device Position	<u>Cheek</u>
Band	<u>LTE band 5</u>
Channels	<u>Middle</u>
Signal	<u>LTE (Crest factor: 1.0)</u>

B. SAR Measurement Results

Frequency (MHz)	836.500000
Relative permittivity (real part)	41.533550
Relative permittivity (imaginary part)	19.510201
Conductivity (S/m)	0.906682
Variation (%)	2.270000

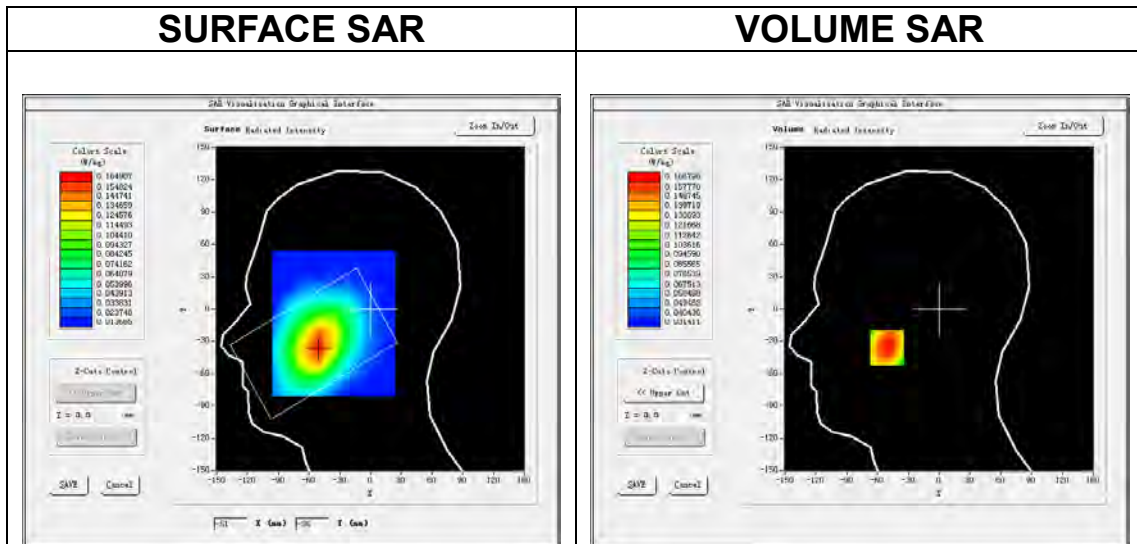

Maximum location: X=-51.00, Y=-36.00

SAR Peak: 0.20 W/kg

SAR 10g (W/Kg)	0.124575
SAR 1g (W/Kg)	0.162912

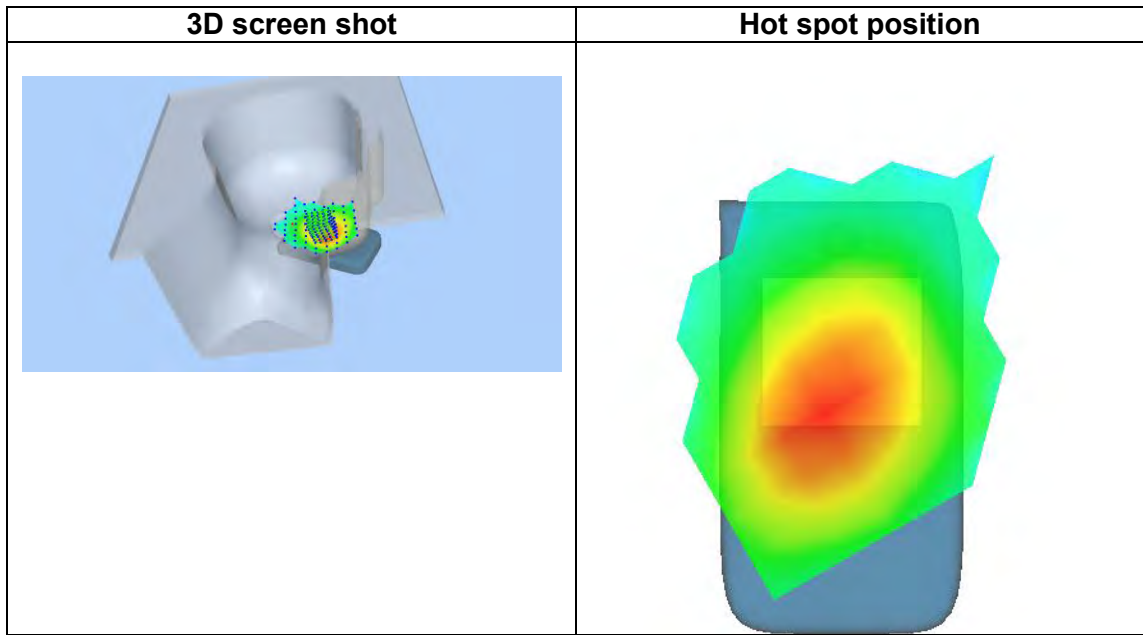
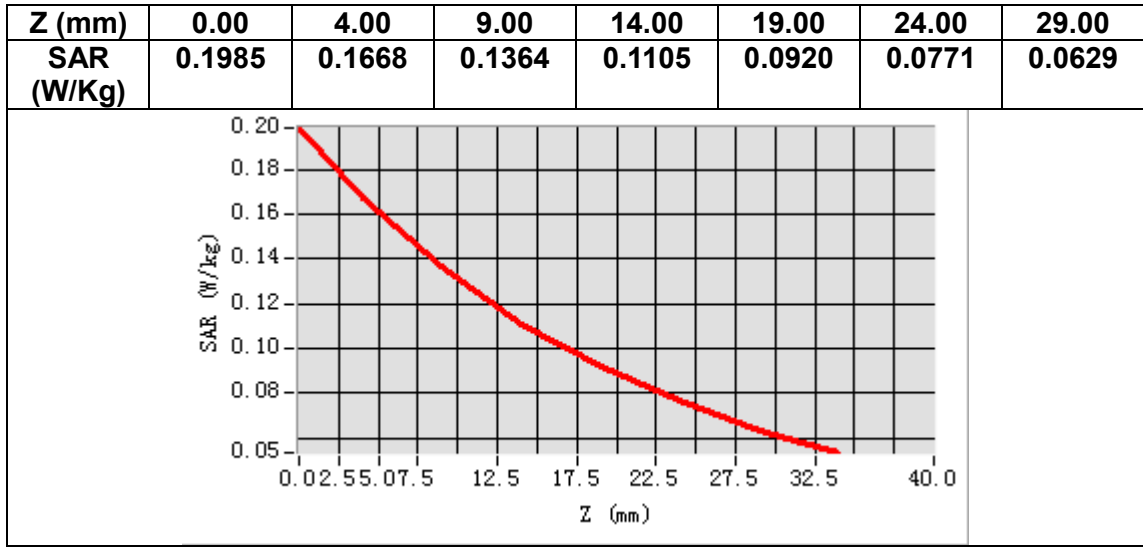

MEASUREMENT 16

A. Experimental conditions.

Area Scan	<u>dx=15mm dy=15mm, h= 5.00 mm</u>
ZoomScan	<u>5x5x7,dx=8mm dy=8mm dz=5mm</u>
Phantom	<u>Validation plane</u>
Device Position	<u>Body</u>
Band	<u>LTE band 5</u>
Channels	<u>Middle</u>
Signal	<u>LTE (Crest factor: 1.0)</u>

B. SAR Measurement Results

Frequency (MHz)	836.500000
Relative permittivity (real part)	54.903500
Relative permittivity (imaginary part)	21.487000
Conductivity (S/m)	0.998549
Variation (%)	1.560000

SURFACE SAR

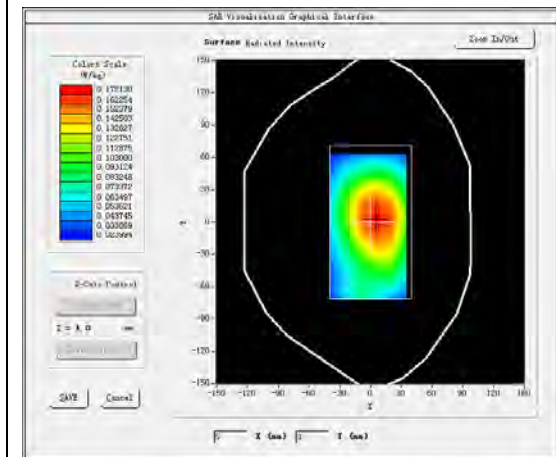

VOLUME SAR

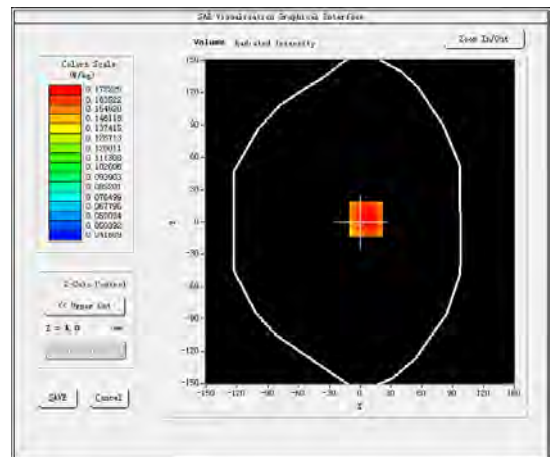

Maximum location: X=6.00, Y=3.00

SAR Peak: 0.21 W/kg

SAR 10g (W/Kg)	0.133694
SAR 1g (W/Kg)	0.171200

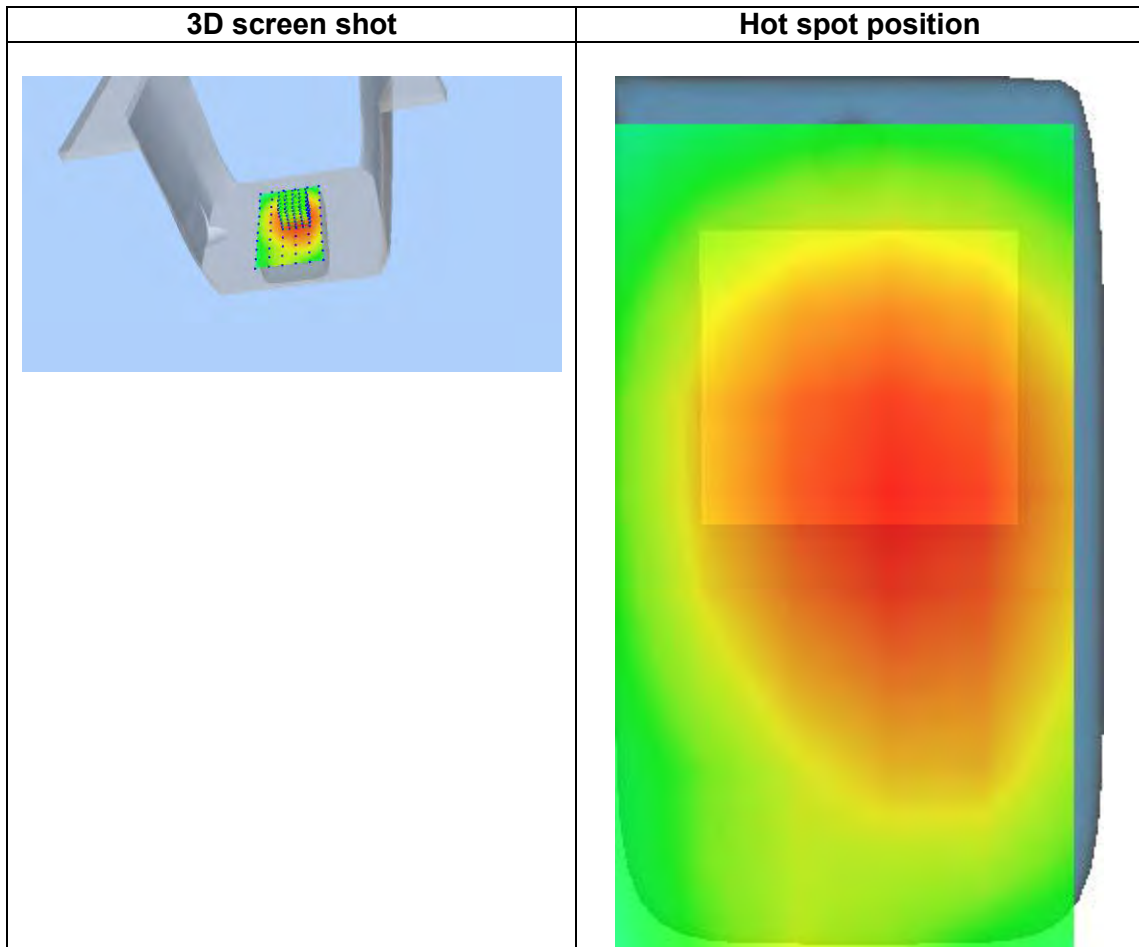
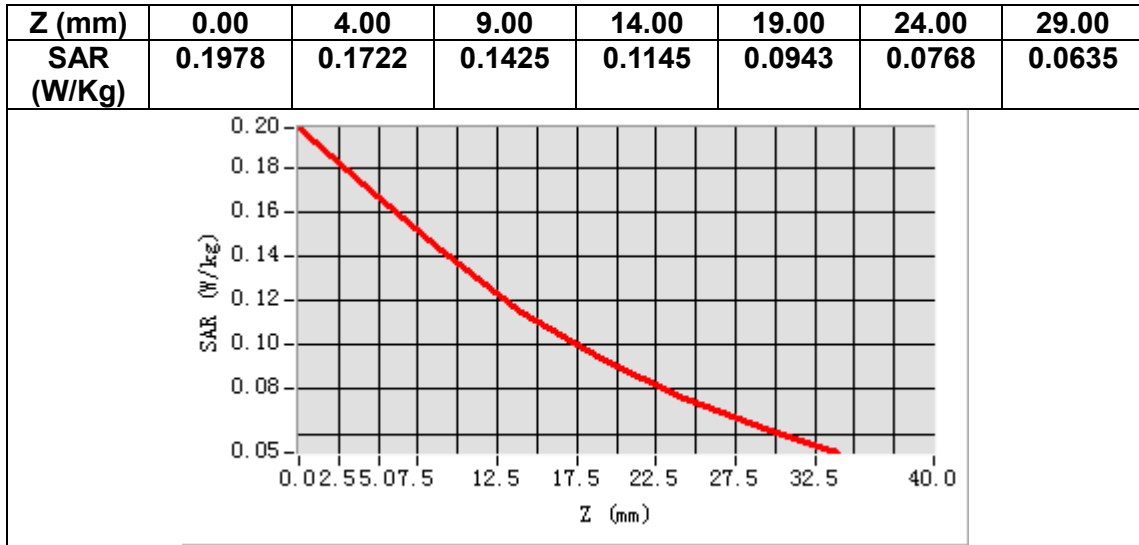

MEASUREMENT 17

A. Experimental conditions.

Area Scan	<u>dx=12mm dy=12mm, h= 5.00 mm</u>
ZoomScan	<u>7x7x7,dx=5mm dy=5mm dz=5mm</u>
Phantom	<u>Left head</u>
Device Position	<u>Cheek</u>
Band	<u>LTE band 7</u>
Channels	<u>Middle</u>
Signal	<u>LTE (Crest factor: 1.0)</u>

B. SAR Measurement Results

Frequency (MHz)	2535.000000
Relative permittivity (real part)	39.355488
Relative permittivity (imaginary part)	13.461160
Conductivity (S/m)	1.895780
Variation (%)	-4.700000

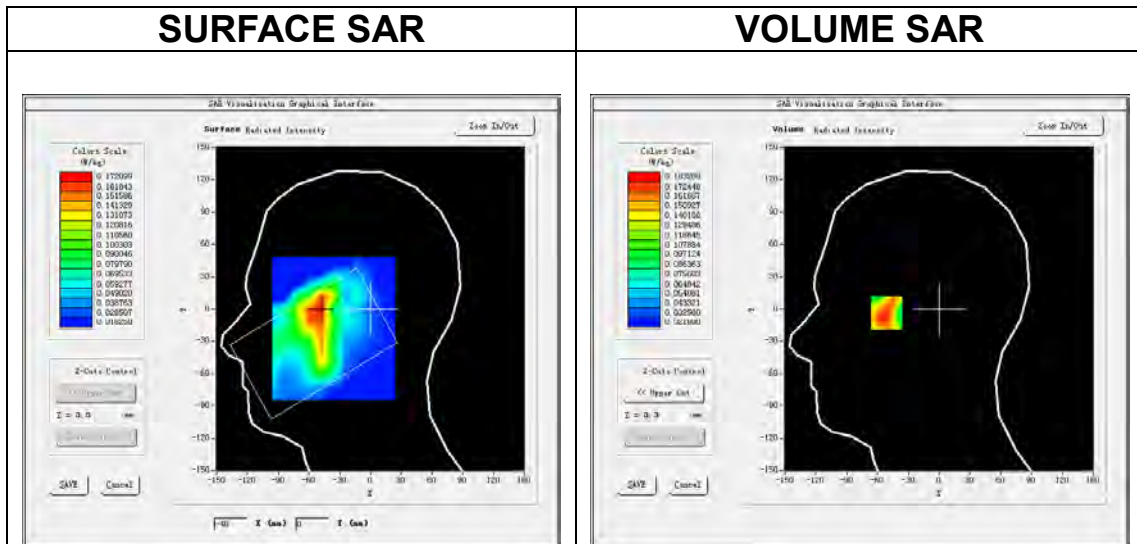

Maximum location: X=-51.00, Y=-1.00

SAR Peak: 0.26 W/kg

SAR 10g (W/Kg)	0.108402
SAR 1g (W/Kg)	0.172594

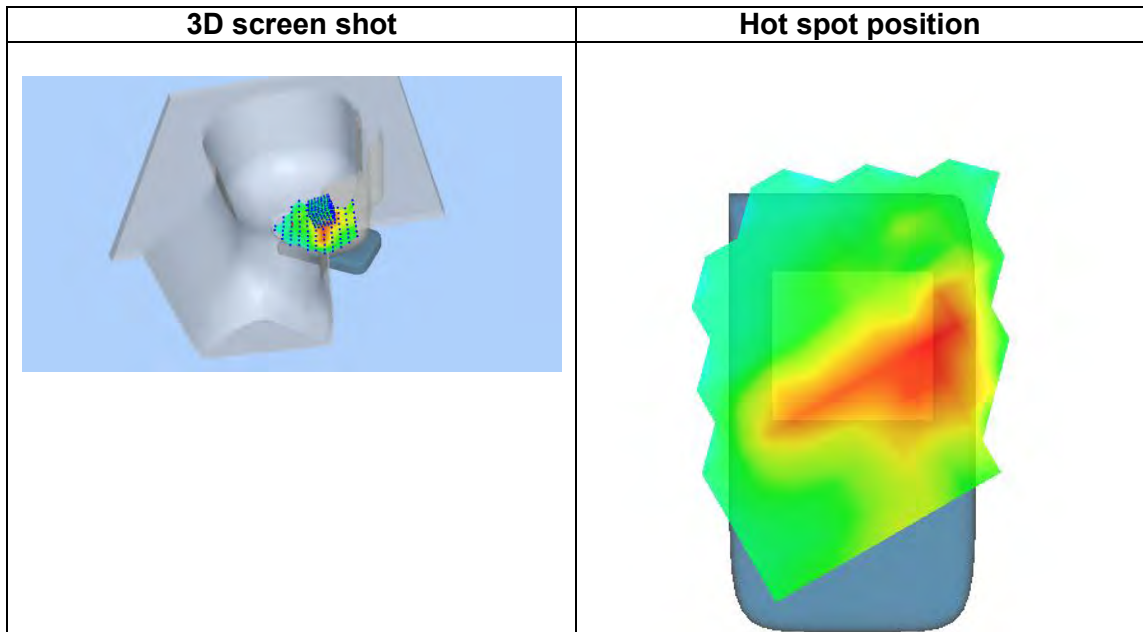
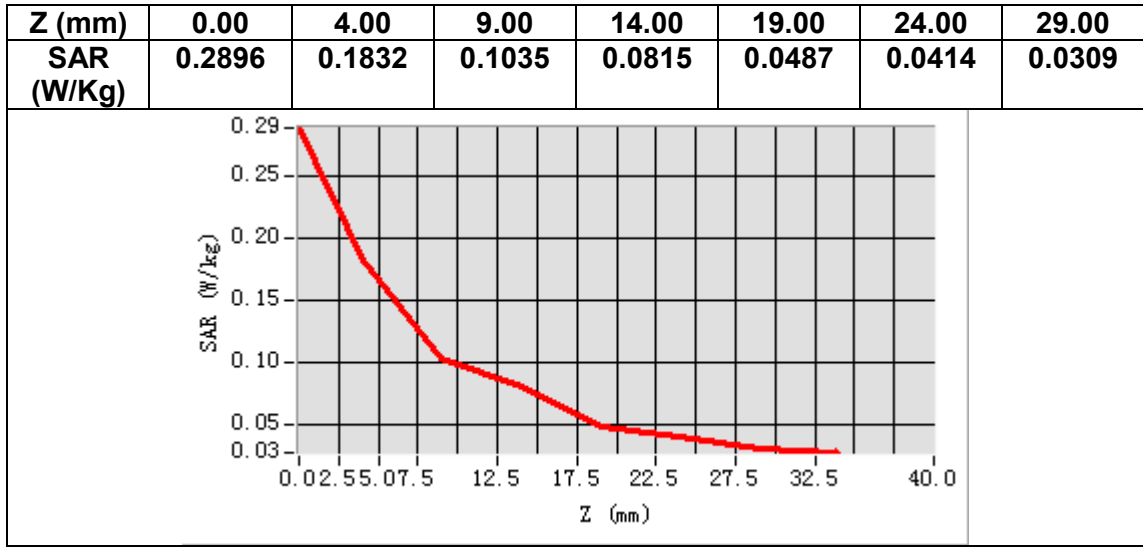

MEASUREMENT 18

A. Experimental conditions.

Area Scan	<u>dx=12mm dy=12mm, h= 5.00 mm</u>
ZoomScan	<u>7x7x7,dx=5mm dy=5mm dz=5mm</u>
Phantom	<u>Validation plane</u>
Device Position	<u>Body</u>
Band	<u>LTE band 7</u>
Channels	<u>Middle</u>
Signal	<u>LTE (Crest factor: 1.0)</u>

B. SAR Measurement Results

Frequency (MHz)	2535.000000
Relative permittivity (real part)	53.416946
Relative permittivity (imaginary part)	14.837840
Conductivity (S/m)	2.089662
Variation (%)	-1.640000

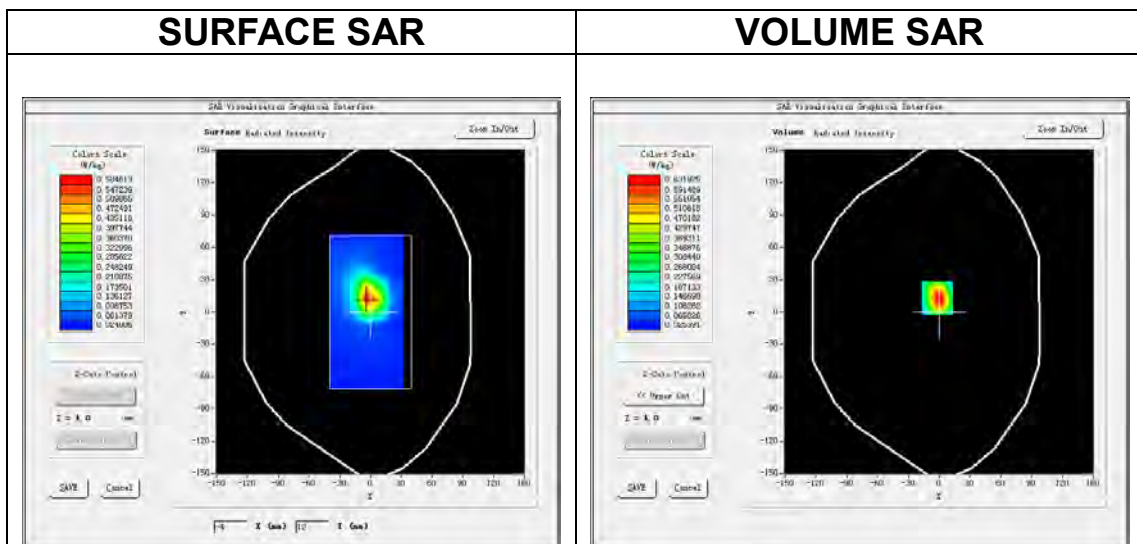

Maximum location: X=-2.00, Y=13.00

SAR Peak: 0.96 W/kg

SAR 10g (W/Kg)	0.307816
SAR 1g (W/Kg)	0.590321

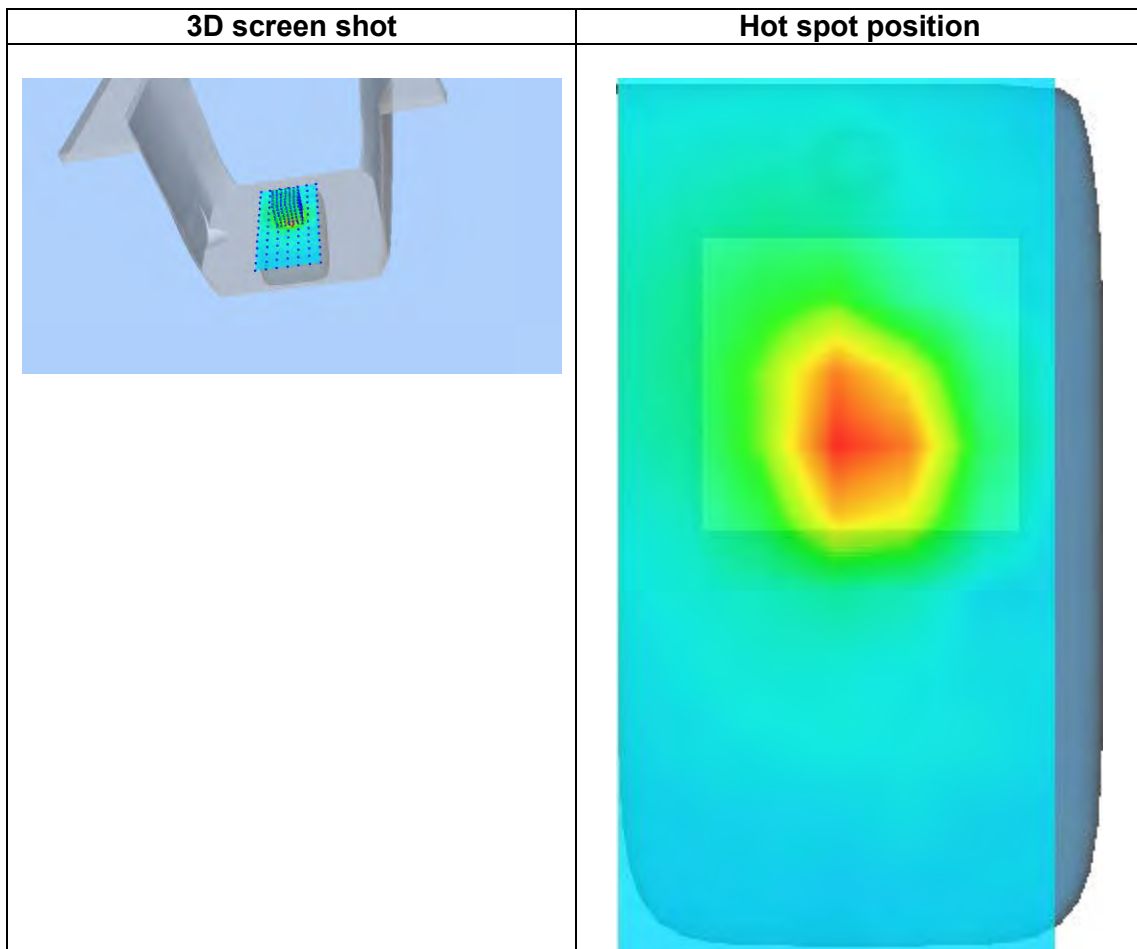
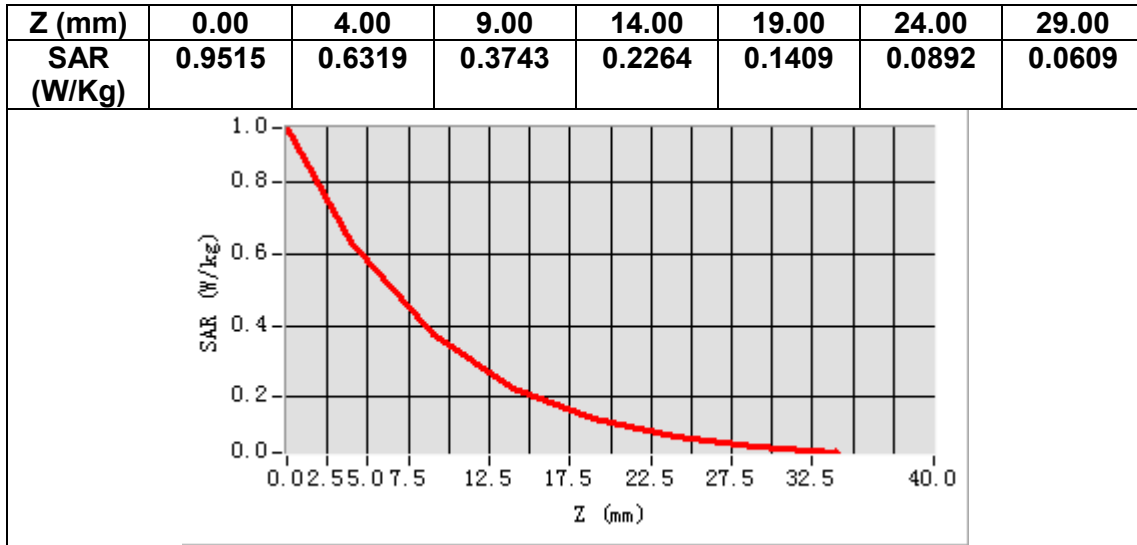

14. Appendix D. Calibration Certificate

Table of contents
E Field Probe - SN 08/16 EPGO287
835 MHz Dipole - SN 03/15 DIP 0G835-347
1800 MHz Dipole - SN 03/15 DIP 1G800-349
1900 MHz Dipole - SN 03/15 DIP 1G900-350
2450 MHz Dipole - SN 03/15 DIP 2G450-352
2600 MHz Dipole - SN 03/15 DIP 2G600-356



COMOSAR E-Field Probe Calibration Report

Ref : ACR.260.1.18.SATU.A

**SHENZHEN NTEK TESTING TECHNOLOGY
CO., LTD.**

**BUILDING E, FENDA SCIENCE PARK, SANWEI
COMMUNITY, XIXIANG STREET,
BAO'AN DISTRICT, SHENZHEN GUANGDONG, CHINA
MVG COMOSAR DOSIMETRIC E-FIELD PROBE
SERIAL NO.: SN 08/16 EPGO287**

**Calibrated at MVG US
2105 Barrett Park Dr. - Kennesaw, GA 30144**



Calibration Date: 09/17/2018

Summary:

This document presents the method and results from an accredited COMOSAR Dosimetric E-Field Probe calibration performed in MVG USA using the CALISAR / CALIBAIR test bench, for use with a COMOSAR system only. All calibration results are traceable to national metrology institutions.



COMOSAR E-FIELD PROBE CALIBRATION REPORT

Ref: ACR.260.1.18.SATU.A

	<i>Name</i>	<i>Function</i>	<i>Date</i>	<i>Signature</i>
<i>Prepared by :</i>	Jérôme LUC	Product Manager	9/17/2018	<i>JL</i>
<i>Checked by :</i>	Jérôme LUC	Product Manager	9/17/2018	<i>JL</i>
<i>Approved by :</i>	Kim RUTKOWSKI	Quality Manager	9/17/2018	<i>Kim Rutkowski</i>

	<i>Customer Name</i>
<i>Distribution :</i>	SHENZHEN NTEK TESTING TECHNOLOGY CO., LTD.

<i>Issue</i>	<i>Date</i>	<i>Modifications</i>
A	9/17/2018	Initial release



COMOSAR E-FIELD PROBE CALIBRATION REPORT

Ref: ACR.260.1.18.SATU.A

TABLE OF CONTENTS

1 Device Under Test 4

2 Product Description 4

 2.1 General Information 4

3 Measurement Method 4

 3.1 Linearity 4

 3.2 Sensitivity 5

 3.3 Lower Detection Limit 5

 3.4 Isotropy 5

 3.5 Boundary Effect 5

4 Measurement Uncertainty 5

5 Calibration Measurement Results 6

 5.1 Sensitivity in air 6

 5.2 Linearity 7

 5.3 Sensitivity in liquid 7

 5.4 Isotropy 8

6 List of Equipment 10



COMOSAR E-FIELD PROBE CALIBRATION REPORT

Ref: ACR.260.1.18.SATU.A

1 DEVICE UNDER TEST

Device Under Test	
Device Type	COMOSAR DOSIMETRIC E FIELD PROBE
Manufacturer	MVG
Model	SSE2
Serial Number	SN 08/16 EPGO287
Product Condition (new / used)	Used
Frequency Range of Probe	0.15 GHz-6GHz
Resistance of Three Dipoles at Connector	Dipole 1: R1=0.209 MΩ Dipole 2: R2=0.196 MΩ Dipole 3: R3=0.197 MΩ

A yearly calibration interval is recommended.

2 PRODUCT DESCRIPTION

2.1 GENERAL INFORMATION

MVG’s COMOSAR E field Probes are built in accordance to the IEEE 1528, OET 65 Bulletin C and CEI/IEC 62209 standards.



Figure 1 – MVG COMOSAR Dosimetric E field Dipole

Probe Length	330 mm
Length of Individual Dipoles	2 mm
Maximum external diameter	8 mm
Probe Tip External Diameter	2.5 mm
Distance between dipoles / probe extremity	1 mm

3 MEASUREMENT METHOD

The IEEE 1528, OET 65 Bulletin C, CENELEC EN50361 and CEI/IEC 62209 standards provide recommended practices for the probe calibrations, including the performance characteristics of interest and methods by which to assess their affect. All calibrations / measurements performed meet the fore mentioned standards.

3.1 LINEARITY

The evaluation of the linearity was done in free space using the waveguide, performing a power sweep to cover the SAR range 0.01W/kg to 100W/kg.



COMOSAR E-FIELD PROBE CALIBRATION REPORT

Ref: ACR.260.1.18.SATU.A

3.2 SENSITIVITY

The sensitivity factors of the three dipoles were determined using a two step calibration method (air and tissue simulating liquid) using waveguides as outlined in the standards.

3.3 LOWER DETECTION LIMIT

The lower detection limit was assessed using the same measurement set up as used for the linearity measurement. The required lower detection limit is 10 mW/kg.

3.4 ISOTROPY

The axial isotropy was evaluated by exposing the probe to a reference wave from a standard dipole with the dipole mounted under the flat phantom in the test configuration suggested for system validations and checks. The probe was rotated along its main axis from 0 - 360 degrees in 15 degree steps. The hemispherical isotropy is determined by inserting the probe in a thin plastic box filled with tissue-equivalent liquid, with the plastic box illuminated with the fields from a half wave dipole. The dipole is rotated about its axis (0°-180°) in 15° increments. At each step the probe is rotated about its axis (0°-360°).

3.5 BOUNDARY EFFECT

The boundary effect is defined as the deviation between the SAR measured data and the expected exponential decay in the liquid when the probe is oriented normal to the interface. To evaluate this effect, the liquid filled flat phantom is exposed to fields from either a reference dipole or waveguide. With the probe normal to the phantom surface, the peak spatial average SAR is measured and compared to the analytical value at the surface.

4 MEASUREMENT UNCERTAINTY

The guidelines outlined in the IEEE 1528, OET 65 Bulletin C, CENELEC EN50361 and CEI/IEC 62209 standards were followed to generate the measurement uncertainty associated with an E-field probe calibration using the waveguide technique. All uncertainties listed below represent an expanded uncertainty expressed at approximately the 95% confidence level using a coverage factor of k=2, traceable to the Internationally Accepted Guides to Measurement Uncertainty.

Uncertainty analysis of the probe calibration in waveguide					
ERROR SOURCES	Uncertainty value (%)	Probability Distribution	Divisor	ci	Standard Uncertainty (%)
Incident or forward power	3.00%	Rectangular	$\sqrt{3}$	1	1.732%
Reflected power	3.00%	Rectangular	$\sqrt{3}$	1	1.732%
Liquid conductivity	5.00%	Rectangular	$\sqrt{3}$	1	2.887%
Liquid permittivity	4.00%	Rectangular	$\sqrt{3}$	1	2.309%
Field homogeneity	3.00%	Rectangular	$\sqrt{3}$	1	1.732%
Field probe positioning	5.00%	Rectangular	$\sqrt{3}$	1	2.887%
Field probe linearity	3.00%	Rectangular	$\sqrt{3}$	1	1.732%
Combined standard uncertainty					5.831%
Expanded uncertainty 95 % confidence level k = 2					12.0%



COMOSAR E-FIELD PROBE CALIBRATION REPORT

Ref: ACR.260.1.18.SATU.A

5 CALIBRATION MEASUREMENT RESULTS

Calibration Parameters	
Liquid Temperature	21 °C
Lab Temperature	21 °C
Lab Humidity	45 %

5.1 SENSITIVITY IN AIR

Normx dipole 1 ($\mu\text{V}/(\text{V}/\text{m})^2$)	Normy dipole 2 ($\mu\text{V}/(\text{V}/\text{m})^2$)	Normz dipole 3 ($\mu\text{V}/(\text{V}/\text{m})^2$)
0.66	0.75	0.58

DCP dipole 1 (mV)	DCP dipole 2 (mV)	DCP dipole 3 (mV)
93	93	98

Calibration curves $e_i=f(V)$ ($i=1,2,3$) allow to obtain H-field value using the formula:

$$E = \sqrt{E_1^2 + E_2^2 + E_3^2}$$

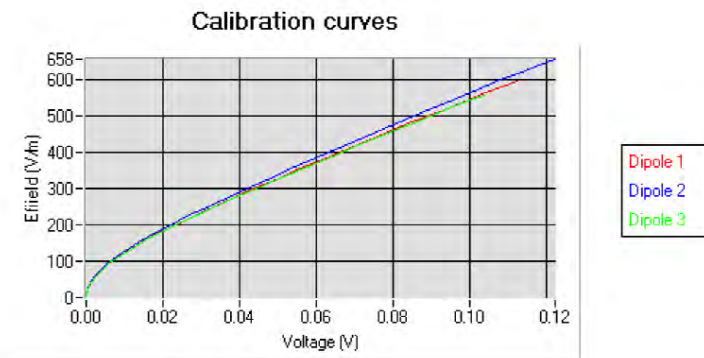



COMOSAR E-FIELD PROBE CALIBRATION REPORT

Ref: ACR.260.1.18.SATU.A

5.2 LINEARITY

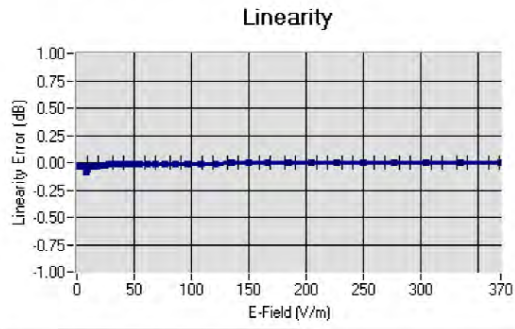

Linearity: $\pm 1.89\%$ ($\pm 0.08\text{dB}$)

5.3 SENSITIVITY IN LIQUID

Liquid	Frequency (MHz +/- 100MHz)	Permittivity	Epsilon (S/m)	ConvF
HL750	750	40.03	0.93	1.45
BL750	750	56.83	1.00	1.49
HL850	835	42.19	0.90	1.50
BL850	835	54.67	1.01	1.56
HL900	900	42.08	1.01	1.51
HL1800	1800	41.68	1.46	1.71
BL1800	1800	53.86	1.46	1.77
HL1900	1900	38.45	1.45	2.03
BL1900	1900	53.32	1.56	2.07
HL2000	2000	38.26	1.38	1.76
HL2450	2450	37.50	1.80	2.00
BL2450	2450	53.22	1.89	2.08
HL2600	2600	39.80	1.99	2.12
BL2600	2600	52.52	2.23	2.19
HL5200	5200	35.64	4.67	2.55
BL5200	5200	48.64	5.51	2.62
HL5400	5400	36.44	4.87	2.53
BL5400	5400	46.52	5.77	2.59
HL5600	5600	36.66	5.17	2.64
BL5600	5600	46.79	5.77	2.73
HL5800	5800	35.31	5.31	2.72
BL5800	5800	47.04	6.10	2.81

LOWER DETECTION LIMIT: 7mW/kg



COMOSAR E-FIELD PROBE CALIBRATION REPORT

Ref: ACR.260.1.18.SATU.A

5.4 ISOTROPY

HL900 MHz

- Axial isotropy: 0.04 dB
- Hemispherical isotropy: 0.07 dB

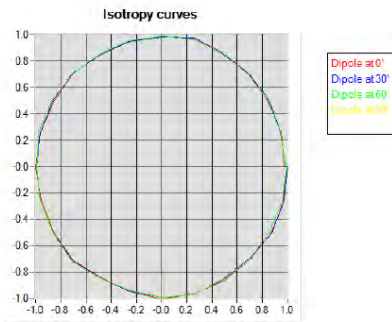

HL1800 MHz

- Axial isotropy: 0.06 dB
- Hemispherical isotropy: 0.08 dB

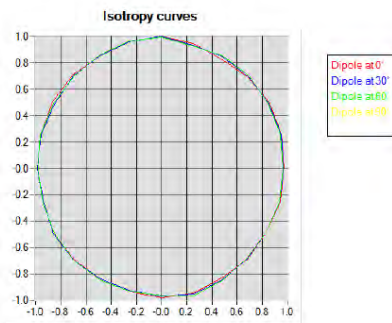



COMOSAR E-FIELD PROBE CALIBRATION REPORT

Ref: ACR.260.1.18.SATU.A

HL5600 MHz

- Axial isotropy: 0.06 dB
- Hemispherical isotropy: 0.08 dB

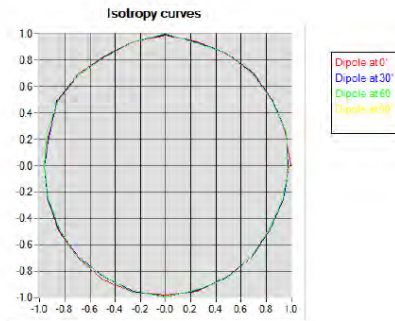



COMOSAR E-FIELD PROBE CALIBRATION REPORT

Ref: ACR.260.1.18.SATU.A

6 LIST OF EQUIPMENT

Equipment Summary Sheet				
Equipment Description	Manufacturer / Model	Identification No.	Current Calibration Date	Next Calibration Date
Flat Phantom	MVG	SN-20/09-SAM71	Validated. No cal required.	Validated. No cal required.
COMOSAR Test Bench	Version 3	NA	Validated. No cal required.	Validated. No cal required.
Network Analyzer	Rhode & Schwarz ZVA	SN100132	02/2016	02/2019
Reference Probe	MVG	EP 94 SN 37/08	10/2017	10/2018
Multimeter	Keithley 2000	1188656	01/2017	01/2020
Signal Generator	Agilent E4438C	MY49070581	01/2017	01/2020
Amplifier	Aethercomm	SN 046	Characterized prior to test. No cal required.	Characterized prior to test. No cal required.
Power Meter	HP E4418A	US38261498	01/2017	01/2020
Power Sensor	HP ECP-E26A	US37181460	01/2017	01/2020
Directional Coupler	Narda 4216-20	01386	Characterized prior to test. No cal required.	Characterized prior to test. No cal required.
Waveguide	Mega Industries	069Y7-158-13-712	Validated. No cal required.	Validated. No cal required.
Waveguide Transition	Mega Industries	069Y7-158-13-701	Validated. No cal required.	Validated. No cal required.
Waveguide Termination	Mega Industries	069Y7-158-13-701	Validated. No cal required.	Validated. No cal required.
Temperature / Humidity Sensor	Control Company	150798832	11/2017	11/2020



SAR Reference Dipole Calibration Report

Ref : ACR.109.2.18.SATU.A

**SHENZHEN NTEK TESTING TECHNOLOGY
CO., LTD.**

**BUILDING E, FENDA SCIENCE PARK, SANWEI
COMMUNITY, XIXIANG STREET,
BAO'AN DISTRICT, SHENZHEN GUANGDONG, CHINA**

MVG COMOSAR REFERENCE DIPOLE

FREQUENCY: 835 MHZ

SERIAL NO.: SN 03/15 DIP 0G835-347

Calibrated at MVG US

2105 Barrett Park Dr. - Kennesaw, GA 30144



Calibration Date: 04/19/2018

Summary:

This document presents the method and results from an accredited SAR reference dipole calibration performed in MVG USA using the COMOSAR test bench. All calibration results are traceable to national metrology institutions.



SAR REFERENCE DIPOLE CALIBRATION REPORT

Ref: ACR.109.2.18.SATU.A

	<i>Name</i>	<i>Function</i>	<i>Date</i>	<i>Signature</i>
<i>Prepared by :</i>	Jérôme LUC	Product Manager	4/19/2018	<i>JL</i>
<i>Checked by :</i>	Jérôme LUC	Product Manager	4/19/2018	<i>JL</i>
<i>Approved by :</i>	Kim RUTKOWSKI	Quality Manager	4/19/2018	<i>Kim Rutkowski</i>

	<i>Customer Name</i>
<i>Distribution :</i>	SHENZHEN NTEK TESTING TECHNOLOGY CO., LTD.

<i>Issue</i>	<i>Date</i>	<i>Modifications</i>
A	4/19/2018	Initial release



SAR REFERENCE DIPOLE CALIBRATION REPORT

Ref: ACR.109.2.18.SATU.A

TABLE OF CONTENTS

1 Introduction 4

2 Device Under Test 4

3 Product Description 4

 3.1 General Information 4

4 Measurement Method 5

 4.1 Return Loss Requirements 5

 4.2 Mechanical Requirements 5

5 Measurement Uncertainty 5

 5.1 Return Loss 5

 5.2 Dimension Measurement 5

 5.3 Validation Measurement 5

6 Calibration Measurement Results 6

 6.1 Return Loss and Impedance In Head Liquid 6

 6.2 Return Loss and Impedance In Body Liquid 6

 6.3 Mechanical Dimensions 6

7 Validation measurement 7

 7.1 Head Liquid Measurement 7

 7.2 SAR Measurement Result With Head Liquid 8

 7.3 Body Liquid Measurement 9

 7.4 SAR Measurement Result With Body Liquid 10

8 List of Equipment 11



SAR REFERENCE DIPOLE CALIBRATION REPORT

Ref: ACR.109.2.18.SATU.A

1 INTRODUCTION

This document contains a summary of the requirements set forth by the IEEE 1528, FCC KDBs and CEI/IEC 62209 standards for reference dipoles used for SAR measurement system validations and the measurements that were performed to verify that the product complies with the fore mentioned standards.

2 DEVICE UNDER TEST

Device Under Test	
Device Type	COMOSAR 835 MHz REFERENCE DIPOLE
Manufacturer	MVG
Model	SID835
Serial Number	SN 03/15 DIP 0G835-347
Product Condition (new / used)	Used

A yearly calibration interval is recommended.

3 PRODUCT DESCRIPTION

3.1 GENERAL INFORMATION

MVG’s COMOSAR Validation Dipoles are built in accordance to the IEEE 1528, FCC KDBs and CEI/IEC 62209 standards. The product is designed for use with the COMOSAR test bench only.



Figure 1 – MVG COMOSAR Validation Dipole



SAR REFERENCE DIPOLE CALIBRATION REPORT

Ref: ACR.109.2.18.SATU.A

4 MEASUREMENT METHOD

The IEEE 1528, FCC KDBs and CEI/IEC 62209 standards provide requirements for reference dipoles used for system validation measurements. The following measurements were performed to verify that the product complies with the fore mentioned standards.

4.1 RETURN LOSS REQUIREMENTS

The dipole used for SAR system validation measurements and checks must have a return loss of -20 dB or better. The return loss measurement shall be performed against a liquid filled flat phantom, with the phantom constructed as outlined in the fore mentioned standards.

4.2 MECHANICAL REQUIREMENTS

The IEEE Std. 1528 and CEI/IEC 62209 standards specify the mechanical components and dimensions of the validation dipoles, with the dimensions frequency and phantom shell thickness dependent. The COMOSAR test bench employs a 2 mm phantom shell thickness therefore the dipoles sold for use with the COMOSAR test bench comply with the requirements set forth for a 2 mm phantom shell thickness.

5 MEASUREMENT UNCERTAINTY

All uncertainties listed below represent an expanded uncertainty expressed at approximately the 95% confidence level using a coverage factor of k=2, traceable to the Internationally Accepted Guides to Measurement Uncertainty.

5.1 RETURN LOSS

The following uncertainties apply to the return loss measurement:

Frequency band	Expanded Uncertainty on Return Loss
400-6000MHz	0.1 dB

5.2 DIMENSION MEASUREMENT

The following uncertainties apply to the dimension measurements:

Length (mm)	Expanded Uncertainty on Length
3 - 300	0.05 mm

5.3 VALIDATION MEASUREMENT

The guidelines outlined in the IEEE 1528, FCC KDBs, CENELEC EN50361 and CEI/IEC 62209 standards were followed to generate the measurement uncertainty for validation measurements.

Scan Volume	Expanded Uncertainty
1 g	20.3 %



SAR REFERENCE DIPOLE CALIBRATION REPORT

Ref: ACR.109.2.18.SATU.A

10 g	20.1 %
------	--------

6 CALIBRATION MEASUREMENT RESULTS

6.1 RETURN LOSS AND IMPEDANCE IN HEAD LIQUID

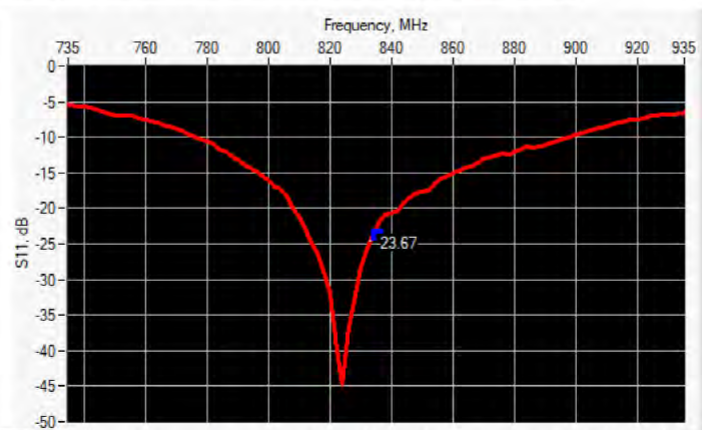

Frequency (MHz)	Return Loss (dB)	Requirement (dB)	Impedance
835	-23.67	-20	56.8 Ω - 1.5 jΩ

6.2 RETURN LOSS AND IMPEDANCE IN BODY LIQUID

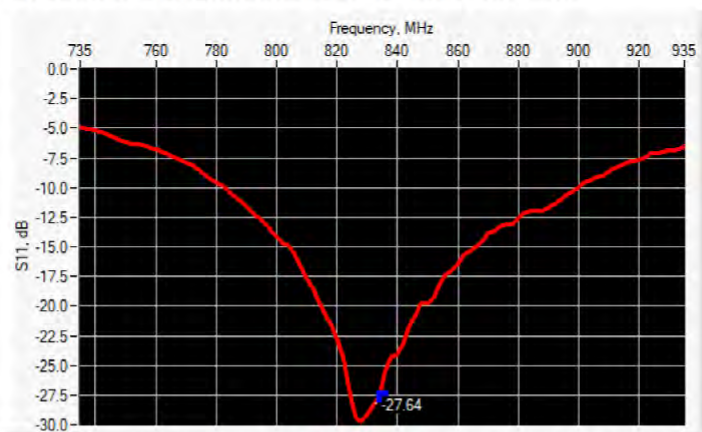

Frequency (MHz)	Return Loss (dB)	Requirement (dB)	Impedance
835	-27.64	-20	53.5 Ω + 2.3 jΩ

6.3 MECHANICAL DIMENSIONS

Frequency MHz	L mm		h mm		d mm	
	required	measured	required	measured	required	measured
300	420.0 ±1 %.		250.0 ±1 %.		6.35 ±1 %.	



SAR REFERENCE DIPOLE CALIBRATION REPORT

Ref: ACR.109.2.18.SATU.A

450	290.0 ±1 %.		166.7 ±1 %.		6.35 ±1 %.	
750	176.0 ±1 %.		100.0 ±1 %.		6.35 ±1 %.	
835	161.0 ±1 %.	PASS	89.8 ±1 %.	PASS	3.6 ±1 %.	PASS
900	149.0 ±1 %.		83.3 ±1 %.		3.6 ±1 %.	
1450	89.1 ±1 %.		51.7 ±1 %.		3.6 ±1 %.	
1500	80.5 ±1 %.		50.0 ±1 %.		3.6 ±1 %.	
1640	79.0 ±1 %.		45.7 ±1 %.		3.6 ±1 %.	
1750	75.2 ±1 %.		42.9 ±1 %.		3.6 ±1 %.	
1800	72.0 ±1 %.		41.7 ±1 %.		3.6 ±1 %.	
1900	68.0 ±1 %.		39.5 ±1 %.		3.6 ±1 %.	
1950	66.3 ±1 %.		38.5 ±1 %.		3.6 ±1 %.	
2000	64.5 ±1 %.		37.5 ±1 %.		3.6 ±1 %.	
2100	61.0 ±1 %.		35.7 ±1 %.		3.6 ±1 %.	
2300	55.5 ±1 %.		32.6 ±1 %.		3.6 ±1 %.	
2450	51.5 ±1 %.		30.4 ±1 %.		3.6 ±1 %.	
2600	48.5 ±1 %.		28.8 ±1 %.		3.6 ±1 %.	
3000	41.5 ±1 %.		25.0 ±1 %.		3.6 ±1 %.	
3500	37.0 ±1 %.		26.4 ±1 %.		3.6 ±1 %.	
3700	34.7 ±1 %.		26.4 ±1 %.		3.6 ±1 %.	

7 VALIDATION MEASUREMENT

The IEEE Std. 1528, FCC KDBs and CEI/IEC 62209 standards state that the system validation measurements must be performed using a reference dipole meeting the fore mentioned return loss and mechanical dimension requirements. The validation measurement must be performed against a liquid filled flat phantom, with the phantom constructed as outlined in the fore mentioned standards. Per the standards, the dipole shall be positioned below the bottom of the phantom, with the dipole length centered and parallel to the longest dimension of the flat phantom, with the top surface of the dipole at the described distance from the bottom surface of the phantom.

7.1 HEAD LIQUID MEASUREMENT

Frequency MHz	Relative permittivity (ε _r)		Conductivity (σ) S/m	
	required	measured	required	measured
300	45.3 ±5 %		0.87 ±5 %	
450	43.5 ±5 %		0.87 ±5 %	
750	41.9 ±5 %		0.89 ±5 %	
835	41.5 ±5 %	PASS	0.90 ±5 %	PASS
900	41.5 ±5 %		0.97 ±5 %	
1450	40.5 ±5 %		1.20 ±5 %	
1500	40.4 ±5 %		1.23 ±5 %	
1640	40.2 ±5 %		1.31 ±5 %	
1750	40.1 ±5 %		1.37 ±5 %	



SAR REFERENCE DIPOLE CALIBRATION REPORT

Ref: ACR.109.2.18.SATU.A

1800	40.0 ±5 %		1.40 ±5 %	
1900	40.0 ±5 %		1.40 ±5 %	
1950	40.0 ±5 %		1.40 ±5 %	
2000	40.0 ±5 %		1.40 ±5 %	
2100	39.8 ±5 %		1.49 ±5 %	
2300	39.5 ±5 %		1.67 ±5 %	
2450	39.2 ±5 %		1.80 ±5 %	
2600	39.0 ±5 %		1.96 ±5 %	
3000	38.5 ±5 %		2.40 ±5 %	
3500	37.9 ±5 %		2.91 ±5 %	

7.2 SAR MEASUREMENT RESULT WITH HEAD LIQUID

The IEEE Std. 1528 and CEI/IEC 62209 standards state that the system validation measurements should produce the SAR values shown below (for phantom thickness of 2 mm), within the uncertainty for the system validation. All SAR values are normalized to 1 W forward power. In bracket, the measured SAR is given with the used input power.

Software	OPENSAR V4
Phantom	SN 20/09 SAM71
Probe	SN 18/11 EPG122
Liquid	Head Liquid Values: eps' : 40.0 sigma : 0.90
Distance between dipole center and liquid	15.0 mm
Area scan resolution	dx=8mm/dy=8mm
Zoon Scan Resolution	dx=8mm/dy=8mm/dz=5mm
Frequency	835 MHz
Input power	20 dBm
Liquid Temperature	21 °C
Lab Temperature	21 °C
Lab Humidity	45 %

Frequency MHz	1 g SAR (W/kg/W)		10 g SAR (W/kg/W)	
	required	measured	required	measured
300	2.85		1.94	
450	4.58		3.06	
750	8.49		5.55	
835	9.56	9.55 (0.95)	6.22	6.10 (0.61)
900	10.9		6.99	
1450	29		16	
1500	30.5		16.8	
1640	34.2		18.4	
1750	36.4		19.3	
1800	38.4		20.1	



SAR REFERENCE DIPOLE CALIBRATION REPORT

Ref: ACR.109.2.18.SATU.A

1900	39.7		20.5	
1950	40.5		20.9	
2000	41.1		21.1	
2100	43.6		21.9	
2300	48.7		23.3	
2450	52.4		24	
2600	55.3		24.6	
3000	63.8		25.7	
3500	67.1		25	
3700	67.4		24.2	

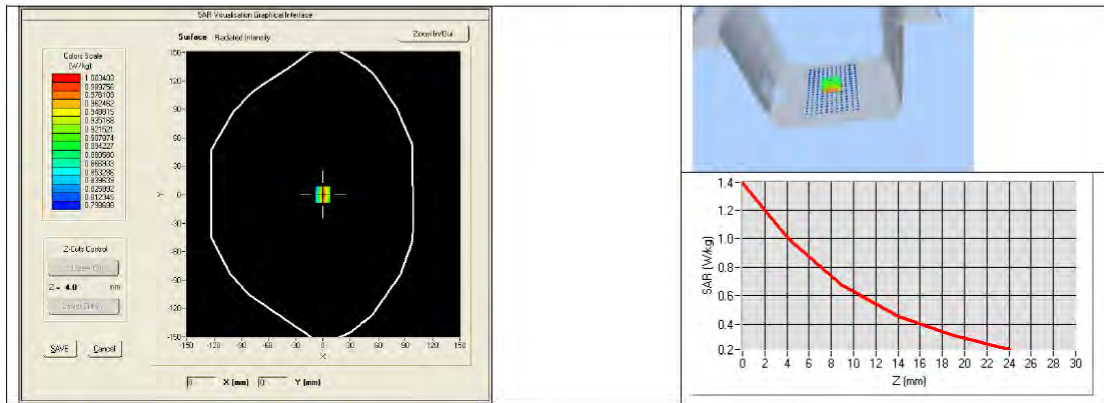

7.3 BODY LIQUID MEASUREMENT

Frequency MHz	Relative permittivity (ϵ_r')		Conductivity (σ) S/m	
	required	measured	required	measured
150	61.9 ± 5 %		0.80 ± 5 %	
300	58.2 ± 5 %		0.92 ± 5 %	
450	56.7 ± 5 %		0.94 ± 5 %	
750	55.5 ± 5 %		0.96 ± 5 %	
835	55.2 ± 5 %	PASS	0.97 ± 5 %	PASS
900	55.0 ± 5 %		1.05 ± 5 %	
915	55.0 ± 5 %		1.06 ± 5 %	
1450	54.0 ± 5 %		1.30 ± 5 %	
1610	53.8 ± 5 %		1.40 ± 5 %	
1800	53.3 ± 5 %		1.52 ± 5 %	
1900	53.3 ± 5 %		1.52 ± 5 %	
2000	53.3 ± 5 %		1.52 ± 5 %	
2100	53.2 ± 5 %		1.62 ± 5 %	

This document shall not be reproduced, except in full or in part, without the written approval of MVG. The information contained herein is to be used only for the purpose for which it is submitted and is not to be released in whole or part without written approval of MVG.



SAR REFERENCE DIPOLE CALIBRATION REPORT

Ref: ACR.109.2.18.SATU.A

2300	52.9 ±5 %		1.81 ±5 %
2450	52.7 ±5 %		1.95 ±5 %
2600	52.5 ±5 %		2.16 ±5 %
3000	52.0 ±5 %		2.73 ±5 %
3500	51.3 ±5 %		3.31 ±5 %
3700	51.0 ±5 %		3.55 ±5 %
5200	49.0 ±10 %		5.30 ±10 %
5300	48.9 ±10 %		5.42 ±10 %
5400	48.7 ±10 %		5.53 ±10 %
5500	48.6 ±10 %		5.65 ±10 %
5600	48.5 ±10 %		5.77 ±10 %
5800	48.2 ±10 %		6.00 ±10 %

7.4 SAR MEASUREMENT RESULT WITH BODY LIQUID

Software	OPENSAR V4
Phantom	SN 20/09 SAM71
Probe	SN 18/11 EPG122
Liquid	Body Liquid Values: eps' : 57.5 sigma : 0.96
Distance between dipole center and liquid	15.0 mm
Area scan resolution	dx=8mm/dy=8mm
Zoon Scan Resolution	dx=8mm/dy=8mm/dz=5mm
Frequency	835 MHz
Input power	20 dBm
Liquid Temperature	21 °C
Lab Temperature	21 °C
Lab Humidity	45 %

Frequency MHz	1 g SAR (W/kg/W)	10 g SAR (W/kg/W)
	measured	measured
835	9.83 (0.98)	6.45 (0.64)

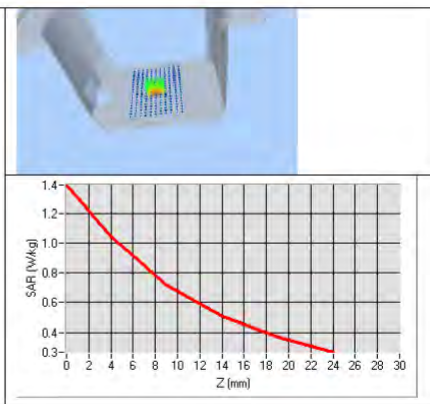
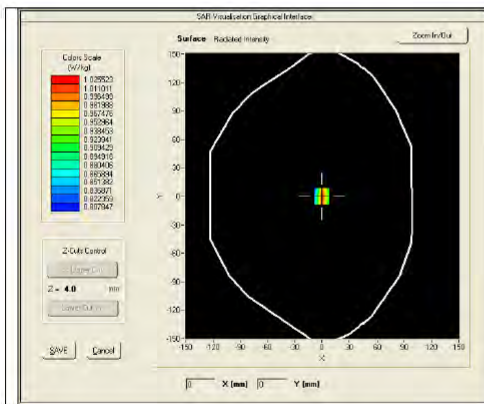



SAR REFERENCE DIPOLE CALIBRATION REPORT

Ref: ACR.109.2.18.SATU.A

8 LIST OF EQUIPMENT

Equipment Summary Sheet				
Equipment Description	Manufacturer / Model	Identification No.	Current Calibration Date	Next Calibration Date
SAM Phantom	MVG	SN-20/09-SAM71	Validated. No cal required.	Validated. No cal required.
COMOSAR Test Bench	Version 3	NA	Validated. No cal required.	Validated. No cal required.
Network Analyzer	Rhode & Schwarz ZVA	SN100132	02/2016	02/2019
Calipers	Carrera	CALIPER-01	01/2017	01/2020
Reference Probe	MVG	EPG122 SN 18/11	10/2017	10/2018
Multimeter	Keithley 2000	1188656	01/2017	01/2020
Signal Generator	Agilent E4438C	MY49070581	01/2017	01/2020
Amplifier	Aethercomm	SN 046	Characterized prior to test. No cal required.	Characterized prior to test. No cal required.
Power Meter	HP E4418A	US38261498	01/2017	01/2020
Power Sensor	HP ECP-E26A	US37181460	01/2017	01/2020
Directional Coupler	Narda 4216-20	01386	Characterized prior to test. No cal required.	Characterized prior to test. No cal required.
Temperature and Humidity Sensor	Control Company	150798832	11/2017	11/2020



SAR Reference Dipole Calibration Report

Ref : ACR.109.4.18.SATU.A

**SHENZHEN NTEK TESTING TECHNOLOGY
CO., LTD.**

**BUILDING E, FENDA SCIENCE PARK, SANWEI
COMMUNITY, XIXIANG STREET,
BAO'AN DISTRICT, SHENZHEN GUANGDONG, CHINA**

MVG COMOSAR REFERENCE DIPOLE

FREQUENCY: 1800 MHZ

SERIAL NO.: SN 03/15 DIP 1G800-349

Calibrated at MVG US

2105 Barrett Park Dr. - Kennesaw, GA 30144



Calibration Date: 04/19/2018

Summary:

This document presents the method and results from an accredited SAR reference dipole calibration performed in MVG USA using the COMOSAR test bench. All calibration results are traceable to national metrology institutions.



SAR REFERENCE DIPOLE CALIBRATION REPORT

Ref: ACR.109.4.18.SATU.A

	<i>Name</i>	<i>Function</i>	<i>Date</i>	<i>Signature</i>
<i>Prepared by :</i>	Jérôme LUC	Product Manager	4/19/2018	<i>JLS</i>
<i>Checked by :</i>	Jérôme LUC	Product Manager	4/19/2018	<i>JLS</i>
<i>Approved by :</i>	Kim RUTKOWSKI	Quality Manager	4/19/2018	<i>Kim Rutkowski</i>

	<i>Customer Name</i>
<i>Distribution :</i>	SHENZHEN NTEK TESTING TECHNOLOGY CO., LTD.

<i>Issue</i>	<i>Date</i>	<i>Modifications</i>
A	4/19/2018	Initial release



SAR REFERENCE DIPOLE CALIBRATION REPORT

Ref: ACR.109.4.18.SATU.A

TABLE OF CONTENTS

1 Introduction 4

2 Device Under Test 4

3 Product Description 4

 3.1 General Information 4

4 Measurement Method 5

 4.1 Return Loss Requirements 5

 4.2 Mechanical Requirements 5

5 Measurement Uncertainty 5

 5.1 Return Loss 5

 5.2 Dimension Measurement 5

 5.3 Validation Measurement 5

6 Calibration Measurement Results 6

 6.1 Return Loss and Impedance In Head Liquid 6

 6.2 Return Loss and Impedance In Body Liquid 6

 6.3 Mechanical Dimensions 6

7 Validation measurement 7

 7.1 Head Liquid Measurement 7

 7.2 SAR Measurement Result With Head Liquid 8

 7.3 Body Liquid Measurement 9

 7.4 SAR Measurement Result With Body Liquid 10

8 List of Equipment 11



SAR REFERENCE DIPOLE CALIBRATION REPORT

Ref: ACR.109.4.18.SATU.A

1 INTRODUCTION

This document contains a summary of the requirements set forth by the IEEE 1528, FCC KDBs and CEI/IEC 62209 standards for reference dipoles used for SAR measurement system validations and the measurements that were performed to verify that the product complies with the fore mentioned standards.

2 DEVICE UNDER TEST

Device Under Test	
Device Type	COMOSAR 1800 MHz REFERENCE DIPOLE
Manufacturer	MVG
Model	SID1800
Serial Number	SN 03/15 DIP 1G800-349
Product Condition (new / used)	Used

A yearly calibration interval is recommended.

3 PRODUCT DESCRIPTION

3.1 GENERAL INFORMATION

MVG’s COMOSAR Validation Dipoles are built in accordance to the IEEE 1528, FCC KDBs and CEI/IEC 62209 standards. The product is designed for use with the COMOSAR test bench only.



Figure 1 – MVG COMOSAR Validation Dipole



SAR REFERENCE DIPOLE CALIBRATION REPORT

Ref: ACR.109.4.18.SATU.A

4 MEASUREMENT METHOD

The IEEE 1528, FCC KDBs and CEI/IEC 62209 standards provide requirements for reference dipoles used for system validation measurements. The following measurements were performed to verify that the product complies with the fore mentioned standards.

4.1 RETURN LOSS REQUIREMENTS

The dipole used for SAR system validation measurements and checks must have a return loss of -20 dB or better. The return loss measurement shall be performed against a liquid filled flat phantom, with the phantom constructed as outlined in the fore mentioned standards.

4.2 MECHANICAL REQUIREMENTS

The IEEE Std. 1528 and CEI/IEC 62209 standards specify the mechanical components and dimensions of the validation dipoles, with the dimensions frequency and phantom shell thickness dependent. The COMOSAR test bench employs a 2 mm phantom shell thickness therefore the dipoles sold for use with the COMOSAR test bench comply with the requirements set forth for a 2 mm phantom shell thickness.

5 MEASUREMENT UNCERTAINTY

All uncertainties listed below represent an expanded uncertainty expressed at approximately the 95% confidence level using a coverage factor of k=2, traceable to the Internationally Accepted Guides to Measurement Uncertainty.

5.1 RETURN LOSS

The following uncertainties apply to the return loss measurement:

Frequency band	Expanded Uncertainty on Return Loss
400-6000MHz	0.1 dB

5.2 DIMENSION MEASUREMENT

The following uncertainties apply to the dimension measurements:

Length (mm)	Expanded Uncertainty on Length
3 - 300	0.05 mm

5.3 VALIDATION MEASUREMENT

The guidelines outlined in the IEEE 1528, FCC KDBs, CENELEC EN50361 and CEI/IEC 62209 standards were followed to generate the measurement uncertainty for validation measurements.

Scan Volume	Expanded Uncertainty
1 g	20.3 %



SAR REFERENCE DIPOLE CALIBRATION REPORT

Ref: ACR.109.4.18.SATU.A

10 g	20.1 %
------	--------

6 CALIBRATION MEASUREMENT RESULTS

6.1 RETURN LOSS AND IMPEDANCE IN HEAD LIQUID

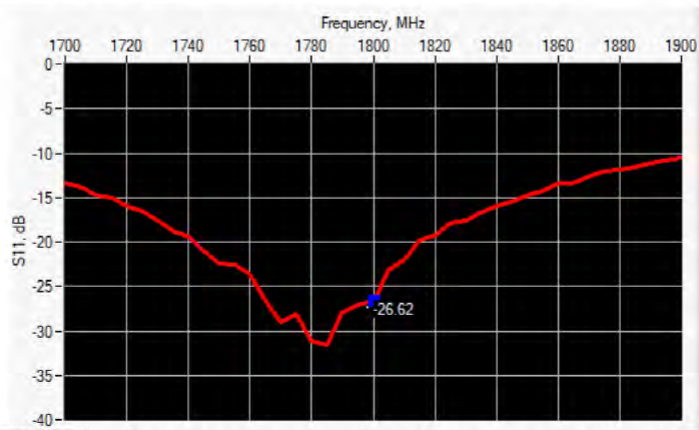

Frequency (MHz)	Return Loss (dB)	Requirement (dB)	Impedance
1800	-26.62	-20	47.3 Ω + 3.6 jΩ

6.2 RETURN LOSS AND IMPEDANCE IN BODY LIQUID

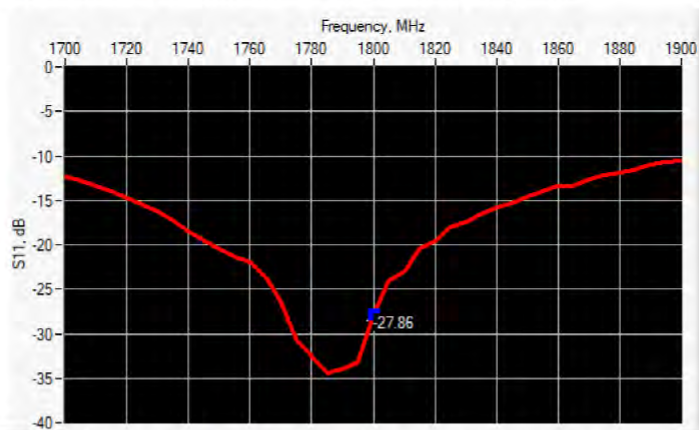

Frequency (MHz)	Return Loss (dB)	Requirement (dB)	Impedance
1800	-27.86	-20	46.2 Ω - 0.9 jΩ

6.3 MECHANICAL DIMENSIONS

Frequency MHz	L mm		h mm		d mm	
	required	measured	required	measured	required	measured
300	420.0 ±1 %.		250.0 ±1 %.		6.35 ±1 %.	