



# FCC REPORT

**Report Reference No.**..... : **TRE1801023801** R/C.....: 50309

**FCC ID**..... : **ZSW-30-063**

**Applicant's name**..... : **b mobile HK Limited**

Address.....: Flat 18; 14/F Block 1; Golden Industrial Building;16-26 Kwai Tak Street; Kwai Chung; New Territories; Hong Kong.

Manufacturer.....: b mobile HK Limited

Address.....: Flat 18; 14/F Block 1; Golden Industrial Building;16-26 Kwai Tak Street; Kwai Chung; New Territories; Hong Kong.

**Test item description** ..... : **Mobile Phone**

Trade Mark .....: Bmobile

Model/Type reference.....: AX925

Listed Model(s) .....: -

**Standard** ..... : **FCC CFR Title 47 Part 2**  
**FCC CFR Title 47 Part 22**  
**FCC CFR Title 47 Part 24**

Date of receipt of test sample.....: Jan.31,2018

Date of testing.....: Feb.01-Mar.06,2018

Date of issue.....: Mar.07,2018

**Result**.....: **Pass**

Compiled by ( position+printedname+signature)....:	File administrators Candy Liu	
Supervised by (position+printedname+signature)....:	Project Engineer Edward Pan	
Approved by (position+printedname+signature)....:	Manager Hans Hu	

**Testing Laboratory Name** ..... : **Shenzhen Huatongwei International Inspection Co., Ltd.**

Address.....: 1/F, Bldg 3, Hongfa Hi-tech Industrial Park, Genyu Road, Tianliao, Gongming, Shenzhen, China

**Shenzhen Huatongwei International Inspection Co., Ltd. All rights reserved.**

This publication may be reproduced in whole or in part for non-commercial purposes as long as the Shenzhen Huatongwei International Inspection Co., Ltd. is acknowledged as copyright owner and source of the material. Shenzhen Huatongwei International Inspection Co., Ltd. takes no responsibility for and will not assume liability for damages resulting from the reader's interpretation of the reproduced material due to its placement and context.

*The test report merely correspond to the test sample.*

## Contents

<b>1.</b>	<b><u>TEST STANDARDS AND REPORT VERSION</u></b>	<b>3</b>
1.1.	Applicable Standards	3
1.2.	Report version	3
<b>2.</b>	<b><u>TEST DESCRIPTION</u></b>	<b>4</b>
<b>3.</b>	<b><u>SUMMARY</u></b>	<b>5</b>
3.1.	Client Information	5
3.2.	Product Description	5
3.3.	Operation state	6
3.4.	EUT configuration	6
3.5.	Modifications	6
<b>4.</b>	<b><u>TEST ENVIRONMENT</u></b>	<b>7</b>
4.1.	Address of the test laboratory	7
4.2.	Test Facility	7
4.3.	Equipments Used during the Test	8
4.4.	Environmental conditions	9
4.5.	Statement of the measurement uncertainty	9
<b>5.</b>	<b><u>TEST CONDITIONS AND RESULTS</u></b>	<b>10</b>
5.1.	Conducted Output Power	10
5.2.	Peak-to-Average Ratio	11
5.3.	99% Occupied Bandwidth & 26 dB Bandwidth	12
5.4.	Band Edge	13
5.5.	Conducted Spurious Emissions	14
5.6.	Frequency stability VS Temperature measurement	15
5.7.	Frequency stability VS Voltage measurement	16
5.8.	ERP and EIRP	17
5.9.	Radiated Spurious Emission	20
<b>6.</b>	<b><u>TEST SETUP PHOTOS</u></b>	<b>24</b>
<b>7.</b>	<b><u>EXTERNAL AND INTERNAL PHOTOS</u></b>	<b>25</b>
<b>8.</b>	<b><u>APPENDIX REPORT</u></b>	<b>31</b>

## 1. TEST STANDARDS AND REPORT VERSION

### 1.1. Applicable Standards

The tests were performed according to following standards:

[FCC Rules Part 2](#):FREQUENCY ALLOCA-TIONS AND RADIO TREATY MAT-TERS; GENERAL RULES AND REG-ULATIONS

[FCC Rules Part 22](#):PRIVATE LAND MOBILE RADIO SERVICES.

[FCC Rules Part 24](#):PUBLIC MOBILE SERVICES

[TIA/EIA 603 E March 2016](#):Land Mobile FM or PM Communications Equipment Measurement and Performance Standards.

[ANSI C63.26-2015](#): American National Standard for Compliance Testing of Transmitters Used in Licensed Radio Services

[KDB 971168 D01 Power Meas License Digital Systems v03](#): MEASUREMENT GUIDANCE FOR CERTIFICATION OF LICENSED DIGITAL TRANSMITTERS

### 1.2. Report version

Revised No.	Date of issue	Description
N/A	Mar.07,2018	Original

## 2. Test Description

Test Item	Section in CFR 47	Result	Test Engineer
Conducted Output Power	Part 2.1046 Part 22.913(a) Part 24.232(c)	Pass	Aaron Fang
Peak-to-Average Ratio	Part 24.232	Pass	Aaron Fang
99% Occupied Bandwidth & 26 dB Bandwidth	Part 2.1049 Part 22.917(b) Part 24.238(b)	Pass	Aaron Fang
Band Edge	Part 2.1051 Part 22.917 Part 24.238	Pass	Aaron Fang
Conducted Spurious Emissions	Part 2.1051 Part 22.917 Part 24.238	Pass	Aaron Fang
Frequency stability VS Temperature	Part 2.1055(a)(1)(b) Part 22.355 Part 24.235	Pass	Aaron Fang
Frequency stability VS Voltage	Part 2.1055(d)(1)(2) Part 22.355 Part 24.235	Pass	Aaron Fang
ERP and EIRP	Part 22.913(a) Part 24.232(b)	Pass	Jiuru Pan
Radiated Spurious Emissions	Part 2.1053 Part 22.917 Part 24.238	Pass	Jiuru Pan

Note: The measurement uncertainty is not included in the test result.

### 3. SUMMARY

#### 3.1. Client Information

Applicant:	b mobile HK Limited
Address:	Flat 18; 14/F Block 1; Golden Industrial Building;16-26 Kwai Tak Street; Kwai Chung; New Territories; Hong Kong.
Manufacturer:	b mobile HK Limited
Address:	Flat 18; 14/F Block 1; Golden Industrial Building;16-26 Kwai Tak Street; Kwai Chung; New Territories; Hong Kong.

#### 3.2. Product Description

Name of EUT:	Mobile Phone
Trade Mark:	Bmobile
Model No.:	AX925
Listed Model(s):	-
IMEI Code:	Conducted: 356038070002605 Radiated: 356038070001722
SIM Information:	Support Two SIM Cards
Hardware version:	ZH193-MB-V0.1
Software version:	SW01
Power supply:	DC 3.8V
Adapter information:	Input:100-240Va.c.,50/60Hz,0.2A Output: 5Vd.c.,1000mA
<b>2G:</b>	
Support Network:	GSM, GPRS, EGPRS
Support Band:	GSM850, PCS1900
Modulation:	GSM/GPRS: GMSK EGPRS: 8PSK
Transmit Frequency:	GSM850: 824.20MHz-848.80MHz PCS1900: 1850.20MHz-1909.80MHz
Receive Frequency:	GSM850: 869.20MHz-893.80MHz PCS1900: 1930.20MHz-1989.80MHz
GPRS Class:	12
EGPRS Class:	12
Antenna type:	Integral Antenna
Antenna gain:	GSM850: -1.2dBi PCS1900: -2.0dBi

### 3.3. Operation state

#### ➤ Test frequency list

GSM850		PCS1900	
Channel	Frequency (MHz)	Channel	Frequency (MHz)
128	824.20	512	1850.20
190	836.60	661	1880.00
251	848.80	810	1909.80

#### ➤ Test mode

Antenna port conducted and radiated test items were performed according to KDB 971168 D01 Power Meas. License Digital Systems v03 and ANSI C63.26-2015 with maximum output power.

Radiated measurements were performed with rotating EUT in different three orthogonal test planes to find the maximum emission.

Radiated emissions were investigated as following frequency range:

30 MHz to 10th harmonic for GSM850, PCS1900.

All modes and data rates and positions were investigated.

Test modes are chosen to be reported as the worst case configuration below:

Test modes		
Band	Radiated	Conducted
<b>GSM 850</b>	<ul style="list-style-type: none"> <li>■ GSM link</li> <li>■ GPRS Class 8 link</li> <li>■ EGPRS Class 8 link</li> </ul>	<ul style="list-style-type: none"> <li>■ GSM link</li> <li>■ GPRS Class 8 link</li> <li>■ EGPRS Class 8 link</li> </ul>
<b>PCS 1900</b>	<ul style="list-style-type: none"> <li>■ GSM link</li> <li>■ GPRS Class 8 link</li> <li>■ EGPRS Class 8 link</li> </ul>	<ul style="list-style-type: none"> <li>■ GSM link</li> <li>■ GPRS Class 8 link</li> <li>■ EGPRS Class 8 link</li> </ul>

The Test EUT support two SIM card(SIM1,SIM2),so all the tests are performed at each SIM card (SIM1,SIM2) mode, the datum recorded is the worst case for all the mode at SIM1 Card mode.

### 3.4. EUT configuration

The following peripheral devices and interface cables were connected during the measurement:

- - supplied by the manufacturer
- - supplied by the lab

○ /	Manufacturer:	/
	Model No.:	/
○ /	Manufacturer:	/
	Model No.:	/

### 3.5. Modifications

No modifications were implemented to meet testing criteria.

## **4. TEST ENVIRONMENT**

### **4.1. Address of the test laboratory**

Laboratory: Shenzhen Huatongwei International Inspection Co., Ltd.

Address: 1/F, Bldg 3, Hongfa Hi-tech Industrial Park, Genyu Road, Tianliao, Gongming, Shenzhen, China

### **4.2. Test Facility**

#### **CNAS-Lab Code: L1225**

Shenzhen Huatongwei International Inspection Co., Ltd. has been assessed and proved to be in compliance with CNAS-CL01 Accreditation Criteria for Testing and Calibration Laboratories (identical to ISO/IEC17025: 2005 General Requirements) for the Competence of Testing and Calibration Laboratories.

#### **A2LA-Lab Cert. No.: 3902.01**

Shenzhen Huatongwei International Inspection Co., Ltd. EMC Laboratory has been accredited by A2LA for technical competence in the field of electrical testing, and proved to be in compliance with ISO/IEC 17025: 2005 General Requirements for the Competence of Testing and Calibration Laboratories and any additional program requirements in the identified field of testing.

#### **FCC-Registration No.: 762235**

Shenzhen Huatongwei International Inspection Co., Ltd. EMC Laboratory has been registered and fully described in a report filed with the FCC (Federal Communications Commission). The acceptance letter from the FCC is maintained in our files.

#### **IC-Registration No.:5377B-1**

Two 3m Alternate Test Site of Shenzhen Huatongwei International Inspection Co., Ltd. has been registered by Certification and Engineering Bureau of Industry Canada for the performance of radiated measurements with Registration No.: 5377B-1.

#### **ACA**

Shenzhen Huatongwei International Inspection Co., Ltd. EMC Laboratory can also perform testing for the Australian C-Tick mark as a result of our A2LA accreditation.

### 4.3. Equipments Used during the Test

RF Conducted Test						
Item	Equipment	Manufacturer	Model No.	Serial No.	Last Cal. (mm-dd-yy)	Next Cal. (mm-dd-yy)
1	Universal Radio Communication	Rohde&Schwarz	CMU200	112012	11/11/2017	11/11/2018
2	Wide Radio communication tester	Rohde&Schwarz	CMW500	137688	10/26/2017	10/25/2018
3	Spectrum Analyzer	Rohde&Schwarz	FSW26	103440	11/11/2017	11/10/2018
4	MXA Signal Analyzer	Agilent	N9020A	MY5050187	11/10/2017	11/09/2018
5	Splitter	Mini-Circuit	ZAPD-4	400059	03/20/2017	03/19/2018
6	Climate Chamber	ESPEC	EL-10KA	05107008	11/10/2017	11/09/2018

Radiated Emissions						
Item	Equipment	Manufacturer	Model No.	Serial No.	Last Cal. (mm-dd-yy)	Next Cal. (mm-dd-yy)
1	EMI Test Receiver	R&S	ESCI	101247	11/11/2017	11/10/2018
2	Loop Antenna	R&S	HFH2-Z2	100020	11/20/2017	11/19/2018
3	Ultra-Broadband Antenna	SCHWARZBECK	VULB9163	538	4/5/2017	4/4/2020
4	Preamplifier	SCHWARZBECK	BBV 9743	9743-0022	10/18/2017	10/17/2018
5	RF Connection Cable	HUBER+SUHNER	RE-7-FL	N/A	11/21/2017	11/20/2018
6	EMI Test Software	R&S	ESK1	N/A	N/A	N/A
7	Spectrum Analyzer	R&S	FSP40	100597	11/11/2017	11/10/2018
8	Horn Antenna	SCHWARZBECK	9120D	1011	3/27/2017	3/26/2020
9	Horn Antenna	SCHWARZBECK	BBHA9170	25841	3/27/2017	3/26/2018
10	Broadband Preamplifier	SCHWARZBECK	BBV 9718	9718-248	10/18/2017	10/17/2018
11	High pass filter	Compliance Direction systems	BSU-6	34202	11/11/2017	11/10/2018
12	RF Connection Cable	HUBER+SUHNER	RE-7-FH	N/A	11/21/2017	11/20/2018
13	Signal Generator	Rohde&Schwarz	SMB100A	114360	06/13/2017	06/12/2018
14	Universal Radio Communication	Rohde&Schwarz	CMU200	112012	11/11/2017	11/11/2018
15	Wide Radio communication tester	Rohde&Schwarz	CMW500	137688	10/26/2017	10/25/2018
16	EMI Test Software	Audix	E3	N/A	N/A	N/A
17	Turntable	MATURO	TT2.0	N/A	N/A	N/A
18	Antenna Mast	MATURO	TAM-4.0-P	N/A	N/A	N/A



#### 4.4. Environmental conditions

During the measurement the environmental conditions were within the listed ranges:

Voltage	VN=Nominal Voltage	DC 3.80V
	VL=Lower Voltage	DC 3.60V
	VH=Higher Voltage	DC 4.35V
Temperature	TN=Normal Temperature	25 °C
	Extreme Temperature	From -30° to + 50° centigrade
Humidity	30~60 %	
Air Pressure	950-1050 hPa	

#### 4.5. Statement of the measurement uncertainty

The data and results referenced in this document are true and accurate. The reader is cautioned that there may be errors within the calibration limits of the equipment and facilities. The measurement uncertainty was calculated for all measurements listed in this test report acc. to TR-100028-01 "Electromagnetic compatibility and Radio spectrum Matters (ERM); Uncertainties in the measurement of mobile radio equipment characteristics; Part 1" and TR-100028-02 "Electromagnetic compatibility and Radio spectrum Matters (ERM); Uncertainties in the measurement of mobile radio equipment characteristics; Part 2" and is documented in the Shenzhen Huatongwei International Inspection Co., Ltd quality system acc. to DIN EN ISO/IEC 17025. Furthermore, component and process variability of devices similar to that tested may result in additional deviation. The manufacturer has the sole responsibility of continued compliance of the device.

Hereafter the best measurement capability for Shenzhen Huatongwei laboratory is reported:

Test Items	Measurement Uncertainty	Notes
Frequency stability	25 Hz	(1)
Transmitter power conducted	0.57 dB	(1)
Transmitter power Radiated	2.20 dB	(1)
Conducted spurious emission 9KHz-12.75 GHz	1.60 dB	(1)
Conducted Emission 9KHz-30MHz	3.39 dB	(1)
Radiated Emission 30~1000MHz	4.24 dB	(1)
Radiated Emission 1~18GHz	5.16 dB	(1)
Radiated Emission 18-40GHz	5.54 dB	(1)
Occupied Bandwidth	-----	(1)

(1) This uncertainty represents an expanded uncertainty expressed at approximately the 95% confidence level using a coverage factor of  $k=1.96$ .

## 5. TEST CONDITIONS AND RESULTS

### 5.1. Conducted Output Power

**LIMIT**

N/A

**TEST CONFIGURATION****TEST PROCEDURE**

1. The EUT output port was connected to communication tester.
2. Set EUT at maximum power through communication tester.
3. Select lowest, middle, and highest channels for each band and different modulation.
4. Measure the maximum burst average power.

**TEST MODE:**

Please refer to the clause 3.3

**TEST RESULTS** **Passed**       **Not Applicable**

Refer to appendix A on the section 8 appendix report

## 5.2. Peak-to-Average Ratio

### LIMIT

13dB

### TEST CONFIGURATION



### TEST PROCEDURE

1. The EUT was connected to the spectrum analyzer and communication tester via a power splitter
2. Set EUT in maximum power output.
3. Center Frequency = Carrier frequency, RBW > Emission bandwidth of signal
4. The signal analyzer was set to collect one million samples to generate the CCDF curve
5. The measurement interval was set depending on the type of signal analyzed.
  - i. For continuous signals (>98% duty cycle), the measurement interval was set to 1ms.
  - ii. For burst transmissions, the spectrum analyzer is set to use an internal "RF Burst" trigger that is synced with an incoming pulse and the measurement interval is set to less than the duration of the "on time" of one burst to ensure that energy is only captured during a time in which the transmitter is operating at maximum power
6. Record the maximum PAPR level associated with a probability of 0.1%.

### TEST MODE:

Please refer to the clause 3.3

### TEST RESULTS

Passed       Not Applicable

Refer to appendix B on the section 8 appendix report

### 5.3. 99% Occupied Bandwidth & 26 dB Bandwidth

**LIMIT**

N/A

**TEST CONFIGURATION****TEST PROCEDURE**

1. The EUT was connected to the spectrum analyzer and communication tester via a power splitter
2. Set EUT in maximum power output.
3. Spectrum analyzer setting as follow:  
Center Frequency= Carrier frequency, RBW=1% to 5% of anticipated OBW, VBW= 3 \* RBW,  
Detector=Peak,  
Trace maximum hold.
4. Record the value of 99% Occupied bandwidth and -26dB bandwidth.

**TEST MODE:**

Please refer to the clause 3.3

**TEST RESULTS** **Passed**       **Not Applicable**

Refer to appendix C on the section 8 appendix report

## 5.4. Band Edge

### LIMIT

Part 24.238 and Part 22.917 specify that the power of any emission outside of the authorized operating frequency ranges must be attenuated below the transmitting power (P) by a factor of at least  $43 + 10 \log(P)$  dB.

The specification that emissions shall be attenuated below the transmitter power (P) by at least  $43 + 10 \log(P)$  dB, translates in the relevant power range (1 to 0.001 W) to -13 dBm. At 1 W the specified minimum attenuation becomes 43 dB and relative to a 30 dBm (1 W) carrier becomes a limit of -13 dBm. At 0.001 W (0 dBm) the minimum attenuation is 13 dB, which again yields a limit of -13 dBm. In this way a translation of the specification from relative to absolute terms is carried out.

### TEST CONFIGURATION



### TEST PROCEDURE

1. The EUT was connected to the spectrum analyzer and communication tester via a power splitter
2. Set EUT in maximum power output.
3. The band edges of low and high channels were measured.
4. Spectrum analyzer setting as follow:  
RBW=3KHz, VBW = 10KHz, Sweep time= Auto
5. Record the test plot.

### TEST MODE:

Please refer to the clause 3.3

### TEST RESULTS

Passed       Not Applicable

Refer to appendix D on the section 8 appendix report

## 5.5. Conducted Spurious Emissions

### LIMIT

Part 24.238 and Part 22.917 specify that the power of any emission outside of the authorized operating frequency ranges must be attenuated below the transmitting power (P) by a factor of at least  $43 + 10 \log(P)$  dB.

The specification that emissions shall be attenuated below the transmitter power (P) by at least  $43 + 10 \log(P)$  dB, translates in the relevant power range (1 to 0.001 W) to -13 dBm. At 1 W the specified minimum attenuation becomes 43 dB and relative to a 30 dBm (1 W) carrier becomes a limit of -13 dBm. At 0.001 W (0 dBm) the minimum attenuation is 13 dB, which again yields a limit of -13 dBm. In this way a translation of the specification from relative to absolute terms is carried out.

### TEST CONFIGURATION

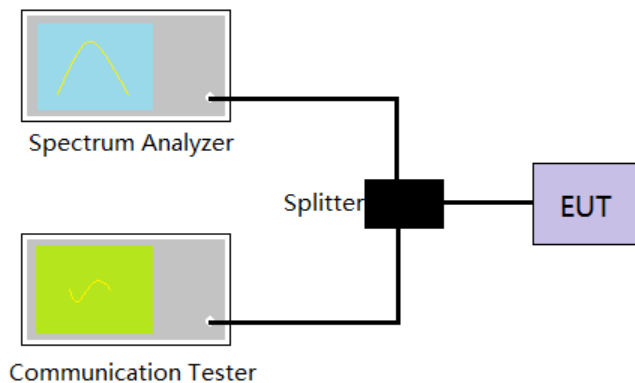

### TEST PROCEDURE

1. The EUT was connected to the spectrum analyzer and communication tester via a power splitter
2. Set EUT in maximum power output.
3. Spectrum analyzer setting as follow:  
Below 1GHz, RBW=100KHz, VBW = 300KHz, Detector=Peak, Sweep time= Auto  
Above 1GHz, RBW=1MHz, VBW=3MHz, Detector=Peak, Sweep time= Auto  
Scan frequency range up to 10<sup>th</sup> harmonic.
4. Record the test plot.

### TEST MODE:

Please refer to the clause 3.3

### TEST RESULTS

Passed       Not Applicable

Refer to appendix E on the section 8 appendix report

## 5.6. Frequency stability VS Temperature measurement

### LIMIT

2.5ppm

### TEST CONFIGURATION



### TEST PROCEDURE

1. The equipment under test was connected to an external DC power supply and input rated voltage.
2. The EUT output port was connected to communication tester.
3. The EUT was placed inside the temperature chamber.
4. Turn EUT off and set the chamber temperature to  $-30^{\circ}\text{C}$ . After the temperature stabilized for approximately 30 minutes recorded the frequency.
5. Repeat step 4 measure with  $10^{\circ}\text{C}$  increased per stage until the highest temperature of  $+50^{\circ}\text{C}$  reached.

### TEST MODE:

Please refer to the clause 3.3

### TEST RESULTS

Passed       Not Applicable

Refer to appendix F on the section 8 appendix report

## 5.7. Frequency stability VS Voltage measurement

### LIMIT

2.5ppm

### TEST CONFIGURATION



### TEST PROCEDURE

1. The equipment under test was connected to an external DC power supply and input rated voltage.
2. The EUT output port was connected to communication tester.
3. The EUT was placed inside the temperature chamber at 25°C
4. The power supply voltage to the EUT was varied  $\pm 15\%$  of the nominal value measured at the input to the EUT
5. Record the maximum frequency change.

### TEST MODE:

Please refer to the clause 3.3

### TEST RESULTS

Passed       Not Applicable

Refer to appendix F on the section 8 appendix report



## 5.8. ERP and EIRP

### LIMIT

GSM850: 7W (38.45dBm) ERP

PCS1900: 2W (33dBm) EIRP

### TEST CONFIGURATION

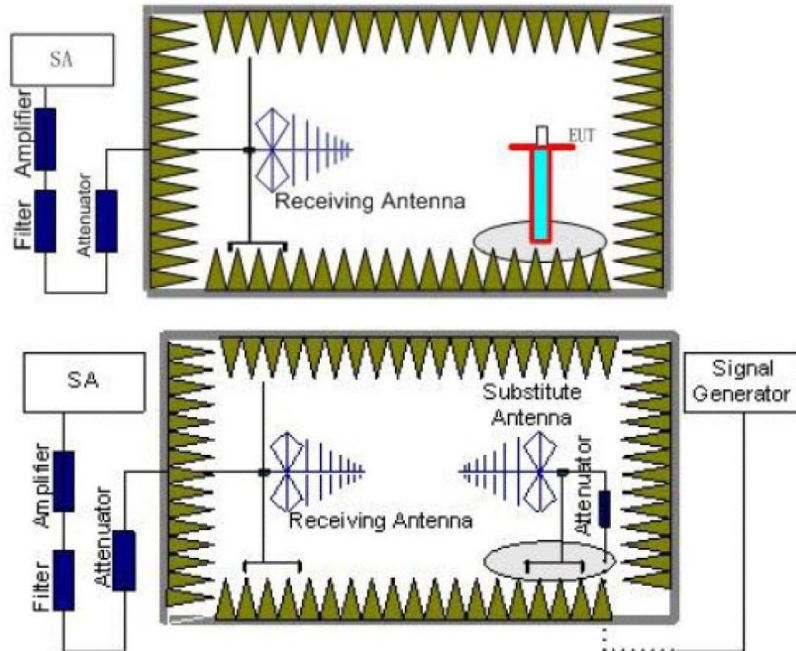

### TEST PROCEDURE

1. EUT was placed on a 0.8 meter for below 1GHz and 1.5 meter for above 1GHz high non-conductive stand at a 3 meter test distance from the receive antenna. A receiving antenna was placed on the antenna mast 3 meters from the EUT for emission measurements. The height of receiving antenna is 1.0m. Detected emissions were maximized at each frequency by rotating the EUT through 360° and adjusting the receiving antenna polarization. The radiated emission measurements of all transmit frequencies in three channels (High, Middle, Low) were measured with peak detector.
2. A log-periodic antenna or double-ridged waveguide horn antenna shall be substituted in place of the EUT. The log-periodic antenna will be driven by a signal generator and the level will be adjusted till the same power value on the spectrum analyzer or receiver. The level of the spurious emissions can be calculated through the level of the signal generator, cable loss, the gain of the substitution antenna and the reading of the spectrum analyzer or receiver.
3. The EUT is then put into continuously transmitting mode at its maximum power level during the test. Set Test Receiver or Spectrum RBW=1MHz, VBW=3MHz for above 1GHz and RBW=100kHz, VBW=300kHz for 30MHz to 1GHz, and the maximum value of the receiver should be recorded as (Pr).
4. The EUT shall be replaced by a substitution antenna. In the chamber, an substitution antenna for the frequency band of interest is placed at the reference point of the chamber. An RF Signal source for the frequency band of interest is connected to the substitution antenna with a cable that has been constructed to not interfere with the radiation pattern of the antenna. A power (PMea) is applied to the input of the substitution antenna, and adjust the level of the signal generator output until the value of the receiver reach the previously recorded (Pr). The power of signal source (PMea) is recorded. The test should be performed by rotating the test item and adjusting the receiving antenna polarization.
5. A amplifier should be connected to the Signal Source output port. And the cable should be connect between the Amplifier and the Substitution Antenna. The cable loss (Pcl), the Substitution Antenna Gain (G<sub>a</sub>) and the Amplifier Gain (P<sub>Ag</sub>) should be recorded after test.

6. The measurement results are obtained as described below:

Power(EIRP)=PMea- PAg - Pcl + Ga

We used SMF100A micowave signal generator which signal level can up to 33dBm,so we not used power Amplifier for substitution test; The measurement results are amend as described below:

Power(EIRP)=PMea- Pcl + Ga

7. This value is EIRP since the measurement is calibrated using an antenna of known gain (2.15 dBi) and known input power.

ERP can be calculated from EIRP by subtracting the gain of the dipole, ERP = EIRP-2.15dBi.

### **TEST MODE:**

Please refer to the clause 3.3

### **TEST RESULTS**

**Passed**       **Not Applicable**

Mode	Channel	Antenna Pol.	ERP	Limit (dBm)	Result
GSM850	128	V	30.78	<38.45	Pass
		H	24.75		
	190	V	32.39		
		H	24.71		
	251	V	31.09		
		H	26.05		
GPRS850	128	V	30.45	<38.45	Pass
		H	24.29		
	190	V	32.15		
		H	24.51		
	251	V	30.87		
		H	25.78		
EGPRS850	128	V	24.98	<38.45	Pass
		H	21.03		
	190	V	25.99		
		H	21.38		
	251	V	24.16		
		H	20.31		

Mode	Channel	Antenna Pol.	EIRP	Limit (dBm)	Result
PCS1900	512	V	26.27	<33.00	Pass
		H	20.63		
	661	V	27.73		
		H	24.60		
	810	V	26.93		
		H	25.27		
GPRS1900	512	V	25.68	<33.00	Pass
		H	20.32		
	661	V	27.48		
		H	23.98		
	810	V	26.57		
		H	25.11		
EGPRS1900	512	V	23.15	<33.00	Pass
		H	17.36		
	661	V	24.17		
		H	18.33		
	810	V	23.16		
		H	17.94		

## 5.9. Radiated Spurious Emission

### LIMIT

-13dBm

### TEST CONFIGURATION

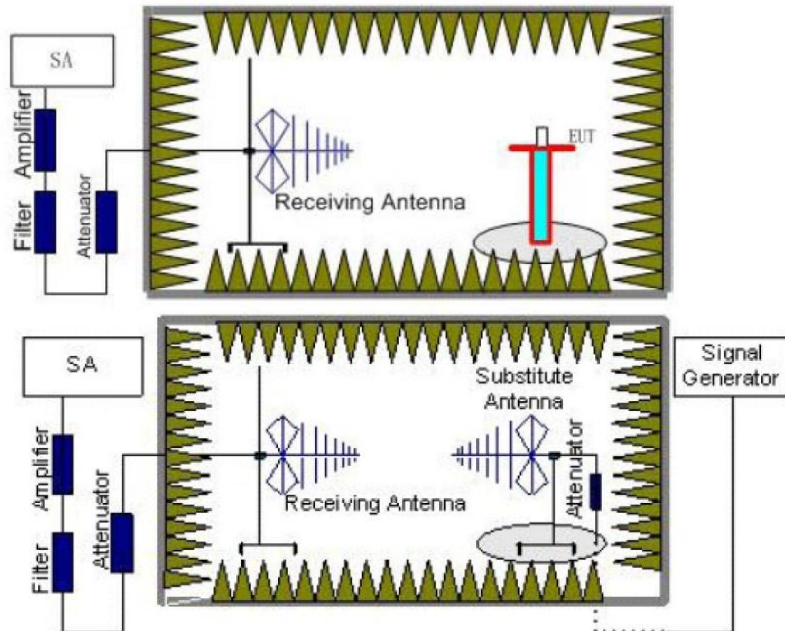

### TEST RESULTS

1. EUT was placed on a 0.8 meter for below 1GHz and 1.5 meter for above 1GHz high non-conductive stand at a 3 meter test distance from the receive antenna. A receiving antenna was placed on the antenna mast 3 meters from the EUT for emission measurements. The height of receiving antenna is 1.0m. Detected emissions were maximized at each frequency by rotating the EUT through 360° and adjusting the receiving antenna polarization. The radiated emission measurements of all transmit frequencies in three channels (High, Middle, Low) were measured with peak detector.
2. A log-periodic antenna or double-ridged waveguide horn antenna shall be substituted in place of the EUT. The log-periodic antenna will be driven by a signal generator and the level will be adjusted till the same power value on the spectrum analyzer or receiver. The level of the spurious emissions can be calculated through the level of the signal generator, cable loss, the gain of the substitution antenna and the reading of the spectrum analyzer or receiver.
3. The EUT is then put into continuously transmitting mode at its maximum power level during the test. Set Test Receiver or Spectrum RBW=1MHz, VBW=3MHz for above 1GHz and RBW=100kHz, VBW=300kHz for 30MHz to 1GHz, And the maximum value of the receiver should be recorded as (Pr).
4. The EUT shall be replaced by a substitution antenna. In the chamber, an substitution antenna for the frequency band of interest is placed at the reference point of the chamber. An RF Signal source for the frequency band of interest is connected to the substitution antenna with a cable that has been constructed to not interfere with the radiation pattern of the antenna. A power (PMea) is applied to the input of the substitution antenna, and adjust the level of the signal generator output until the value of the receiver reach the previously recorded (Pr). The power of signal source (PMea) is recorded. The test should be performed by rotating the test item and adjusting the receiving antenna polarization.
5. A amplifier should be connected to the Signal Source output port. And the cable should be connect between the Amplifier and the Substitution Antenna. The cable loss (Pcl), the Substitution Antenna Gain (Ga) and the Amplifier Gain (PAg) should be recorded after test.

6. The measurement results are obtained as described below:  
Power(EIRP)=PMea- PAg - Pcl + Ga  
We used SMF100A micowave signal generator which signal level can up to 33dBm,so we not used power Amplifier for substitution test; The measurement results are amend as described below:  
Power(EIRP)=PMea- Pcl + Ga
7. This value is EIRP since the measurement is calibrated using an antenna of known gain (2.15 dBi) and known input power.  
ERP can be calculated from EIRP by subtracting the gain of the dipole, ERP = EIRP-2.15dBi.

**TEST MODE:**

Please refer to the clause 3.3

**TEST RESULTS**

**Passed**       **Not Applicable**

Note: Worst case at GSM850/PCS1900

GSM850					
Channel	Frequency (MHz)	Spurious Emission		Limit (dBm)	Result
		Polarization	Level (dBm)		
128	182.21	Vertical	-57.15	<-13.00	Pass
	414.90	V	-58.34		
	1648.51	V	-50.86		
	2472.57	V	-42.51		
	4119.70	V	-52.72		
	8581.52	V	-47.68		
	182.21	Horizontal	-58.84	<-13.00	Pass
	259.91	H	-58.88		
	1753.11	H	-41.03		
	2472.57	H	-39.52		
	4119.70	H	-54.08		
	4945.67	H	-51.96		
190	182.21	Vertical	-60.23	<-13.00	Pass
	312.06	V	-65.95		
	1672.22	V	-48.34		
	2510.89	V	-42.01		
	4179.88	V	-48.46		
	5017.92	V	-51.01		
	182.21	Horizontal	-55.66	<-13.00	Pass
	469.24	H	-57.16		
	1745.42	H	-47.94		
	2510.89	H	-45.49		
	4179.88	H	-50.70		
	5017.92	H	-51.35		
251	182.21	Vertical	-50.37	<-13.00	Pass
	259.91	V	-55.67		
	1698.14	V	-47.85		
	2575.14	V	-48.60		
	4125.68	V	-54.64		
	5091.22	V	-52.25		
	182.21	Horizontal	-53.76	<-13.00	Pass
	469.24	H	-56.33		
	1766.64	H	-43.99		
	2547.01	H	-44.27		
	4240.94	H	-54.83		
	5091.22	H	-54.00		

## Remark:

1. The emission behaviour belongs to narrowband spurious emission.
2. The emission levels of not record in the report are very lower than the limit and not show in test report.

PCS1900					
Channel	Frequency (MHz)	Spurious Emission		Limit (dBm)	Result
		Polarization	Level (dBm)		
512	182.21	Vertical	-60.44	<-13.00	Pass
	469.24	V	-61.01		
	1745.42	V	-47.17		
	2340.41	V	-48.87		
	4125.68	V	-55.21		
	7148.33	V	-50.78		
	182.21	Horizontal	-57.72	<-13.00	Pass
	259.91	H	-58.64		
	1513.13	H	-53.65		
	2327.59	H	-51.76		
	4125.68	H	-55.69		
	6094.28	H	-52.72		
661	182.21	Vertical	-57.52	<-13.00	Pass
	414.90	V	-56.64		
	1572.44	V	-54.82		
	2497.14	V	-50.02		
	3759.98	V	-51.17		
	5643.40	V	-51.13		
	182.21	Horizontal	-58.24	<-13.00	Pass
	200.36	H	-63.70		
	1745.42	H	-42.99		
	2242.25	H	-51.69		
	3759.98	H	-54.96		
	5643.40	H	-51.85		
810	182.21	Vertical	-55.34	<-13.00	Pass
	259.91	V	-57.34		
	1513.13	V	-54.75		
	2575.14	V	-46.58		
	3820.45	V	-52.17		
	5725.84	V	-52.35		
	182.21	Horizontal	-57.83	<-13.00	Pass
	259.91	H	-57.13		
	1513.13	H	-50.87		
	1764.70	H	-46.04		
	3820.45	H	-50.96		
	6774.86	H	-51.79		

## Remark:

1. The emission behaviour belongs to narrowband spurious emission.
2. The emission levels of not record in the report are very lower than the limit and not show in test report.

## 6. TEST SETUP PHOTOS

Radiated emission:

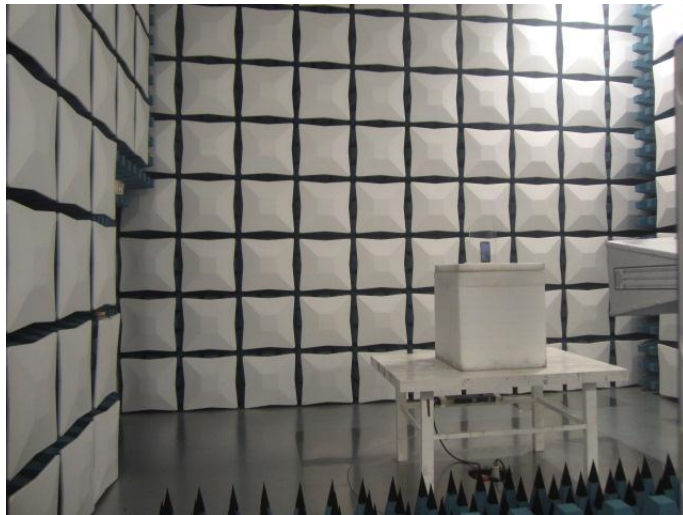
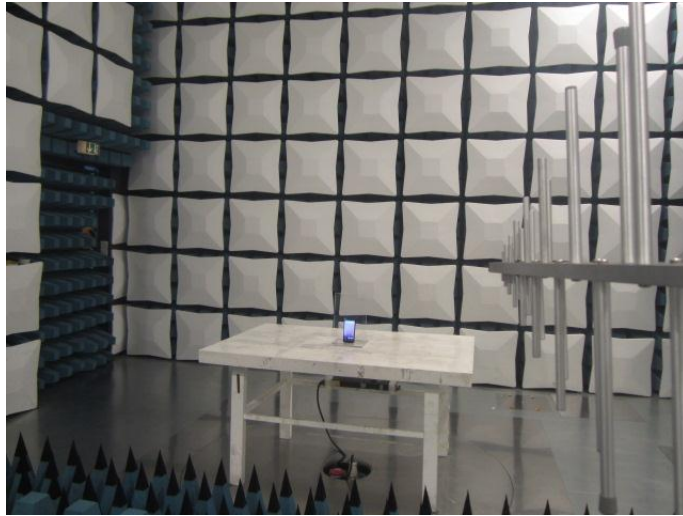



## 7. EXTERNAL AND INTERNAL PHOTOS

### External photos of the EUT



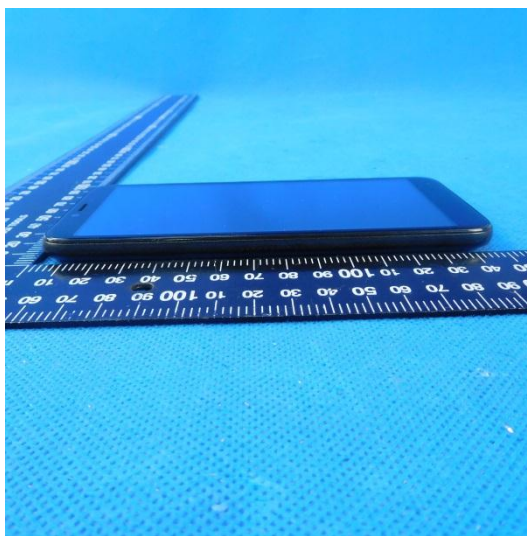
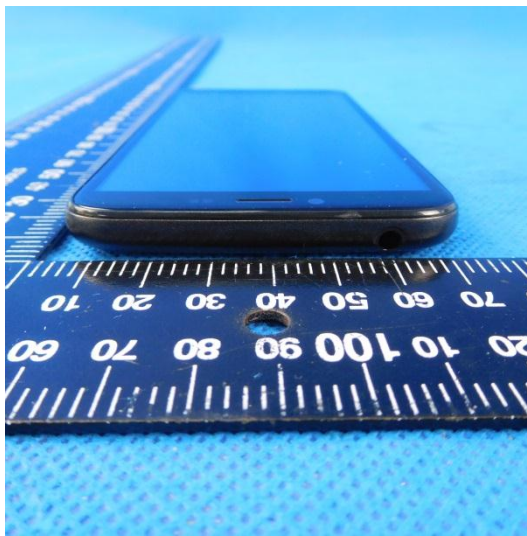
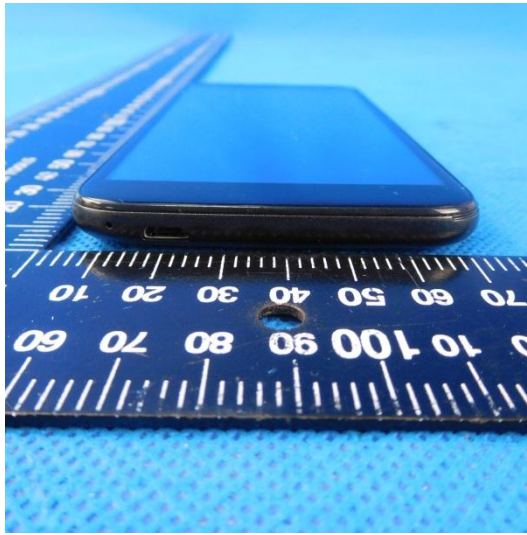

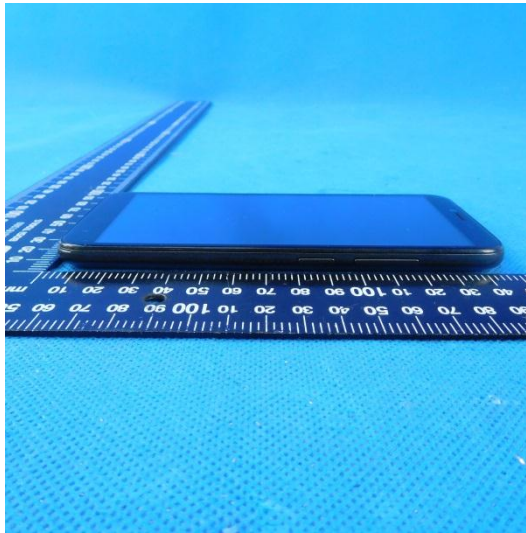

**Internal photos of the EUT**

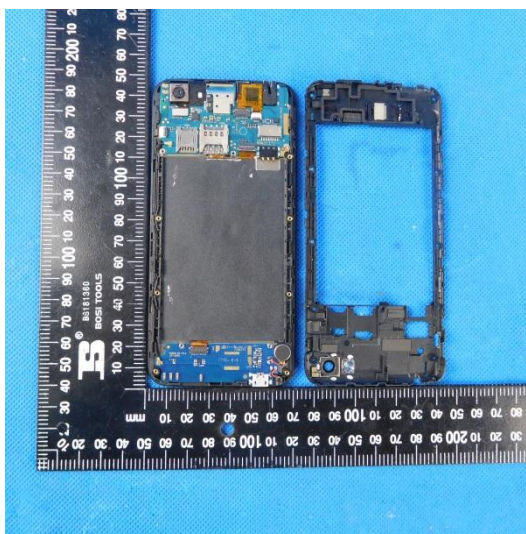

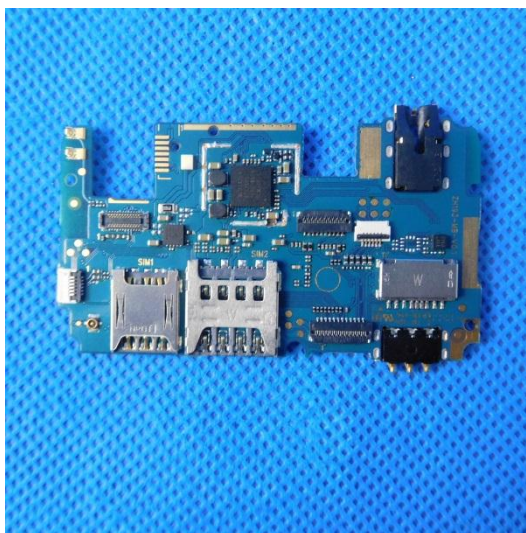
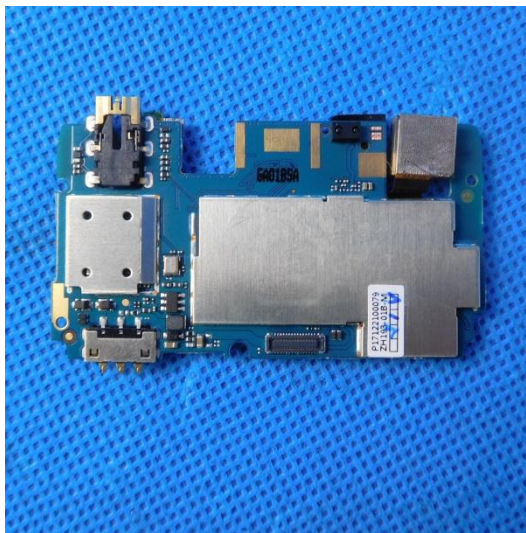
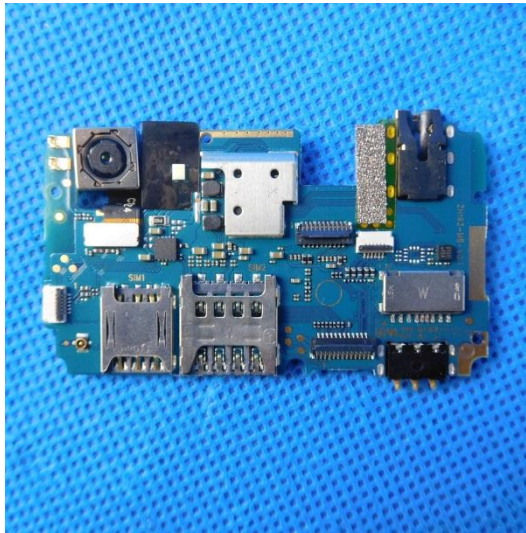

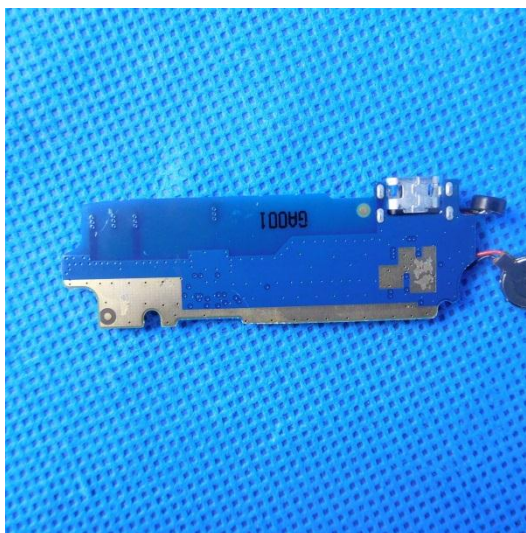
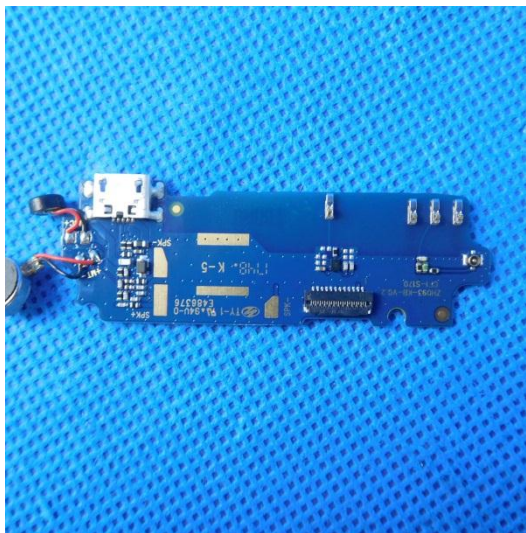
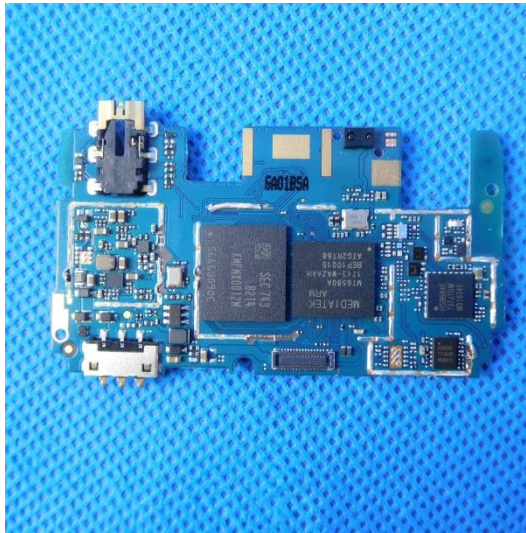



## 8. APPENDIX REPORT

**Appendix A: Conducted Output Power**

## Test Result

Band	Channel	PCL	Power(dBm)	Limit(dBm)	Verdict
GSM850	128	5	32.35	38.5	PASS
GSM850	190	5	32.36	38.5	PASS
GSM850	251	5	32.43	38.5	PASS
GSM1900	512	0	30.35	33	PASS
GSM1900	661	0	30.07	33	PASS
GSM1900	810	0	30.08	33	PASS



Band	Channel	PCL	Slot	Power(dBm)	Limit(dBm)	Verdict
GPRS850	128	5	1	32.36	38.5	PASS
GPRS850	128	5	2	31.90	38.5	PASS
GPRS850	128	5	3	30.22	38.5	PASS
GPRS850	128	5	4	29.12	38.5	PASS
GPRS850	190	5	1	32.32	38.5	PASS
GPRS850	190	5	2	31.94	38.5	PASS
GPRS850	190	5	3	30.34	38.5	PASS
GPRS850	190	5	4	29.14	38.5	PASS
GPRS850	251	5	1	32.29	38.5	PASS
GPRS850	251	5	2	31.77	38.5	PASS
GPRS850	251	5	3	30.51	38.5	PASS
GPRS850	251	5	4	29.27	38.5	PASS
GPRS1900	512	0	1	30.16	33	PASS
GPRS1900	512	0	2	29.62	33	PASS
GPRS1900	512	0	3	27.71	33	PASS
GPRS1900	512	0	4	26.77	33	PASS
GPRS1900	661	0	1	29.88	33	PASS
GPRS1900	661	0	2	29.32	33	PASS
GPRS1900	661	0	3	27.85	33	PASS
GPRS1900	661	0	4	26.62	33	PASS
GPRS1900	810	0	1	29.86	33	PASS
GPRS1900	810	0	2	29.23	33	PASS
GPRS1900	810	0	3	27.60	33	PASS
GPRS1900	810	0	4	26.57	33	PASS

Band	Channel	PCL	Slot	Power(dBm)	Limit(dBm)	Verdict
EGPRS850	128	8	1	27.00	38.5	PASS
EGPRS850	128	8	2	27.05	38.5	PASS
EGPRS850	128	8	3	27.01	38.5	PASS
EGPRS850	128	8	4	26.93	38.5	PASS
EGPRS850	190	8	1	26.87	38.5	PASS
EGPRS850	190	8	2	26.91	38.5	PASS
EGPRS850	190	8	3	26.86	38.5	PASS
EGPRS850	190	8	4	26.78	38.5	PASS
EGPRS850	251	8	1	26.80	38.5	PASS
EGPRS850	251	8	2	26.86	38.5	PASS
EGPRS850	251	8	3	26.81	38.5	PASS
EGPRS850	251	8	4	26.73	38.5	PASS
EGPRS1900	512	2	1	26.50	33	PASS
EGPRS1900	512	2	2	26.57	33	PASS
EGPRS1900	512	2	3	26.46	33	PASS
EGPRS1900	512	2	4	26.36	33	PASS
EGPRS1900	661	2	1	26.22	33	PASS
EGPRS1900	661	2	2	26.28	33	PASS
EGPRS1900	661	2	3	26.19	33	PASS
EGPRS1900	661	2	4	26.07	33	PASS
EGPRS1900	810	2	1	26.17	33	PASS
EGPRS1900	810	2	2	26.25	33	PASS
EGPRS1900	810	2	3	26.17	33	PASS
EGPRS1900	810	2	4	26.04	33	PASS

**Appendix B: Peak-to-Average Ratio**

## Test Result

Band	Channel	Peak-to-Average Ratio(dB)	Limit(dBm)	Verdict
GSM850	128	2.65	13	PASS
GSM850	190	2.66	13	PASS
GSM850	251	2.65	13	PASS
GPRS850	128	2.65	13	PASS
GPRS850	190	2.65	13	PASS
GPRS850	251	2.66	13	PASS
EGPRS850	128	2.63	13	PASS
EGPRS850	190	2.63	13	PASS
EGPRS850	251	2.63	13	PASS
GSM1900	512	2.70	13	PASS
GSM1900	661	2.67	13	PASS
GSM1900	810	2.67	13	PASS
GPRS1900	512	2.68	13	PASS
GPRS1900	661	2.70	13	PASS
GPRS1900	810	2.67	13	PASS
EGPRS1900	512	2.68	13	PASS
EGPRS1900	661	2.68	13	PASS
EGPRS1900	810	2.67	13	PASS

Test Graphs



GSM850\_128



GSM850\_190



GSM850\_251



GPRS850\_128



GPRS850\_190

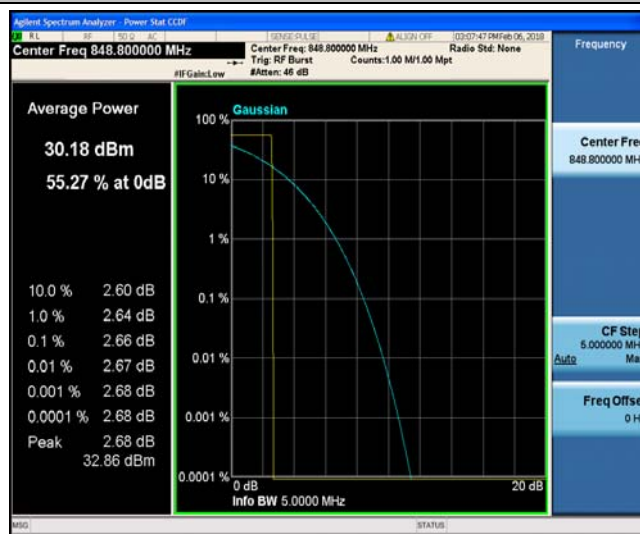

GPRS850\_251



EGPRS850\_128

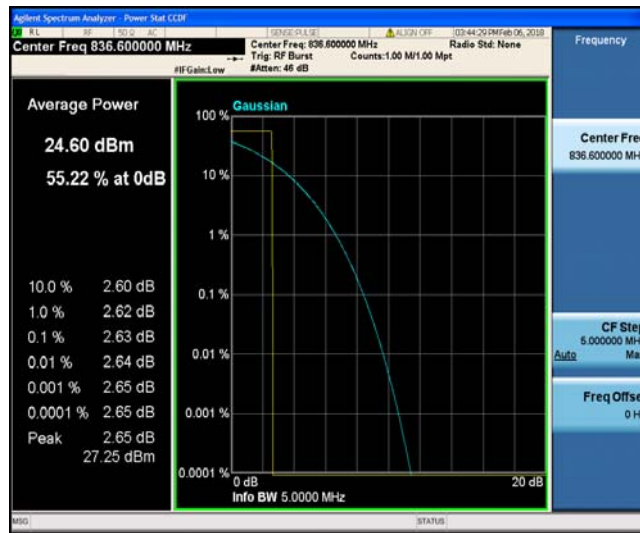

EGPRS850\_190



EGPRS850\_251



GSM1900\_512



GSM1900\_661

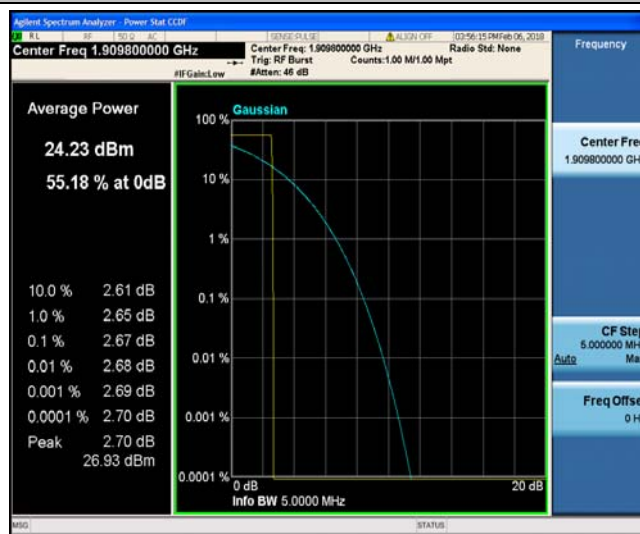

GSM1900\_810



GPRS1900\_512



GPRS1900\_661

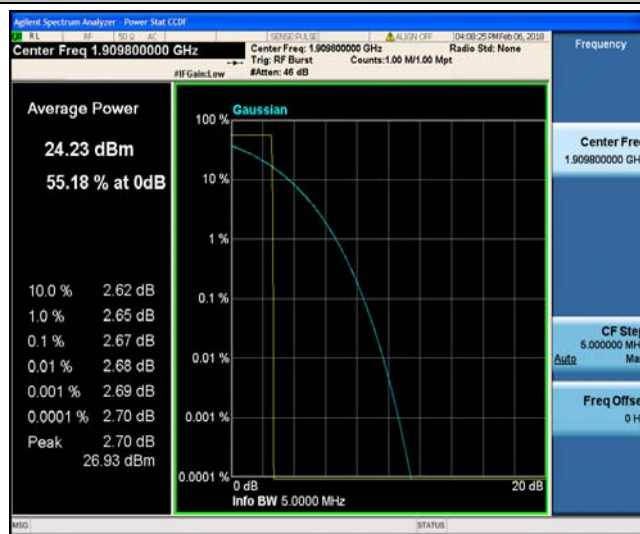

GPRS1900\_810





EGPRS1900\_512



EGPRS1900\_661



EGPRS1900\_810

**Appendix C: 26dB Bandwidth and Occupied Bandwidth**

## Test Result

Band	Channel	Occupied Bandwidth (kHz)	26dB Bandwidth (kHz)	Limit(kHz)	Verdict
GSM850	128	246.47	318.7	---	PASS
GSM850	190	244.25	316.6	---	PASS
GSM850	251	246.24	315.5	---	PASS
GPRS850	128	247.13	317.0	---	PASS
GPRS850	190	247.43	318.6	---	PASS
GPRS850	251	243.54	316.5	---	PASS
EGPRS850	128	246.28	318.6	---	PASS
EGPRS850	190	245.89	320.7	---	PASS
EGPRS850	251	245.08	317.7	---	PASS
GSM1900	512	246.69	317.1	---	PASS
GSM1900	661	247.11	314.1	---	PASS
GSM1900	810	245.23	313.5	---	PASS
GPRS1900	512	244.41	317.4	---	PASS
GPRS1900	661	244.66	318.9	---	PASS
GPRS1900	810	246.06	318.1	---	PASS
EGPRS1900	512	244.12	320.3	---	PASS
EGPRS1900	661	245.12	315.4	---	PASS
EGPRS1900	810	246.06	319.5	---	PASS

Test Graphs



GSM850\_128



GSM850\_190

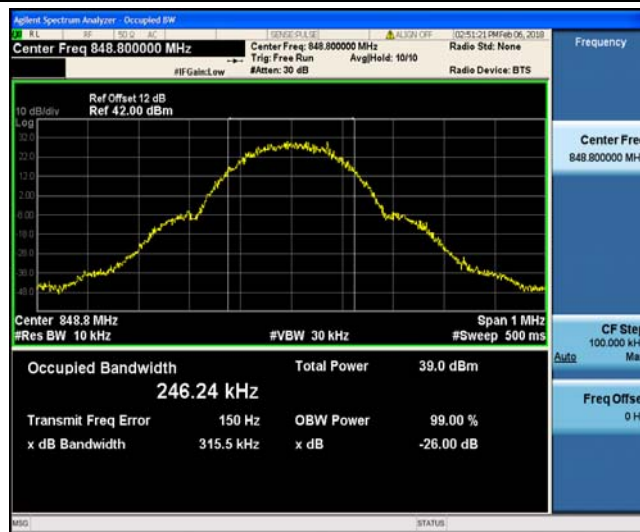

GSM850\_251

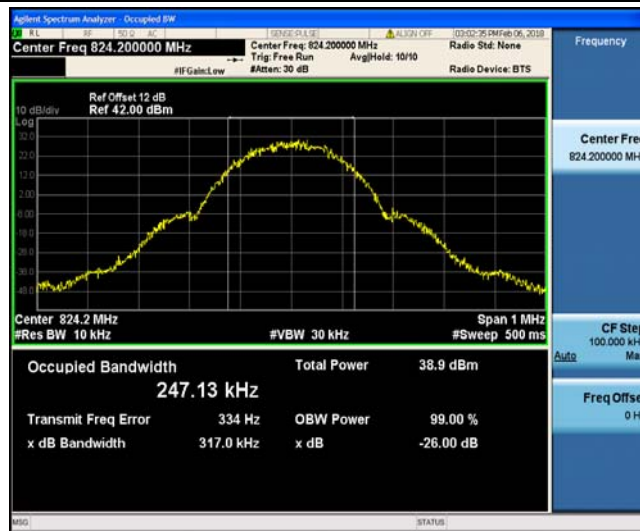

GPRS850\_128

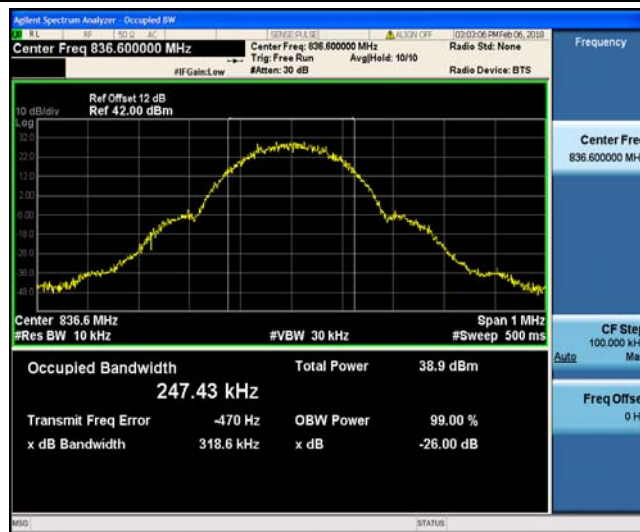

GPRS850\_190

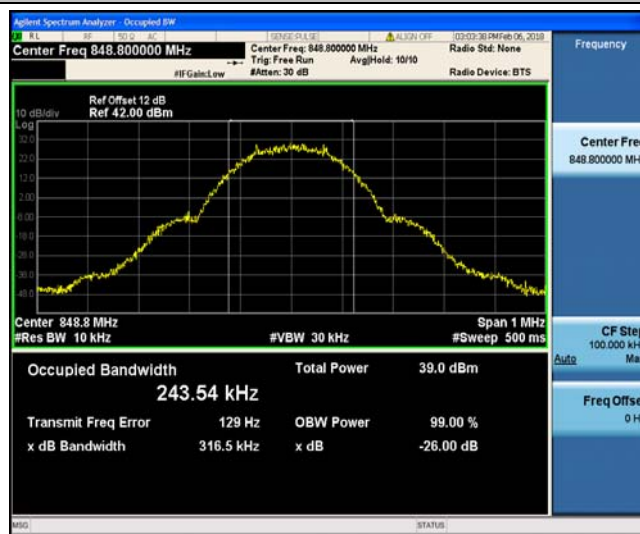

GPRS850\_251

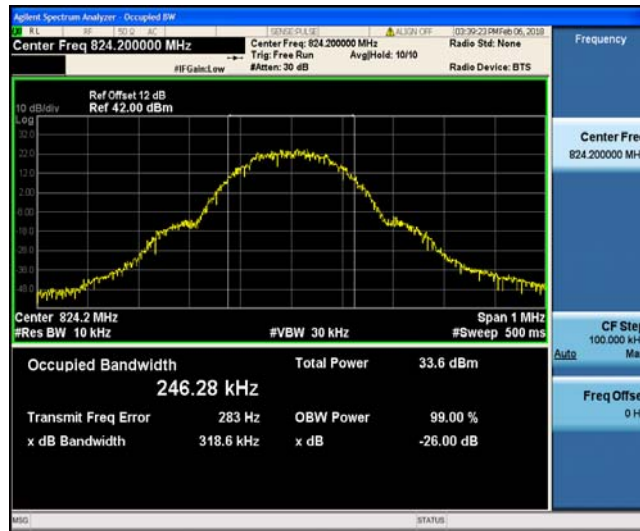

EGPRS850\_128

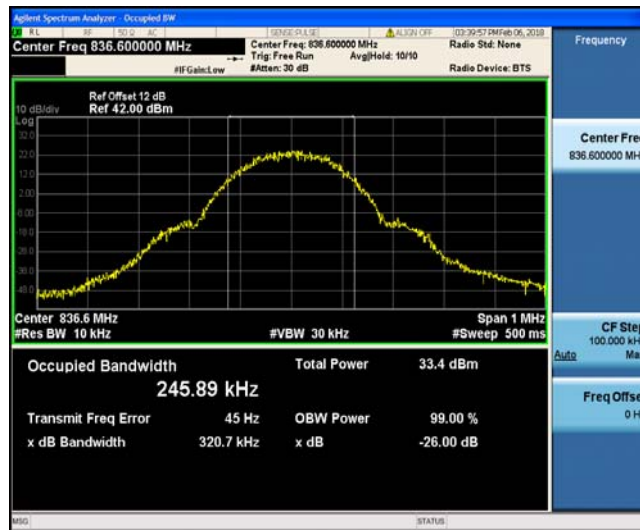

EGPRS850\_190



EGPRS850\_251

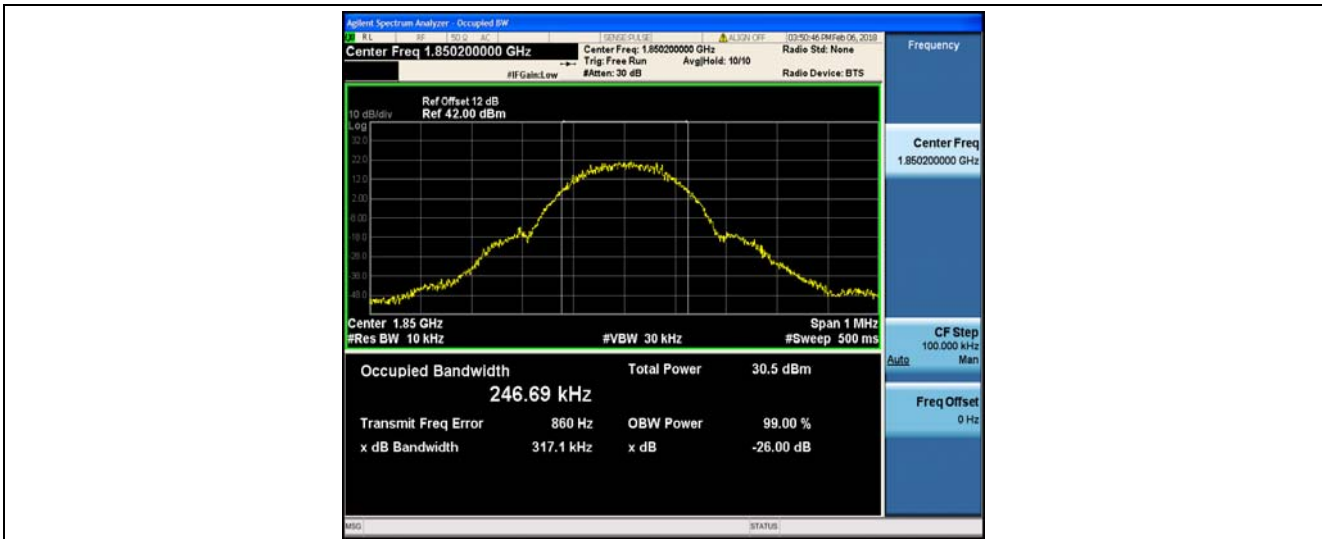

GSM1900\_512

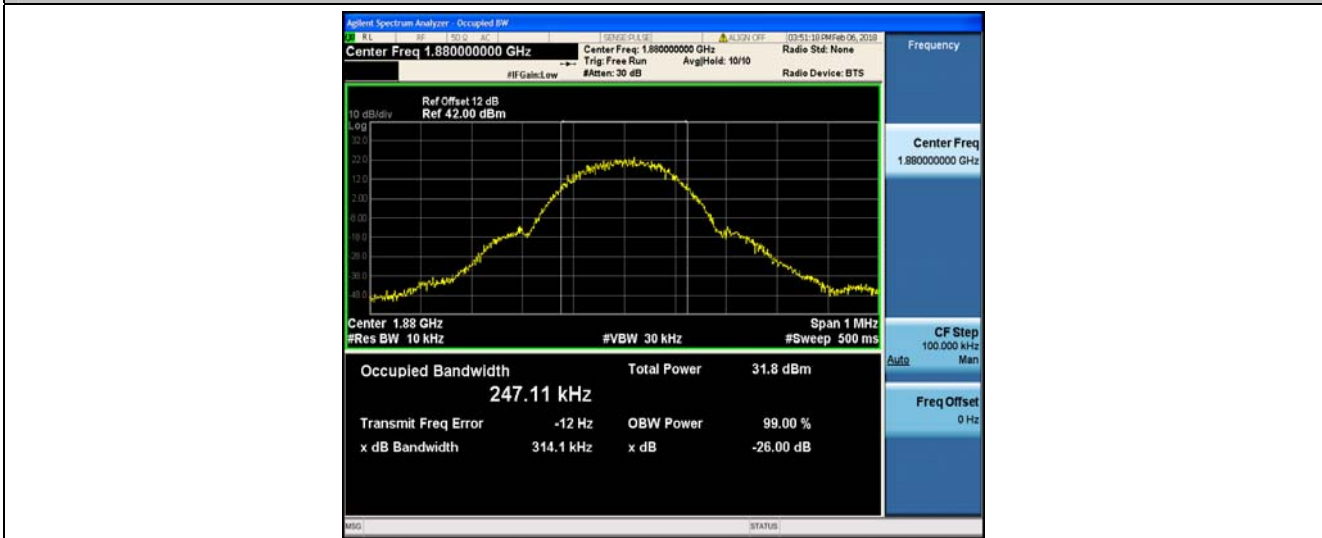

GSM1900\_661

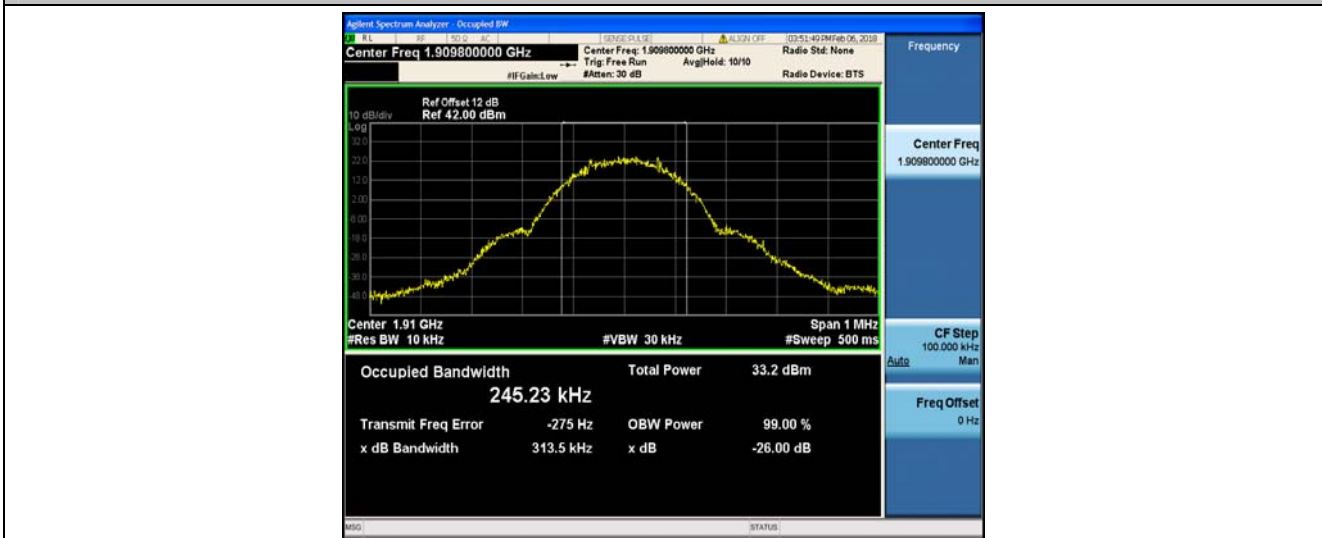

GSM1900\_810

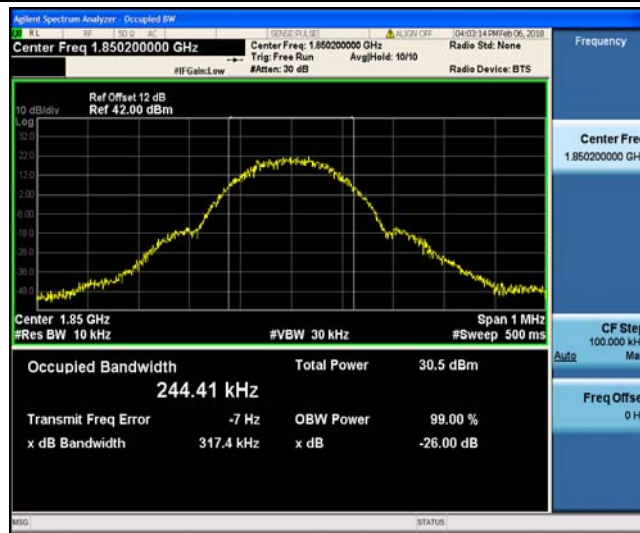

GPRS1900\_512

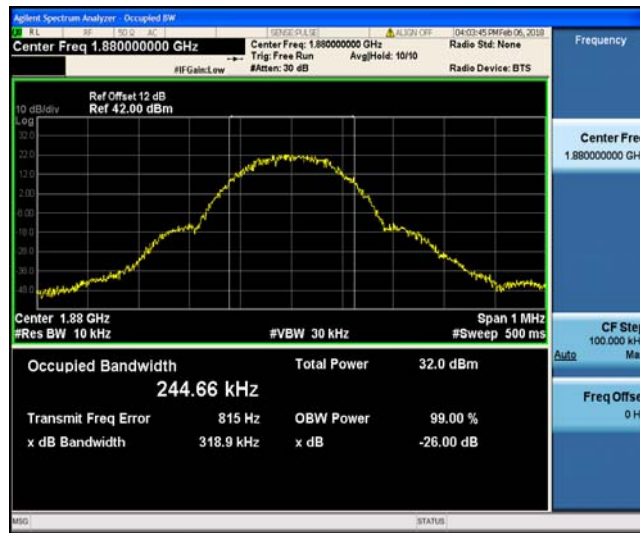

GPRS1900\_661



GPRS1900\_810

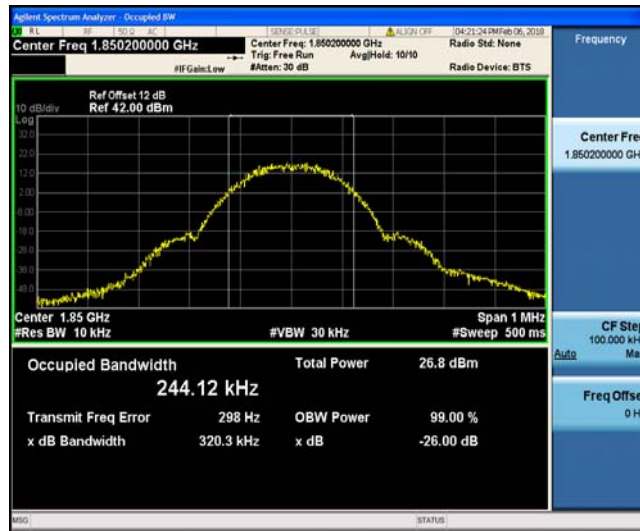

EGPRS1900\_512



EGPRS1900\_661



EGPRS1900\_810



**Appendix D: Band Edge**

## Test Result

Band	Channel	Value(dBm)	Limit(dBm)	Verdict
GSM850	128	-19.04	-13	PASS
GSM850	251	-16.98	-13	PASS
GPRS850	128	-17.68	-13	PASS
GPRS850	251	-17.72	-13	PASS
EGPRS850	128	-22.95	-13	PASS
EGPRS850	251	-22.64	-13	PASS
GSM1900	512	-24.13	-13	PASS
GSM1900	810	-22.48	-13	PASS
GPRS1900	512	-27.03	-13	PASS
GPRS1900	810	-21.91	-13	PASS
EGPRS1900	512	-30.14	-13	PASS
EGPRS1900	810	-27.26	-13	PASS

Test Graphs



GSM850\_128



GSM850\_251



GPRS850\_128



GPRS850\_251



EGPRS850\_128



EGPRS850\_251



GSM1900\_512



GSM1900\_810



GPRS1900\_512



GPRS1900\_810



EGPRS1900\_512



EGPRS1900\_810

**Appendix E: Conducted Spurious Emission**

## Test Result

Band	Channel	Frequency Rang(Mhz)	Value(dBm)	Limit(dBm)	Verdict
GSM850	128	30~1000	-38.23	-13	PASS
GSM850	128	1000~10000	-25.87	-13	PASS
GSM850	190	30~1000	-38.12	-13	PASS
GSM850	190	1000~10000	-25.68	-13	PASS
GSM850	251	30~1000	-39.29	-13	PASS
GSM850	251	1000~10000	-24.78	-13	PASS
GPRS850	128	30~1000	-38.66	-13	PASS
GPRS850	128	1000~10000	-25.62	-13	PASS
GPRS850	190	30~1000	-38.48	-13	PASS
GPRS850	190	1000~10000	-25.60	-13	PASS
GPRS850	251	30~1000	-39.06	-13	PASS
GPRS850	251	1000~10000	-25.97	-13	PASS
EGPRS850	128	30~1000	-38.23	-13	PASS
EGPRS850	128	1000~10000	-25.86	-13	PASS
EGPRS850	190	30~1000	-38.84	-13	PASS
EGPRS850	190	1000~10000	-25.90	-13	PASS
EGPRS850	251	30~1000	-38.25	-13	PASS
EGPRS850	251	1000~10000	-26.08	-13	PASS
GSM1900	512	30~1000	-38.78	-13	PASS
GSM1900	512	1000~20000	-19.59	-13	PASS
GSM1900	661	30~1000	-38.69	-13	PASS
GSM1900	661	1000~20000	-19.61	-13	PASS
GSM1900	810	30~1000	-38.27	-13	PASS
GSM1900	810	1000~20000	-19.31	-13	PASS
GPRS1900	512	30~1000	-38.62	-13	PASS
GPRS1900	512	1000~20000	-19.48	-13	PASS
GPRS1900	661	30~1000	-39.04	-13	PASS
GPRS1900	661	1000~20000	-20.03	-13	PASS
GPRS1900	810	30~1000	-38.55	-13	PASS
GPRS1900	810	1000~20000	-20.14	-13	PASS
EGPRS1900	512	30~1000	-38.79	-13	PASS
EGPRS1900	512	1000~20000	-19.78	-13	PASS
EGPRS1900	661	30~1000	-38.47	-13	PASS
EGPRS1900	661	1000~20000	-19.86	-13	PASS
EGPRS1900	810	30~1000	-38.41	-13	PASS
EGPRS1900	810	1000~20000	-19.96	-13	PASS

Test Graphs

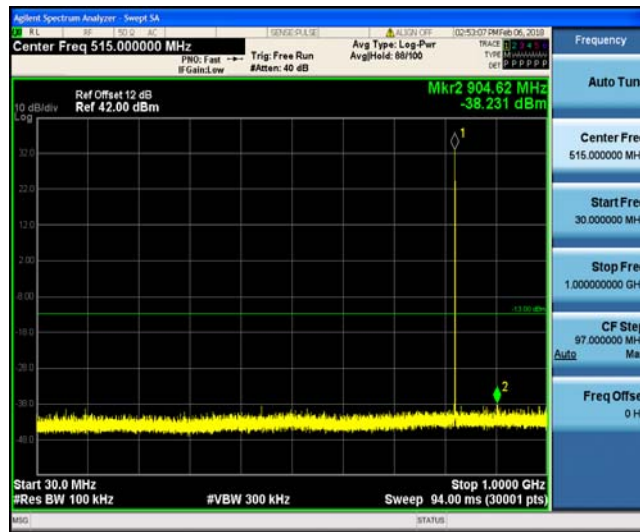

GSM850\_128



GSM850\_128

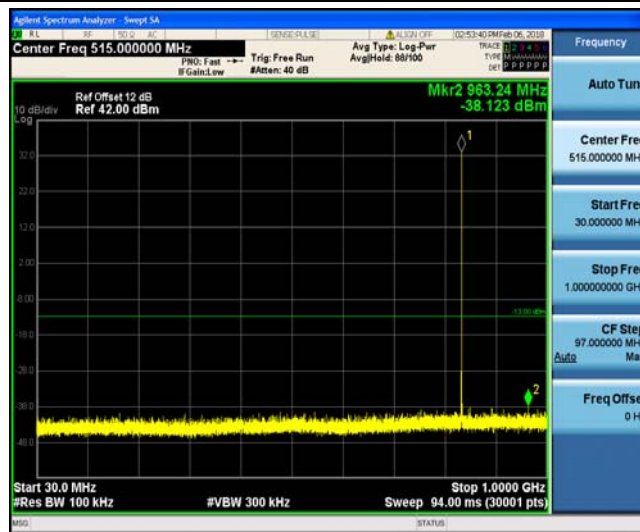

GSM850\_190



GSM850\_190

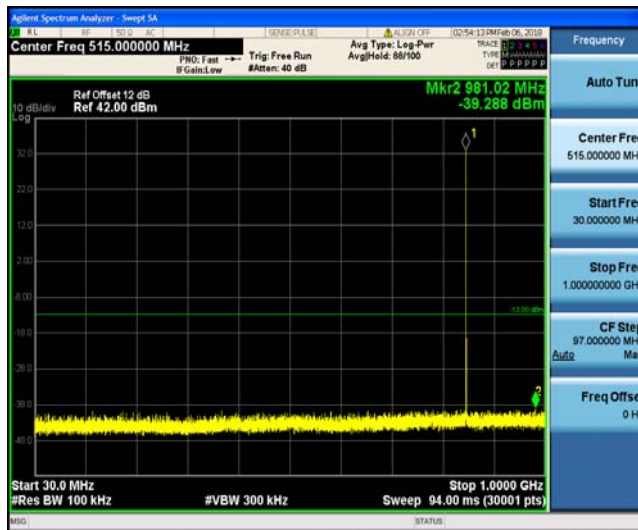

GSM850\_251



GSM850\_251



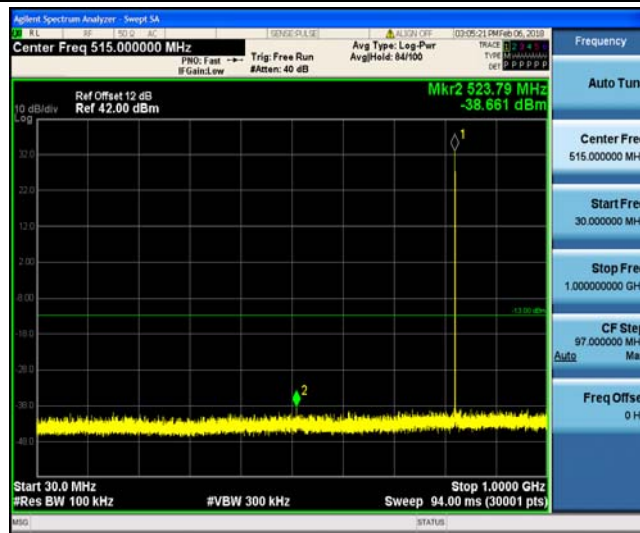

GPRS850\_128



GPRS850\_128



GPRS850\_190



GPRS850\_190

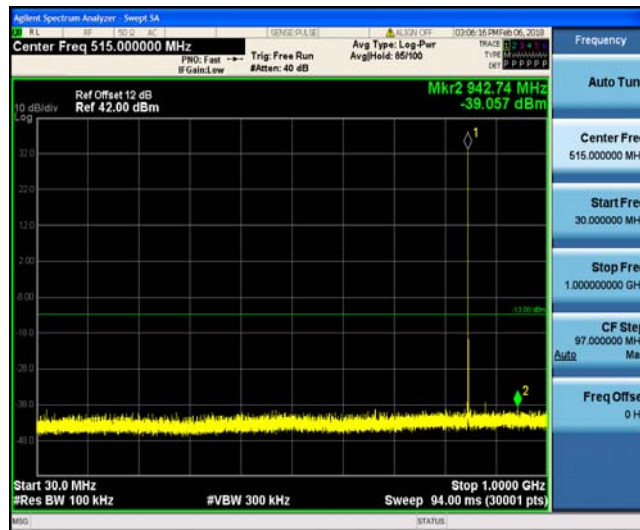

GPRS850\_251



GPRS850\_251

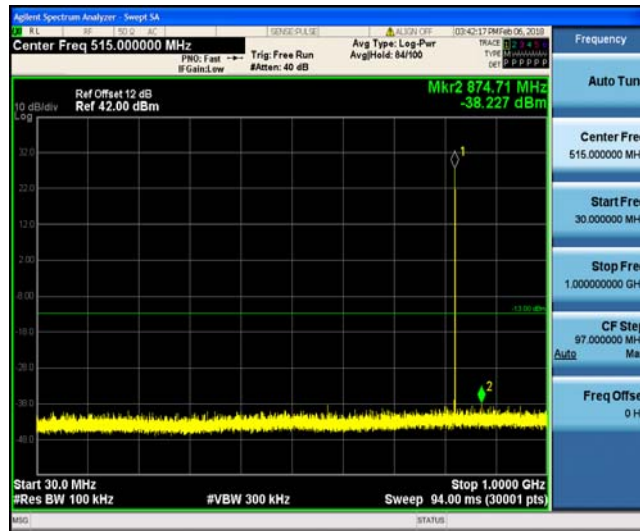

EGPRS850\_128



EGPRS850\_128

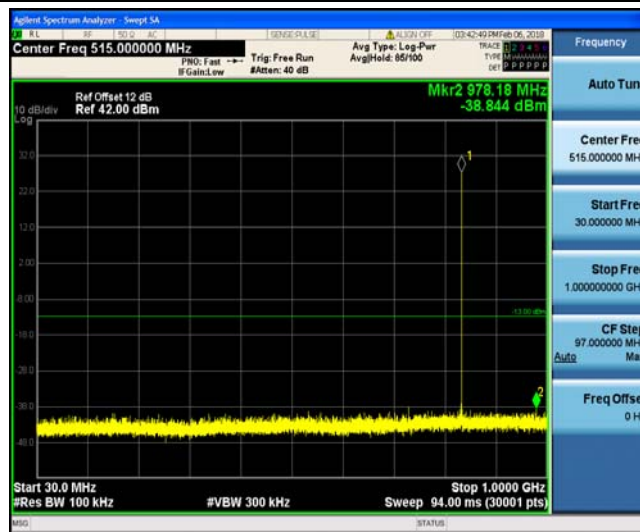

EGPRS850\_190



EGPRS850\_190

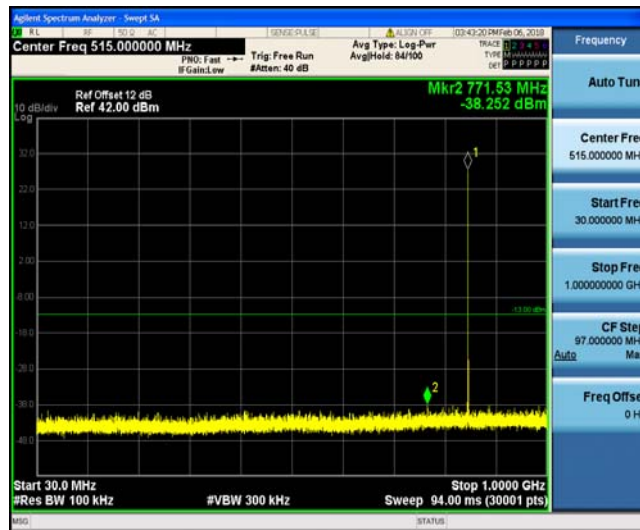

EGPRS850\_251



EGPRS850\_251



GSM1900\_512



GSM1900\_512



GSM1900\_661



GSM1900\_661

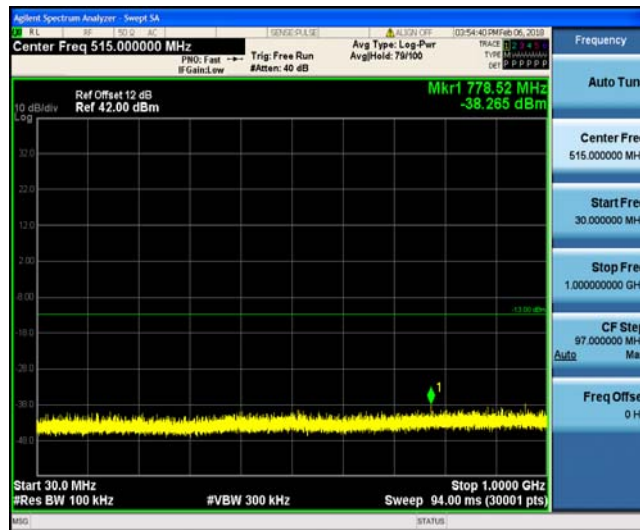

GSM1900\_810



GSM1900\_810

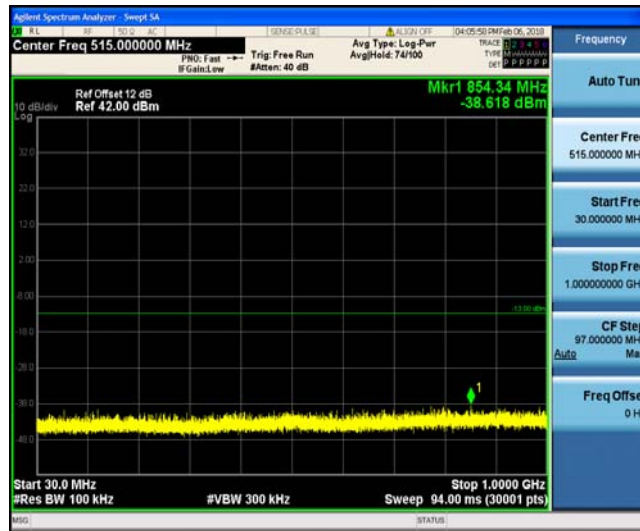

GPRS1900\_512



GPRS1900\_512

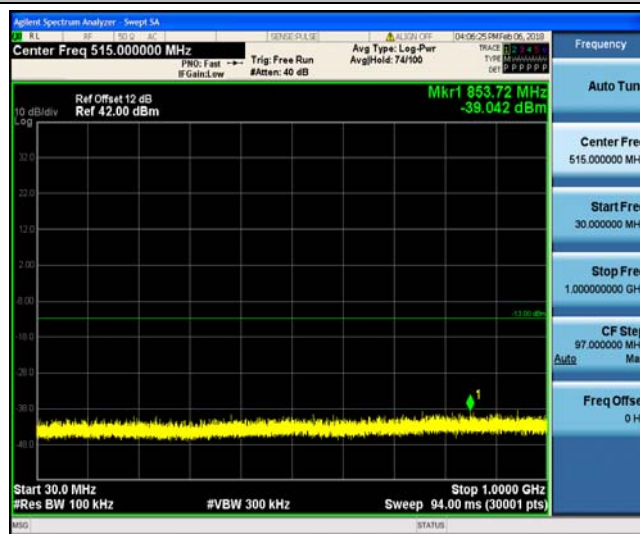

GPRS1900\_661



GPRS1900\_661

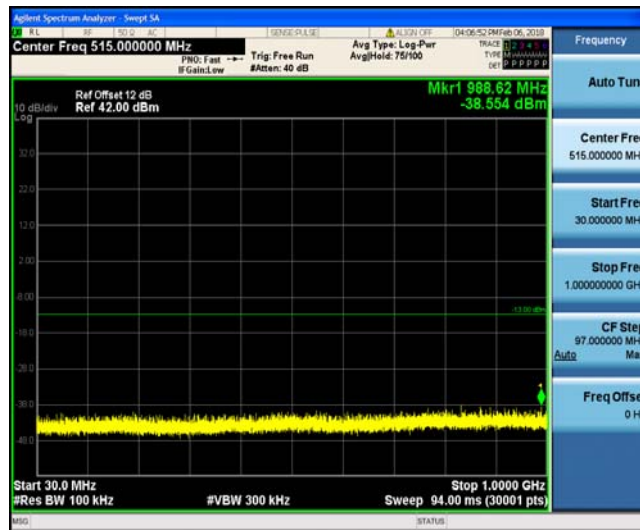

GPRS1900\_810



GPRS1900\_810



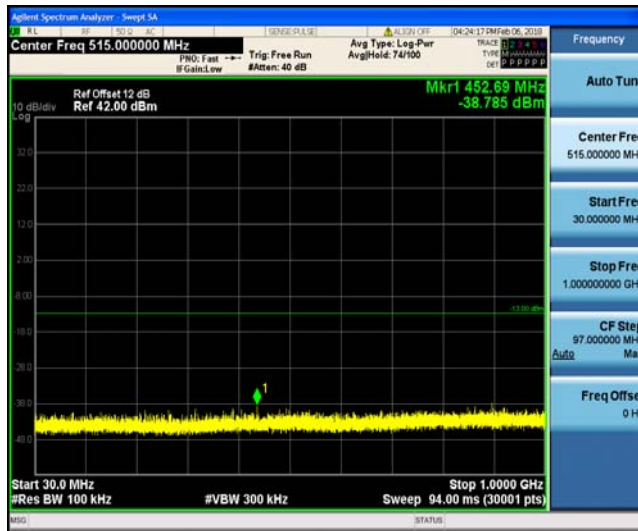

EGPRS1900\_512



EGPRS1900\_512

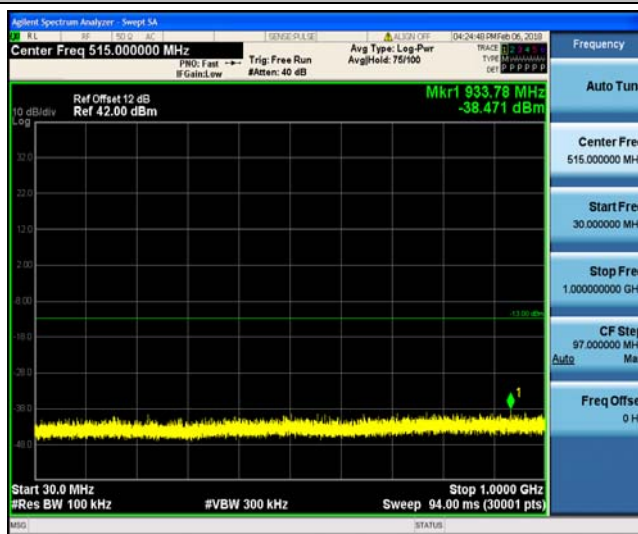

EGPRS1900\_661



EGPRS1900\_661

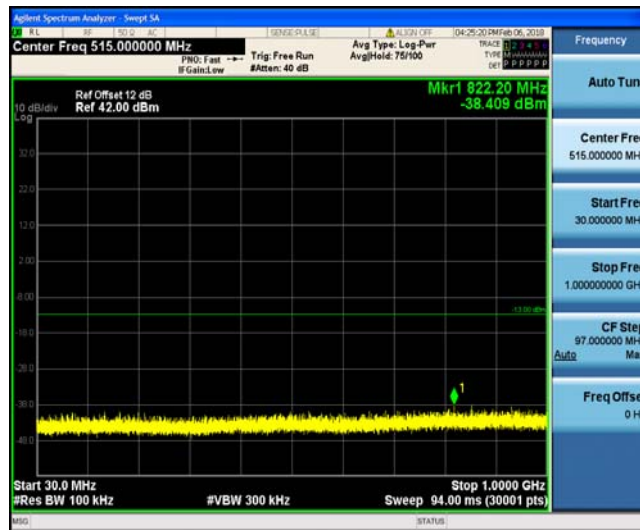

EGPRS1900\_810



EGPRS1900\_810

**Appendix F: Frequency Stability**

## Test Result

Voltage							
Band	Channel	Voltage (Vdc)	Temperature (°C)	Deviation (Hz)	Deviation (ppm)	Limit (ppm)	Verdict
GSM850	128	VL	TN	12.82	0.015551	2.5	PASS
GSM850	128	VN	TN	10.40	0.012613	2.5	PASS
GSM850	128	VH	TN	8.17	0.009911	2.5	PASS
GSM850	190	VL	TN	4.07	0.004863	2.5	PASS
GSM850	190	VN	TN	7.20	0.008606	2.5	PASS
GSM850	190	VH	TN	5.55	0.006638	2.5	PASS
GSM850	251	VL	TN	6.17	0.007265	2.5	PASS
GSM850	251	VN	TN	5.62	0.006618	2.5	PASS
GSM850	251	VH	TN	3.29	0.003880	2.5	PASS
GPRS850	128	VL	TN	8.36	0.010146	2.5	PASS
GPRS850	128	VN	TN	7.85	0.009519	2.5	PASS
GPRS850	128	VH	TN	8.59	0.010420	2.5	PASS
GPRS850	190	VL	TN	2.36	0.002817	2.5	PASS
GPRS850	190	VN	TN	2.39	0.002856	2.5	PASS
GPRS850	190	VH	TN	2.42	0.002894	2.5	PASS
GPRS850	251	VL	TN	12.27	0.014454	2.5	PASS
GPRS850	251	VN	TN	8.04	0.009471	2.5	PASS
GPRS850	251	VH	TN	8.65	0.010194	2.5	PASS
EGPRS850	128	VL	TN	-0.32	-0.000392	2.5	PASS
EGPRS850	128	VN	TN	4.94	0.005993	2.5	PASS
EGPRS850	128	VH	TN	9.65	0.011713	2.5	PASS
EGPRS850	190	VL	TN	3.84	0.004592	2.5	PASS
EGPRS850	190	VN	TN	5.97	0.007139	2.5	PASS
EGPRS850	190	VH	TN	3.00	0.003589	2.5	PASS
EGPRS850	251	VL	TN	7.46	0.008787	2.5	PASS
EGPRS850	251	VN	TN	4.75	0.005591	2.5	PASS
EGPRS850	251	VH	TN	4.55	0.005363	2.5	PASS
GSM1900	512	VL	TN	13.33	0.007207	2.5	PASS
GSM1900	512	VN	TN	20.11	0.010871	2.5	PASS
GSM1900	512	VH	TN	21.83	0.011796	2.5	PASS
GSM1900	661	VL	TN	12.85	0.006835	2.5	PASS
GSM1900	661	VN	TN	22.96	0.012210	2.5	PASS
GSM1900	661	VH	TN	9.69	0.005152	2.5	PASS
GSM1900	810	VL	TN	18.21	0.009535	2.5	PASS
GSM1900	810	VN	TN	26.22	0.013727	2.5	PASS
GSM1900	810	VH	TN	18.24	0.009552	2.5	PASS
GPRS1900	512	VL	TN	15.14	0.008184	2.5	PASS
GPRS1900	512	VN	TN	22.54	0.012180	2.5	PASS
GPRS1900	512	VH	TN	23.08	0.012477	2.5	PASS
GPRS1900	661	VL	TN	16.43	0.008741	2.5	PASS
GPRS1900	661	VN	TN	14.56	0.007745	2.5	PASS
GPRS1900	661	VH	TN	6.72	0.003572	2.5	PASS
GPRS1900	810	VL	TN	14.98	0.007844	2.5	PASS
GPRS1900	810	VN	TN	22.76	0.011918	2.5	PASS
GPRS1900	810	VH	TN	18.98	0.009940	2.5	PASS
EGPRS1900	512	VL	TN	16.92	0.009144	2.5	PASS
EGPRS1900	512	VN	TN	22.86	0.012355	2.5	PASS
EGPRS1900	512	VH	TN	29.19	0.015775	2.5	PASS

EGPRS1900	661	VL	TN	13.33	0.007093	2.5	PASS
EGPRS1900	661	VN	TN	19.34	0.010287	2.5	PASS
EGPRS1900	661	VH	TN	1.03	0.000550	2.5	PASS
EGPRS1900	810	VL	TN	15.40	0.008064	2.5	PASS
EGPRS1900	810	VN	TN	19.11	0.010008	2.5	PASS
EGPRS1900	810	VH	TN	9.81	0.005139	2.5	PASS

Temperature							
Band	Channel	Voltage (Vdc)	Temperature (°C)	Deviation (Hz)	Deviation (ppm)	Limit (ppm)	Verdict
GSM850	128	VN	-30	8.30	0.010067	2.5	PASS
GSM850	128	VN	-20	3.65	0.004426	2.5	PASS
GSM850	128	VN	-10	7.17	0.008696	2.5	PASS
GSM850	128	VN	0	2.26	0.002742	2.5	PASS
GSM850	128	VN	10	3.81	0.004622	2.5	PASS
GSM850	128	VN	20	1.39	0.001684	2.5	PASS
GSM850	128	VN	30	4.81	0.005837	2.5	PASS
GSM850	128	VN	40	-3.58	-0.004348	2.5	PASS
GSM850	128	VN	50	0.68	0.000823	2.5	PASS
GSM850	190	VN	-30	4.91	0.005866	2.5	PASS
GSM850	190	VN	-20	5.20	0.006213	2.5	PASS
GSM850	190	VN	-10	6.20	0.007410	2.5	PASS
GSM850	190	VN	0	8.49	0.010150	2.5	PASS
GSM850	190	VN	10	0.10	0.000116	2.5	PASS
GSM850	190	VN	20	1.39	0.001659	2.5	PASS
GSM850	190	VN	30	1.36	0.001621	2.5	PASS
GSM850	190	VN	40	0.87	0.001042	2.5	PASS
GSM850	190	VN	50	5.00	0.005982	2.5	PASS
GSM850	251	VN	-30	4.16	0.004907	2.5	PASS
GSM850	251	VN	-20	6.59	0.007760	2.5	PASS
GSM850	251	VN	-10	8.17	0.009623	2.5	PASS
GSM850	251	VN	0	7.39	0.008710	2.5	PASS
GSM850	251	VN	10	8.10	0.009547	2.5	PASS
GSM850	251	VN	20	3.39	0.003994	2.5	PASS
GSM850	251	VN	30	4.81	0.005668	2.5	PASS
GSM850	251	VN	40	3.84	0.004526	2.5	PASS
GSM850	251	VN	50	0.61	0.000723	2.5	PASS
GPRS850	128	VN	-30	0.58	0.000705	2.5	PASS
GPRS850	128	VN	-20	11.53	0.013985	2.5	PASS
GPRS850	128	VN	-10	9.01	0.010929	2.5	PASS
GPRS850	128	VN	0	4.81	0.005837	2.5	PASS
GPRS850	128	VN	10	13.92	0.016883	2.5	PASS
GPRS850	128	VN	20	13.04	0.015826	2.5	PASS
GPRS850	128	VN	30	17.43	0.021153	2.5	PASS
GPRS850	128	VN	40	18.95	0.022994	2.5	PASS
GPRS850	128	VN	50	11.20	0.013593	2.5	PASS
GPRS850	190	VN	-30	5.33	0.006368	2.5	PASS
GPRS850	190	VN	-20	9.98	0.011925	2.5	PASS
GPRS850	190	VN	-10	8.65	0.010343	2.5	PASS
GPRS850	190	VN	0	6.68	0.007988	2.5	PASS
GPRS850	190	VN	10	10.07	0.012041	2.5	PASS
GPRS850	190	VN	20	17.82	0.021303	2.5	PASS
GPRS850	190	VN	30	18.79	0.022460	2.5	PASS
GPRS850	190	VN	40	16.72	0.019991	2.5	PASS
GPRS850	190	VN	50	14.75	0.017636	2.5	PASS
GPRS850	251	VN	-30	4.04	0.004755	2.5	PASS
GPRS850	251	VN	-20	3.97	0.004679	2.5	PASS
GPRS850	251	VN	-10	9.07	0.010688	2.5	PASS
GPRS850	251	VN	0	9.30	0.010955	2.5	PASS
GPRS850	251	VN	10	18.08	0.021301	2.5	PASS
GPRS850	251	VN	20	14.24	0.016774	2.5	PASS

GPRS850	251	VN	30	12.79	0.015063	2.5	PASS
GPRS850	251	VN	40	11.91	0.014036	2.5	PASS
GPRS850	251	VN	50	17.40	0.020502	2.5	PASS
EGPRS850	128	VN	-30	7.14	0.008657	2.5	PASS
EGPRS850	128	VN	-20	6.26	0.007599	2.5	PASS
EGPRS850	128	VN	-10	1.23	0.001489	2.5	PASS
EGPRS850	128	VN	0	3.65	0.004426	2.5	PASS
EGPRS850	128	VN	10	18.47	0.022407	2.5	PASS
EGPRS850	128	VN	20	20.21	0.024522	2.5	PASS
EGPRS850	128	VN	30	6.97	0.008461	2.5	PASS
EGPRS850	128	VN	40	12.46	0.015121	2.5	PASS
EGPRS850	128	VN	50	18.14	0.022015	2.5	PASS
EGPRS850	190	VN	-30	2.58	0.003087	2.5	PASS
EGPRS850	190	VN	-20	2.78	0.003319	2.5	PASS
EGPRS850	190	VN	-10	5.33	0.006368	2.5	PASS
EGPRS850	190	VN	0	4.07	0.004863	2.5	PASS
EGPRS850	190	VN	10	4.07	0.004863	2.5	PASS
EGPRS850	190	VN	20	14.79	0.017675	2.5	PASS
EGPRS850	190	VN	30	6.26	0.007487	2.5	PASS
EGPRS850	190	VN	40	13.72	0.016401	2.5	PASS
EGPRS850	190	VN	50	21.31	0.025471	2.5	PASS
EGPRS850	251	VN	-30	-0.94	-0.001103	2.5	PASS
EGPRS850	251	VN	-20	1.61	0.001902	2.5	PASS
EGPRS850	251	VN	-10	6.46	0.007607	2.5	PASS
EGPRS850	251	VN	0	0.36	0.000418	2.5	PASS
EGPRS850	251	VN	10	6.59	0.007760	2.5	PASS
EGPRS850	251	VN	20	0.94	0.001103	2.5	PASS
EGPRS850	251	VN	30	10.65	0.012552	2.5	PASS
EGPRS850	251	VN	40	6.42	0.007569	2.5	PASS
EGPRS850	251	VN	50	7.97	0.009395	2.5	PASS
GSM1900	512	VN	-30	15.69	0.008481	2.5	PASS
GSM1900	512	VN	-20	16.24	0.008777	2.5	PASS
GSM1900	512	VN	-10	22.50	0.012163	2.5	PASS
GSM1900	512	VN	0	16.27	0.008795	2.5	PASS
GSM1900	512	VN	10	22.44	0.012128	2.5	PASS
GSM1900	512	VN	20	17.60	0.009510	2.5	PASS
GSM1900	512	VN	30	17.27	0.009336	2.5	PASS
GSM1900	512	VN	40	16.14	0.008725	2.5	PASS
GSM1900	512	VN	50	14.66	0.007922	2.5	PASS
GSM1900	661	VN	-30	19.15	0.010184	2.5	PASS
GSM1900	661	VN	-20	11.24	0.005976	2.5	PASS
GSM1900	661	VN	-10	16.82	0.008947	2.5	PASS
GSM1900	661	VN	0	13.95	0.007419	2.5	PASS
GSM1900	661	VN	10	14.11	0.007505	2.5	PASS
GSM1900	661	VN	20	11.91	0.006337	2.5	PASS
GSM1900	661	VN	30	15.01	0.007986	2.5	PASS
GSM1900	661	VN	40	17.72	0.009428	2.5	PASS
GSM1900	661	VN	50	14.08	0.007488	2.5	PASS
GSM1900	810	VN	-30	23.89	0.012510	2.5	PASS
GSM1900	810	VN	-20	18.31	0.009585	2.5	PASS
GSM1900	810	VN	-10	22.70	0.011884	2.5	PASS
GSM1900	810	VN	0	11.40	0.005968	2.5	PASS
GSM1900	810	VN	10	22.76	0.011918	2.5	PASS
GSM1900	810	VN	20	19.37	0.010143	2.5	PASS
GSM1900	810	VN	30	17.24	0.009027	2.5	PASS

GSM1900	810	VN	40	14.85	0.007776	2.5	PASS
GSM1900	810	VN	50	22.99	0.012037	2.5	PASS
GPRS1900	512	VN	-30	32.96	0.017816	2.5	PASS
GPRS1900	512	VN	-20	13.20	0.007137	2.5	PASS
GPRS1900	512	VN	-10	19.60	0.010592	2.5	PASS
GPRS1900	512	VN	0	11.14	0.006020	2.5	PASS
GPRS1900	512	VN	10	40.94	0.022127	2.5	PASS
GPRS1900	512	VN	20	43.62	0.023575	2.5	PASS
GPRS1900	512	VN	30	55.95	0.030241	2.5	PASS
GPRS1900	512	VN	40	32.41	0.017520	2.5	PASS
GPRS1900	512	VN	50	45.98	0.024849	2.5	PASS
GPRS1900	661	VN	-30	15.98	0.008501	2.5	PASS
GPRS1900	661	VN	-20	15.43	0.008209	2.5	PASS
GPRS1900	661	VN	-10	11.62	0.006182	2.5	PASS
GPRS1900	661	VN	0	17.82	0.009480	2.5	PASS
GPRS1900	661	VN	10	20.21	0.010751	2.5	PASS
GPRS1900	661	VN	20	24.34	0.012949	2.5	PASS
GPRS1900	661	VN	30	20.57	0.010939	2.5	PASS
GPRS1900	661	VN	40	22.28	0.011850	2.5	PASS
GPRS1900	661	VN	50	8.17	0.004345	2.5	PASS
GPRS1900	810	VN	-30	26.15	0.013693	2.5	PASS
GPRS1900	810	VN	-20	21.18	0.011090	2.5	PASS
GPRS1900	810	VN	-10	20.40	0.010684	2.5	PASS
GPRS1900	810	VN	0	13.04	0.006830	2.5	PASS
GPRS1900	810	VN	10	20.08	0.010515	2.5	PASS
GPRS1900	810	VN	20	30.12	0.015773	2.5	PASS
GPRS1900	810	VN	30	18.11	0.009484	2.5	PASS
GPRS1900	810	VN	40	6.97	0.003652	2.5	PASS
GPRS1900	810	VN	50	35.19	0.018427	2.5	PASS
EGPRS1900	512	VN	-30	18.44	0.009964	2.5	PASS
EGPRS1900	512	VN	-20	23.86	0.012895	2.5	PASS
EGPRS1900	512	VN	-10	15.82	0.008550	2.5	PASS
EGPRS1900	512	VN	0	23.12	0.012494	2.5	PASS
EGPRS1900	512	VN	10	20.57	0.011116	2.5	PASS
EGPRS1900	512	VN	20	45.88	0.024796	2.5	PASS
EGPRS1900	512	VN	30	22.50	0.012163	2.5	PASS
EGPRS1900	512	VN	40	41.81	0.022598	2.5	PASS
EGPRS1900	512	VN	50	41.39	0.022371	2.5	PASS
EGPRS1900	661	VN	-30	22.24	0.011832	2.5	PASS
EGPRS1900	661	VN	-20	2.94	0.001563	2.5	PASS
EGPRS1900	661	VN	-10	19.02	0.010115	2.5	PASS
EGPRS1900	661	VN	0	16.27	0.008655	2.5	PASS
EGPRS1900	661	VN	10	14.17	0.007539	2.5	PASS
EGPRS1900	661	VN	20	11.43	0.006079	2.5	PASS
EGPRS1900	661	VN	30	20.28	0.010785	2.5	PASS
EGPRS1900	661	VN	40	32.35	0.017208	2.5	PASS
EGPRS1900	661	VN	50	28.99	0.015422	2.5	PASS
EGPRS1900	810	VN	-30	15.01	0.007861	2.5	PASS
EGPRS1900	810	VN	-20	14.63	0.007658	2.5	PASS
EGPRS1900	810	VN	-10	14.59	0.007641	2.5	PASS
EGPRS1900	810	VN	0	15.85	0.008301	2.5	PASS
EGPRS1900	810	VN	10	11.17	0.005849	2.5	PASS
EGPRS1900	810	VN	20	17.79	0.009315	2.5	PASS
EGPRS1900	810	VN	30	35.68	0.018680	2.5	PASS
EGPRS1900	810	VN	40	23.47	0.012290	2.5	PASS

EGPRS1900	810	VN	50	8.04	0.004209	2.5	PASS
-----------	-----	----	----	------	----------	-----	------

-----End of Appendix-----