



TEST REPORT

Report Reference No...... : **TRE18010173** R/C.....: 56448
FCC ID..... : **ZSW-30-061**
Applicant's name..... : **b mobile HK Limited**
 Address.....: Flat 18; 14/F Block 1; Golden Industrial Building;16-26 Kwai Tak Street; Kwai Chung; New Territories; Hong Kong.
 Manufacturer.....: b mobile HK Limited
 Address.....: Flat 18; 14/F Block 1; Golden Industrial Building;16-26 Kwai Tak Street; Kwai Chung; New Territories; Hong Kong.
Test item description : **Mobile Phone**
 Trade Mark: Bmobile
 Model/Type reference.....: AX950
 Listed Model(s): -
Standard : **FCC 47 CFR Part2.1093**
IEEE 1528: 2013 **ANSI/IEEE C95.1: 1999**
 Date of receipt of test sample.....: Jan.23,2018
 Date of testing.....: Jan.24,2018- Feb.02,2018
 Date of issue.....: Feb.08,2018
Result.....: **PASS**

Compiled by
 (position+printedname+signature)....: File administrators:Xiaodong Zhao Xiaodong Zhao

Supervised by
 (position+printedname+signature)....: Test Engineer: Xiaodong Zhao Xiaodong Zhao

Approved by
 (position+printedname+signature)....: Manager: Hans Hu Hans Hu

Testing Laboratory Name : **Shenzhen Huatongwei International Inspection Co., Ltd**
 Address.....: 1/F, Bldg 3, Hongfa Hi-tech Industrial Park, Genyu Road, Tianliao, Gongming, Shenzhen, China

Shenzhen Huatongwei International Inspection Co., Ltd. All rights reserved.

This publication may be reproduced in whole or in part for non-commercial purposes as long as the Shenzhen Huatongwei International Inspection Co., Ltd is acknowledged as copyright owner and source of the material. Shenzhen Huatongwei International Inspection Co., Ltd takes no responsibility for and will not assume liability for damages resulting from the reader's interpretation of the reproduced material due to its placement and context.

The test report merely correspond to the test sample.

Contents

<u>1.</u>	<u>Test Standards and Report version</u>	<u>3</u>
1.1.	Test Standards	3
1.2.	Report version	3
<u>2.</u>	<u>Summary</u>	<u>4</u>
2.1.	Client Information	4
2.2.	Product Description	4
<u>3.</u>	<u>Test Environment</u>	<u>6</u>
3.1.	Test laboratory	6
3.2.	Test Facility	6
<u>4.</u>	<u>Equipments Used during the Test</u>	<u>7</u>
<u>5.</u>	<u>Measurement Uncertainty</u>	<u>8</u>
<u>6.</u>	<u>SAR Measurements System Configuration</u>	<u>10</u>
6.1.	SAR Measurement Set-up	10
6.2.	DASY5 E-field Probe System	11
6.3.	Phantoms	12
6.4.	Device Holder	12
<u>7.</u>	<u>SAR Test Procedure</u>	<u>13</u>
7.1.	Scanning Procedure	13
7.2.	Data Storage and Evaluation	15
<u>8.</u>	<u>Position of the wireless device in relation to the phantom</u>	<u>17</u>
8.1.	Head Position	17
8.2.	Body Position	18
8.3.	Hotspot Mode Exposure conditions	18
<u>9.</u>	<u>System Check</u>	<u>19</u>
9.1.	Tissue Dielectric Parameters	19
9.2.	SAR System Check	20
<u>10.</u>	<u>SAR Exposure Limits</u>	<u>28</u>
<u>11.</u>	<u>Conducted Power Measurement Results</u>	<u>29</u>
<u>12.</u>	<u>Maximum Tune-up Limit</u>	<u>33</u>
<u>13.</u>	<u>Antenna Location</u>	<u>35</u>
<u>14.</u>	<u>SAR Measurement Results</u>	<u>36</u>
<u>15.</u>	<u>Simultaneous Transmission analysis</u>	<u>54</u>
<u>16.</u>	<u>TestSetup Photos</u>	<u>59</u>
<u>17.</u>	<u>External and Internal Photos of the EUT</u>	<u>61</u>

1 . Test Standards and Report version

1.1. Test Standards

The tests were performed according to following standards:

[FCC 47 Part 2.1093](#) Radiofrequency Radiation Exposure Evaluation:Portable Devices

[IEEE Std C95.1, 1999](#): IEEE Standard for Safety Levels with Respect to Human Exposure to Radio Frequency Electromagnetic Fields, 3 KHz to 300 GHz.

[IEEE Std 1528™-2013](#): IEEE Recommended Practice for Determining the Peak Spatial-Average Specific Absorption Rate (SAR) in the Human Head from Wireless Communications Devices: Measurement Techniques.

[KDB 865664 D01 SAR Measurement 100 MHz to 6 GHz v01r04](#): SAR Measurement Requirements for 100 MHz to 6 GHz

[KDB 865664 D02 RF Exposure Reporting v01r02](#): RF Exposure Compliance Reporting and Documentation Considerations

[KDB 447498 D01 General RF Exposure Guidance v06](#): Mobile and Portable Device RF Exposure Procedures and Equipment Authorization Policies

[KDB 248227 D01 802.11 Wi-Fi SAR v02r02](#): SAR Measurement Procedures for 802.11 a/b/g Transmitters

[KDB 648474 D04 Handset SAR v01r03](#): SAR Evaluation Considerations for Wireless Handsets

[KDB 941225 D01 3G SAR Procedures v03r01](#): SAR Measurement Procedures for 3G Devices

[KDB 941225 D06 Hotspot Mode v02r01](#): SAR Evaluation Procedures for Portable Devices with Wireless Router Capabilities

1.2. Report version

Version No.	Date of issue	Description
00	Feb.08, 2018	Original

2. Summary

2.1. Client Information

Applicant:	b mobile HK Limited
Address:	Flat 18; 14/F Block 1; Golden Industrial Building;16-26 Kwai Tak Street; Kwai Chung; New Territories; Hong Kong.
Manufacturer:	b mobile HK Limited
Address:	Flat 18; 14/F Block 1; Golden Industrial Building;16-26 Kwai Tak Street; Kwai Chung; New Territories; Hong Kong.

2.2. Product Description

Name of EUT:	Mobile Phone			
Trade Mark:	Bmobile			
Model No.:	AX950			
Listed Model(s):	-			
Power supply:	DC 3.85V			
Device Category:	Portable			
Product stage:	Production unit			
RF Exposure Environment:	General Population / Uncontrolled			
IMEI:	865922019824910			
Device Class:	B			
Hardware version:	m603-01			
Software version:	Bmobile_AX950_Base_V002_MT6580_N0_V1.23.1@2018-01-06_09-0			
Maximum SAR Value				
Separation Distance:	Head:	0mm		
	Body:	10mm		
Max Report SAR Value (1g):	Test location:	PCE	DTS	Simultaneous TX
	Head:	0.248 W/Kg	0.291 W/Kg	0.539 W/Kg
	Body:	0.322 W/Kg	0.146 W/Kg	0.468 W/Kg
	Hotspot:	0.322 W/Kg	0.146 W/Kg	0.468 W/Kg
GSM				
Support Network:	GSM, GPRS,EGPRS			
Support Band:	GSM850, PCS1900			
Modulation:	GSM/GPRS/EGPRS: GMSK EGPRS:8PSK			
GPRS Class:	12			
EGPRS Class:	12			
Antenna type:	Integral Antenna			

WCDMA	
Operation Band:	WCDMA Band II, WCDMA Band V
Power Class:	Power Class 3
Modulation Type:	QPSK/16QAM/64QAM/HSUPA/HSDPA
DC-HSUPA Release Version:	Not Supported
Antenna type:	Integral Antenna
WIFI	
Supported type:	802.11b/802.11g/802.11n(HT20)/802.11n(HT40)
Modulation:	DSSS for 802.11b OFDM for 802.11g/802.11n(HT20)/802.11n(HT40)
Operation frequency:	2412MHz~2462MHz for 802.11b/802.11g/802.11n(HT20) 2422MHz~2452MHz for 802.11n(HT40)
Channel number:	11 for 802.11b/802.11g/802.11n(HT20) 9 for 802.11n(HT40)
Channel separation:	5MHz
Antenna type:	Integral Antenna
Bluetooth	
Version:	Supported BT4.0+EDR
Modulation:	GFSK, $\pi/4$ DQPSK, 8DPSK
Operation frequency:	2402MHz~2480MHz
Channel number:	79
Channel separation:	1MHz
Antenna type:	Integral Antenna
Bluetooth-BLE	
Version:	Supported BT4.0+BLE
Modulation:	GFSK
Operation frequency:	2402MHz~2480MHz
Channel number:	40
Channel separation:	2MHz
Antenna type:	Integral Antenna
<i>Remark:</i>	
<ol style="list-style-type: none"> 1. The EUT battery must be fully charged and checked periodically during the test to ascertain uniform power 2. The Test EUT support two SIM card(SIM1,SIM2),so all the tests are performed at each SIM card (SIM1,SIM2) mode, the datum recorded is the worst case for all the mode at SIM1 Card mode. 	

3. Test Environment

3.1. Test laboratory

Laboratory: Shenzhen Huatongwei International Inspection Co., Ltd.

Address: 1/F, Bldg 3, Hongfa Hi-tech Industrial Park, Genyu Road, Tianliao, Gongming, Shenzhen, China

3.2. Test Facility

CNAS-Lab Code: L1225

Shenzhen Huatongwei International Inspection Co., Ltd. has been assessed and proved to be in compliance with CNAS-CL01 Accreditation Criteria for Testing and Calibration Laboratories (identical to ISO/IEC17025:2005 General Requirements) for the Competence of Testing and Calibration Laboratories

A2LA-Lab Cert. No. 3902.01

Shenzhen Huatongwei International Inspection Co., Ltd. EMC Laboratory has been accredited by A2LA for technical competence in the field of electrical testing, and proved to be in compliance with ISO/IEC 17025: 2005 General Requirements for the Competence of Testing and Calibration Laboratories and any additional program requirements in the identified field of testing.

FCC-Registration No.: 762235

Shenzhen Huatongwei International Inspection Co., Ltd. EMC Laboratory has been registered and fully described in a report filed with the FCC (Federal Communications Commission). The acceptance letter from the FCC is maintained in our files.

IC-Registration No.:5377B

Two 3m Alternate Test Site of Shenzhen Huatongwei International Inspection Co., Ltd. has been registered by Certification and Engineering Bureau of Industry Canada for the performance of radiated measurements with Registration No.: 5377B

ACA

Shenzhen Huatongwei International Inspection Co., Ltd. EMC Laboratory can also perform testing for the Australian C-Tick mark as a result of our A2LA accreditation.

4. Equipments Used during the Test

Test Equipment	Manufacturer	Type/Model	Serial Number	Calibration	
				Last Calibration	Calibration Interval
Data Acquisition Electronics DAEx	SPEAG	DAE4	1315	2017/08/15	1
E-field Probe	SPEAG	EX3DV4	3842	2017/08/15	1
System Validation Dipole	SPEAG	D835V2	4d134	2017/10/27	3
System Validation Dipole	SPEAG	D1900V2	5d150	2017/10/26	3
System Validation Dipole	SPEAG	D2450V2	884	2017/10/26	3
Dielectric Assessment Kit	SPEAG	DAK-3.5	1038	2016/08/25	3
Network analyzer	Agilent	N9923A	MY51491493	2017/09/05	1
Power meter	Agilent	N1914A	MY52090010	2017/03/23	1
Power sensor	Agilent	E9304A	MY52140008	2017/03/23	1
Power sensor	Agilent	E9301H	MY54470001	2017/06/02	1
Signal Generator	ROHDE & SCHWARZ	SMBV100A	175248	2017/09/02	1
Universal Radio Communication Tester	ROHDE & SCHWARZ	CMU200	112012	2017/10/21	1
Dual Directional Coupler	Agilent	772D	MY46151257	2017/03/23	1
Dual Directional Coupler	Agilent	778D	MY48220612	2017/03/23	1
Power Amplifier	Mini-Circuits	ZHL-42W	QA1202003	2017/11/27	1

Note:

1. *The Probe, Dipole and DAE calibration reference to the Appendix A.*
2. *Referring to KDB865664 D01, the dipole calibration interval can be extended to 3 years with justifiatio. The dipole are also not physically damaged or repaired during the interval.*

5. Measurement Uncertainty

Measurement Uncertainty										
No.	Error Description	Type	Uncertainty Value	Probably Distribution	Div.	(Ci) 1g	(Ci) 10g	Std. Unc. (1g)	Std. Unc. (10g)	Degree of freedom
Measurement System										
1	Probe calibration	B	6.0%	N	1	1	1	6.0%	6.0%	∞
2	Axial isotropy	B	4.70%	R	$\sqrt{3}$	0.7	0.7	1.90%	1.90%	∞
3	Hemispherical isotropy	B	9.60%	R	$\sqrt{3}$	0.7	0.7	3.90%	3.90%	∞
4	Boundary Effects	B	1.00%	R	$\sqrt{3}$	1	1	0.60%	0.60%	∞
5	Probe Linearity	B	4.70%	R	$\sqrt{3}$	1	1	2.70%	2.70%	∞
6	Detection limit	B	1.00%	R	$\sqrt{3}$	1	1	0.60%	0.60%	∞
7	RF ambient conditions-noise	B	0.00%	R	$\sqrt{3}$	1	1	0.00%	0.00%	∞
8	RF ambient conditions-reflection	B	0.00%	R	$\sqrt{3}$	1	1	0.00%	0.00%	∞
9	Response time	B	0.80%	R	$\sqrt{3}$	1	1	0.50%	0.50%	∞
10	Integration time	B	5.00%	R	$\sqrt{3}$	1	1	2.90%	2.90%	∞
11	RF ambient	B	3.00%	R	$\sqrt{3}$	1	1	1.70%	1.70%	∞
12	Probe positioned mech. restrictions	B	0.40%	R	$\sqrt{3}$	1	1	0.20%	0.20%	∞
13	Probe positioning with respect to phantom shell	B	2.90%	R	$\sqrt{3}$	1	1	1.70%	1.70%	∞
14	Max.SAR evaluation	B	3.90%	R	$\sqrt{3}$	1	1	2.30%	2.30%	∞
Test Sample Related										
15	Test sample positioning	A	1.86%	N	1	1	1	1.86%	1.86%	∞
16	Device holder uncertainty	A	1.70%	N	1	1	1	1.70%	1.70%	∞
17	Drift of output power	B	5.00%	R	$\sqrt{3}$	1	1	2.90%	2.90%	∞
Phantom and Set-up										
18	Phantom uncertainty	B	4.00%	R	$\sqrt{3}$	1	1	2.30%	2.30%	∞
19	Liquid conductivity (target)	B	5.00%	R	$\sqrt{3}$	0.64	0.43	1.80%	1.20%	∞
20	Liquid conductivity (meas.)	A	0.50%	N	1	0.64	0.43	0.32%	0.26%	∞
21	Liquid permittivity (target)	B	5.00%	R	$\sqrt{3}$	0.64	0.43	1.80%	1.20%	∞
22	Liquid permittivity (meas.)	A	0.16%	N	1	0.64	0.43	0.10%	0.07%	∞
Combined standard uncertainty		$u_c = \sqrt{\sum_{i=1}^{22} c_i^2 u_i^2}$		/	/	/	/	9.79%	9.67%	∞
Expanded uncertainty (confidence interval of 95 %)		$u_e = 2u_c$		R	K=2	/	/	19.57%	19.34%	∞

System Check Uncertainty										
No.	Error Description	Type	Uncertainty Value	Probably Distribution	Div.	(Ci) 1g	(Ci) 10g	Std. Unc. (1g)	Std. Unc. (10g)	Degree of freedom
Measurement System										
1	Probe calibration	B	6.0%	N	1	1	1	6.0%	6.0%	∞
2	Axial isotropy	B	4.70%	R	$\sqrt{3}$	0.7	0.7	1.90%	1.90%	∞
3	Hemispherical isotropy	B	9.60%	R	$\sqrt{3}$	0.7	0.7	3.90%	3.90%	∞
4	Boundary Effects	B	1.00%	R	$\sqrt{3}$	1	1	0.60%	0.60%	∞
5	Probe Linearity	B	4.70%	R	$\sqrt{3}$	1	1	2.70%	2.70%	∞
6	Detection limit	B	1.00%	R	$\sqrt{3}$	1	1	0.60%	0.60%	∞
7	RF ambient conditions-noise	B	0.00%	R	$\sqrt{3}$	1	1	0.00%	0.00%	∞
8	RF ambient conditions-reflection	B	0.00%	R	$\sqrt{3}$	1	1	0.00%	0.00%	∞
9	Response time	B	0.80%	R	$\sqrt{3}$	1	1	0.50%	0.50%	∞
10	Integration time	B	5.00%	R	$\sqrt{3}$	1	1	2.90%	2.90%	∞
11	RF ambient	B	3.00%	R	$\sqrt{3}$	1	1	1.70%	1.70%	∞
12	Probe positioned mech. restrictions	B	0.40%	R	$\sqrt{3}$	1	1	0.20%	0.20%	∞
13	Probe positioning with respect to phantom shell	B	2.90%	R	$\sqrt{3}$	1	1	1.70%	1.70%	∞
14	Max.SAR evaluation	B	3.90%	R	$\sqrt{3}$	1	1	2.30%	2.30%	∞
System validation source-dipole										
15	Deviation of experimental dipole from numerical dipole	A	1.58%	N	1	1	1	1.58%	1.58%	∞
16	Dipole axis to liquid distance	A	1.35%	N	1	1	1	1.35%	1.35%	∞
17	Input power and SAR drift	B	4.00%	R	$\sqrt{3}$	1	1	2.30%	2.30%	∞
Phantom and Set-up										
18	Phantom uncertainty	B	4.00%	R	$\sqrt{3}$	1	1	2.30%	2.30%	∞
20	Liquid conductivity (meas.)	A	0.50%	N	1	0.64	0.43	0.32%	0.26%	∞
22	Liquid permittivity (meas.)	A	0.16%	N	1	0.64	0.43	0.10%	0.07%	∞
Combined standard uncertainty		$u_c = \sqrt{\sum_{i=1}^{22} c_i^2 u_i^2}$		/	/	/	/	8.80%	8.79%	∞
Expanded uncertainty (confidence interval of 95 %)		$u_e = 2u_c$		R	K=2	/	/	17.59%	17.58%	∞

6. SAR Measurements System Configuration

6.1. SAR Measurement Set-up

The DASY5 system for performing compliance tests consists of the following items:

A standard high precision 6-axis robot (Stäubli RX family) with controller and software. An arm extension for accommodating the data acquisition electronics (DAE).

A dosimetric probe, i.e. an isotropic E-field probe optimized and calibrated for usage in tissue simulating liquid. The probe is equipped with an optical surface detector system.

A data acquisition electronic (DAE) which performs the signal amplification, signal multiplexing, AD-conversion, offset measurements, mechanical surface detection, collision detection, etc. The unit is battery powered with standard or rechargeable batteries. The signal is optically transmitted to the EOC.

A unit to operate the optical surface detector which is connected to the EOC.

The Electro-Optical Coupler (EOC) performs the conversion from the optical into a digital electric signal of the DAE. The EOC is connected to the DASY5 measurement server.

The DASY5 measurement server, which performs all real-time data evaluation for field measurements and surface detection, controls robot movements and handles safety operation. A computer operating Windows 2003.

DASY5 software and SEMCAD data evaluation software.

Remote control with teach panel and additional circuitry for robot safety such as warning lamps, etc.

The generic twin phantom enabling the testing of left-hand and right-hand usage.

The device holder for handheld Mobile Phones.

Tissue simulating liquid mixed according to the given recipes.

System validation dipoles allowing to validate the proper functioning of the system.

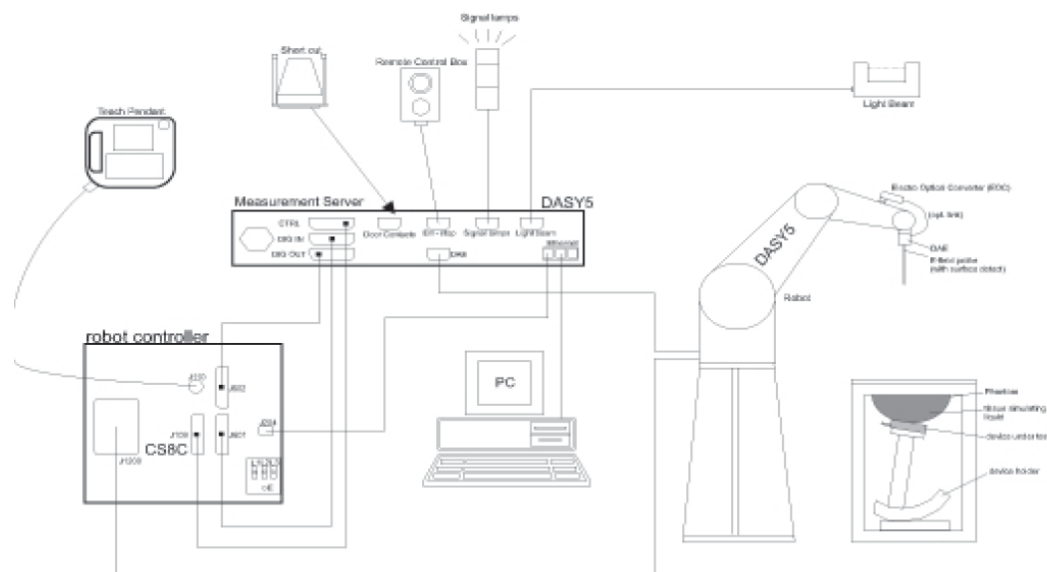

6.2. DASY5 E-field Probe System

The SAR measurements were conducted with the dosimetric probe EX3DV4 (manufactured by SPEAG), designed in the classical triangular configuration and optimized for dosimetric evaluation.

● Probe Specification

Construction	Symmetrical design with triangular core Interleaved sensors Built-in shielding against static charges PEEK enclosure material (resistant to organic solvents, e.g., DGBE)
Calibration	ISO/IEC 17025 calibration service available.
Frequency	10 MHz to 6 GHz; Linearity: ± 0.2 dB (30 MHz to 6 GHz)
Directivity	± 0.3 dB in HSL (rotation around probe axis) ± 0.5 dB in tissue material (rotation normal to probe axis)
Dynamic Range	10 μ W/g to > 100 W/kg; Linearity: ± 0.2 dB
Dimensions	Overall length: 337 mm (Tip: 20 mm) Tip diameter: 2.5 mm (Body: 12 mm) Distance from probe tip to dipole centers: 1.0 mm
Application	General dosimetry up to 6 GHz Dosimetry in strong gradient fields Compliance tests of Mobile Phones
Compatibility	DASY3, DASY4, DASY52 SAR and higher, EASY4/MRI



● Isotropic E-Field Probe

The isotropic E-Field probe has been fully calibrated and assessed for isotropicity, and boundary effect within a controlled environment. Depending on the frequency for which the probe is calibrated the method utilized for calibration will change.

The E-Field probe utilizes a triangular sensor arrangement as detailed in the diagram below:

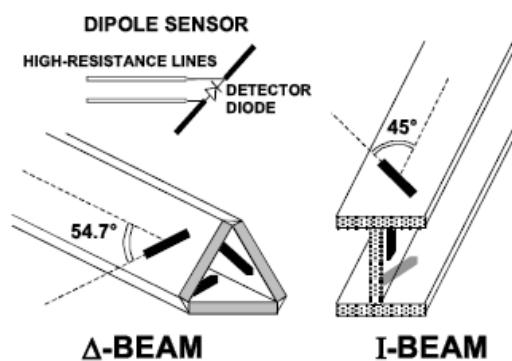

6.3. Phantoms

The phantom used for all tests i.e. for both system checks and device testing, was the twin-headed "SAM Phantom", manufactured by SPEAG. The SAM twin phantom is a fiberglass shell phantom with 2mm shell thickness (except the ear region, where shell thickness increases to 6mm).

System checking was performed using the flat section, whilst Head SAR tests used the left and right head profile sections. Body SAR testing also used the flat section between the head profiles.



SAM Twin Phantom

6.4. Device Holder

The device was placed in the device holder (illustrated below) that is supplied by SPEAG as an integral part of the DASY system.

The DASY device holder is designed to cope with the different positions given in the standard. It has two scales for device rotation (with respect to the body axis) and device inclination (with respect to the line between the ear reference points). The rotation centers for both scales is the ear reference point (ERP). Thus the device needs no repositioning when changing the angles.



Device holder supplied by SPEAG

7. SAR Test Procedure

7.1. Scanning Procedure

The DASY5 installation includes predefined files with recommended procedures for measurements and validation. They are read-only document files and destined as fully defined but unmeasured masks. All test positions (head or body-worn) are tested with the same configuration of test steps differing only in the grid definition for the different test positions.

The “reference” and “drift” measurements are located at the beginning and end of the batch process. They measure the field drift at one single point in the liquid over the complete procedure. The indicated drift is mainly the variation of the DUT’s output power and should vary max. $\pm 5\%$.

The “surface check” measurement tests the optical surface detection system of the DASY5 system by repeatedly detecting the surface with the optical and mechanical surface detector and comparing the results. The output gives the detecting heights of both systems, the difference between the two systems and the standard deviation of the detection repeatability. Air bubbles or refraction in the liquid due to separation of the sugar-water mixture gives poor repeatability (above $\pm 0.1\text{mm}$). To prevent wrong results tests are only executed when the liquid is free of air bubbles. The difference between the optical surface detection and the actual surface depends on the probe and is specified with each probe (It does not depend on the surface reflectivity or the probe angle to the surface within $\pm 30^\circ$.)

Area Scan

The Area Scan is used as a fast scan in two dimensions to find the area of high field values before running a detailed measurement around the hot spot. Before starting the area scan a grid spacing of 15 mm x 15 mm is set. During the scan the distance of the probe to the phantom remains unchanged. After finishing area scan, the field maxima within a range of 2 dB will be ascertained.

Zoom Scan

After the maximum interpolated values were calculated between the points in the cube, the SAR was averaged over the spatial volume (1g or 10g) using a 3D-Spline interpolation algorithm. The 3D-spline is composed of three one-dimensional splines with the “Not a knot” condition (in x, y, and z directions). The volume was then integrated with the trapezoidal algorithm.

Spatial Peak Detection

The procedure for spatial peak SAR evaluation has been implemented and can determine values of masses of 1g and 10g, as well as for user-specific masses. The DASY5 system allows evaluations that combine measured data and robot positions, such as:

- maximum search
- extrapolation
- boundary correction
- peak search for averaged SAR

During a maximum search, global and local maxima searches are automatically performed in 2-D after each Area Scan measurement with at least 6 measurement points. It is based on the evaluation of the local SAR gradient calculated by the Quadratic Shepard’s method. The algorithm will find the global maximum and all local maxima within -2 dB of the global maxima for all SAR distributions.

Extrapolation routines are used to obtain SAR values between the lowest measurement points and the inner phantom surface. The extrapolation distance is determined by the surface detection distance and the probe sensor offset. Several measurements at different distances are necessary for the extrapolation. Extrapolation routines require at least 10 measurement points in 3-D space.

They are used in the Zoom Scan to obtain SAR values between the lowest measurement points and the inner phantom surface. The routine uses the modified Quadratic Shepard’s method for extrapolation.

A Z-axis scan measures the total SAR value at the x-and y-position of the maximum SAR value found during the cube scan. The probe is moved away in z-direction from the bottom of the SAM phantom in 5mm steps.

Table 1: Area and Zoom Scan Resolutions per FCC KDB Publication 865664 D01v04

		≤ 3 GHz	> 3 GHz	
Maximum distance from closest measurement point (geometric center of probe sensors) to phantom surface		5 mm \pm 1 mm	$\frac{1}{2} \cdot \delta \cdot \ln(2)$ mm \pm 0.5 mm	
Maximum probe angle from probe axis to phantom surface normal at the measurement location		30° \pm 1°	20° \pm 1°	
Maximum area scan spatial resolution: Δx_{Area} , Δy_{Area}		≤ 2 GHz: ≤ 15 mm 2 – 3 GHz: ≤ 12 mm	3 – 4 GHz: ≤ 12 mm 4 – 6 GHz: ≤ 10 mm	
		When the x or y dimension of the test device, in the measurement plane orientation, is smaller than the above, the measurement resolution must be \leq the corresponding x or y dimension of the test device with at least one measurement point on the test device.		
Maximum zoom scan spatial resolution: Δx_{Zoom} , Δy_{Zoom}		≤ 2 GHz: ≤ 8 mm 2 – 3 GHz: ≤ 5 mm*	3 – 4 GHz: ≤ 5 mm* 4 – 6 GHz: ≤ 4 mm*	
Maximum zoom scan spatial resolution, normal to phantom surface	uniform grid: $\Delta z_{Zoom}(n)$	≤ 5 mm	3 – 4 GHz: ≤ 4 mm 4 – 5 GHz: ≤ 3 mm 5 – 6 GHz: ≤ 2 mm	
	graded grid	$\Delta z_{Zoom}(1)$: between 1 st two points closest to phantom surface	≤ 4 mm	3 – 4 GHz: ≤ 3 mm 4 – 5 GHz: ≤ 2.5 mm 5 – 6 GHz: ≤ 2 mm
		$\Delta z_{Zoom}(n>1)$: between subsequent points	$\leq 1.5 \cdot \Delta z_{Zoom}(n-1)$ mm	
Minimum zoom scan volume	x, y, z	≥ 30 mm	3 – 4 GHz: ≥ 28 mm 4 – 5 GHz: ≥ 25 mm 5 – 6 GHz: ≥ 22 mm	
<p>Note: δ is the penetration depth of a plane-wave at normal incidence to the tissue medium; see IEEE Std 1528-2013 for details.</p> <p>* When zoom scan is required and the <i>reported</i> SAR from the <i>area scan based 1-g SAR estimation</i> procedures of KDB Publication 447498 is ≤ 1.4 W/kg, ≤ 8 mm, ≤ 7 mm and ≤ 5 mm zoom scan resolution may be applied, respectively, for 2 GHz to 3 GHz, 3 GHz to 4 GHz and 4 GHz to 6 GHz.</p>				

7.2. Data Storage and Evaluation

Data Storage

The DASY5 software stores the acquired data from the data acquisition electronics as raw data (in microvolt readings from the probe sensors),s together with all necessary software parameters for the data evaluation (probe calibration data, liquid parameters and device frequency and modulation data) in measurement files with the extension “.DA4”. The software evaluates the desired unit and format for output each time the data is visualized or exported. This allows verification of the complete software setup even after the measurement and allows correction of incorrect parameter settings. For example, if a measurement has been performed with a wrong crest factor parameter in the device setup, the parameter can be corrected afterwards and the data can be re-evaluated.

The measured data can be visualized or exported in different units or formats, depending on the selected probe type ([V/m], [A/m], [°C], [W/kg], [mW/cm²], [dBrel], etc.). Some of these units are not available in certain situations or show meaningless results, e.g., a SAR output in a lossless media will always be zero. Raw data can also be exported to perform the evaluation with other software packages.

Data Evaluation

The SEMCAD software automatically executes the following procedures to calculate the field units from the microvolt readings at the probe connector. The parameters used in the evaluation are stored in the configuration modules of the software:

Probe parameters:	Sensitivity:	Normi, ai0, ai1, ai2
	Conversion factor:	ConvFi
	Diode compression point:	Dcpi
Device parameters:	Frequency:	f
	Crest factor:	cf
Media parameters:	Conductivity:	σ
	Density:	ρ

These parameters must be set correctly in the software. They can be found in the component documents or they can be imported into the software from the configuration files issued for the DASY5 components. In the direct measuring mode of the multimeter option, the parameters of the actual system setup are used. In the scan visualization and export modes, the parameters stored in the corresponding document files are used.

The first step of the evaluation is a linearization of the filtered input signal to account for the compression characteristics of the detector diode. The compensation depends on the input signal, the diode type and the DC-transmission factor from the diode to the evaluation electronics. If the exciting field is pulsed, the crest factor of the signal must be known to correctly compensate for peak power. The formula for each channel can be given as:

$$V_i = U_i + U_i^2 \cdot \frac{cf}{dcp_i}$$

Vi:	compensated signal of channel (i = x, y, z)
Ui:	input signal of channel (i = x, y, z)
cf:	crest factor of exciting field (DASY parameter)
dcp _i :	diode compression point (DASY parameter)

From the compensated input signals the primary field data for each channel can be evaluated:

$$E - \text{fieldprobes} : \quad E_i = \sqrt{\frac{V_i}{Norm_i \cdot ConvF}}$$

$$H - \text{fieldprobes} : \quad H_i = \sqrt{V_i} \cdot \frac{a_{i0} + a_{i1}f + a_{i2}f^2}{f}$$

Vi:	compensated signal of channel (i = x, y, z)
Normi:	sensor sensitivity of channel (i = x, y, z), [mV/(V/m) ²] for E-field Probes
ConvF:	sensitivity enhancement in solution
aij:	sensor sensitivity factors for H-field probes
f:	carrier frequency [GHz]
Ei:	electric field strength of channel i in V/m
Hi:	magnetic field strength of channel i in A/m

The RSS value of the field components gives the total field strength (Hermitian magnitude):

$$E_{tot} = \sqrt{E_x^2 + E_y^2 + E_z^2}$$

The primary field data are used to calculate the derived field units.

$$SAR = E_{tot}^2 \cdot \frac{\sigma}{\rho \cdot 1'000}$$

SAR: local specific absorption rate in W/kg
Etot: total field strength in V/m
 σ : conductivity in [mho/m] or [Siemens/m]
 ρ : equivalent tissue density in g/cm³

Note that the density is normally set to 1 (or 1.06), to account for actual brain density rather than the density of the simulation liquid.

8. Position of the wireless device in relation to the phantom

8.1. Head Position

The wireless device define two imaginary lines on the handset, the vertical centreline and the horizontal line, for the handset in vertical orientation as shown in Figures 5a and 5b.

The vertical centreline passes through two points on the front side of the handset: the midpoint of the width W_t of the handset at the level of the acoustic output (point A in Figures 5a and 5b), and the midpoint of the width W_b of the bottom of the handset (point B).

The horizontal line is perpendicular to the vertical centreline and passes through the centre of the acoustic output (see Figures 5a and 5b). The two lines intersect at point A.

Note that for many handsets, point A coincides with the centre of the acoustic output. However, the acoustic output may be located elsewhere on the horizontal line. Also note that the vertical centreline is not necessarily parallel to the front face of the handset (see Figure 5b), especially for clam-shell handsets, handsets with flip cover pieces, and other irregularly shaped handsets.

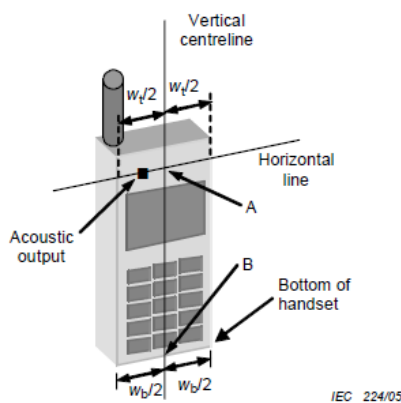

Figures 5a

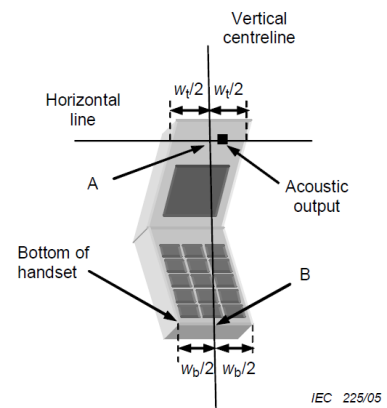

Figures 5b

- W_t Width of the handset at the level of the acoustic
- W_b Width of the bottom of the handset
- A Midpoint of the width w_t of the handset at the level of the acoustic output
- B Midpoint of the width w_b of the bottom of the handset

Cheek position

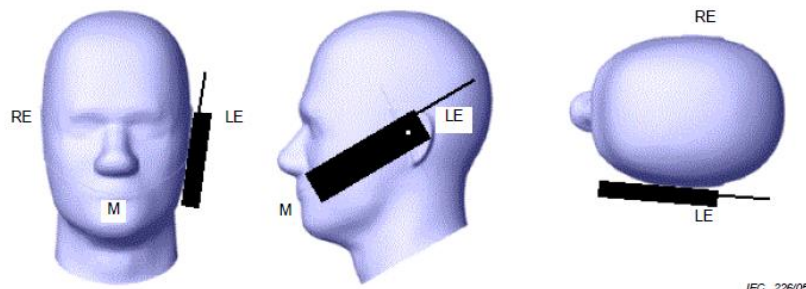

Picture 2 Cheek position of the wireless device on the left side of SAM

Tilt position

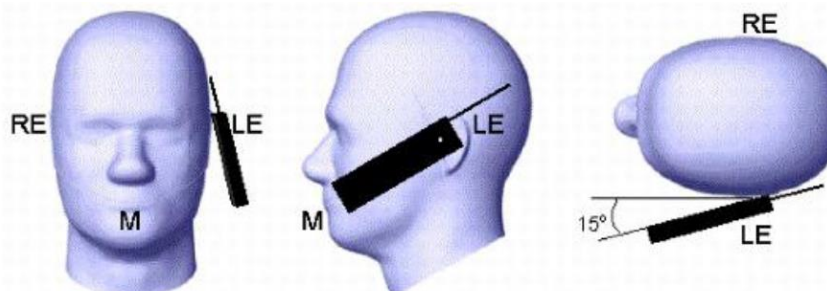

Picture 3 Tilt position of the wireless device on the left side of SAM

8.2. Body Position

Devices that support transmission while used with body-worn accessories must be tested for body-worn accessory SAR compliance, typically according to the smallest test separation distance required for the group of body-worn accessories with similar operating and exposure characteristics. Devices that are designed to operate on the body of users using lanyards and straps or without requiring additional body-worn accessories must be tested for SAR compliance using a conservative minimum test separation distance $\leq 10 \text{ mm}$ to support compliance.

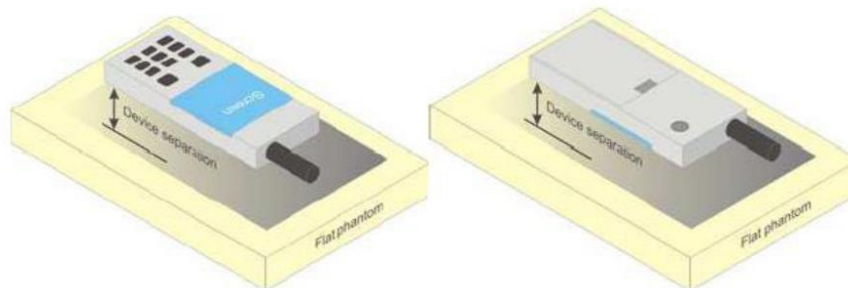

Picture 4 Test positions for body-worn devices

8.3. Hotspot Mode Exposure conditions

The hotspot mode and body-worn accessory SAR test configurations may overlap for handsets. When the same wireless mode transmission configurations for voice and data are required for SAR measurements, the more conservative configuration with a smaller separation distance should be tested for the overlapping SAR configurations. This typically applies to the back and front surfaces of a handset when SAR is required for both hotspot mode and body-worn accessory exposure conditions. Depending on the form factor and dimensions of a device, the test separation distance used for hotspot mode SAR measurement is either **10 mm** or that used in the body-worn accessory configuration, whichever is less for devices with dimension $> 9 \text{ cm} \times 5 \text{ cm}$. For smaller devices with dimensions $\leq 9 \text{ cm} \times 5 \text{ cm}$ because of a greater potential for next to body use a test separation of $\leq 5 \text{ mm}$ must be used.

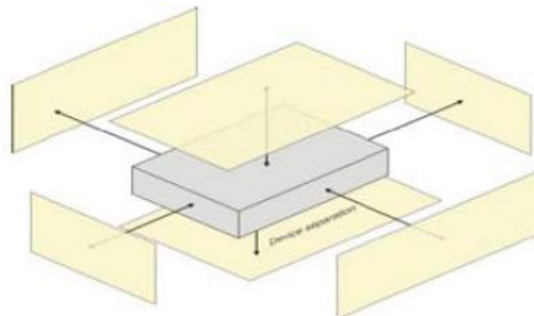

Picture 5 Test positions for Hotspot Mode

9. System Check

9.1. Tissue Dielectric Parameters

The liquid is consisted of water,salt,Glycol,Sugar,Preventol and Cellulose.The liquid has previously been proven to be suited for worst-case. It's satisfying the latest tissue dielectric parameters requirements proposed by the KDB865664.

Tissue dielectric parameters for head and body phantoms				
Target Frequency	Head		Body	
(MHz)	ϵ_r	σ (s/m)	ϵ_r	σ (s/m)
835	41.5	0.90	55.2	0.97
1800-2000	40.0	1.40	53.3	1.52
2450	39.2	1.80	52.7	1.95

Check Result:

Dielectric performance of Head tissue simulating liquid									
Frequency (MHz)	ϵ_r		σ (s/m)		Delta (ϵ_r)	Delta (σ)	Limit	Temp (°C)	Date
	Target	Measured	Target	Measured					
835	41.50	41.62	0.90	0.92	0.29%	2.22%	±5%	21	2018-01-29
1900	40.00	40.05	1.40	1.42	0.12%	1.43%	±5%	21	2018-01-30
2450	39.20	39.11	1.80	1.79	-0.23%	-0.56%	±5%	21	2018-01-31

Dielectric performance of Body tissue simulating liquid									
Frequency (MHz)	ϵ_r		σ (s/m)		Delta (ϵ_r)	Delta (σ)	Limit	Temp (°C)	Date
	Target	Measured	Target	Measured					
835	55.20	55.15	0.97	0.96	-0.09%	-1.03%	±5%	21	2018-01-29
1900	53.30	53.12	1.52	1.53	-0.34%	0.66%	±5%	21	2018-01-30
2450	52.70	52.52	1.95	1.94	-0.34%	-0.51%	±5%	21	2018-01-31

9.2. SAR System Check

The purpose of the system check is to verify that the system operates within its specifications at the device test frequency. The system check is simple check of repeatability to make sure that the system works correctly at the time of the compliance test;

System check results have to be equal or near the values determined during dipole calibration with the relevant liquids and test system ($\pm 10\%$).

System check is performed regularly on all frequency bands where tests are performed with the DASY5 system.

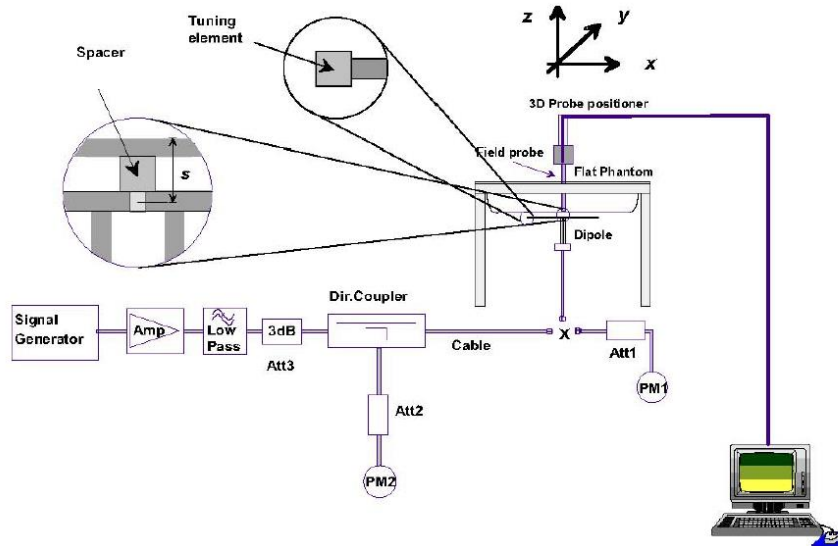

The output power on dipole port must be calibrated to 24 dBm (250mW) before dipole is connected.

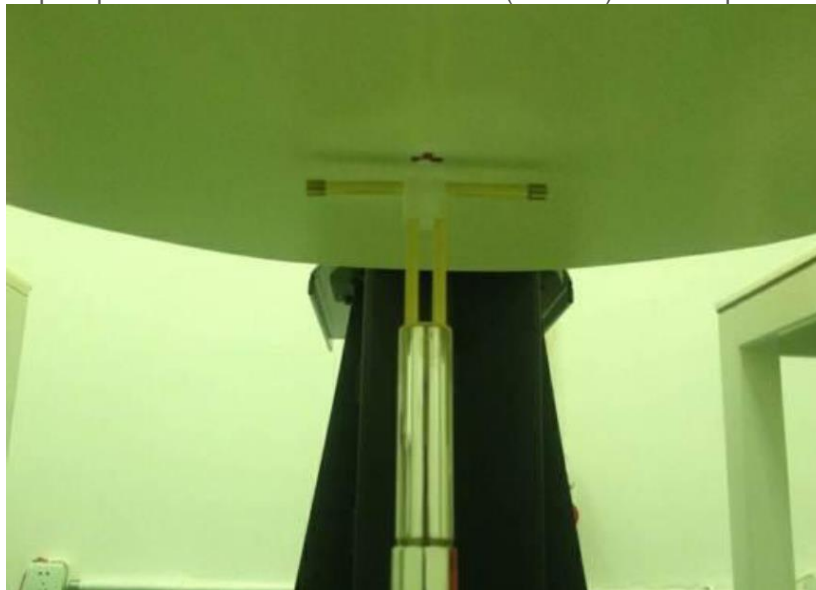

Photo of Dipole Setup

Check Result:

Head									
Frequency (MHz)	1g SAR		10g SAR		Delta (1g)	Delta (10g)	Limit	Temp (°C)	Date
	Target	Measured	Target	Measured					
835	2.38	2.34	1.54	1.52	-1.68%	-1.30%	±10%	21	2018-01-29
1900	10.10	9.72	5.23	5.16	-3.76%	-1.34%	±10%	21	2018-01-30
2450	12.90	12.40	6.07	5.80	-3.88%	-4.45%	±10%	21	2018-01-31

Body									
Frequency (MHz)	1g SAR		10g SAR		Delta (1g)	Delta (10g)	Limit	Temp (°C)	Date
	Target	Measured	Target	Measured					
835	2.39	2.47	1.57	1.59	3.35%	1.27%	±10%	21	2018-01-29
1900	10.20	10.30	5.29	5.34	0.98%	0.95%	±10%	21	2018-01-30
2450	12.60	12.50	5.88	5.76	-0.79%	-2.04%	±10%	21	2018-01-31

Plots of System Performance Check

System Performance Check at 835 MHz Head

DUT: Dipole 835 MHz; Type: D835V2; Serial: 4d134

Date: 2018-01-29

Communication System: CW; Frequency: 835 MHz; Duty Cycle: 1:1

Medium parameters used (interpolated): $f = 835$ MHz; $\sigma = 0.92$ S/m; $\epsilon_r = 41.62$; $\rho = 1000$ kg/m³

Phantom section: Flat Section

DASY5 Configuration:

- Probe: EX3DV4 - SN3842; ConvF(9.15, 9.15, 9.15); Calibrated: 2017/8/15;
- Sensor-Surface: 1.4mm (Mechanical Surface Detection)
- Electronics: DAE4 Sn1315; Calibrated: 2017/8/15
- Phantom: SAM 1; Type: SAM;
- Measurement SW: DASY52, Version 52.8 (2); SEMCAD X Version 14.6.6 (6824)

Area Scan (7x10x1): Measurement grid: dx=15.00 mm, dy=15.00 mm

Maximum value of SAR (interpolated) = 2.834 W/kg

Zoom Scan (5x5x7)/Cube 0: Measurement grid: dx=8mm, dy=8mm, dz=5mm

Reference Value = 49.865 V/m; Power Drift = -0.01 dB

Peak SAR (extrapolated) = 3.286 W/kg

SAR(1 g) = 2.34 W/kg; SAR(10 g) = 1.52 W/kg

Maximum value of SAR (measured) = 2.825 W/kg

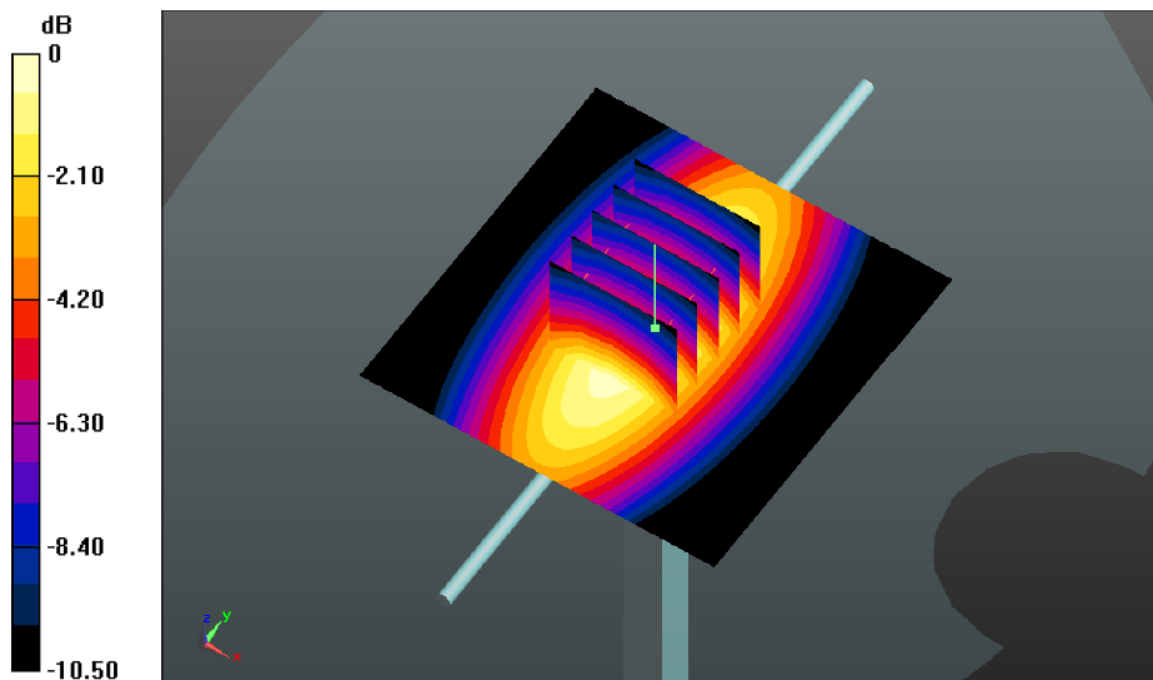

System Performance Check 835MHz Head 250mW

System Performance Check at 835 MHz Body

DUT: Dipole 835 MHz; Type: D835V2; Serial: 4d134

Date: 2018-01-29

Communication System: CW; Frequency: 835 MHz; Duty Cycle: 1:1

Medium parameters used (interpolated): $f = 835$ MHz; $\sigma = 0.96$ S/m; $\epsilon_r = 55.15$; $\rho = 1000$ kg/m³

Phantom section: Flat Section

DASY5 Configuration:

- Probe: EX3DV4 - SN3842; ConvF(9.02, 9.02, 9.02); Calibrated: 2017/8/15;
- Sensor-Surface: 1.4mm (Mechanical Surface Detection)
- Electronics: DAE4 Sn1315; Calibrated: 2017/8/15
- Phantom: SAM 2; Type: SAM;
- Measurement SW: DASY52, Version 52.8 (2); SEMCAD X Version 14.6.6 (6824)

Area Scan (7x10x1): Measurement grid: dx=15.00 mm, dy=15.00 mm

Maximum value of SAR (interpolated) = 2.888 W/kg

Zoom Scan (5x5x7)/Cube 0: Measurement grid: dx=8mm, dy=8mm, dz=5mm

Reference Value = 50.236 V/m; Power Drift = -0.02 dB

Peak SAR (extrapolated) = 3.339 W/kg

SAR(1 g) = 2.47 W/kg; SAR(10 g) = 1.59 W/kg

Maximum value of SAR (measured) = 2.871 W/kg

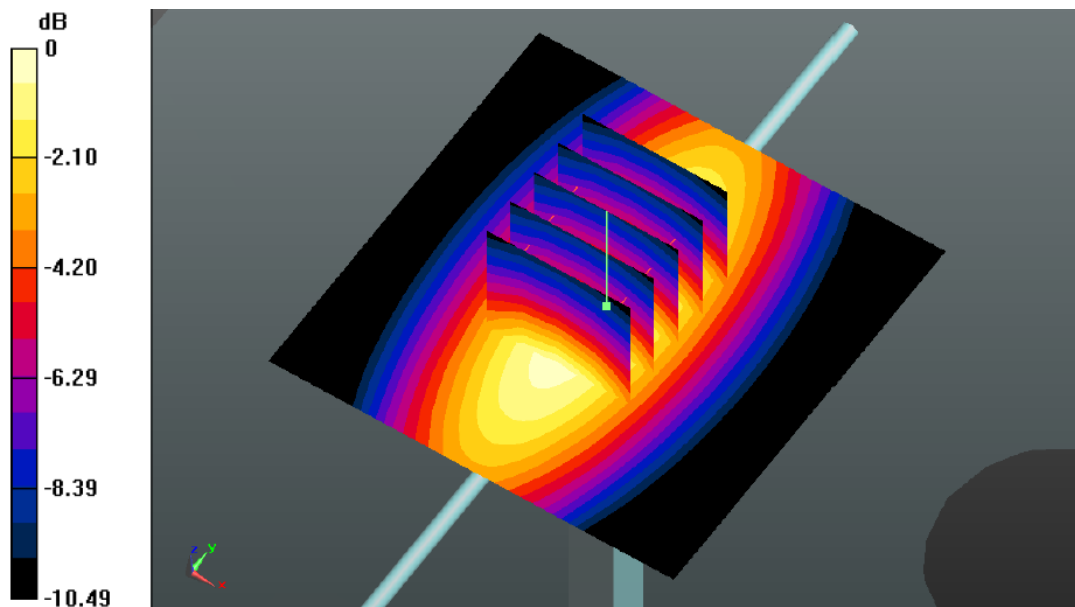

System Performance Check 835MHz Body 250mW

System Performance Check at 1900 MHz Head

DUT: Dipole 1900 MHz; Type: D1900V2; Serial: 5d150

Date:2018-01-30

Communication System: CW; Frequency: 1900 MHz;Duty Cycle: 1:1

Medium parameters used (interpolated): $f = 1900$ MHz; $\sigma = 1.42$ S/m; $\epsilon_r = 40.05$; $\rho = 1000$ kg/m³

Phantom section: Flat Section

DASY5 Configuration:

Probe: EX3DV4 - SN3842; ConvF(7.58, 7.58, 7.58); Calibrated: 2017/8/15;

Sensor-Surface: 1.4mm (Mechanical Surface Detection)

Electronics: DAE4 Sn1315; Calibrated: 2017/8/15

Phantom: SAM 1; Type: SAM;

Measurement SW: DASY52, Version 52.8 (1); SEMCAD X Version 14.6.5 (6469)

Area Scan (7x10x1):Measurement grid: dx=15.00 mm, dy=15.00 mm

Maximum value of SAR (interpolated) = 10.61 W/kg

Zoom Scan (5x5x7)/Cube 0: Measurement grid: dx=8mm, dy=8mm, dz=5mm

Reference Value = 94.79 V/m; Power Drift = -0.06 dB

Peak SAR (extrapolated) = 12.34 W/kg

SAR(1 g) = 9.72 W/kg; SAR(10 g) = 5.16 W/kg

Maximum value of SAR (measured) = 12.44 W/kg

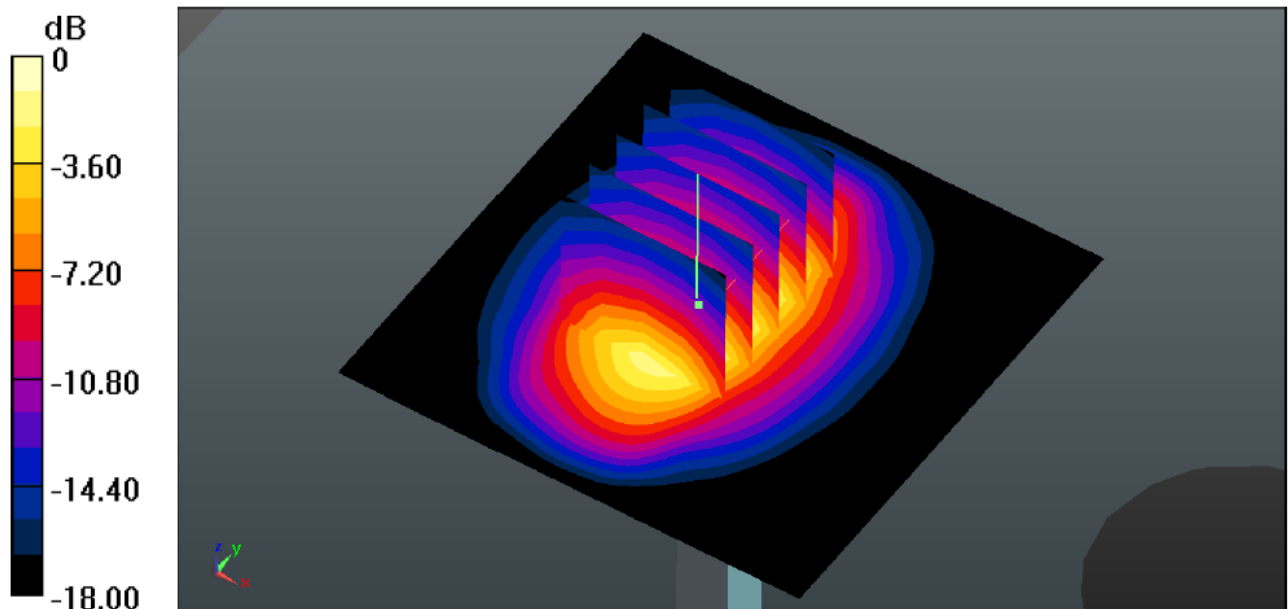

System Performance Check 1900MHz Head 250mW

System Performance Check at 1900 MHz Body

DUT: Dipole 1900 MHz; Type: D1900V2; Serial: 5d150

Date:2018-01-30

Communication System: CW; Frequency: 1900 MHz;Duty Cycle: 1:1

Medium parameters used (interpolated): $f = 1900$ MHz; $\sigma = 1.53$ S/m; $\epsilon_r = 53.12$; $\rho = 1000$ kg/m³

Phantom section: Flat Section

DASY5 Configuration:

Probe: EX3DV4 - SN3842; ConvF(7.32, 7.32, 7.32); Calibrated: 2017/8/15;

Sensor-Surface: 1.4mm (Mechanical Surface Detection)

Electronics: DAE4 Sn1315; Calibrated: 2017/8/15

Phantom: SAM 2; Type: SAM;

Measurement SW: DASY52, Version 52.8 (1); SEMCAD X Version 14.6.5 (6469)

Area Scan (7x10x1):Measurement grid: dx=15.00 mm, dy=15.00 mm

Maximum value of SAR (interpolated) = 15.187 W/kg

Zoom Scan (5x5x7)/Cube 0: Measurement grid: dx=8mm, dy=8mm, dz=5mm

Reference Value = 87.679 V/m; Power Drift = -0.14 dB

Peak SAR (extrapolated) = 19.027 W/kg

SAR(1 g) = 10.3 W/kg; SAR(10 g) = 5.34 W/kg

Maximum value of SAR (measured) = 15.09 W/kg

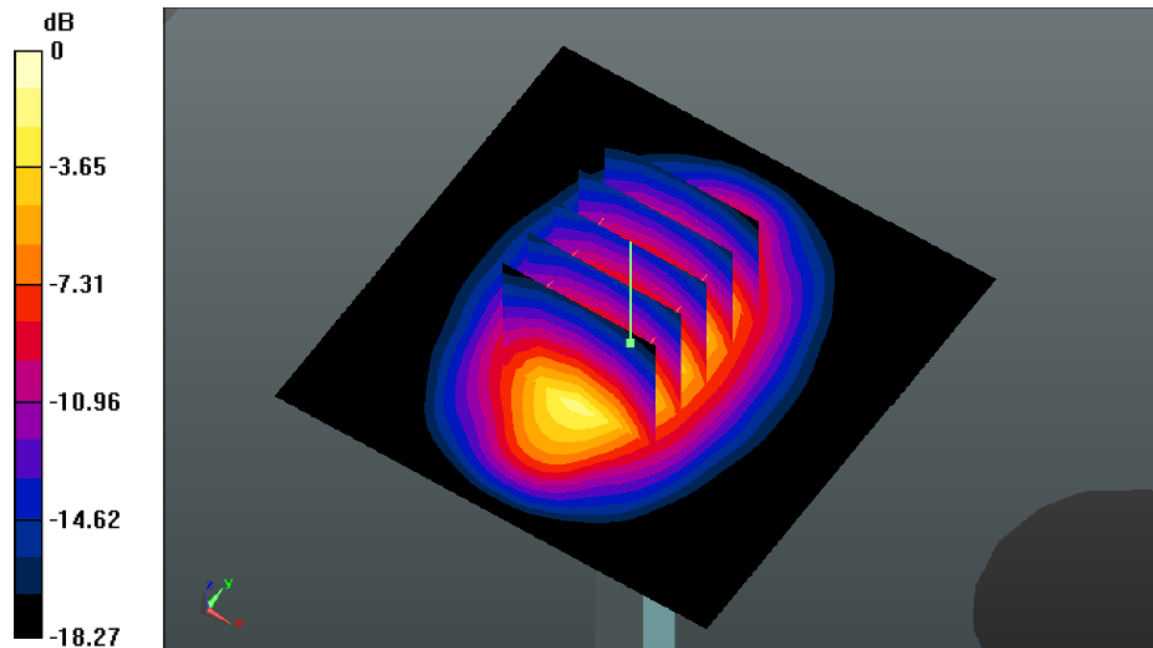

System Performance Check 1900MHz Body250mW

System Performance Check at 2450 MHz Head

DUT: Dipole 2450 MHz; Type: D2450V2; Serial: 884

Date:2018-01-31

Communication System: CW; Frequency: 2450 MHz;Duty Cycle: 1:1

Medium parameters used (interpolated): $f = 2450$ MHz; $\sigma = 1.79$ S/m; $\epsilon_r = 39.11$; $\rho = 1000$ kg/m³

Phantom section: Flat Section

DASY5 Configuration:

Probe: EX3DV4 - SN3842; ConvF(6.92, 6.92, 6.92); Calibrated: 2017/8/15;

Sensor-Surface: 1.4mm (Mechanical Surface Detection)

Electronics: DAE4 Sn1315; Calibrated: 2017/8/15

Phantom: SAM 1; Type: SAM;

Measurement SW: DASY52, Version 52.8 (1); SEMCAD X Version 14.6.5 (6469)

Area Scan (7x10x1):Measurement grid: dx=12.00 mm, dy=12.00 mm

Maximum value of SAR (interpolated) = 19.313 W/kg

Zoom Scan (7x7x7)/Cube 0: Measurement grid: dx=5mm, dy=5mm, dz=5mm

Reference Value = 84.314 V/m; Power Drift = 0.02 dB

Peak SAR (extrapolated) = 25.703 W/kg

SAR(1 g) = 12.4 W/kg; SAR(10 g) = 5.8 W/kg

Maximum value of SAR (measured) = 18.871 W/kg

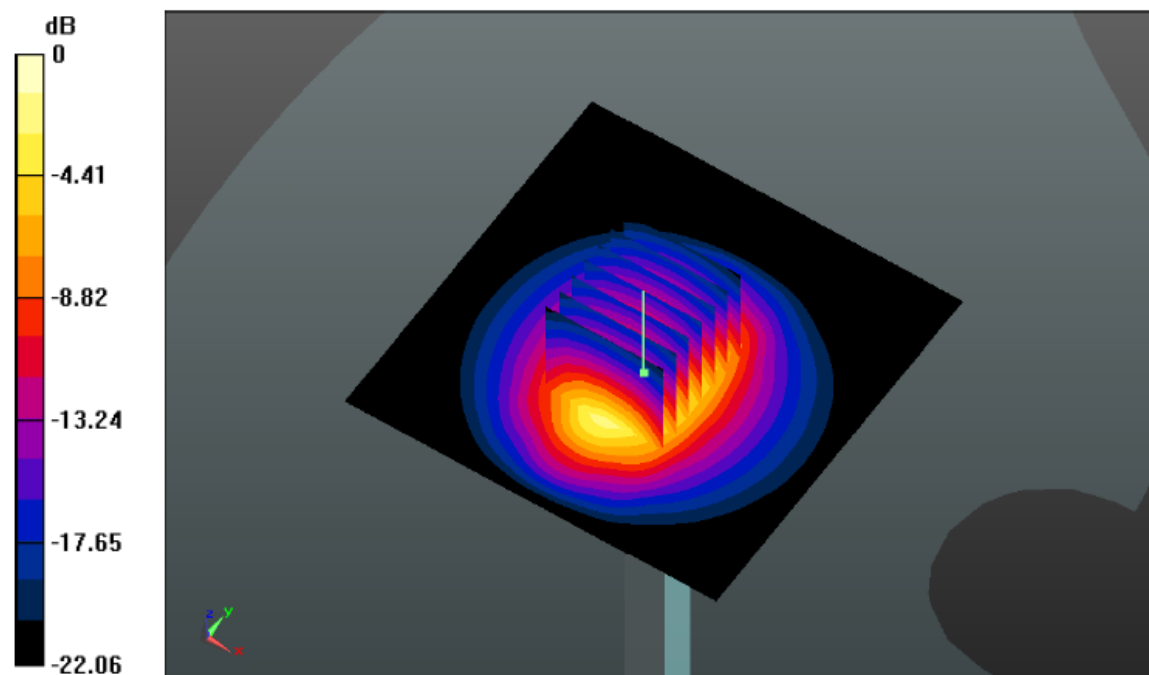

System Performance Check 2450MHz Head250mW

System Performance Check at 2450 MHz Body

DUT: Dipole 2450 MHz; Type: D2450V2; Serial: 884

Date:2018-01-31

Communication System: CW; Frequency: 2450 MHz;Duty Cycle: 1:1

Medium parameters used (interpolated): $f = 2450$ MHz; $\sigma = 1.94$ S/m; $\epsilon_r = 52.52$; $\rho = 1000$ kg/m³

Phantom section: Flat Section

DASY5 Configuration:

Probe: EX3DV4 - SN3842; ConvF(7.01, 7.01, 7.01); Calibrated: 2017/8/15;

Sensor-Surface: 1.4mm (Mechanical Surface Detection)

Electronics: DAE4 Sn1315; Calibrated: 2017/8/15

Phantom: SAM 2; Type: SAM;

Measurement SW: DASY52, Version 52.8 (1); SEMCAD X Version 14.6.5 (6469)

Area Scan (7x10x1):Measurement grid: dx=12.00 mm, dy=12.00 mm

Maximum value of SAR (interpolated) = 19.266 W/kg

Zoom Scan (7x7x7)/Cube 0: Measurement grid: dx=5mm, dy=5mm, dz=5mm

Reference Value = 84.170 V/m; Power Drift = 0.03 dB

Peak SAR (extrapolated) = 26.174 W/kg

SAR(1 g) = 12.5 W/kg; SAR(10 g) = 5.76 W/kg

Maximum value of SAR (measured) = 19.27W/kg

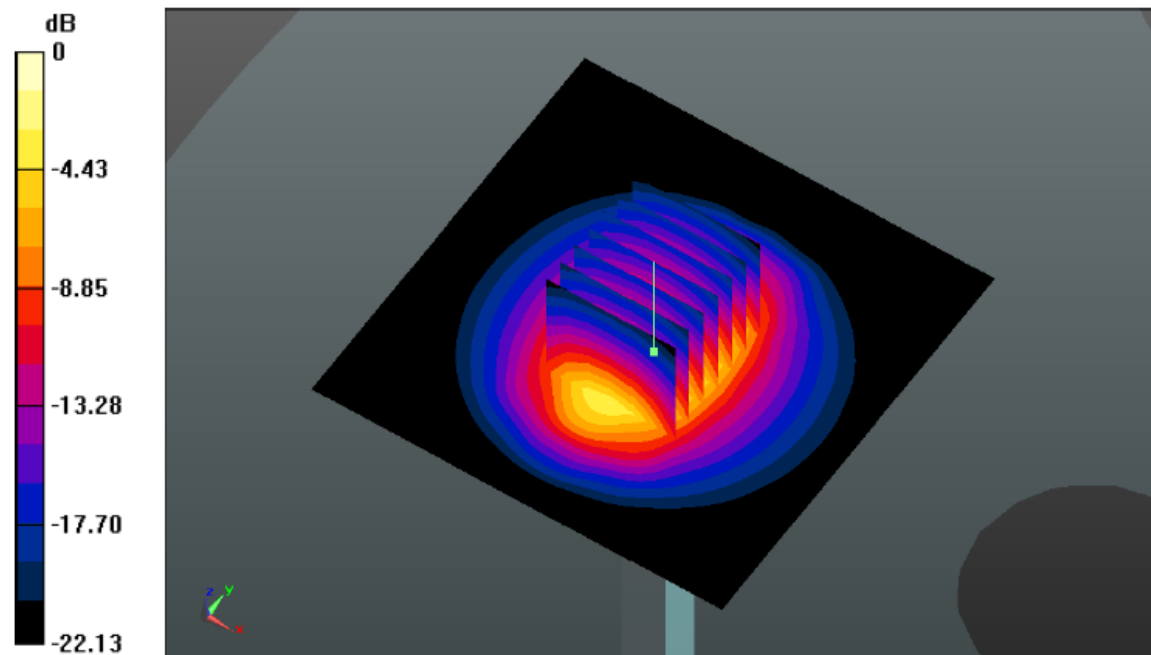

System Performance Check 2450MHz Body250mW

10. SAR Exposure Limits

SAR assessments have been made in line with the requirements of ANSI/IEEE C95.1-1999

Type Exposure	Limit (W/kg)	
	General Population / Uncontrolled Exposure Environment	Occupational / Controlled Exposure Environment
Spatial Average SAR (whole body)	0.08	0.4
Spatial Peak SAR (1g cube tissue for head and trunk)	1.60	8.0
Spatial Peak SAR (10g for limb)	4.0	20.0

Population/Uncontrolled Environments: are defined as locations where there is the exposure of individual who have no knowledge or control of their exposure.

Occupational/Controlled Environments: are defined as locations where there is exposure that may be incurred by people who are aware of the potential for exposure (i.e. as a result of employment or occupation).

11. Conducted Power Measurement Results

GSM Conducted Power

1. Per KDB 447498 D01, the maximum output power channel is used for SAR testing and further SAR test reduction
2. Per KDB 941225 D01, considering the possibility of e.g. 3rd party VoIP operation for Head and Body-worn SAR test reduction for GSM and GPRS modes is determined by the source-base time-averaged output power including tune-up tolerance. The mode with highest specified time-averaged output power should be tested for SAR compliance in the applicable exposure conditions. For modes with the same specified maximum output power and tolerance, the higher number time-slot configuration should be tested. Therefore, the EUT was set in GPRS (4Tx slots) for GSM850 and GPRS (4Tx slots) for PCS1900.
3. Per KDB941225 D01, for hotspot SAR test reduction for GPRS modes is determined by the source-based time-averaged output power including tune-up tolerance, For modes with the same specified maximum output power and tolerance, the higher number time-slot configuration should be tested. Therefore, the EUT was set in GPRS (4Tx slots) for GSM850 and GPRS (4Tx slots) for PCS1900.

Mode: GSM850		Conducted Power (dBm)			Division Factors	Averager Power (dBm)		
		CH128	CH190	CH251		CH128	CH190	CH251
		824.2MHz	836.6MHz	848.8MHz		824.2MHz	836.6MHz	848.8MHz
GSM		33.60	34.28	33.89	-9.03	24.57	25.25	24.86
GPRS (GMSK)	1TXslot	33.33	33.98	33.64	-9.03	24.30	24.95	24.61
	2TXslots	32.39	32.07	32.70	-6.02	26.37	26.05	26.68
	3TXslots	31.32	31.01	31.67	-4.26	27.06	26.75	27.41
	4TXslots	30.28	30.94	30.60	-3.01	27.27	27.93	27.59
EGPRS (8PSK)	1TXslot	25.58	25.56	25.48	-9.03	16.55	16.53	16.45
	2TXslots	24.51	24.79	24.51	-6.02	18.49	18.77	18.49
	3TXslots	22.72	22.90	22.76	-4.26	18.46	18.64	18.50
	4TXslots	20.84	20.90	20.79	-3.01	17.83	17.89	17.78
Mode: PCS1900		Conducted Power (dBm)			Division Factors	Averager Power (dBm)		
		CH512	CH661	CH810		CH512	CH661	CH810
		1850.2MHz	1880.0MHz	1909.8MHz		1850.2MHz	1880.0MHz	1909.8MHz
GSM		31.38	31.80	31.07	-9.03	22.35	22.77	22.04
GPRS (GMSK)	1TXslot	31.35	31.75	31.03	-9.03	22.32	22.72	22.00
	2TXslots	30.71	31.22	30.23	-6.02	24.69	25.20	24.21
	3TXslots	29.38	29.60	29.00	-4.26	25.12	25.34	24.74
	4TXslots	28.26	28.46	27.91	-3.01	25.25	25.45	24.90
EGPRS (8PSK)	1TXslot	23.63	23.92	23.41	-9.03	14.60	14.89	14.38
	2TXslots	22.57	22.92	22.38	-6.02	16.55	16.90	16.36
	3TXslots	20.51	20.83	20.54	-4.26	16.25	16.57	16.28
	4TXslots	18.95	19.10	18.80	-3.01	15.94	16.09	15.79

Note:

1) Division Factors

To average the power, the division factor is as follows:

1TX-slot = 1 transmit time slot out of 8 time slots=> conducted power divided by (8/1) => -9.03dB

2TX-slots = 2 transmit time slots out of 8 time slots=> conducted power divided by (8/2) => -6.02dB

3TX-slots = 3 transmit time slots out of 8 time slots=> conducted power divided by (8/3) => -4.26dB

4TX-slots = 4 transmit time slots out of 8 time slots=> conducted power divided by (8/4) => -3.01dB

WCDMA Conducted Power

1. The following tests were conducted according to the test requirements outlines in 3GPP TS34.121 specification.
2. The procedures in KDB 941225 D01 are applied for 3GPP Rel. 6 HSPA to configure the device in the required sub-test mode to determine SAR test exclusion

A summary of these settings are illustrated below:

HSDPA Setup Configuration:

- a) The EUT was connected to base station RS CMU200 referred to the setup configuration
- b) The RF path losses were compensated into the measurements
- c) A call was established between EUT and base station with following setting:
 - i. Set Gain Factors (β_c and β_d) and parameters were set according to each specific sub-test in the following table, C10.1.4, Quoted from the TS 34.121
 - ii. Set RMC 12.2Kbps + HSDPA mode
 - iii. Set Cell Power=-86dBm
 - iv. Set HS-DSCH Configuration Type to FRC (H-set 1, QPSK)
 - v. Select HSDPA uplink parameters
 - vi. Set Delta ACK, Delta NACK and Delta CQI=8
 - vii. Set Ack-Nack repetition Factor to 3
 - viii. Set CQI Feedback Cycle (K) to 4ms
 - ix. Set CQI repetition factor to 2
 - x. Power ctrl mode= all up bits
- d) The transmitter maximum output power was recorded.

Table C.10.1.4: β values for transmitter characteristics tests with HS-DPCCH

Sub-test	β_c	β_d	β_d (SF)	β_c/β_d	β_{HS} (Note 1, Note 2)	CM (dB) (Note 3)	MPR (dB) (Note 3)
1	2/15	15/15	64	2/15	4/15	0.0	0.0
2	12/15 (Note 4)	15/15 (Note 4)	64	12/15 (Note 4)	24/15	1.0	0.0
3	15/15	8/15	64	15/8	30/15	1.5	0.5
4	15/15	4/15	64	15/4	30/15	1.5	0.5

Note 1: Δ_{ACK} , Δ_{NACK} and $\Delta_{CQI} = 30/15$ with $\beta_{HS} = 30/15 * \beta_c$.

Note 2: For the HS-DPCCH power mask requirement test in clause 5.2C, 5.7A, and the Error Vector Magnitude (EVM) with HS-DPCCH test in clause 5.13.1A, and HSDPA EVM with phase discontinuity in clause 5.13.1AA, Δ_{ACK} and $\Delta_{NACK} = 30/15$ with $\beta_{HS} = 30/15 * \beta_c$, and $\Delta_{CQI} = 24/15$ with $\beta_{HS} = 24/15 * \beta_c$.

Note 3: CM = 1 for $\beta_c/\beta_d = 12/15$, $\beta_{HS}/\beta_c = 24/15$. For all other combinations of DPCCH, DPCCCH and HS-DPCCH the MPR is based on the relative CM difference. This is applicable for only UEs that support HSDPA in release 6 and later releases.

Note 4: For subtest 2 the β_c/β_d ratio of 12/15 for the TFC during the measurement period (TF1, TF0) is achieved by setting the signalled gain factors for the reference TFC (TF1, TF1) to $\beta_c = 11/15$ and $\beta_d = 15/15$.

Setup Configuration

HSUPA Setup Configuration:

- a) The EUT was connected to base station RS CMU200 referred to the setup configuration
- b) The RF path losses were compensated into the measurements
- c) A call was established between EUT and base station with following setting:
 - i. Call configs = 5.2b, 5.9b, 5.10b, and 5.13.2B with QPSK
 - ii. Set Gain Factors (β_c and β_d) and parameters (AG index) were set according to each specific sub-test in the following table, C11.1.3, Quoted from the TS 34.121
 - iii. Set Cell Power=-86dBm
 - iv. Set channel type= 12.2Kbps + HSPA mode
 - v. Set UE Target power
 - vi. Set Ctrl mode=Alternating bits
 - vii. Set and observe the E-TFCI
 - viii. Confirm that E-TFCI is equal the target E-TFCI of 75 for Sub-test 1, and other subtest's E-TFCI
- d) The transmitter maximum output power was recorded.

Table C.11.1.3: β values for transmitter characteristics tests with HS-DPCCH and E-DCH

Sub-test	β_c	β_d	β_d (SF)	β_c/β_d	β_{HS} (Note 1)	β_{ec}	β_{ed} (Note 5) (Note 6)	β_{ed} (SF)	β_{ed} (Codes)	CM (dB) (Note 2)	MPR (dB) (Note 2)	AG Index (Note 6)	E-TFCI
1	11/15 (Note 3)	15/15 (Note 3)	64	11/15 (Note 3)	22/15	209/25	1309/225	4	1	1.0	0.0	20	75
2	6/15	15/15	64	6/15	12/15	12/15	94/75	4	1	3.0	2.0	12	67
3	15/15	9/15	64	15/9	30/15	30/15	β_{ed1} : 47/15 β_{ed2} : 47/15	4 4	2	2.0	1.0	15	92
4	2/15	15/15	64	2/15	4/15	2/15	56/75	4	1	3.0	2.0	17	71
5	15/15 (Note 4)	15/15 (Note 4)	64	15/15 (Note 4)	30/15	24/15	134/15	4	1	1.0	0.0	21	81

Note 1: $\Delta_{ACK}, \Delta_{NACK}$ and $\Delta_{CQI} = 30/15$ with $\beta_{HS} = 30/15 * \beta_c$.

Note 2: CM = 1 for $\beta_c/\beta_d = 12/15, \beta_{HS}/\beta_c = 24/15$. For all other combinations of DPDCH, DPCCH, HS-DPCCH, E-DPDCH and E-DPCCH the MPR is based on the relative CM difference.

Note 3: For subtest 1 the β_c/β_d ratio of 11/15 for the TFC during the measurement period (TF1, TF0) is achieved by setting the signalled gain factors for the reference TFC (TF1, TF1) to $\beta_c = 10/15$ and $\beta_d = 15/15$.

Note 4: For subtest 5 the β_c/β_d ratio of 15/15 for the TFC during the measurement period (TF1, TF0) is achieved by setting the signalled gain factors for the reference TFC (TF1, TF1) to $\beta_c = 14/15$ and $\beta_d = 15/15$.

Note 5: In case of testing by UE using E-DPDCH Physical Layer category 1, Sub-test 3 is omitted according to TS25.306 Table 5.1g.

Note 6: β_{ed} can not be set directly, it is set by Absolute Grant Value.

Setup Configuration

General Note:

- Per KDB 941225 D01, SAR for Head / Hotspot / Body-worn Exposure is measured using a 12.2Kbps RMC with TPC bit configured to all 1s
- Per KDB 941225 D01 RMC 12.2Kbps setting is used to evaluate SAR. If the maximum output power and Tune-up tolerance specified for production units in HSDPA/HSUPA is $\leq 1/4$ dB higher than RMC 12.2Kbps or when the highest reported SAR of the RMC 12.2Kbps is scaled by the ratio of specified maximum output power and tune-up tolerance of HSDPA / HSUPA to RMC 12.2Kbps and the adjusted SAR is ≤ 1.2 W/kg, SAR measurement is not required for HSDPA / HSUPA.

Mode		WCDMA Band II			WCDMA Band V		
		Conducted Power (dBm)			Conducted Power (dBm)		
		CH9262	CH9400	CH9538	CH4132	CH4183	CH4233
		1852.4	1880.0	1907.6	826.4	836.6	846.6
AMR 12.2K		22.73	23.30	22.75	21.93	22.01	21.78
RMC 12.2K		22.76	23.33	22.76	21.95	22.04	21.79
HSDPA	Subtest-1	21.83	22.39	21.81	20.95	21.06	20.82
	Subtest-2	21.27	21.88	21.28	20.38	20.52	20.26
	Subtest-3	21.29	21.89	21.34	20.42	20.56	20.28
	Subtest-4	21.25	21.86	21.45	20.39	20.53	20.26
HSUPA	Subtest-1	18.81	19.43	18.85	17.95	17.98	17.77
	Subtest-2	19.79	20.31	19.89	18.82	18.91	18.73
	Subtest-3	19.70	20.36	19.75	18.93	18.97	18.80
	Subtest-4	18.81	19.33	18.90	17.86	17.97	17.72
	Subtest-5	19.81	20.31	19.91	18.84	18.94	18.68

WLAN Conducted Power

For 2.4GHz WLAN SAR testing, highest average RF output power channel for the lowest data rate for 802.11b were for SAR evaluation. 802.11g/n were not investigated since the average putput powers over all channels and data rates were not more than 0.25dB higher than the tested channel in the lowest data rate of 802.11b mode.

WIFI				
Mode	Channel	Frequency (MHz)	Conducted Average Power (dBm)	Data rate
802.11b	01	2412	14.94	1 Mbps
	06	2437	14.69	1 Mbps
	11	2462	14.60	1 Mbps
802.11g	01	2412	12.18	6 Mbps
	06	2437	12.32	6 Mbps
	11	2462	12.25	6 Mbps
802.11n(HT20)	01	2412	11.14	6.5 Mbps
	06	2437	11.22	6.5 Mbps
	11	2462	11.12	6.5 Mbps
802.11n(HT40)	03	2422	9.23	13.5 Mbps
	06	2437	10.01	13.5 Mbps
	09	2452	10.34	13.5 Mbps

Note: The output power was test all data rate and recorded worst case at recorded data rate.

Bluetooth Conducted Power

Bluetooth			
Mode	Channel	Frequency (MHz)	Conducted power (dBm)
GFSK	0	2402	2.42
	39	2441	1.12
	78	2480	0.83
$\pi/4$ QPSK	0	2402	2.28
	39	2441	1.03
	78	2480	0.80
8DPSK	0	2402	2.22
	39	2441	0.97
	78	2480	0.47
BLE	0	2402	-4.31
	19	2440	-5.19
	39	2480	-6.17

12. Maximum Tune-up Limit

GSM		
Mode	Maximum Tune-up (dBm)	
	GSM850	PCS1900
GSM (GMSK, 1Tx Slot)	34.50	32.00
GPRS (GMSK, 1Tx Slot)	34.00	32.00
GPRS (GMSK, 2Tx Slot)	33.00	31.50
GPRS (GMSK, 3Tx Slot)	32.00	30.00
GPRS (GMSK, 4Tx Slot)	31.00	28.50
EGPRS (8PSK, 1Tx Slot)	26.00	24.00
EGPRS (8PSK, 2Tx Slot)	25.00	23.00
EGPRS (8PSK, 3Tx Slot)	23.00	21.00
EGPRS (8PSK, 4Tx Slot)	21.00	19.50

WCDMA		
Mode	Maximum Tune-up (dBm)	
	WCDMA Band II	WCDMA Band V
AMR 12.2Kbps	23.50	22.30
RMC 12.2Kbps	23.50	22.30
HSDPA Subtest-1	22.50	21.30
HSDPA Subtest-2	22.00	21.00
HSDPA Subtest-3	22.00	21.00
HSDPA Subtest-4	22.00	21.00
HSUPA Subtest-1	19.50	18.00
HSUPA Subtest-2	20.50	19.00
HSUPA Subtest-3	20.50	19.00
HSUPA Subtest-4	19.50	18.00
HSUPA Subtest-5	20.50	19.00

WLAN	
Mode	Maximum Tune-up (dBm) Burst Average Power
802.11b	15.00
802.11g	12.50
802.11n(HT20)	11.50
802.11n(HT40)	10.50

Bluetooth	
Mode	Maximum Tune-up (dBm)
GFSK	2.50
$\pi/4$ QPSK	2.30
8DPSK	2.30
BLE	-4.20

Per KDB 447498 D01, the 1-g and 10-g SAR test exclusion thresholds for 100MHz to 6GHz at test separation distances ≤ 50 mm are determined by:

$$[(\text{max. Power of channel, including tune-up tolerance, mW}) / (\text{min. test separation distance, mm})] * [\sqrt{f(\text{GHz})}] \leq 3.0 \text{ for 1-g SAR}$$

Band/Mode	F(GHz)	Position	SAR test exclusion threshold (mW)	RF output power		SAR test exclusion
				dBm	mW	
Bluetooth	2.45	Head	10	2.50	1.78	Yes
		Body	19	2.50	1.78	Yes

Per KDB 447498 D01, when the minimum test separation distance is <5mm, a distance of 5mm is applied to determine SAR test exclusion.

The test exclusion threshold is ≤ 3 , SAR testing is not required.

13. Antenna Location

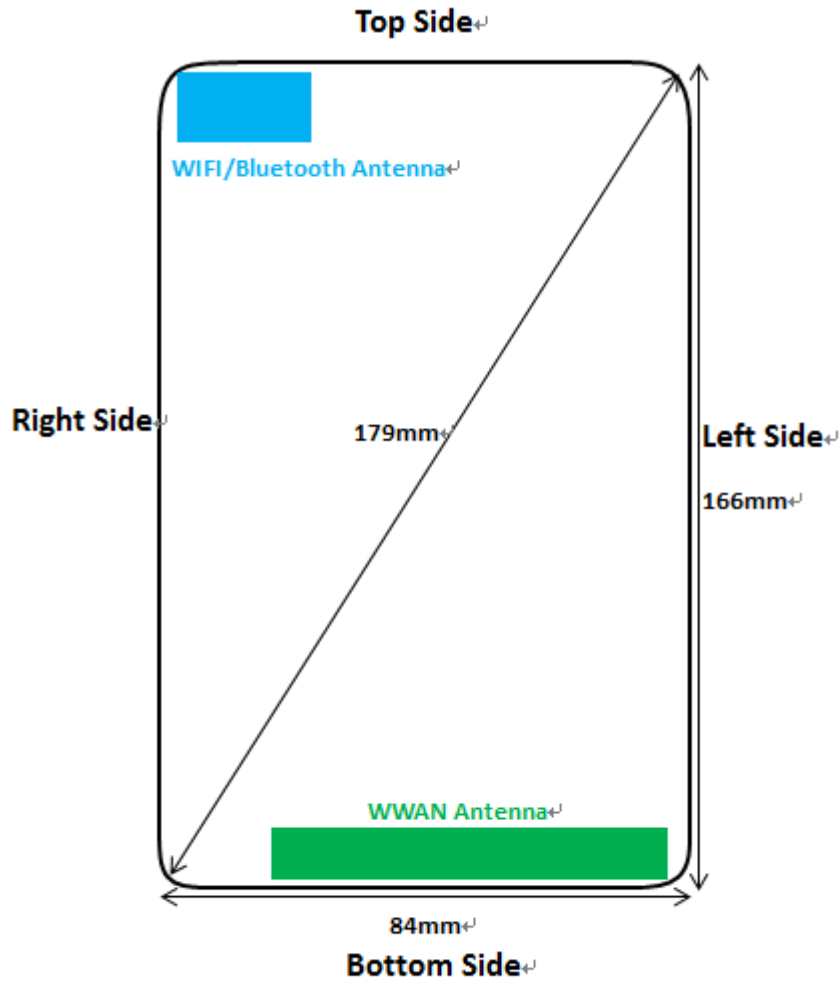

Back View

Distance of the Antenna to the EUT surface/edge(mm)						
Antenna	Back	Front	Top side	Bottom side	Right side	Left side
WWAN	2	3	154	2	17	2
WIFI/BT	2	3	2	146	2	52

Positions for SAR tests; Hotspot mode						
Antenna	Back	Front	Top side	Bottom side	Right side	Left side
WWAN	Yes	Yes	No	Yes	Yes	Yes
WIFI/BT	Yes	Yes	Yes	No	Yes	No

General note:

Referring to KDB941225 D06, when the overall device length and width are >9cm*5cm, the test distance is 10mm. SAR must be measured for all sides and surfaces with a transmitting antenna located within 25mm from that surface or edge.

14. SAR Measurement Results

Head SAR

GSM850										
Mode	Test Position	Frequency		Conducted Power (dBm)	Tune up limit (dBm)	Tune up scaling factor	Power Drift(dB)	Measured SAR(1g) (W/kg)	Report SAR(1g) (W/kg)	Test Plot
		CH	MHz							
GPRS (4Tx slot)	Left-Cheek	128	824.2	30.28	31.00	1.18	-	-	-	-
		190	836.6	30.94	31.00	1.01	0.09	0.245	0.248	H1
		251	848.8	30.60	31.00	1.10	-	-	-	-
	Left-Tilt	128	824.2	30.28	31.00	1.18	-	-	-	-
		190	836.6	30.94	31.00	1.01	-0.10	0.187	0.190	-
		251	848.8	30.60	31.00	1.10	-	-	-	-
	Right-Cheek	128	824.2	30.28	31.00	1.18	-	-	-	-
		190	836.6	30.94	31.00	1.01	-0.04	0.227	0.230	-
		251	848.8	30.60	31.00	1.10	-	-	-	-
	Right-Tilt	128	824.2	30.28	31.00	1.18	-	-	-	-
		190	836.6	30.94	31.00	1.01	0.05	0.172	0.174	-
		251	848.8	30.60	31.00	1.10	-	-	-	-

PCS1900										
Mode	Test Position	Frequency		Conducted Power (dBm)	Tune up limit (dBm)	Tune up scaling factor	Power Drift(dB)	Measured SAR(1g) (W/kg)	Report SAR(1g) (W/kg)	Test Plot
		CH	MHz							
GPRS (4Tx slot)	Left-Cheek	512	1850.2	28.26	28.50	1.06	-	-	-	-
		661	1880.0	28.46	28.50	1.01	0.12	0.115	0.116	H2
		810	1909.8	27.91	28.50	1.15	-	-	-	-
	Left-Tilt	512	1850.2	28.26	28.50	1.06	-	-	-	-
		661	1880.0	28.46	28.50	1.01	0.09	0.093	0.093	-
		810	1909.8	27.91	28.50	1.15	-	-	-	-
	Right-Cheek	512	1850.2	28.26	28.50	1.06	-	-	-	-
		661	1880.0	28.46	28.50	1.01	-0.06	0.111	0.112	-
		810	1909.8	27.91	28.50	1.15	-	-	-	-
	Right-Tilt	512	1850.2	28.26	28.50	1.06	-	-	-	-
		661	1880.0	28.46	28.50	1.01	-0.08	0.087	0.088	-
		810	1909.8	27.91	28.50	1.15	-	-	-	-

Note:

Per KDB865664 D01v01r04, Repeated measurement is not required when the original highest measured SAR is < 0.80 W/kg

WCDMA Band II										
Mode	Test Position	Frequency		Conducted Power (dBm)	Tune up limit (dBm)	Tune up scaling factor	Power Drift(dB)	Measured SAR(1g) (W/kg)	Report SAR(1g) (W/kg)	Test Plot
		CH	MHz							
RMC 12.2K bps	Left-Cheek	9262	1852.4	22.76	23.50	1.19	-	-	-	-
		9400	1880.0	23.33	23.50	1.04	-0.14	0.195	0.203	H3
		9538	1907.6	22.76	23.50	1.19	-	-	-	-
	Left-Tilt	9262	1852.4	22.76	23.50	1.19	-	-	-	-
		9400	1880.0	23.33	23.50	1.04	-0.12	0.160	0.167	-
		9538	1907.6	22.76	23.50	1.19	-	-	-	-
	Right-Cheek	9262	1852.4	22.76	23.50	1.19	-	-	-	-
		9400	1880.0	23.33	23.50	1.04	-0.15	0.186	0.193	-
		9538	1907.6	22.76	23.50	1.19	-	-	-	-
	Right-Tilt	9262	1852.4	22.76	23.50	1.19	-	-	-	-
		9400	1880.0	23.33	23.50	1.04	0.06	0.149	0.155	-
		9538	1907.6	22.76	23.50	1.19	-	-	-	-

WCDMA Band V										
Mode	Test Position	Frequency		Conducted Power (dBm)	Tune up limit (dBm)	Tune up scaling factor	Power Drift(dB)	Measured SAR(1g) (W/kg)	Report SAR(1g) (W/kg)	Test Plot
		CH	MHz							
RMC 12.2K bps	Left-Cheek	4132	826.4	21.95	22.30	1.08	-	-	-	-
		4183	836.6	22.04	22.30	1.06	0.11	0.125	0.133	H4
		4233	846.6	21.79	22.30	1.12	-	-	-	-
	Left-Tilt	4132	826.4	21.95	22.30	1.08	-	-	-	-
		4183	836.6	22.04	22.30	1.06	0.06	0.101	0.107	-
		4233	846.6	21.79	22.30	1.12	-	-	-	-
	Right-Cheek	4132	826.4	21.95	22.30	1.08	-	-	-	-
		4183	836.6	22.04	22.30	1.06	-0.12	0.121	0.128	-
		4233	846.6	21.79	22.30	1.12	-	-	-	-
	Right-Tilt	4132	826.4	21.95	22.30	1.08	-	-	-	-
		4183	836.6	22.04	22.30	1.06	-0.06	0.095	0.101	-
		4233	846.6	21.79	22.30	1.12	-	-	-	-

Note:

Per KDB865664 D01v01r04, Repeated measurement is not required when the original highest measured SAR is < 0.80 W/kg

WLAN										
Mode	Test Position	Frequency		Conducted Power (dBm)	Tune up limit (dBm)	Tune up scaling factor	Power Drift(dB)	Measured SAR(1g) (W/kg)	Report SAR(1g) (W/kg)	Test Plot
		CH	MHz							
802.11 b 1Mbps	Left-Cheek	01	2412	14.94	15.00	1.01	-	-	-	-
		06	2437	14.69	15.00	1.08	0.09	0.267	0.287	H5
		11	2462	14.60	15.00	1.10	-	-	-	-
	Left-Tilt	01	2412	14.94	15.00	1.01	-	-	-	-
		06	2437	14.69	15.00	1.08	-0.12	0.226	0.243	-
		11	2462	14.60	15.00	1.10	-	-	-	-
	Right-Cheek	01	2412	14.94	15.00	1.01	-	-	-	-
		06	2437	14.69	15.00	1.08	-0.05	0.257	0.276	-
		11	2462	14.60	15.00	1.10	-	-	-	-
	Right-Tilt	01	2412	14.94	15.00	1.01	-	-	-	-
		06	2437	14.69	15.00	1.08	0.06	0.215	0.232	-
		11	2462	14.60	15.00	1.10	-	-	-	-

Note:

- According to the above table, the initial test position for head is "LeftCheek", and its reported SAR is ≤ 0.4 W/kg. Thus further SAR measurement is not required for the other (remaining) test positions. Because the reported SAR of the highest measured maximum output power channel for the exposureconfiguration is ≤ 0.8 W/kg, no further SAR testing is required for 802.11b DSSS in that exposureconfiguration.
- When SAR measurement is required for 2.4 GHz 802.11g/n OFDM configurations, the measurement and test reduction procedures for OFDM are applied. SAR is not required for the following 2.4 GHz OFDM conditions.
 - When KDB Publication 447498 D01 SAR test exclusion applies to the OFDM configuration.
 - When the highest *reported* SAR for DSSS is adjusted by the ratio of OFDM to DSSS specified maximum output power and the adjusted SAR is ≤ 1.2 W/kg, the 802.11g/n is not required.

WLAN- Scaled Reported SAR							
Mode	Test Position	Frequency		Actual duty factor	maximum duty factor	Reported SAR (1g)(W/kg)	Scaled reported SAR (1g)(W/kg)
		CH	MHz				
802.11b 1Mbps	Left-Cheek	6	2437	98.77%	100%	0.287	0.291
	Left-Tilt	6	2437	98.77%	100%	0.243	0.246
	Right-Cheek	6	2437	98.77%	100%	0.276	0.279
	Right-Tilt	6	2437	98.77%	100%	0.232	0.235

Note:

- According to the KDB248227 D01, The reported SAR must be scaled to 100% transmission duty factor to determine compliance at the maximum tune-up tolerance limit. A maximum transmission duty factor of 98.77% is achievable for WLAN in this project.

Body SAR

GSM850										
Mode	Test Position	Frequency		Conducted Power (dBm)	Tune up limit (dBm)	Tune up scaling factor	Power Drift(dB)	Measured SAR(1g) (W/kg)	Report SAR(1g) (W/kg)	Test Plot
		CH	MHz							
GPRS (3Tx slot)	Front	128	824.2	30.28	31.00	1.18	-	-	-	-
		190	836.6	30.94	31.00	1.01	-0.03	0.234	0.237	-
		251	848.8	30.60	31.00	1.10	-	-	-	-
	Back	128	824.2	30.28	31.00	1.18	-	-	-	-
		190	836.6	30.94	31.00	1.01	0.07	0.270	0.274	B1
		251	848.8	30.60	31.00	1.10	-	-	-	-

PCS1900										
Mode	Test Position	Frequency		Conducted Power (dBm)	Tune up limit (dBm)	Tune up scaling factor	Power Drift(dB)	Measured SAR(1g) (W/kg)	Report SAR(1g) (W/kg)	Test Plot
		CH	MHz							
GPRS (3Tx slot)	Front	512	1850.2	28.26	28.50	1.06	-	-	-	-
		661	1880.0	28.46	28.50	1.01	-0.11	0.158	0.159	-
		810	1909.8	27.91	28.50	1.15	-	-	-	-
	Back	512	1850.2	28.26	28.50	1.06	-	-	-	-
		661	1880.0	28.46	28.50	1.01	0.15	0.249	0.251	B2
		810	1909.8	27.91	28.50	1.15	-	-	-	-

WCDMA Band II										
Mode	Test Position	Frequency		Conducted Power (dBm)	Tune up limit (dBm)	Tune up scaling factor	Power Drift(dB)	Measured SAR(1g) (W/kg)	Report SAR(1g) (W/kg)	Test Plot
		CH	MHz							
RMC 12.2Kbps	Front	9262	1852.4	22.76	23.50	1.19	-	-	-	-
		9400	1880.0	23.33	23.50	1.04	-0.03	0.221	0.229	-
		9538	1907.6	22.76	23.50	1.19	-	-	-	-
	Back	9262	1852.4	22.76	23.50	1.19	-	-	-	-
		9400	1880.0	23.33	23.50	1.04	0.08	0.310	0.322	B3
		9538	1907.6	22.76	23.50	1.19	-	-	-	-

WCDMA Band V										
Mode	Test Position	Frequency		Conducted Power (dBm)	Tune up limit (dBm)	Tune up scaling factor	Power Drift(dB)	Measured SAR(1g) (W/kg)	Report SAR(1g) (W/kg)	Test Plot
		CH	MHz							
RMC 12.2Kbps	Front	4132	826.4	21.95	22.30	1.08	-	-	-	-
		4183	836.6	22.04	22.30	1.06	0.02	0.143	0.152	-
		4233	846.6	21.79	22.30	1.12	-	-	-	-
	Back	4132	826.4	21.95	22.30	1.08	-	-	-	-
		4183	836.6	22.04	22.30	1.06	0.05	0.232	0.246	B4
		4233	846.6	21.79	22.30	1.12	-	-	-	-

Note:

Per KDB865664 D01v01r04, Repeated measurement is not required when the original highest measured SAR is < 0.80 W/kg

WLAN										
Mode	Test Position	Frequency		Conducted Power (dBm)	Tune up limit (dBm)	Tune up scaling factor	Power Drift(dB)	Measured SAR(1g) (W/kg)	Report SAR(1g) (W/kg)	Test Plot
		CH	MHz							
802.11b 1Mbps	Front	1	2412	14.94	15.00	1.01	-	-	-	-
		6	2437	14.69	15.00	1.08	-0.18	0.091	0.098	-
		11	2462	14.60	15.00	1.10	-	-	-	-
	Back	1	2412	14.94	15.00	1.01	-	-	-	-
		6	2437	14.69	15.00	1.08	0.17	0.134	0.144	B5
		11	2462	14.60	15.00	1.10	-	-	-	-

Note:

- According to the above table, the initial test position for body is "Back", and its reported SAR is ≤ 0.4 W/kg. Thus further SAR measurement is not required for the other (remaining) test positions. Because the reported SAR of the highest measured maximum output power channel for the exposure configuration is ≤ 0.8 W/kg, no further SAR testing is required for 802.11b DSSS in that exposure configuration.

WLAN- Scaled Reported SAR							
Mode	Test Position	Frequency		Actual duty factor	maximum duty factor	Reported SAR (1g)(W/kg)	Scaled reported SAR (1g)(W/kg)
		CH	MHz				
802.11b 1Mbps	Front	6	2437	98.77%	100%	0.098	0.099
	Back	6	2437	98.77%	100%	0.144	0.146

Note:

- According to the KDB248227 D01, The reported SAR must be scaled to 100% transmission duty factor to determine compliance at the maximum tune-up tolerance limit. A maximum transmission duty factor of 98.77% is achievable for WLAN in this project.

Hotspot SAR

Positions for SAR tests; Hotspot mode						
Antenna	Back	Front	Top side	Bottom side	Right side	Left side
WWAN	Yes	Yes	No	Yes	Yes	Yes
WIFI/BT	Yes	Yes	Yes	No	Yes	No

General note:

Referring to KDB941225 D06, when the overall device length and width are >9cm*5cm, the test distance is 10mm. SAR must be measured for all sides and surfaces with a transmitting antenna located within 25mm from that surface or edge.

GSM850										
Mode	Test Position	Frequency		Conducted Power (dBm)	Tune up limit (dBm)	Tune up scaling factor	Power Drift(dB)	Measured SAR(1g) (W/kg)	Report SAR(1g) (W/kg)	Test Plot
		CH	MHz							
GPRS (3Tx slot)	Front	128	824.2	30.28	31.00	1.18	-	-	-	-
		190	836.6	30.94	31.00	1.01	-0.03	0.234	0.237	-
		251	848.8	30.60	31.00	1.10	-	-	-	-
	Back	128	824.2	30.28	31.00	1.18	-	-	-	-
		190	836.6	30.94	31.00	1.01	0.07	0.270	0.274	B1
		251	848.8	30.60	31.00	1.10	-	-	-	-
	Left	190	836.6	30.94	31.00	1.01	0.05	0.166	0.168	-
	Right	190	836.6	30.94	31.00	1.01	-0.04	0.139	0.141	-
	Top	190	836.6	30.94	31.00	1.01	-	-	-	-
Bottom	190	836.6	30.94	31.00	1.01	0.10	0.169	0.172	-	

PCS1900										
Mode	Test Position	Frequency		Conducted Power (dBm)	Tune up limit (dBm)	Tune up scaling factor	Power Drift(dB)	Measured SAR(1g) (W/kg)	Report SAR(1g) (W/kg)	Test Plot
		CH	MHz							
GPRS (3Tx slot)	Front	512	1850.2	28.26	28.50	1.06	-	-	-	-
		661	1880.0	28.46	28.50	1.01	-0.11	0.158	0.159	-
		810	1909.8	27.91	28.50	1.15	-	-	-	-
	Back	512	1850.2	28.26	28.50	1.06	-	-	-	-
		661	1880.0	28.46	28.50	1.01	0.15	0.249	0.251	B2
		810	1909.8	27.91	28.50	1.15	-	-	-	-
	Left	661	1880.0	28.46	28.50	1.01	-0.07	0.150	0.152	-
	Right	661	1880.0	28.46	28.50	1.01	-0.13	0.115	0.116	-
	Top	661	1880.0	28.46	28.50	1.01	-	-	-	-
Bottom	661	1880.0	28.46	28.50	1.01	0.16	0.181	0.183	-	

WCDMA Band II										
Mode	Test Position	Frequency		Conducted Power (dBm)	Tune up limit (dBm)	Tune up scaling factor	Power Drift(dB)	Measured SAR(1g) (W/kg)	Report SAR(1g) (W/kg)	Test Plot
		CH	MHz							
RMC 12.2Kbps	Front	9262	1852.4	22.76	23.50	1.19	-	-	-	-
		9400	1880.0	23.33	23.50	1.04	-0.03	0.221	0.229	-
		9538	1907.6	22.76	23.50	1.19	-	-	-	-
	Back	9262	1852.4	22.76	23.50	1.19	-	-	-	-
		9400	1880.0	23.33	23.50	1.04	0.08	0.310	0.322	B3
		9538	1907.6	22.76	23.50	1.19	-	-	-	-
	Left	9400	1880.0	23.33	23.50	1.04	-0.04	0.211	0.219	-
	Right	9400	1880.0	23.33	23.50	1.04	0.06	0.149	0.155	-
	Top	9400	1880.0	23.33	23.50	1.04	-	-	-	-
Bottom	9400	1880.0	23.33	23.50	1.04	-0.02	0.235	0.244	-	

WCDMA Band V										
Mode	Test Position	Frequency		Conducted Power (dBm)	Tune up limit (dBm)	Tune up scaling factor	Power Drift(dB)	Measured SAR(1g) (W/kg)	Report SAR(1g) (W/kg)	Test Plot
		CH	MHz							
RMC 12.2Kbps	Front	4132	826.4	21.95	22.30	1.08	-	-	-	-
		4183	836.6	22.04	22.30	1.06	0.02	0.143	0.152	-
		4233	846.6	21.79	22.30	1.12	-	-	-	-
	Back	4132	826.4	21.95	22.30	1.08	-	-	-	-
		4183	836.6	22.04	22.30	1.06	0.05	0.232	0.246	B4
		4233	846.6	21.79	22.30	1.12	-	-	-	-
	Left	4183	836.6	22.04	22.30	1.06	0.02	0.164	0.174	-
	Right	4183	836.6	22.04	22.30	1.06	-0.04	0.118	0.125	-
	Top	4183	836.6	22.04	22.30	1.06	-	-	-	-
Bottom	4183	836.6	22.04	22.30	1.06	0.03	0.141	0.149	-	

Note:

- Per KDB865664 D01v01r04, Repeated measurement is not required when the original highest measured SAR is < 0.80 W/kg

WLAN										
Mode	Test Position	Frequency		Conducted Power (dBm)	Tune up limit (dBm)	Tune up scaling factor	Power Drift(dB)	Measured SAR(1g) (W/kg)	Report SAR(1g) (W/kg)	Test Plot
		CH	MHz							
802.11b 1Mbps	Front	1	2412	14.94	15.00	1.01	-	-	-	-
		6	2437	14.69	15.00	1.08	-0.18	0.091	0.098	-
		11	2462	14.60	15.00	1.10	-	-	-	-
	Back	1	2412	14.94	15.00	1.01	-	-	-	-
		6	2437	14.69	15.00	1.08	0.17	0.134	0.144	B5
		11	2462	14.60	15.00	1.10	-	-	-	-
	Left	6	2437	14.69	15.00	1.08	-	-	-	-
	Right	6	2437	14.69	15.00	1.08	0.13	0.112	0.120	-
	Top	6	2437	14.69	15.00	1.08	-0.05	0.088	0.095	-
Bottom	6	2437	14.69	15.00	1.08	-	-	-	-	

Note:

- According to the above table, the initial test position for body is "Back", and its reported SAR is ≤ 0.4 W/kg. Thus further SAR measurement is not required for the other (remaining) test positions. Because the reported SAR of the highest measured maximum output power channel for the exposure configuration is ≤ 0.8 W/kg, no further SAR testing is required for 802.11b DSSS in that exposure configuration.
- When SAR measurement is required for 2.4 GHz 802.11g/n OFDM configurations, the measurement and test reduction procedures for OFDM are applied. SAR is not required for the following 2.4 GHz OFDM conditions.
 - When KDB Publication 447498 D01 SAR test exclusion applies to the OFDM configuration.
 - When the highest *reported* SAR for DSSS is adjusted by the ratio of OFDM to DSSS specified maximum output power and the adjusted SAR is ≤ 1.2 W/kg. the 802.11g/n is not required

WLAN- Scaled Reported SAR							
Mode	Test Position	Frequency		Actual duty factor	maximum duty factor	Reported SAR (1g)(W/kg)	Scaled reported SAR (1g)(W/kg)
		CH	MHz				
802.11b 1Mbps	Front	6	2437	98.77%	100%	0.098	0.099
	Back	6	2437	98.77%	100%	0.144	0.146
	Left	6	2437	98.77%	100%	0.120	0.122
	Top	6	2437	98.77%	100%	0.095	0.096

Note:

- According to the KDB248227 D01, The reported SAR must be scaled to 100% transmission duty factor to determine compliance at the maximum tune-up tolerance limit. A maximum transmission duty factor of 98.77% is achievable for WLAN in this project.

SAR Test Data Plots

Test mode: GPRS850 4Tx slot Test Position: Left Head Cheek Test Plot: H1

Date:2018-01-29

Communication System: Customer System; Frequency: 836.6 MHz;Duty Cycle: 1:2

Medium parameters used (interpolated): $f = 836.6$ MHz; $\sigma = 0.921$ mho/m; $\epsilon_r = 41.869$; $\rho = 1000$ kg/m³

Phantom section: Left Section

DASY5 Configuration:

- Probe: EX3DV4 - SN3842; ConvF(9.15, 9.15, 9.15); Calibrated: 2017/8/15;
- Sensor-Surface: 1.4mm (Mechanical Surface Detection)
- Electronics: DAE4 Sn1315; Calibrated: 2017/8/15
- Phantom: SAM 1; Type: SAM;
- Measurement SW: DASY52, Version 52.8 (2); SEMCAD X Version 14.6.6 (6824)

Area Scan (61x121x1): Interpolated grid: dx=1.500 mm, dy=1.500 mm

Maximum value of SAR (interpolated) = 0.319 W/kg

Zoom Scan (5x5x7)/Cube 0: Measurement grid: dx=8mm, dy=8mm, dz=5mm

Reference Value = 14.623 V/m; Power Drift = 0.09 dB

Peak SAR (extrapolated) = 0.436 W/kg

SAR(1 g) = 0.245 W/kg; SAR(10 g) = 0.136 W/kg

Maximum value of SAR (measured) = 0.315 W/kg

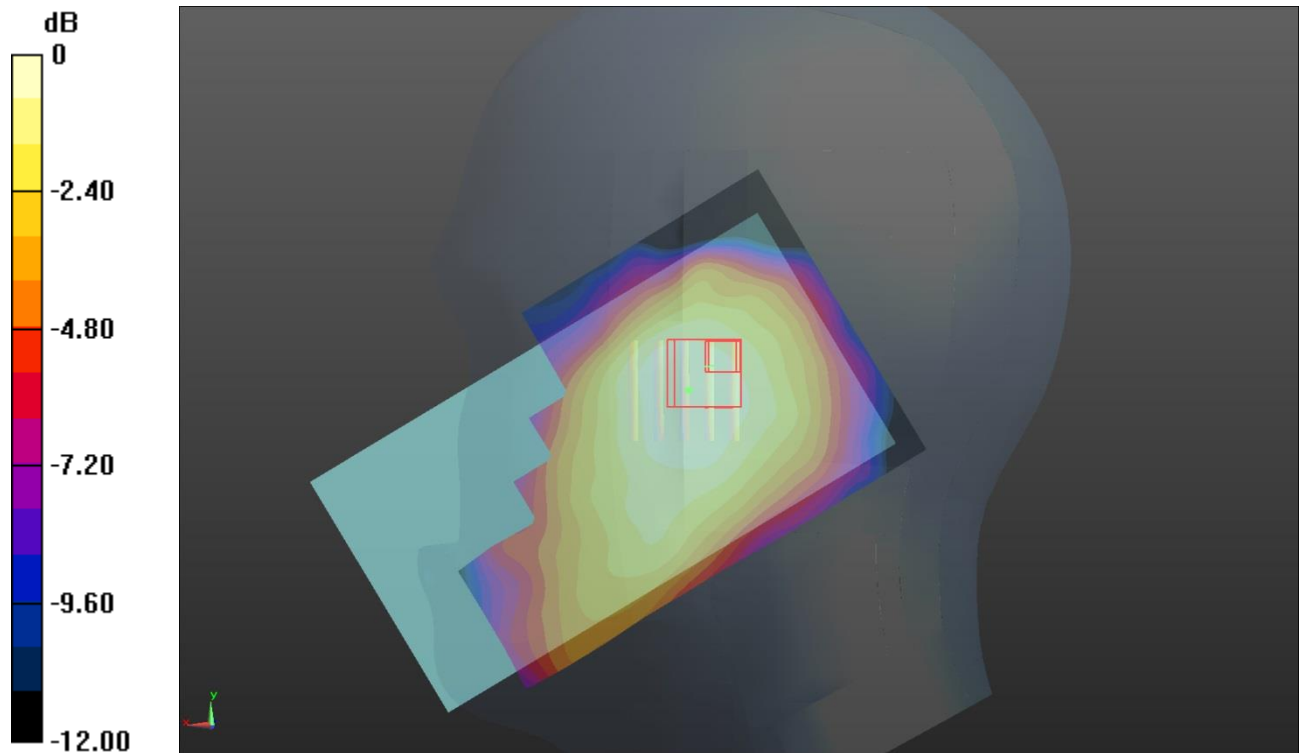

Test mode: GPRS1900 4Tx slot Test Position: Left Head Cheek Test Plot: H2

Date:2018-01-30

Communication System: Customer System; Frequency: 1880 MHz; Duty Cycle: 1:2
Medium parameters used: $f = 1880$ MHz; $\sigma = 1.45$ mho/m; $\epsilon_r = 39.74$; $\rho = 1000$ kg/m³
Phantom section: Left Section

DASY5 Configuration:

- Probe: EX3DV4 - SN3842; ConvF(7.58, 7.58, 7.58); Calibrated: 2017/8/15;
- Sensor-Surface: 1.4mm (Mechanical Surface Detection)
- Electronics: DAE4 Sn1315; Calibrated: 2017/8/15
- Phantom: SAM 1; Type: SAM;
- Measurement SW: DASY52, Version 52.8 (2); SEMCAD X Version 14.6.6 (6824)

Area Scan (71x121x1): Interpolated grid: dx=1.500 mm, dy=1.500 mm

Maximum value of SAR (interpolated) = 0.131 W/kg

Zoom Scan (5x5x7)/Cube 0: Measurement grid: dx=8mm, dy=8mm, dz=5mm

Reference Value = 5.024 V/m; Power Drift = 0.12 dB

Peak SAR (extrapolated) = 0.254 W/kg

SAR(1 g) = 0.115 W/kg; SAR(10 g) = 0.072 W/kg

Maximum value of SAR (measured) = 0.135 W/kg

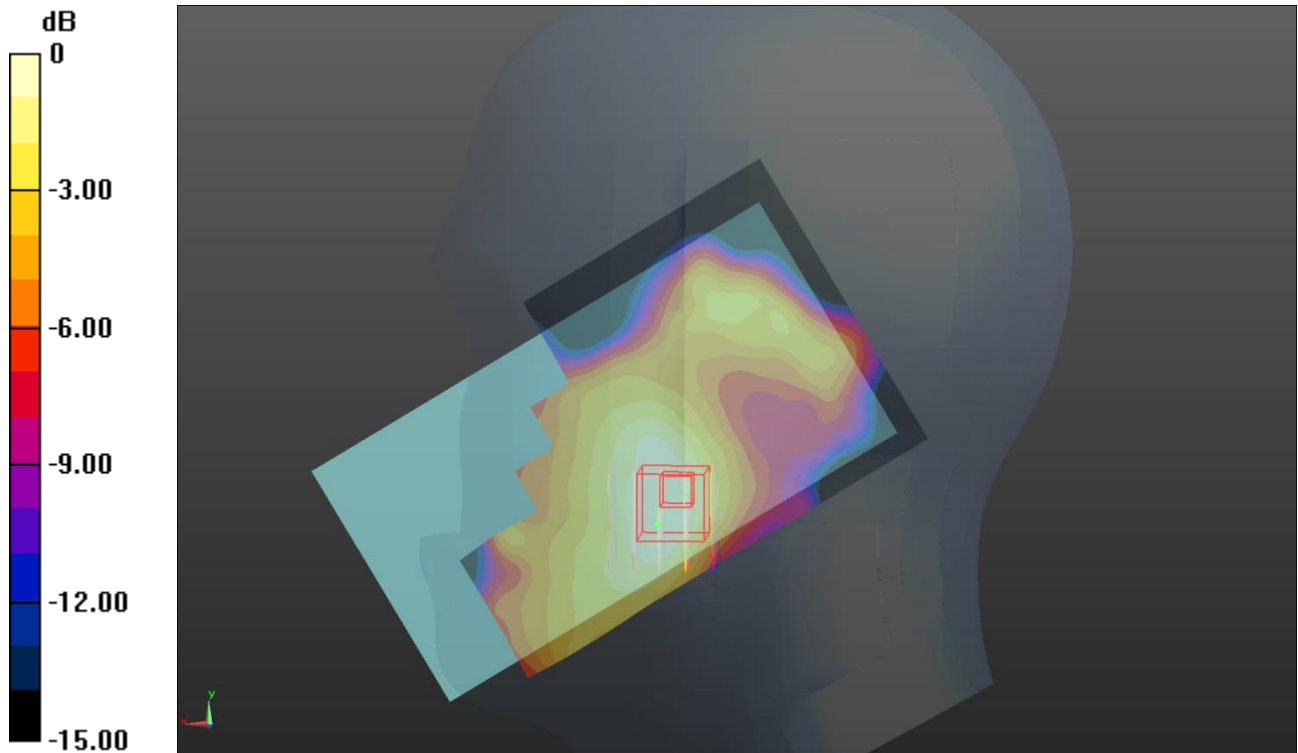

Test mode: WCDMA Band II

Test Position: Left Head Cheek

Test Plot: H3

Date:2018-01-30

Communication System: WCDMA; Frequency: 1880 MHz;Duty Cycle: 1:1

Medium parameters used: $f = 1880$ MHz; $\sigma = 1.45$ mho/m; $\epsilon_r = 39.74$; $\rho = 1000$ kg/m³

Phantom section: Left Section

DASY5 Configuration:

- Probe: EX3DV4 - SN3842; ConvF(7.58, 7.58, 7.58); Calibrated: 2017/8/15;
- Sensor-Surface: 1.4mm (Mechanical Surface Detection)
- Electronics: DAE4 Sn1315; Calibrated: 2017/8/15
- Phantom: SAM 1; Type: SAM;
- Measurement SW: DASY52, Version 52.8 (2); SEMCAD X Version 14.6.6 (6824)

Area Scan (71x121x1): Interpolated grid: dx=1.500 mm, dy=1.500 mm

Maximum value of SAR (interpolated) = 0.232 W/kg

Zoom Scan (5x5x7)/Cube 0: Measurement grid: dx=8mm, dy=8mm, dz=5mm

Reference Value = 5.267 V/m; Power Drift = -0.14 dB

Peak SAR (extrapolated) = 0.333 W/kg

SAR(1 g) = 0.195 W/kg; SAR(10 g) = 0.104 W/kg

Maximum value of SAR (measured) = 0.233 W/kg

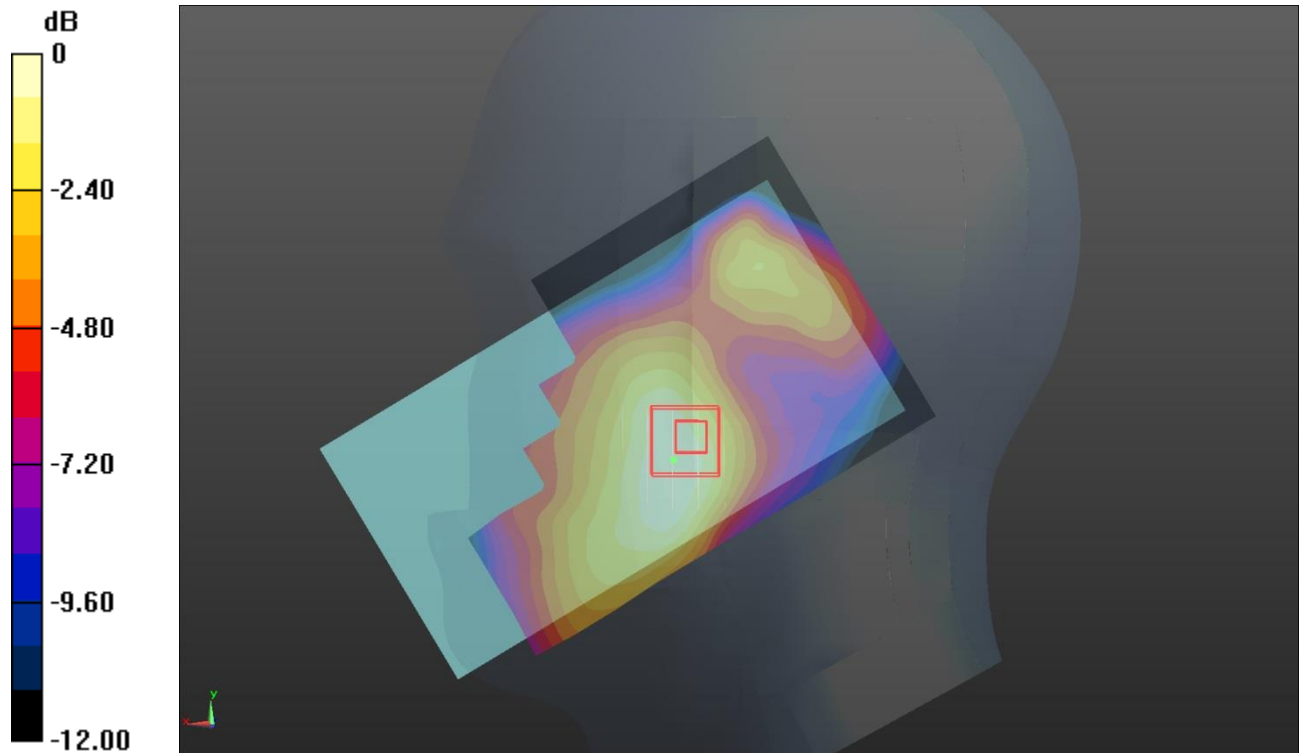

Test mode: WCDMA Band V

Test Position: Left Head Cheek

Test Plot: H4

Date:2018-01-29

Communication System: WCDMA; Frequency: 836.6 MHz;Duty Cycle: 1:1

Medium parameters used (interpolated): $f = 836.6$ MHz; $\sigma = 0.921$ mho/m; $\epsilon_r = 41.869$; $\rho = 1000$ kg/m³

Phantom section: Left Section

DASY5 Configuration:

- Probe: EX3DV4 - SN3842; ConvF(9.15, 9.15, 9.15); Calibrated: 2017/8/15;
- Sensor-Surface: 1.4mm (Mechanical Surface Detection)
- Electronics: DAE4 Sn1315; Calibrated: 2017/8/15
- Phantom: SAM 1; Type: SAM;
- Measurement SW: DASY52, Version 52.8 (2); SEMCAD X Version 14.6.6 (6824)

Area Scan (71x121x1): Interpolated grid: dx=1.500 mm, dy=1.500 mm

Maximum value of SAR (interpolated) = 0.189 W/kg

Zoom Scan (5x5x7)/Cube 0: Measurement grid: dx=8mm, dy=8mm, dz=5mm

Reference Value = 6.152 V/m; Power Drift = 0.11 dB

Peak SAR (extrapolated) = 0.227 W/kg

SAR(1 g) = 0.125 W/kg; SAR(10 g) = 0.069 W/kg

Maximum value of SAR (measured) = 0.186 W/kg

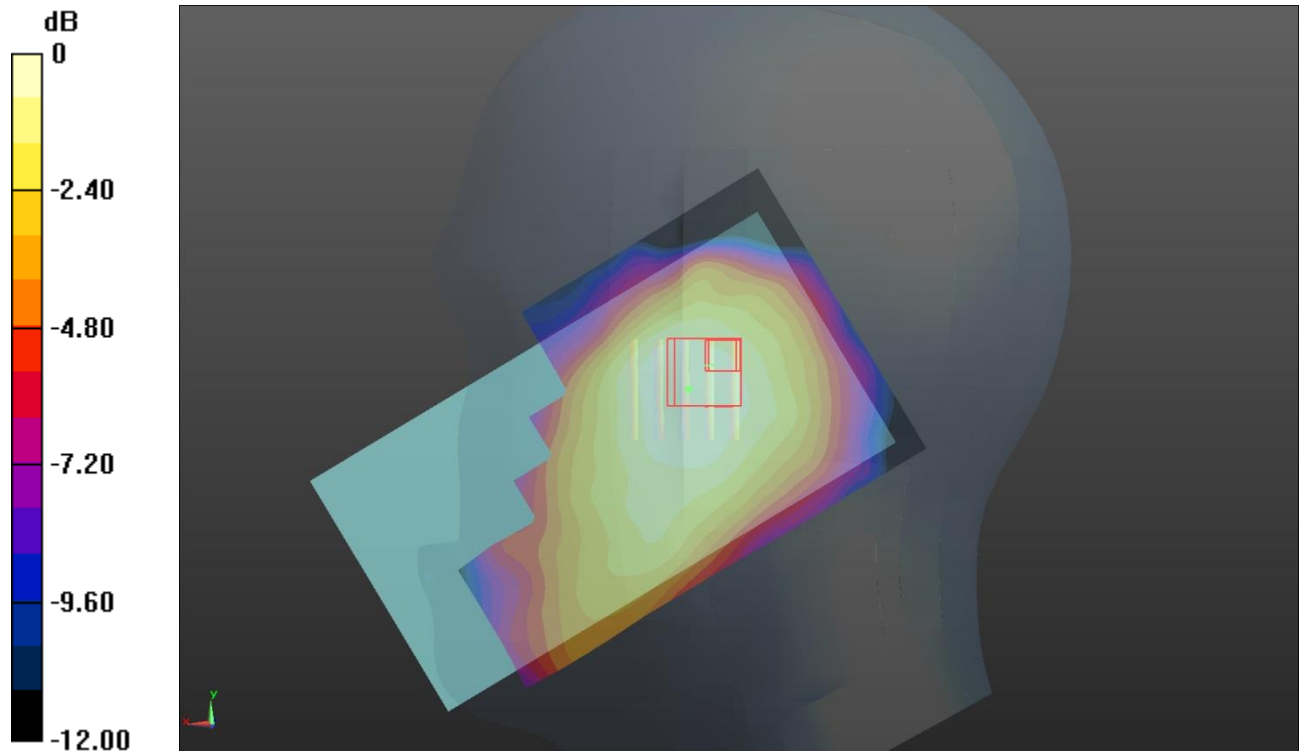

Test mode: WLAN 802.11b

Test Position: Left Head Cheek

Test Plot: H5

Date:2018-01-31

Communication System: wifi; Frequency: 2437 MHz;Duty Cycle: 1:1

Medium parameters used (interpolated): $f = 2437$ MHz; $\sigma = 1.889$ mho/m; $\epsilon_r = 37.997$; $\rho = 1000$ kg/m³

Phantom section: Left Section

DASY5 Configuration:

- Probe: EX3DV4 - SN3842; ConvF(6.92, 6.92, 6.92); Calibrated: 2017/8/15;
- Sensor-Surface: 1.4mm (Mechanical Surface Detection)
- Electronics: DAE4 Sn1315; Calibrated: 2017/8/15
- Phantom: SAM 1; Type: SAM;
- Measurement SW: DASY52, Version 52.8 (2); SEMCAD X Version 14.6.6 (6824)

Area Scan (91x141x1): Interpolated grid: dx=1.200 mm, dy=1.200 mm

Maximum value of SAR (interpolated) = 0.364 W/kg

Zoom Scan (7x7x7)/Cube 0: Measurement grid: dx=5mm, dy=5mm, dz=5mm

Reference Value = 7.389 V/m; Power Drift = 0.09 dB

Peak SAR (extrapolated) = 0.574 W/kg

SAR(1 g) = 0.267 W/kg; SAR(10 g) = 0.127 W/kg

Maximum value of SAR (measured) = 0.369 W/kg

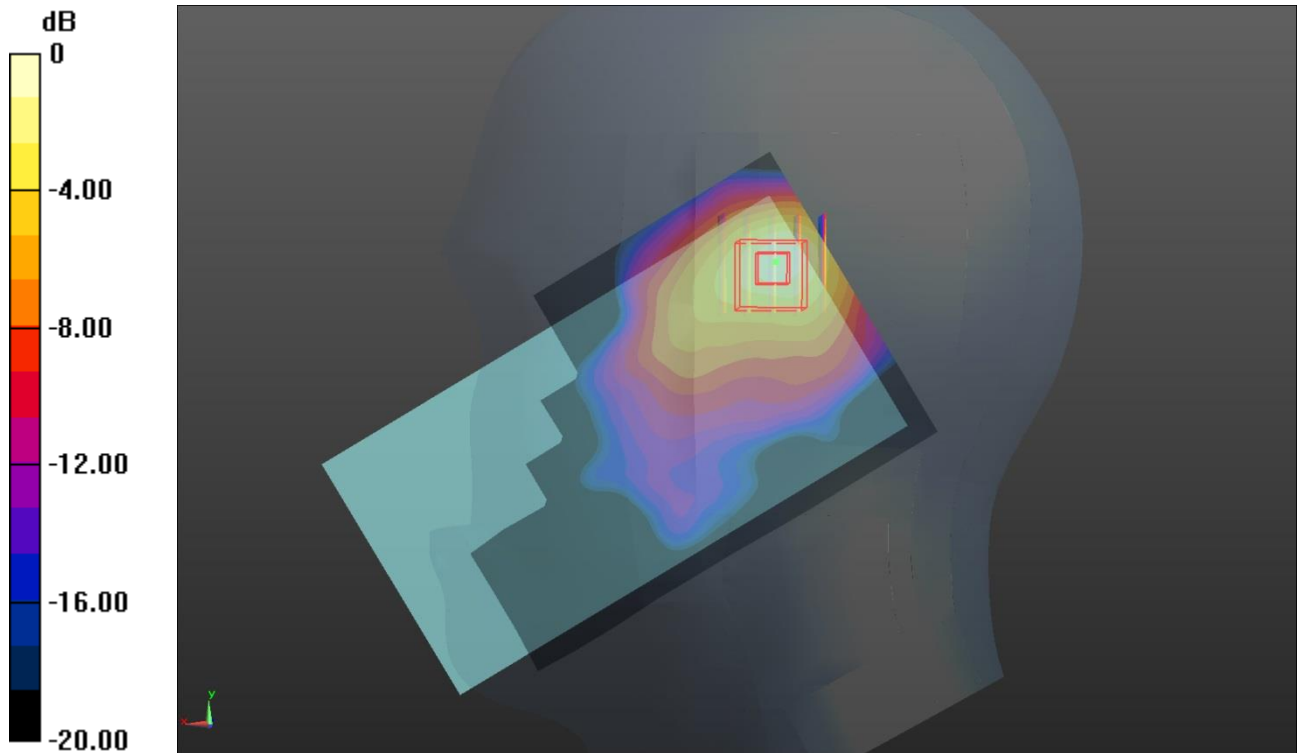

Test mode: GPRS850 4Tx slot Test Position: Body- worn Rear Side Test Plot: B1

Date:2018-01-29

Communication System: Customer System; Frequency: 836.6 MHz;Duty Cycle: 1:2

Medium parameters used (interpolated): $f = 836.6$ MHz; $\sigma = 0.96$ mho/m; $\epsilon_r = 55.858$; $\rho = 1000$ kg/m³

Phantom section: Flat Section

DASY 5 Configuration:

- Probe: EX3DV4 - SN3842; ConvF(9.31, 9.31, 9.31); Calibrated: 2017/8/15;
- Sensor-Surface: 1.4mm (Mechanical Surface Detection)
- Electronics: DAE4 Sn1315; Calibrated: 2017/8/15
- Phantom: SAM 2; Type: SAM;
- Measurement SW: DASY52, Version 52.8 (2); SEMCAD X Version 14.6.6 (6824)

Area Scan (71x121x1): Interpolated grid: dx=1.500 mm, dy=1.500 mm

Maximum value of SAR (interpolated) = 0.435 W/kg

Zoom Scan (5x5x7)/Cube 0: Measurement grid: dx=8mm, dy=8mm, dz=5mm

Reference Value = 12.152 V/m; Power Drift = 0.07 dB

Peak SAR (extrapolated) = 0.565 W/kg

SAR(1 g) = 0.270 W/kg; SAR(10 g) = 0.138 W/kg

Maximum value of SAR (measured) = 0.441 W/kg

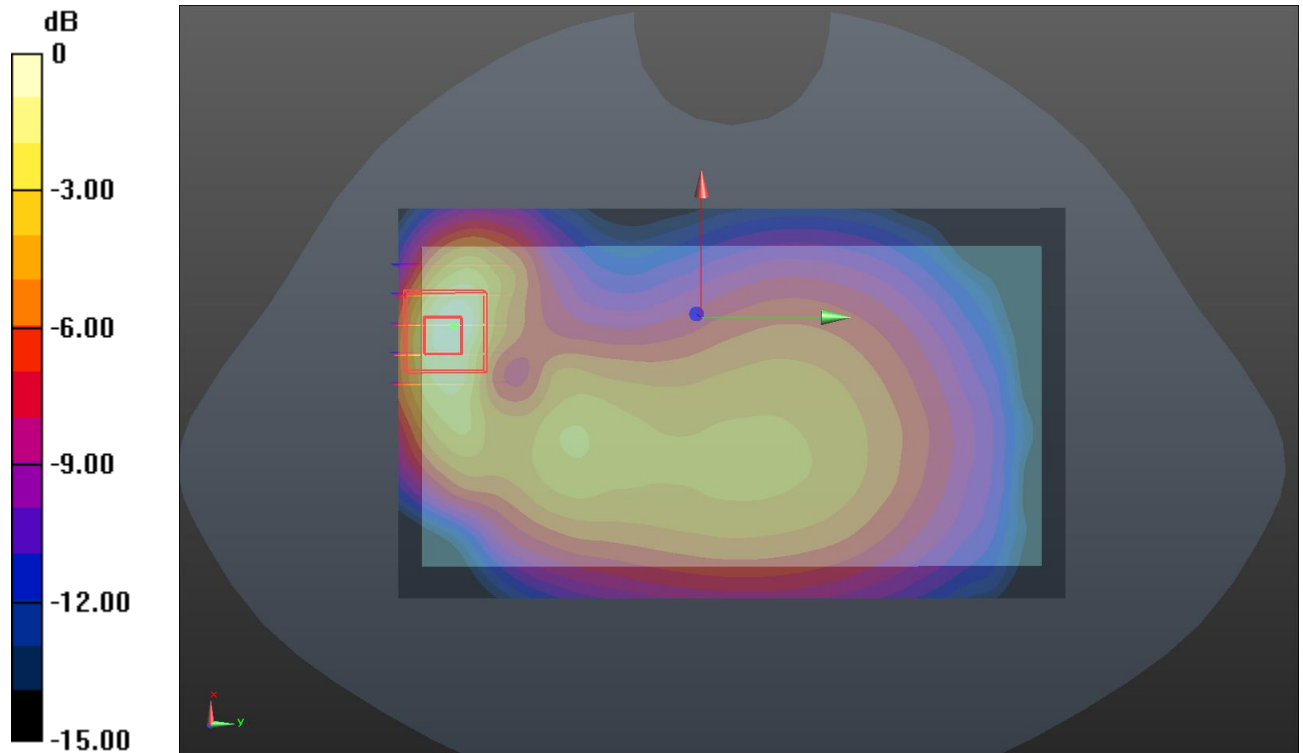

Test mode: GPRS1900 4Tx slot Test Position: Body- worn Rear Side Test Plot: B2

Date:2018-01-30

Communication System: Customer System; Frequency: 1880 MHz;Duty Cycle: 1:2

Medium parameters used: $f = 1880$ MHz; $\sigma = 1.57$ mho/m; $\epsilon_r = 51.14$; $\rho = 1000$ kg/m³

Phantom section: Flat Section

DASY5 Configuration:

- Probe: EX3DV4 - SN3842; ConvF(7.32, 7.32, 7.32); Calibrated: 2017/8/15;
- Sensor-Surface: 1.4mm (Mechanical Surface Detection)
- Electronics: DAE4 Sn1315; Calibrated: 2017/8/15
- Phantom: SAM 2; Type: SAM;
- Measurement SW: DASY52, Version 52.8 (2); SEMCAD X Version 14.6.6 (6824)

Area Scan (71x121x1): Interpolated grid: dx=1.500 mm, dy=1.500 mm

Maximum value of SAR (interpolated) = 0.389 W/kg

Zoom Scan (5x5x7)/Cube 0: Measurement grid: dx=8mm, dy=8mm, dz=5mm

Reference Value = 4.689 V/m; Power Drift = 0.15 dB

Peak SAR (extrapolated) = 0.464 W/kg

SAR(1 g) = 0.249 W/kg; SAR(10 g) = 0.133 W/kg

Maximum value of SAR (measured) = 0.383 W/kg

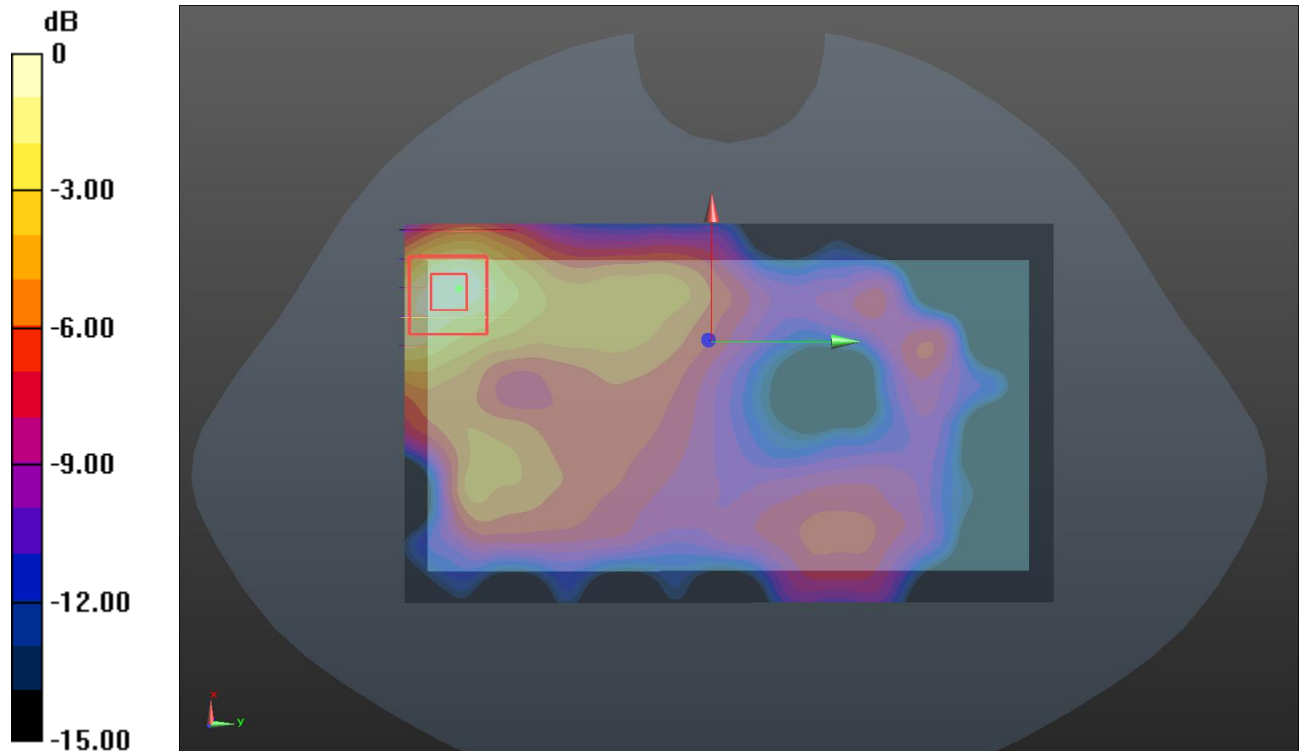

Test mode: WCDMA Band II Test Position: Body- worn Rear Side Test Plot: B3

Date:2018-01-30

Communication System: WCDMA; Frequency: 1880 MHz;Duty Cycle: 1:1

Medium parameters used: $f = 1880 \text{ MHz}$; $\sigma = 1.57 \text{ mho/m}$; $\epsilon_r = 51.14$; $\rho = 1000 \text{ kg/m}^3$

Phantom section: Flat Section

DASY5 Configuration:

- Probe: EX3DV4 - SN3842; ConvF(7.32, 7.32, 7.32); Calibrated: 2017/8/15;
- Sensor-Surface: 1.4mm (Mechanical Surface Detection)
- Electronics: DAE4 Sn1315; Calibrated: 2017/8/15
- Phantom: SAM 2; Type: SAM;
- Measurement SW: DASY52, Version 52.8 (2); SEMCAD X Version 14.6.6 (6824)

Area Scan (71x121x1): Interpolated grid: $dx=1.500 \text{ mm}$, $dy=1.500 \text{ mm}$

Maximum value of SAR (interpolated) = 0.458 W/kg

Zoom Scan (5x5x7)/Cube 0: Measurement grid: $dx=8\text{mm}$, $dy=8\text{mm}$, $dz=5\text{mm}$

Reference Value = 4.843 V/m ; Power Drift = 0.08 dB

Peak SAR (extrapolated) = 0.573 W/kg

SAR(1 g) = 0.310 W/kg ; SAR(10 g) = 0.165 W/kg

Maximum value of SAR (measured) = 0.474 W/kg

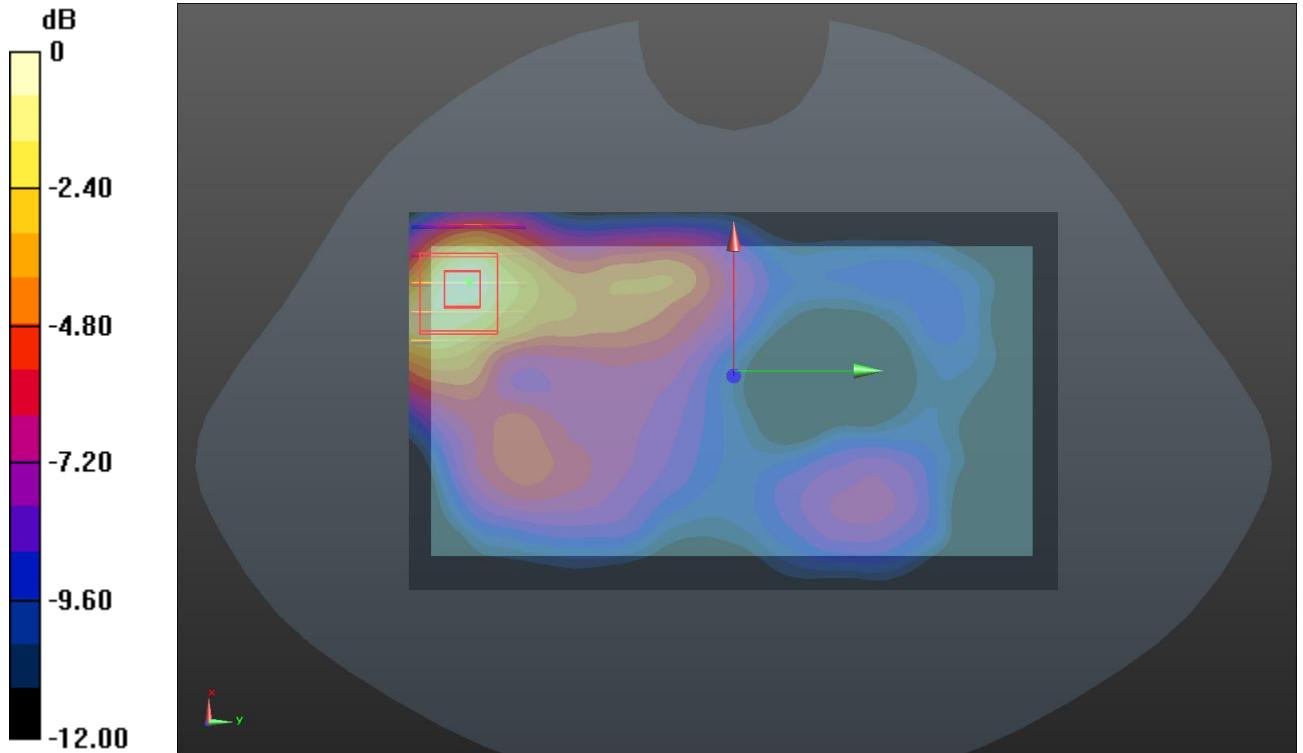

Test mode: WCDMA Band V

Test Position: Body- worn Rear Side

Test Plot: B4

Date:2018-01-29

Communication System: WCDMA; Frequency: 836.6 MHz;Duty Cycle: 1:1

Medium parameters used (interpolated): $f = 836.6$ MHz; $\sigma = 0.96$ mho/m; $\epsilon_r = 55.858$; $\rho = 1000$ kg/m³

Phantom section: Flat Section

DASY5 Configuration:

- Probe: EX3DV4 - SN3842; ConvF(9.31, 9.31, 9.31); Calibrated: 2017/8/15;
- Sensor-Surface: 1.4mm (Mechanical Surface Detection)
- Electronics: DAE4 Sn1315; Calibrated: 2017/8/15
- Phantom: SAM 2; Type: SAM;
- Measurement SW: DASY52, Version 52.8 (2); SEMCAD X Version 14.6.6 (6824)

Area Scan (71x121x1): Interpolated grid: dx=1.500 mm, dy=1.500 mm

Maximum value of SAR (interpolated) = 0.347 W/kg

Zoom Scan (5x5x7)/Cube 0: Measurement grid: dx=8mm, dy=8mm, dz=5mm

Reference Value = 10.359 V/m; Power Drift = 0.05 dB

Peak SAR (extrapolated) = 0.494 W/kg

SAR(1 g) = 0.232 W/kg; SAR(10 g) = 0.117 W/kg

Maximum value of SAR (measured) = 0.350 W/kg

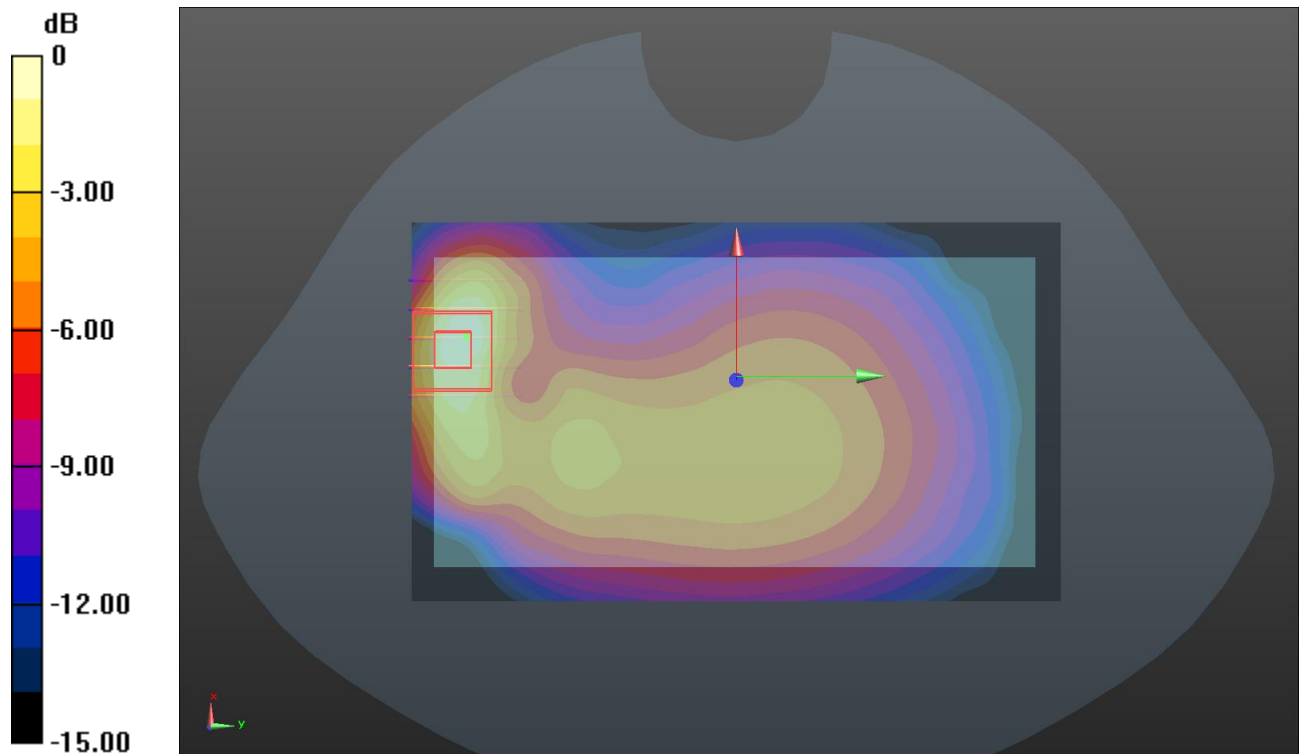

Test mode: WLAN 802.11b

Test Position: Body- worn Rear Side

Test Plot: B5

Date:2018-01-31

Communication System: wifi; Frequency: 2437 MHz;Duty Cycle: 1:1

Medium parameters used (interpolated): $f = 2437$ MHz; $\sigma = 2.02$ mho/m; $\epsilon_r = 50.719$; $\rho = 1000$ kg/m³

Phantom section: Flat Section

DASY5 Configuration:

- Probe: EX3DV4 – SN3842; ConvF(7.01, 7.01, 7.01); Calibrated: 2017/8/15;
- Sensor-Surface: 1.4mm (Mechanical Surface Detection)
- Electronics: DAE4 Sn1315; Calibrated: 2017/8/15
- Phantom: SAM 2; Type: SAM;
- Measurement SW: DASY52, Version 52.8 (2); SEMCAD X Version 14.6.6 (6824)

Area Scan (71x121x1): Interpolated grid: dx=1.500 mm, dy=1.500 mm

Maximum value of SAR (interpolated) = 0.208 W/kg

Zoom Scan (5x5x7)/Cube 0: Measurement grid: dx=8mm, dy=8mm, dz=5mm

Reference Value = 2.211 V/m; Power Drift = 0.17 dB

Peak SAR (extrapolated) = 0.276 W/kg

SAR(1 g) = 0.134 W/kg; SAR(10 g) = 0.073 W/kg

Maximum value of SAR (measured) = 0.205 W/kg

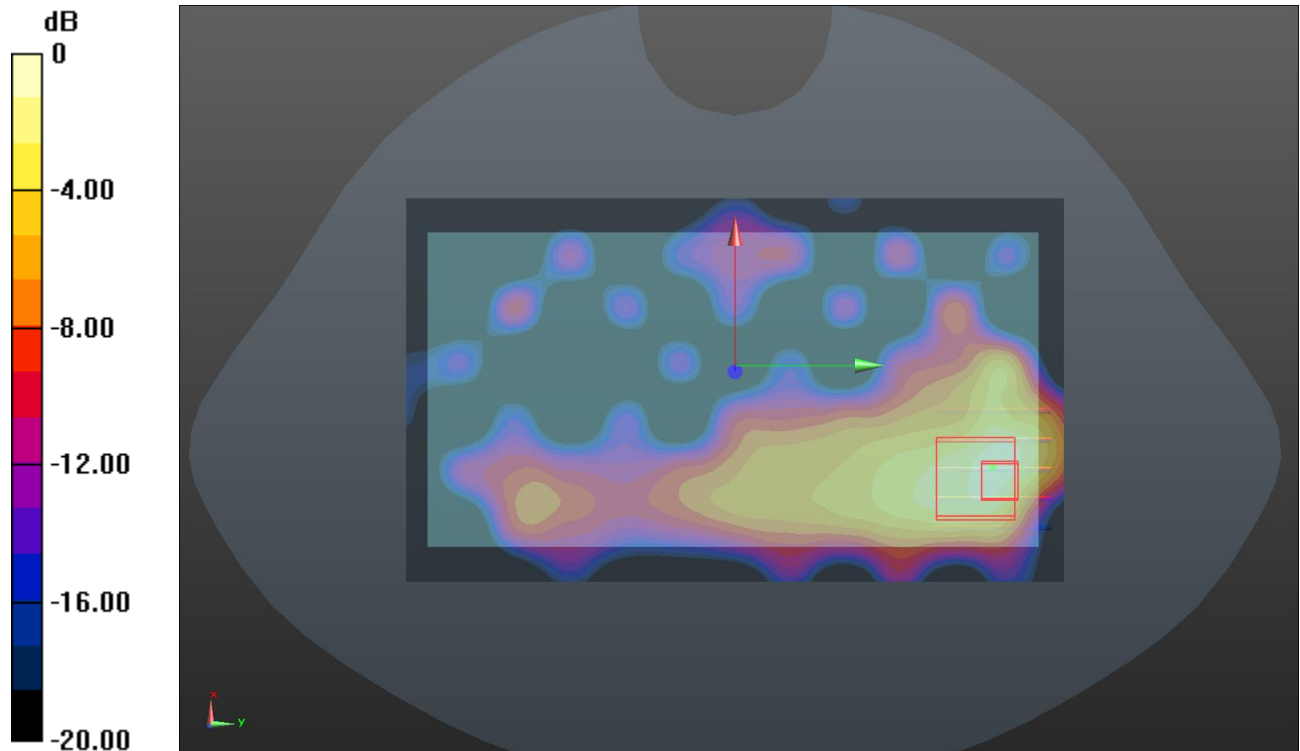

15. Simultaneous Transmission analysis

No.	Simultaneous Transmission Configurations	Head	Body-worn	Hotspot	Note
1	GSM(voice) + Bluetooth (data)	Yes	Yes		
2	GSM(voice) + WIFI (data)	Yes	Yes		
3	WCDMA(voice) + Bluetooth (data)	Yes	Yes		
4	WCDMA(voice) + WIFI (data)	Yes	Yes		
5	GPRS (data) + Bluetooth (data)	Yes	Yes	NA	
6	GPRS (data) + WIFI (data)	Yes	Yes	Yes	
7	WCDMA (data) + Bluetooth (data)	Yes	Yes	NA	
8	WCDMA (data) + WIFI (data)	Yes	Yes	Yes	

General note:

1. WLAN and Bluetooth share the same antenna, and cannot transmit simultaneously.
2. EUT will choose either GSM or WCDMA LTE according to the network signal condition; therefore, they will not operate simultaneously at any moment.
3. The reported SAR summation is calculated based on the same configuration and test position
4. For simultaneous transmission analysis, Bluetooth SAR is estimated per KDB 447498 D01 based on the formula below
 - a) $[(\text{max. Power of channel, including tune-up tolerance, mW}) / (\text{min. test separation distance, mm})] * [\sqrt{f(\text{GHz})/x}] \text{W/kg}$ for test separation distances $\leq 50\text{mm}$; when $x=7.5$ for 1-g SAR, and $x=18.75$ for 10-g SAR.
 - b) When the minimum separation distance is $<5\text{mm}$, the distance is used 5mm to determine SAR test exclusion
 - c) 0.4 W/kg for 1-g SAR and 1.0W/kg for 10-g SAR, when the test separation distances is $>50\text{mm}$.

Bluetooth Max power	Exposure position	Head	Body worn
	Test separation	0mm	10mm
2.50 dBm	Estimated SAR (W/kg)	0.074	0.037

Maximum reported SAR value for Head

WWAN PCE + WLAN DTS					
WWAN Band		Exposure Position	Max SAR (W/kg)		Summed SAR (W/kg)
			WWAN PCE	WLAN DTS	
GSM	GSM850	Left Cheek	0.248	0.291	0.539
		Left Tilted	0.190	0.246	0.436
		Right Cheek	0.230	0.279	0.510
		Right Tilted	0.174	0.235	0.409
	PCS1900	Left Cheek	0.116	0.291	0.407
		Left Tilted	0.093	0.246	0.340
		Right Cheek	0.112	0.279	0.391
		Right Tilted	0.088	0.235	0.322
WCDMA	Band II	Left Cheek	0.203	0.291	0.493
		Left Tilted	0.167	0.246	0.413
		Right Cheek	0.193	0.279	0.473
		Right Tilted	0.155	0.235	0.389
	Band V	Left Cheek	0.133	0.291	0.423
		Left Tilted	0.107	0.246	0.353
		Right Cheek	0.128	0.279	0.407
		Right Tilted	0.101	0.235	0.335

WWAN PCE + Bluetooth					
WWAN Band		Exposure Position	Max SAR (W/kg)		Summed SAR (W/kg)
			WWAN PCE	Bluetooth	
GSM	GSM850	Left Cheek	0.248	0.074	0.323
		Left Tilted	0.190	0.074	0.264
		Right Cheek	0.230	0.074	0.305
		Right Tilted	0.174	0.074	0.249
	PCS1900	Left Cheek	0.116	0.074	0.190
		Left Tilted	0.093	0.074	0.168
		Right Cheek	0.112	0.074	0.186
		Right Tilted	0.088	0.074	0.162
WCDMA	Band II	Left Cheek	0.203	0.074	0.277
		Left Tilted	0.167	0.074	0.241
		Right Cheek	0.193	0.074	0.268
		Right Tilted	0.155	0.074	0.229
	Band V	Left Cheek	0.133	0.074	0.207
		Left Tilted	0.107	0.074	0.181
		Right Cheek	0.128	0.074	0.202
		Right Tilted	0.101	0.074	0.175

Maximum reported SAR value for Body

WWAN PCE + WLAN DTS					
WWAN Band		Exposure Position	Max SAR (W/kg)		Summed SAR
			WWAN PCE	WLAN DTS	(W/kg)
GSM	GSM850	Front	0.237	0.099	0.336
		Back	0.274	0.146	0.420
	PCS1900	Front	0.159	0.099	0.258
		Back	0.251	0.146	0.397
WCDMA	Band II	Front	0.229	0.099	0.329
		Back	0.322	0.146	0.468
	Band V	Front	0.152	0.099	0.251
		Back	0.246	0.146	0.392

WWAN PCE + Bluetooth					
WWAN Band		Exposure Position	Max SAR (W/kg)		Summed SAR
			WWAN PCE	Bluetooth	(W/kg)
GSM	GSM850	Front	0.237	0.037	0.274
		Back	0.274	0.037	0.311
	PCS1900	Front	0.159	0.037	0.196
		Back	0.251	0.037	0.288
WCDMA	Band II	Front	0.229	0.037	0.266
		Back	0.322	0.037	0.359
	Band V	Front	0.152	0.037	0.189
		Back	0.246	0.037	0.283

Maximum reported SAR value for Hotspot mode

WWAN PCE + WLAN DTS					
WWAN Band		Exposure Position	Max SAR (W/kg)		Summed SAR
			WWAN PCE	WLAN DTS	(W/kg)
GSM	GSM850	Front	0.237	0.099	0.336
		Back	0.274	0.146	0.420
		Left side	0.168	-	0.168
		Right side	0.141	0.122	0.263
		Top side	-	0.096	0.096
		Bottom side	0.172	-	0.172
	PCS1900	Front	0.159	0.099	0.258
		Back	0.251	0.146	0.397
		Left side	0.152	-	0.152
		Right side	0.116	0.122	0.238
		Top side	-	0.096	0.096
		Bottom side	0.183	-	0.183
WCDMA	Band II	Front	0.229	0.099	0.329
		Back	0.322	0.146	0.468
		Left side	0.219	-	0.219
		Right side	0.155	0.122	0.277
		Top side	-	0.096	0.096
		Bottom side	0.244	-	0.244
	Band V	Front	0.152	0.099	0.251
		Back	0.246	0.146	0.392
		Left side	0.174	-	0.174
		Right side	0.125	0.122	0.247
		Top side	-	0.096	0.096
		Bottom side	0.149	-	0.149

16. TestSetup Photos

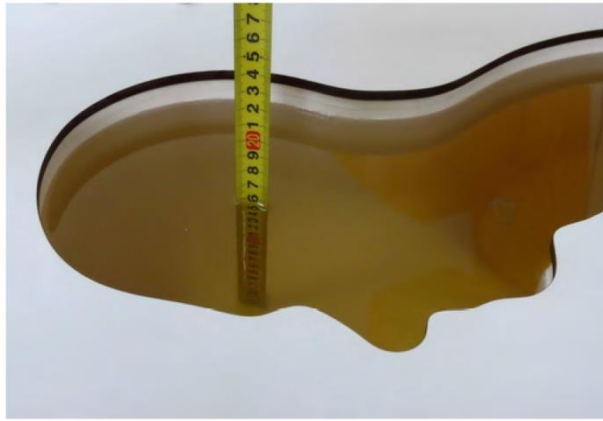

Liquid depth in the head phantom (835MHz)



Liquid depth in the body phantom (835MHz)



Liquid depth in the head phantom (1900MHz)

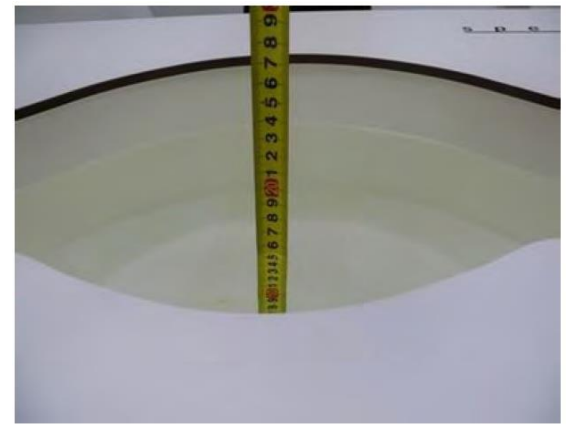

Liquid depth in the body phantom (1900MHz)



Liquid depth in the head phantom (2450MHz)



Liquid depth in the body phantom (2450MHz)



Left Head Touch



Right Head Touch

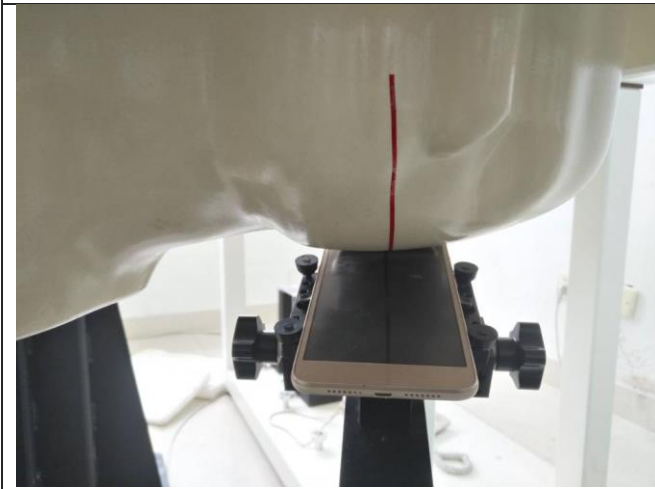

Left Head Tilt (15°)

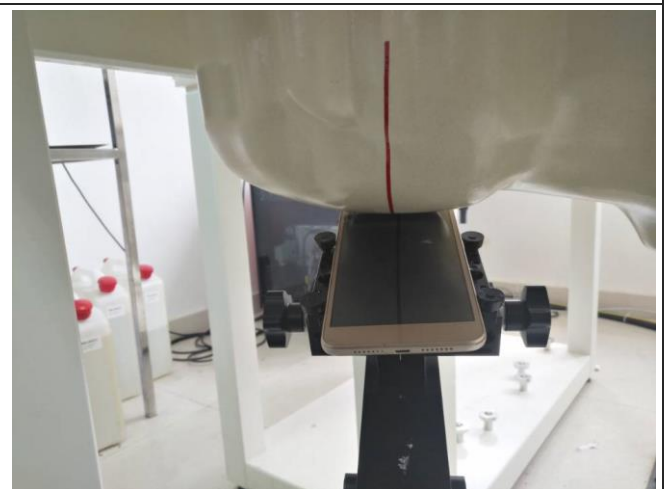

Right Head Tilt (15°)



Body-worn Front Side (10mm)



Body-worn Rear Side (10mm)

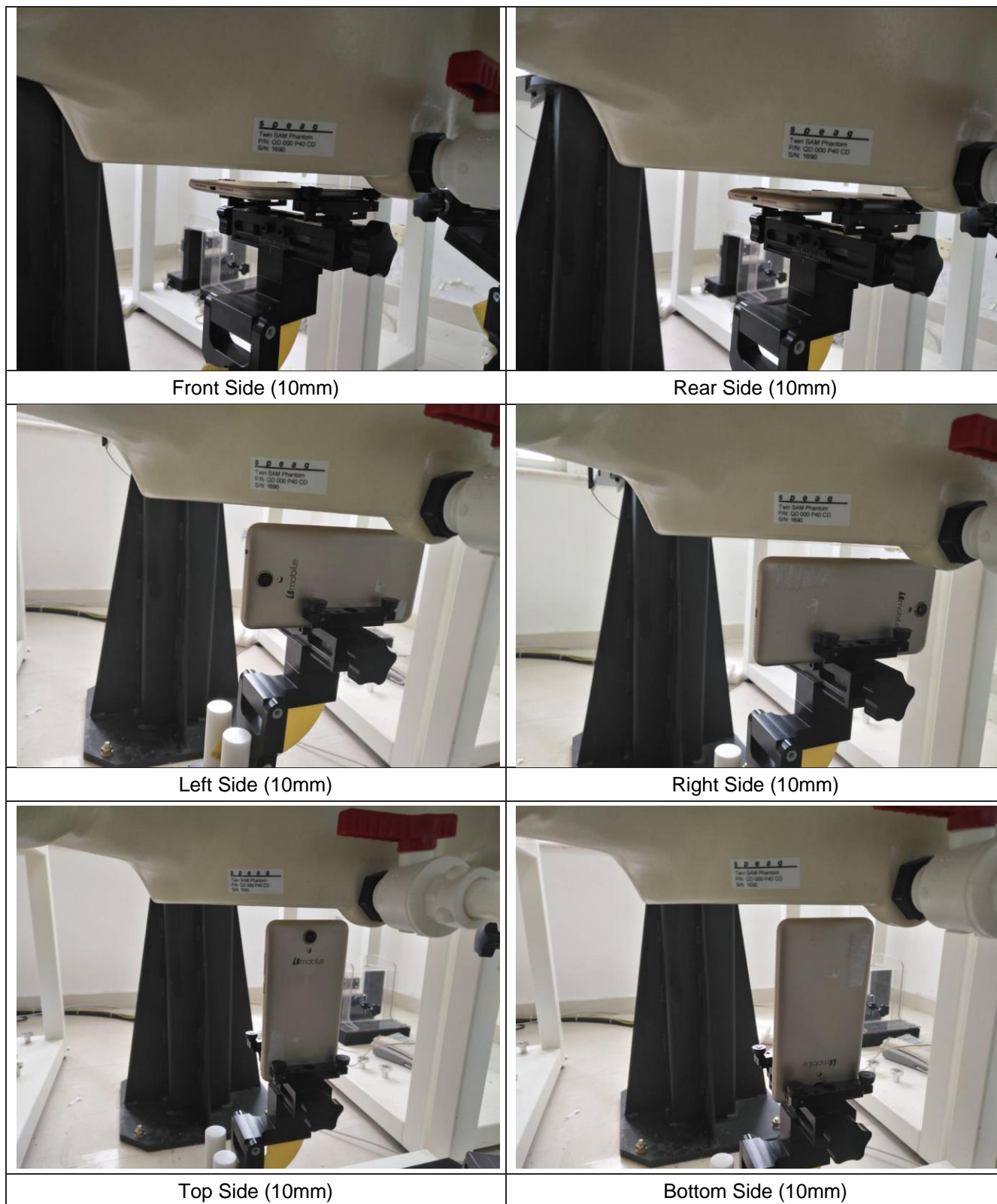

17. External and Internal Photos of the EUT

Please reference to the report No.: TRE1801017201

-----End of Report-----

1.1. DAE4 Calibration Certificate



Add: No.51 Xueyuan Road, Haidian District, Beijing, 100191, China
 Tel: +86-10-62304633-2218 Fax: +86-10-62304633-2209
 E-mail: cttl@chinattl.com [Http://www.chinattl.cn](http://www.chinattl.cn)



中国认可
 国际互认
 校准
 CALIBRATION
 CNAS L0570

Client : **CIQ(Shenzhen)**

Certificate No: **Z17-97109**

CALIBRATION CERTIFICATE			
Object	DAE4 - SN: 1315		
Calibration Procedure(s)	FF-Z11-002-01 Calibration Procedure for the Data Acquisition Electronics (DAEx)		
Calibration date:	August 15, 2017		
<p>This calibration Certificate documents the traceability to national standards, which realize the physical units of measurements(SI). The measurements and the uncertainties with confidence probability are given on the following pages and are part of the certificate.</p> <p>All calibrations have been conducted in the closed laboratory facility: environment temperature(22±3)°C and humidity<70%.</p> <p>Calibration Equipment used (M&TE critical for calibration)</p>			
Primary Standards	ID #	Cal Date(Calibrated by, Certificate No.)	Scheduled Calibration
Process Calibrator 753	1971018	27-Jun-17 (CTTL, No.J17X05859)	June-18
Calibrated by:	Name Yu Zongying	Function SAR Test Engineer	Signature
Reviewed by:	Name Lin Hao	Function SAR Test Engineer	Signature
Approved by:	Name Qi Dianyuan	Function SAR Project Leader	Signature
Issued: August 16, 2017			
This calibration certificate shall not be reproduced except in full without written approval of the laboratory.			



Add: No.51 Xueyuan Road, Haidian District, Beijing, 100191, China
Tel: +86-10-62304633-2218 Fax: +86-10-62304633-2209
E-mail: cttl@chinattl.com Http://www.chinattl.cn

Glossary:

DAE data acquisition electronics
Connector angle information used in DASY system to align probe sensor X to the robot coordinate system.

Methods Applied and Interpretation of Parameters:

- *DC Voltage Measurement:* Calibration Factor assessed for use in DASY system by comparison with a calibrated instrument traceable to national standards. The figure given corresponds to the full scale range of the voltmeter in the respective range.
- *Connector angle:* The angle of the connector is assessed measuring the angle mechanically by a tool inserted. Uncertainty is not required.
- The report provide only calibration results for DAE, it does not contain other performance test results.



Add: No.51 Xueyuan Road, Haidian District, Beijing, 100191, China
Tel: +86-10-62304633-2218 Fax: +86-10-62304633-2209
E-mail: cttl@chinattl.com Http://www.chinattl.cn

DC Voltage Measurement

A/D - Converter Resolution nominal

High Range: 1LSB = 6.1μV, full range = -100...+300 mV

Low Range: 1LSB = 61nV, full range = -1.....+3mV

DASY measurement parameters: Auto Zero Time: 3 sec; Measuring time: 3 sec

Calibration Factors	X	Y	Z
High Range	405.175 ± 0.15% (k=2)	405.013 ± 0.15% (k=2)	404.971 ± 0.15% (k=2)
Low Range	3.99087 ± 0.7% (k=2)	3.98644 ± 0.7% (k=2)	3.98913 ± 0.7% (k=2)

Connector Angle

Connector Angle to be used in DASY system	20.5° ± 1 °
---	-------------

1.2. Probe Calibration Certificate



Add: No.51 Xueyuan Road, Haidian District, Beijing, 100191, China
 Tel: +86-10-62304633-2218 Fax: +86-10-62304633-2209
 E-mail: cttl@chinattl.com [Http://www.chinattl.cn](http://www.chinattl.cn)



中国认可
 国际互认
 校准
 CALIBRATION
 CNAS L0570

Client **CIQ(Shenzhen)** Certificate No: **Z17-97110**

CALIBRATION CERTIFICATE

Object **EX3DV4 - SN:3842**

Calibration Procedure(s) **FF-Z11-004-01
 Calibration Procedures for Dosimetric E-field Probes**

Calibration date: **August 15, 2017**

This calibration Certificate documents the traceability to national standards, which realize the physical units of measurements(SI). The measurements and the uncertainties with confidence probability are given on the following pages and are part of the certificate.

All calibrations have been conducted in the closed laboratory facility: environment temperature(22±3)°C and humidity<70%.

Calibration Equipment used (M&TE critical for calibration)

Primary Standards	ID #	Cal Date(Calibrated by, Certificate No.)	Scheduled Calibration
Power Meter NRP2	101919	27-Jun-17 (CTTL, No.J17X05857)	Jun-18
Power sensor NRP-Z91	101547	27-Jun-17 (CTTL, No.J17X05857)	Jun-18
Power sensor NRP-Z91	101548	27-Jun-17 (CTTL, No.J17X05857)	Jun-18
Reference10dBAttenuator	18N50W-10dB	13-Mar-16(CTTL,No.J16X01547)	Mar-18
Reference20dBAttenuator	18N50W-20dB	13-Mar-16(CTTL, No.J16X01548)	Mar-18
Reference Probe EX3DV4	SN 7433	26-Sep-16(SPEAG,No.EX3-7433_Sep16)	Sep-17
DAE4	SN 549	13-Dec-16(SPEAG, No.DAE4-549_Dec16)	Dec -17
Secondary Standards	ID #	Cal Date(Calibrated by, Certificate No.)	Scheduled Calibration
SignalGeneratorMG3700A	6201052605	27-Jun-17 (CTTL, No.J17X05858)	Jun-18
Network Analyzer E5071C	MY46110673	13-Jan-17 (CTTL, No.J17X00285)	Jan -18

	Name	Function	Signature
Calibrated by:	Yu Zongying	SAR Test Engineer	
Reviewed by:	Lin Hao	SAR Test Engineer	
Approved by:	Qi Dianyuan	SAR Project Leader	

Issued: August 16, 2017

This calibration certificate shall not be reproduced except in full without written approval of the laboratory.



Add: No.51 Xueyuan Road, Haidian District, Beijing, 100191, China
Tel: +86-10-62304633-2218 Fax: +86-10-62304633-2209
E-mail: cttl@chinattl.com [Http://www.chinattl.cn](http://www.chinattl.cn)

Glossary:

TSL	tissue simulating liquid
NORM _{x,y,z}	sensitivity in free space
ConvF	sensitivity in TSL / NORM _{x,y,z}
DCP	diode compression point
CF	crest factor (1/duty_cycle) of the RF signal
A,B,C,D	modulation dependent linearization parameters
Polarization Φ	Φ rotation around probe axis
Polarization θ	θ rotation around an axis that is in the plane normal to probe axis (at measurement center), i $\theta=0$ is normal to probe axis

Connector Angle information used in DAS4 system to align probe sensor X to the robot coordinate system

Calibration is Performed According to the Following Standards:

- IEEE Std 1528-2013, "IEEE Recommended Practice for Determining the Peak Spatial-Averaged Specific Absorption Rate (SAR) in the Human Head from Wireless Communications Devices: Measurement Techniques", June 2013
- IEC 62209-1, "Measurement procedure for the assessment of Specific Absorption Rate (SAR) from hand-held and body-mounted devices used next to the ear (frequency range of 300 MHz to 6 GHz)", July 2016
- IEC 62209-2, "Procedure to determine the Specific Absorption Rate (SAR) for wireless communication devices used in close proximity to the human body (frequency range of 30 MHz to 6 GHz)", March 2010
- KDB 865664, "SAR Measurement Requirements for 100 MHz to 6 GHz"

Methods Applied and Interpretation of Parameters:

- NORM_{x,y,z}**: Assessed for E-field polarization $\theta=0$ ($f \leq 900$ MHz in TEM-cell; $f > 1800$ MHz: waveguide). NORM_{x,y,z} are only intermediate values, i.e., the uncertainties of NORM_{x,y,z} does not effect the E^2 -field uncertainty inside TSL (see below ConvF).
- NORM(f)_{x,y,z} = NORM_{x,y,z} * frequency_response** (see Frequency Response Chart). This linearization is implemented in DAS4 software versions later than 4.2. The uncertainty of the frequency response is included in the stated uncertainty of ConvF.
- DCP_{x,y,z}**: DCP are numerical linearization parameters assessed based on the data of power sweep (no uncertainty required). DCP does not depend on frequency nor media.
- PAR**: PAR is the Peak to Average Ratio that is not calibrated but determined based on the signal characteristics.
- A_{x,y,z}; B_{x,y,z}; C_{x,y,z}; VR_{x,y,z}; A,B,C** are numerical linearization parameters assessed based on the data of power sweep for specific modulation signal. The parameters do not depend on frequency nor media. VR is the maximum calibration range expressed in RMS voltage across the diode.
- ConvF and Boundary Effect Parameters**: Assessed in flat phantom using E-field (or Temperature Transfer Standard for $f \leq 800$ MHz) and inside waveguide using analytical field distributions based on power measurements for $f > 800$ MHz. The same setups are used for assessment of the parameters applied for boundary compensation (alpha, depth) of which typical uncertainty valued are given. These parameters are used in DAS4 software to improve probe accuracy close to the boundary. The sensitivity in TSL corresponds to NORM_{x,y,z} * ConvF whereby the uncertainty corresponds to that given for ConvF. A frequency dependent ConvF is used in DAS4 version 4.4 and higher which allows extending the validity from ± 50 MHz to ± 100 MHz.
- Spherical isotropy (3D deviation from isotropy)**: in a field of low gradients realized using a flat phantom exposed by a patch antenna.
- Sensor Offset**: The sensor offset corresponds to the offset of virtual measurement center from the probe tip (on probe axis). No tolerance required.
- Connector Angle**: The angle is assessed using the information gained by determining the NORM_x (no uncertainty required).



Add: No.51 Xueyuan Road, Haidian District, Beijing, 100191, China
Tel: +86-10-62304633-2218 Fax: +86-10-62304633-2209
E-mail: ctl@chinattl.com [Http://www.chinattl.cn](http://www.chinattl.cn)

Probe EX3DV4

SN: 3842

Calibrated: August 15, 2017

Calibrated for DASY/EASY Systems

(Note: non-compatible with DASY2 system!)



Add: No.51 Xueyuan Road, Haidian District, Beijing, 100191, China
 Tel: +86-10-62304633-2218 Fax: +86-10-62304633-2209
 E-mail: cttl@chinattl.com [Http://www.chinattl.cn](http://www.chinattl.cn)

DASY/EASY – Parameters of Probe: EX3DV4 – SN: 3842

Basic Calibration Parameters

	Sensor X	Sensor Y	Sensor Z	Unc (k=2)
Norm($\mu\text{V}/(\text{V}/\text{m})^2$) ^A	0.34	0.53	0.42	±10.0%
DCP(mV) ^B	102.3	102.6	101.2	

Modulation Calibration Parameters

UID	Communication System Name		A dB	B dB/μV	C	D dB	VR mV	Unc ^E (k=2)
0	CW	X	0.0	0.0	1.0	0.00	137.4	±2.1%
		Y	0.0	0.0	1.0		176.2	
		Z	0.0	0.0	1.0		153.3	

The reported uncertainty of measurement is stated as the standard uncertainty of Measurement multiplied by the coverage factor k=2, which for a normal distribution Corresponds to a coverage probability of approximately 95%.

^A The uncertainties of Norm X, Y, Z do not affect the E²-field uncertainty inside TSL (see Page 5 and Page 6).
^B Numerical linearization parameter: uncertainty not required.
^E Uncertainty is determined using the max. deviation from linear response applying rectangular distribution and is expressed for the square of the field value.



Add: No.51 Xueyuan Road, Haidian District, Beijing, 100191, China
 Tel: +86-10-62304633-2218 Fax: +86-10-62304633-2209
 E-mail: cttl@chinattl.com [Http://www.chinattl.cn](http://www.chinattl.cn)

DASY/EASY – Parameters of Probe: EX3DV4 – SN: 3842

Calibration Parameter Determined in Head Tissue Simulating Media

f [MHz] ^C	Relative Permittivity ^F	Conductivity (S/m) ^F	ConvF X	ConvF Y	ConvF Z	Alpha ^G	Depth ^G (mm)	Unct. (k=2)
750	41.9	0.89	9.41	9.41	9.41	0.30	0.90	±12.1%
900	41.5	0.97	9.15	9.15	9.15	0.16	1.37	±12.1%
1750	40.1	1.37	7.89	7.89	7.89	0.23	1.09	±12.1%
1900	40.0	1.40	7.58	7.58	7.58	0.20	1.19	±12.1%
2450	39.2	1.80	6.92	6.92	6.92	0.32	1.16	±12.1%
2600	39.0	1.96	6.78	6.78	6.78	0.40	0.93	±12.1%

^C Frequency validity above 300 MHz of ±100MHz only applies for DASY v4.4 and higher (Page 2), else it is restricted to ±50MHz. The uncertainty is the RSS of ConvF uncertainty at calibration frequency and the uncertainty for the indicated frequency band. Frequency validity below 300 MHz is ± 10, 25, 40, 50 and 70 MHz for ConvF assessments at 30, 64, 128, 150 and 220 MHz respectively. Above 5 GHz frequency validity can be extended to ± 110 MHz.

^F At frequency below 3 GHz, the validity of tissue parameters (ϵ and σ) can be relaxed to ±10% if liquid compensation formula is applied to measured SAR values. At frequencies above 3 GHz, the validity of tissue parameters (ϵ and σ) is restricted to ±5%. The uncertainty is the RSS of the ConvF uncertainty for indicated target tissue parameters.

^G Alpha/Depth are determined during calibration. SPEAG warrants that the remaining deviation due to the boundary effect after compensation is always less than ± 1% for frequencies below 3 GHz and below ± 2% for the frequencies between 3-6 GHz at any distance larger than half the probe tip diameter from the boundary.



Add: No.51 Xueyuan Road, Haidian District, Beijing, 100191, China
Tel: +86-10-62304633-2218 Fax: +86-10-62304633-2209
E-mail: cttl@chinattl.com [Http://www.chinattl.cn](http://www.chinattl.cn)

DASY/EASY – Parameters of Probe: EX3DV4 – SN: 3842

Calibration Parameter Determined in Body Tissue Simulating Media

f [MHz] ^C	Relative Permittivity ^F	Conductivity (S/m) ^F	ConvF X	ConvF Y	ConvF Z	Alpha ^G	Depth ^G (mm)	Unct. (k=2)
750	55.5	0.96	9.31	9.31	9.31	0.30	0.90	±12.1%
900	55.0	1.05	9.02	9.02	9.02	0.24	1.15	±12.1%
1750	53.4	1.49	7.57	7.57	7.57	0.23	1.12	±12.1%
1900	53.3	1.52	7.32	7.32	7.32	0.22	1.21	±12.1%
2450	52.7	1.95	7.01	7.01	7.01	0.42	1.04	±12.1%
2600	52.5	2.16	6.97	6.97	6.97	0.42	1.01	±12.1%

^C Frequency validity above 300 MHz of ±100MHz only applies for DASY v4.4 and higher (Page 2), else it is restricted to ±50MHz. The uncertainty is the RSS of ConvF uncertainty at calibration frequency and the uncertainty for the indicated frequency band. Frequency validity below 300 MHz is ± 10, 25, 40, 50 and 70 MHz for ConvF assessments at 30, 64, 128, 150 and 220 MHz respectively. Above 5 GHz frequency validity can be extended to ± 110 MHz.

^F At frequency below 3 GHz, the validity of tissue parameters (ϵ and σ) can be relaxed to ±10% if liquid compensation formula is applied to measured SAR values. At frequencies above 3 GHz, the validity of tissue parameters (ϵ and σ) is restricted to ±5%. The uncertainty is the RSS of the ConvF uncertainty for indicated target tissue parameters.

^G Alpha/Depth are determined during calibration. SPEAG warrants that the remaining deviation due to the boundary effect after compensation is always less than ± 1% for frequencies below 3 GHz and below ± 2% for the frequencies between 3-6 GHz at any distance larger than half the probe tip diameter from the boundary.