



TEST REPORT

Report Reference No...... : **TRE1801017203** R/C.....: 66089

FCC ID..... : **ZSW-30-061**

Applicant's name..... : **b mobile HK Limited**

Address..... : Flat 18; 14/F Block 1; Golden Industrial Building; 16-26 Kwai Tak Street; Kwai Chung; New Territories; Hong Kong.

Manufacturer..... : b mobile HK Limited

Address..... : Flat 18; 14/F Block 1; Golden Industrial Building; 16-26 Kwai Tak Street; Kwai Chung; New Territories; Hong Kong.

Test item description : **Mobile Phone**

Trade Mark : Bmobile

Model/Type reference..... : AX950

Listed Model(s) : -

Standard : **FCC CFR Title 47 Part 15 Subpart C Section 15.247**

Date of receipt of test sample..... : Jan. 23, 2018

Date of testing..... : Jan. 24, 2018 - Feb. 04, 2018

Date of issue..... : Feb. 05, 2018

Result..... : **PASS**

Compiled by
(position+printedname+signature)....: File administrators Becky Liang

Supervised by
(position+printedname+signature)....: Project Engineer : Edward Pan

Approved by
(position+printedname+signature)....: Manager Hans Hu

Testing Laboratory Name : **Shenzhen Huatongwei International Inspection Co., Ltd.**

Address..... : 1/F, Bldg 3, Hongfa Hi-tech Industrial Park, Genyu Road, Tianliao, Gongming, Shenzhen, China

Shenzhen Huatongwei International Inspection Co., Ltd. All rights reserved.

This publication may be reproduced in whole or in part for non-commercial purposes as long as the Shenzhen Huatongwei International Inspection Co., Ltd. is acknowledged as copyright owner and source of the material. Shenzhen Huatongwei International Inspection Co., Ltd. takes no responsibility for and will not assume liability for damages resulting from the reader's interpretation of the reproduced material due to its placement and context.

The test report merely correspond to the test sample.

Contents

1.	<u>TEST STANDARDS AND REPORT VERSION</u>	3
1.1.	Test Standards	3
1.2.	Report version	3
2.	<u>TEST DESCRIPTION</u>	4
3.	<u>SUMMARY</u>	5
3.1.	Client Information	5
3.2.	Product Description	5
3.3.	Operation state	6
3.4.	EUT configuration	6
3.5.	Modifications	6
4.	<u>TEST ENVIRONMENT</u>	7
4.1.	Address of the test laboratory	7
4.2.	Test Facility	7
4.3.	Environmental conditions	8
4.4.	Statement of the measurement uncertainty	8
4.5.	Equipments Used during the Test	9
5.	<u>TEST CONDITIONS AND RESULTS</u>	11
5.1.	Antenna requirement	11
5.2.	Conducted Emissions (AC Main)	12
5.3.	Conducted Peak Output Power	15
5.4.	Power Spectral Density	16
5.5.	6dB bandwidth	22
5.6.	Restricted band	28
5.7.	Band edge and Spurious Emissions (conducted)	33
5.8.	Spurious Emissions (radiated)	50
6.	<u>TEST SETUP PHOTOS</u>	59
7.	<u>EXTERANAL AND INTERNAL PHOTOS</u>	60

1. TEST STANDARDS AND REPORT VERSION

1.1. Test Standards

The tests were performed according to following standards:

[FCC Rules Part 15.247](#): Frequency Hopping, Direct Spread Spectrum and Hybrid Systems that are in operation within the bands of 902-928 MHz, 2400-2483.5 MHz, and 5725-5850 MHz.

[ANSI C63.10:2013](#): American National Standard for Testing Unlicensed Wireless Devices

[KDB 558074 D01 DTS Meas Guidance v04](#): Guidance for Performing Compliance Measurements on Digital Transmission Systems (DTS) Operating under §15.247

1.2. Report version

Revision No.	Date of issue	Description
N/A	Feb. 05, 2018	Original

2. TEST DESCRIPTION

Test Item	FCC Rule	Result	Test Engineer
Antenna requirement	15.203/15.247(c)	PASS	Edward Pan
Line Conducted Emissions (AC Main)	15.207	PASS	Alex Guo
Conducted Peak Output Power	15.247(b)(3)	PASS	Baozhu Hu
Power Spectral Density	15.247(e)	PASS	Baozhu Hu
6dB Bandwidth	15.247(a)(2)	PASS	Baozhu Hu
Restricted band	15.247(d)/15.205	PASS	Baozhu Hu
Spurious Emissions	15.247(d)/15.209	PASS	Baozhu Hu

Note: The measurement uncertainty is not included in the test result.

3. SUMMARY

3.1. Client Information

Applicant:	b mobile HK Limited
Address:	Flat 18; 14/F Block 1; Golden Industrial Building;16-26 Kwai Tak Street; Kwai Chung; New Territories; Hong Kong.
Manufacturer:	b mobile HK Limited
Address:	Flat 18; 14/F Block 1; Golden Industrial Building;16-26 Kwai Tak Street; Kwai Chung; New Territories; Hong Kong.

3.2. Product Description

Name of EUT:	Mobile Phone
Trade Mark:	Bmobile
Model No.:	AX950
Listed Model(s):	-
IMEI 1:	865922019824530
IMEI 2:	865922019825081
Power supply:	DC 3.85V
Adapter information:	Input: 100-240Va.c., 50-60Hz, 0.2A Output: 5Vd.c., 1A
Hardware version:	m603-01
Software version:	Bmobile_AX950_Base_V002_MT6580_NO_V1.23.1@2018-01-06_09-0
WIFI	
Supported type:	802.11b/802.11g/802.11n(HT20)/802.11n(HT40)
Modulation:	DSSS for 802.11b OFDM for 802.11g/802.11n(HT20)/802.11n(HT40)
Operation frequency:	2412MHz~2462MHz for 802.11b/802.11g/802.11n(HT20) 2422MHz~2452MHz for 802.11n(HT40)
Channel number:	11 for 802.11b/802.11g/802.11n(HT20) 7 for 802.11n(HT40)
Channel separation:	5MHz
Antenna type:	Integral Antenna
Antenna gain:	0.98 dBi

3.3. Operation state

➤ **Test frequency list**

According to section 15.31(m), regards to the operating frequency range over 10 MHz, must select three channel which were tested. the Lowest frequency, the middle frequency, and the highest frequency of channel were selected to perform the test, please see the above gray bottom.

802.11b/g/n(HT20)		802.11n(HT40)	
Channel	Frequency (MHz)	Channel	Frequency (MHz)
01	2412	01	-
02	2417	02	-
03	2422	03	2422
04	2427	04	2427
05	2432	05	2432
06	2437	06	2437
07	2442	07	2442
08	2447	08	2447
09	2452	09	2452
10	2457	10	-
11	2462	11	-

➤ **Test mode**

For RF test items
The engineering test program was provided and enabled to make EUT continuous transmit (duty cycle>98%).
For AC power line conducted emissions:
The EUT was set to connect with the WLAN AP under large package sizes transmission.
For Radiated suprious emissions test item:
The engineering test program was provided and enabled to make EUT continuous transmit(duty cycle>98%). The EUT in each of three orthogonal axis emissions had been tested ,but only the worst case (X axis) data Recorded in the report.

3.4. EUT configuration

The following peripheral devices and interface cables were connected during the measurement:

- - supplied by the manufacturer
- - supplied by the lab

○	/	Manufacturer:	/
		Model No.:	/
○	/	Manufacturer:	/
		Model No.:	/

3.5. Modifications

No modifications were implemented to meet testing criteria.

4. TEST ENVIRONMENT

4.1. Address of the test laboratory

Laboratory: Shenzhen Huatongwei International Inspection Co., Ltd.

Address: 1/F, Bldg 3, Hongfa Hi-tech Industrial Park, Genyu Road, Tianliao, Gongming, Shenzhen, China

4.2. Test Facility

CNAS-Lab Code: L1225

Shenzhen Huatongwei International Inspection Co., Ltd. has been assessed and proved to be in compliance with CNAS-CL01 Accreditation Criteria for Testing and Calibration Laboratories (identical to ISO/IEC17025: 2005 General Requirements) for the Competence of Testing and Calibration Laboratories.

A2LA-Lab Cert. No.: 3902.01

Shenzhen Huatongwei International Inspection Co., Ltd. EMC Laboratory has been accredited by A2LA for technical competence in the field of electrical testing, and proved to be in compliance with ISO/IEC 17025: 2005 General Requirements for the Competence of Testing and Calibration Laboratories and any additional program requirements in the identified field of testing.

FCC-Registration No.: 762235

Shenzhen Huatongwei International Inspection Co., Ltd. EMC Laboratory has been registered and fully described in a report filed with the FCC (Federal Communications Commission). The acceptance letter from the FCC is maintained in our files.

IC-Registration No.:5377B-1

Two 3m Alternate Test Site of Shenzhen Huatongwei International Inspection Co., Ltd. has been registered by Certification and Engineering Bureau of Industry Canada for the performance of radiated measurements with Registration No.: 5377B-1.

ACA

Shenzhen Huatongwei International Inspection Co., Ltd. EMC Laboratory can also perform testing for the Australian C-Tick mark as a result of our A2LA accreditation.

4.3. Environmental conditions

During the measurement the environmental conditions were within the listed ranges:

Voltage	V _N =Nominal Voltage	DC 3.85V
	V _L =Lower Voltage	DC 3.60V
	V _H =Higher Voltage	DC 4.40V
Normal Temperature/T _{nor} :		15~35°C
Relative Humidity		30~60 %
Air Pressure		950-1050 hPa

4.4. Statement of the measurement uncertainty

The data and results referenced in this document are true and accurate. The reader is cautioned that there may be errors in calibration limits of the equipment and facilities. The measurement uncertainty was calculated for all measurements listed in this test report according to TR-100028-01 "Electromagnetic compatibility and Radio spectrum Matters (ERM); Uncertainties in the measurement of mobile radio equipment characteristics; Part 1" and TR-100028-02 "Electromagnetic compatibility and Radio spectrum Matters (ERM); Uncertainties in the measurement of mobile radio equipment characteristics; Part 2" and is documented in the Shenzhen Huatongwei International Inspection Co., Ltd. quality system according to ISO/IEC 17025. Furthermore, component and process variability of devices similar to that tested may result in additional deviation. The manufacturer has the sole responsibility of continued compliance of the device.

Here after the best measurement capability for Shenzhen Huatongwei International Inspection Co., Ltd. is reported:

Test Items	Measurement Uncertainty	Notes
Transmitter power conducted	0.57 dB	(1)
Transmitter power Radiated	2.20 dB	(1)
Conducted spurious emissions 9kHz~40GHz	1.60 dB	(1)
Radiated spurious emissions 9kHz~40GHz	2.20 dB	(1)
Conducted Emissions 9kHz~30MHz	3.39 dB	(1)
Radiated Emissions 30~1000MHz	4.24 dB	(1)
Radiated Emissions 1~18GHz	5.16 dB	(1)
Radiated Emissions 18~40GHz	5.54 dB	(1)

(1) This uncertainty represents an expanded uncertainty expressed at approximately the 95% confidence level using a coverage factor of k=1.96.

4.5. Equipments Used during the Test

Conducted Emissions						
Item	Test Equipment	Manufacturer	Model No.	Serial No.	Last Cal. (mm-dd-yy)	Next Cal. (mm-dd-yy)
1	EMI Test Receiver	R&S	ESCI	101247	11/11/2017	11/10/2018
2	Artificial Mains	SCHWARZBECK	NNLK 8121	573	11/11/2017	11/10/2018
3	2-Line V-Network	R&S	ESH3-Z5	100049	11/11/2017	11/10/2018
4	Pulse Limiter	R&S	ESH3-Z2	101488	11/11/2017	11/10/2018
5	RF Connection Cable	HUBER+SUHNER	EF400	N/A	11/21/2017	11/20/2018
6	Test Software	R&S	ES-K1	N/A	N/A	N/A

Radiated Emissions						
Item	Test Equipment	Manufacturer	Model No.	Serial No.	Last Cal. (mm-dd-yy)	Next Cal. (mm-dd-yy)
1	EMI Test Receiver	R&S	ESCI	101247	11/11/2017	11/10/2018
2	Loop Antenna	R&S	HFH2-Z2	100020	11/20/2017	11/19/2018
3	Ultra-Broadband Antenna	SCHWARZBECK	VULB9163	538	4/5/2017	4/4/2018
4	Preamplifier	SCHWARZBECK	BBV 9743	9743-0022	10/18/2017	10/17/2018
5	RF Connection Cable	HUBER+SUHNER	RE-7-FL	N/A	11/21/2017	11/20/2018
6	EMI Test Software	R&S	ESK1	N/A	N/A	N/A
7	Spectrum Analyzer	R&S	FSP40	100597	11/11/2017	11/10/2018
8	Horn Antenna	SCHWARZBECK	9120D	1011	3/27/2017	3/26/2018
9	Horn Antenna	SCHWARZBECK	BBHA9170	25841	3/27/2017	3/26/2018
10	Broadband Preamplifier	SCHWARZBECK	BBV 9718	9718-248	10/18/2017	10/17/2018
11	High pass filter	Compliance Direction systems	BSU-6	34202	11/11/2017	11/10/2018
12	RF Connection Cable	HUBER+SUHNER	RE-7-FH	N/A	11/21/2017	11/20/2018
13	EMI Test Software	Audix	E3	N/A	N/A	N/A
14	Turntable	MATURO	TT2.0	/	N/A	N/A
15	Antenna Mast	MATURO	TAM-4.0-P	/	N/A	N/A

RF Conducted Test						
Item	Test Equipment	Manufacturer	Model No.	Serial No.	Last Cal. (mm-dd-yy)	Next Cal. (mm-dd-yy)
1	Spectrum Analyzer	R&S	FSV40	100048	11/11/2017	11/10/2018
2	EXA Signal Analyzer	Agilent	N9020A	184247	9/22/2017	9/21/2018
3	Power Meter	Anritsu	ML249A	/	9/22/2017	9/21/2018
4	OSP	R&S	OSP120	101317	N/A	N/A

The Cal.Interval was one year.

5. TEST CONDITIONS AND RESULTS

5.1. Antenna requirement

REQUIREMENT:

FCC CFR Title 47 Part 15 Subpart C Section 15.203:

An intentional radiator shall be designed to ensure that no antenna other than that furnished by the responsible party shall be used with the device. The use of a permanently attached antenna or of an antenna that uses a unique coupling to the intentional radiator, the manufacturer may design the unit so that a broken antenna can be replaced by the user, but the use of a standard antenna jack or electrical connector is prohibited.

FCC CFR Title 47 Part 15 Subpart C Section 15.247(c) (1)(i):

(i) Systems operating in the 2400~2483.5 MHz band that is used exclusively for fixed. Point-to-point operations may employ transmitting antennas with directional gain greater than 6 dBi provided the maximum conducted output power of the intentional radiator is reduced by 1 dB for every 3 dB that the directional gain of the antenna exceeds 6 dBi.

TEST RESULTS

Passed Not Applicable

The directional gain of the antenna less than 6 dBi, please refer to the below antenna photo.

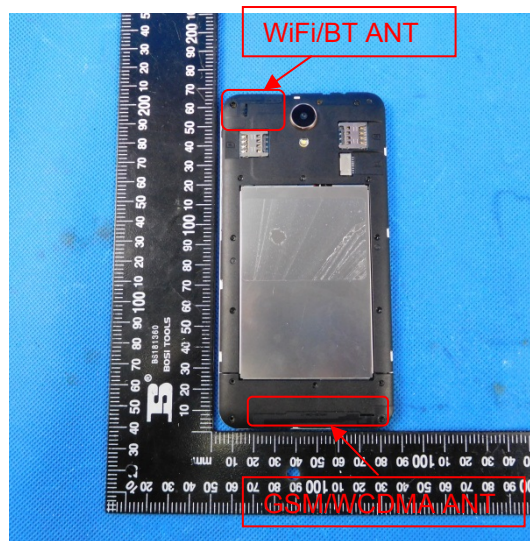

5.2. Conducted Emissions (AC Main)

LIMIT

FCC CFR Title 47 Part 15 Subpart C Section 15.207:

Frequency range (MHz)	Limit (dBuV)	
	Quasi-peak	Average
0.15-0.5	66 to 56*	56 to 46*
0.5-5	56	46
5-30	60	50

* Decreases with the logarithm of the frequency.

TEST CONFIGURATION

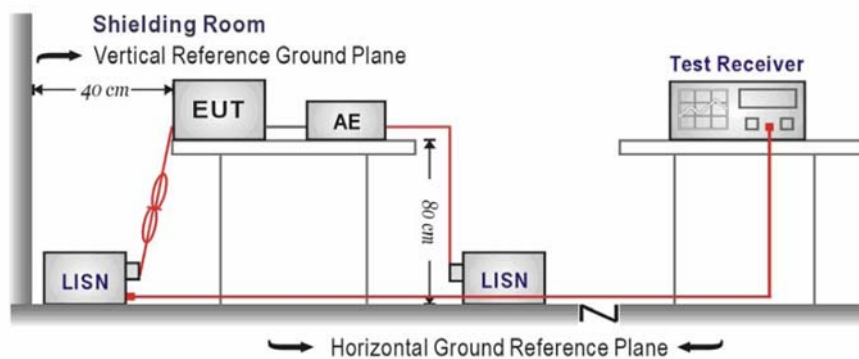

TEST PROCEDURE

1. The EUT was setup according to ANSI C63.10:2013 requirements.
2. The EUT was placed on a platform of nominal size, 1 m by 1.5 m, raised 80 cm above the conducting ground plane. The vertical conducting plane was located 40 cm to the rear of the EUT. All other surfaces of EUT were at least 80 cm from any other grounded conducting surface.
3. The EUT and simulators are connected to the main power through a line impedances stabilization network (LISN). The LISN provides a 50 ohm /50uH coupling impedance for the measuring equipment.
4. The peripheral devices are also connected to the main power through a LISN. (Please refer to the block diagram of the test setup and photographs)
5. Each current-carrying conductor of the EUT power cord, except the ground (safety) conductor, was individually connected through a LISN to the input power source.
6. The excess length of the power cord between the EUT and the LISN receptacle were folded back and forth at the center of the lead to form a bundle not exceeding 40 cm in length.
7. Conducted Emissions were investigated over the frequency range from 0.15MHz to 30MHz using a receiver bandwidth of 9 kHz.
8. During the above scans, the emissions were maximized by cable manipulation.

TEST MODE:

Please refer to the clause 3.3

TEST RESULTS

Passed Not Applicable

Note:

- 1) Transd=Cable lose+ Pulse Limiter Factor + Artificial Mains Factor
- 2) Margin= Limit -Level

Test Line:

L

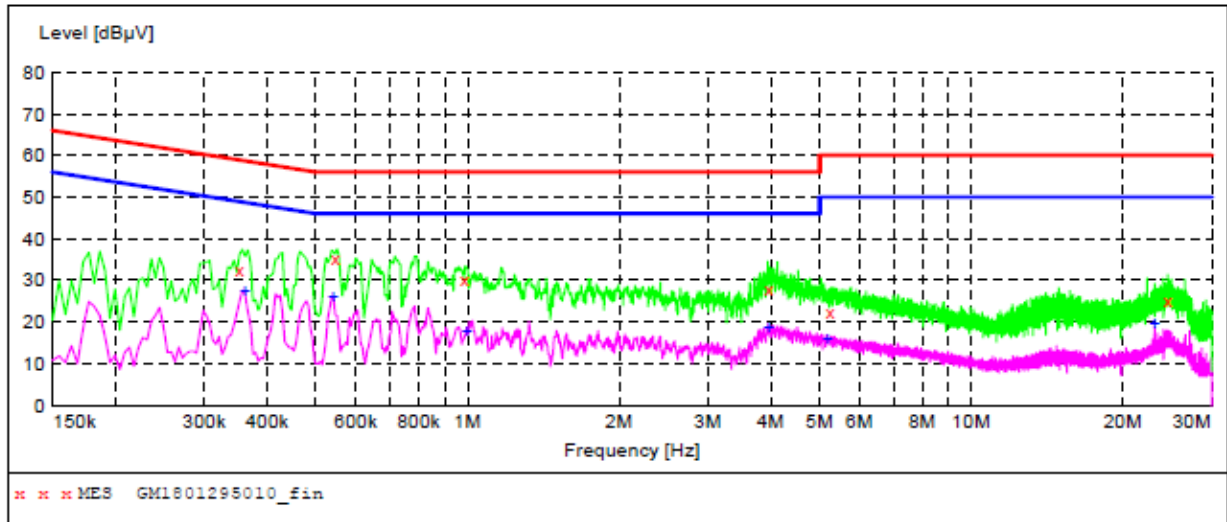

MEASUREMENT RESULT: "GM1801295010_fin"

1/29/2018 9:56AM

Frequency MHz	Level dBµV	Transd dB	Limit dBµV	Margin dB	Detector	Line	PE
0.352500	32.40	9.9	59	26.5	QP	L1	GND
0.546000	35.30	10.0	56	20.7	QP	L1	GND
0.987000	30.20	10.1	56	25.8	QP	L1	GND
3.966000	27.70	10.1	56	28.3	QP	L1	GND
5.239500	22.40	10.2	60	37.6	QP	L1	GND
24.531000	25.00	10.8	60	35.0	QP	L1	GND

MEASUREMENT RESULT: "GM1801295010_fin2"

1/29/2018 9:56AM

Frequency MHz	Level dBµV	Transd dB	Limit dBµV	Margin dB	Detector	Line	PE
0.361500	27.50	9.9	49	21.2	AV	L1	GND
0.541500	25.90	10.0	46	20.1	AV	L1	GND
0.996000	17.90	10.1	46	28.1	AV	L1	GND
3.957000	18.60	10.1	46	27.4	AV	L1	GND
5.185500	16.00	10.2	50	34.0	AV	L1	GND
23.127000	19.40	10.7	50	30.6	AV	L1	GND

Test Line: _____

N

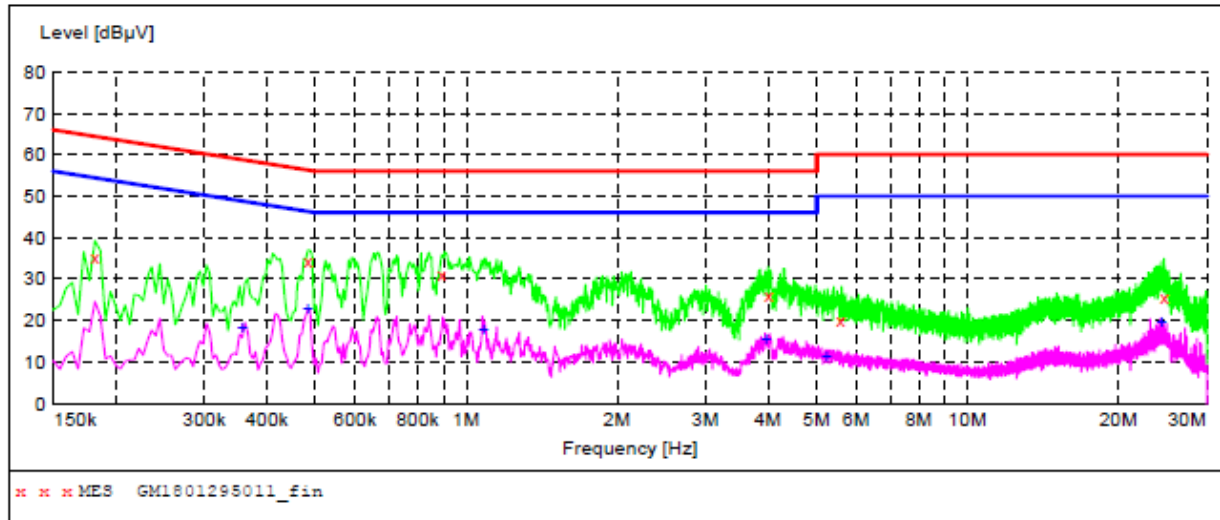

MEASUREMENT RESULT: "GM1801295011_fin"

1/29/2018 9:59AM

Frequency MHz	Level dBµV	Transd dB	Limit dBµV	Margin dB	Detector	Line	PE
0.181500	35.20	10.0	64	29.2	QP	N	GND
0.483000	34.40	9.9	56	21.9	QP	N	GND
0.892500	31.10	10.0	56	24.9	QP	N	GND
4.011000	25.90	10.1	56	30.1	QP	N	GND
5.586000	20.20	10.2	60	39.8	QP	N	GND
24.675000	25.70	10.8	60	34.3	QP	N	GND

MEASUREMENT RESULT: "GM1801295011_fin2"

1/29/2018 9:59AM

Frequency MHz	Level dBµV	Transd dB	Limit dBµV	Margin dB	Detector	Line	PE
0.357000	18.10	9.9	49	30.7	AV	N	GND
0.483000	22.60	9.9	46	23.7	AV	N	GND
1.081500	17.90	10.1	46	28.1	AV	N	GND
3.952500	15.40	10.1	46	30.6	AV	N	GND
5.221500	11.20	10.2	50	38.8	AV	N	GND
24.351000	19.50	10.8	50	30.5	AV	N	GND

5.3. Conducted Peak Output Power

LIMIT

FCC CFR Title 47 Part 15 Subpart C Section 15.247 (b)(3): 30dBm

TEST CONFIGURATION

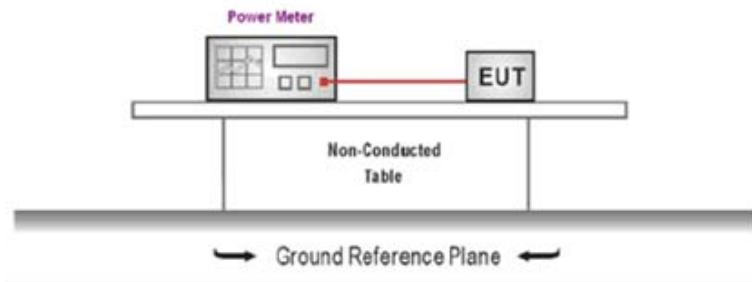

TEST PROCEDURE

1. The EUT was tested according to ANSI C63.10: 2013 and KDB 558074 D01 for compliance to FCC 47 CFR 15.247 requirements.
2. The maximum peak conducted output power may be measured using a broadband peak RF power meter.
3. The power meter shall have a video bandwidth that is greater than or equal to the DTS bandwidth and shall utilize a fast-responding diode detector
4. Record the measurement data.

TEST MODE:

Please refer to the clause 3.3

TEST RESULTS

Passed Not Applicable

Type	Channel	Output power (dBm)	Limit (dBm)	Result
802.11b	01	17.52	≤30.00	Pass
	06	17.21		
	11	17.13		
802.11g	01	15.54	≤30.00	Pass
	06	15.77		
	11	15.66		
802.11n(HT20)	01	14.61	≤30.00	Pass
	06	14.74		
	11	14.61		
802.11n(HT40)	03	12.11	≤30.00	Pass
	06	13.15		
	09	13.58		

5.4. Power Spectral Density

LIMIT

FCC CFR Title 47 Part 15 Subpart C Section 15.247 (e):

For digitally modulated systems, the power spectral density conducted from the intentional radiator to the antenna shall not be greater than 8 dBm in any 3 kHz band during any time interval of continuous transmission.

TEST CONFIGURATION

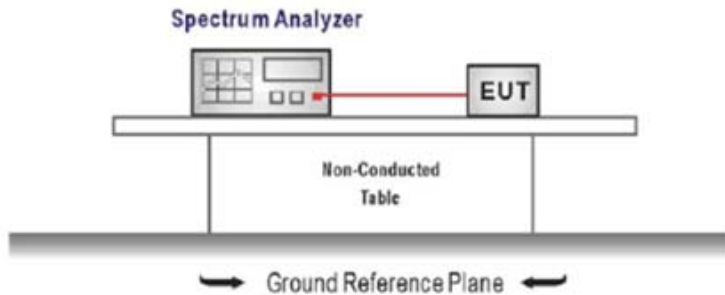

TEST PROCEDURE

1. Connect the antenna port(s) to the spectrum analyzer input,
2. Configure the spectrum analyzer as shown below:
Center frequency=DTS channel center frequency
Span =1.5 times the DTS bandwidth
RBW = 3 kHz ≤ RBW ≤ 100 kHz, VBW ≥ 3 × RBW
Sweep time = auto couple
Detector = peak
Trace mode = max hold
3. Place the radio in continuous transmit mode, allow the trace to stabilize, view the transmitter wave form on the spectrum analyzer.
4. Use the peak marker function to determine the maximum amplitude level within the RBW.
5. If measured value exceeds limit, reduce RBW (no less than 3 kHz) and repeat.

TEST MODE:

Please refer to the clause 3.3

TEST RESULTS

Passed Not Applicable

Type	Channel	Power Spectral Density (dBm/30KHz)	Power Spectral Density (dBm/3KHz)	Limit (dBm/3KHz)	Result
802.11b	01	5.39	-4.61	≤8.00	Pass
	06	4.86	-5.14		
	11	4.83	-5.17		
802.11g	01	-8.29	-18.29	≤8.00	Pass
	06	-8.53	-18.53		
	11	-7.85	-17.85		
802.11n(HT20)	01	-9.13	-19.13	≤8.00	Pass
	06	-9.12	-19.12		
	11	-9.14	-19.14		
802.11n(HT40)	03	-14.96	-24.96	≤8.00	Pass
	06	-14.33	-24.33		
	09	-13.89	-23.89		

Test plot as follows:

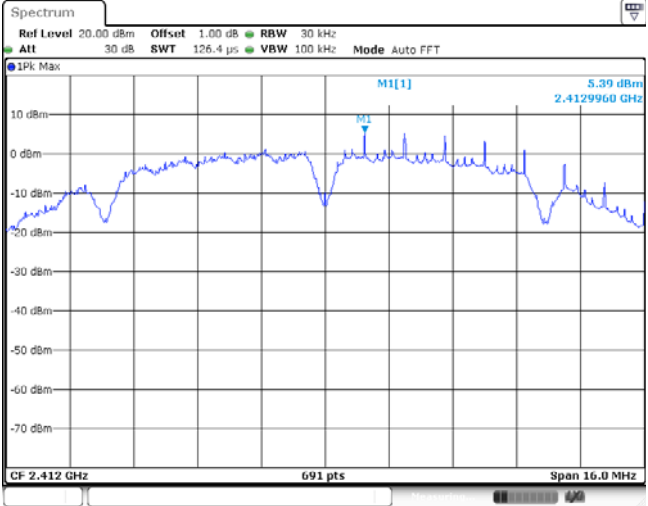
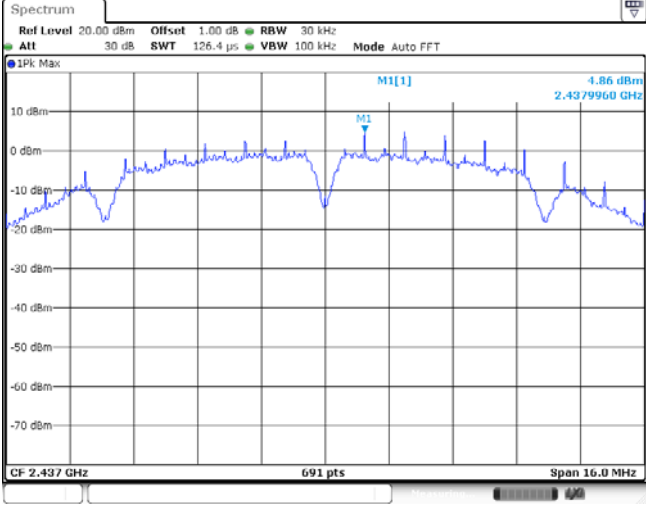
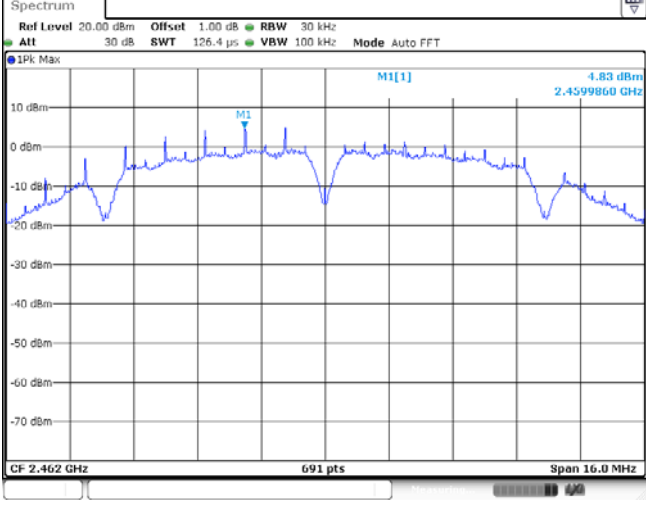
Type:		802.11 b
CH01		
CH06		
CH11		

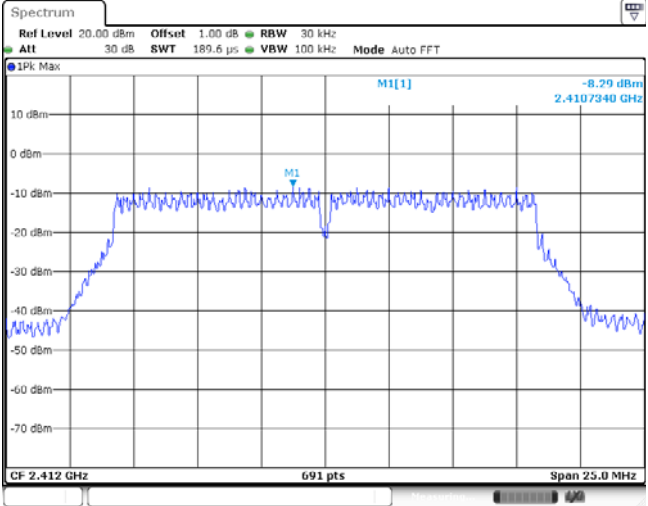
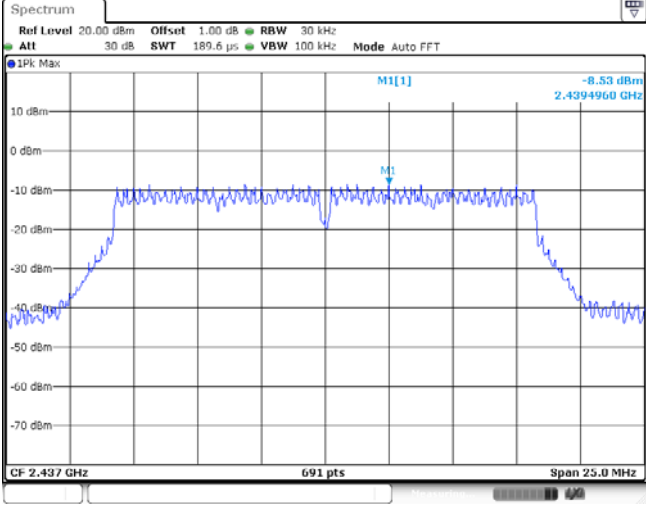
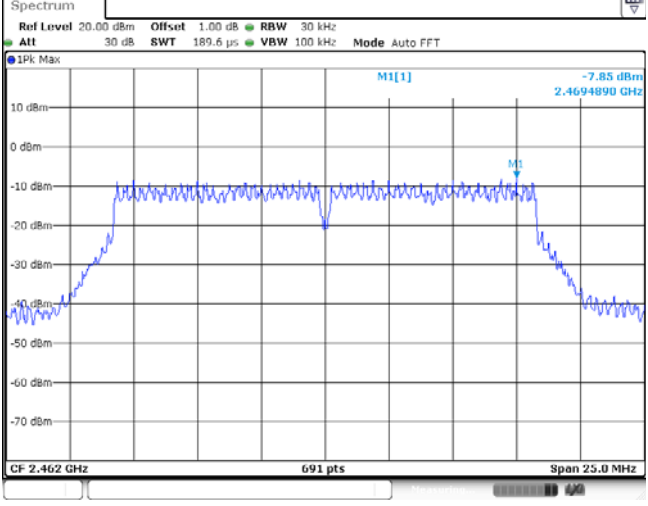
Type:		802.11 g
CH01		
CH06		
CH11		

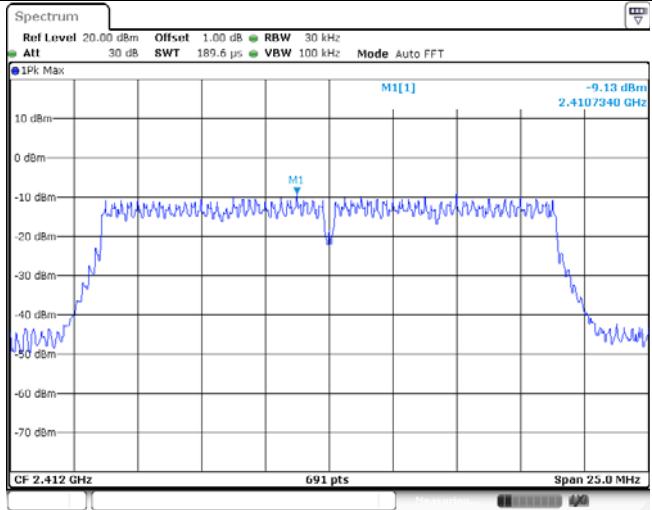
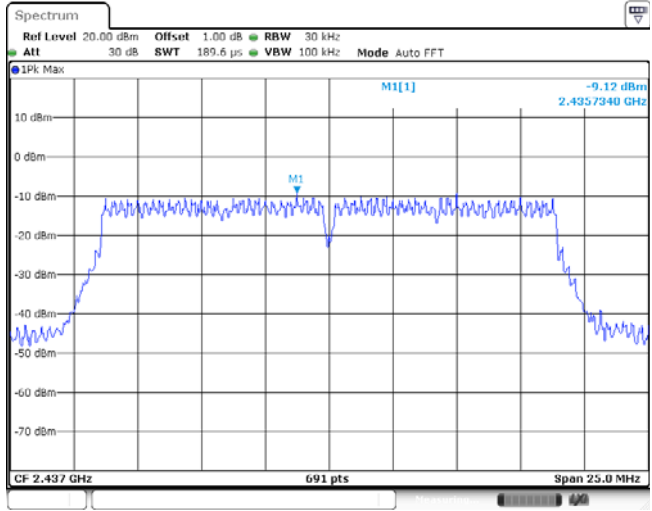
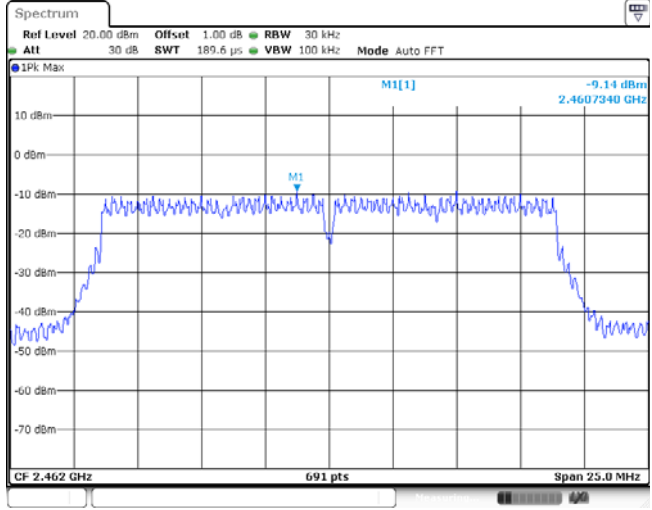
Type:		802.11n(HT20)
CH01		
CH06		
CH11		

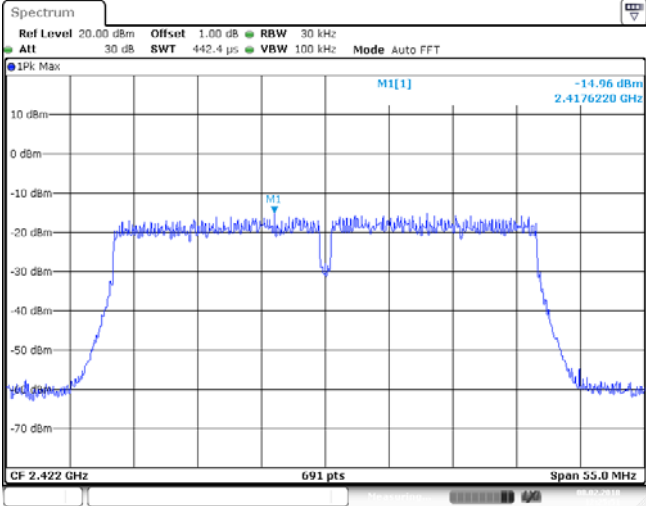
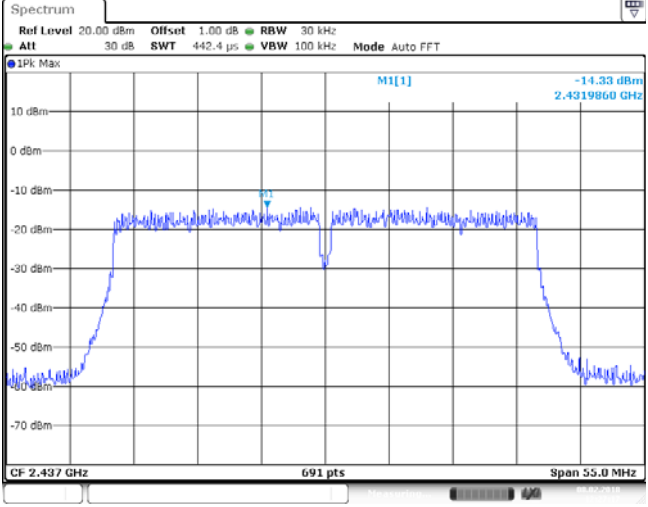
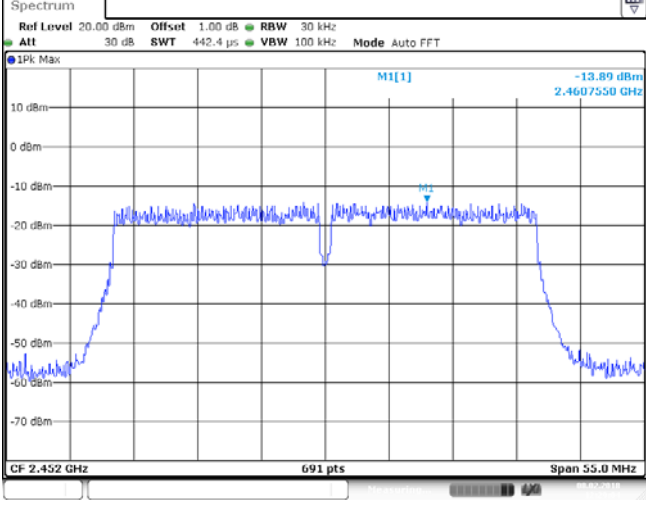
Type:		802.11n(HT40)
CH03		
CH06		
CH09		

5.5. 6dB bandwidth

LIMIT

FCC CFR Title 47 Part 15 Subpart C Section 15.247 (a)(2):

For digital modulation systems, the minimum 6 dB bandwidth shall be at least 500 kHz.

TEST CONFIGURATION

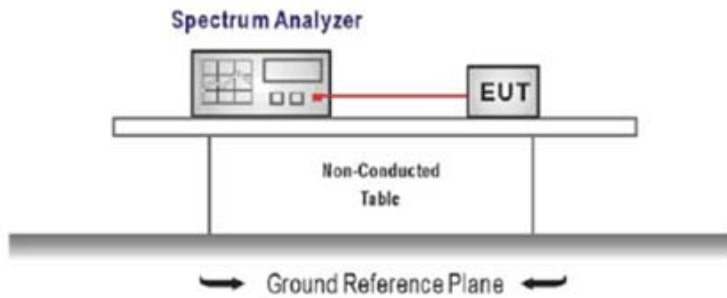

TEST PROCEDURE

1. Connect the antenna port(s) to the spectrum analyzer input.
2. Configure the spectrum analyzer as shown below (enter all losses between the transmitter output and the spectrum analyzer).
Center Frequency = DTS channel center frequency
Span = 2 x DTS bandwidth
RBW = 100 kHz, VBW \geq 3 x RBW
Sweep time = auto couple
Detector = Peak
Trace mode = max hold
3. Place the radio in continuous transmit mode, allow the trace to stabilize, view the transmitter wave form on the spectrum analyzer.
4. Measure the maximum width of the emission that is constrained by the frequencies associated with the two outermost amplitude points (upper and lower frequencies) that are attenuated by 6 dB relative to the maximum level measured in the fundamental emission, and record the pertinent measurements.

TEST MODE:

Please refer to the clause 3.3



TEST RESULTS

Passed Not Applicable

Type	Channel	6dB Bandwidth (MHz)	Limit (kHz)	Result
802.11b	01	10.11	≥500	Pass
	06	10.14		
	11	9.63		
802.11g	01	16.41	≥500	Pass
	06	16.41		
	11	16.38		
802.11n(HT20)	01	17.64	≥500	Pass
	06	17.67		
	11	17.64		
802.11n(HT40)	03	35.64	≥500	Pass
	06	35.76		
	09	35.88		

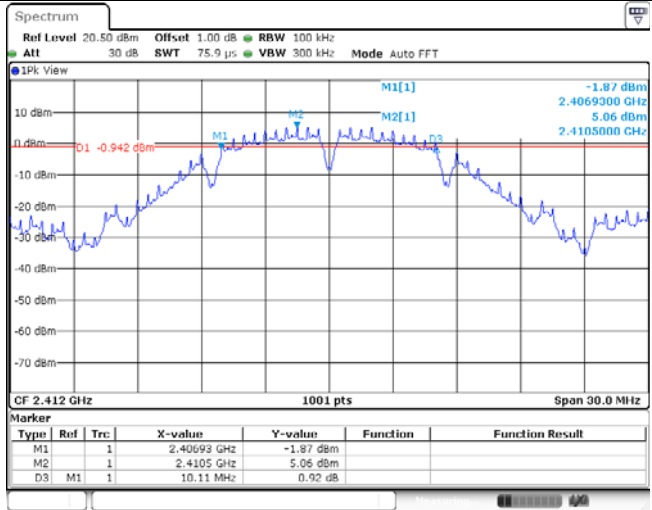
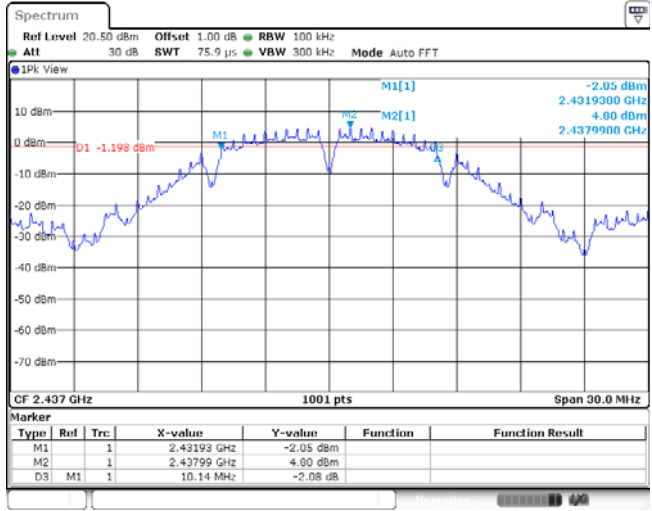
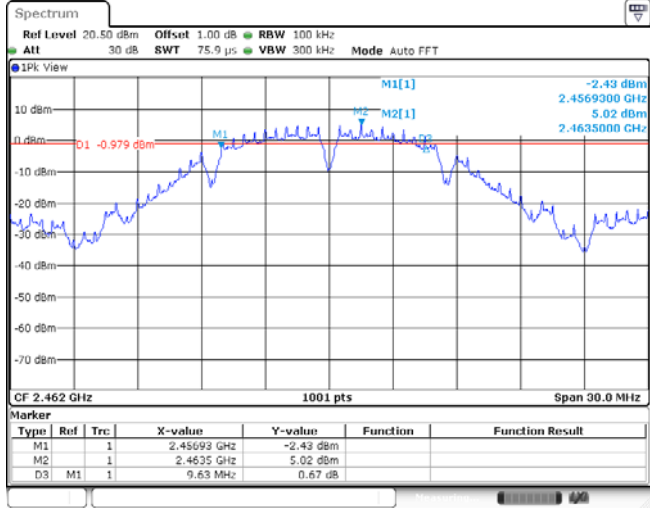
Test plot as follows:

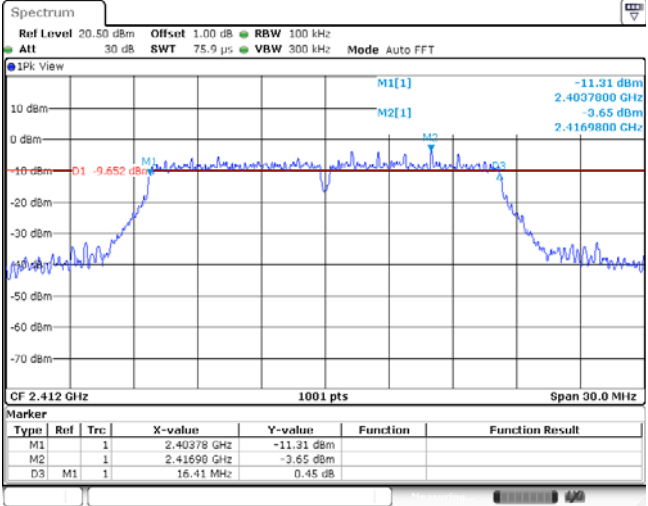
Type:		802.11 b																												
CH01	 <p>Marker</p> <table border="1"> <thead> <tr> <th>Type</th> <th>Ref</th> <th>Trc</th> <th>X-value</th> <th>Y-value</th> <th>Function</th> <th>Function Result</th> </tr> </thead> <tbody> <tr> <td>M1</td> <td></td> <td>1</td> <td>2.40693 GHz</td> <td>-1.87 dBm</td> <td></td> <td></td> </tr> <tr> <td>M2</td> <td></td> <td>1</td> <td>2.4105 GHz</td> <td>5.08 dBm</td> <td></td> <td></td> </tr> <tr> <td>D3</td> <td>M1</td> <td>1</td> <td>10.11 MHz</td> <td>0.92 dB</td> <td></td> <td></td> </tr> </tbody> </table>		Type	Ref	Trc	X-value	Y-value	Function	Function Result	M1		1	2.40693 GHz	-1.87 dBm			M2		1	2.4105 GHz	5.08 dBm			D3	M1	1	10.11 MHz	0.92 dB		
Type	Ref	Trc	X-value	Y-value	Function	Function Result																								
M1		1	2.40693 GHz	-1.87 dBm																										
M2		1	2.4105 GHz	5.08 dBm																										
D3	M1	1	10.11 MHz	0.92 dB																										
CH06	 <p>Marker</p> <table border="1"> <thead> <tr> <th>Type</th> <th>Ref</th> <th>Trc</th> <th>X-value</th> <th>Y-value</th> <th>Function</th> <th>Function Result</th> </tr> </thead> <tbody> <tr> <td>M1</td> <td></td> <td>1</td> <td>2.43193 GHz</td> <td>-2.05 dBm</td> <td></td> <td></td> </tr> <tr> <td>M2</td> <td></td> <td>1</td> <td>2.43799 GHz</td> <td>4.80 dBm</td> <td></td> <td></td> </tr> <tr> <td>D3</td> <td>M1</td> <td>1</td> <td>10.14 MHz</td> <td>-2.08 dB</td> <td></td> <td></td> </tr> </tbody> </table>		Type	Ref	Trc	X-value	Y-value	Function	Function Result	M1		1	2.43193 GHz	-2.05 dBm			M2		1	2.43799 GHz	4.80 dBm			D3	M1	1	10.14 MHz	-2.08 dB		
Type	Ref	Trc	X-value	Y-value	Function	Function Result																								
M1		1	2.43193 GHz	-2.05 dBm																										
M2		1	2.43799 GHz	4.80 dBm																										
D3	M1	1	10.14 MHz	-2.08 dB																										
CH11	 <p>Marker</p> <table border="1"> <thead> <tr> <th>Type</th> <th>Ref</th> <th>Trc</th> <th>X-value</th> <th>Y-value</th> <th>Function</th> <th>Function Result</th> </tr> </thead> <tbody> <tr> <td>M1</td> <td></td> <td>1</td> <td>2.45693 GHz</td> <td>-2.43 dBm</td> <td></td> <td></td> </tr> <tr> <td>M2</td> <td></td> <td>1</td> <td>2.4635 GHz</td> <td>5.02 dBm</td> <td></td> <td></td> </tr> <tr> <td>D3</td> <td>M1</td> <td>1</td> <td>9.63 MHz</td> <td>0.67 dB</td> <td></td> <td></td> </tr> </tbody> </table>		Type	Ref	Trc	X-value	Y-value	Function	Function Result	M1		1	2.45693 GHz	-2.43 dBm			M2		1	2.4635 GHz	5.02 dBm			D3	M1	1	9.63 MHz	0.67 dB		
Type	Ref	Trc	X-value	Y-value	Function	Function Result																								
M1		1	2.45693 GHz	-2.43 dBm																										
M2		1	2.4635 GHz	5.02 dBm																										
D3	M1	1	9.63 MHz	0.67 dB																										

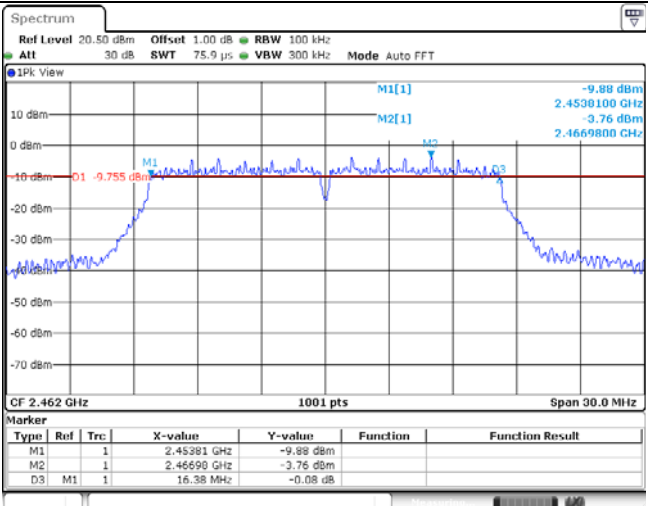
Type:	802.11 g																												
CH01	 <p>Spectrum</p> <p>Ref Level 20.50 dBm Offset 1.00 dB RBW 100 kHz Att 30 dB SWT 75.9 μs VBW 300 kHz Mode Auto FFT</p> <p>1Pk View</p> <p>M1[1] -11.31 dBm 2.4037000 GHz M2[1] -3.65 dBm 2.4169800 GHz</p> <p>-10 dBm -01 -9.652 dBm</p> <p>CF 2.412 GHz 1001 pts Span 30.0 MHz</p> <table border="1"> <thead> <tr> <th>Type</th> <th>Ref</th> <th>Trc</th> <th>X-value</th> <th>Y-value</th> <th>Function</th> <th>Function Result</th> </tr> </thead> <tbody> <tr> <td>M1</td> <td></td> <td>1</td> <td>2.40378 GHz</td> <td>-11.31 dBm</td> <td></td> <td></td> </tr> <tr> <td>M2</td> <td></td> <td>1</td> <td>2.41690 GHz</td> <td>-3.65 dBm</td> <td></td> <td></td> </tr> <tr> <td>DS</td> <td>M1</td> <td>1</td> <td>16.41 MHz</td> <td>0.45 dB</td> <td></td> <td></td> </tr> </tbody> </table>	Type	Ref	Trc	X-value	Y-value	Function	Function Result	M1		1	2.40378 GHz	-11.31 dBm			M2		1	2.41690 GHz	-3.65 dBm			DS	M1	1	16.41 MHz	0.45 dB		
Type	Ref	Trc	X-value	Y-value	Function	Function Result																							
M1		1	2.40378 GHz	-11.31 dBm																									
M2		1	2.41690 GHz	-3.65 dBm																									
DS	M1	1	16.41 MHz	0.45 dB																									
CH06	 <p>Spectrum</p> <p>Ref Level 20.50 dBm Offset 1.00 dB RBW 100 kHz Att 30 dB SWT 75.9 μs VBW 300 kHz Mode Auto FFT</p> <p>1Pk Max</p> <p>M1[1] -10.46 dBm 2.4207000 GHz M2[1] -3.71 dBm 2.4319900 GHz</p> <p>-10 dBm -01 -9.710 dBm</p> <p>CF 2.437 GHz 1001 pts Span 30.0 MHz</p> <table border="1"> <thead> <tr> <th>Type</th> <th>Ref</th> <th>Trc</th> <th>X-value</th> <th>Y-value</th> <th>Function</th> <th>Function Result</th> </tr> </thead> <tbody> <tr> <td>M1</td> <td></td> <td>1</td> <td>2.42878 GHz</td> <td>-10.46 dBm</td> <td></td> <td></td> </tr> <tr> <td>M2</td> <td></td> <td>1</td> <td>2.43199 GHz</td> <td>-3.71 dBm</td> <td></td> <td></td> </tr> <tr> <td>DS</td> <td>M1</td> <td>1</td> <td>16.41 MHz</td> <td>0.01 dB</td> <td></td> <td></td> </tr> </tbody> </table>	Type	Ref	Trc	X-value	Y-value	Function	Function Result	M1		1	2.42878 GHz	-10.46 dBm			M2		1	2.43199 GHz	-3.71 dBm			DS	M1	1	16.41 MHz	0.01 dB		
Type	Ref	Trc	X-value	Y-value	Function	Function Result																							
M1		1	2.42878 GHz	-10.46 dBm																									
M2		1	2.43199 GHz	-3.71 dBm																									
DS	M1	1	16.41 MHz	0.01 dB																									
CH11	 <p>Spectrum</p> <p>Ref Level 20.50 dBm Offset 1.00 dB RBW 100 kHz Att 30 dB SWT 75.9 μs VBW 300 kHz Mode Auto FFT</p> <p>1Pk View</p> <p>M1[1] -9.88 dBm 2.4538100 GHz M2[1] -3.76 dBm 2.4669800 GHz</p> <p>-10 dBm -01 -9.755 dBm</p> <p>CF 2.462 GHz 1001 pts Span 30.0 MHz</p> <table border="1"> <thead> <tr> <th>Type</th> <th>Ref</th> <th>Trc</th> <th>X-value</th> <th>Y-value</th> <th>Function</th> <th>Function Result</th> </tr> </thead> <tbody> <tr> <td>M1</td> <td></td> <td>1</td> <td>2.45381 GHz</td> <td>-9.88 dBm</td> <td></td> <td></td> </tr> <tr> <td>M2</td> <td></td> <td>1</td> <td>2.46690 GHz</td> <td>-3.76 dBm</td> <td></td> <td></td> </tr> <tr> <td>DS</td> <td>M1</td> <td>1</td> <td>16.38 MHz</td> <td>-0.08 dB</td> <td></td> <td></td> </tr> </tbody> </table>	Type	Ref	Trc	X-value	Y-value	Function	Function Result	M1		1	2.45381 GHz	-9.88 dBm			M2		1	2.46690 GHz	-3.76 dBm			DS	M1	1	16.38 MHz	-0.08 dB		
Type	Ref	Trc	X-value	Y-value	Function	Function Result																							
M1		1	2.45381 GHz	-9.88 dBm																									
M2		1	2.46690 GHz	-3.76 dBm																									
DS	M1	1	16.38 MHz	-0.08 dB																									

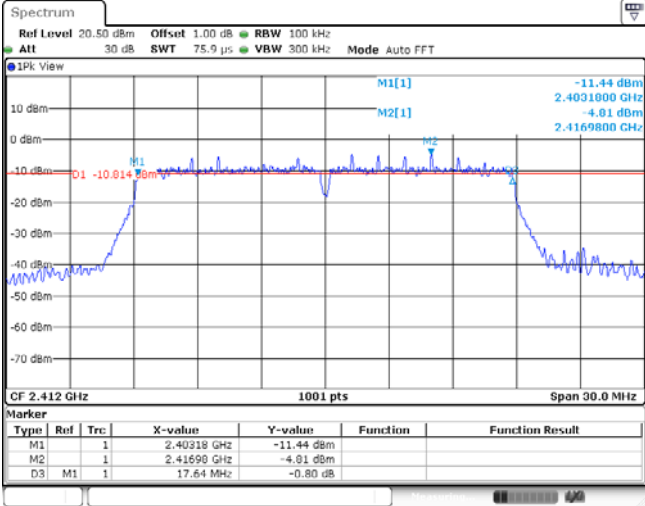
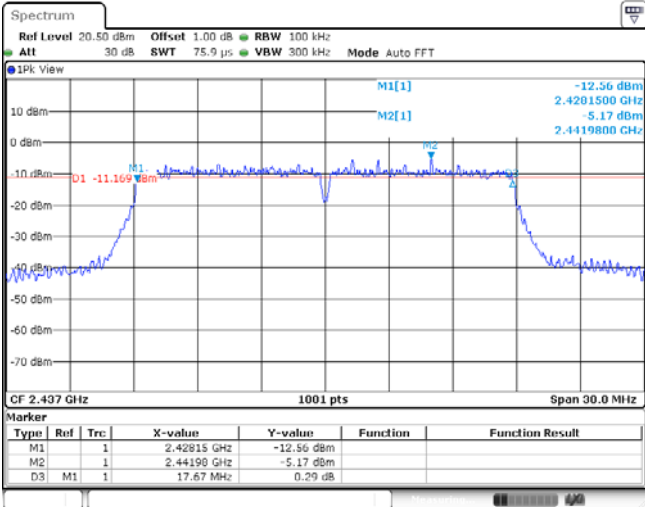
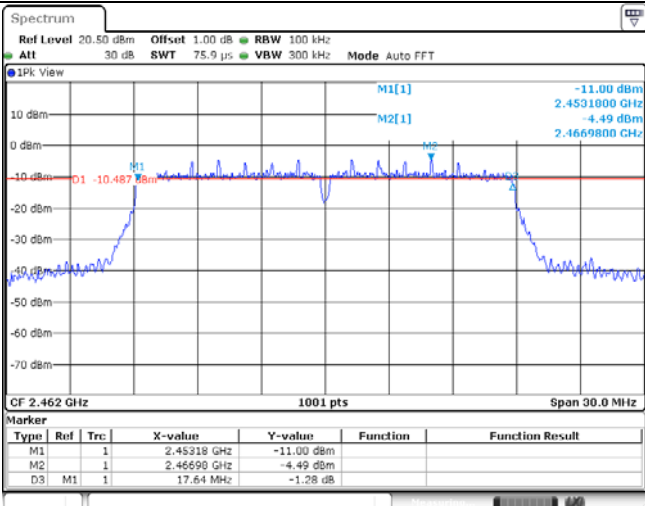
Type:	802.11n(HT20)																												
CH01	 <p>Spectrum</p> <p>Rel Level 20.50 dBm Offset 1.00 dB RBW 100 kHz Att 30 dB SWT 75.9 μs VBW 300 kHz Mode Auto FFT</p> <p>1Pk View</p> <p>M1[1] -11.44 dBm 2.4031000 GHz M2[1] -4.81 dBm 2.4169800 GHz</p> <p>D1 -10.814 dBm</p> <p>CF 2.412 GHz 1001 pts Span 30.0 MHz</p> <table border="1"> <thead> <tr> <th>Type</th> <th>Ref</th> <th>Trc</th> <th>X-value</th> <th>Y-value</th> <th>Function</th> <th>Function Result</th> </tr> </thead> <tbody> <tr> <td>M1</td> <td></td> <td>1</td> <td>2.40318 GHz</td> <td>-11.44 dBm</td> <td></td> <td></td> </tr> <tr> <td>M2</td> <td></td> <td>1</td> <td>2.41690 GHz</td> <td>-4.81 dBm</td> <td></td> <td></td> </tr> <tr> <td>DS</td> <td>M1</td> <td>1</td> <td>17.64 MHz</td> <td>-0.80 dB</td> <td></td> <td></td> </tr> </tbody> </table>	Type	Ref	Trc	X-value	Y-value	Function	Function Result	M1		1	2.40318 GHz	-11.44 dBm			M2		1	2.41690 GHz	-4.81 dBm			DS	M1	1	17.64 MHz	-0.80 dB		
Type	Ref	Trc	X-value	Y-value	Function	Function Result																							
M1		1	2.40318 GHz	-11.44 dBm																									
M2		1	2.41690 GHz	-4.81 dBm																									
DS	M1	1	17.64 MHz	-0.80 dB																									
CH06	 <p>Spectrum</p> <p>Rel Level 20.50 dBm Offset 1.00 dB RBW 100 kHz Att 30 dB SWT 75.9 μs VBW 300 kHz Mode Auto FFT</p> <p>1Pk View</p> <p>M1[1] -12.56 dBm 2.4201500 GHz M2[1] -5.17 dBm 2.4419800 GHz</p> <p>D1 -11.169 dBm</p> <p>CF 2.437 GHz 1001 pts Span 30.0 MHz</p> <table border="1"> <thead> <tr> <th>Type</th> <th>Ref</th> <th>Trc</th> <th>X-value</th> <th>Y-value</th> <th>Function</th> <th>Function Result</th> </tr> </thead> <tbody> <tr> <td>M1</td> <td></td> <td>1</td> <td>2.42015 GHz</td> <td>-12.56 dBm</td> <td></td> <td></td> </tr> <tr> <td>M2</td> <td></td> <td>1</td> <td>2.44190 GHz</td> <td>-5.17 dBm</td> <td></td> <td></td> </tr> <tr> <td>DS</td> <td>M1</td> <td>1</td> <td>17.67 MHz</td> <td>0.29 dB</td> <td></td> <td></td> </tr> </tbody> </table>	Type	Ref	Trc	X-value	Y-value	Function	Function Result	M1		1	2.42015 GHz	-12.56 dBm			M2		1	2.44190 GHz	-5.17 dBm			DS	M1	1	17.67 MHz	0.29 dB		
Type	Ref	Trc	X-value	Y-value	Function	Function Result																							
M1		1	2.42015 GHz	-12.56 dBm																									
M2		1	2.44190 GHz	-5.17 dBm																									
DS	M1	1	17.67 MHz	0.29 dB																									
CH11	 <p>Spectrum</p> <p>Rel Level 20.50 dBm Offset 1.00 dB RBW 100 kHz Att 30 dB SWT 75.9 μs VBW 300 kHz Mode Auto FFT</p> <p>1Pk View</p> <p>M1[1] -11.00 dBm 2.4531000 GHz M2[1] -4.49 dBm 2.4669800 GHz</p> <p>D1 -10.487 dBm</p> <p>CF 2.462 GHz 1001 pts Span 30.0 MHz</p> <table border="1"> <thead> <tr> <th>Type</th> <th>Ref</th> <th>Trc</th> <th>X-value</th> <th>Y-value</th> <th>Function</th> <th>Function Result</th> </tr> </thead> <tbody> <tr> <td>M1</td> <td></td> <td>1</td> <td>2.45318 GHz</td> <td>-11.00 dBm</td> <td></td> <td></td> </tr> <tr> <td>M2</td> <td></td> <td>1</td> <td>2.46690 GHz</td> <td>-4.49 dBm</td> <td></td> <td></td> </tr> <tr> <td>DS</td> <td>M1</td> <td>1</td> <td>17.64 MHz</td> <td>-1.28 dB</td> <td></td> <td></td> </tr> </tbody> </table>	Type	Ref	Trc	X-value	Y-value	Function	Function Result	M1		1	2.45318 GHz	-11.00 dBm			M2		1	2.46690 GHz	-4.49 dBm			DS	M1	1	17.64 MHz	-1.28 dB		
Type	Ref	Trc	X-value	Y-value	Function	Function Result																							
M1		1	2.45318 GHz	-11.00 dBm																									
M2		1	2.46690 GHz	-4.49 dBm																									
DS	M1	1	17.64 MHz	-1.28 dB																									

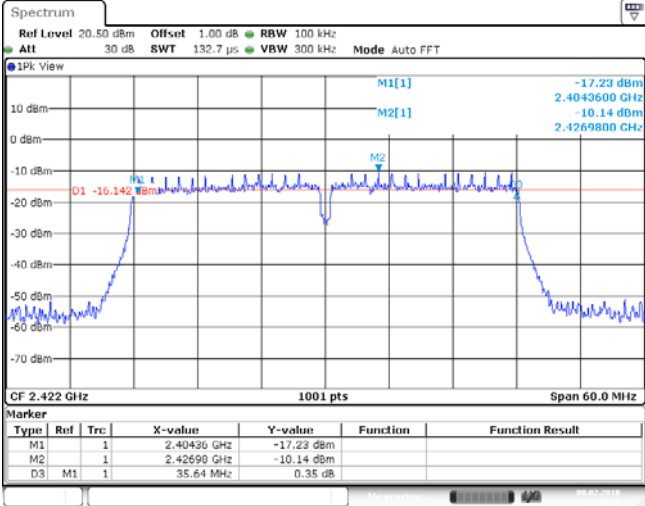
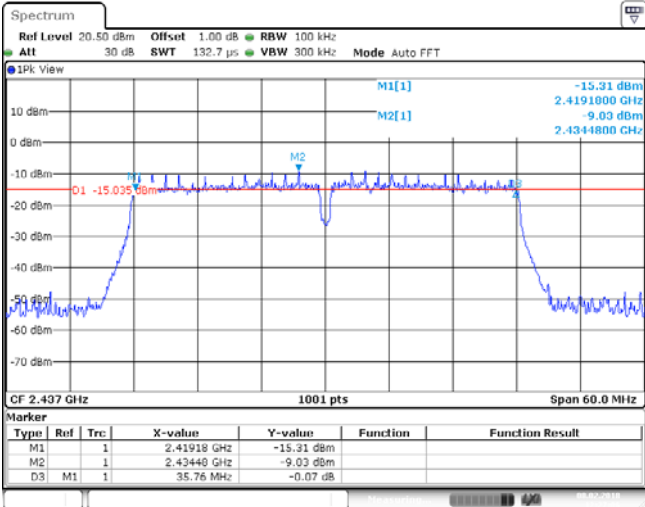
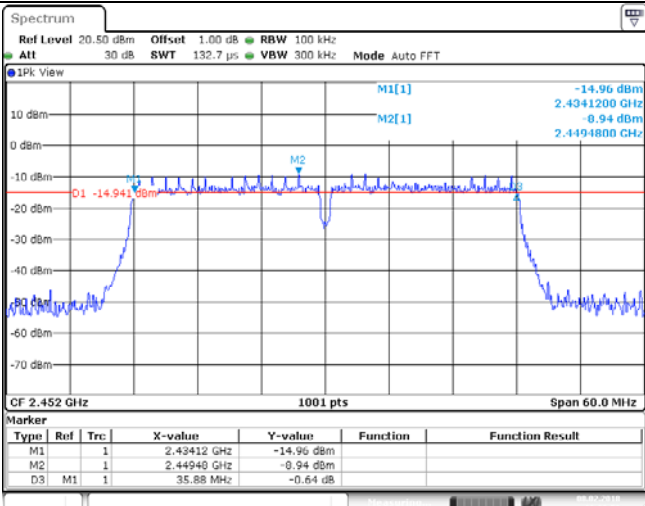
Type:	802.11n(HT40)																												
CH03	 <p>Marker</p> <table border="1"> <thead> <tr> <th>Type</th> <th>Ref</th> <th>Trc</th> <th>X-value</th> <th>Y-value</th> <th>Function</th> <th>Function Result</th> </tr> </thead> <tbody> <tr> <td>M1</td> <td></td> <td>1</td> <td>2.40436 GHz</td> <td>-17.23 dBm</td> <td></td> <td></td> </tr> <tr> <td>M2</td> <td></td> <td>1</td> <td>2.42690 GHz</td> <td>-10.14 dBm</td> <td></td> <td></td> </tr> <tr> <td>DS</td> <td>M1</td> <td>1</td> <td>35.64 MHz</td> <td>0.35 dB</td> <td></td> <td></td> </tr> </tbody> </table>	Type	Ref	Trc	X-value	Y-value	Function	Function Result	M1		1	2.40436 GHz	-17.23 dBm			M2		1	2.42690 GHz	-10.14 dBm			DS	M1	1	35.64 MHz	0.35 dB		
Type	Ref	Trc	X-value	Y-value	Function	Function Result																							
M1		1	2.40436 GHz	-17.23 dBm																									
M2		1	2.42690 GHz	-10.14 dBm																									
DS	M1	1	35.64 MHz	0.35 dB																									
CH06	 <p>Marker</p> <table border="1"> <thead> <tr> <th>Type</th> <th>Ref</th> <th>Trc</th> <th>X-value</th> <th>Y-value</th> <th>Function</th> <th>Function Result</th> </tr> </thead> <tbody> <tr> <td>M1</td> <td></td> <td>1</td> <td>2.41918 GHz</td> <td>-15.31 dBm</td> <td></td> <td></td> </tr> <tr> <td>M2</td> <td></td> <td>1</td> <td>2.43440 GHz</td> <td>-9.03 dBm</td> <td></td> <td></td> </tr> <tr> <td>DS</td> <td>M1</td> <td>1</td> <td>35.76 MHz</td> <td>-0.07 dB</td> <td></td> <td></td> </tr> </tbody> </table>	Type	Ref	Trc	X-value	Y-value	Function	Function Result	M1		1	2.41918 GHz	-15.31 dBm			M2		1	2.43440 GHz	-9.03 dBm			DS	M1	1	35.76 MHz	-0.07 dB		
Type	Ref	Trc	X-value	Y-value	Function	Function Result																							
M1		1	2.41918 GHz	-15.31 dBm																									
M2		1	2.43440 GHz	-9.03 dBm																									
DS	M1	1	35.76 MHz	-0.07 dB																									
CH09	 <p>Marker</p> <table border="1"> <thead> <tr> <th>Type</th> <th>Ref</th> <th>Trc</th> <th>X-value</th> <th>Y-value</th> <th>Function</th> <th>Function Result</th> </tr> </thead> <tbody> <tr> <td>M1</td> <td></td> <td>1</td> <td>2.43412 GHz</td> <td>-14.96 dBm</td> <td></td> <td></td> </tr> <tr> <td>M2</td> <td></td> <td>1</td> <td>2.44940 GHz</td> <td>-0.94 dBm</td> <td></td> <td></td> </tr> <tr> <td>DS</td> <td>M1</td> <td>1</td> <td>35.88 MHz</td> <td>-0.64 dB</td> <td></td> <td></td> </tr> </tbody> </table>	Type	Ref	Trc	X-value	Y-value	Function	Function Result	M1		1	2.43412 GHz	-14.96 dBm			M2		1	2.44940 GHz	-0.94 dBm			DS	M1	1	35.88 MHz	-0.64 dB		
Type	Ref	Trc	X-value	Y-value	Function	Function Result																							
M1		1	2.43412 GHz	-14.96 dBm																									
M2		1	2.44940 GHz	-0.94 dBm																									
DS	M1	1	35.88 MHz	-0.64 dB																									

5.6. Restricted band

LIMIT

FCC CFR Title 47 Part 15 Subpart C Section 15.247 (d):

In any 100 kHz bandwidth outside the frequency band in which the spread spectrum or digitally modulated intentional radiator is operating, Radiated Emissions which fall in the restricted bands, as defined in §15.205(a), must also comply with the Radiated Emissions limits specified in §15.209(a) (see §15.205(c)).

TEST CONFIGURATION

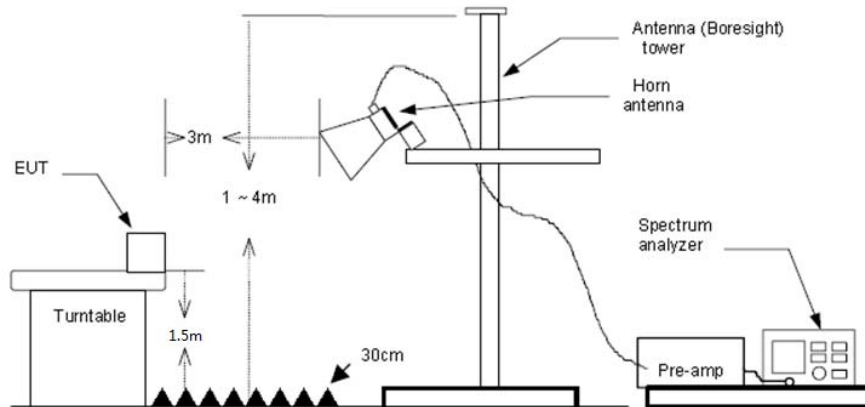

TEST PROCEDURE

- 1) The EUT was setup and tested according to ANSI C63.10:2013 for compliance to FCC 47CFR 15.247 requirements.
- 2) The EUT is placed on a turn table which is 1.5 meter above ground. The turn table is rotated 360 degrees to determine the position of the maximum emission level.
- 3) The EUT was positioned such that the distance from antenna to the EUT was 3 meters.
- 4) The antenna is scanned from 1 meter to 4 meters to find out the maximum emission level. This is repeated for both horizontal and vertical polarization of the antenna. In order to find the maximum emission, all of the interface cables were manipulated according to ANSI C63.10:2013 on radiated measurement.
- 5) The receiver set as follow:
 RBW=1MHz, VBW=3MHz PEAK detector for Peak value.
 RBW=1MHz, VBW=3MHz RMS detector for Average value.

TEST MODE:

Please refer to the clause 3.3

TEST RESULTS

Passed Not Applicable

Note:

- 1) Final level= Read level + Antenna Factor+ Cable Loss- Preamp Factor

802.11b					CH01				
Frequency (MHz)	Read Level (dBuV)	Antenna Factor (dB/m)	Cable Loss (dB)	Preamp Factor (dB)	Level (dBuV/m)	Limit Line (dBuV/m)	Over Limit (dB)	Polarization	Test value
2310.00	14.80	28.05	6.62	0.00	49.47	74.00	-24.53	Vertical	Peak
2390.01	13.40	27.65	6.75	0.00	47.80	74.00	-26.20	Vertical	Peak
2310.00	14.16	28.05	6.62	0.00	48.83	74.00	-25.17	Horizontal	Peak
2390.01	13.42	27.65	6.75	0.00	47.82	74.00	-26.18	Horizontal	Peak
2310.00	10.51	28.05	6.62	0.00	45.18	54.00	-8.82	Vertical	Average
2390.01	10.33	27.65	6.75	0.00	44.73	54.00	-9.27	Vertical	Average
2310.00	10.48	28.05	6.62	0.00	45.15	54.00	-8.85	Horizontal	Average
2390.01	10.46	27.65	6.75	0.00	44.86	54.00	-9.14	Horizontal	Average

802.11b					CH11				
Frequency (MHz)	Read Level (dBuV)	Antenna Factor (dB/m)	Cable Loss (dB)	Preamp Factor (dB)	Level (dBuV/m)	Limit Line (dBuV/m)	Over Limit (dB)	Polarization	Test value
2483.49	19.48	27.26	6.83	0.00	53.57	74.00	-20.43	Vertical	Peak
2500.00	13.89	27.20	6.84	0.00	47.93	74.00	-26.07	Vertical	Peak
2483.49	18.90	27.26	6.83	0.00	52.99	74.00	-21.01	Horizontal	Peak
2500.00	13.23	27.20	6.84	0.00	47.27	74.00	-26.73	Horizontal	Peak
2483.49	17.79	27.26	6.83	0.00	51.88	54.00	-2.12	Vertical	Average
2500.00	10.66	27.20	6.84	0.00	44.70	54.00	-9.30	Vertical	Average
2483.49	11.25	27.26	6.83	0.00	45.34	54.00	-8.66	Horizontal	Average
2500.00	10.28	27.20	6.84	0.00	44.32	54.00	-9.68	Horizontal	Average

802.11g					CH01				
Frequency (MHz)	Read Level (dBuV)	Antenna Factor (dB/m)	Cable Loss (dB)	Preamp Factor (dB)	Level (dBuV/m)	Limit Line (dBuV/m)	Over Limit (dB)	Polarization	Test value
2310.00	12.94	28.05	6.62	0.00	47.61	74.00	-26.39	Vertical	Peak
2390.01	17.27	27.65	6.75	0.00	51.67	74.00	-22.33	Vertical	Peak
2310.00	12.73	28.05	6.62	0.00	47.40	74.00	-26.60	Horizontal	Peak
2390.01	16.60	27.65	6.75	0.00	51.00	74.00	-23.00	Horizontal	Peak
2310.00	10.48	28.05	6.62	0.00	45.15	54.00	-8.85	Vertical	Average
2390.01	12.44	27.65	6.75	0.00	46.84	54.00	-7.16	Vertical	Average
2310.00	10.51	28.05	6.62	0.00	45.18	54.00	-8.82	Horizontal	Average
2390.01	12.06	27.65	6.75	0.00	46.46	54.00	-7.54	Horizontal	Average

802.11g					CH11				
Frequency (MHz)	Read Level (dBuV)	Antenna Factor (dB/m)	Cable Loss (dB)	Preamp Factor (dB)	Level (dBuV/m)	Limit Line (dBuV/m)	Over Limit (dB)	Polarization	Test value
2483.49	19.65	27.26	6.83	0.00	53.74	74.00	-20.26	Vertical	Peak
2500.00	13.78	27.20	6.84	0.00	47.82	74.00	-26.18	Vertical	Peak
2483.49	18.69	27.26	6.83	0.00	52.78	74.00	-21.22	Horizontal	Peak
2500.00	13.42	27.20	6.84	0.00	47.46	74.00	-26.54	Horizontal	Peak
2483.49	18.32	27.26	6.83	0.00	52.41	54.00	-1.59	Vertical	Average
2500.00	10.87	27.20	6.84	0.00	44.91	54.00	-9.09	Vertical	Average
2483.49	16.19	27.26	6.83	0.00	50.28	54.00	-3.72	Horizontal	Average
2500.00	10.60	27.20	6.84	0.00	44.64	54.00	-9.36	Horizontal	Average

802.11n(HT20)					CH01				
Frequency (MHz)	Read Level (dBuV)	Antenna Factor (dB/m)	Cable Loss (dB)	Preamp Factor (dB)	Level (dBuV/m)	Limit Line (dBuV/m)	Over Limit (dB)	Polarization	Test value
2310.00	13.09	28.05	6.62	0.00	47.76	74.00	-26.24	Vertical	Peak
2390.01	21.79	27.65	6.75	0.00	56.19	74.00	-17.81	Vertical	Peak
2310.00	15.39	28.05	6.62	0.00	50.06	74.00	-23.94	Horizontal	Peak
2390.01	18.15	27.65	6.75	0.00	52.55	74.00	-21.45	Horizontal	Peak
2310.00	10.46	28.05	6.62	0.00	45.13	54.00	-8.87	Vertical	Average
2390.01	15.60	27.65	6.75	0.00	50.00	54.00	-4.00	Vertical	Average
2310.00	10.45	28.05	6.62	0.00	45.12	54.00	-8.88	Horizontal	Average
2390.01	15.98	27.65	6.75	0.00	50.38	54.00	-3.62	Horizontal	Average

802.11n(HT20)					CH11				
Frequency (MHz)	Read Level (dBuV)	Antenna Factor (dB/m)	Cable Loss (dB)	Preamp Factor (dB)	Level (dBuV/m)	Limit Line (dBuV/m)	Over Limit (dB)	Polarization	Test value
2483.49	22.26	27.26	6.83	0.00	56.35	74.00	-17.65	Vertical	Peak
2500.00	12.55	27.20	6.84	0.00	46.59	74.00	-27.41	Vertical	Peak
2483.49	20.00	27.26	6.83	0.00	54.09	74.00	-19.91	Horizontal	Peak
2500.00	12.51	27.20	6.84	0.00	46.55	74.00	-27.45	Horizontal	Peak
2483.49	19.39	27.26	6.83	0.00	53.48	54.00	-0.52	Vertical	Average
2500.00	10.71	27.20	6.84	0.00	44.75	54.00	-9.25	Vertical	Average
2483.49	18.04	27.26	6.83	0.00	52.13	54.00	-1.87	Horizontal	Average
2500.00	10.47	27.20	6.84	0.00	44.51	54.00	-9.49	Horizontal	Average

802.11n(HT40)					CH03				
Frequency (MHz)	Read Level (dBuV)	Antenna Factor (dB/m)	Cable Loss (dB)	Preamp Factor (dB)	Level (dBuV/m)	Limit Line (dBuV/m)	Over Limit (dB)	Polarization	Test value
2310.00	13.01	28.05	6.62	0.00	47.68	74.00	-26.32	Vertical	Peak
2389.99	16.35	27.65	6.75	0.00	50.75	74.00	-23.25	Vertical	Peak
2310.00	12.91	28.05	6.62	0.00	47.58	74.00	-26.42	Horizontal	Peak
2389.99	22.95	27.65	6.75	0.00	57.35	74.00	-16.65	Horizontal	Peak
2310.00	11.46	28.05	6.62	0.00	46.13	54.00	-7.87	Vertical	Average
2389.99	17.59	27.65	6.75	0.00	51.99	54.00	-2.01	Vertical	Average
2310.00	11.55	28.05	6.62	0.00	46.22	54.00	-7.78	Horizontal	Average
2389.99	15.42	27.65	6.75	0.00	49.82	54.00	-4.18	Horizontal	Average

802.11n(HT40)					CH09				
Frequency (MHz)	Read Level (dBuV)	Antenna Factor (dB/m)	Cable Loss (dB)	Preamp Factor (dB)	Level (dBuV/m)	Limit Line (dBuV/m)	Over Limit (dB)	Polarization	Test value
2483.50	21.12	27.26	6.83	0.00	55.21	74.00	-18.79	Vertical	Peak
2500.00	15.62	27.20	6.84	0.00	49.66	74.00	-24.34	Vertical	Peak
2483.50	23.50	27.26	6.83	0.00	57.59	74.00	-16.41	Horizontal	Peak
2500.00	17.14	27.20	6.84	0.00	51.18	74.00	-22.82	Horizontal	Peak
2483.50	15.91	27.26	6.83	0.00	50.00	54.00	-4.00	Vertical	Average
2500.00	12.12	27.20	6.84	0.00	46.16	54.00	-7.84	Vertical	Average
2483.50	18.94	27.26	6.83	0.00	53.03	54.00	-0.97	Horizontal	Average
2500.00	13.80	27.20	6.84	0.00	47.84	54.00	-6.16	Horizontal	Average

5.7. Band edge and Spurious Emissions (conducted)

LIMIT

FCC CFR Title 47 Part 15 Subpart C Section 15.247 (d):

In any 100 kHz bandwidth outside the frequency band in which the spread spectrum intentional radiator is operating, the radio frequency power that is produced by the intentional radiator shall be at least 20 dB below that in the 100 kHz bandwidth within the band that contains the highest level of the desired power, based on either an RF conducted or a radiated measurement.

TEST CONFIGURATION

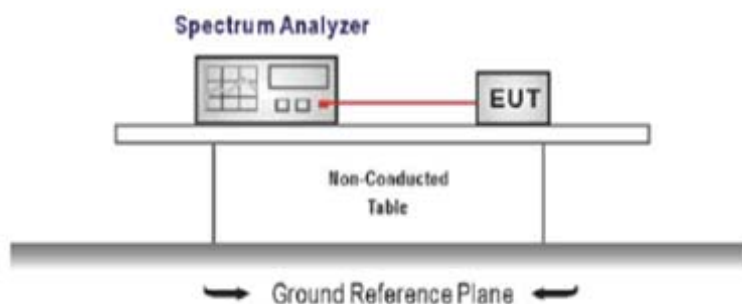

TEST PROCEDURE

1. Connect the antenna port(s) to the spectrum analyzer input.
2. Establish a reference level by using the following procedure
Center frequency=DTS channel center frequency
The span = 1.5 times the DTS bandwidth.
RBW = 100 kHz, VBW \geq 3 x RBW
Detector = peak, Sweep time = auto couple, Trace mode = max hold
Allow trace to fully stabilize
Use the peak marker function to determine the maximum PSD level

Note: the channel found to contain the maximum PSD level can be used to establish the reference level.



3. Emission level measurement
Set the center frequency and span to encompass frequency range to be measured
RBW = 100 kHz, VBW \geq 3 x RBW
Detector = peak, Sweep time = auto couple, Trace mode = max hold
Allow trace to fully stabilize
Use the peak marker function to determine the maximum amplitude level.
4. Place the radio in continuous transmit mode, allow the trace to stabilize, view the transmitter waveform on the spectrum analyzer.
5. Ensure that the amplitude of all unwanted emission outside of the authorized frequency band excluding restricted frequency bands) are attenuated by at least the minimum requirements specified (at least 20 dB relative to the maximum in-band peak PSD level in 100 kHz). Report the three highest emission relative to the limit.

TEST MODE:

Please refer to the clause 3.3

TEST RESULTS

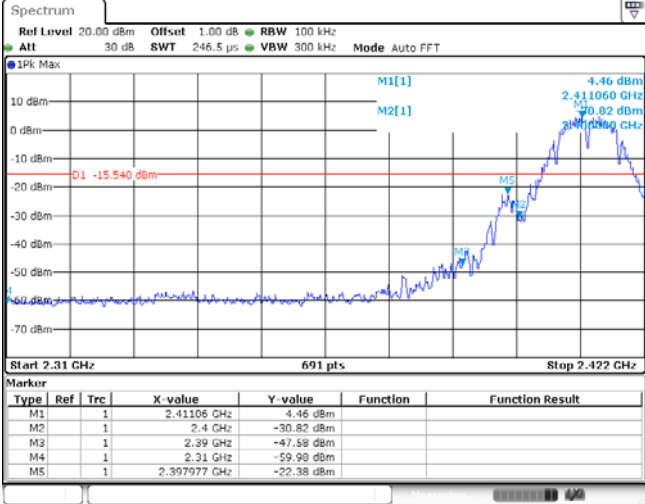
Passed Not Applicable

Test Item:	Bandedge	Type:	802.11 b																																										
CH01	 <p>Spectrum Ref Level 20.00 dBm Offset 1.00 dB RBW 100 kHz Att 30 dB SWT 246.5 μs VBW 300 kHz Mode Auto FFT</p> <p>1Pk Max</p> <p>M1[1] 4.46 dBm M2[1] 2.411060 GHz M3[1] 2.397777 GHz M4[1] 2.31 GHz M5[1] -15.540 dBm</p> <p>Start 2.31 GHz 691 pts Stop 2.422 GHz</p> <table border="1"> <thead> <tr> <th>Type</th> <th>Ref</th> <th>Trc</th> <th>X-value</th> <th>Y-value</th> <th>Function</th> <th>Function Result</th> </tr> </thead> <tbody> <tr> <td>M1</td> <td>1</td> <td></td> <td>2.41106 GHz</td> <td>4.46 dBm</td> <td></td> <td></td> </tr> <tr> <td>M2</td> <td>1</td> <td></td> <td>2.4 GHz</td> <td>-30.82 dBm</td> <td></td> <td></td> </tr> <tr> <td>M3</td> <td>1</td> <td></td> <td>2.39777 GHz</td> <td>-47.58 dBm</td> <td></td> <td></td> </tr> <tr> <td>M4</td> <td>1</td> <td></td> <td>2.31 GHz</td> <td>-59.99 dBm</td> <td></td> <td></td> </tr> <tr> <td>M5</td> <td>1</td> <td></td> <td>2.397777 GHz</td> <td>-22.38 dBm</td> <td></td> <td></td> </tr> </tbody> </table>			Type	Ref	Trc	X-value	Y-value	Function	Function Result	M1	1		2.41106 GHz	4.46 dBm			M2	1		2.4 GHz	-30.82 dBm			M3	1		2.39777 GHz	-47.58 dBm			M4	1		2.31 GHz	-59.99 dBm			M5	1		2.397777 GHz	-22.38 dBm		
Type	Ref	Trc	X-value	Y-value	Function	Function Result																																							
M1	1		2.41106 GHz	4.46 dBm																																									
M2	1		2.4 GHz	-30.82 dBm																																									
M3	1		2.39777 GHz	-47.58 dBm																																									
M4	1		2.31 GHz	-59.99 dBm																																									
M5	1		2.397777 GHz	-22.38 dBm																																									
CH11	 <p>Spectrum Ref Level 20.00 dBm Offset 1.00 dB RBW 100 kHz Att 30 dB SWT 113.8 μs VBW 300 kHz Mode Auto FFT</p> <p>1Pk Max</p> <p>M1[1] 5.01 dBm M2[1] 2.4605090 GHz M3[1] -38.71 dBm M4[1] 2.4835000 GHz</p> <p>Start 2.452 GHz 691 pts Stop 2.5 GHz</p> <table border="1"> <thead> <tr> <th>Type</th> <th>Ref</th> <th>Trc</th> <th>X-value</th> <th>Y-value</th> <th>Function</th> <th>Function Result</th> </tr> </thead> <tbody> <tr> <td>M1</td> <td>1</td> <td></td> <td>2.460509 GHz</td> <td>5.01 dBm</td> <td></td> <td></td> </tr> <tr> <td>M2</td> <td>1</td> <td></td> <td>2.46055 GHz</td> <td>-38.71 dBm</td> <td></td> <td></td> </tr> <tr> <td>M3</td> <td>1</td> <td></td> <td>2.5 GHz</td> <td>-55.47 dBm</td> <td></td> <td></td> </tr> <tr> <td>M4</td> <td>1</td> <td></td> <td>2.483513 GHz</td> <td>-38.71 dBm</td> <td></td> <td></td> </tr> </tbody> </table>			Type	Ref	Trc	X-value	Y-value	Function	Function Result	M1	1		2.460509 GHz	5.01 dBm			M2	1		2.46055 GHz	-38.71 dBm			M3	1		2.5 GHz	-55.47 dBm			M4	1		2.483513 GHz	-38.71 dBm									
Type	Ref	Trc	X-value	Y-value	Function	Function Result																																							
M1	1		2.460509 GHz	5.01 dBm																																									
M2	1		2.46055 GHz	-38.71 dBm																																									
M3	1		2.5 GHz	-55.47 dBm																																									
M4	1		2.483513 GHz	-38.71 dBm																																									

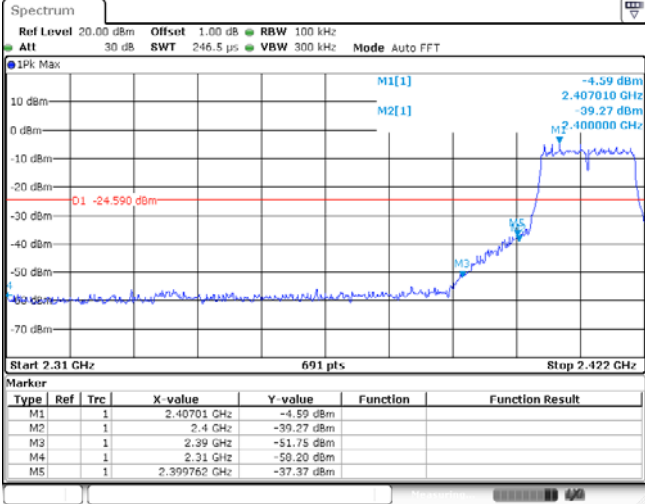
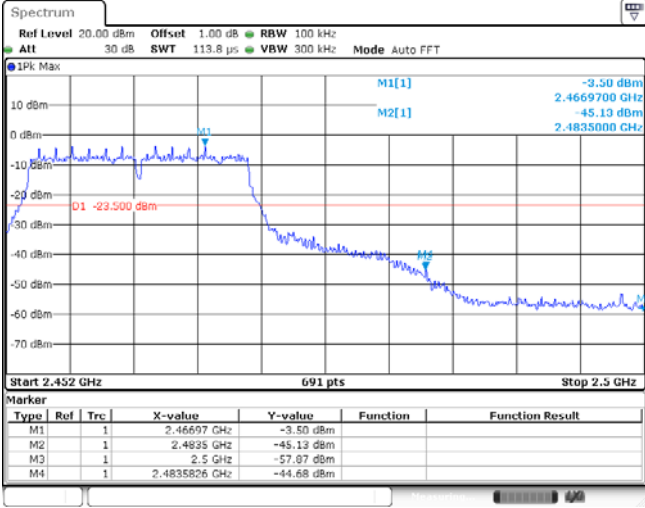
Test Item:	Bandedge	Type:	802.11 g																																										
CH01	 <p>Spectrum</p> <p>Ref Level 20.00 dBm Offset 1.00 dB RBW 100 kHz Att 30 dB SWT 246.5 μs VBW 300 kHz Mode Auto FFT</p> <p>1Pk Max</p> <p>M1[1] -4.59 dBm 2.407010 GHz M2[1] -39.27 dBm 2.407010 GHz M3 -40.000000 GHz M4 M5</p> <p>D1 -24.590 dBm</p> <p>Start 2.31 GHz 691 pts Stop 2.422 GHz</p> <table border="1"> <thead> <tr> <th>Type</th> <th>Ref</th> <th>Trc</th> <th>X-value</th> <th>Y-value</th> <th>Function</th> <th>Function Result</th> </tr> </thead> <tbody> <tr> <td>M1</td> <td>1</td> <td></td> <td>2.40701 GHz</td> <td>-4.59 dBm</td> <td></td> <td></td> </tr> <tr> <td>M2</td> <td>1</td> <td></td> <td>2.4 GHz</td> <td>-39.27 dBm</td> <td></td> <td></td> </tr> <tr> <td>M3</td> <td>1</td> <td></td> <td>2.39 GHz</td> <td>-51.75 dBm</td> <td></td> <td></td> </tr> <tr> <td>M4</td> <td>1</td> <td></td> <td>2.31 GHz</td> <td>-59.20 dBm</td> <td></td> <td></td> </tr> <tr> <td>M5</td> <td>1</td> <td></td> <td>2.399762 GHz</td> <td>-37.37 dBm</td> <td></td> <td></td> </tr> </tbody> </table>			Type	Ref	Trc	X-value	Y-value	Function	Function Result	M1	1		2.40701 GHz	-4.59 dBm			M2	1		2.4 GHz	-39.27 dBm			M3	1		2.39 GHz	-51.75 dBm			M4	1		2.31 GHz	-59.20 dBm			M5	1		2.399762 GHz	-37.37 dBm		
Type	Ref	Trc	X-value	Y-value	Function	Function Result																																							
M1	1		2.40701 GHz	-4.59 dBm																																									
M2	1		2.4 GHz	-39.27 dBm																																									
M3	1		2.39 GHz	-51.75 dBm																																									
M4	1		2.31 GHz	-59.20 dBm																																									
M5	1		2.399762 GHz	-37.37 dBm																																									
CH11	 <p>Spectrum</p> <p>Ref Level 20.00 dBm Offset 1.00 dB RBW 100 kHz Att 30 dB SWT 113.8 μs VBW 300 kHz Mode Auto FFT</p> <p>1Pk Max</p> <p>M1[1] -3.50 dBm 2.4669700 GHz M2[1] -45.13 dBm 2.4669700 GHz M3 -45.13 dBm 2.4835000 GHz M4</p> <p>D1 -23.500 dBm</p> <p>Start 2.452 GHz 691 pts Stop 2.5 GHz</p> <table border="1"> <thead> <tr> <th>Type</th> <th>Ref</th> <th>Trc</th> <th>X-value</th> <th>Y-value</th> <th>Function</th> <th>Function Result</th> </tr> </thead> <tbody> <tr> <td>M1</td> <td>1</td> <td></td> <td>2.46697 GHz</td> <td>-3.50 dBm</td> <td></td> <td></td> </tr> <tr> <td>M2</td> <td>1</td> <td></td> <td>2.46695 GHz</td> <td>-45.13 dBm</td> <td></td> <td></td> </tr> <tr> <td>M3</td> <td>1</td> <td></td> <td>2.5 GHz</td> <td>-57.07 dBm</td> <td></td> <td></td> </tr> <tr> <td>M4</td> <td>1</td> <td></td> <td>2.4835826 GHz</td> <td>-44.68 dBm</td> <td></td> <td></td> </tr> </tbody> </table>			Type	Ref	Trc	X-value	Y-value	Function	Function Result	M1	1		2.46697 GHz	-3.50 dBm			M2	1		2.46695 GHz	-45.13 dBm			M3	1		2.5 GHz	-57.07 dBm			M4	1		2.4835826 GHz	-44.68 dBm									
Type	Ref	Trc	X-value	Y-value	Function	Function Result																																							
M1	1		2.46697 GHz	-3.50 dBm																																									
M2	1		2.46695 GHz	-45.13 dBm																																									
M3	1		2.5 GHz	-57.07 dBm																																									
M4	1		2.4835826 GHz	-44.68 dBm																																									

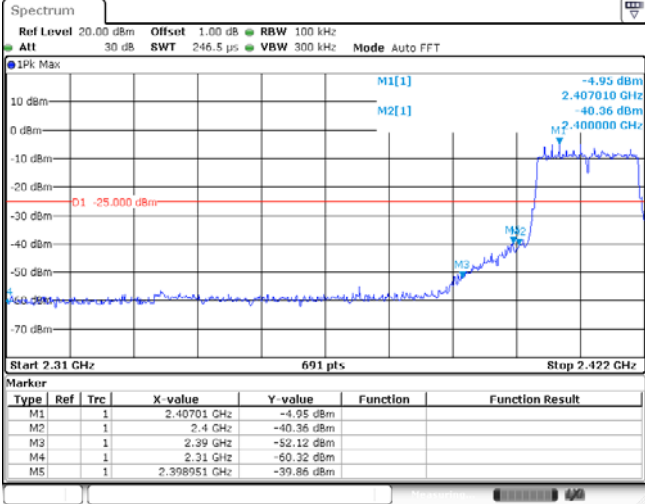
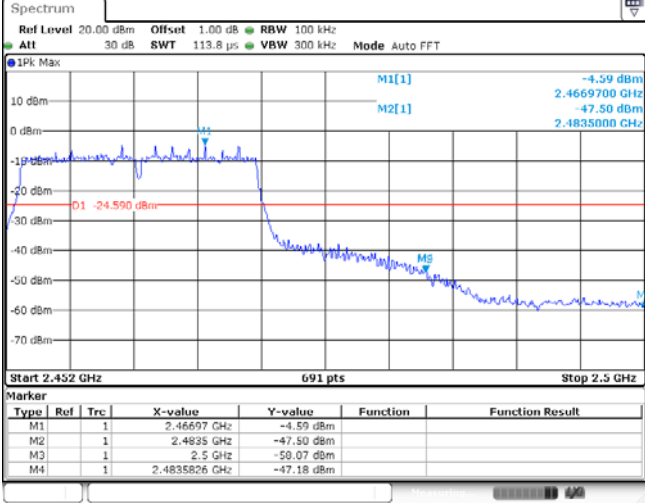
Test Item:	Bandedge	Type:	802.11 n(HT20)																																										
CH01	 <p>Spectrum Ref Level 20.00 dBm Offset 1.00 dB RBW 100 kHz Att 30 dB SWT 246.5 μs VBW 300 kHz Mode Auto FFT</p> <p>1Pk Max</p> <p>M1[1] -4.95 dBm 2.407010 GHz M2[1] -40.36 dBm 2.400000 GHz M3 -52.12 dBm 2.39 GHz M4 -50.32 dBm 2.31 GHz M5 -39.86 dBm 2.398951 GHz</p> <p>O1 -25.000 dBm</p> <p>Start 2.31 GHz 691 pts Stop 2.422 GHz</p> <table border="1"> <thead> <tr> <th>Type</th> <th>Ref</th> <th>Trc</th> <th>X-value</th> <th>Y-value</th> <th>Function</th> <th>Function Result</th> </tr> </thead> <tbody> <tr> <td>M1</td> <td>1</td> <td></td> <td>2.40701 GHz</td> <td>-4.95 dBm</td> <td></td> <td></td> </tr> <tr> <td>M2</td> <td>1</td> <td></td> <td>2.4 GHz</td> <td>-40.36 dBm</td> <td></td> <td></td> </tr> <tr> <td>M3</td> <td>1</td> <td></td> <td>2.39 GHz</td> <td>-52.12 dBm</td> <td></td> <td></td> </tr> <tr> <td>M4</td> <td>1</td> <td></td> <td>2.31 GHz</td> <td>-50.32 dBm</td> <td></td> <td></td> </tr> <tr> <td>M5</td> <td>1</td> <td></td> <td>2.398951 GHz</td> <td>-39.86 dBm</td> <td></td> <td></td> </tr> </tbody> </table>			Type	Ref	Trc	X-value	Y-value	Function	Function Result	M1	1		2.40701 GHz	-4.95 dBm			M2	1		2.4 GHz	-40.36 dBm			M3	1		2.39 GHz	-52.12 dBm			M4	1		2.31 GHz	-50.32 dBm			M5	1		2.398951 GHz	-39.86 dBm		
Type	Ref	Trc	X-value	Y-value	Function	Function Result																																							
M1	1		2.40701 GHz	-4.95 dBm																																									
M2	1		2.4 GHz	-40.36 dBm																																									
M3	1		2.39 GHz	-52.12 dBm																																									
M4	1		2.31 GHz	-50.32 dBm																																									
M5	1		2.398951 GHz	-39.86 dBm																																									
CH11	 <p>Spectrum Ref Level 20.00 dBm Offset 1.00 dB RBW 100 kHz Att 30 dB SWT 113.8 μs VBW 300 kHz Mode Auto FFT</p> <p>1Pk Max</p> <p>M1[1] -4.59 dBm 2.466970 GHz M2[1] -47.50 dBm 2.483500 GHz M3 -50.07 dBm 2.5 GHz M4 -47.18 dBm 2.4835826 GHz</p> <p>O1 -24.590 dBm</p> <p>Start 2.452 GHz 691 pts Stop 2.5 GHz</p> <table border="1"> <thead> <tr> <th>Type</th> <th>Ref</th> <th>Trc</th> <th>X-value</th> <th>Y-value</th> <th>Function</th> <th>Function Result</th> </tr> </thead> <tbody> <tr> <td>M1</td> <td>1</td> <td></td> <td>2.46697 GHz</td> <td>-4.59 dBm</td> <td></td> <td></td> </tr> <tr> <td>M2</td> <td>1</td> <td></td> <td>2.4695 GHz</td> <td>-47.50 dBm</td> <td></td> <td></td> </tr> <tr> <td>M3</td> <td>1</td> <td></td> <td>2.5 GHz</td> <td>-50.07 dBm</td> <td></td> <td></td> </tr> <tr> <td>M4</td> <td>1</td> <td></td> <td>2.4835826 GHz</td> <td>-47.18 dBm</td> <td></td> <td></td> </tr> </tbody> </table>			Type	Ref	Trc	X-value	Y-value	Function	Function Result	M1	1		2.46697 GHz	-4.59 dBm			M2	1		2.4695 GHz	-47.50 dBm			M3	1		2.5 GHz	-50.07 dBm			M4	1		2.4835826 GHz	-47.18 dBm									
Type	Ref	Trc	X-value	Y-value	Function	Function Result																																							
M1	1		2.46697 GHz	-4.59 dBm																																									
M2	1		2.4695 GHz	-47.50 dBm																																									
M3	1		2.5 GHz	-50.07 dBm																																									
M4	1		2.4835826 GHz	-47.18 dBm																																									

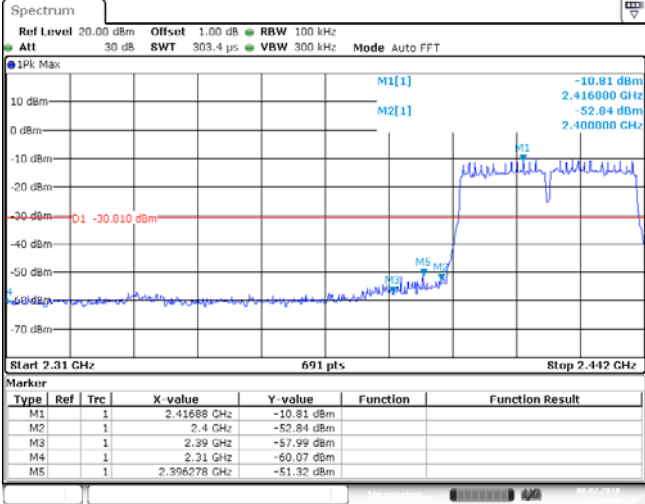
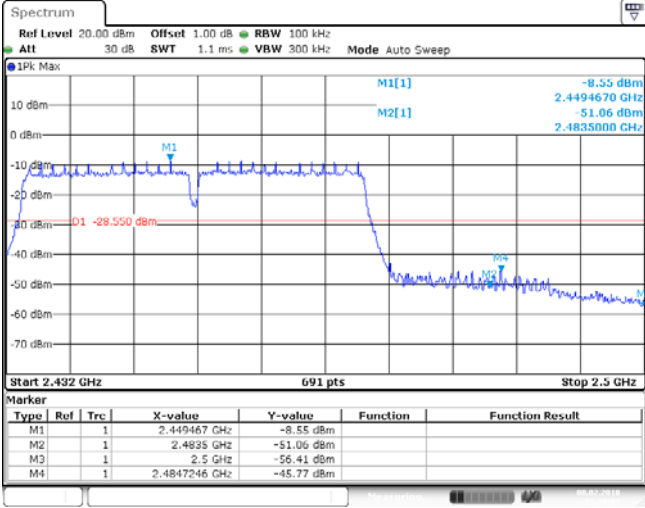
Test Item:	Bandedge	Type:	802.11n(HT40)																																										
CH03	 <table border="1" data-bbox="687 613 1334 734"> <thead> <tr> <th>Type</th> <th>Ref</th> <th>Trc</th> <th>X-value</th> <th>Y-value</th> <th>Function</th> <th>Function Result</th> </tr> </thead> <tbody> <tr> <td>M1</td> <td>1</td> <td></td> <td>2.41688 GHz</td> <td>-10.81 dBm</td> <td></td> <td></td> </tr> <tr> <td>M2</td> <td>1</td> <td></td> <td>2.4 GHz</td> <td>-52.84 dBm</td> <td></td> <td></td> </tr> <tr> <td>M3</td> <td>1</td> <td></td> <td>2.39 GHz</td> <td>-57.99 dBm</td> <td></td> <td></td> </tr> <tr> <td>M4</td> <td>1</td> <td></td> <td>2.31 GHz</td> <td>-60.07 dBm</td> <td></td> <td></td> </tr> <tr> <td>M5</td> <td>1</td> <td></td> <td>2.396278 GHz</td> <td>-51.32 dBm</td> <td></td> <td></td> </tr> </tbody> </table>			Type	Ref	Trc	X-value	Y-value	Function	Function Result	M1	1		2.41688 GHz	-10.81 dBm			M2	1		2.4 GHz	-52.84 dBm			M3	1		2.39 GHz	-57.99 dBm			M4	1		2.31 GHz	-60.07 dBm			M5	1		2.396278 GHz	-51.32 dBm		
Type	Ref	Trc	X-value	Y-value	Function	Function Result																																							
M1	1		2.41688 GHz	-10.81 dBm																																									
M2	1		2.4 GHz	-52.84 dBm																																									
M3	1		2.39 GHz	-57.99 dBm																																									
M4	1		2.31 GHz	-60.07 dBm																																									
M5	1		2.396278 GHz	-51.32 dBm																																									
CH09	 <table border="1" data-bbox="687 1153 1334 1265"> <thead> <tr> <th>Type</th> <th>Ref</th> <th>Trc</th> <th>X-value</th> <th>Y-value</th> <th>Function</th> <th>Function Result</th> </tr> </thead> <tbody> <tr> <td>M1</td> <td>1</td> <td></td> <td>2.449467 GHz</td> <td>-8.55 dBm</td> <td></td> <td></td> </tr> <tr> <td>M2</td> <td>1</td> <td></td> <td>2.4635 GHz</td> <td>-51.06 dBm</td> <td></td> <td></td> </tr> <tr> <td>M3</td> <td>1</td> <td></td> <td>2.5 GHz</td> <td>-56.41 dBm</td> <td></td> <td></td> </tr> <tr> <td>M4</td> <td>1</td> <td></td> <td>2.4847246 GHz</td> <td>-45.77 dBm</td> <td></td> <td></td> </tr> </tbody> </table>			Type	Ref	Trc	X-value	Y-value	Function	Function Result	M1	1		2.449467 GHz	-8.55 dBm			M2	1		2.4635 GHz	-51.06 dBm			M3	1		2.5 GHz	-56.41 dBm			M4	1		2.4847246 GHz	-45.77 dBm									
Type	Ref	Trc	X-value	Y-value	Function	Function Result																																							
M1	1		2.449467 GHz	-8.55 dBm																																									
M2	1		2.4635 GHz	-51.06 dBm																																									
M3	1		2.5 GHz	-56.41 dBm																																									
M4	1		2.4847246 GHz	-45.77 dBm																																									

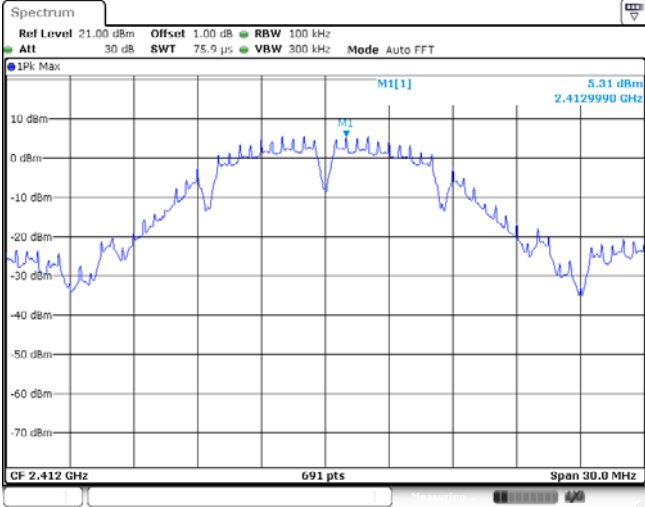
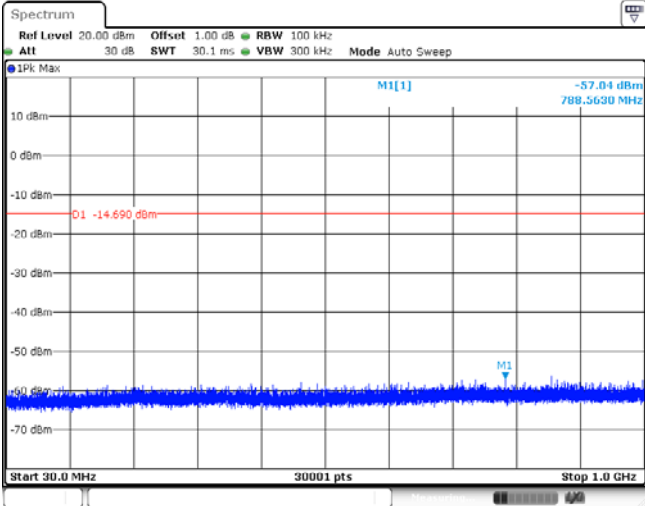
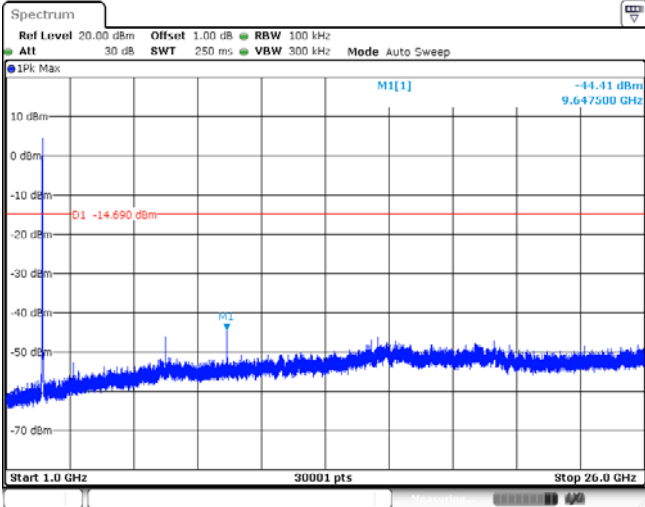
Test Item:	SE	Type:	802.11 b
<p>CH01 Reference level</p>			
<p>CH01 30MHz~1000MHz</p>			
<p>CH01 1GHz~26GHz</p>			

CH06
Reference level

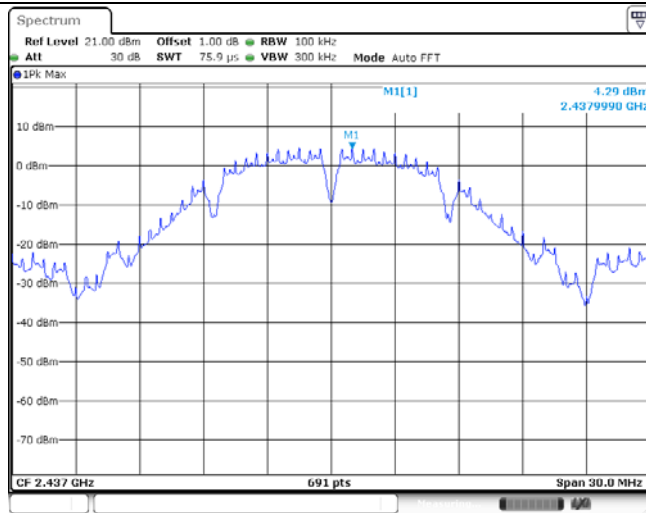

CH06
30MHz~1000MHz

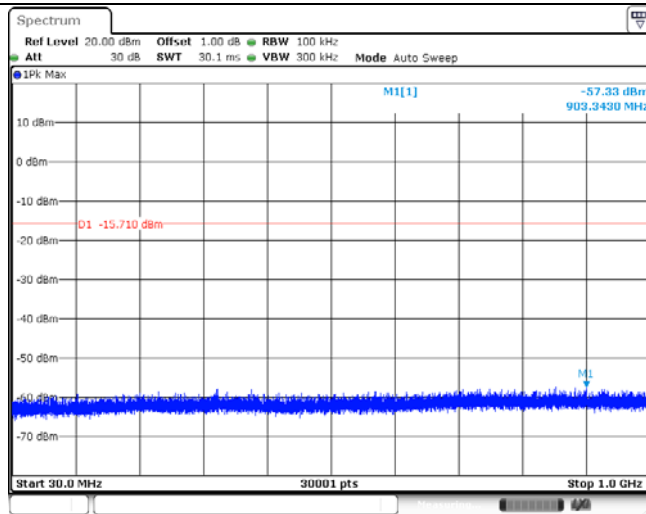

CH06
1GHz~26GHz

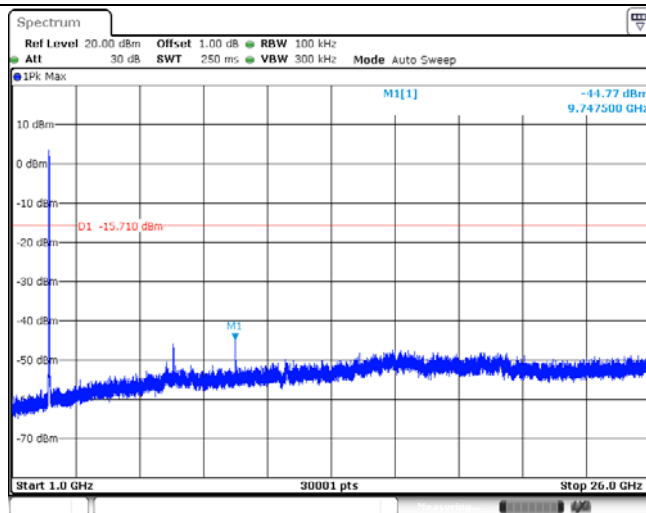

CH11
Reference level

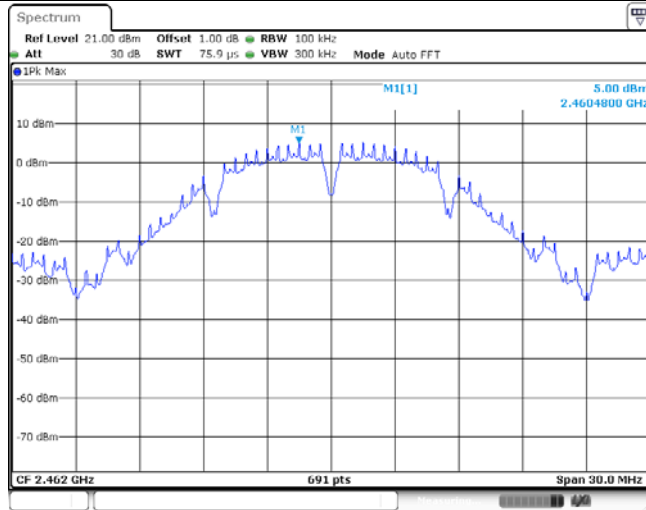

CH11
30MHz~1000MHz

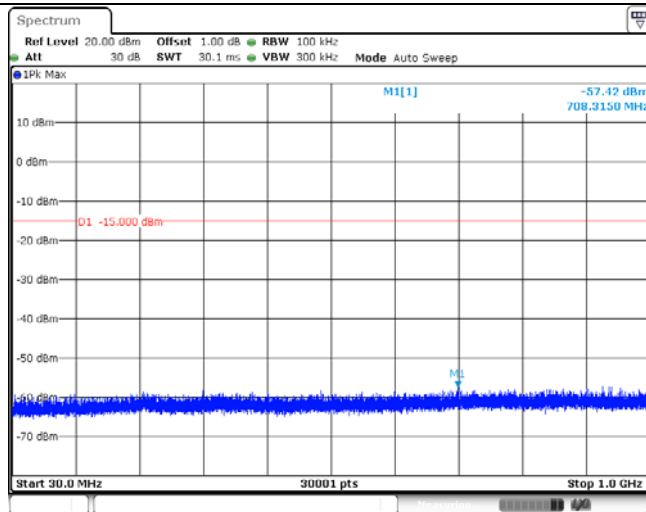

CH11
1GHz~26GHz

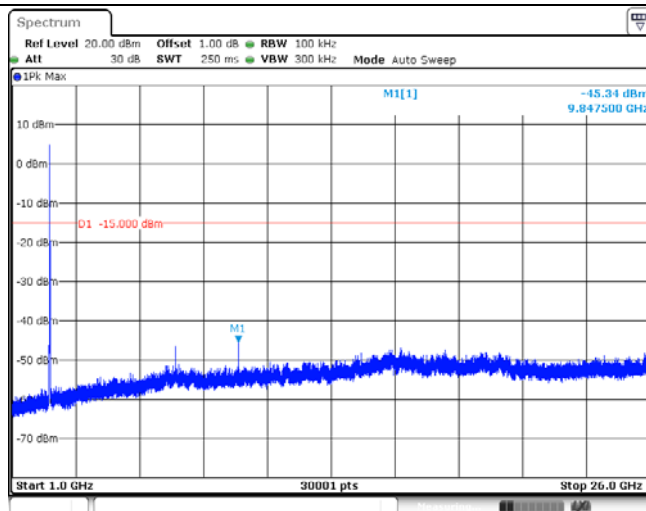

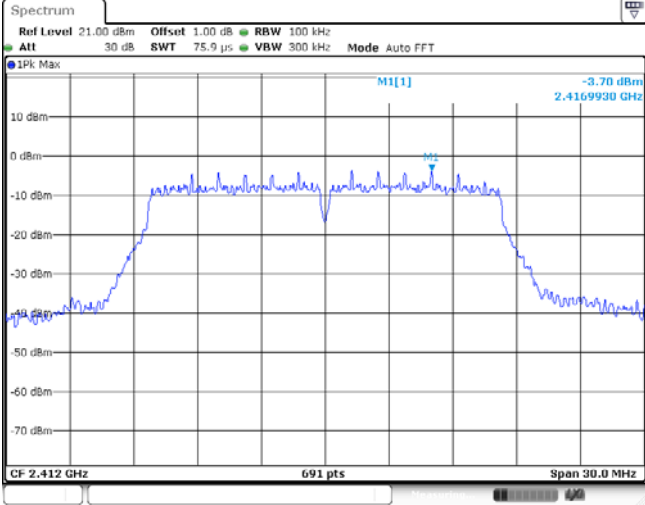
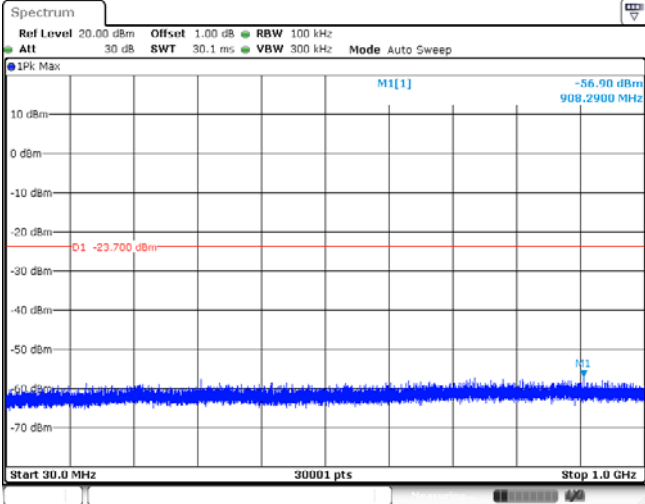
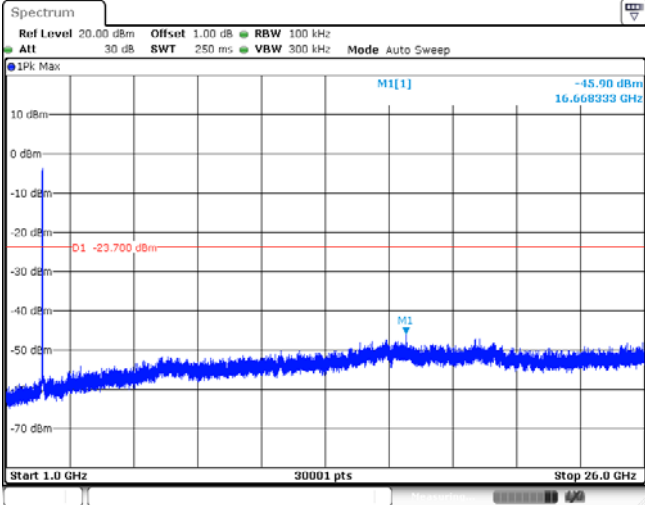
Test Item:	SE	Type:	802.11 g
<p>CH01 Reference level</p>			
<p>CH01 30MHz~1000MHz</p>			
<p>CH01 1GHz~26GHz</p>			

CH06
Reference level

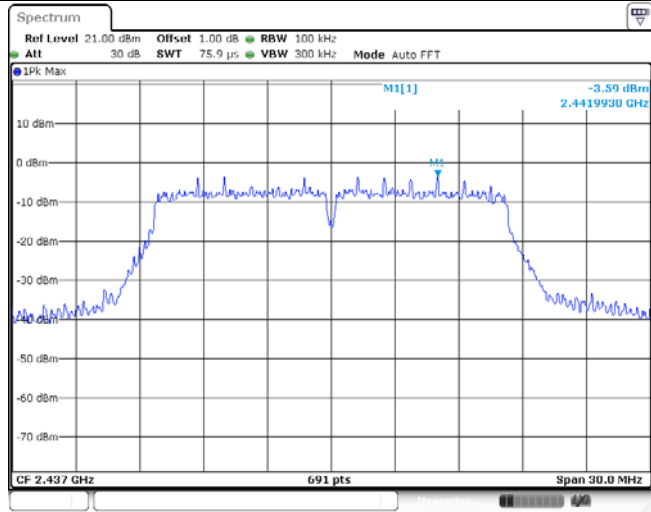

CH06
30MHz~1000MHz

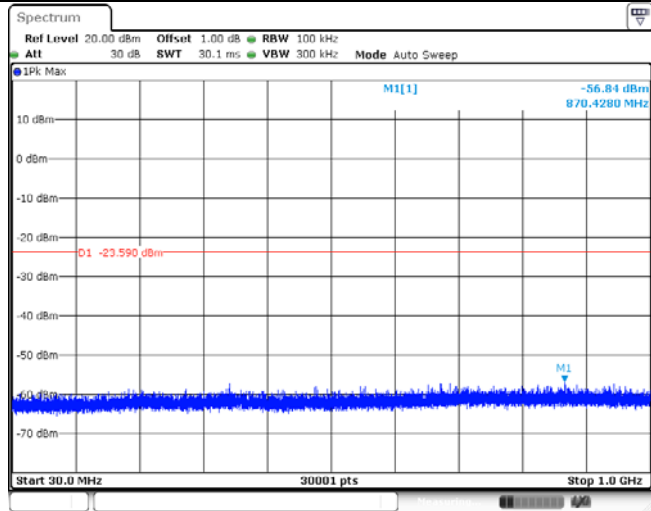

CH06
1GHz~26GHz

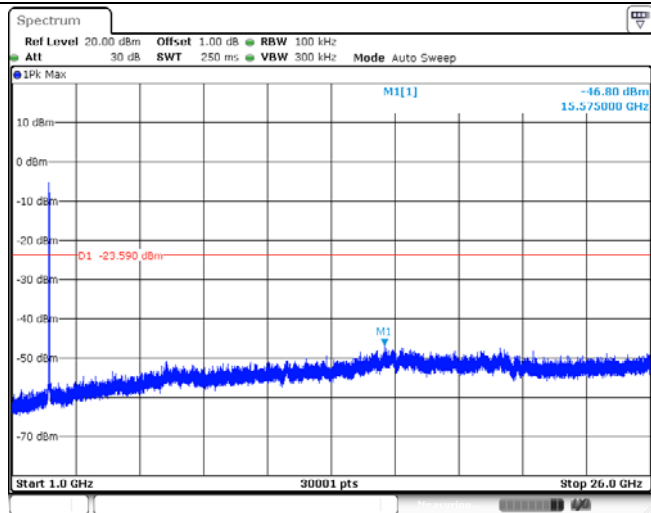

CH11
Reference level

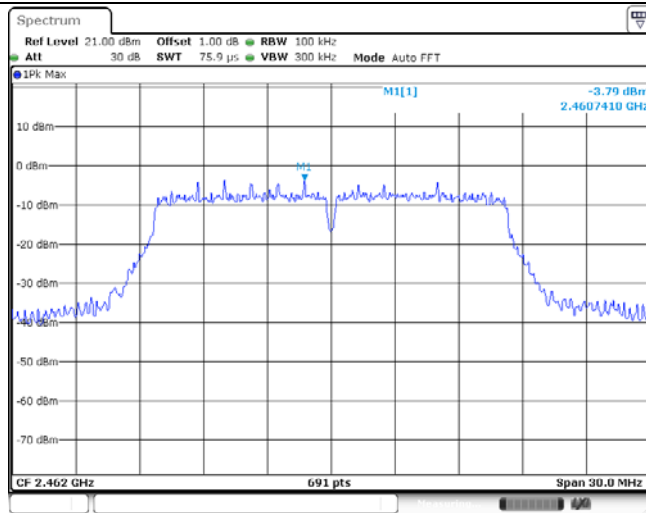

CH11
30MHz~1000MHz

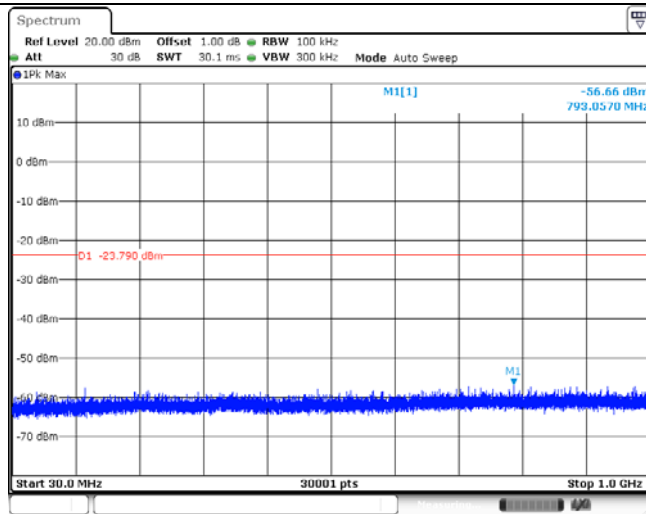

CH11
1GHz~26GHz

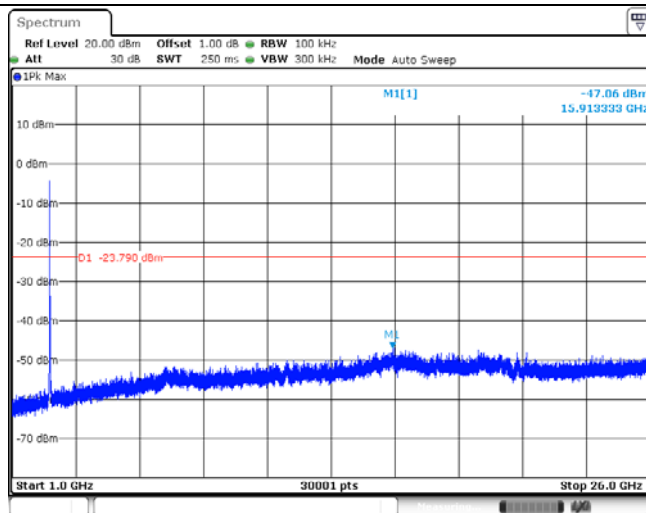

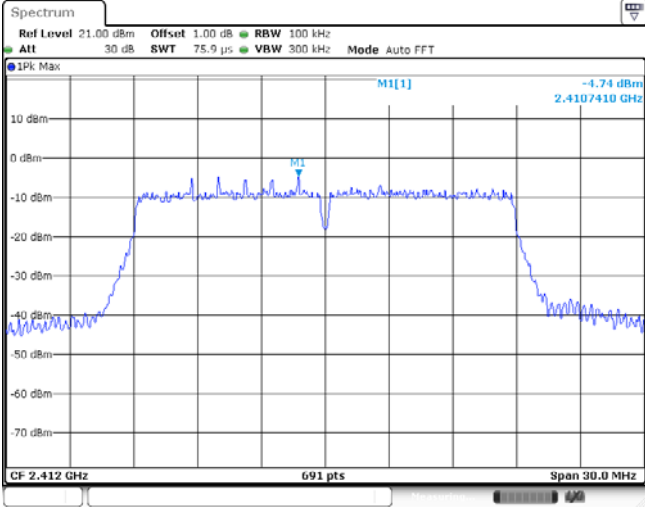
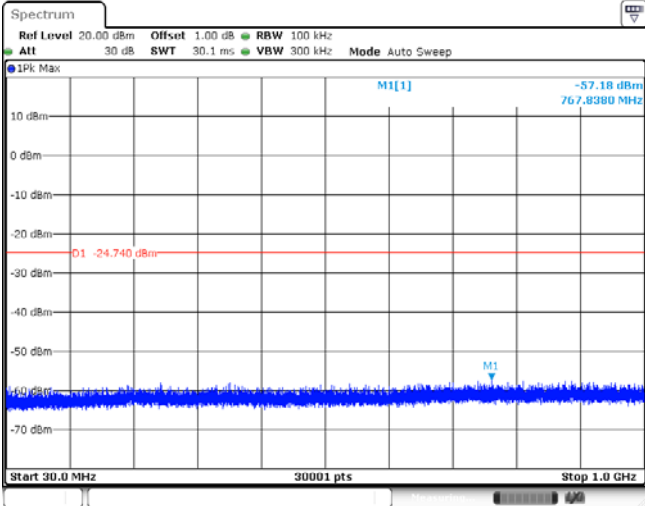
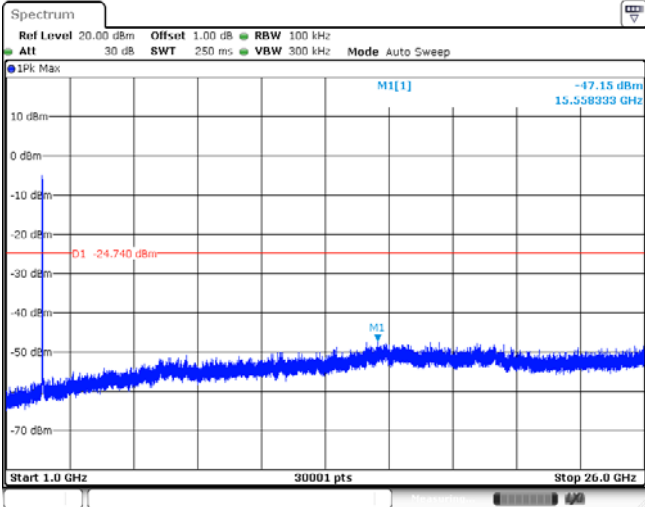
Test Item:	SE	Type:	802.11 n(HT20)
<p>CH01 Reference level</p>			
<p>CH01 30MHz~1000MHz</p>			
<p>CH01 1GHz~26GHz</p>			

CH06
Reference level

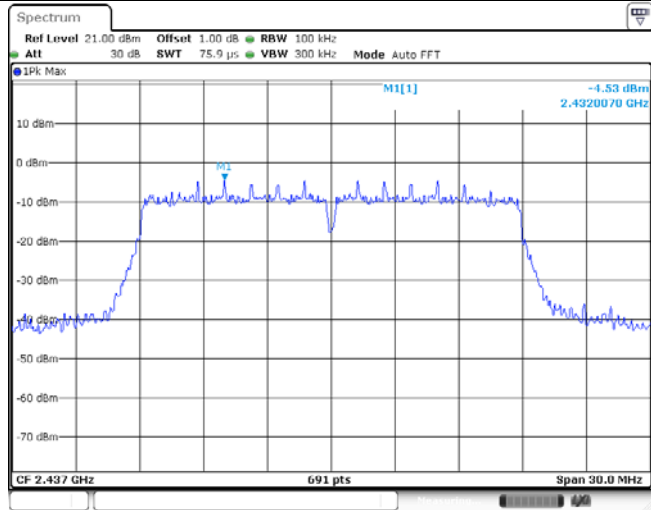

CH06
30MHz~1000MHz

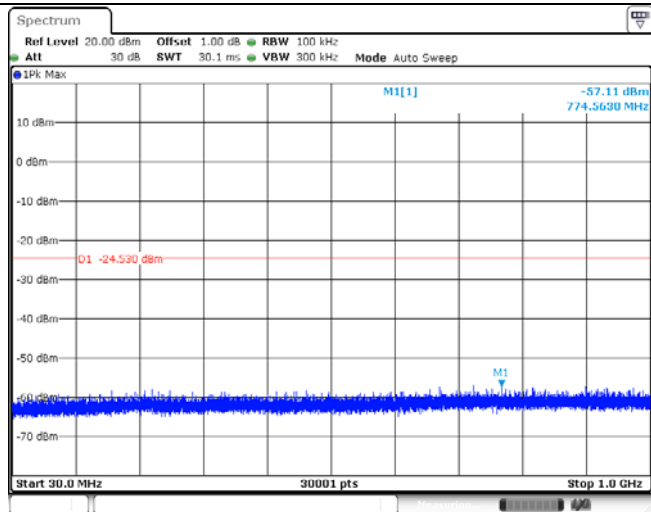

CH06
1GHz~26GHz

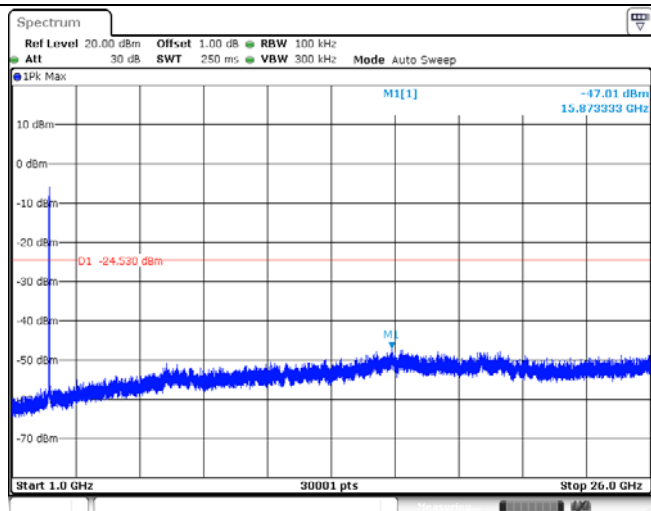

CH11
Reference level

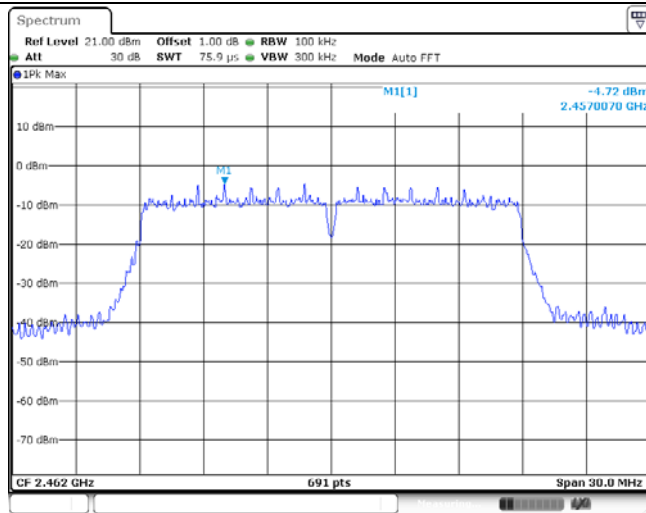

CH11
30MHz~1000MHz

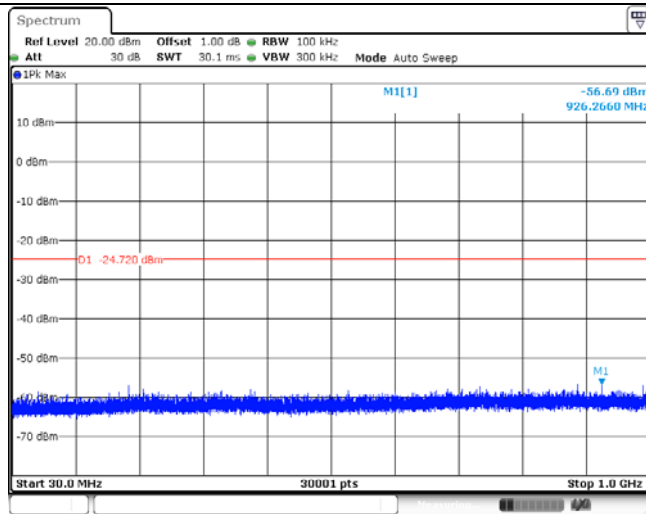

CH11
1GHz~26GHz

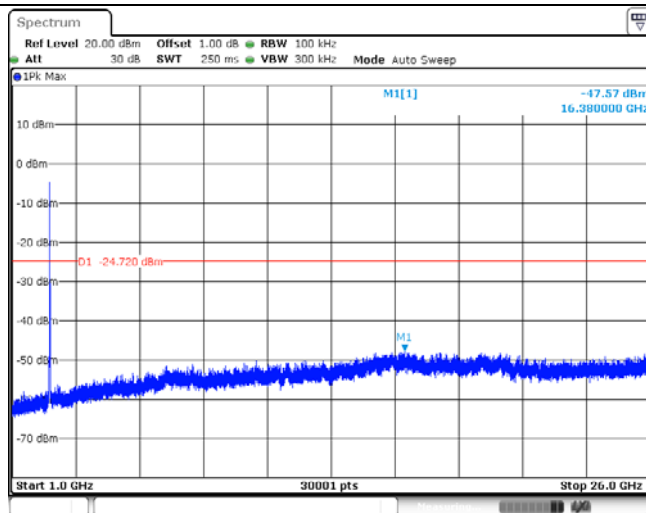

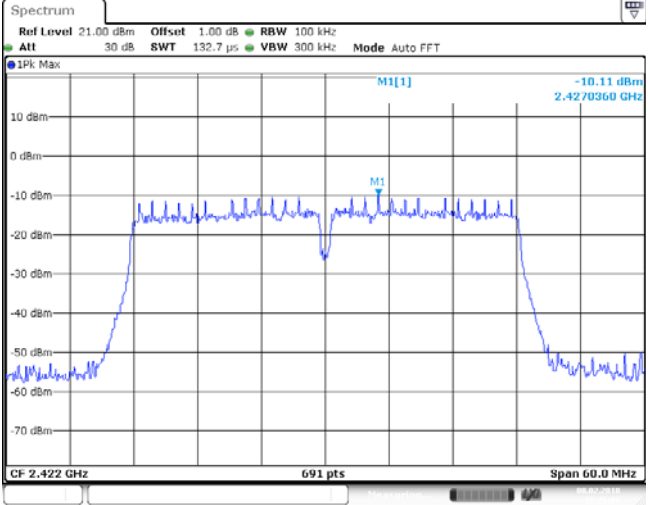
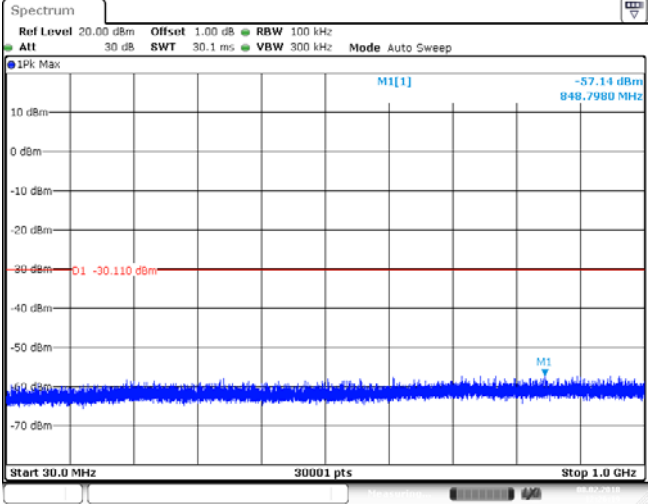
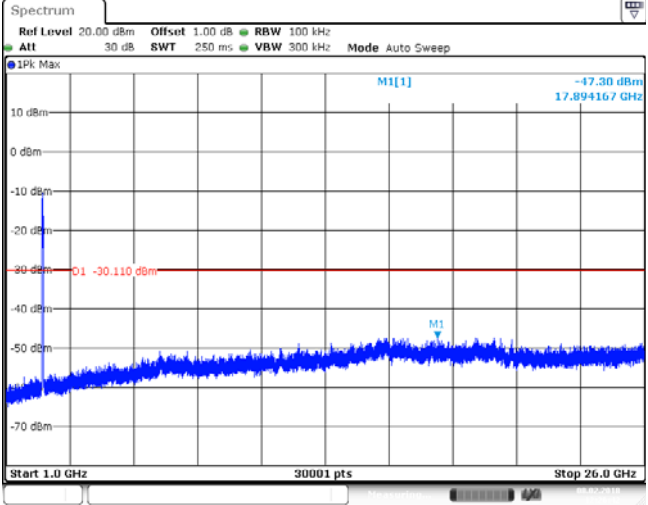
Test Item:	SE	Type:	802.11n(HT40)
CH03 Reference level			 <p>Spectrum plot showing a signal at 2.4270360 GHz with a level of -10.11 dBm. The plot includes parameters: Ref Level 21.00 dBm, Att 30 dB, Offset 1.00 dB, RBW 100 kHz, Mode Auto FFT, and Span 60.0 MHz.</p>
CH03 30MHz~1000MHz			 <p>Spectrum plot showing a noise floor at 848.7980 MHz with a level of -57.14 dBm. The plot includes parameters: Ref Level 20.00 dBm, Att 30 dB, Offset 1.00 dB, RBW 100 kHz, Mode Auto Sweep, and Start 30.0 MHz.</p>
CH03 1GHz~26GHz			 <p>Spectrum plot showing a noise floor at 17.894167 GHz with a level of -47.30 dBm. The plot includes parameters: Ref Level 20.00 dBm, Att 30 dB, Offset 1.00 dB, RBW 100 kHz, Mode Auto Sweep, and Start 1.0 GHz.</p>

CH06
Reference level

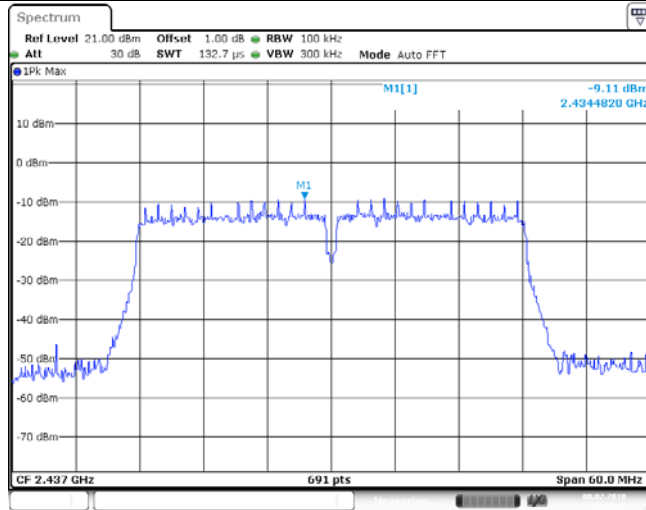

CH06
30MHz~1000MHz

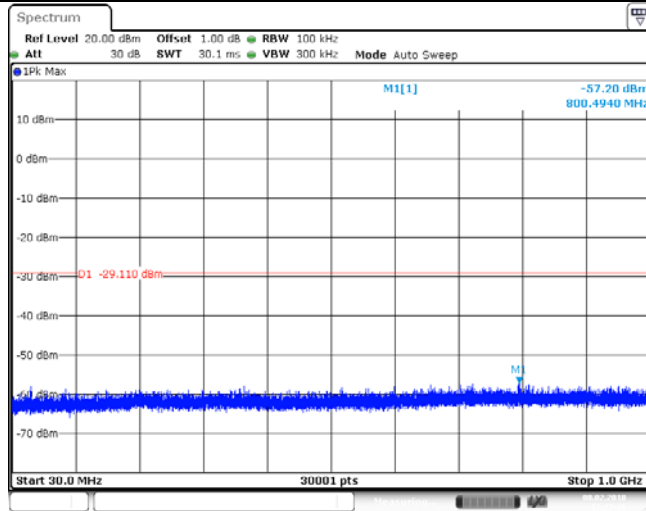

CH06
1GHz~26GHz

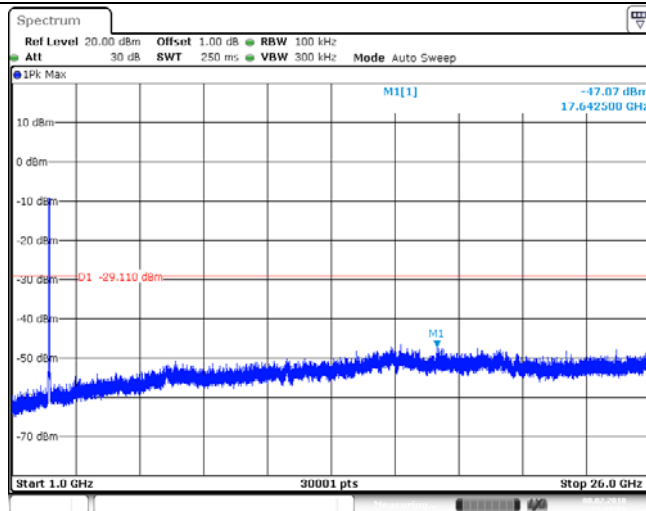

CH09
Reference level

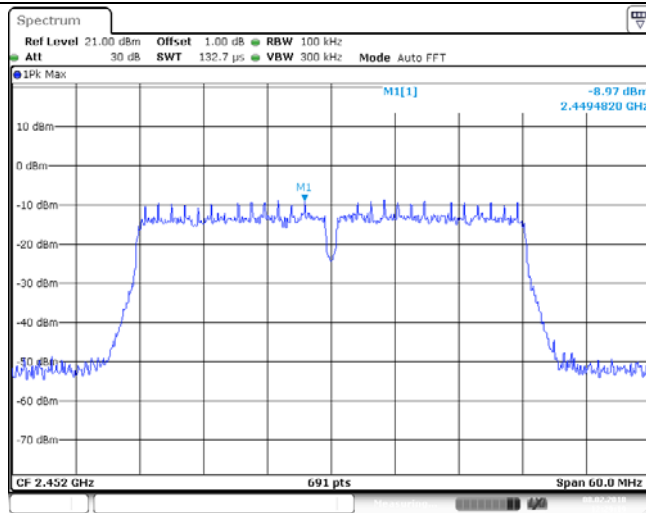

CH09
30MHz~1000MHz

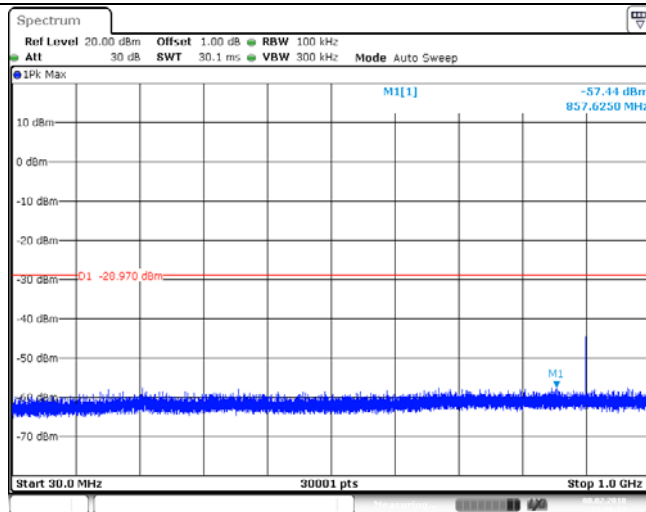

CH09
1GHz~26GHz

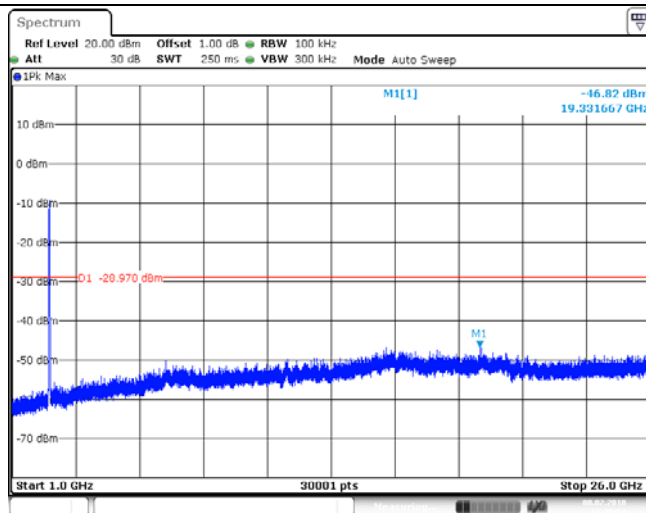

5.8. Spurious Emissions (radiated)

LIMIT

FCC CFR Title 47 Part 15 Subpart C Section 15.209

Frequency	Limit (dBuV/m @3m)	Value
30MHz-88MHz	40.00	Quasi-peak
88MHz-216MHz	43.50	Quasi-peak
216MHz-960MHz	46.00	Quasi-peak
960MHz-1GHz	54.00	Quasi-peak
Above 1GHz	54.00	Average
	74.00	Peak

TEST CONFIGURATION

➤ 9kHz ~30MHz

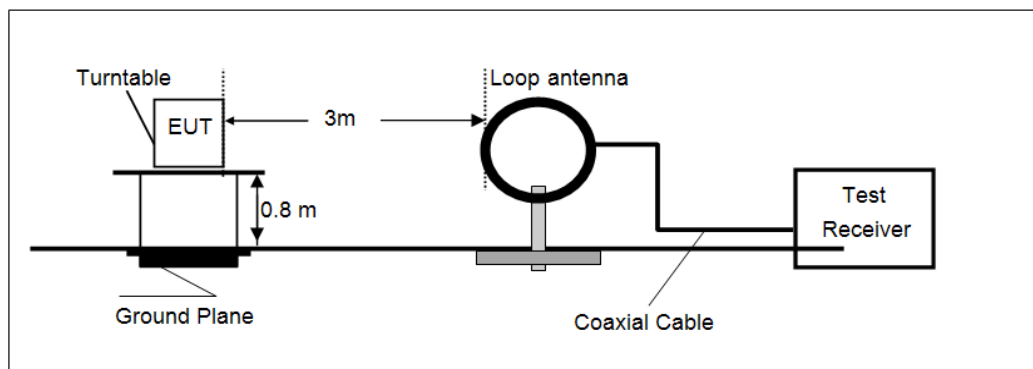

➤ 30MHz ~ 1GHz

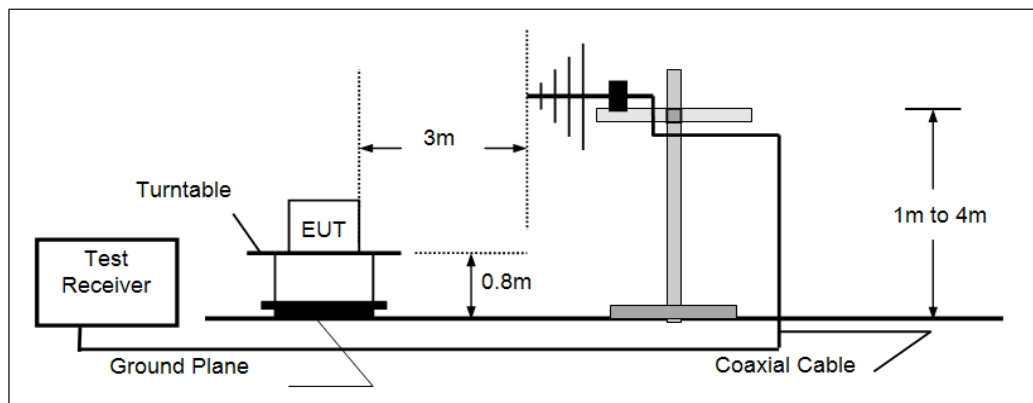

➤ Above 1GHz

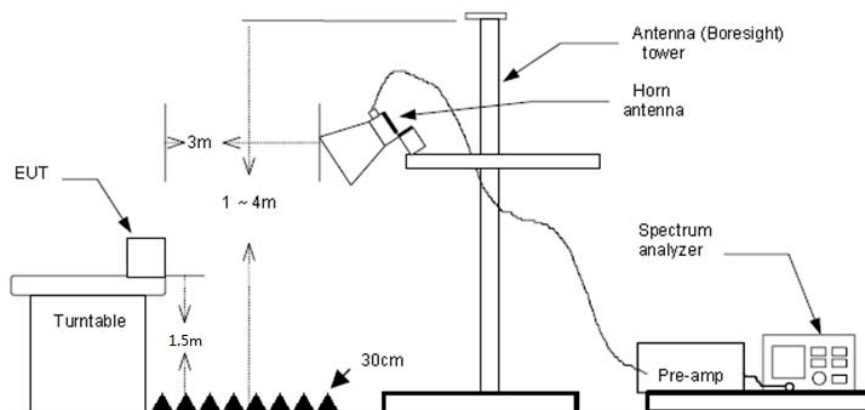

TEST PROCEDURE

1. The EUT was setup and tested according to ANSI C63.10:2013 for compliance to FCC 47CFR 15.247 requirements.
2. The EUT is placed on a turn table which is 0.8 meter above ground for below 1 GHz, and 1.5 m for above 1 GHz. The turn table is rotated 360 degrees to determine the position of the maximum emission level.
3. The EUT was set 3 meters from the receiving antenna, which was mounted on the top of a variable height antenna tower.
4. For each suspected emission, the EUT was arranged to its worst case and then tune the Antenna tower (from 1 m to 4 m) and turntable (from 0 degree to 360 degrees) to find the maximum reading. A pre-amp and a high pass filter are used for the test in order to get better signal level to comply with the guidelines.
5. Set to the maximum power setting and enable the EUT transmit continuously.
6. Use the following spectrum analyzer settings
 - (1) Span shall wide enough to fully capture the emission being measured;
 - (2) Below 1 GHz:
RBW=120 kHz, VBW=300 kHz, Sweep=auto, Detector function=peak, Trace=max hold;
If the emission level of the EUT measured by the peak detector is 3 dB lower than the applicable limit, the peak emission level will be reported. Otherwise, the emission measurement will be repeated using the quasi-peak detector and reported.
 - (3) From 1 GHz to 10th harmonic:
RBW=1MHz, VBW=3MHz Peak detector for Peak value.
RBW=1MHz, VBW=3MHz RMS detector for Average value.

TEST MODE:

Please refer to the clause 3.3

TEST RESULTS

Passed **Not Applicable**

Note:

- 1) Final Level =Receiver Read level + Antenna Factor + Cable Loss – Preamplifier Factor
- 2) The emission levels of other frequencies are very lower than the limit and not show in test report.

➤ 9kHz ~ 30MHz

The EUT was pre-scanned the frequency band (9kHz~30MHz), found the radiated level lower than the limit, so don't show on the report.

➤ 30MHz ~1000MHz

Have pre-scan all modulation mode, found the 802.11b mode CH01 which it was worst case, so only the worst case's data on the test report.

➤ 30MHz ~ 1GHz

Polarization: Vertical

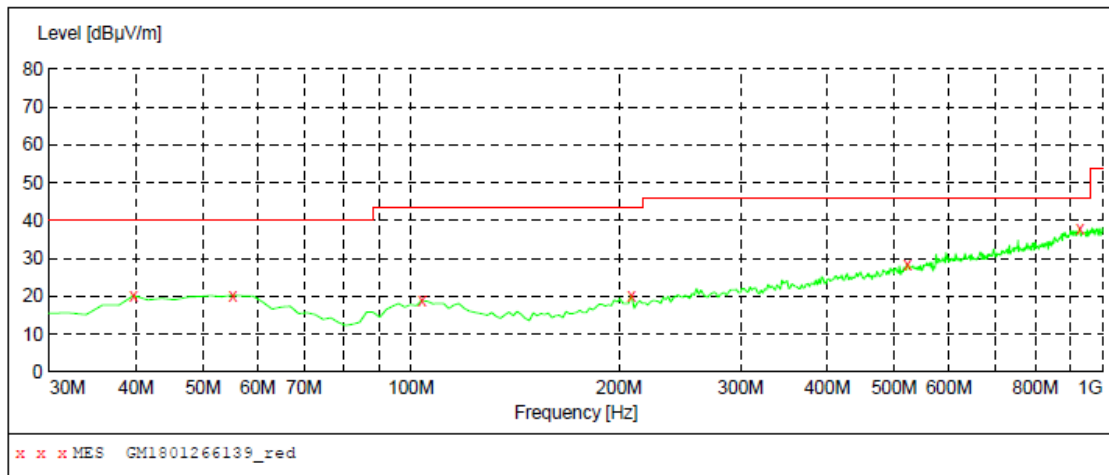

MEASUREMENT RESULT: "GM1801266139_red"

1/26/2018 8:47PM

Frequency MHz	Level dBµV/m	Transd dB	Limit dBµV/m	Margin dB	Det.	Height cm	Azimuth deg	Polarization
39.700000	20.20	-10.1	40.0	19.8	QP	100.0	191.00	VERTICAL
55.220000	20.30	-9.2	40.0	19.7	QP	100.0	174.00	VERTICAL
103.720000	18.90	-10.5	43.5	24.6	QP	100.0	354.00	VERTICAL
208.480000	20.30	-10.5	43.5	23.2	QP	100.0	215.00	VERTICAL
522.760000	28.50	-1.3	46.0	17.5	QP	100.0	326.00	VERTICAL
928.220000	37.70	7.1	46.0	8.3	QP	100.0	161.00	VERTICAL

Polarization: Horizontal

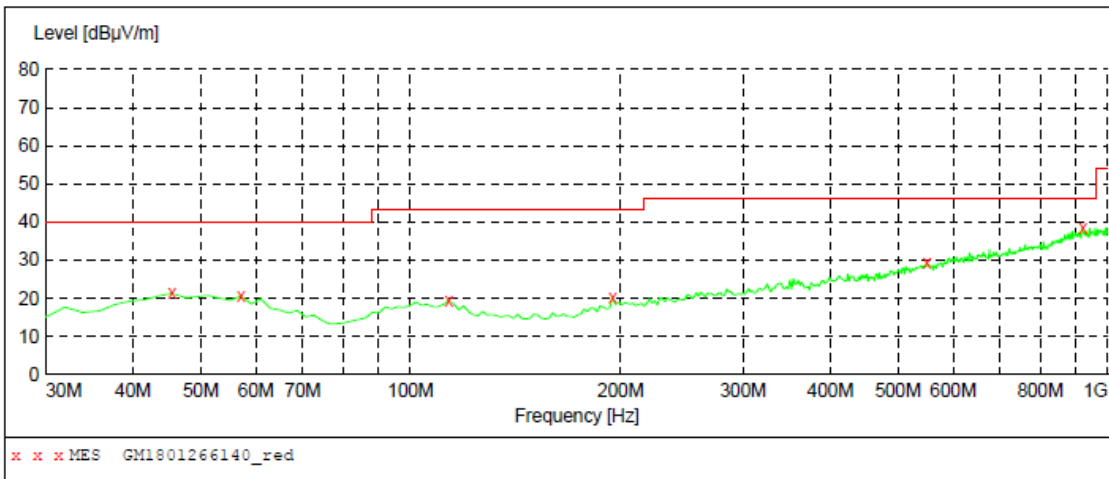

MEASUREMENT RESULT: "GM1801266140_red"

1/26/2018 8:51PM

Frequency MHz	Level dBµV/m	Transd dB	Limit dBµV/m	Margin dB	Det.	Height cm	Azimuth deg	Polarization
45.520000	21.40	-8.8	40.0	18.6	QP	300.0	42.00	HORIZONTAL
57.160000	20.70	-9.4	40.0	19.3	QP	100.0	219.00	HORIZONTAL
113.420000	19.30	-11.3	43.5	24.2	QP	300.0	42.00	HORIZONTAL
194.900000	20.10	-10.1	43.5	23.4	QP	300.0	58.00	HORIZONTAL
549.920000	29.20	-0.8	46.0	16.8	QP	300.0	323.00	HORIZONTAL
920.460000	38.50	7.0	46.0	7.5	QP	300.0	184.00	HORIZONTAL

➤ 1 GHz ~ 25 GHz

802.11b					CH01				
Frequency (MHz)	Read Level (dBuV)	Antenna Factor (dB/m)	Cable Loss (dB)	Preamp Factor (dB)	Level (dBuV/m)	Limit Line (dBuV/m)	Over Limit (dB)	Polarization	Test value
1185.96	35.29	26.19	4.63	36.58	29.53	74.00	-44.47	Vertical	Peak
3616.45	39.86	29.30	8.29	38.27	39.18	74.00	-34.82	Vertical	Peak
4821.76	33.58	31.56	9.55	36.90	37.79	74.00	-36.21	Vertical	Peak
4821.76	21.78	31.56	9.55	36.90	25.99	54.00	-28.01	Vertical	Average
7245.81	40.20	36.25	11.91	35.02	53.34	74.00	-20.66	Vertical	Peak
7245.82	31.16	36.25	11.91	35.02	44.30	54.00	-9.70	Vertical	Average
1303.09	33.75	26.19	4.84	36.51	28.27	74.00	-45.73	Horizontal	Peak
3616.45	41.94	29.30	8.29	38.27	41.26	74.00	-32.74	Horizontal	Peak
4821.76	36.01	31.56	9.55	36.90	40.22	74.00	-33.78	Horizontal	Peak
4821.76	23.73	31.56	9.55	36.90	27.94	54.00	-26.06	Horizontal	Average
7245.81	39.58	36.25	11.91	35.02	52.72	74.00	-21.28	Horizontal	Peak
7245.82	29.57	36.25	11.91	35.02	42.71	54.00	-11.29	Horizontal	Average

802.11b					CH06				
Frequency (MHz)	Read Level (dBuV)	Antenna Factor (dB/m)	Cable Loss (dB)	Preamp Factor (dB)	Level (dBuV/m)	Limit Line (dBuV/m)	Over Limit (dB)	Polarization	Test value
2577.80	36.38	27.67	6.89	37.85	33.09	74.00	-40.91	Vertical	Peak
3653.46	41.74	29.30	8.33	38.26	41.11	74.00	-32.89	Vertical	Peak
4871.10	34.19	31.46	9.59	36.76	38.48	74.00	-35.52	Vertical	Peak
4871.10	21.70	31.46	9.59	36.76	25.99	54.00	-28.01	Vertical	Average
7319.96	41.31	36.30	11.99	34.92	54.68	74.00	-19.32	Vertical	Peak
7319.97	30.50	36.30	11.99	34.92	43.87	54.00	-10.13	Vertical	Average
2584.37	32.53	27.71	6.90	37.84	29.30	74.00	-44.70	Horizontal	Peak
3653.46	43.71	29.30	8.33	38.26	43.08	74.00	-30.92	Horizontal	Peak
4871.10	23.86	31.46	9.59	36.76	28.15	54.00	-25.85	Horizontal	Average
4871.10	37.37	31.46	9.59	36.76	41.66	74.00	-32.34	Horizontal	Peak
7319.96	38.99	36.30	11.99	34.92	52.36	74.00	-21.64	Horizontal	Peak
7319.97	28.69	36.30	11.99	34.92	42.06	54.00	-11.94	Horizontal	Average

802.11b					CH11				
Frequency (MHz)	Read Level (dBuV)	Antenna Factor (dB/m)	Cable Loss (dB)	Preamp Factor (dB)	Level (dBuV/m)	Limit Line (dBuV/m)	Over Limit (dB)	Polarization	Test value
3057.17	34.69	28.72	7.55	38.22	32.74	74.00	-41.26	Vertical	Peak
3690.85	40.18	29.30	8.37	38.25	39.60	74.00	-34.40	Vertical	Peak
4920.96	35.08	31.42	9.62	36.62	39.50	74.00	-34.50	Vertical	Peak
4920.96	22.08	31.42	9.62	36.62	26.50	54.00	-27.50	Vertical	Average
7394.88	39.93	36.30	12.06	34.83	53.46	74.00	-20.54	Vertical	Peak
7394.88	29.87	36.30	12.06	34.83	43.40	54.00	-10.60	Vertical	Average
2584.37	34.47	27.71	6.90	37.84	31.24	74.00	-42.76	Horizontal	Peak
3690.85	42.86	29.30	8.37	38.25	42.28	74.00	-31.72	Horizontal	Peak
4920.96	37.12	31.42	9.62	36.62	41.54	74.00	-32.46	Horizontal	Peak
4920.96	23.27	31.42	9.62	36.62	27.69	54.00	-26.31	Horizontal	Average
7394.88	36.89	36.30	12.06	34.83	50.42	74.00	-23.58	Horizontal	Peak
7394.88	27.46	36.30	12.06	34.83	40.99	54.00	-13.01	Horizontal	Average

Remark:

1. Final Level =Receiver Read level + Antenna Factor + Cable Loss – Preamplifier Factor
2. The peak level is lower than average limit(54 dBuV/m), this data is the too weak instrument of signal is unable to test.
3. The emission levels of other frequencies(test frequency band is 1GHz to 25GHz) are very lower than the limit and not show in test report.

802.11g					CH01				
Frequency (MHz)	Read Level (dBuV)	Antenna Factor (dB/m)	Cable Loss (dB)	Preamp Factor (dB)	Level (dBuV/m)	Limit Line (dBuV/m)	Over Limit (dB)	Polarization	Test value
1185.96	35.21	26.19	4.63	36.58	29.45	74.00	-44.55	Vertical	Peak
3616.45	39.86	29.30	8.29	38.27	39.18	74.00	-34.82	Vertical	Peak
5806.41	31.19	32.11	10.59	35.32	38.57	74.00	-35.43	Vertical	Peak
7245.81	40.40	36.25	11.91	35.02	53.54	74.00	-20.46	Vertical	Peak
7245.82	27.31	36.25	11.91	35.02	40.45	54.00	-13.55	Vertical	Average
1715.41	36.77	25.23	5.80	36.96	30.84	74.00	-43.16	Horizontal	Peak
3616.45	44.32	29.30	8.29	38.27	43.64	74.00	-30.36	Horizontal	Peak
5112.49	32.80	31.85	9.76	36.29	38.12	74.00	-35.88	Horizontal	Peak
7245.81	37.30	36.25	11.91	35.02	50.44	74.00	-23.56	Horizontal	Peak
7245.82	24.17	36.25	11.91	35.02	37.31	54.00	-16.69	Horizontal	Average

802.11g					CH06				
Frequency (MHz)	Read Level (dBuV)	Antenna Factor (dB/m)	Cable Loss (dB)	Preamp Factor (dB)	Level (dBuV/m)	Limit Line (dBuV/m)	Over Limit (dB)	Polarization	Test value
1296.47	34.84	26.20	4.82	36.52	29.34	74.00	-44.66	Vertical	Peak
3653.46	42.86	29.30	8.33	38.26	42.23	74.00	-31.77	Vertical	Peak
5191.17	31.67	31.54	9.82	36.21	36.82	74.00	-37.18	Vertical	Peak
7319.96	37.84	36.30	11.99	34.92	51.21	74.00	-22.79	Vertical	Peak
7319.97	27.74	36.30	11.99	34.92	41.11	54.00	-12.89	Vertical	Average
2577.80	34.34	27.67	6.89	37.85	31.05	74.00	-42.95	Horizontal	Peak
3653.46	43.35	29.30	8.33	38.26	42.72	74.00	-31.28	Horizontal	Peak
4871.10	33.21	31.46	9.59	36.76	37.50	74.00	-36.50	Horizontal	Peak
7319.96	35.37	36.30	11.99	34.92	48.74	74.00	-25.26	Horizontal	Peak
7319.97	25.76	36.30	11.99	34.92	39.13	54.00	-14.87	Horizontal	Average

802.11g					CH11				
Frequency (MHz)	Read Level (dBuV)	Antenna Factor (dB/m)	Cable Loss (dB)	Preamp Factor (dB)	Level (dBuV/m)	Limit Line (dBuV/m)	Over Limit (dB)	Polarization	Test value
1219.64	35.86	26.28	4.69	36.56	30.27	74.00	-43.73	Vertical	Peak
3700.26	38.19	29.30	8.39	38.25	37.63	74.00	-36.37	Vertical	Peak
5865.83	30.99	32.23	10.62	35.36	38.48	74.00	-35.52	Vertical	Peak
7394.88	37.37	36.30	12.06	34.83	50.90	74.00	-23.10	Vertical	Peak
1764.12	35.58	25.33	5.89	37.06	29.74	74.00	-44.26	Horizontal	Peak
3690.85	42.06	29.30	8.37	38.25	41.48	74.00	-32.52	Horizontal	Peak
5112.49	32.17	31.85	9.76	36.29	37.49	74.00	-36.51	Horizontal	Peak
7394.88	35.52	36.30	12.06	34.83	49.05	74.00	-24.95	Horizontal	Peak

Remark:

1. Final Level = Receiver Read level + Antenna Factor + Cable Loss – Pre-amplifier Factor
2. The peak level is lower than average limit(54 dBuV/m), this data is the too weak instrument of signal is unable to test.
3. The emission levels of other frequencies(test frequency band is 1GHz to 25GHz) are very lower than the limit and not show in test report.

802.11n(HT20)					CH01				
Frequency (MHz)	Read Level (dBuV)	Antenna Factor (dB/m)	Cable Loss (dB)	Preamp Factor (dB)	Level (dBuV/m)	Limit Line (dBuV/m)	Over Limit (dB)	Polarization	Test value
1899.28	36.80	25.30	6.11	37.22	30.99	74.00	-43.01	Vertical	Peak
3616.45	41.63	29.30	8.29	38.27	40.95	74.00	-33.05	Vertical	Peak
4772.91	33.17	31.49	9.53	37.00	37.19	74.00	-36.81	Vertical	Peak
7245.81	37.52	36.25	11.91	35.02	50.66	74.00	-23.34	Vertical	Peak
1706.70	33.98	25.21	5.78	36.94	28.03	74.00	-45.97	Horizontal	Peak
3625.67	44.14	29.30	8.30	38.26	43.48	74.00	-30.52	Horizontal	Peak
5177.97	32.48	31.59	9.81	36.22	37.66	74.00	-36.34	Horizontal	Peak
7245.81	36.33	36.25	11.91	35.02	49.47	74.00	-24.53	Horizontal	Peak

802.11n(HT20)					CH06				
Frequency (MHz)	Read Level (dBuV)	Antenna Factor (dB/m)	Cable Loss (dB)	Preamp Factor (dB)	Level (dBuV/m)	Limit Line (dBuV/m)	Over Limit (dB)	Polarization	Test value
1685.12	34.41	25.16	5.74	36.90	28.41	74.00	-45.59	Vertical	Peak
2577.80	39.28	27.67	6.89	37.85	35.99	74.00	-38.01	Vertical	Peak
3653.46	40.22	29.30	8.33	38.26	39.59	74.00	-34.41	Vertical	Peak
7301.36	37.11	36.30	11.97	34.95	50.43	74.00	-23.57	Vertical	Peak
1782.18	34.11	25.37	5.93	37.10	28.31	74.00	-45.69	Horizontal	Peak
3653.46	43.52	29.30	8.33	38.26	42.89	74.00	-31.11	Horizontal	Peak
4871.10	34.57	31.46	9.59	36.76	38.86	74.00	-35.14	Horizontal	Peak
7319.96	36.21	36.30	11.99	34.92	49.58	74.00	-24.42	Horizontal	Peak

802.11n(HT20)					CH11				
Frequency (MHz)	Read Level (dBuV)	Antenna Factor (dB/m)	Cable Loss (dB)	Preamp Factor (dB)	Level (dBuV/m)	Limit Line (dBuV/m)	Over Limit (dB)	Polarization	Test value
1680.83	34.99	25.14	5.73	36.89	28.97	74.00	-45.03	Vertical	Peak
3700.26	38.38	29.30	8.39	38.25	37.82	74.00	-36.18	Vertical	Peak
5603.13	32.01	31.79	10.28	35.86	38.22	74.00	-35.78	Vertical	Peak
7376.08	37.57	36.30	12.04	34.85	51.06	74.00	-22.94	Vertical	Peak
1293.17	35.12	26.21	4.82	36.52	29.63	74.00	-44.37	Horizontal	Peak
3690.85	41.16	29.30	8.37	38.25	40.58	74.00	-33.42	Horizontal	Peak
7394.88	35.75	36.30	12.06	34.83	49.28	74.00	-24.72	Horizontal	Peak
10011.21	32.56	39.10	13.54	33.25	51.95	74.00	-22.05	Horizontal	Peak

Remark:

- Final Level = Receiver Read level + Antenna Factor + Cable Loss – Preamplifier Factor
- The peak level is lower than average limit(54 dBuV/m), this data is the too weak instrument of signal is unable to test.
- The emission levels of other frequencies(test frequency band is 1GHz to 25GHz) are very lower than the limit and not show in test report.

802.11n(HT40)					CH03				
Frequency (MHz)	Read Level (dBuV)	Antenna Factor (dB/m)	Cable Loss (dB)	Preamp Factor (dB)	Level (dBuV/m)	Limit Line (dBuV/m)	Over Limit (dB)	Polarization	Test value
1884.83	52.27	25.31	6.09	37.21	46.46	74.00	-27.54	Vertical	Peak
3672.11	35.80	29.30	8.35	38.26	35.19	74.00	-38.81	Vertical	Peak
5099.49	32.57	31.90	9.75	36.30	37.92	74.00	-36.08	Vertical	Peak
7921.00	32.31	36.78	12.68	34.74	47.03	74.00	-26.97	Vertical	Peak
1777.65	50.26	25.36	5.92	37.09	44.45	74.00	-29.55	Horizontal	Peak
3709.69	34.46	29.33	8.40	38.25	33.94	74.00	-40.06	Horizontal	Peak
5086.52	33.89	31.85	9.74	36.31	39.17	74.00	-34.83	Horizontal	Peak
7451.57	31.72	36.20	12.24	34.86	45.30	74.00	-28.70	Horizontal	Peak

802.11n(HT40)					CH06				
Frequency (MHz)	Read Level (dBuV)	Antenna Factor (dB/m)	Cable Loss (dB)	Preamp Factor (dB)	Level (dBuV/m)	Limit Line (dBuV/m)	Over Limit (dB)	Polarization	Test value
1764.12	37.86	25.33	5.89	37.06	32.02	74.00	-41.98	Vertical	Peak
3653.46	36.69	29.30	8.33	38.26	36.06	74.00	-37.94	Vertical	Peak
4582.42	33.14	30.87	9.43	37.26	36.18	74.00	-37.82	Vertical	Peak
7394.88	31.20	36.30	12.06	34.83	44.73	74.00	-29.27	Vertical	Peak
1417.28	40.29	25.88	5.05	36.48	34.74	74.00	-39.26	Horizontal	Peak
3662.78	36.73	29.30	8.34	38.26	36.11	74.00	-37.89	Horizontal	Peak
5603.13	31.17	31.79	10.28	35.86	37.38	74.00	-36.62	Horizontal	Peak
7840.75	31.25	36.35	13.06	34.96	45.70	74.00	-28.30	Horizontal	Peak

802.11n(HT40)					CH09				
Frequency (MHz)	Read Level (dBuV)	Antenna Factor (dB/m)	Cable Loss (dB)	Preamp Factor (dB)	Level (dBuV/m)	Limit Line (dBuV/m)	Over Limit (dB)	Polarization	Test value
1894.45	34.55	25.31	6.11	37.22	28.75	74.00	-45.25	Vertical	Peak
3700.26	36.00	29.30	8.39	38.25	35.44	74.00	-38.56	Vertical	Peak
4958.68	32.30	31.46	9.64	36.52	36.88	74.00	-37.12	Vertical	Peak
7027.82	30.64	35.38	11.85	34.83	43.04	74.00	-30.96	Vertical	Peak
1746.25	36.42	25.29	5.86	37.03	30.54	74.00	-43.46	Horizontal	Peak
3690.85	36.43	29.30	8.37	38.25	35.85	74.00	-38.15	Horizontal	Peak
4920.96	34.49	31.42	9.62	36.62	38.91	74.00	-35.09	Horizontal	Peak
7009.96	31.73	35.33	11.85	34.80	44.11	74.00	-29.89	Horizontal	Peak

Remark:

1. Final Level = Receiver Read level + Antenna Factor + Cable Loss – Preamplifier Factor
2. The peak level is lower than average limit(54 dBuV/m), this data is the too weak instrument of signal is unable to test.
3. The emission levels of other frequencies(test frequency band is 1GHz to 25GHz) are very lower than the limit and not show in test report.

6. TEST SETUP PHOTOS

Conducted Emissions (AC Mains)



Radiated Emissions



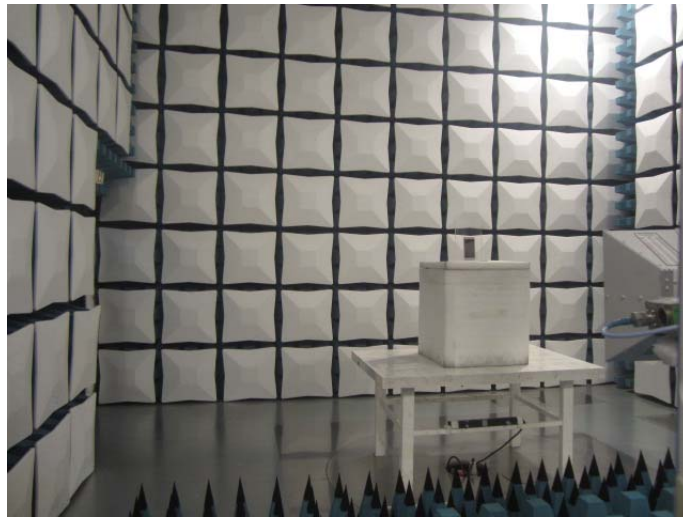

7. EXTERANAL AND INTERNAL PHOTOS

Reference to the test report No.: TRE1801017201.

.....**End of Report**.....