



# FCC REPORT

**Report Reference No.**..... : **TRE1801013302** R/C.....: 12078

**FCC ID**..... : **ZSW-30-060**

**Applicant's name**..... : **b mobile HK Limited**

Address.....: Flat 18; 14/F Block 1; Golden Industrial Building;16-26 Kwai Tak Street; Kwai Chung; New Territories; Hong Kong.

Manufacturer.....: b mobile HK Limited

Address.....: Flat 18; 14/F Block 1; Golden Industrial Building;16-26 Kwai Tak Street; Kwai Chung; New Territories; Hong Kong.

**Test item description** ..... : **Mobile Phone**

Trade Mark .....: Bmobile

Model/Type reference.....: AX750

Listed Model(s) .....: -

**Standard** ..... : **FCC Part 22: PUBLIC MOBILE SERVICES**  
**FCC Part 24: PERSONAL COMMUNICATIONS SERVICES**

Date of receipt of test sample.....: Jan.17,2018

Date of testing.....: Jan.17,2018- Feb.01,2018

Date of issue.....: Feb.02,2018

**Result**.....: **Pass**

Compiled by  
( position+printedname+signature)....: File administrators Candy Liu 

Supervised by  
(position+printedname+signature)....: Project Engineer : Edward Pan 

Approved by  
(position+printedname+signature)....: Manager Hans Hu 

**Testing Laboratory Name** ..... : **Shenzhen Huatongwei International Inspection Co., Ltd.**

Address.....: 1/F, Bldg 3, Hongfa Hi-tech Industrial Park, Genyu Road, Tianliao, Gongming, Shenzhen, China

**Shenzhen Huatongwei International Inspection Co., Ltd. All rights reserved.**

This publication may be reproduced in whole or in part for non-commercial purposes as long as the Shenzhen Huatongwei International Inspection Co., Ltd. is acknowledged as copyright owner and source of the material. Shenzhen Huatongwei International Inspection Co., Ltd. takes no responsibility for and will not assume liability for damages resulting from the reader's interpretation of the reproduced material due to its placement and context.

## Contents

<b>1.</b>	<b><u>TEST STANDARDS AND REPORT VERSION</u></b>	<b>3</b>
1.1.	Applicable Standards	3
1.2.	Report version	3
<b>2.</b>	<b><u>TEST DESCRIPTION</u></b>	<b>4</b>
<b>3.</b>	<b><u>SUMMARY</u></b>	<b>5</b>
3.1.	Client Information	5
3.2.	Product Description	5
3.3.	Operation state	6
3.4.	EUT configuration	6
3.5.	Modifications	6
<b>4.</b>	<b><u>TEST ENVIRONMENT</u></b>	<b>7</b>
4.1.	Address of the test laboratory	7
4.2.	Test Facility	7
4.3.	Equipments Used during the Test	8
	<b><u>RF CONDUCTED</u></b>	<b>8</b>
4.4.	Environmental conditions	9
4.5.	Statement of the measurement uncertainty	9
<b>5.</b>	<b><u>TEST CONDITIONS AND RESULTS</u></b>	<b>10</b>
5.1.	Conducted Output Power	10
5.2.	99% & -26 dB Occupied Bandwidth	11
5.3.	Conducted Spurious Emissions	12
5.4.	Band Edge	13
5.5.	ERP and EIRP	14
5.6.	Radiated Spurious Emission	17
5.7.	Frequency stability V.S. Temperature measurement	21
5.8.	Frequency stability V.S. Voltage measurement	22
5.9.	Peak-Average Ratio	23
<b>6.</b>	<b><u>TEST SETUP PHOTOS OF THE EUT</u></b>	<b>24</b>
<b>7.</b>	<b><u>EXTERNAL AND INTERNAL PHOTOS OF THE EUT</u></b>	<b>24</b>

# 1. Test standards and Report version

## 1.1. Applicable Standards

The tests were performed according to following standards:

[FCC Part 22](#):PRIVATE LAND MOBILE RADIO SERVICES.

[FCC Part 24](#):PUBLIC MOBILE SERVICES

Performance Standards.

[FCC Part 2](#):FREQUENCY ALLOCA-TIONS AND RADIO TREATY MAT-TERS; GENERAL RULES AND REG-ULATIONS

[ANSI C63.26-2015](#): American National Standard for Compliance Testing of Transmitters Used in Licensed Radio Services

[KDB 971168 D01 Power Meas License Digital Systems v03](#): MEASUREMENT GUIDANCE FOR CERTIFICATION OF LICENSED DIGITAL TRANSMITTERS

## 1.2. Report version

Version No.	Date of issue	Description
00	Feb.02,2018	Original

## 2. Test Description

Test Item	Section in CFR 47	Result	Test Engineer
RF Output Power	Part 2.1046 Part 22.913(a) Part 24.232(c)	Pass	William Wang
99% & -26 dB Occupied Bandwidth	Part 2.1049 Part 22.917(b) Part 24.238(b)	Pass	William Wang
Conducted Spurious Emissions	Part 2.1051 Part 22.917 Part 24.238	Pass	William Wang
Band Edge	Part 2.1051 Part 22.917 Part 24.238	Pass	William Wang
ERP and EIRP	Part 22.913(a) Part 24.232(b)	Pass	William Wang
Radiated Spurious Emissions	Part 2.1053 Part 22.917 Part 24.238	Pass	William Wang
Frequency stability vs. temperature	Part 2.1055(a)(1)(b) Part 22.355 Part 24.235	Pass	William Wang
Frequency stability vs. voltage	Part 2.1055(d)(1)(2) Part 22.355 Part 24.235	Pass	William Wang
Peak-Average Ratio	Part 24.232	Pass	William Wang

Note: The measurement uncertainty is not included in the test result.

### 3. SUMMARY

#### 3.1. Client Information

Applicant:	b mobile HK Limited
Address:	Flat 18; 14/F Block 1; Golden Industrial Building;16-26 Kwai Tak Street; Kwai Chung; New Territories; Hong Kong.
Manufacturer:	b mobile HK Limited
Address:	Flat 18; 14/F Block 1; Golden Industrial Building;16-26 Kwai Tak Street; Kwai Chung; New Territories; Hong Kong.

#### 3.2. Product Description

Name of EUT:	Mobile Phone
Trade Mark:	Bmobile
Model No.:	AX750
Listed Model(s):	-
IMEI 1:	357229080262243
IMEI 2:	357229080262250
Power supply:	DC 3.8V
Adapter information:	Input:100-220Va.c.,50/60Hz,0.2A Output: 5Vd.c.,1000mA
Hardware version:	Bmobile_AX750_Base_V001
Software version:	V1.0
<b>3G:</b>	
Operation Band:	FDD Band II and FDD Band V
Power Class:	Power Class 3
Modulation Type:	QPSK/16QAM/64QAM/HSUPA/HSDPA
DC-HSUPA Release Version:	Not Supported
Antenna type:	Integral Antenna
Antenna gain:	Band II: 1.2dBi, Band V: 1.2dBi

### 3.3. Operation state

#### ➤ Test frequency list

FDD Band II		FDD Band V	
Channel	Frequency (MHz)	Channel	Frequency (MHz)
9262	1852.4	4132	826.40
9400	1880.0	4183	836.60
9538	1907.6	4233	846.60

#### ➤ Test mode

For RF test items

The EUT has been tested under typical operating condition. Testing was performed by configuring EUT to maximum output power status.

The Test EUT support two SIM card(SIM1,SIM2),so all the tests are performed at each SIM card (SIM1,SIM2) mode, the datum recorded is the worst case for all the mode at SIM1 Card mode.

### 3.4. EUT configuration

The following peripheral devices and interface cables were connected during the measurement:

- - supplied by the manufacturer
- - supplied by the lab

	Length (m):	/
	Shield:	/
	Detachable:	/
	Manufacturer:	/
	Model No.:	/

### 3.5. Modifications

No modifications were implemented to meet testing criteria.

## **4. TEST ENVIRONMENT**

### **4.1. Address of the test laboratory**

Laboratory: Shenzhen Huatongwei International Inspection Co., Ltd.

Address: 1/F, Bldg 3, Hongfa Hi-tech Industrial Park, Genyu Road, Tianliao, Gongming, Shenzhen, China

### **4.2. Test Facility**

#### **CNAS-Lab Code: L1225**

Shenzhen Huatongwei International Inspection Co., Ltd. has been assessed and proved to be in compliance with CNAS-CL01 Accreditation Criteria for Testing and Calibration Laboratories (identical to ISO/IEC17025: 2005 General Requirements) for the Competence of Testing and Calibration Laboratories.

#### **A2LA-Lab Cert. No.: 3902.01**

Shenzhen Huatongwei International Inspection Co., Ltd. EMC Laboratory has been accredited by A2LA for technical competence in the field of electrical testing, and proved to be in compliance with ISO/IEC 17025: 2005 General Requirements for the Competence of Testing and Calibration Laboratories and any additional program requirements in the identified field of testing.

#### **FCC-Registration No.: 762235**

Shenzhen Huatongwei International Inspection Co., Ltd. EMC Laboratory has been registered and fully described in a report filed with the FCC (Federal Communications Commission). The acceptance letter from the FCC is maintained in our files.

#### **IC-Registration No.:5377B-1**

Two 3m Alternate Test Site of Shenzhen Huatongwei International Inspection Co., Ltd. has been registered by Certification and Engineering Bureau of Industry Canada for the performance of radiated measurements with Registration No.: 5377B-1.

#### **ACA**

Shenzhen Huatongwei International Inspection Co., Ltd. EMC Laboratory can also perform testing for the Australian C-Tick mark as a result of our A2LA accreditation.

### 4.3. Equipments Used during the Test

RF Conducted						
No.	Equipment	Manufacturer	Model No.	SerialNo.	Last Cal. (mm/dd/yy)	Next Cal. (mm/dd/yy)
1	UNIVERSAL RADIO COMMUNICATION	Rohde&Schwarz	CMU200	112012	11/11/2017	11/11/2018
2	WIDEB.RADIO COMM.TESRER	Rohde&Schwarz	CMW500	137688	10/26/2017	10/25/2018
3	Spectrum Analyzer	Rohde&Schwarz	FSW26	103440	11/11/2017	11/10/2018
4	MXA Signal Analyzer	Agilent Technologies	N9020A	MY5050187	11/10/2017	11/09/2018
5	Splitter	Mini-Circuit	ZAPD-4	400059	03/20/2017	03/19/2018
6	Climate Chamber	ESPEC	EL-10KA	05107008	11/10/2017	11/09/2018

RF Radiated						
No.	Equipment	Manufacturer	Model No.	SerialNo.	Last Cal. (mm/dd/yy)	Next Cal. (mm/dd/yy)
1	UNIVERSAL RADIO COMMUNICATION	Rohde&Schwarz	CMU200	112012	11/11/2017	11/11/2018
2	WIDEB.RADIO COMM.TESRER	Rohde&Schwarz	CMW500	137688	10/26/2017	10/25/2018
3	Spectrum Analyzer	Rohde&Schwarz	FSW26	103440	11/11/2017	11/10/2018
4	HORNANTENNA	ShwarzBeck	9120D	1011	03/27/2017	03/26/2020
5	Ultra-Broadband Antenna	ShwarzBeck	VULB9163	538	04/05/2017	04/04/2020
6	TURNTABLE	MATURO	TT2.0	N/A	N/A	N/A
7	ANTENNA MAST	MATURO	TAM-4.0-P	N/A	N/A	N/A
8	EMI Test Software	Audix	E3	N/A	N/A	N/A
9	EMI Test Receiver	R&S	ESCI	101247	11/11/2017	11/10/2018
10	High pass filter	Compliance Direction systems	BSU-6	34202	11/11/2017	11/10/2018
11	Preamplifier	ShwarzBeck	BBV 9718	9718-248	10/18/2017	10/17/2018
12	Broadband Preamplifier	ShwarzBeck	BBV 9743	9743-0022	10/18/2017	10/17/2018
13	Signal Generator	Rohde&Schwarz	SMB100A	114360	06/13/2017	06/12/2018
14	Pre-amplifier	SCHWARZBECK	BBV 9742	N/A	11/22/2017	11/21/2018
15	Turntable	Maturo Germany	TT2.0-1T	N/A	N/A	N/A
16	Antenna Mast	Maturo Germany	CAM-4.0-P-12	N/A	N/A	N/A
17	Test Software	R&S	ES-K1	N/A	N/A	N/A
18	Loop Antenna	R&S	HFH2-Z2	100020	11/20/2017	11/19/2020
19	RF Connection Cable	HUBER+SUHNER	N/A	N/A	11/21/2017	11/20/2018
20	RF Connection Cable	HUBER+SUHNER	SUCOFLEX104	501184/4	11/21/2017	11/20/2018
21	RF Connection Cable	HUBER+SUHNER	MULTIFLEX 141	N/A	11/21/2017	11/20/2018
22	Spectrum Analyzer	R&S	FSP40	100597	11/11/2017	11/10/2018
23	RF Connection Cable	HUBER+SUHNER	RE-7-FH	N/A	11/21/2017	11/20/2018
24	RF Connection Cable	HUBER+SUHNER	RE-7-FL	N/A	11/21/2017	11/20/2018



#### 4.4. Environmental conditions

During the measurement the environmental conditions were within the listed ranges:

Voltage	VN=Nominal Voltage	DC 3.80V
	VL=Lower Voltage	DC 3.60V
	VH=Higher Voltage	DC 4.35V
Normal Temperature/Tnor:		15~35°C
Relative Humidity		30~60 %
Air Pressure		950-1050 hPa

#### 4.5. Statement of the measurement uncertainty

The data and results referenced in this document are true and accurate. The reader is cautioned that there may be errors within the calibration limits of the equipment and facilities. The measurement uncertainty was calculated for all measurements listed in this test report acc. to TR-100028-01 "Electromagnetic compatibility and Radio spectrum Matters (ERM); Uncertainties in the measurement of mobile radio equipment characteristics; Part 1" and TR-100028-02 "Electromagnetic compatibility and Radio spectrum Matters (ERM); Uncertainties in the measurement of mobile radio equipment characteristics; Part 2" and is documented in the Shenzhen Huatongwei International Inspection Co., Ltd quality system acc. to DIN EN ISO/IEC 17025. Furthermore, component and process variability of devices similar to that tested may result in additional deviation. The manufacturer has the sole responsibility of continued compliance of the device.

Hereafter the best measurement capability for Shenzhen Huatongwei laboratory is reported:

Test Items	Measurement Uncertainty	Notes
Frequency stability	25 Hz	(1)
Transmitter power conducted	0.57 dB	(1)
Transmitter power Radiated	2.20 dB	(1)
Conducted spurious emission 9KHz-12.75 GHz	1.60 dB	(1)
Conducted Emission 9KHz-30MHz	3.39 dB	(1)
Radiated Emission 30~1000MHz	4.24 dB	(1)
Radiated Emission 1~18GHz	5.16 dB	(1)
Radiated Emission 18-40GHz	5.54 dB	(1)
Occupied Bandwidth	-----	(1)

(1) This uncertainty represents an expanded uncertainty expressed at approximately the 95% confidence level using a coverage factor of  $k=1.96$ .

## 5. TEST CONDITIONS AND RESULTS

### 5.1. Conducted Output Power

#### LIMIT

N/A

#### TEST CONFIGURATION

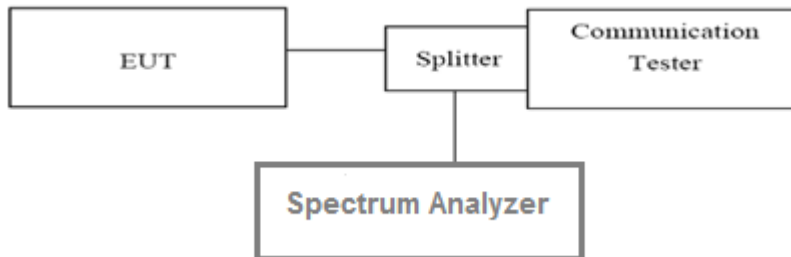

#### TEST PROCEDURE

1. The transmitter output port was connected to base station.
2. The RF output of EUT was connected to the spectrum analyzer by RF cable and attenuator, the path loss was compensated to the results for each measurement.
3. Set EUT at maximum power through base station.
4. Select lowest, middle, and highest channels for each band and different modulation.
5. Measure the maximum burst average power.

#### TEST MODE:

Please refer to the clause 3.3

#### TEST RESULTS

Passed       Not Applicable

Reference Appendix A:

## 5.2. 99% & -26 dB Occupied Bandwidth

### LIMIT

N/A

### TEST CONFIGURATION

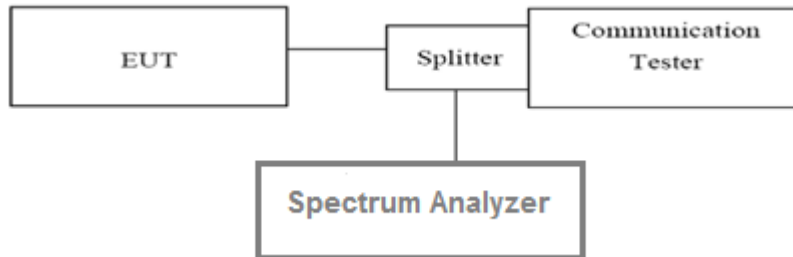

### TEST PROCEDURE

1. The EUT's output RF connector was connected with a short cable to the spectrum analyzer
2. RBW was set to about 1% of emission BW, VBW= 3 times RBW.
3. -26dBc display line was placed on the screen (or 99% bandwidth), the occupied bandwidth is the delta frequency between the two points where the display line intersects the signal trace.

### TEST MODE:

Please refer to the clause 3.3

### TEST RESULTS

Passed       Not Applicable

Reference Appendix C:

### 5.3. Conducted Spurious Emissions

#### LIMIT

Part 24.238 and Part 22.917 specify that the power of any emission outside of the authorized operating frequency ranges must be attenuated below the transmitting power (P) by a factor of at least  $43 + 10 \log(P)$  dB.

The specification that emissions shall be attenuated below the transmitter power (P) by at least  $43 + 10 \log(P)$  dB, translates in the relevant power range (1 to 0.001 W) to -13 dBm. At 1 W the specified minimum attenuation becomes 43 dB and relative to a 30 dBm (1 W) carrier becomes a limit of -13 dBm. At 0.001 W (0 dBm) the minimum attenuation is 13 dB, which again yields a limit of -13 dBm. In this way a translation of the specification from relative to absolute terms is carried out.

#### TEST CONFIGURATION

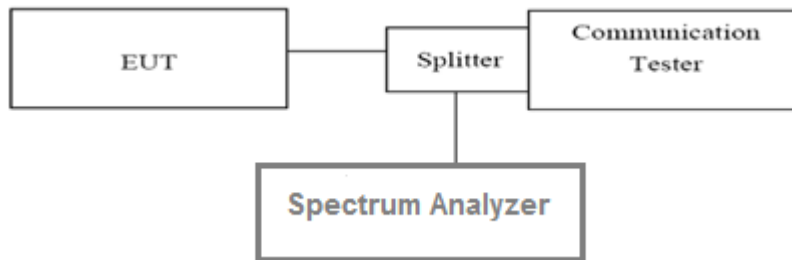

#### TEST PROCEDURE

1. The RF output of the transceiver was connected to a spectrum analyzer through appropriate attenuation.
2. The resolution bandwidth of the spectrum analyzer was set at 1MHz, sufficient scans were taken to show the out of band Emissions if any up to 10th harmonic.
3. For the out of band: Set the RBW= 1MHz, VBW = 3MHz, Start=30MHz, Stop= 10th harmonic.

#### TEST MODE:

Please refer to the clause 3.3

#### TEST RESULTS

**Passed**       **Not Applicable**

**Reference Appendix E:**

## 5.4. Band Edge

### LIMIT

Part 24.238 and Part 22.917 specify that the power of any emission outside of the authorized operating frequency ranges must be attenuated below the transmitting power (P) by a factor of at least  $43 + 10 \log(P)$  dB.

The specification that emissions shall be attenuated below the transmitter power (P) by at least  $43 + 10 \log(P)$  dB, translates in the relevant power range (1 to 0.001 W) to -13 dBm. At 1 W the specified minimum attenuation becomes 43 dB and relative to a 30 dBm (1 W) carrier becomes a limit of -13 dBm. At 0.001 W (0 dBm) the minimum attenuation is 13 dB, which again yields a limit of -13 dBm. In this way a translation of the specification from relative to absolute terms is carried out.

### TEST CONFIGURATION

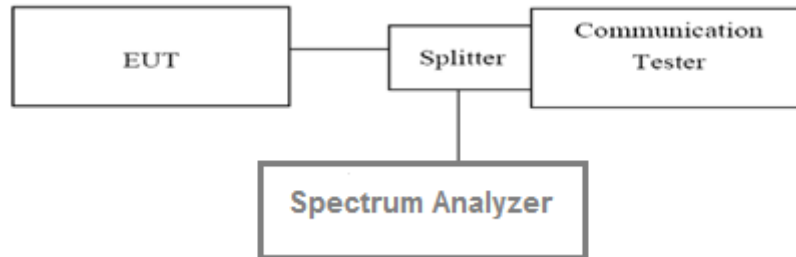

### TEST PROCEDURE

1. The RF output of the transceiver was connected to a spectrum analyzer through appropriate attenuation.
2. For the band edge: Set the RBW=100KHz, VBW = 300KHz, Sweep time= Auto

### TEST MODE:

Please refer to the clause 3.3

### TEST RESULTS

Passed       Not Applicable

Reference Appendix D:

## 5.5. ERP and EIRP

### LIMIT

WCDMA Band V: 7W ERP

WCDMA Band II: 2W EIRP

### TEST CONFIGURATION

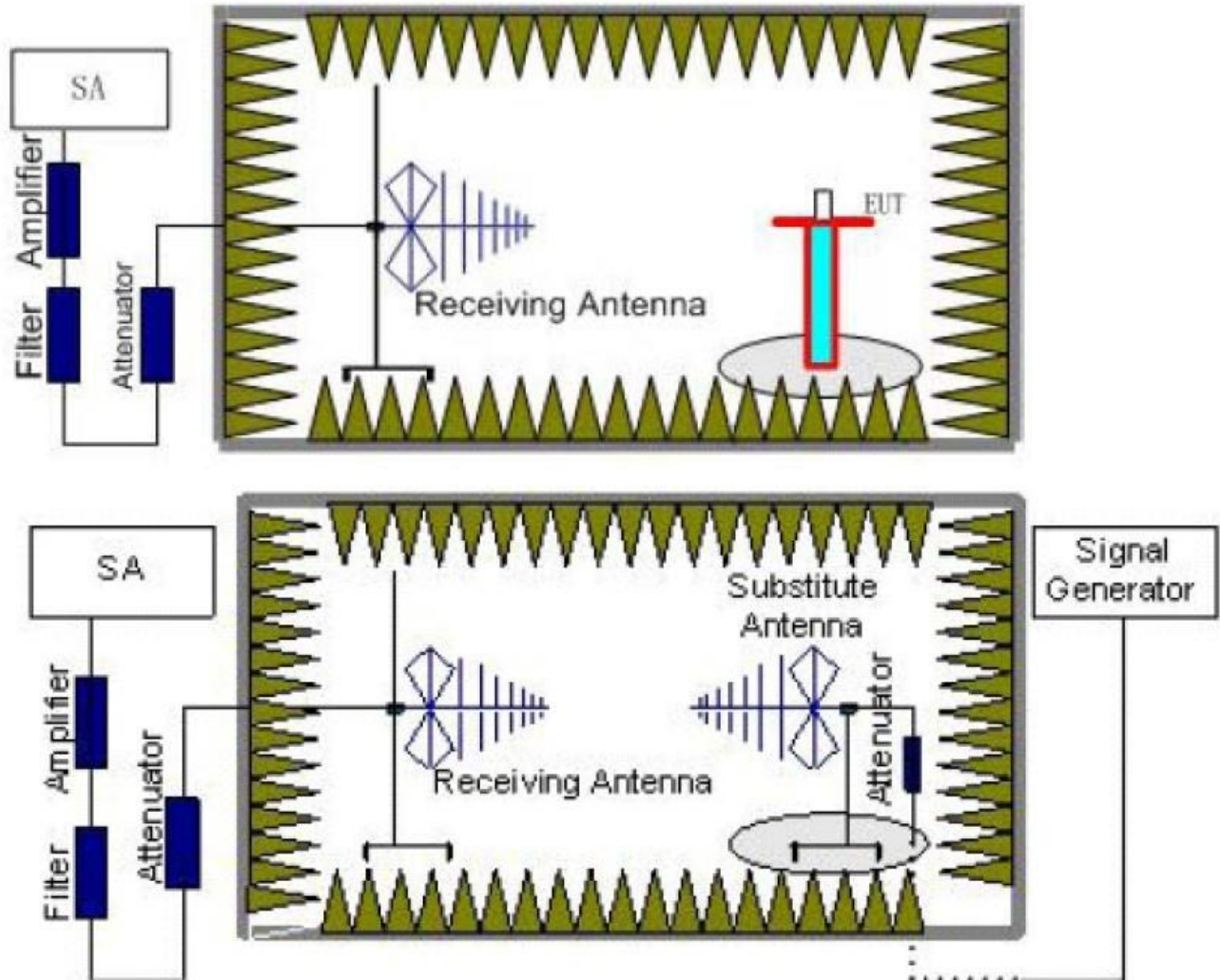

### TEST PROCEDURE

1. EUT was placed on a 0.8 meter high non-conductive stand at a 3 meter test distance from the receive antenna. A receiving antenna was placed on the antenna mast 3 meters from the EUT for emission measurements. The height of receiving antenna is 1.0m. Detected emissions were maximized at each frequency by rotating the EUT through 360° and adjusting the receiving antenna polarization. The radiated emission measurements of all transmit frequencies in three channels (High, Middle, Low) were measured with peak detector.
2. A log-periodic antenna or double-ridged waveguide horn antenna shall be substituted in place of the EUT. The log-periodic antenna will be driven by a signal generator and the level will be adjusted till the same power value on the spectrum analyzer or receiver. The level of the spurious emissions can be calculated through the level of the signal generator, cable loss, the gain of the substitution antenna and the reading of the spectrum analyzer or receiver.
3. The EUT is then put into continuously transmitting mode at its maximum power level during the test. Set Test Receiver or Spectrum RBW=1MHz, VBW=3MHz for above 1GHz and RBW=100kHz, VBW=300kHz for 30MHz to 1GHz,, And the maximum value of the receiver should be recorded as (Pr).
4. The EUT shall be replaced by a substitution antenna. In the chamber, an substitution antenna for the frequency band of interest is placed at the reference point of the chamber. An RF Signal source for the frequency band of interest is connected to the substitution antenna with a cable that has been constructed to not interfere with the radiation pattern of the antenna. A power (PMea) is applied to the input of the

substitution antenna, and adjust the level of the signal generator output until the value of the receiver reach the previously recorded (Pr). The power of signal source (PMea) is recorded. The test should be performed by rotating the test item and adjusting the receiving antenna polarization.

5. A amplifier should be connected to the Signal Source output port. And the cable should be connect between the Amplifier and the Substitution Antenna. The cable loss (Pcl) ,the Substitution Antenna Gain (Ga) and the Amplifier Gain (PAg) should be recorded after test.
6. The measurement results are obtained as described below:  
Power(EIRP)=PMea- PAg - Pcl + Ga  
We used SMF100A micowave signal generator which signal level can up to 33dBm,so we not used power Amplifier for substitution test; The measurement results are amend as described below:  
Power(EIRP)=PMea- Pcl + Ga
7. This value is EIRP since the measurement is calibrated using an antenna of known gain (2.15 dBi) and known input power.  
ERP can be calculated from EIRP by subtracting the gain of the dipole, ERP = EIRP-2.15dBi.

**TEST MODE:**

Please refer to the clause 3.3

**TEST RESULTS**

**Passed**       **Not Applicable**

Mode	Channel	Antenna Pol.	EIRP	Limit (dBm)	Result
WCDMA Band II	9262	V	16.92	33.00	Pass
		H	21.94		
	9400	V	16.71		
		H	26.35		
	9538	V	17.68		
		H	24.88		

Mode	Channel	Antenna Pol.	ERP	Limit (dBm)	Result
WCDMA Band V	4132	V	24.26	38.45	Pass
		H	18.41		
	4183	V	24.54		
		H	18.42		
	4233	V	23.70		
		H	17.47		



## 5.6. Radiated Spurious Emission

### LIMIT

-13dBm

### TEST CONFIGURATION

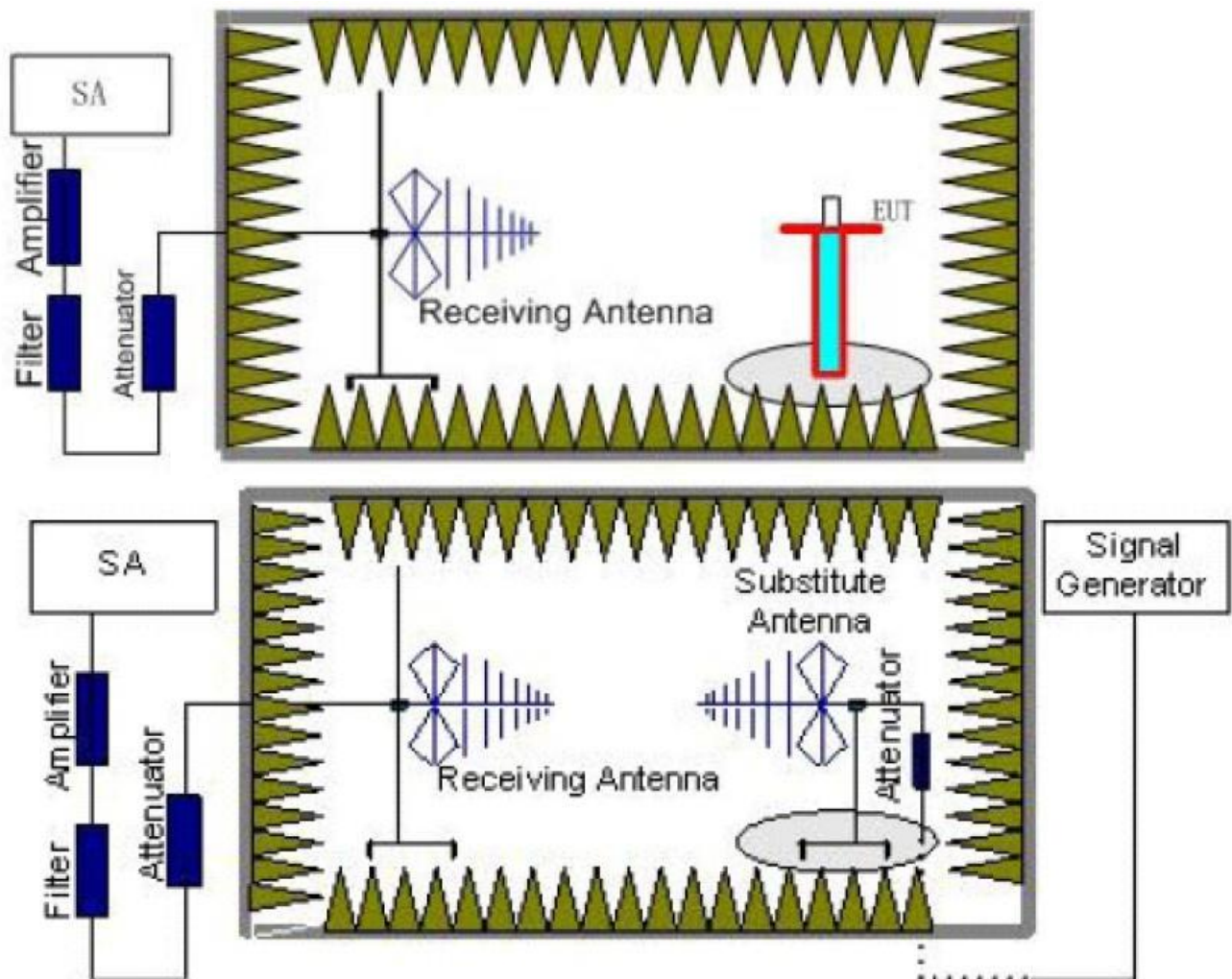

### TEST RESULTS

1. EUT was placed on a 0.8 meter high non-conductive stand at a 3 meter test distance from the receive antenna. A receiving antenna was placed on the antenna mast 3 meters from the EUT for emission measurements. The height of receiving antenna is 1.0m. Detected emissions were maximized at each frequency by rotating the EUT through 360° and adjusting the receiving antenna polarization. The radiated emission measurements of all transmit frequencies in three channels (High, Middle, Low) were measured with peak detector.
2. A log-periodic antenna or double-ridged waveguide horn antenna shall be substituted in place of the EUT. The log-periodic antenna will be driven by a signal generator and the level will be adjusted till the same power value on the spectrum analyzer or receiver. The level of the spurious emissions can be calculated through the level of the signal generator, cable loss, the gain of the substitution antenna and the reading of the spectrum analyzer or receiver.
3. The EUT is then put into continuously transmitting mode at its maximum power level during the test. Set Test Receiver or Spectrum RBW=1MHz,VBW=3MHz for above 1GHz and RBW=100kHz,VBW=300kHz for 30MHz to 1GHz, And the maximum value of the receiver should be recorded as (Pr).
4. The EUT shall be replaced by a substitution antenna. In the chamber, an substitution antenna for the frequency band of interest is placed at the reference point of the chamber. An RF Signal source for the frequency band of interest is connected to the substitution antenna with a cable that has been constructed to not interfere with the radiation pattern of the antenna. A power (PMea) is applied to the input of the

substitution antenna, and adjust the level of the signal generator output until the value of the receiver reach the previously recorded (Pr). The power of signal source (PMea) is recorded. The test should be performed by rotating the test item and adjusting the receiving antenna polarization.

5. A amplifier should be connected to the Signal Source output port. And the cable should be connect between the Amplifier and the Substitution Antenna. The cable loss (Pcl) ,the Substitution Antenna Gain (Ga) and the Amplifier Gain (PAg) should be recorded after test.
6. The measurement results are obtained as described below:  
Power(EIRP)=PMea- PAg - Pcl + Ga  
We used SMF100A micowave signal generator which signal level can up to 33dBm,so we not used power Amplifier for substitution test; The measurement results are amend as described below:  
Power(EIRP)=PMea- Pcl + Ga
7. This value is EIRP since the measurement is calibrated using an antenna of known gain (2.15 dBi) and known input power.  
ERP can be calculated from EIRP by subtracting the gain of the dipole, ERP = EIRP-2.15dBi.

**TEST MODE:**

Please refer to the clause 3.3

**TEST RESULTS**

**Passed**       **Not Applicable**

Note: Worst case at WCDMA Band II/ WCDMA Band V

WCDMA Band II					
Channel	Frequency (MHz)	Spurious Emission		Limit (dBm)	Result
		Polarization	Level (dBm)		
9262	200.36	Vertical	-58.14	-13.00	Pass
	266.39	V	-54.71		
	1288.89	V	-53.84		
	2646.85	V	-48.24		
	5554.08	V	-34.29		
	7401.51	V	-26.65		
	266.39	Horizontal	-61.03	-13.00	Pass
	600.20	H	-61.12		
	1449.66	H	-50.35		
	2519.18	H	-45.55		
	5562.15	H	-29.32		
	7401.51	H	-24.11		
9400	266.39	Vertical	-60.28	-13.00	Pass
	598.09	V	-59.54		
	1259.49	V	-48.14		
	2580.81	V	-44.28		
	5635.22	V	-31.78		
	7520.54	V	-29.30		
	200.36	Horizontal	-62.47	-13.00	Pass
	319.84	H	-60.88		
	1260.88	H	-50.52		
	2580.81	H	-44.82		
	5643.40	H	-29.28		
	7520.54	H	-26.84		
9538	266.39	Vertical	-54.18	-13.00	Pass
	600.20	V	-52.46		
	1449.66	V	-48.42		
	2580.81	V	-44.96		
	5725.84	V	-30.75		
	7641.47	V	-30.87		
	159.98	Horizontal	-63.32	-13.00	Pass
	300.22	H	-60.81		
	1716.90	H	-45.02		
	1989.20	H	-44.08		
	5725.84	H	-27.16		
	7641.47	H	-27.35		

## Remark:

1. The emission behaviour belongs to narrowband spurious emission.
2. The emission levels of not record in the report are very lower than the limit and not show in test report.

WCDMA Band V					
Channel	Frequency (MHz)	Spurious Emission		Limit (dBm)	Result
		Polarization	Level (dBm)		
4132	184.14	Vertical	-59.42	-13.00	Pass
	266.39	V	-54.28		
	1650.32	V	-50.00		
	2519.18	V	-46.35		
	4137.66	V	-45.66		
	4952.85	V	-46.82		
	266.39	Horizontal	-57.84	-13.00	Pass
	600.20	H	-58.84		
	1650.32	H	-46.55		
	2475.28	H	-47.87		
	4125.68	H	-45.03		
	4952.85	H	-45.26		
4183	200.36	Vertical	-55.71	-13.00	Pass
	266.39	V	-54.22		
	1670.38	V	-50.32		
	2580.81	V	-44.73		
	4173.82	V	-49.13		
	5010.65	V	-48.04		
	266.39	Horizontal	-59.06	-13.00	Pass
	600.20	H	-59.79		
	1670.38	H	-44.47		
	2508.13	H	-45.18		
	4173.82	H	-46.66		
	5017.92	H	-46.93		
4233	200.36	Vertical	-55.79	-13.00	Pass
	266.39	V	-54.29		
	1448.07	V	-48.09		
	2580.81	V	-37.62		
	5076.48	V	-45.23		
	6774.86	V	-42.59		
	319.84	Horizontal	-60.29	-13.00	Pass
	600.20	H	-59.87		
	1696.27	H	-47.20		
	2586.49	H	-43.46		
	4222.53	H	-44.12		
	6784.69	H	-41.50		

## Remark:

1. The emission behaviour belongs to narrowband spurious emission.
2. The emission levels of not record in the report are very lower than the limit and not show in test report.

## 5.7. Frequency stability V.S. Temperature measurement

### LIMIT

2.5ppm

### TEST CONFIGURATION

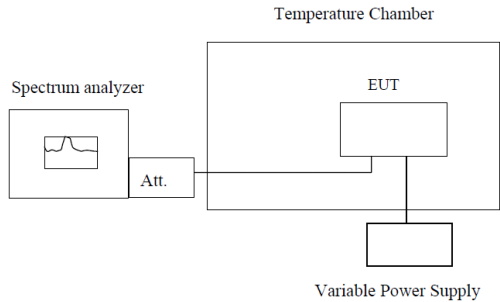

**Note :** Measurement setup for testing on Antenna connector

### TEST PROCEDURE

1. The equipment under test was connected to an external DC power supply and input rated voltage.
2. RF output was connected to a frequency counter or spectrum analyzer via feed through attenuators.
3. The EUT was placed inside the temperature chamber.
4. Set the spectrum analyzer RBW low enough to obtain the desired frequency resolution and measure EUT 25°C operating frequency as reference frequency.
5. Turn EUT off and set the chamber temperature to  $-30^{\circ}\text{C}$ . After the temperature stabilized for approximately 30 minutes recorded the frequency.
6. Repeat step measure with  $10^{\circ}\text{C}$  increased per stage until the highest temperature of  $+50^{\circ}\text{C}$  reached.

### TEST MODE:

Please refer to the clause 3.3

### TEST RESULTS

**Passed**       **Not Applicable**

**Reference Appendix F:**

## 5.8. Frequency stability V.S. Voltage measurement

### LIMIT

2.5ppm

### TEST CONFIGURATION

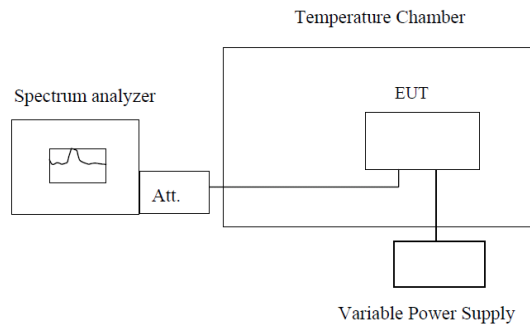

**Note :** Measurement setup for testing on Antenna connector

### TEST PROCEDURE

1. Set chamber temperature to 25°C. Use a variable DC power source to power the EUT and set the voltage to rated voltage.
2. Set the spectrum analyzer RBW low enough to obtain the desired frequency resolution and record the frequency.
3. Reduce the input voltage to specified extreme voltage variation (+/- 15%) and endpoint, record the maximum frequency change.

### TEST MODE:

Please refer to the clause 3.3

### TEST RESULTS

**Passed**       **Not Applicable**

**Reference Appendix F:**

## 5.9. Peak-Average Ratio

### LIMIT

13dB

### TEST CONFIGURATION

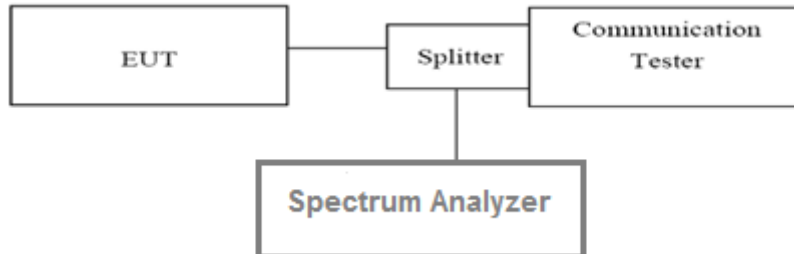

### TEST PROCEDURE

According with KDB 971168

1. The signal analyzer's CCDF measurement profile is enabled
2. Frequency = carrier center frequency
3. Measurement BW > Emission bandwidth of signal
4. The signal analyzer was set to collect one million samples to generate the CCDF curve
5. The measurement interval was set depending on the type of signal analyzed. For continuous signals (>98% duty cycle), the measurement interval was set to 1ms. For burst transmissions, the spectrum analyzer is set to use an internal "RF Burst" trigger that is synced with an incoming pulse and the measurement interval is set to less than the duration of the "on time" of one burst to ensure that energy is only captured during a time in which the transmitter is operating at maximum power

### TEST MODE:

Please refer to the clause 3.3

### TEST RESULTS

Passed       Not Applicable

**Reference Appendix B:**

## 6. Test Setup Photos of the EUT

Radiated emission:

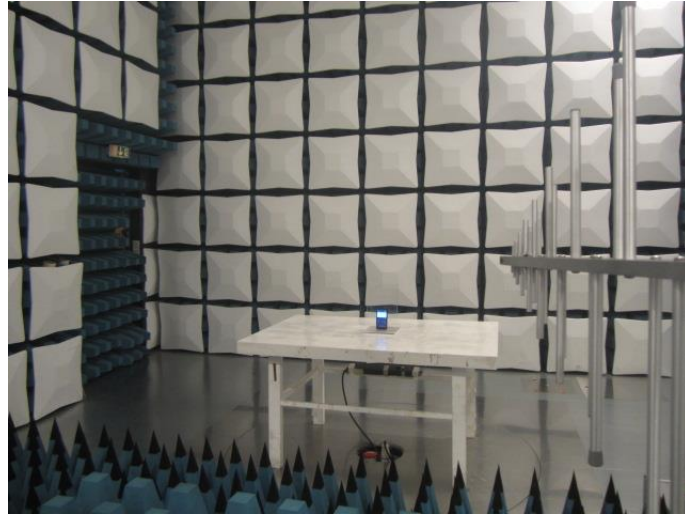

## 7. External and Internal Photos of the EUT

Reference to the test report No.: TRE1801013301

.....End of Report.....



**Appendix A: Conducted Output Power**

## Test Result

Band	Channel	Power(dBm)	Limit(dBm)	Verdict
Band II	9262	23.06	33	PASS
Band II	9400	23.26	33	PASS
Band II	9538	23.02	33	PASS
Band V	4132	24.03	38.5	PASS
Band V	4182	24.29	38.5	PASS
Band V	4233	24.14	38.5	PASS

Band	Channel	SubTest	Power(dBm)	Limit(dBm)	Verdict
Band II	9262	HSDPA_Sub0	22.01	33	PASS
Band II	9262	HSDPA_Sub1	21.55	33	PASS
Band II	9262	HSDPA_Sub2	21.53	33	PASS
Band II	9262	HSDPA_Sub3	21.55	33	PASS
Band II	9400	HSDPA_Sub0	22.33	33	PASS
Band II	9400	HSDPA_Sub1	21.88	33	PASS
Band II	9400	HSDPA_Sub2	21.86	33	PASS
Band II	9400	HSDPA_Sub3	21.81	33	PASS
Band II	9538	HSDPA_Sub0	22.00	33	PASS
Band II	9538	HSDPA_Sub1	21.55	33	PASS
Band II	9538	HSDPA_Sub2	21.54	33	PASS
Band II	9538	HSDPA_Sub3	21.49	33	PASS
Band V	4132	HSDPA_Sub0	23.33	38.5	PASS
Band V	4132	HSDPA_Sub1	22.80	38.5	PASS
Band V	4132	HSDPA_Sub2	22.83	38.5	PASS
Band V	4132	HSDPA_Sub3	22.79	38.5	PASS
Band V	4182	HSDPA_Sub0	23.21	38.5	PASS
Band V	4182	HSDPA_Sub1	22.69	38.5	PASS
Band V	4182	HSDPA_Sub2	22.72	38.5	PASS
Band V	4182	HSDPA_Sub3	22.69	38.5	PASS
Band V	4233	HSDPA_Sub0	23.14	38.5	PASS
Band V	4233	HSDPA_Sub1	22.66	38.5	PASS
Band V	4233	HSDPA_Sub2	22.70	38.5	PASS
Band V	4233	HSDPA_Sub3	22.65	38.5	PASS

Band	Channel	SubTest	Power(dBm)	Limit(dBm)	Verdict
Band II	9262	HSUPA_Sub1	19.19	33	PASS
Band II	9262	HSUPA_Sub2	20.17	33	PASS
Band II	9262	HSUPA_Sub3	20.01	33	PASS
Band II	9262	HSUPA_Sub4	19.20	33	PASS
Band II	9262	HSUPA_Sub5	20.07	33	PASS
Band II	9400	HSUPA_Sub1	18.67	33	PASS
Band II	9400	HSUPA_Sub2	19.85	33	PASS
Band II	9400	HSUPA_Sub3	19.85	33	PASS
Band II	9400	HSUPA_Sub4	18.98	33	PASS
Band II	9400	HSUPA_Sub5	19.80	33	PASS
Band II	9538	HSUPA_Sub1	19.25	33	PASS
Band II	9538	HSUPA_Sub2	20.20	33	PASS
Band II	9538	HSUPA_Sub3	20.18	33	PASS
Band II	9538	HSUPA_Sub4	19.23	33	PASS
Band II	9538	HSUPA_Sub5	20.17	33	PASS
Band V	4132	HSUPA_Sub1	20.18	38.5	PASS
Band V	4132	HSUPA_Sub2	21.06	38.5	PASS
Band V	4132	HSUPA_Sub3	21.20	38.5	PASS
Band V	4132	HSUPA_Sub4	20.27	38.5	PASS
Band V	4132	HSUPA_Sub5	21.25	38.5	PASS
Band V	4182	HSUPA_Sub1	20.27	38.5	PASS
Band V	4182	HSUPA_Sub2	21.27	38.5	PASS
Band V	4182	HSUPA_Sub3	21.29	38.5	PASS
Band V	4182	HSUPA_Sub4	20.32	38.5	PASS
Band V	4182	HSUPA_Sub5	21.27	38.5	PASS
Band V	4233	HSUPA_Sub1	19.99	38.5	PASS
Band V	4233	HSUPA_Sub2	21.02	38.5	PASS
Band V	4233	HSUPA_Sub3	21.22	38.5	PASS
Band V	4233	HSUPA_Sub4	20.23	38.5	PASS
Band V	4233	HSUPA_Sub5	21.10	38.5	PASS

**Appendix B: Peak-to-Average Ratio**

## Test Result

Band	Channel	Peak-to-Average Ratio(dB)	Limit(dBm)	Verdict
Band II	9262	3.11	13	PASS
Band II	9400	3.09	13	PASS
Band II	9538	3.17	13	PASS
Band V	4132	3.02	13	PASS
Band V	4182	3.00	13	PASS
Band V	4233	2.99	13	PASS

Test Graphs

Band II\_9262

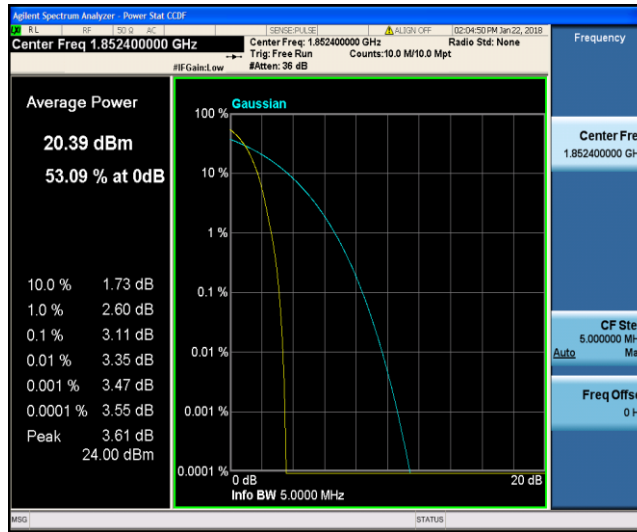

Band II\_9400

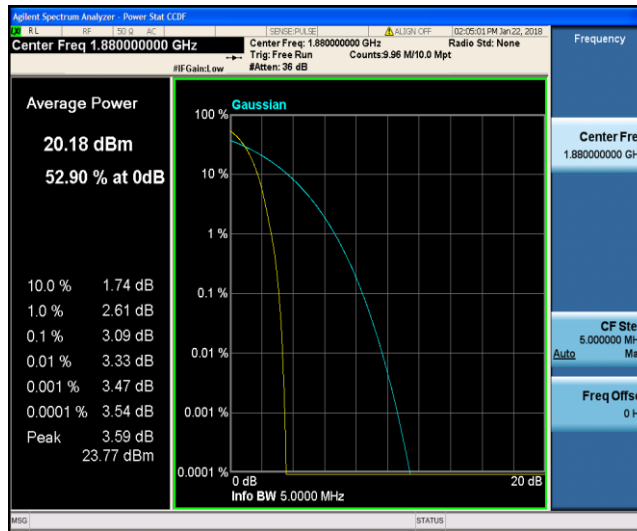

Band II\_9538

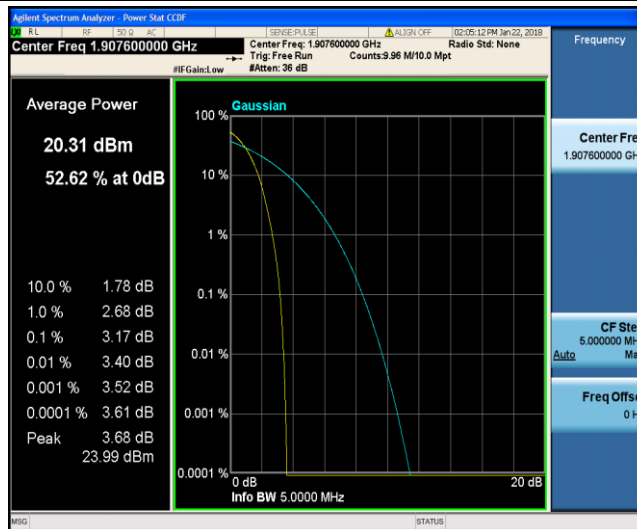

Band V\_4132

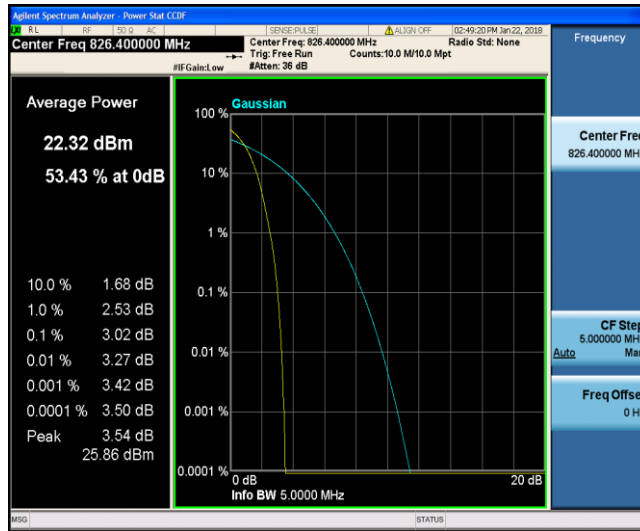

Band V\_4182

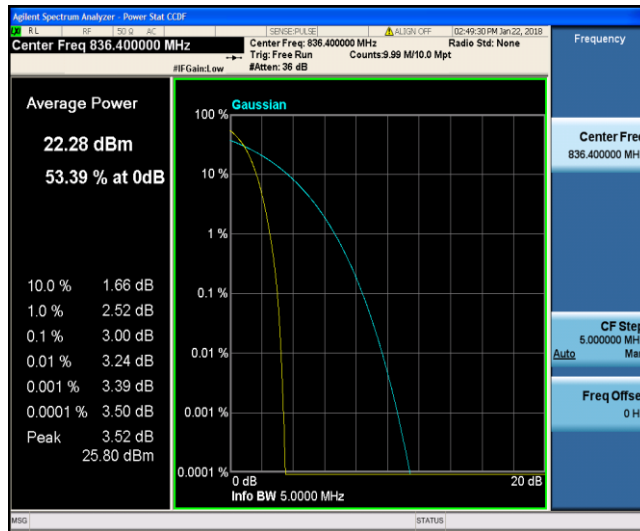

Band V\_4233

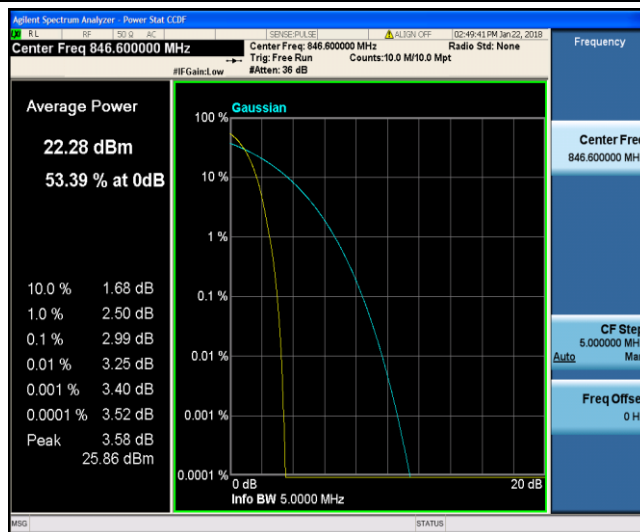

**Appendix C: 26dB Bandwidth and Occupied Bandwidth**

## Test Result

Band	Channel	Occupied Bandwidth (kHz)	26dB Bandwidth (kHz)	Limit(kHz)	Verdict
Band II	9262	4152.0	4697	---	PASS
Band II	9400	4174.1	4684	---	PASS
Band II	9538	4179.0	4686	---	PASS
Band V	4132	4164.2	4695	---	PASS
Band V	4182	4152.0	4687	---	PASS
Band V	4233	4156.4	4689	---	PASS

Test Graphs

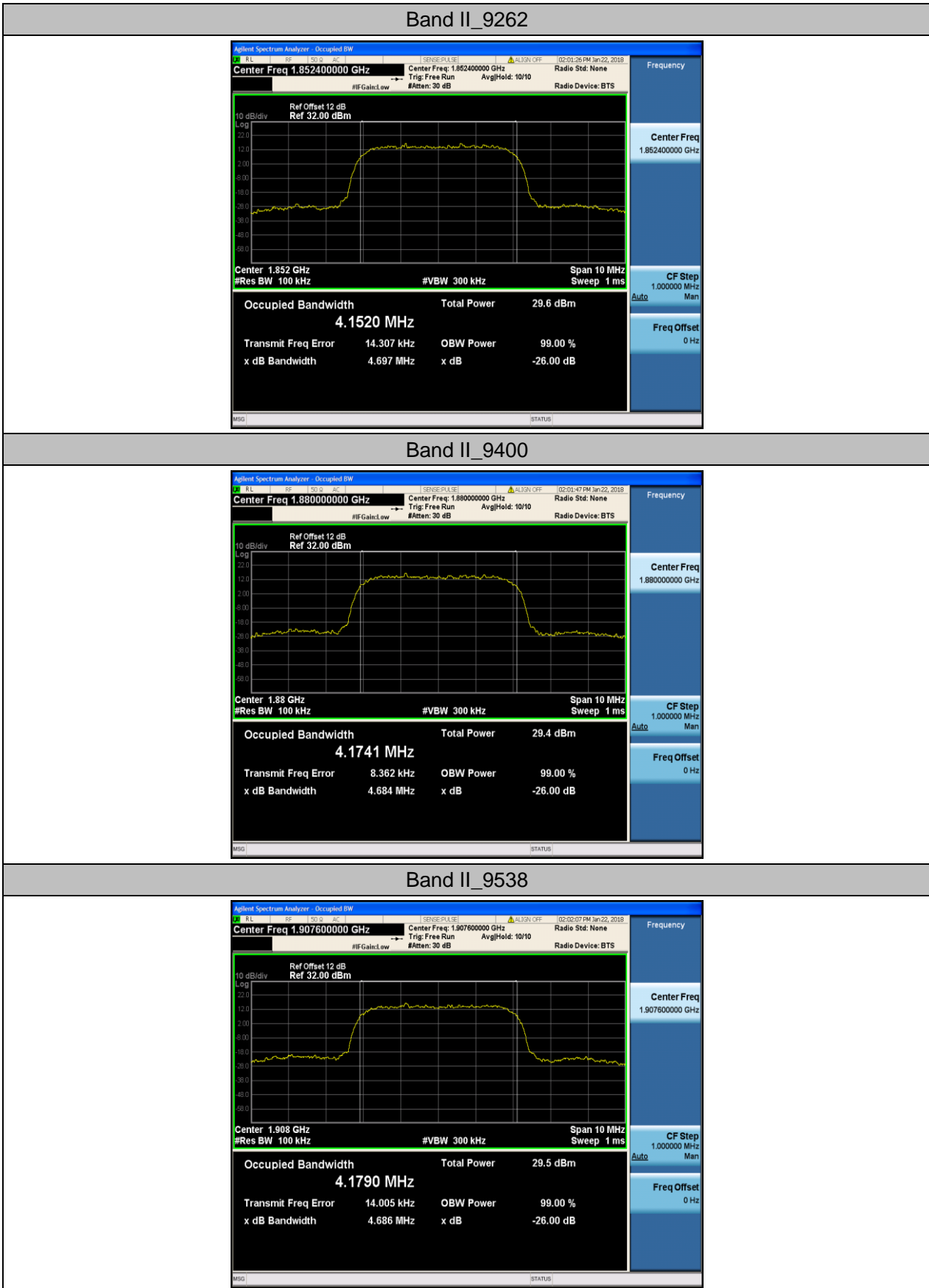



Band V\_4132

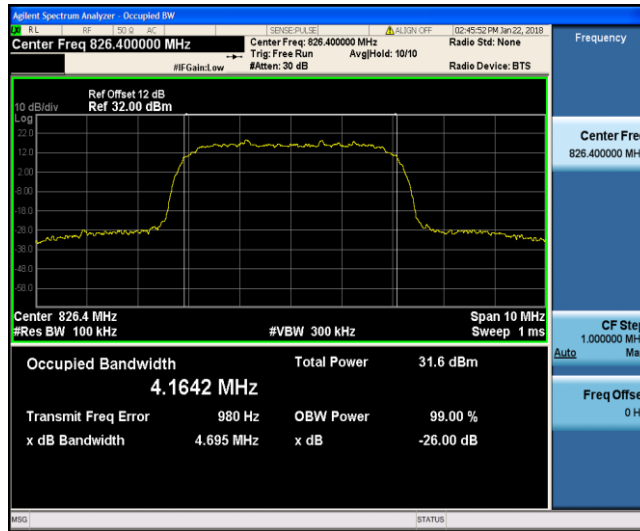

Band V\_4182

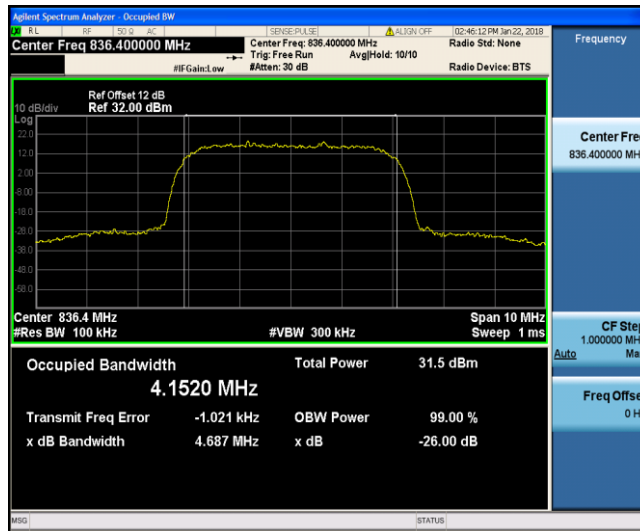

Band V\_4233

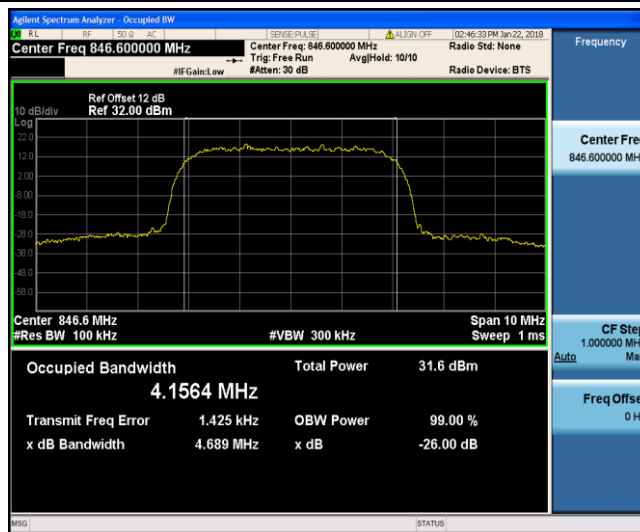

**Appendix D: Band Edge**

## Test Result

Band	Channel	Value(dBm)	Limit(dBm)	Verdict
Band II	9262	-20.27	-13	PASS
Band II	9538	-16.60	-13	PASS
Band V	4132	-18.25	-13	PASS
Band V	4233	-15.57	-13	PASS

Test Graphs

Band II\_9262



Band II\_9538



Band V\_4132

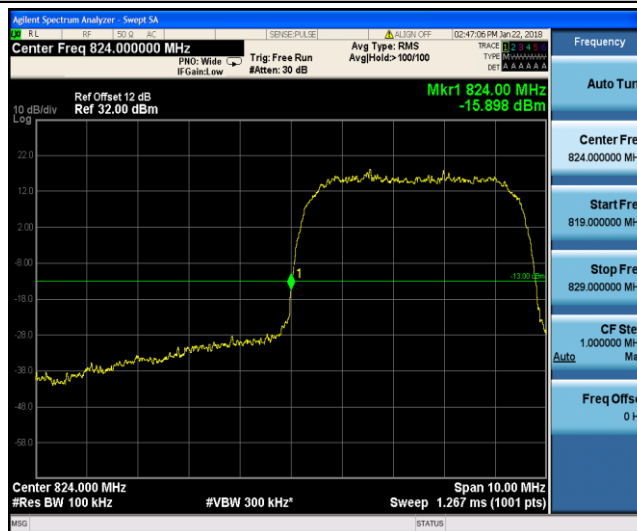

Band V\_4233



**Appendix E: Conducted Spurious Emission**

## Test Result

Band	Channel	Frequency Rang(Mhz)	Value(dBm)	Limit(dBm)	Verdict
Band II	9262	30~1000	-38.73	-13	PASS
Band II	9262	1000~20000	-19.63	-13	PASS
Band II	9400	30~1000	-33.36	-13	PASS
Band II	9400	1000~20000	-19.53	-13	PASS
Band II	9538	30~1000	-37.53	-13	PASS
Band II	9538	1000~20000	-19.54	-13	PASS
Band V	4132	30~1000	-37.76	-13	PASS
Band V	4132	1000~20000	-19.28	-13	PASS
Band V	4182	30~1000	-39.17	-13	PASS
Band V	4182	1000~20000	-19.31	-13	PASS
Band V	4233	30~1000	-38.25	-13	PASS
Band V	4233	1000~20000	-19.71	-13	PASS

Test Graphs

Band II\_9262

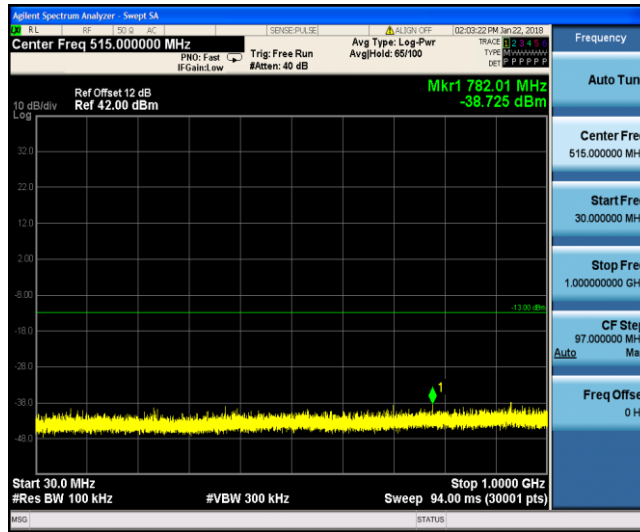

Band II\_9262

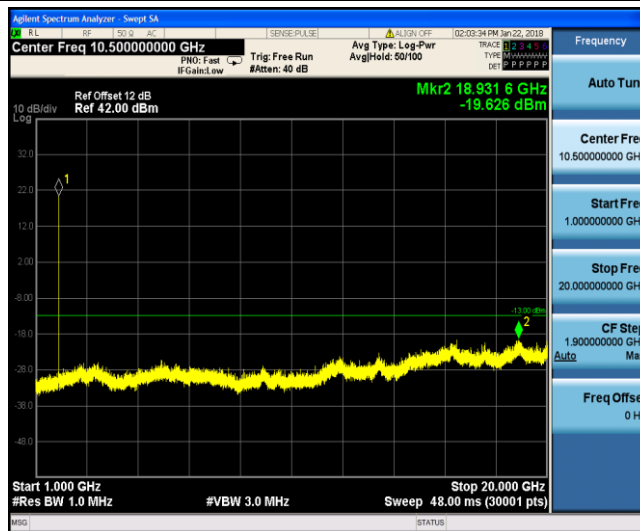

Band II\_9400

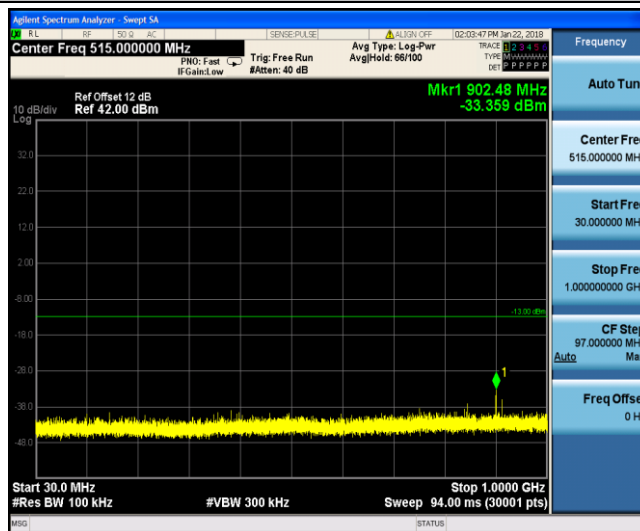

Band II\_9400



Band II\_9538

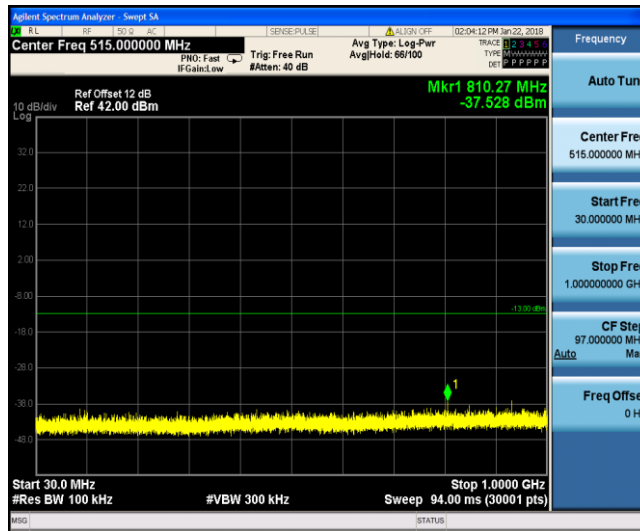

Band II\_9538

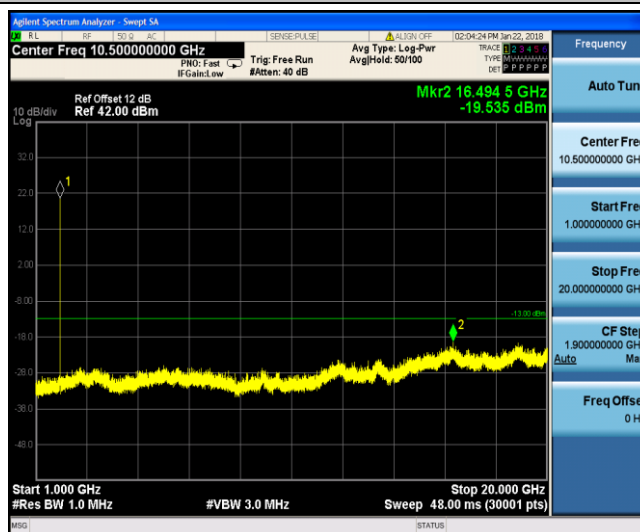

Band V\_4132

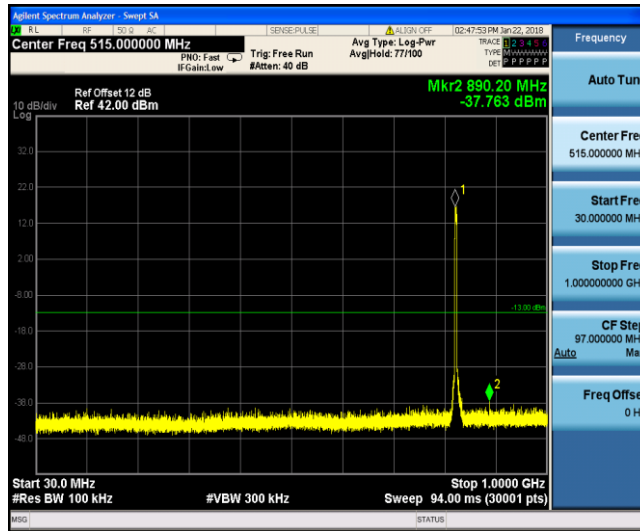

Band V\_4132

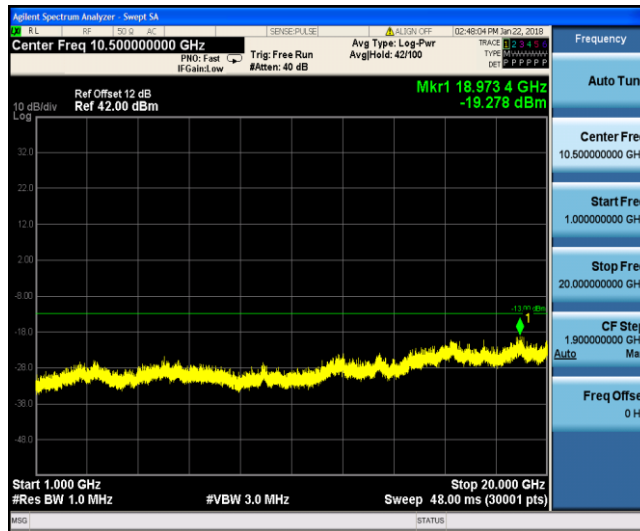

Band V\_4182

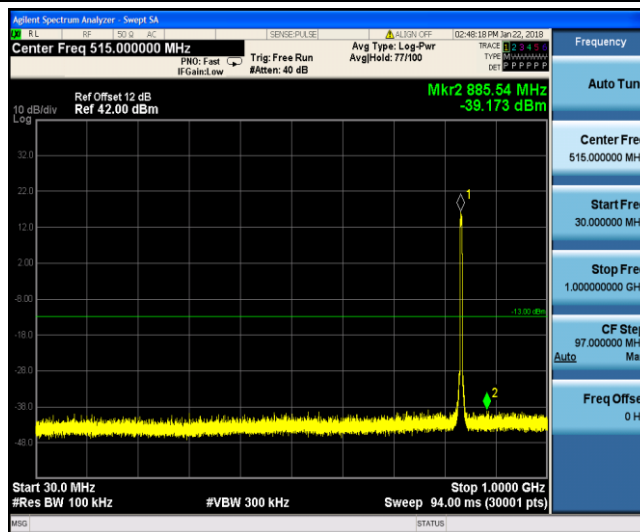



Band V\_4182



Band V\_4233

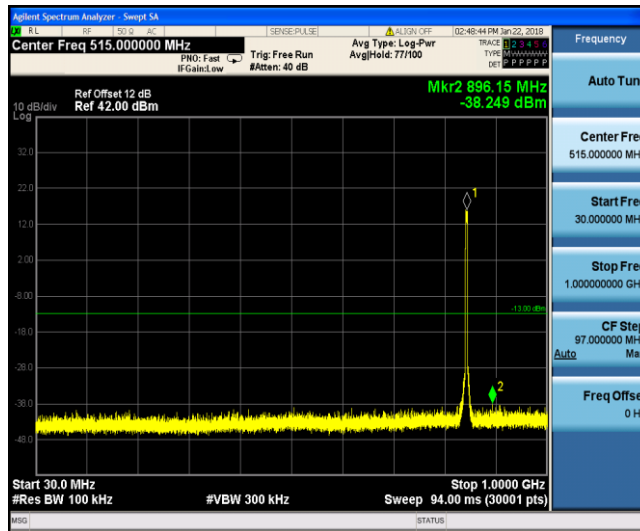

Band V\_4233

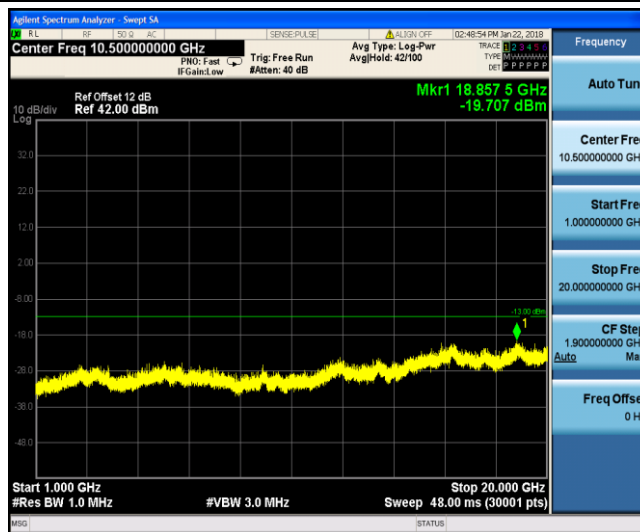

**Appendix F: Frequency Stability**

## Test Result

Voltage							
Band	Channel	Voltage (Vdc)	Temperature (°C)	Deviation (Hz)	Deviation (ppm)	Limit (ppm)	Verdict
Band II	9262	VL	TN	8.08	0.004359	2.5	PASS
Band II	9262	VN	TN	6.20	0.003348	2.5	PASS
Band II	9262	VH	TN	4.97	0.002684	2.5	PASS
Band II	9400	VL	TN	8.96	0.004763	2.5	PASS
Band II	9400	VN	TN	9.21	0.004900	2.5	PASS
Band II	9400	VH	TN	9.57	0.005090	2.5	PASS
Band II	9538	VL	TN	9.30	0.004874	2.5	PASS
Band II	9538	VN	TN	-5.84	-0.003063	2.5	PASS
Band II	9538	VH	TN	7.91	0.004147	2.5	PASS
Band V	4132	VL	TN	-0.39	-0.000467	2.5	PASS
Band V	4132	VN	TN	-2.47	-0.002995	2.5	PASS
Band V	4132	VH	TN	-2.89	-0.003497	2.5	PASS
Band V	4182	VL	TN	0.20	0.000239	2.5	PASS
Band V	4182	VN	TN	-1.57	-0.001881	2.5	PASS
Band V	4182	VH	TN	-1.00	-0.001197	2.5	PASS
Band V	4233	VL	TN	2.00	0.002357	2.5	PASS
Band V	4233	VN	TN	2.63	0.003109	2.5	PASS
Band V	4233	VH	TN	3.27	0.003861	2.5	PASS

Temperature							
Band	Channel	Voltage (Vdc)	Temperature (°C)	Deviation (Hz)	Deviation (ppm)	Limit (ppm)	Verdict
Band II	9262	VN	-30	5.32	0.002873	2.5	PASS
Band II	9262	VN	-20	8.36	0.004514	2.5	PASS
Band II	9262	VN	-10	4.16	0.002243	2.5	PASS
Band II	9262	VN	0	8.14	0.004394	2.5	PASS
Band II	9262	VN	10	10.51	0.005676	2.5	PASS
Band II	9262	VN	20	9.36	0.005050	2.5	PASS
Band II	9262	VN	30	6.39	0.003448	2.5	PASS
Band II	9262	VN	40	3.21	0.001734	2.5	PASS
Band II	9262	VN	50	6.17	0.003328	2.5	PASS
Band II	9400	VN	-30	6.74	0.003588	2.5	PASS
Band II	9400	VN	-20	5.34	0.002838	2.5	PASS
Band II	9400	VN	-10	7.82	0.004162	2.5	PASS
Band II	9400	VN	0	8.44	0.004489	2.5	PASS
Band II	9400	VN	10	4.99	0.002652	2.5	PASS
Band II	9400	VN	20	8.85	0.004706	2.5	PASS
Band II	9400	VN	30	6.59	0.003508	2.5	PASS
Band II	9400	VN	40	11.14	0.005924	2.5	PASS
Band II	9400	VN	50	4.51	0.002401	2.5	PASS
Band II	9538	VN	-30	5.81	0.003045	2.5	PASS
Band II	9538	VN	-20	6.32	0.003311	2.5	PASS
Band II	9538	VN	-10	9.41	0.004931	2.5	PASS
Band II	9538	VN	0	8.98	0.004709	2.5	PASS
Band II	9538	VN	10	8.69	0.004556	2.5	PASS
Band II	9538	VN	20	20.95	0.010982	2.5	PASS
Band II	9538	VN	30	7.47	0.003918	2.5	PASS
Band II	9538	VN	40	-3.16	-0.001657	2.5	PASS
Band II	9538	VN	50	-2.05	-0.001072	2.5	PASS
Band V	4132	VN	-30	-2.42	-0.002934	2.5	PASS
Band V	4132	VN	-20	-1.62	-0.001965	2.5	PASS
Band V	4132	VN	-10	-2.05	-0.002484	2.5	PASS
Band V	4132	VN	0	-1.81	-0.002190	2.5	PASS
Band V	4132	VN	10	-1.89	-0.002285	2.5	PASS
Band V	4132	VN	20	-1.17	-0.001411	2.5	PASS
Band V	4132	VN	30	-3.25	-0.003938	2.5	PASS
Band V	4132	VN	40	-0.68	-0.000822	2.5	PASS
Band V	4132	VN	50	-3.34	-0.004042	2.5	PASS
Band V	4182	VN	-30	0.10	0.000120	2.5	PASS
Band V	4182	VN	-20	-0.63	-0.000753	2.5	PASS
Band V	4182	VN	-10	-0.57	-0.000676	2.5	PASS
Band V	4182	VN	0	1.39	0.001659	2.5	PASS
Band V	4182	VN	10	0.13	0.000154	2.5	PASS
Band V	4182	VN	20	-1.04	-0.001249	2.5	PASS
Band V	4182	VN	30	0.94	0.001120	2.5	PASS
Band V	4182	VN	40	0.19	0.000231	2.5	PASS
Band V	4182	VN	50	-0.65	-0.000778	2.5	PASS
Band V	4233	VN	-30	2.12	0.002509	2.5	PASS
Band V	4233	VN	-20	1.74	0.002053	2.5	PASS
Band V	4233	VN	-10	1.68	0.001985	2.5	PASS

Band V	4233	VN	0	1.56	0.001842	2.5	PASS
Band V	4233	VN	10	2.66	0.003143	2.5	PASS
Band V	4233	VN	20	1.20	0.001419	2.5	PASS
Band V	4233	VN	30	1.90	0.002247	2.5	PASS
Band V	4233	VN	40	1.11	0.001310	2.5	PASS
Band V	4233	VN	50	1.43	0.001690	2.5	PASS

-----End of Appendix-----