

802.11g-2462MHz Peak:

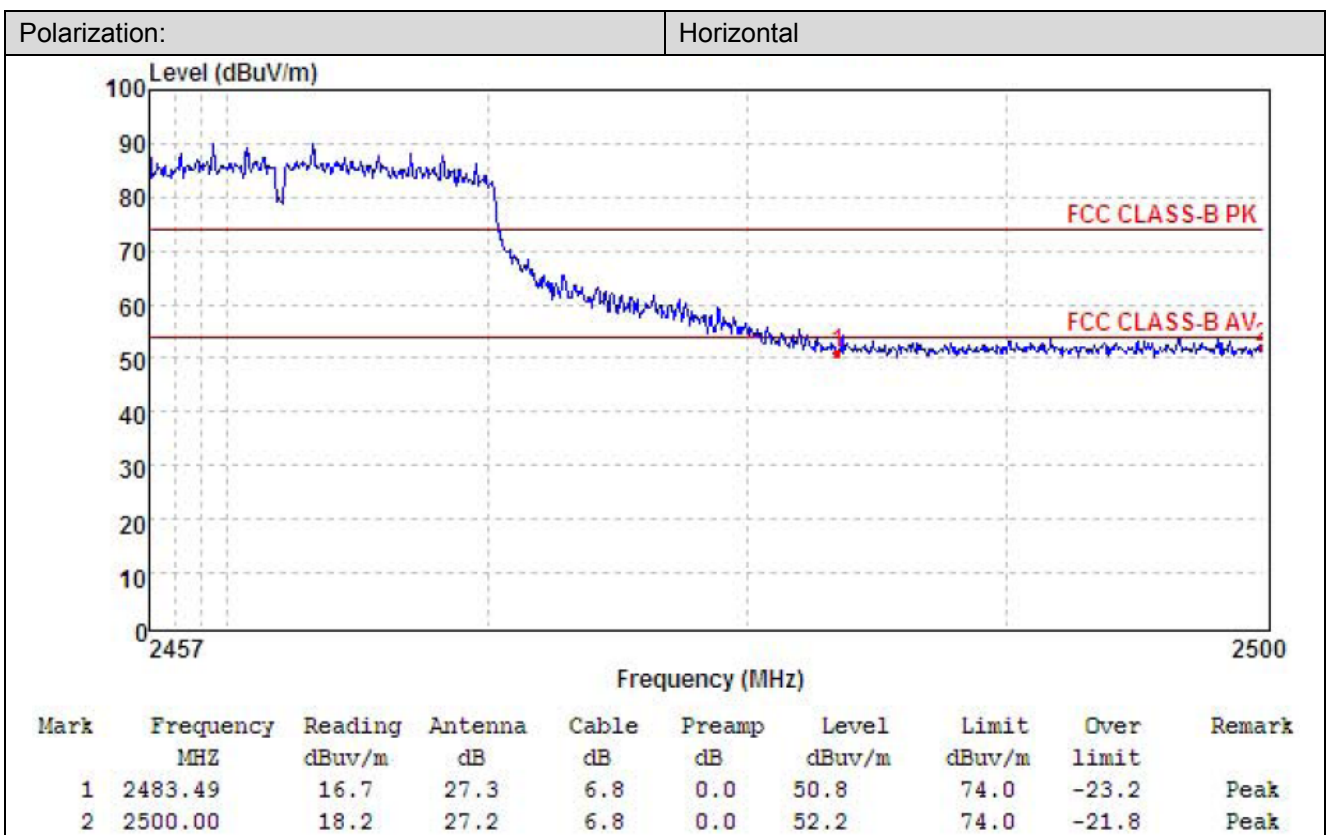

802.11g-2462MHz Average:

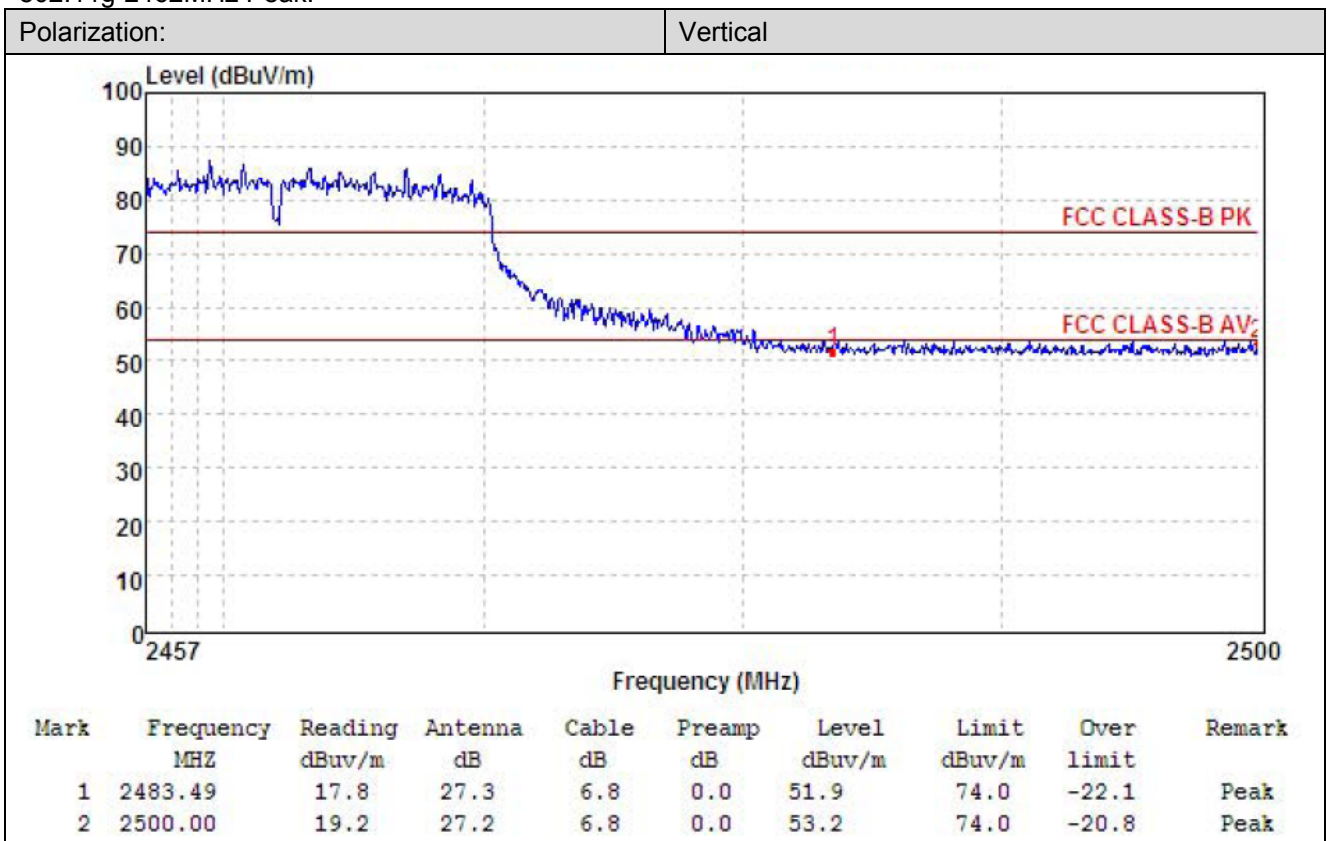
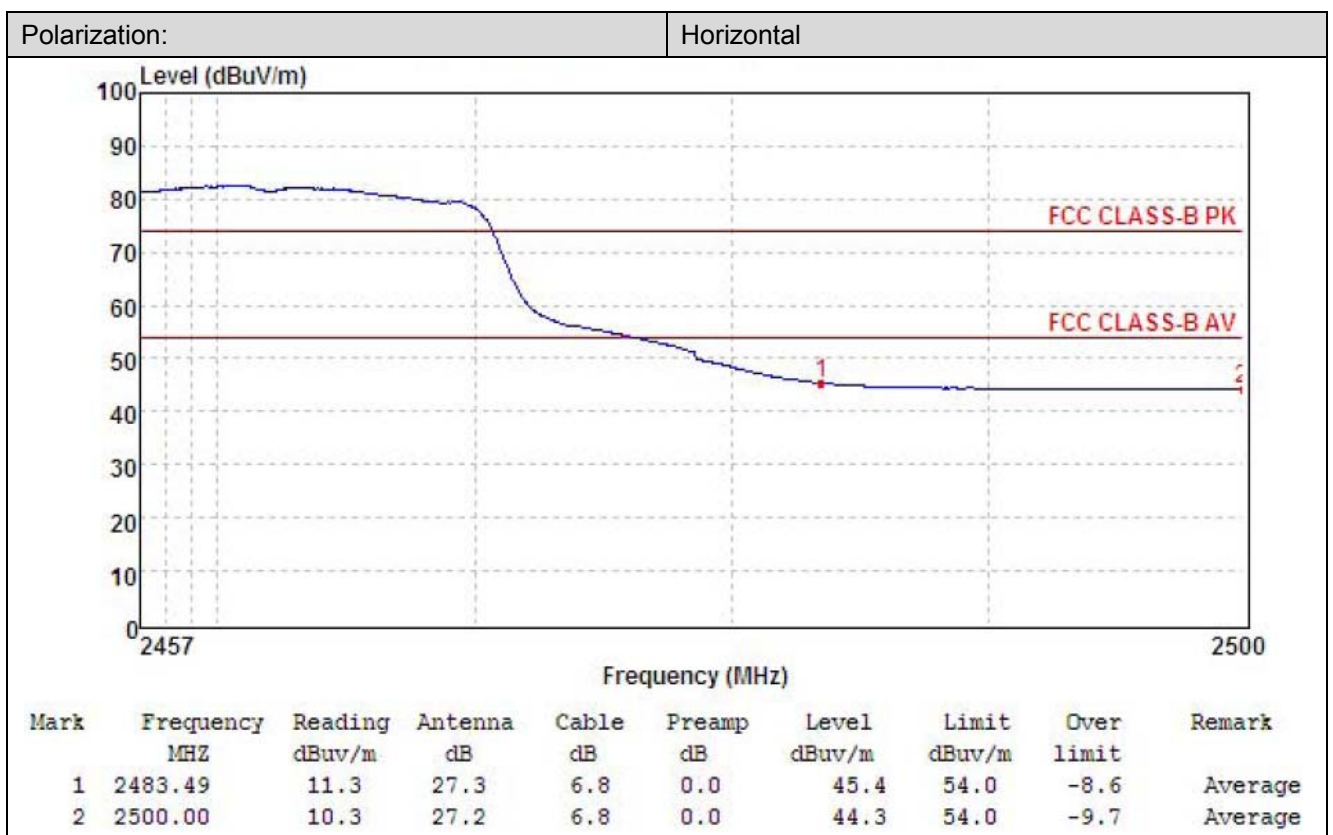
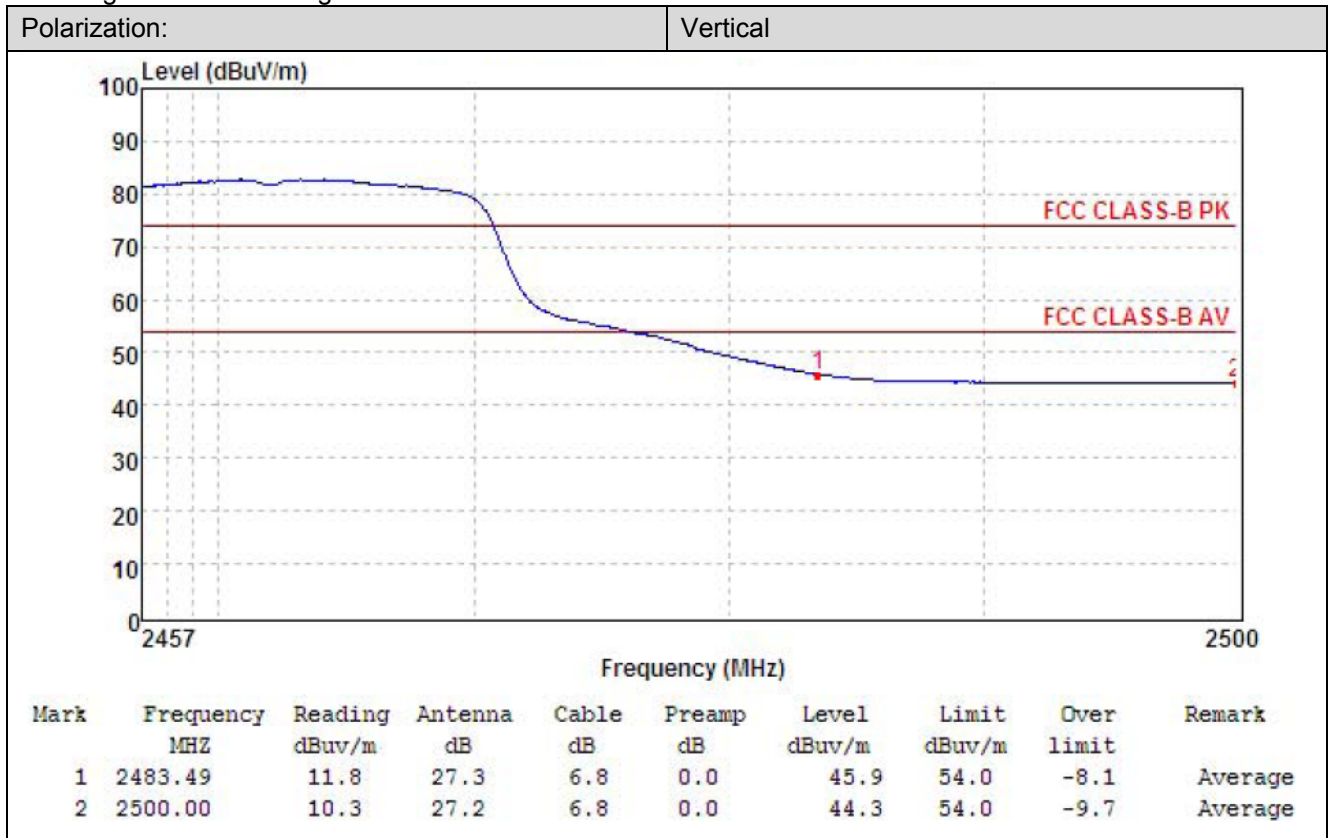

802.11n(HT20)-2412MHz Peak:

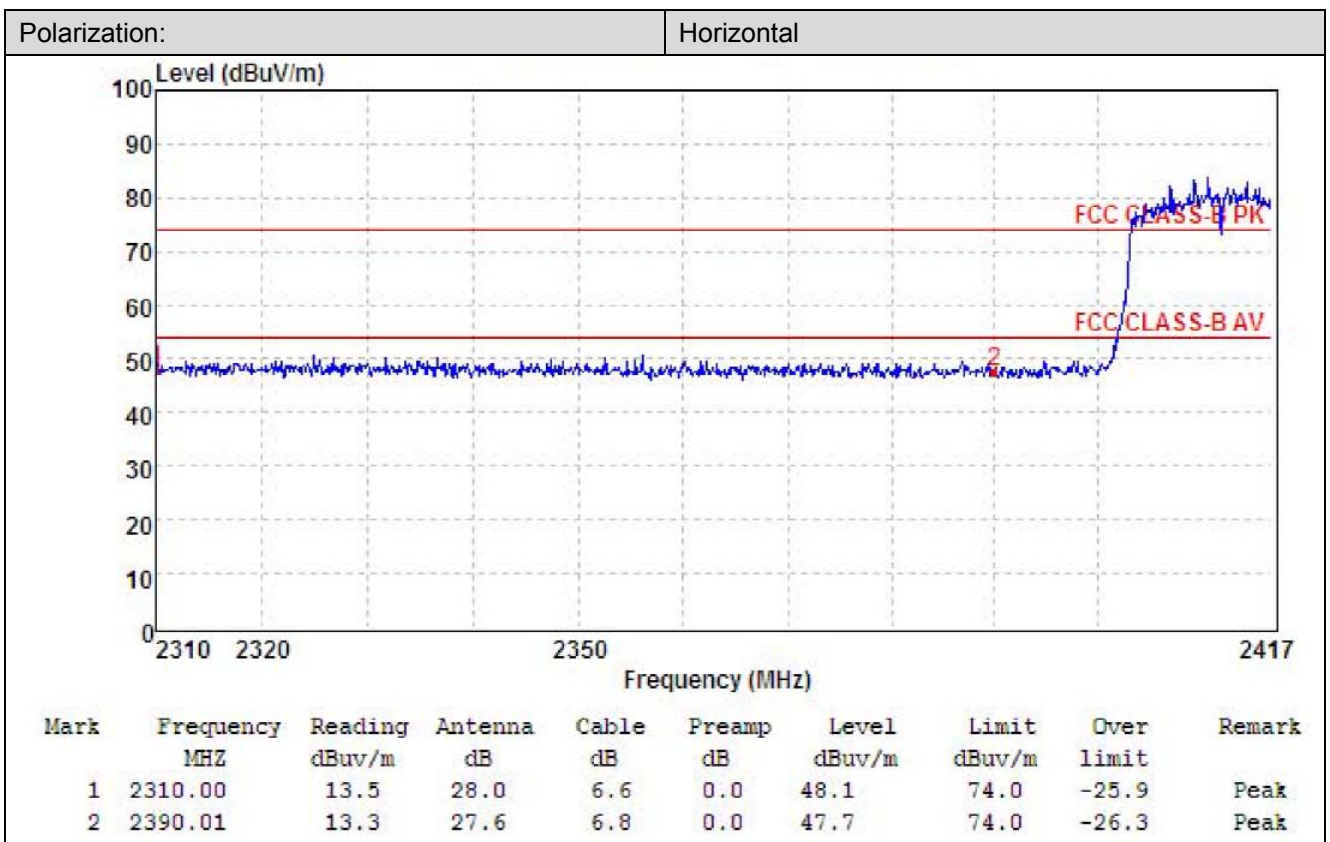
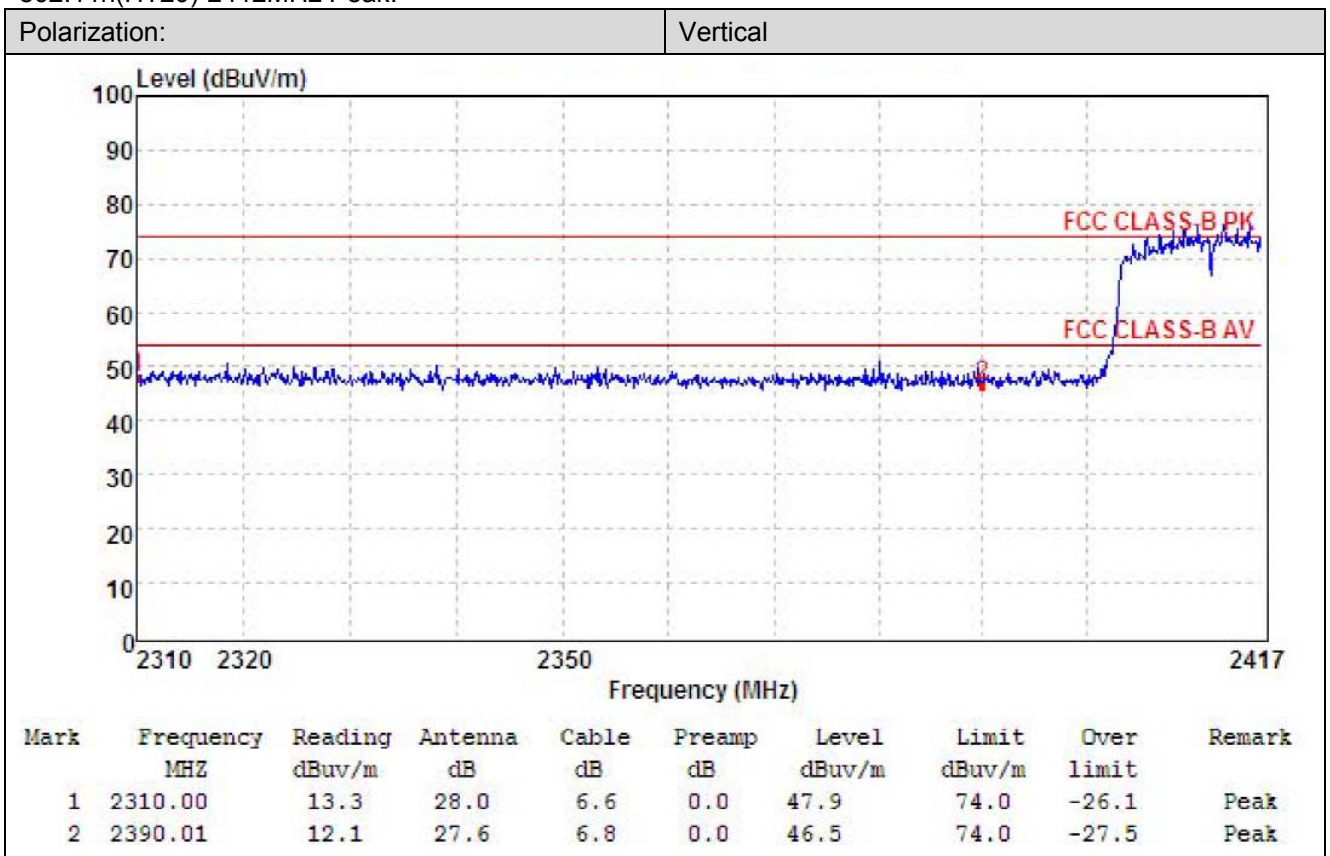

802.11n(HT20)-2412MHz Average:

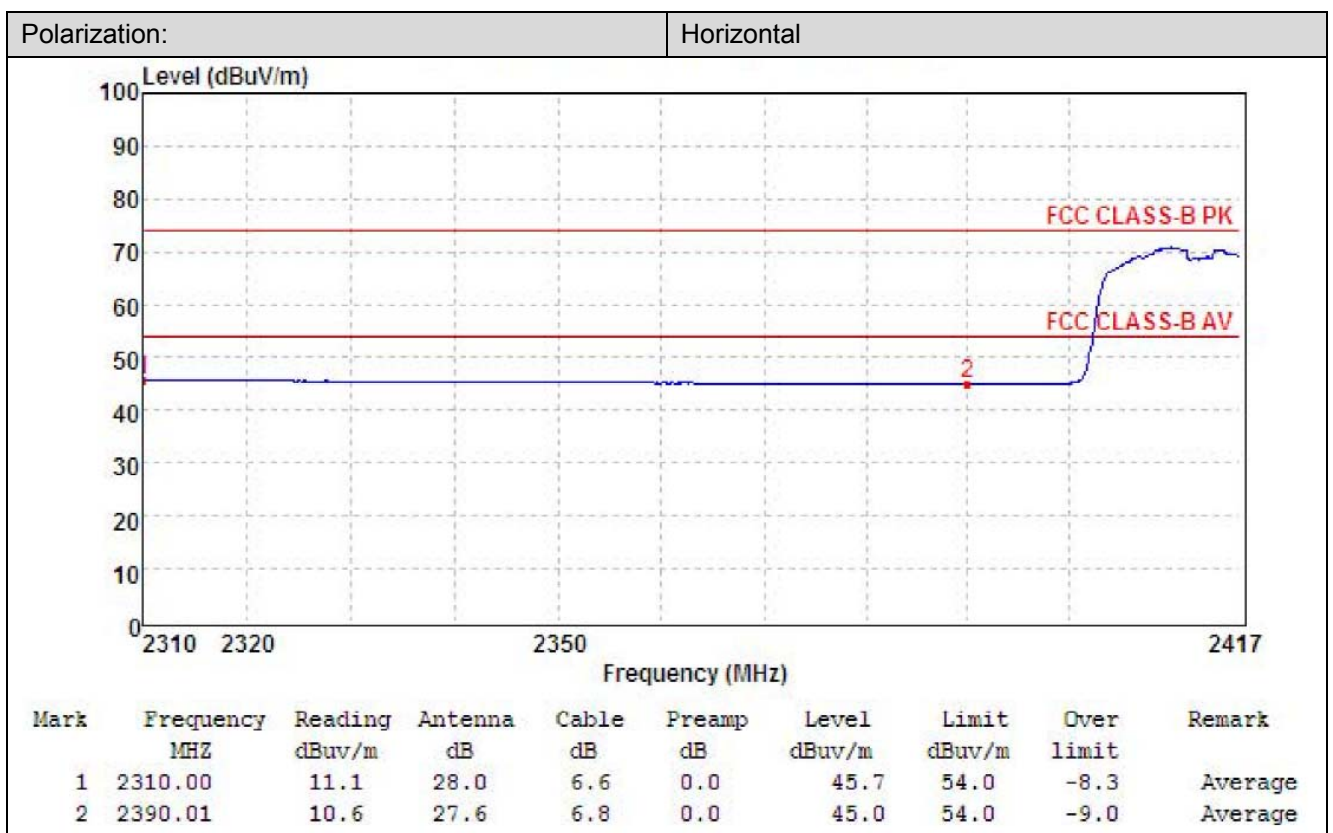
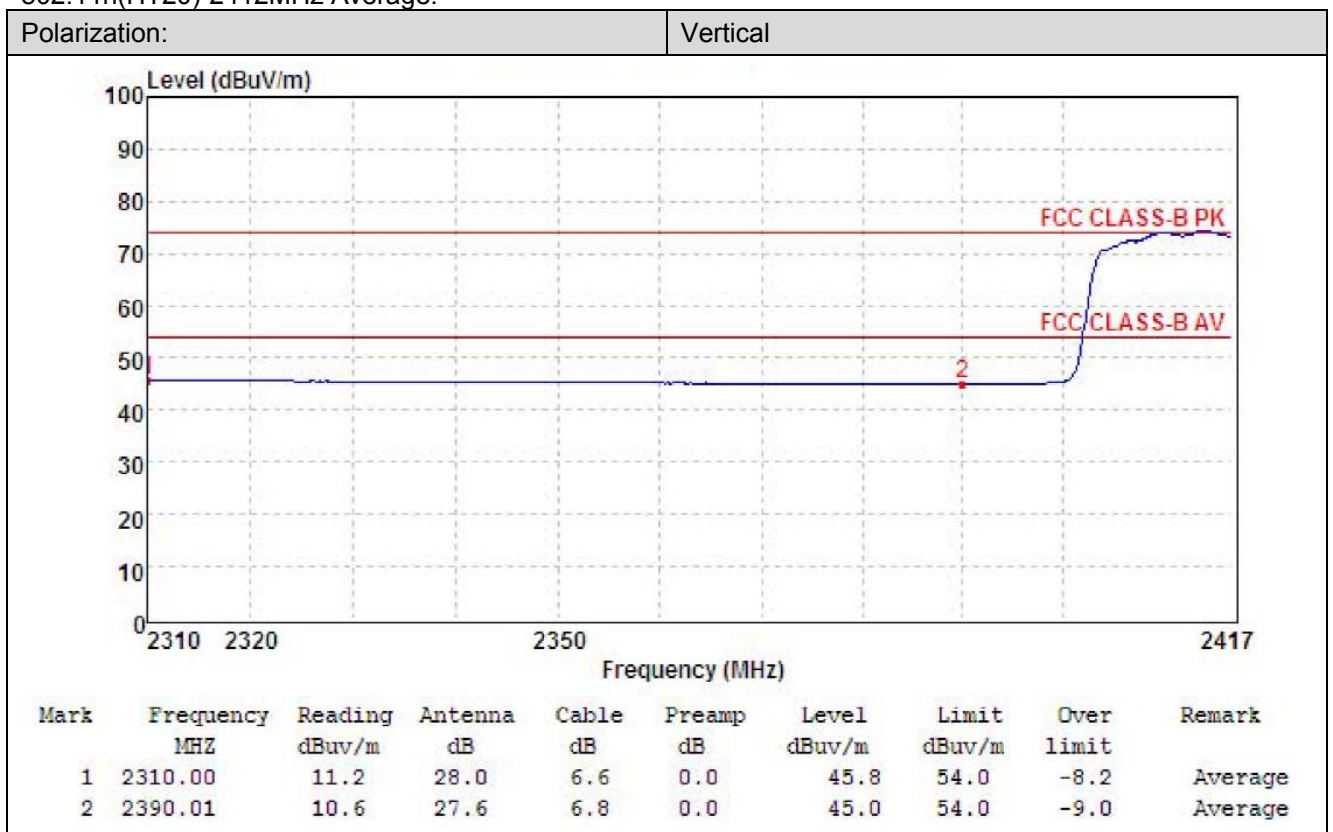

802.11n(HT20)-2462MHz Peak:

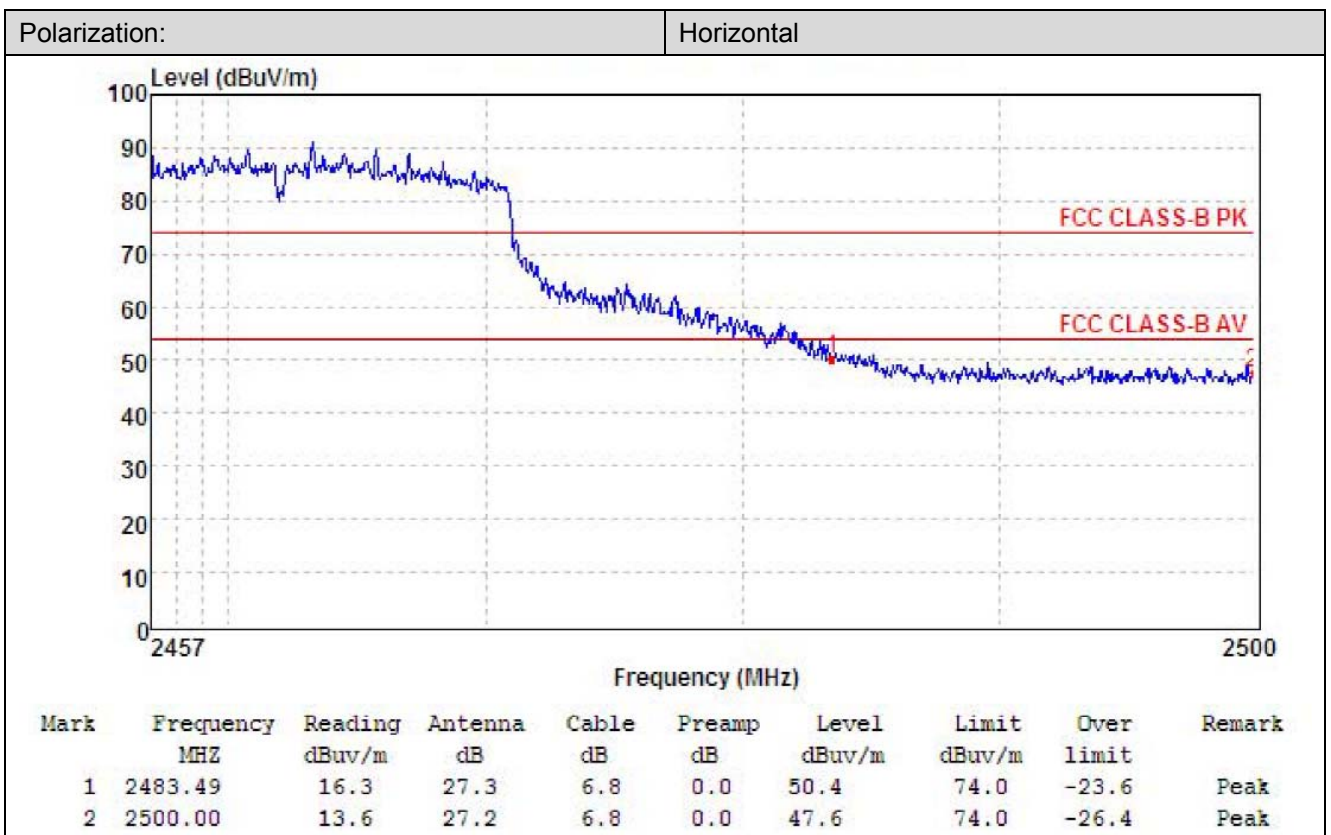
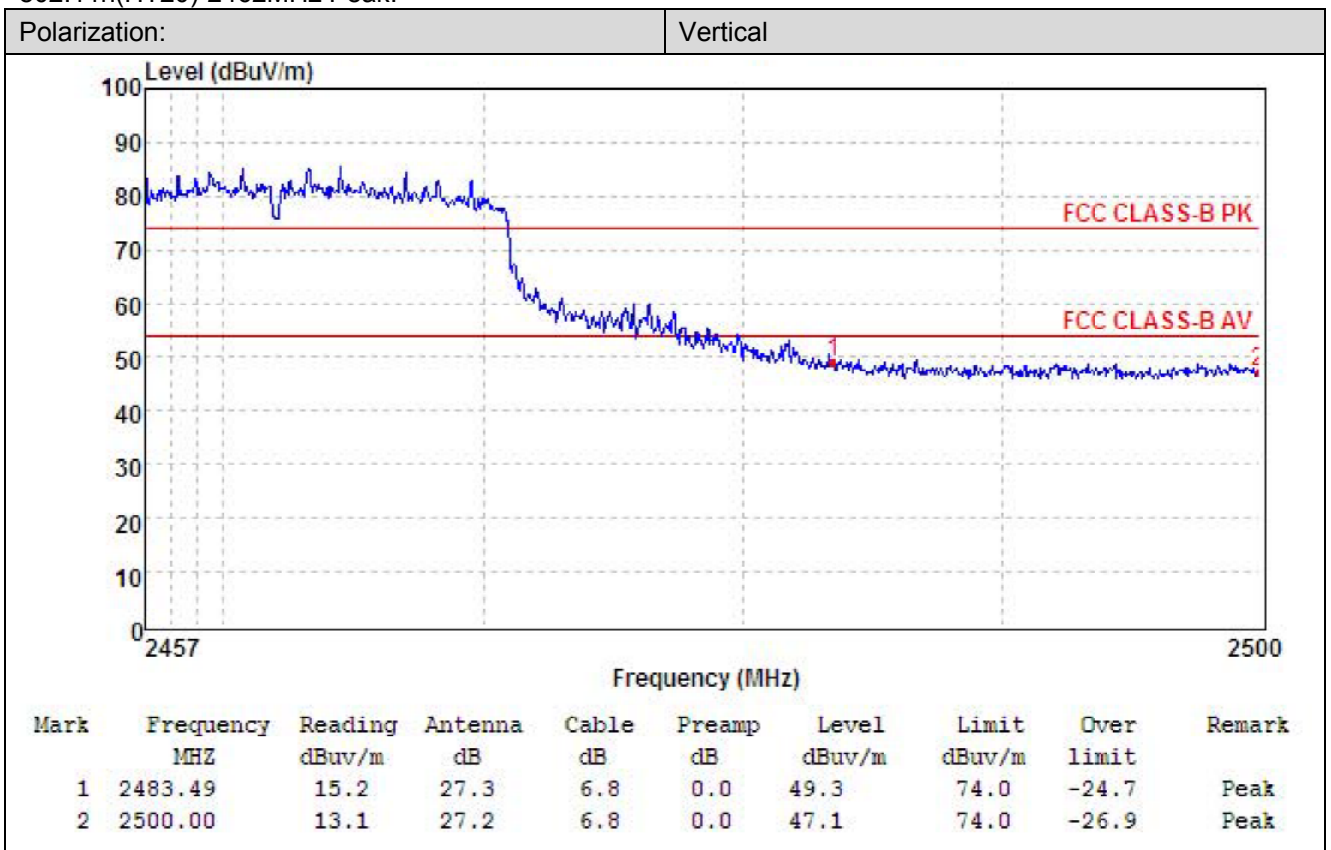

802.11n(HT20)-2462MHz Average:

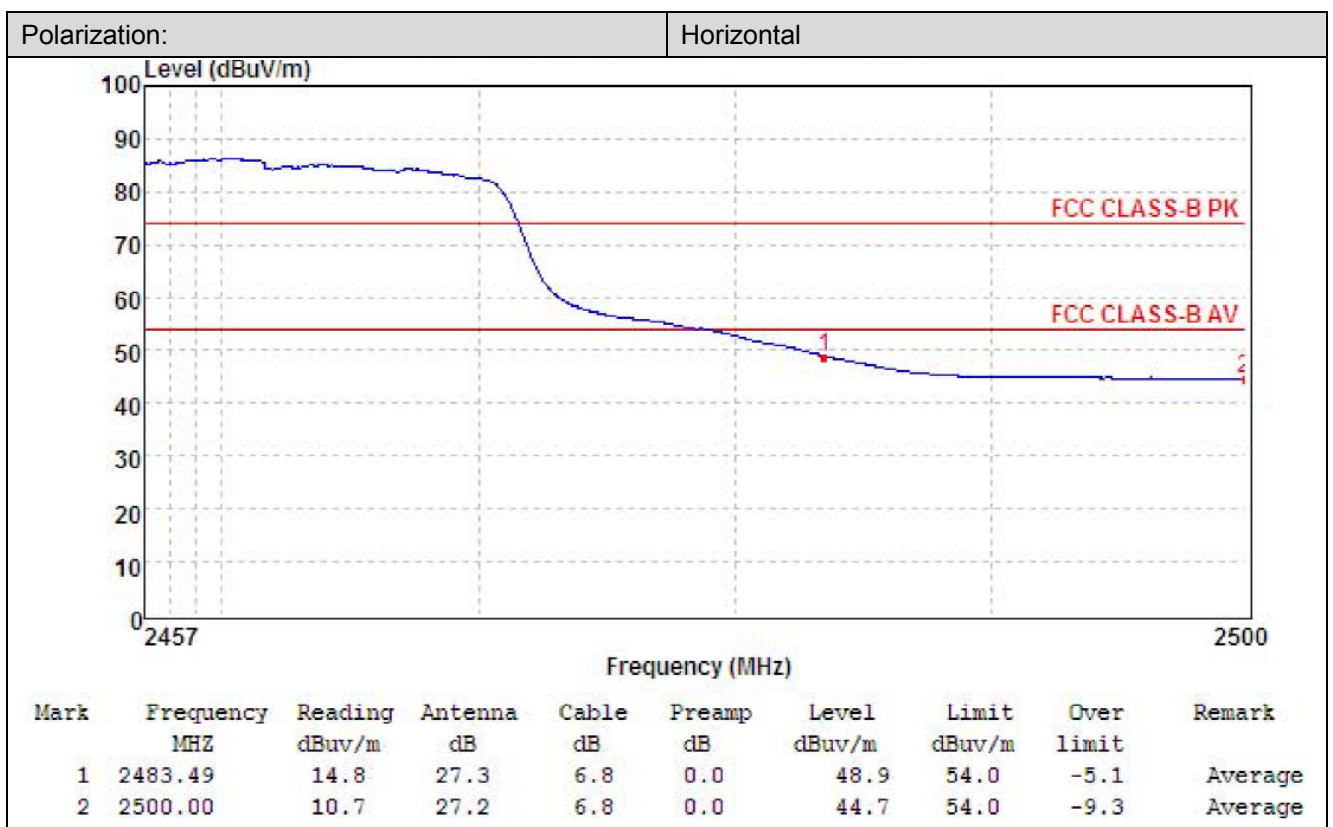
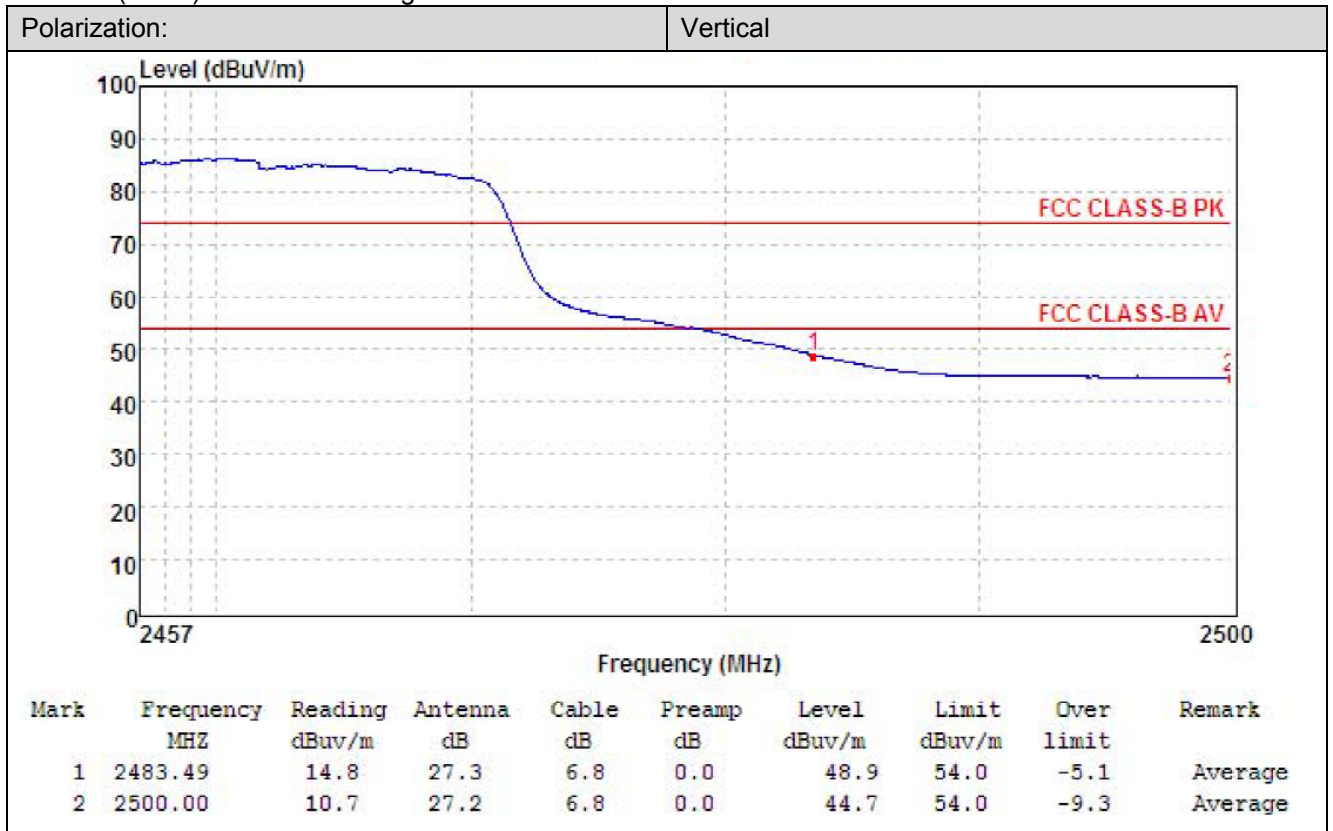

5.7. Band edge and Spurious Emissions (conducted)

LIMIT

FCC CFR Title 47 Part 15 Subpart C Section 15.247 (d):

In any 100 kHz bandwidth outside the frequency band in which the spread spectrum intentional radiator is operating, the radio frequency power that is produced by the intentional radiator shall be at least 20 dB below that in the 100 kHz bandwidth within the band that contains the highest level of the desired power, based on either an RF conducted or a radiated measurement.

TEST CONFIGURATION

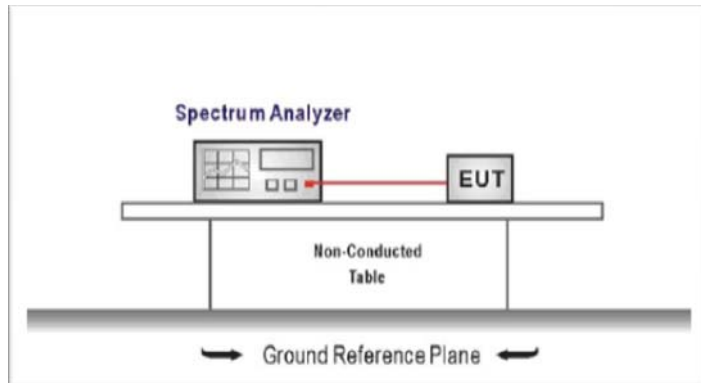

TEST PROCEDURE

1. Connect the antenna port(s) to the spectrum analyzer input.
2. Establish a reference level by using the following procedure
Center frequency=DTS channel center frequency
The span = 1.5 times the DTS bandwidth.
RBW = 100 kHz, VBW $\geq 3 \times$ RBW
Detector = peak, Sweep time = auto couple, Trace mode = max hold
Allow trace to fully stabilize
Use the peak marker function to determine the maximum PSD level



Note: the channel found to contain the maximum PSD level can be used to establish the reference level.
3. Emission level measurement
Set the center frequency and span to encompass frequency range to be measured
RBW = 100 kHz, VBW $\geq 3 \times$ RBW
Detector = peak, Sweep time = auto couple, Trace mode = max hold
Allow trace to fully stabilize
Use the peak marker function to determine the maximum amplitude level.
4. Place the radio in continuous transmit mode, allow the trace to stabilize, view the transmitter waveform on the spectrum analyzer.
5. Ensure that the amplitude of all unwanted emission outside of the authorized frequency band excluding restricted frequency bands) are attenuated by at least the minimum requirements specified (at least 20 dB relative to the maximum in-band peak PSD level in 100 kHz). Report the three highest emission relative to the limit.

TEST MODE:

Please refer to the clause 3.3

TEST RESULTS

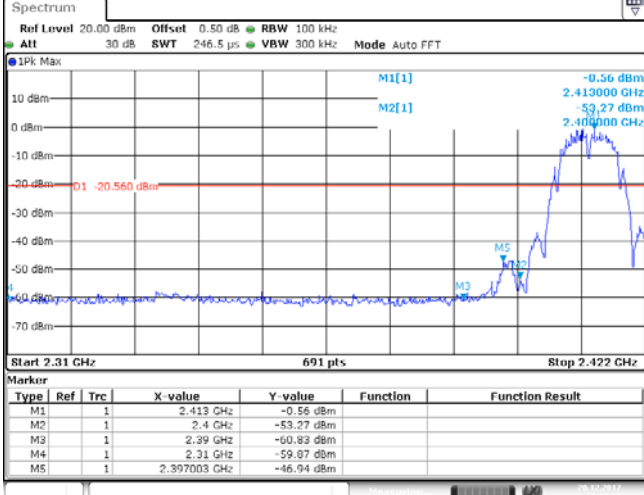
Passed Not Applicable

Test Item:	Bandedge	Type:	802.11 b																																										
CH01	 <p>Spectrum Ref Level 20.00 dBm Offset 0.50 dB RBW 100 kHz Att 30 dB SWT 246.5 μs VBW 300 kHz Mode Auto FFT</p> <p>1Pk Max</p> <p>M1[1] -0.56 dBm 2.413000 GHz M2[1] -53.27 dBm 2.400000 GHz</p> <p>D1 -20.560 dBm</p> <p>M3 M4 M5</p> <p>Start 2.31 GHz 691 pts Stop 2.422 GHz</p> <table border="1"> <thead> <tr> <th>Type</th> <th>Ref</th> <th>Trc</th> <th>X-value</th> <th>Y-value</th> <th>Function</th> <th>Function Result</th> </tr> </thead> <tbody> <tr> <td>M1</td> <td>1</td> <td></td> <td>2.413 GHz</td> <td>-0.56 dBm</td> <td></td> <td></td> </tr> <tr> <td>M2</td> <td>1</td> <td></td> <td>2.4 GHz</td> <td>-53.27 dBm</td> <td></td> <td></td> </tr> <tr> <td>M3</td> <td>1</td> <td></td> <td>2.39 GHz</td> <td>-60.83 dBm</td> <td></td> <td></td> </tr> <tr> <td>M4</td> <td>1</td> <td></td> <td>2.31 GHz</td> <td>-59.87 dBm</td> <td></td> <td></td> </tr> <tr> <td>M5</td> <td>1</td> <td></td> <td>2.397003 GHz</td> <td>-46.94 dBm</td> <td></td> <td></td> </tr> </tbody> </table>			Type	Ref	Trc	X-value	Y-value	Function	Function Result	M1	1		2.413 GHz	-0.56 dBm			M2	1		2.4 GHz	-53.27 dBm			M3	1		2.39 GHz	-60.83 dBm			M4	1		2.31 GHz	-59.87 dBm			M5	1		2.397003 GHz	-46.94 dBm		
Type	Ref	Trc	X-value	Y-value	Function	Function Result																																							
M1	1		2.413 GHz	-0.56 dBm																																									
M2	1		2.4 GHz	-53.27 dBm																																									
M3	1		2.39 GHz	-60.83 dBm																																									
M4	1		2.31 GHz	-59.87 dBm																																									
M5	1		2.397003 GHz	-46.94 dBm																																									
CH11	 <p>Spectrum Ref Level 20.00 dBm Offset 0.50 dB RBW 100 kHz Att 30 dB SWT 113.8 μs VBW 300 kHz Mode Auto FFT</p> <p>1Pk Max</p> <p>M1[1] -0.24 dBm 2.4630100 GHz M2[1] -59.17 dBm 2.4835000 GHz</p> <p>D1 -21.620 dBm</p> <p>M3 M4</p> <p>Start 2.452 GHz 691 pts Stop 2.5 GHz</p> <table border="1"> <thead> <tr> <th>Type</th> <th>Ref</th> <th>Trc</th> <th>X-value</th> <th>Y-value</th> <th>Function</th> <th>Function Result</th> </tr> </thead> <tbody> <tr> <td>M1</td> <td>1</td> <td></td> <td>2.46301 GHz</td> <td>-0.24 dBm</td> <td></td> <td></td> </tr> <tr> <td>M2</td> <td>1</td> <td></td> <td>2.4635 GHz</td> <td>-59.17 dBm</td> <td></td> <td></td> </tr> <tr> <td>M3</td> <td>1</td> <td></td> <td>2.5 GHz</td> <td>-60.27 dBm</td> <td></td> <td></td> </tr> <tr> <td>M4</td> <td>1</td> <td></td> <td>2.496313 GHz</td> <td>-58.57 dBm</td> <td></td> <td></td> </tr> </tbody> </table>			Type	Ref	Trc	X-value	Y-value	Function	Function Result	M1	1		2.46301 GHz	-0.24 dBm			M2	1		2.4635 GHz	-59.17 dBm			M3	1		2.5 GHz	-60.27 dBm			M4	1		2.496313 GHz	-58.57 dBm									
Type	Ref	Trc	X-value	Y-value	Function	Function Result																																							
M1	1		2.46301 GHz	-0.24 dBm																																									
M2	1		2.4635 GHz	-59.17 dBm																																									
M3	1		2.5 GHz	-60.27 dBm																																									
M4	1		2.496313 GHz	-58.57 dBm																																									

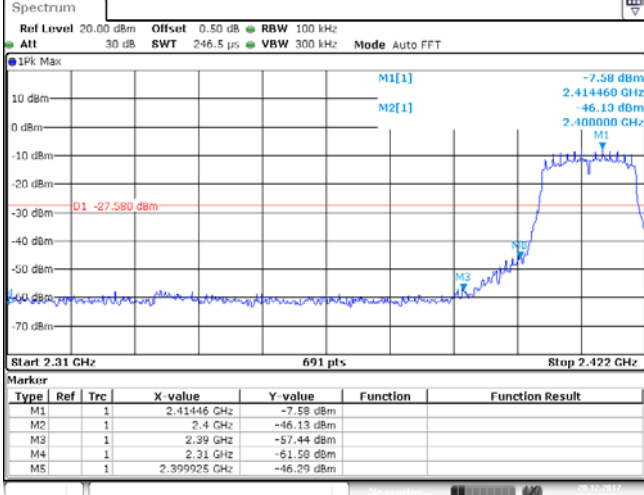
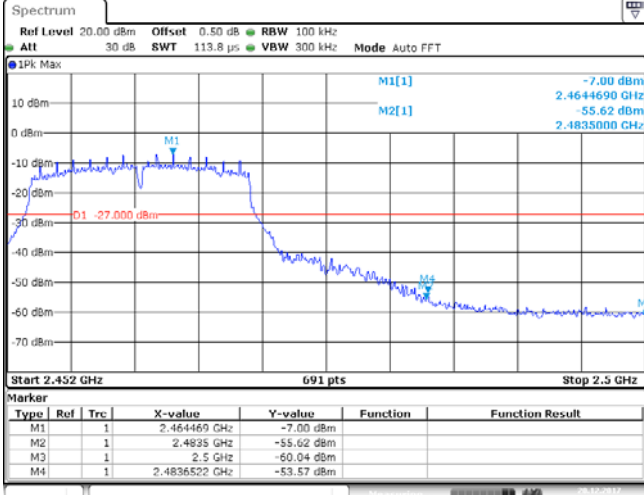
Test Item:	Bandedge	Type:	802.11 g																																										
CH01	 <p>Spectrum Ref Level 20.00 dBm Offset 0.50 dB RBW 100 kHz Att 30 dB SWT 246.5 μs VBW 300 kHz Mode Auto FFT</p> <p>1Pk Max</p> <p>M1[1] -7.58 dBm 2.414460 GHz M2[1] -46.13 dBm 2.400000 GHz M3 M4 M5</p> <p>O1 -27.580 dBm</p> <p>Start 2.31 GHz 691 pts Stop 2.422 GHz</p> <table border="1"> <thead> <tr> <th>Type</th> <th>Ref</th> <th>Trc</th> <th>X-value</th> <th>Y-value</th> <th>Function</th> <th>Function Result</th> </tr> </thead> <tbody> <tr> <td>M1</td> <td>1</td> <td></td> <td>2.41446 GHz</td> <td>-7.58 dBm</td> <td></td> <td></td> </tr> <tr> <td>M2</td> <td>1</td> <td></td> <td>2.4 GHz</td> <td>-46.13 dBm</td> <td></td> <td></td> </tr> <tr> <td>M3</td> <td>1</td> <td></td> <td>2.39 GHz</td> <td>-57.44 dBm</td> <td></td> <td></td> </tr> <tr> <td>M4</td> <td>1</td> <td></td> <td>2.31 GHz</td> <td>-61.59 dBm</td> <td></td> <td></td> </tr> <tr> <td>M5</td> <td>1</td> <td></td> <td>2.399925 GHz</td> <td>-46.29 dBm</td> <td></td> <td></td> </tr> </tbody> </table>			Type	Ref	Trc	X-value	Y-value	Function	Function Result	M1	1		2.41446 GHz	-7.58 dBm			M2	1		2.4 GHz	-46.13 dBm			M3	1		2.39 GHz	-57.44 dBm			M4	1		2.31 GHz	-61.59 dBm			M5	1		2.399925 GHz	-46.29 dBm		
Type	Ref	Trc	X-value	Y-value	Function	Function Result																																							
M1	1		2.41446 GHz	-7.58 dBm																																									
M2	1		2.4 GHz	-46.13 dBm																																									
M3	1		2.39 GHz	-57.44 dBm																																									
M4	1		2.31 GHz	-61.59 dBm																																									
M5	1		2.399925 GHz	-46.29 dBm																																									
CH11	 <p>Spectrum Ref Level 20.00 dBm Offset 0.50 dB RBW 100 kHz Att 30 dB SWT 113.8 μs VBW 300 kHz Mode Auto FFT</p> <p>1Pk Max</p> <p>M1[1] -7.00 dBm 2.4644690 GHz M2[1] -55.62 dBm 2.4835000 GHz M3 M4</p> <p>O1 -27.000 dBm</p> <p>Start 2.452 GHz 691 pts Stop 2.5 GHz</p> <table border="1"> <thead> <tr> <th>Type</th> <th>Ref</th> <th>Trc</th> <th>X-value</th> <th>Y-value</th> <th>Function</th> <th>Function Result</th> </tr> </thead> <tbody> <tr> <td>M1</td> <td>1</td> <td></td> <td>2.464469 GHz</td> <td>-7.00 dBm</td> <td></td> <td></td> </tr> <tr> <td>M2</td> <td>1</td> <td></td> <td>2.4693 GHz</td> <td>-55.62 dBm</td> <td></td> <td></td> </tr> <tr> <td>M3</td> <td>1</td> <td></td> <td>2.5 GHz</td> <td>-60.04 dBm</td> <td></td> <td></td> </tr> <tr> <td>M4</td> <td>1</td> <td></td> <td>2.483522 GHz</td> <td>-53.57 dBm</td> <td></td> <td></td> </tr> </tbody> </table>			Type	Ref	Trc	X-value	Y-value	Function	Function Result	M1	1		2.464469 GHz	-7.00 dBm			M2	1		2.4693 GHz	-55.62 dBm			M3	1		2.5 GHz	-60.04 dBm			M4	1		2.483522 GHz	-53.57 dBm									
Type	Ref	Trc	X-value	Y-value	Function	Function Result																																							
M1	1		2.464469 GHz	-7.00 dBm																																									
M2	1		2.4693 GHz	-55.62 dBm																																									
M3	1		2.5 GHz	-60.04 dBm																																									
M4	1		2.483522 GHz	-53.57 dBm																																									

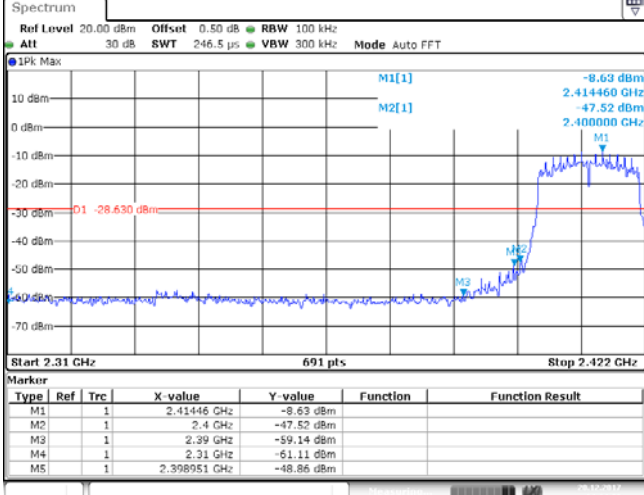
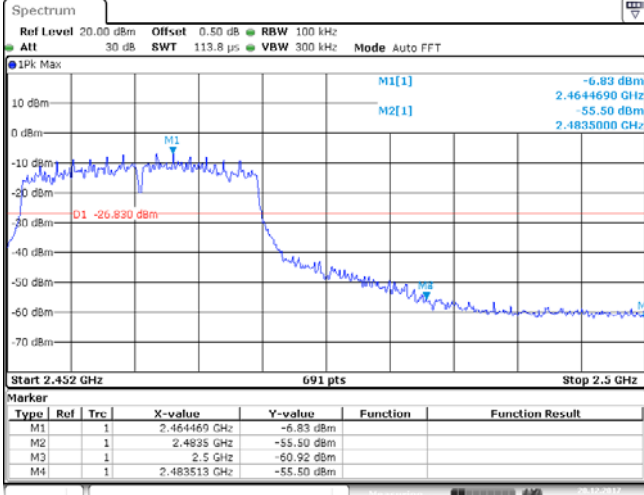
Test Item:	Bandedge	Type:	802.11 n(HT20)																																										
CH01	 <p>Spectrum Ref Level 20.00 dBm Offset 0.50 dB RBW 100 kHz Att 30 dB SWT 246.5 μs VBW 300 kHz Mode Auto FFT</p> <p>1Pk Max</p> <p>M1[1] -8.63 dBm 2.414460 GHz M2[1] -47.52 dBm 2.400000 GHz</p> <p>D1 -28.630 dBm</p> <p>Start 2.31 GHz 691 pts Stop 2.422 GHz</p> <table border="1"> <thead> <tr> <th>Type</th> <th>Ref</th> <th>Trc</th> <th>X-value</th> <th>Y-value</th> <th>Function</th> <th>Function Result</th> </tr> </thead> <tbody> <tr> <td>M1</td> <td>1</td> <td></td> <td>2.41446 GHz</td> <td>-8.63 dBm</td> <td></td> <td></td> </tr> <tr> <td>M2</td> <td>1</td> <td></td> <td>2.4 GHz</td> <td>-47.52 dBm</td> <td></td> <td></td> </tr> <tr> <td>M3</td> <td>1</td> <td></td> <td>2.39 GHz</td> <td>-59.14 dBm</td> <td></td> <td></td> </tr> <tr> <td>M4</td> <td>1</td> <td></td> <td>2.31 GHz</td> <td>-61.11 dBm</td> <td></td> <td></td> </tr> <tr> <td>M5</td> <td>1</td> <td></td> <td>2.398951 GHz</td> <td>-48.86 dBm</td> <td></td> <td></td> </tr> </tbody> </table>			Type	Ref	Trc	X-value	Y-value	Function	Function Result	M1	1		2.41446 GHz	-8.63 dBm			M2	1		2.4 GHz	-47.52 dBm			M3	1		2.39 GHz	-59.14 dBm			M4	1		2.31 GHz	-61.11 dBm			M5	1		2.398951 GHz	-48.86 dBm		
Type	Ref	Trc	X-value	Y-value	Function	Function Result																																							
M1	1		2.41446 GHz	-8.63 dBm																																									
M2	1		2.4 GHz	-47.52 dBm																																									
M3	1		2.39 GHz	-59.14 dBm																																									
M4	1		2.31 GHz	-61.11 dBm																																									
M5	1		2.398951 GHz	-48.86 dBm																																									
CH11	 <p>Spectrum Ref Level 20.00 dBm Offset 0.50 dB RBW 100 kHz Att 30 dB SWT 113.8 μs VBW 300 kHz Mode Auto FFT</p> <p>1Pk Max</p> <p>M1[1] -6.83 dBm 2.4644690 GHz M2[1] -55.50 dBm 2.4835000 GHz</p> <p>D1 -26.830 dBm</p> <p>Start 2.452 GHz 691 pts Stop 2.5 GHz</p> <table border="1"> <thead> <tr> <th>Type</th> <th>Ref</th> <th>Trc</th> <th>X-value</th> <th>Y-value</th> <th>Function</th> <th>Function Result</th> </tr> </thead> <tbody> <tr> <td>M1</td> <td>1</td> <td></td> <td>2.464469 GHz</td> <td>-6.83 dBm</td> <td></td> <td></td> </tr> <tr> <td>M2</td> <td>1</td> <td></td> <td>2.4699 GHz</td> <td>-55.50 dBm</td> <td></td> <td></td> </tr> <tr> <td>M3</td> <td>1</td> <td></td> <td>2.5 GHz</td> <td>-60.92 dBm</td> <td></td> <td></td> </tr> <tr> <td>M4</td> <td>1</td> <td></td> <td>2.483513 GHz</td> <td>-55.50 dBm</td> <td></td> <td></td> </tr> </tbody> </table>			Type	Ref	Trc	X-value	Y-value	Function	Function Result	M1	1		2.464469 GHz	-6.83 dBm			M2	1		2.4699 GHz	-55.50 dBm			M3	1		2.5 GHz	-60.92 dBm			M4	1		2.483513 GHz	-55.50 dBm									
Type	Ref	Trc	X-value	Y-value	Function	Function Result																																							
M1	1		2.464469 GHz	-6.83 dBm																																									
M2	1		2.4699 GHz	-55.50 dBm																																									
M3	1		2.5 GHz	-60.92 dBm																																									
M4	1		2.483513 GHz	-55.50 dBm																																									

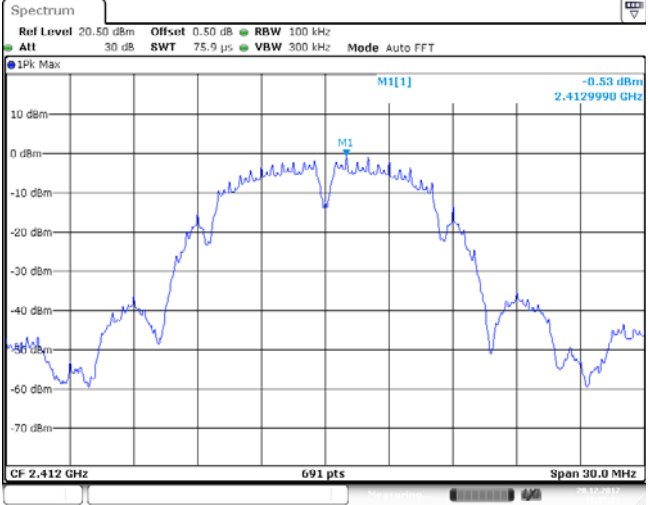
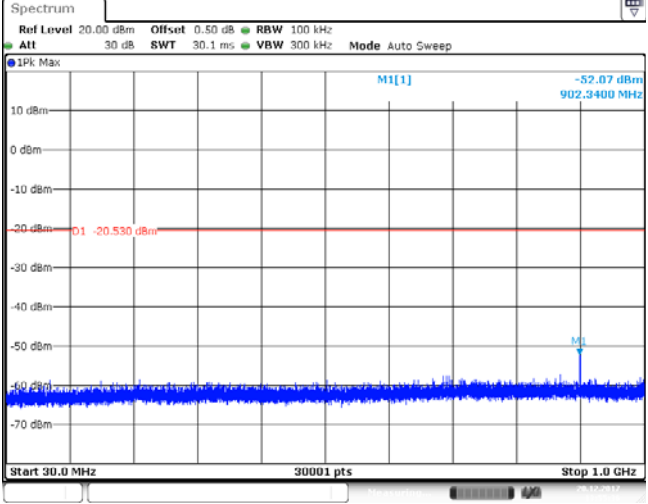
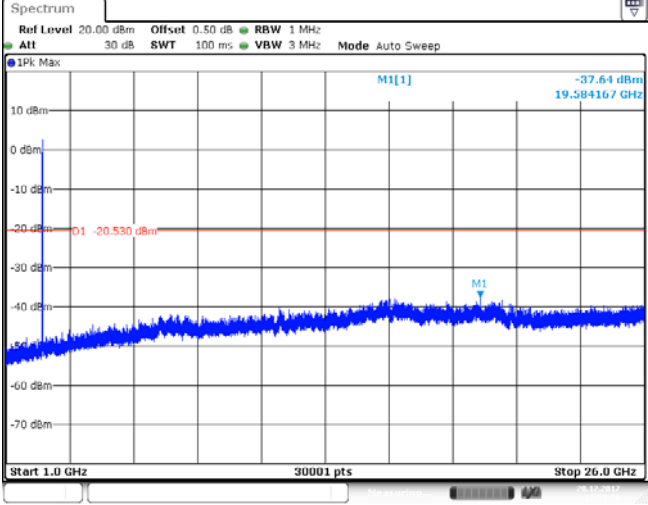
Test Item:	SE	Type:	802.11 b
Pref/11B/LCH			
Puw/11B/LCH			
			

Pref/11B/MCH

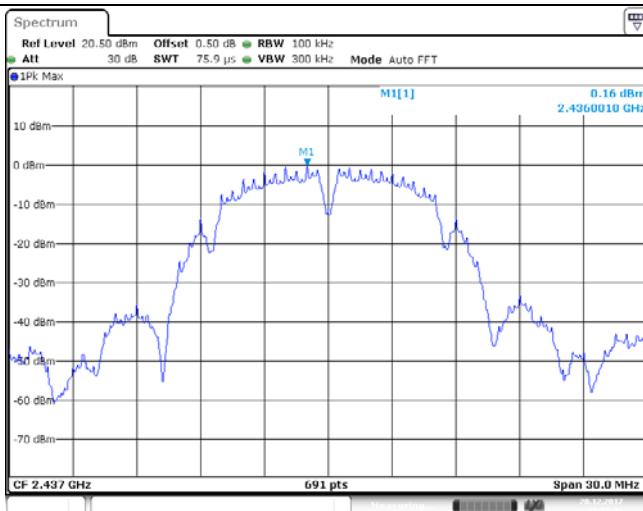

Puw/11B/MCH

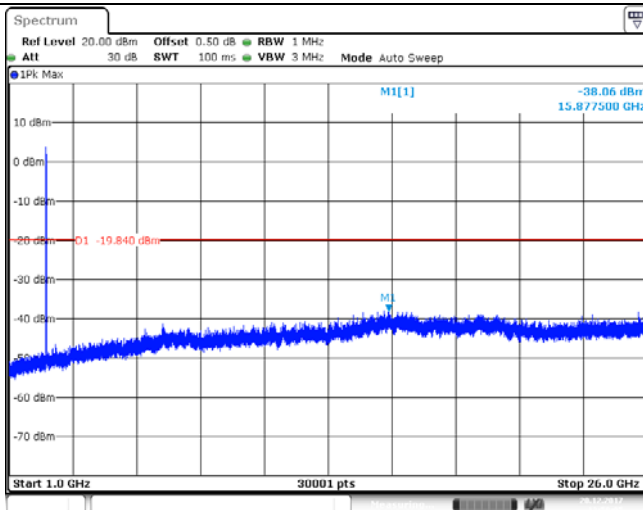
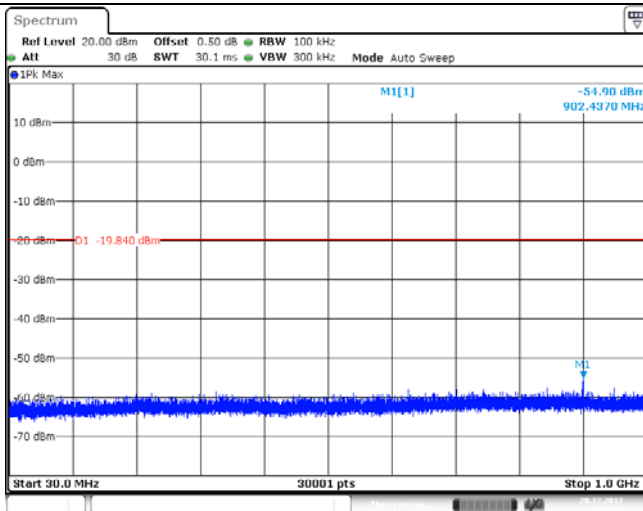

Pref/11B/HCH

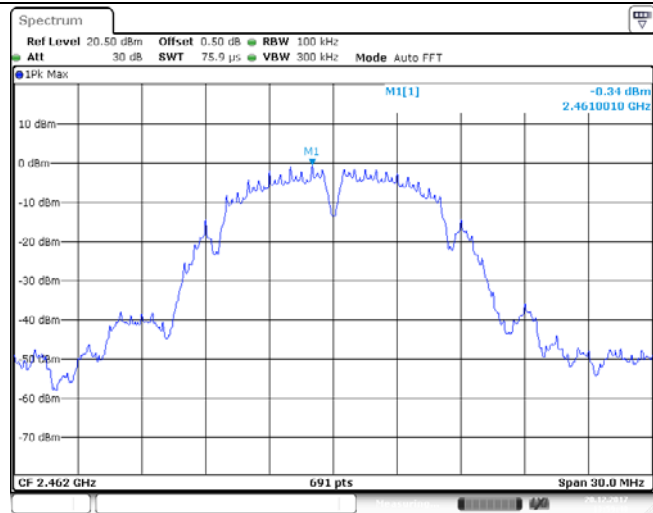

Puw/11B/HCH

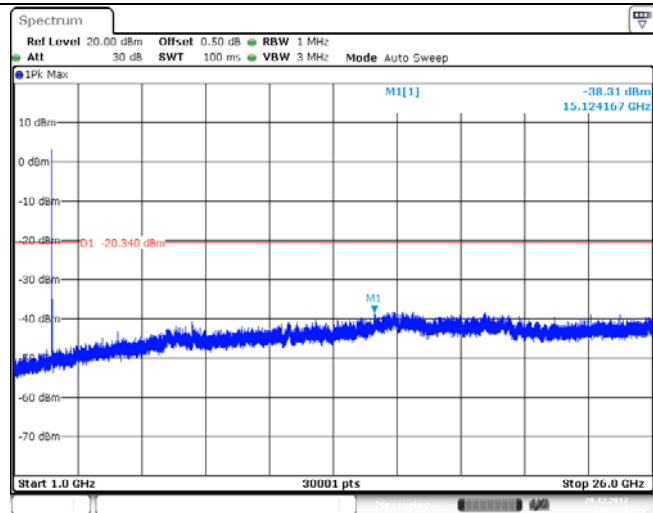
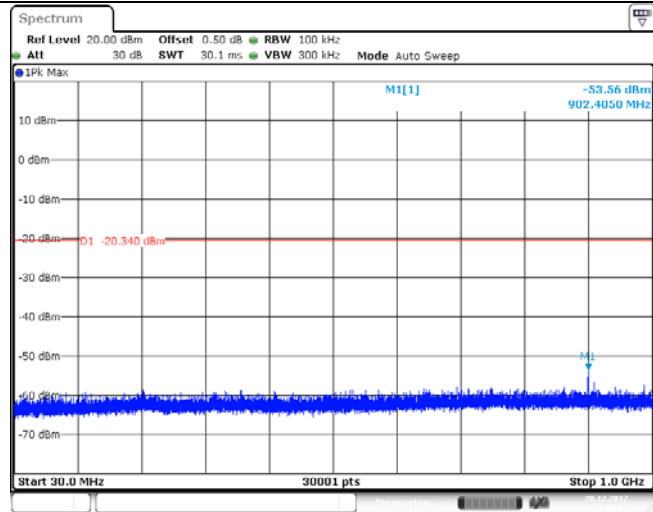

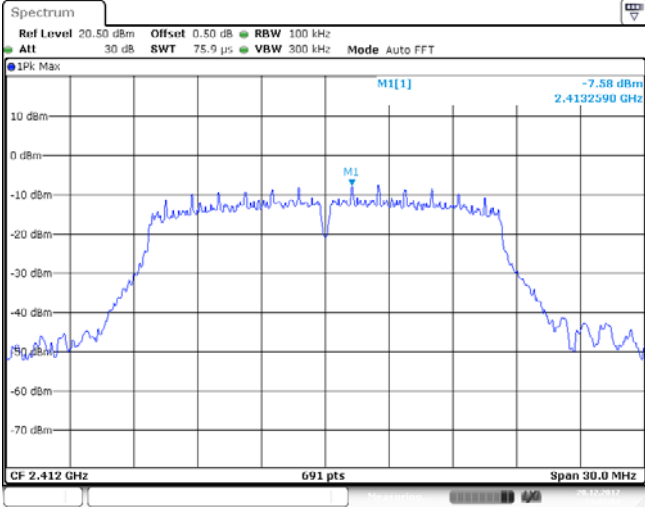
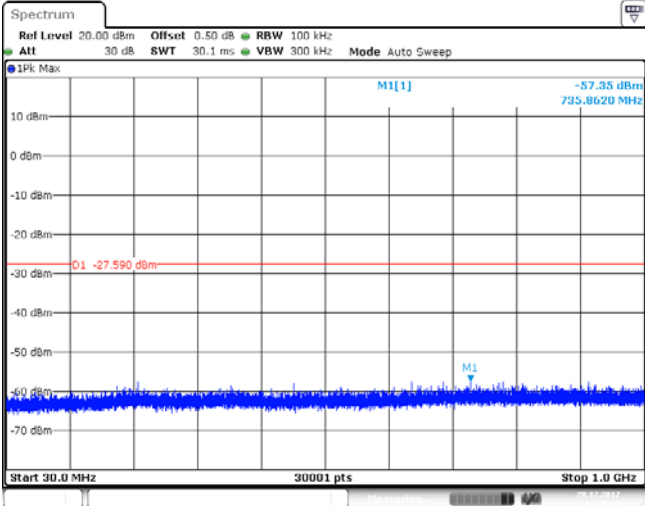
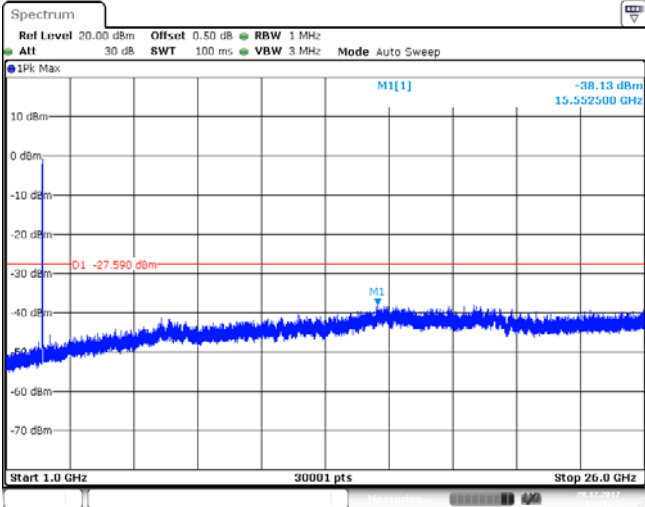
Test Item:	SE	Type:	802.11 g
Pref/11G/LCH			
Puw/11G/LCH			
			

Pref/11G/MCH

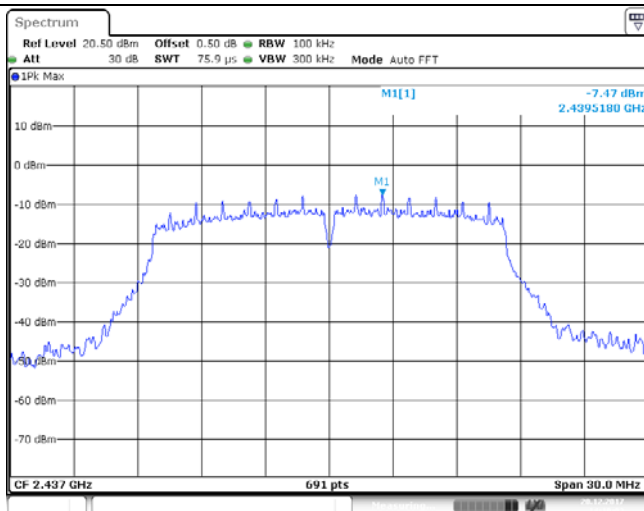

Puw/11G/MCH

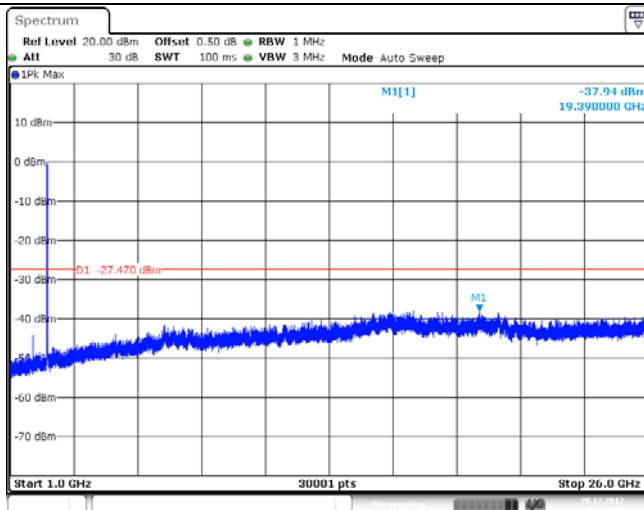
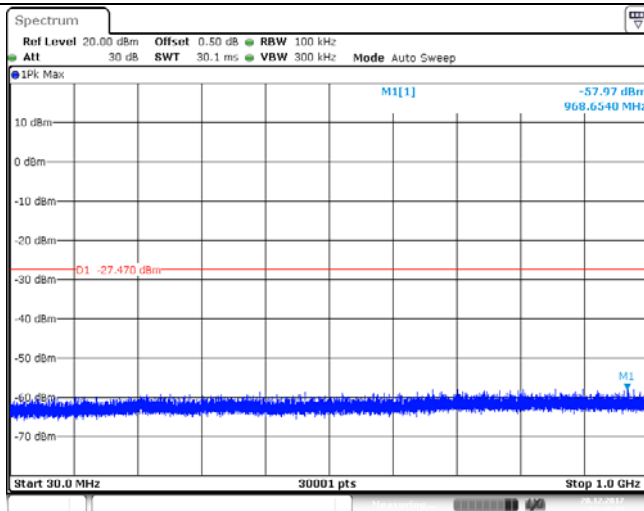

Pref/11G/HCH

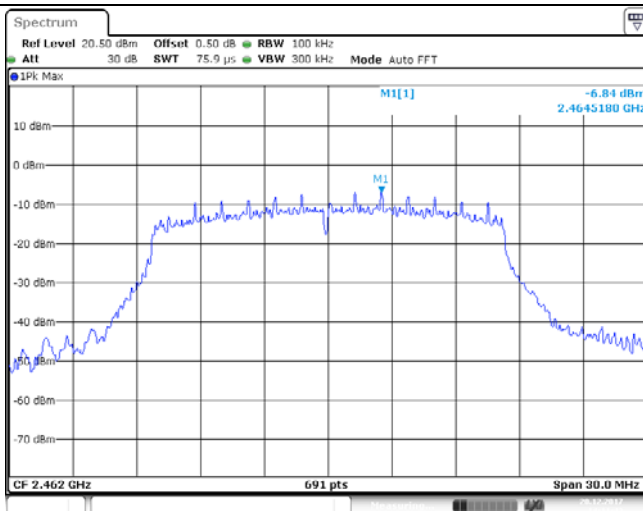

Puw/11G/HCH

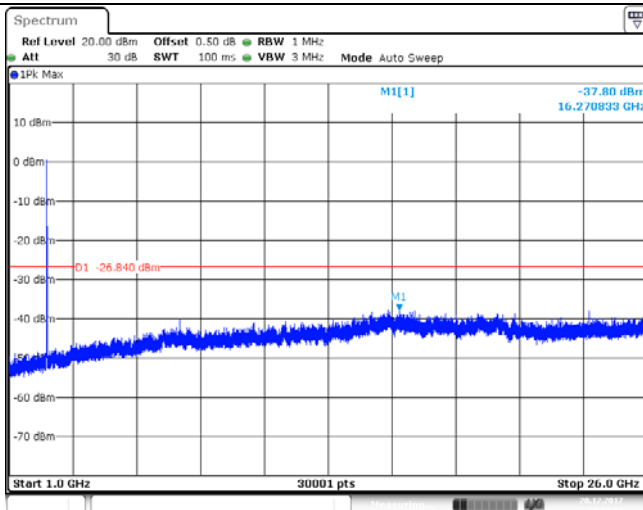
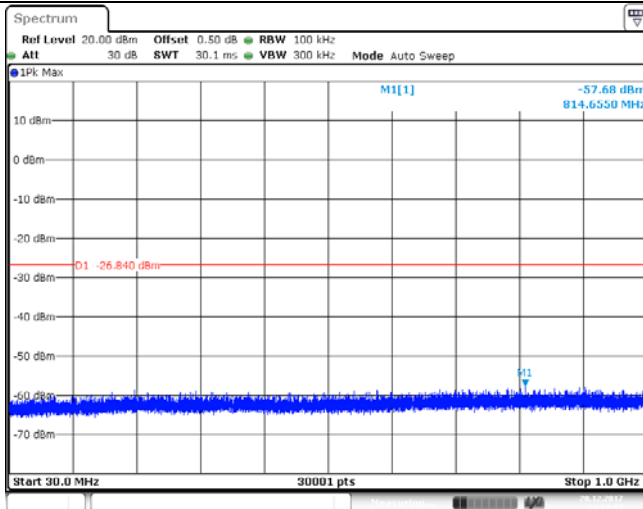

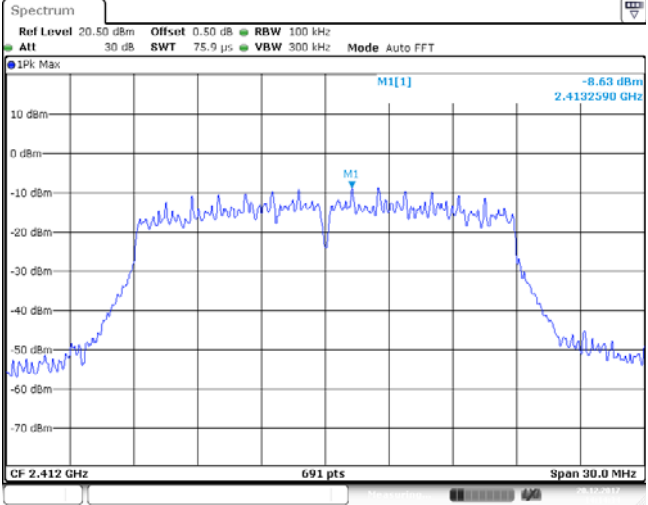
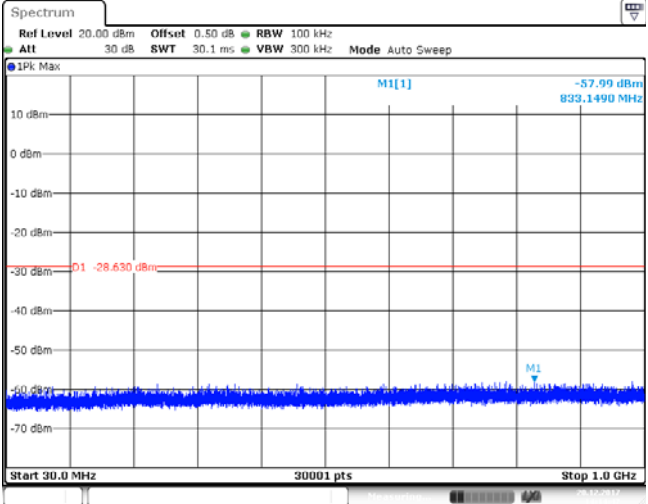
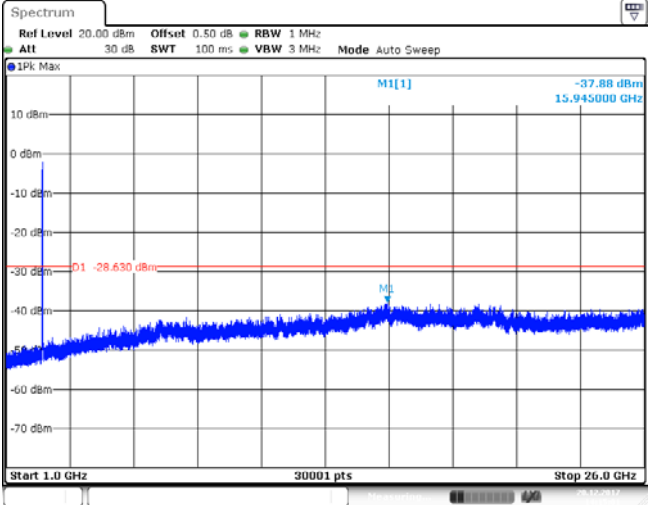
Test Item:	SE	Type:	802.11 n(HT20)
Pref/11n20/LCH			
Puw/11n20/LCH			
			

Pref/11n20/MCH

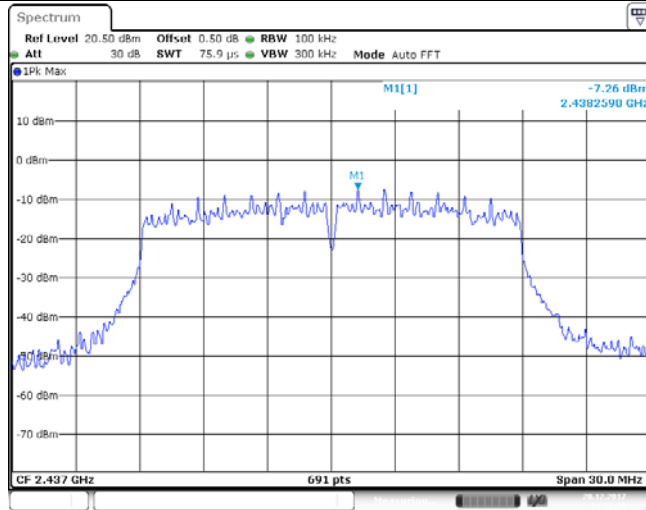

Puw/11n20/MCH

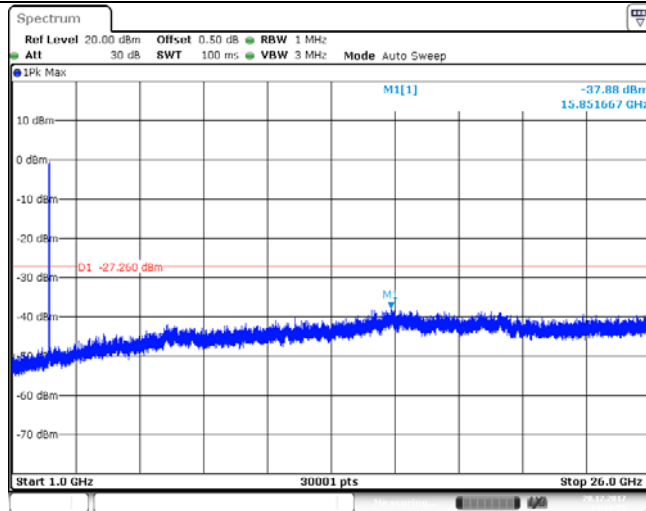
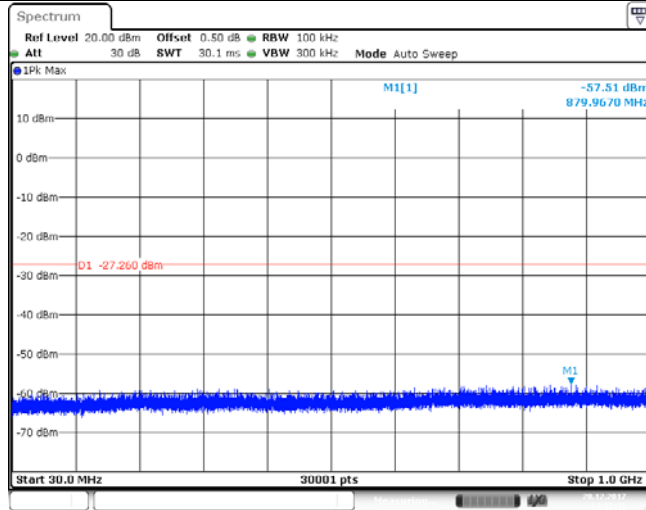

Pref/11n20/HCH

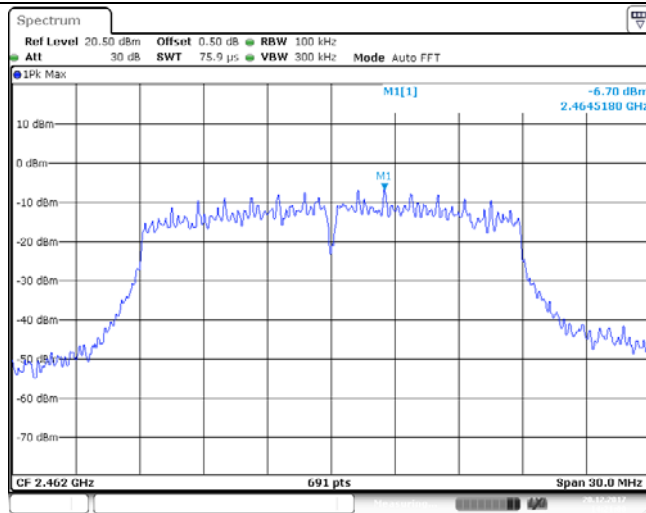

Puw/11n20/HCH

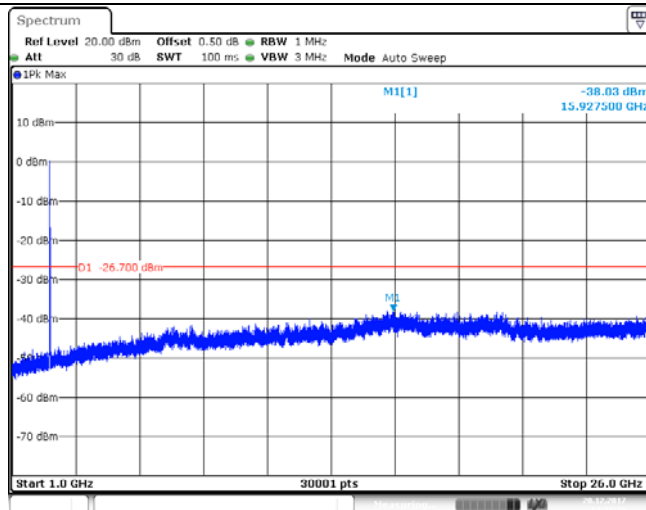
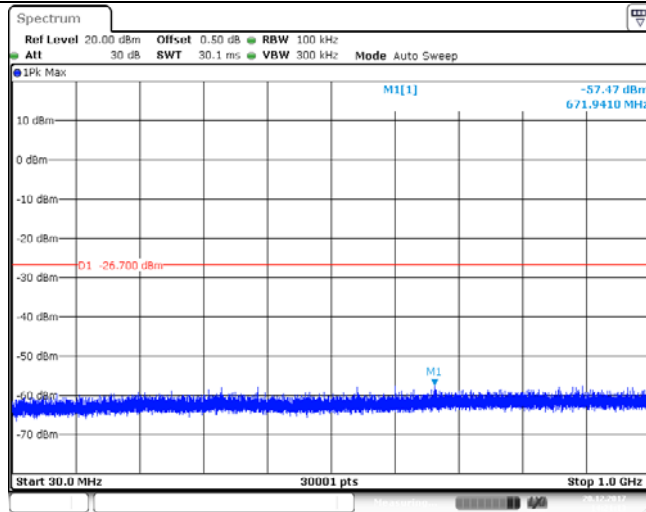

5.8. Spurious Emissions (radiated)

LIMIT

FCC CFR Title 47 Part 15 Subpart C Section 15.209

Frequency	Limit (dBuV/m @3m)	Value
30MHz-88MHz	40.00	Quasi-peak
88MHz-216MHz	43.50	Quasi-peak
216MHz-960MHz	46.00	Quasi-peak
960MHz-1GHz	54.00	Quasi-peak
Above 1GHz	54.00	Average
	74.00	Peak

TEST CONFIGURATION

➤ 9kHz ~30MHz

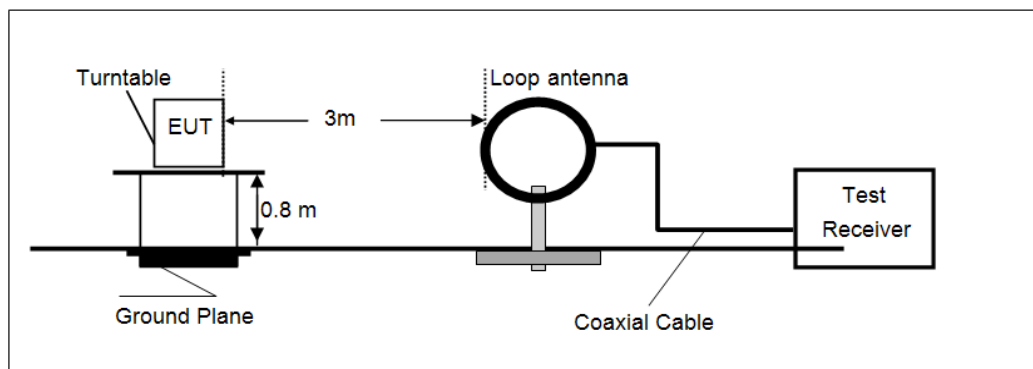

➤ 30MHz ~ 1GHz

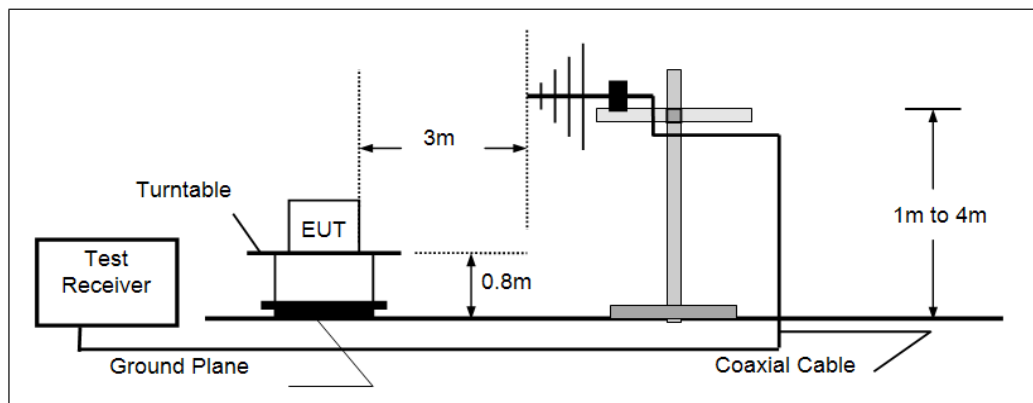

➤ Above 1GHz

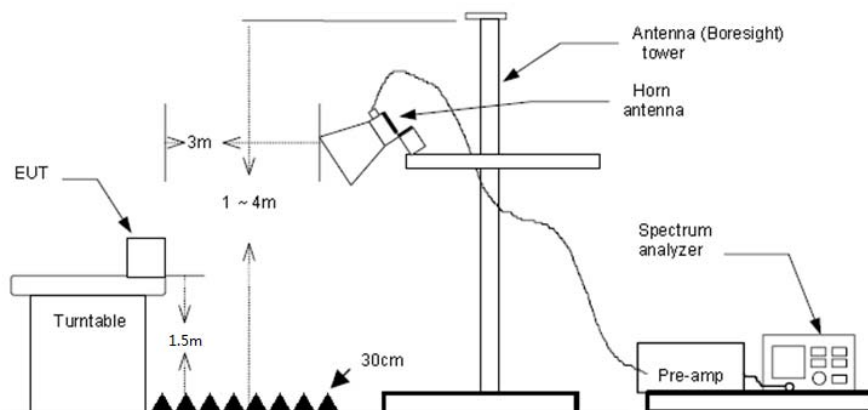

TEST PROCEDURE

1. The EUT was setup and tested according to ANSI C63.10:2013 for compliance to FCC 47CFR 15.247 requirements.
2. The EUT is placed on a turn table which is 0.8 meter above ground for below 1 GHz, and 1.5 m for above 1 GHz. The turn table is rotated 360 degrees to determine the position of the maximum emission level.
3. The EUT was set 3 meters from the receiving antenna, which was mounted on the top of a variable height antenna tower.
4. For each suspected emission, the EUT was arranged to its worst case and then tune the Antenna tower (from 1 m to 4 m) and turntable (from 0 degree to 360 degrees) to find the maximum reading. A pre-amp and a high pass filter are used for the test in order to get better signal level to comply with the guidelines.
5. Set to the maximum power setting and enable the EUT transmit continuously.
6. Use the following spectrum analyzer settings
 - (1) Span shall wide enough to fully capture the emission being measured;
 - (2) Below 1 GHz:
RBW=120 kHz, VBW=300 kHz, Sweep=auto, Detector function=peak, Trace=max hold;
If the emission level of the EUT measured by the peak detector is 3 dB lower than the applicable limit, the peak emission level will be reported. Otherwise, the emission measurement will be repeated using the quasi-peak detector and reported.
 - (3) From 1 GHz to 10th harmonic:
RBW=1MHz, VBW=3MHz Peak detector for Peak value.
RBW=1MHz, VBW=3MHz RMS detector for Average value.

TEST MODE:

Please refer to the clause 3.3

TEST RESULTS

Passed **Not Applicable**

Note:

- 1) Final Level =Receiver Read level + Antenna Factor + Cable Loss – Preamplifier Factor
- 2) The emission levels of other frequencies are very lower than the limit and not show in test report.

➤ 9kHz ~ 30MHz

The EUT was pre-scanned the frequency band (9kHz~30MHz), found the radiated level lower than the limit, so don't show on the report.

➤ 30MHz ~1000MHz

Have pre-scan all modulation mode, found the 802.11b mode CH01 which it was worst case, so only the worst case's data on the test report.

➤ 30MHz ~ 1GHz

Polarization: Vertical

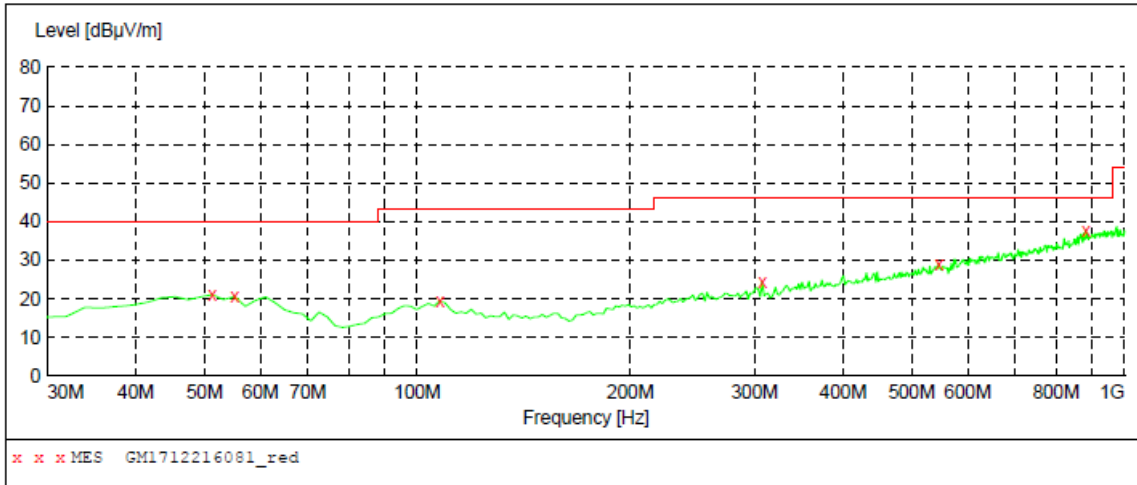

MEASUREMENT RESULT: "GM1712216081_red"

12/21/2017 8:26PM

Frequency MHz	Level dBµV/m	Transd dB	Limit dBµV/m	Margin dB	Det.	Height cm	Azimuth deg	Polarization
51.340000	21.10	-8.8	40.0	18.9	QP	100.0	331.00	VERTICAL
55.220000	20.60	-9.2	40.0	19.4	QP	100.0	3.00	VERTICAL
107.600000	19.40	-10.6	43.5	24.1	QP	100.0	208.00	VERTICAL
307.420000	24.30	-7.1	46.0	21.7	QP	100.0	0.00	VERTICAL
546.040000	29.00	-0.8	46.0	17.0	QP	100.0	0.00	VERTICAL
881.660000	37.70	6.3	46.0	8.3	QP	100.0	169.00	VERTICAL

Polarization: Horizontal

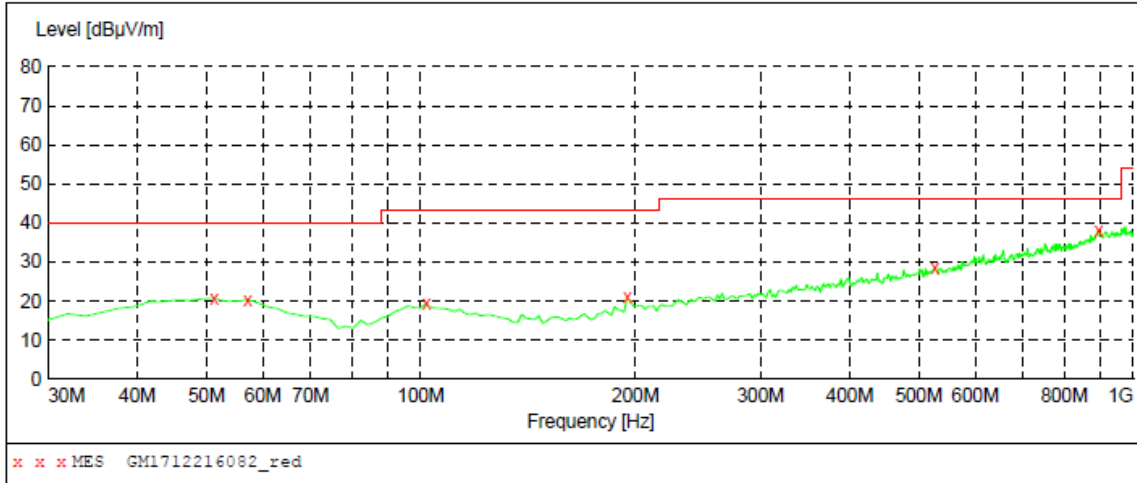

MEASUREMENT RESULT: "GM1712216082_red"

12/21/2017 8:29PM

Frequency MHz	Level dBµV/m	Transd dB	Limit dBµV/m	Margin dB	Det.	Height cm	Azimuth deg	Polarization
51.340000	20.70	-8.8	40.0	19.3	QP	100.0	342.00	HORIZONTAL
57.160000	20.40	-9.4	40.0	19.6	QP	100.0	166.00	HORIZONTAL
101.780000	19.40	-10.5	43.5	24.1	QP	100.0	352.00	HORIZONTAL
194.900000	20.90	-10.1	43.5	22.6	QP	300.0	35.00	HORIZONTAL
526.640000	28.50	-1.2	46.0	17.5	QP	100.0	245.00	HORIZONTAL
893.300000	38.00	6.6	46.0	8.0	QP	100.0	193.00	HORIZONTAL

➤ 1 GHz ~ 25 GHz

802.11b					CH01				
Frequency (MHz)	Read Level (dBuV)	Antenna Factor (dB/m)	Cable Loss (dB)	Preamp Factor (dB)	Level (dBuV/m)	Limit Line (dBuV/m)	Over Limit (dB)	Polarization	Test value
1750.70	36.03	25.30	5.86	37.04	30.15	74.00	-43.85	Vertical	Peak
3709.69	33.76	29.33	8.40	38.25	33.24	74.00	-40.76	Vertical	Peak
5125.52	31.08	31.80	9.77	36.27	36.38	74.00	-37.62	Vertical	Peak
8637.08	30.87	37.52	12.93	34.48	46.84	74.00	-27.16	Vertical	Peak
1182.94	34.94	26.17	4.62	36.58	29.15	74.00	-44.85	Horizontal	Peak
1750.70	38.88	25.30	5.86	37.04	33.00	74.00	-41.00	Horizontal	Peak
2462.36	32.67	27.35	6.81	37.88	28.95	74.00	-45.05	Horizontal	Peak
5940.97	31.19	32.38	10.65	35.41	38.81	74.00	-35.19	Horizontal	Peak

802.11b					CH06				
Frequency (MHz)	Read Level (dBuV)	Antenna Factor (dB/m)	Cable Loss (dB)	Preamp Factor (dB)	Level (dBuV/m)	Limit Line (dBuV/m)	Over Limit (dB)	Polarization	Test value
1216.53	34.78	26.28	4.69	36.56	29.19	74.00	-44.81	Vertical	Peak
2449.85	45.09	27.40	6.80	37.89	41.40	74.00	-32.60	Vertical	Peak
5086.52	31.67	31.85	9.74	36.31	36.95	74.00	-37.05	Vertical	Peak
7961.43	30.52	36.95	12.49	34.63	45.33	74.00	-28.67	Vertical	Peak
1276.82	34.53	26.22	4.79	36.53	29.01	74.00	-44.99	Horizontal	Peak
2108.21	31.94	26.77	6.36	37.32	27.75	74.00	-46.25	Horizontal	Peak
4676.70	31.71	31.13	9.49	37.13	35.20	74.00	-38.80	Horizontal	Peak
7319.96	32.41	36.30	11.99	34.92	45.78	74.00	-28.22	Horizontal	Peak

802.11b					CH11				
Frequency (MHz)	Read Level (dBuV)	Antenna Factor (dB/m)	Cable Loss (dB)	Preamp Factor (dB)	Level (dBuV/m)	Limit Line (dBuV/m)	Over Limit (dB)	Polarization	Test value
1280.07	33.82	26.22	4.80	36.53	28.31	74.00	-45.69	Vertical	Peak
1795.84	32.73	25.39	5.95	37.13	26.94	74.00	-47.06	Vertical	Peak
3561.64	34.06	29.19	8.21	38.32	33.14	74.00	-40.86	Vertical	Peak
6544.35	30.99	34.09	11.26	35.35	40.99	74.00	-33.01	Vertical	Peak
1244.73	34.99	26.25	4.74	36.55	29.43	74.00	-44.57	Horizontal	Peak
1800.42	33.18	25.40	5.96	37.14	27.40	74.00	-46.60	Horizontal	Peak
3983.75	33.25	29.70	8.76	38.12	33.59	74.00	-40.41	Horizontal	Peak
6412.43	30.81	33.39	11.01	35.31	39.90	74.00	-34.10	Horizontal	Peak

Remark:

1. Final Level = Receiver Read level + Antenna Factor + Cable Loss – Preamplifier Factor
2. The peak level is lower than average limit(54 dBuV/m), this data is the too weak instrument of signal is unable to test.
3. The emission levels of other frequencies(test frequency band is 1GHz to 25GHz) are very lower than the limit and not show in test report.

802.11g					CH01				
Frequency (MHz)	Read Level (dBuV)	Antenna Factor (dB/m)	Cable Loss (dB)	Preamp Factor (dB)	Level (dBuV/m)	Limit Line (dBuV/m)	Over Limit (dB)	Polarization	Test value
1195.05	35.12	26.26	4.65	36.57	29.46	74.00	-44.54	Vertical	Peak
3200.50	33.61	28.80	7.72	38.20	31.93	74.00	-42.07	Vertical	Peak
5560.50	30.42	31.84	10.24	36.05	36.45	74.00	-37.55	Vertical	Peak
6851.19	30.14	34.36	11.66	34.94	41.22	74.00	-32.78	Vertical	Peak
1213.44	34.94	26.29	4.68	36.56	29.35	74.00	-44.65	Horizontal	Peak
3233.26	34.05	28.60	7.76	38.26	32.15	74.00	-41.85	Horizontal	Peak
4821.76	30.80	31.56	9.55	36.90	35.01	74.00	-38.99	Horizontal	Peak
5732.97	32.01	31.77	10.48	35.50	38.76	74.00	-35.24	Horizontal	Peak

802.11g					CH06				
Frequency (MHz)	Read Level (dBuV)	Antenna Factor (dB/m)	Cable Loss (dB)	Preamp Factor (dB)	Level (dBuV/m)	Limit Line (dBuV/m)	Over Limit (dB)	Polarization	Test value
1219.64	34.23	26.28	4.69	36.56	28.64	74.00	-45.36	Vertical	Peak
1732.97	32.90	25.27	5.83	37.00	27.00	74.00	-47.00	Vertical	Peak
3786.01	32.98	29.56	8.48	38.23	32.79	74.00	-41.21	Vertical	Peak
5099.49	31.41	31.90	9.75	36.30	36.76	74.00	-37.24	Vertical	Peak
1213.44	35.44	26.29	4.68	36.56	29.85	74.00	-44.15	Horizontal	Peak
1689.41	32.50	25.17	5.74	36.91	26.50	74.00	-47.50	Horizontal	Peak
4191.82	32.74	29.99	8.93	37.67	33.99	74.00	-40.01	Horizontal	Peak
6645.07	30.60	34.20	11.41	35.28	40.93	74.00	-33.07	Horizontal	Peak

802.11g					CH11				
Frequency (MHz)	Read Level (dBuV)	Antenna Factor (dB/m)	Cable Loss (dB)	Preamp Factor (dB)	Level (dBuV/m)	Limit Line (dBuV/m)	Over Limit (dB)	Polarization	Test value
1371.15	32.87	25.98	4.95	36.48	27.32	74.00	-46.68	Vertical	Peak
4688.62	30.54	31.17	9.50	37.11	34.10	74.00	-39.90	Vertical	Peak
5646.08	30.54	31.71	10.34	35.74	36.85	74.00	-37.15	Vertical	Peak
6851.19	30.18	34.36	11.66	34.94	41.26	74.00	-32.74	Vertical	Peak
1219.64	34.46	26.28	4.69	36.56	28.87	74.00	-45.13	Horizontal	Peak
1746.25	32.44	25.29	5.86	37.03	26.56	74.00	-47.44	Horizontal	Peak
3653.46	33.26	29.30	8.33	38.26	32.63	74.00	-41.37	Horizontal	Peak
6478.05	31.10	33.85	11.13	35.33	40.75	74.00	-33.25	Horizontal	Peak

Remark:

1. Final Level = Receiver Read level + Antenna Factor + Cable Loss – Pre-amplifier Factor
2. The peak level is lower than average limit (54 dBuV/m), this data is too weak; instrument of signal is unable to test.
3. The emission levels of other frequencies (test frequency band is 1GHz to 25GHz) are very lower than the limit and not show in test report.

802.11n(HT20)					CH01				
Frequency (MHz)	Read Level (dBuV)	Antenna Factor (dB/m)	Cable Loss (dB)	Preamp Factor (dB)	Level (dBuV/m)	Limit Line (dBuV/m)	Over Limit (dB)	Polarization	Test value
1680.83	33.33	25.14	5.73	36.89	27.31	74.00	-46.69	Vertical	Peak
3653.46	32.78	29.30	8.33	38.26	32.15	74.00	-41.85	Vertical	Peak
4821.76	36.57	31.56	9.55	36.90	40.78	74.00	-33.22	Vertical	Peak
6868.65	29.52	34.48	11.69	34.92	40.77	74.00	-33.23	Vertical	Peak
1502.73	31.13	25.77	5.29	36.59	25.60	74.00	-48.40	Horizontal	Peak
3588.94	31.55	29.27	8.25	38.29	30.78	74.00	-43.22	Horizontal	Peak
4821.76	32.10	31.56	9.55	36.90	36.31	74.00	-37.69	Horizontal	Peak
6511.12	29.49	34.02	11.20	35.34	39.37	74.00	-34.63	Horizontal	Peak

802.11n(HT20)					CH06				
Frequency (MHz)	Read Level (dBuV)	Antenna Factor (dB/m)	Cable Loss (dB)	Preamp Factor (dB)	Level (dBuV/m)	Limit Line (dBuV/m)	Over Limit (dB)	Polarization	Test value
1257.47	35.02	26.24	4.76	36.54	29.48	74.00	-44.52	Vertical	Peak
1755.16	36.18	25.31	5.87	37.05	30.31	74.00	-43.69	Vertical	Peak
3135.99	32.58	28.80	7.64	38.21	30.81	74.00	-43.19	Vertical	Peak
7604.87	31.14	36.20	12.73	34.98	45.09	74.00	-28.91	Vertical	Peak
1746.25	37.52	25.29	5.86	37.03	31.64	74.00	-42.36	Horizontal	Peak
3552.58	32.36	29.16	8.20	38.34	31.38	74.00	-42.62	Horizontal	Peak
4871.10	32.65	31.46	9.59	36.76	36.94	74.00	-37.06	Horizontal	Peak
8042.90	31.17	37.06	12.40	34.53	46.10	74.00	-27.90	Horizontal	Peak

802.11n(HT20)					CH11				
Frequency (MHz)	Read Level (dBuV)	Antenna Factor (dB/m)	Cable Loss (dB)	Preamp Factor (dB)	Level (dBuV/m)	Limit Line (dBuV/m)	Over Limit (dB)	Polarization	Test value
1257.47	34.77	26.24	4.76	36.54	29.23	74.00	-44.77	Vertical	Peak
1814.22	33.09	25.39	5.98	37.15	27.31	74.00	-46.69	Vertical	Peak
4641.12	32.56	31.02	9.48	37.17	35.89	74.00	-38.11	Vertical	Peak
7394.88	32.33	36.30	12.06	34.83	45.86	74.00	-28.14	Vertical	Peak
1185.96	35.73	26.19	4.63	36.58	29.97	74.00	-44.03	Horizontal	Peak
1741.81	33.37	25.29	5.85	37.02	27.49	74.00	-46.51	Horizontal	Peak
5086.52	31.79	31.85	9.74	36.31	37.07	74.00	-36.93	Horizontal	Peak
7394.88	34.66	36.30	12.06	34.83	48.19	74.00	-25.81	Horizontal	Peak

Remark:

1. Final Level = Receiver Read level + Antenna Factor + Cable Loss – Preamplifier Factor
2. The peak level is lower than average limit(54 dBuV/m), this data is the too weak instrument of signal is unable to test.
3. The emission levels of other frequencies(test frequency band is 1GHz to 25GHz) are very lower than the limit and not show in test report.

6. TEST SETUP PHOTOS

Conducted Emissions (AC Mains)



Radiated Emissions



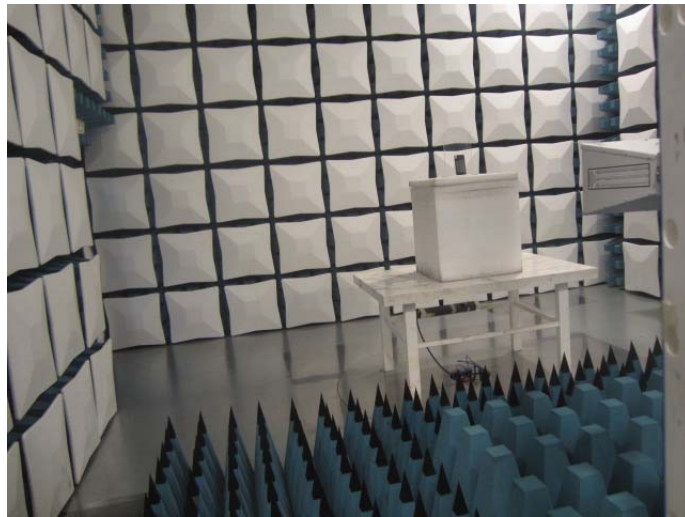

EXTERANAL AND INTERNAL PHOTOS

Reference to the test report No.: TRE1712012601.

-----End of Report-----