



TEST REPORT

Report Reference No...... : **TRE1712020706** R/C.....: 55390

FCC ID..... : **ZSW-30-056**

Applicant's name..... : **b mobile HK Limited**

Address..... : Flat 18; 14/F Block 1; Golden Industrial Building;16-26 Kwai Tak Street; Kwai Chung; New Territories; Hong Kong.

Manufacturer..... : b mobile HK Limited

Address..... : Flat 18; 14/F Block 1; Golden Industrial Building;16-26 Kwai Tak Street; Kwai Chung; New Territories; Hong Kong.

Test item description : **Mobile Phone**

Trade Mark : Bmobile

Model/Type reference..... : AX1016

Listed Model(s)..... : -

Standard : **FCC CFR Title 47 Part 15 Subpart C Section 15.247**

Date of receipt of test sample..... : Dec.21, 2017

Date of testing..... : Dec.22, 2017 - Jan.03, 2018

Date of issue..... : Jan.04, 2018

Result..... : **PASS**

Compiled by
(position+printedname+signature)....: File administrators Candy Liu *Candy Liu*

Supervised by
(position+printedname+signature)....: Project Engineer : Edward Pan *Edward Pan*

Approved by
(Position+Printed name+Signature): RF Manager Hans Hu *Hans Hu*

Testing Laboratory Name : **Shenzhen Huatongwei International Inspection Co., Ltd.**

Address..... : 1/F, Bldg 3, Hongfa Hi-tech Industrial Park, Genyu Road, Tianliao, Gongming, Shenzhen, China

Shenzhen Huatongwei International Inspection Co., Ltd. All rights reserved.

This publication may be reproduced in whole or in part for non-commercial purposes as long as the Shenzhen Huatongwei International Inspection Co., Ltd. is acknowledged as copyright owner and source of the material. Shenzhen Huatongwei International Inspection Co., Ltd. takes no responsibility for and will not assume liability for damages resulting from the reader's interpretation of the reproduced material due to its placement and context.

The test report merely correspond to the test sample.

Contents

1.	<u>TEST STANDARDS AND REPORT VERSION</u>	3
1.1.	Test Standards	3
1.2.	Report version	3
2.	<u>TEST DESCRIPTION</u>	4
3.	<u>SUMMARY</u>	5
3.1.	Client Information	5
3.2.	Product Description	5
3.3.	Operation state	6
3.4.	EUT configuration	6
3.5.	Modifications	6
4.	<u>TEST ENVIRONMENT</u>	7
4.1.	Address of the test laboratory	7
4.2.	Test Facility	7
4.3.	Environmental conditions	8
4.4.	Statement of the measurement uncertainty	8
4.5.	Equipments Used during the Test	9
5.	<u>TEST CONDITIONS AND RESULTS</u>	11
5.1.	Antenna Requirement	11
5.2.	Conducted Emissions (AC Main)	12
5.3.	Conducted Peak Output Power	15
5.4.	Power Spectral Density	16
5.5.	6dB bandwidth	18
5.6.	Restricted band	20
5.7.	Band edge and Spurious Emissions (conducted)	25
5.8.	Spurious Emissions (radiated)	30
6.	<u>TEST SETUP PHOTOS</u>	34
7.	<u>EXTERANAL AND INTERNAL PHOTOS</u>	35

1. TEST STANDARDS AND REPORT VERSION

1.1. Test Standards

The tests were performed according to following standards:

[FCC Rules Part 15.247](#): Frequency Hopping, Direct Spread Spectrum and Hybrid Systems that are in operation within the bands of 902-928 MHz, 2400-2483.5 MHz, and 5725-5850 MHz

[ANSI C63.10:2013](#): American National Standard for Testing Unlicensed Wireless Devices

[KDB 558074 D01 DTS Meas Guidance v04](#): Guidance for Performing Compliance Measurements on Digital Transmission Systems (DTS) Operating under §15.247

1.2. Report version

Version No.	Date of issue	Description
00	Jan.04,2018	Original

2. TEST DESCRIPTION

Test Item	FCC Rule	Result	Test Engineer
Antenna requirement	15.203/15.247(c)	PASS	Baozhu.hu
Line Conducted Emissions (AC Main)	15.207	PASS	Baozhu.hu
Conducted Peak Output Power	15.247(b)(3)	PASS	Baozhu.hu
Power Spectral Density	15.247(e)	PASS	Baozhu.hu
6dB Bandwidth	15.247(a)(2)	PASS	Baozhu.hu
Restricted band	15.247(d)/15.205	PASS	Baozhu.hu
Spurious Emissions	15.247(d)/15.209	PASS	Baozhu.hu

Note: The measurement uncertainty is not included in the test result.

3. SUMMARY

3.1. Client Information

Applicant:	b mobile HK Limited
Address:	Flat 18; 14/F Block 1; Golden Industrial Building;16-26 Kwai Tak Street; Kwai Chung; New Territories; Hong Kong.
Manufacturer:	b mobile HK Limited
Address:	Flat 18; 14/F Block 1; Golden Industrial Building;16-26 Kwai Tak Street; Kwai Chung; New Territories; Hong Kong.

3.2. Product Description

Name of EUT:	Mobile Phone
Trade Mark:	Bmobile
Model No.:	AX1016
Listed Model(s):	-
IMEI 1:	325518030001829
IMEI 2:	325518030001845
Power supply:	DC 3.8V
Adapter information:	Input: 100-240Va.c., 50/60Hz, 0.2A Output: 5Vd.c.,700mA
Hardware version:	W4G01_MB_V3.0_20170406
Software version:	Bmobile_AX1016_TIGO_V001(20171218)
Bluetooth	
Version:	Supported BT4.0+BLE
Modulation:	GFSK
Operation frequency:	2402MHz~2480MHz
Channel number:	40
Channel separation:	2MHz
Antenna type:	Integral Antenna
Antenna gain:	-0.8dBi

3.3. Operation state

➤ Test frequency list

According to section 15.31(m), regards to the operating frequency range over 10 MHz, must select three channel which were tested. the Lowest frequency, the middle frequency, and the highest frequency of channel were selected to perform the test, please see the above gray bottom.

Channel	Frequency (MHz)
00	2402
01	2404
⋮	⋮
19	2440
⋮	⋮
38	2478
39	2480

➤ Test mode

For RF test items
The engineering test program was provided and enabled to make EUT continuous transmit (duty cycle>98%).
For AC power line conducted emissions:
The EUT was set to connect with the Bluetooth instrument under large package sizes transmission.
For Radiated suprious emissions test item:
The engineering test program was provided and enabled to make EUT continuous transmit(duty cycle>98%). The EUT in each of three orthogonal axis emissions had been tested ,but only the worst case (X axis) data Recorded in the report.

3.4. EUT configuration

The following peripheral devices and interface cables were connected during the measurement:

- - supplied by the manufacturer
- - supplied by the lab

/	Manufacturer:	/
	Model No.:	/
/	Manufacturer:	/
	Model No.:	/

3.5. Modifications

No modifications were implemented to meet testing criteria.

4. TEST ENVIRONMENT

4.1. Address of the test laboratory

Laboratory: Shenzhen Huatongwei International Inspection Co., Ltd.

Address: 1/F, Bldg 3, Hongfa Hi-tech Industrial Park, Genyu Road, Tianliao, Gongming, Shenzhen, China

4.2. Test Facility

CNAS-Lab Code: L1225

Shenzhen Huatongwei International Inspection Co., Ltd. has been assessed and proved to be in compliance with CNAS-CL01 Accreditation Criteria for Testing and Calibration Laboratories (identical to ISO/IEC17025: 2005 General Requirements) for the Competence of Testing and Calibration Laboratories.

A2LA-Lab Cert. No.: 3902.01

Shenzhen Huatongwei International Inspection Co., Ltd. EMC Laboratory has been accredited by A2LA for technical competence in the field of electrical testing, and proved to be in compliance with ISO/IEC 17025: 2005 General Requirements for the Competence of Testing and Calibration Laboratories and any additional program requirements in the identified field of testing.

FCC-Registration No.: 762235

Shenzhen Huatongwei International Inspection Co., Ltd. EMC Laboratory has been registered and fully described in a report filed with the FCC (Federal Communications Commission). The acceptance letter from the FCC is maintained in our files.

IC-Registration No.:5377B-1

Two 3m Alternate Test Site of Shenzhen Huatongwei International Inspection Co., Ltd. has been registered by Certification and Engineering Bureau of Industry Canada for the performance of radiated measurements with Registration No.: 5377B-1.

ACA

Shenzhen Huatongwei International Inspection Co., Ltd. EMC Laboratory can also perform testing for the Australian C-Tick mark as a result of our A2LA accreditation.

4.3. Environmental conditions

During the measurement the environmental conditions were within the listed ranges:

Temperature:	15~35°C
Relative Humidity:	30~60 %
Air Pressure:	950~1050mba

4.4. Statement of the measurement uncertainty

The data and results referenced in this document are true and accurate. The reader is cautioned that there may be errors in calibration limits of the equipment and facilities. The measurement uncertainty was calculated for all measurements listed in this test report according to TR-100028-01 "Electromagnetic compatibility and Radio spectrum Matters (ERM); Uncertainties in the measurement of mobile radio equipment characteristics; Part 1" and TR-100028-02 "Electromagnetic compatibility and Radio spectrum Matters (ERM); Uncertainties in the measurement of mobile radio equipment characteristics; Part 2" and is documented in the Shenzhen Huatongwei International Inspection Co., Ltd. quality system according to ISO/IEC 17025. Furthermore, component and process variability of devices similar to that tested may result in additional deviation. The manufacturer has the sole responsibility of continued compliance of the device.

Here after the best measurement capability for Shenzhen Huatongwei International Inspection Co., Ltd. is reported:

Test Items	Measurement Uncertainty	Notes
Transmitter power conducted	0.57 dB	(1)
Transmitter power Radiated	2.20 dB	(1)
Conducted spurious emissions 9kHz~40GHz	1.60 dB	(1)
Radiated spurious emissions 9kHz~40GHz	2.20 dB	(1)
Conducted Emissions 9kHz~30MHz	3.39 dB	(1)
Radiated Emissions 30~1000MHz	4.24 dB	(1)
Radiated Emissions 1~18GHz	5.16 dB	(1)
Radiated Emissions 18~40GHz	5.54 dB	(1)

(1) This uncertainty represents an expanded uncertainty expressed at approximately the 95% confidence level using a coverage factor of k=1.96.

4.5. Equipments Used during the Test

Conducted Emissions						
Item	Test Equipment	Manufacturer	Model No.	Serial No.	Last Cal. (mm-dd-yy)	Next Cal. (mm-dd-yy)
1	EMI Test Receiver	R&S	ESCI	101247	11/11/2017	11/10/2018
2	Artificial Mains	SCHWARZBECK	NNLK 8121	573	11/11/2017	11/10/2018
3	2-Line V-Network	R&S	ESH3-Z5	100049	11/11/2017	11/10/2018
4	Pulse Limiter	R&S	ESH3-Z2	101488	11/11/2017	11/10/2018
5	RF Connection Cable	HUBER+SUHNER	EF400	N/A	11/21/2017	11/20/2018
6	Test Software	R&S	ES-K1	N/A	N/A	N/A

Radiated Emissions						
Item	Test Equipment	Manufacturer	Model No.	Serial No.	Last Cal. (mm-dd-yy)	Next Cal. (mm-dd-yy)
1	EMI Test Receiver	R&S	ESCI	101247	11/11/2017	11/10/2018
2	Loop Antenna	R&S	HFH2-Z2	100020	11/20/2017	11/19/2018
3	Ultra-Broadband Antenna	SCHWARZBECK	VULB9163	538	4/5/2017	4/4/2018
4	Preamplifier	SCHWARZBECK	BBV 9743	9743-0022	10/18/2017	10/17/2018
5	RF Connection Cable	HUBER+SUHNER	RE-7-FL	N/A	11/21/2017	11/20/2018
6	EMI Test Software	R&S	ESK1	N/A	N/A	N/A
7	Spectrum Analyzer	R&S	FSP40	100597	11/11/2017	11/10/2018
8	Horn Antenna	SCHWARZBECK	9120D	1011	3/27/2017	3/26/2018
9	Horn Antenna	SCHWARZBECK	BBHA9170	25841	3/27/2017	3/26/2018
10	Broadband Preamplifier	SCHWARZBECK	BBV 9718	9718-248	10/18/2017	10/17/2018
11	High pass filter	Compliance Direction systems	BSU-6	34202	11/11/2017	11/10/2018
12	RF Connection Cable	HUBER+SUHNER	RE-7-FH	N/A	11/21/2017	11/20/2018
13	EMI Test Software	Audix	E3	N/A	N/A	N/A
14	Turntable	MATURO	TT2.0	/	N/A	N/A
15	Antenna Mast	MATURO	TAM-4.0-P	/	N/A	N/A

RF Conducted Test						
Item	Test Equipment	Manufacturer	Model No.	Serial No.	Last Cal. (mm-dd-yy)	Next Cal. (mm-dd-yy)
1	Spectrum Analyzer	R&S	FSV40	100048	11/11/2017	11/10/2018
2	EXA Signal Analyzer	Agilent	N9020A	184247	9/22/2017	9/21/2018
3	Power Meter	Agilent	U2021XA	178231	9/22/2017	9/21/2018
4	OSP	R&S	OSP120	101317	N/A	N/A

The Cal.Interval was one year.

5. TEST CONDITIONS AND RESULTS

5.1. Antenna Requirement

Requirement

FCC CFR Title 47 Part 15 Subpart C Section 15.203:

An intentional radiator shall be designed to ensure that no antenna other than that furnished by the responsible party shall be used with the device. The use of a permanently attached antenna or of an antenna that uses a unique coupling to the intentional radiator, the manufacturer may design the unit so that a broken antenna can be replaced by the user, but the use of a standard antenna jack or electrical connector is prohibited.

FCC CFR Title 47 Part 15 Subpart C Section 15.247(c) (1)(i):

(i) Systems operating in the 2400-2483.5 MHz band that is used exclusively for fixed. Point-to-point operations may employ transmitting antennas with directional gain greater than 6 dBi provided the maximum conducted output power of the intentional radiator is reduced by 1 dB for every 3 dB that the directional gain of the antenna exceeds 6 dBi.

TEST RESULTS

Passed Not Applicable

The directional gain of the antenna less than 6 dBi, please refer to the below antenna photo.

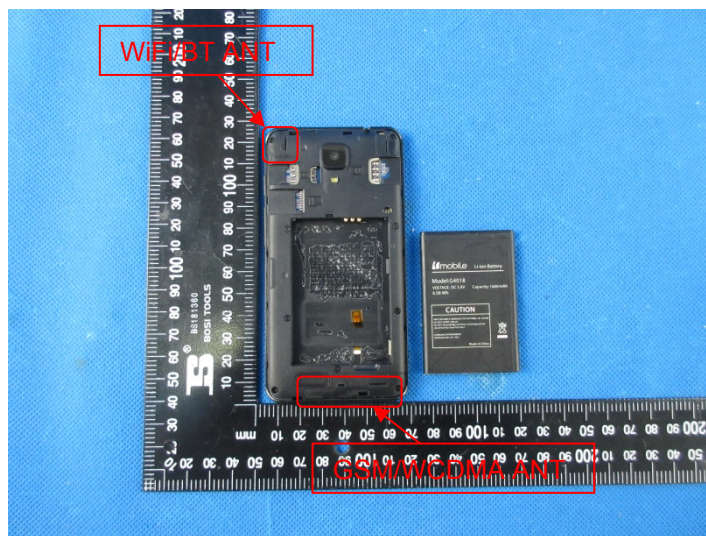

5.2. Conducted Emissions (AC Main)

LIMIT

FCC CFR Title 47 Part 15 Subpart C Section 15.207

Frequency range (MHz)	Limit (dBuV)	
	Quasi-peak	Average
0.15-0.5	66 to 56*	56 to 46*
0.5-5	56	46
5-30	60	50

* Decreases with the logarithm of the frequency.

TEST CONFIGURATION

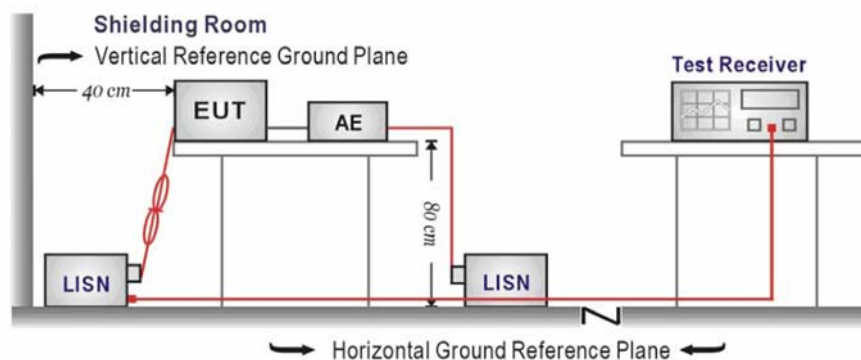

TEST PROCEDURE

1. The EUT was setup according to ANSI C63.10:2013 requirements.
2. The EUT was placed on a platform of nominal size, 1 m by 1.5 m, raised 80 cm above the conducting ground plane. The vertical conducting plane was located 40 cm to the rear of the EUT. All other surfaces of EUT were at least 80 cm from any other grounded conducting surface.
3. The EUT and simulators are connected to the main power through a line impedances stabilization network (LISN). The LISN provides a 50 ohm /50uH coupling impedance for the measuring equipment.
4. The peripheral devices are also connected to the main power through a LISN. (Please refer to the block diagram of the test setup and photographs)
5. Each current-carrying conductor of the EUT power cord, except the ground (safety) conductor, was individually connected through a LISN to the input power source.
6. The excess length of the power cord between the EUT and the LISN receptacle were folded back and forth at the center of the lead to form a bundle not exceeding 40 cm in length.
7. Conducted emissions were investigated over the frequency range from 0.15MHz to 30MHz using a receiver bandwidth of 9 kHz.
8. During the above scans, the emissions were maximized by cable manipulation.

TEST MODE:

Please refer to the clause 3.3

TEST RESULTS

Passed Not Applicable

Note:

- 1) Transd = Cable lose + Pulse Limiter Factor + Artificial Mains Factor
- 2) Margin = Limit - Level

Test Line: L

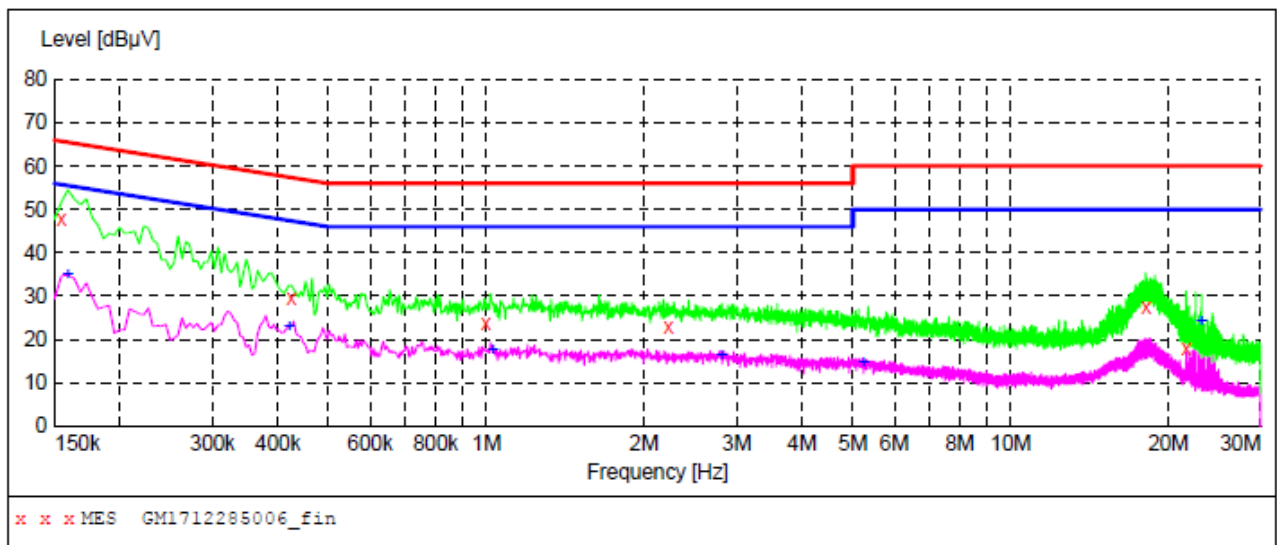

MEASUREMENT RESULT: "GM1712285006_fin"

12/28/2017 10:44AM

Frequency MHz	Level dBµV	Transd dB	Limit dBµV	Margin dB	Detector	Line	PE
0.154500	47.80	10.0	66	18.0	QP	L1	GND
0.424500	29.50	9.9	57	27.9	QP	L1	GND
0.996000	23.80	10.1	56	32.2	QP	L1	GND
2.220000	23.10	10.1	56	32.9	QP	L1	GND
18.109500	27.40	10.6	60	32.6	QP	L1	GND
21.646500	18.10	10.7	60	41.9	QP	L1	GND

MEASUREMENT RESULT: "GM1712285006_fin2"

12/28/2017 10:44AM

Frequency MHz	Level dBµV	Transd dB	Limit dBµV	Margin dB	Detector	Line	PE
0.159000	35.10	10.0	56	20.4	AV	L1	GND
0.420000	23.10	9.9	47	24.3	AV	L1	GND
1.027500	17.40	10.1	46	28.6	AV	L1	GND
2.809500	16.10	10.1	46	29.9	AV	L1	GND
5.244000	14.60	10.2	50	35.4	AV	L1	GND
23.127000	24.30	10.7	50	25.7	AV	L1	GND

Test Line: N

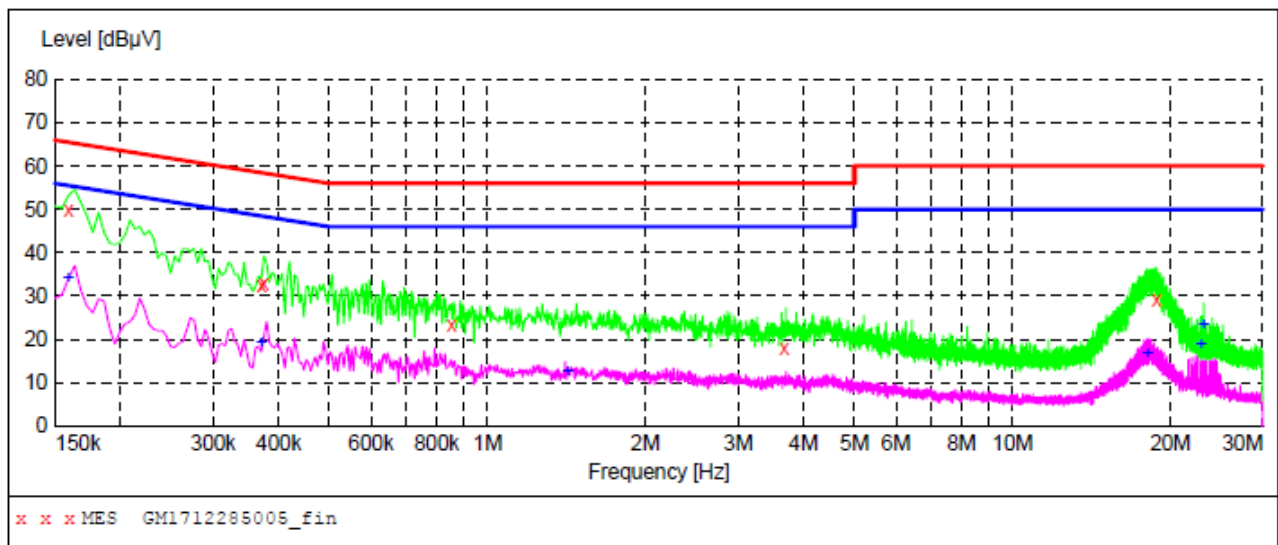

MEASUREMENT RESULT: "GM1712285005_fin"

12/28/2017 10:42AM

Frequency MHz	Level dBµV	Transd dB	Limit dBµV	Margin dB	Detector	Line	PE
0.159000	49.80	10.0	66	15.7	QP	N	GND
0.370500	32.30	9.9	59	26.2	QP	N	GND
0.375000	33.00	9.9	58	25.4	QP	N	GND
0.852000	23.50	10.0	56	32.5	QP	N	GND
3.673500	18.10	10.1	56	37.9	QP	N	GND
18.798000	29.20	10.6	60	30.8	QP	N	GND

MEASUREMENT RESULT: "GM1712285005_fin2"

12/28/2017 10:42AM

Frequency MHz	Level dBµV	Transd dB	Limit dBµV	Margin dB	Detector	Line	PE
0.159000	34.00	10.0	56	21.5	AV	N	GND
0.370500	19.20	9.9	49	29.3	AV	N	GND
1.419000	12.40	10.1	46	33.6	AV	N	GND
18.087000	16.70	10.6	50	33.3	AV	N	GND
22.884000	18.60	10.7	50	31.4	AV	N	GND
23.127000	23.50	10.7	50	26.5	AV	N	GND

5.3. Conducted Peak Output Power

LIMIT

FCC CFR Title 47 Part 15 Subpart C Section 15.247 (b)(3): 30 dBm

TEST CONFIGURATION

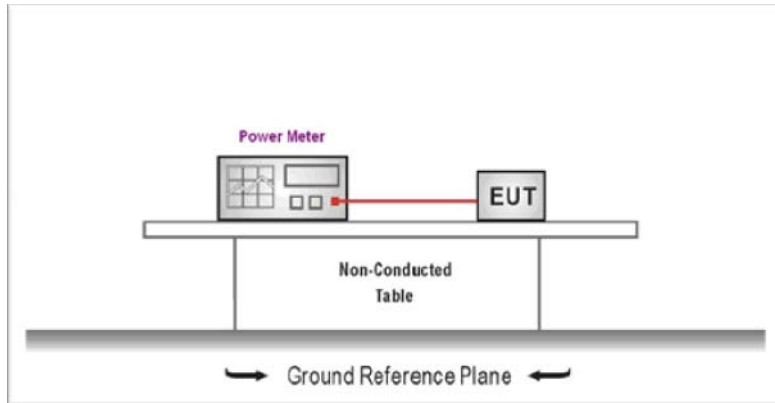

TEST PROCEDURE

1. The EUT was tested according to ANSI C63.10: 2013 and KDB 558074 D01 for compliance to FCC 47 CFR 15.247 requirements.
2. The maximum peak conducted output power may be measured using a broadband peak RF power meter.
3. The power meter shall have a video bandwidth that is greater than or equal to the DTS bandwidth and shall utilize a fast-responding diode detector.
4. Record the measurement data.

TEST MODE:

Please refer to the clause 3.3

TEST RESULTS

Passed Not Applicable

Type	Channel	Output power (dBm)	Limit (dBm)	Result
BT-BLE	00	-8.36	≤30.00	Pass
	19	-7.54		
	39	-6.55		

5.4. Power Spectral Density

LIMIT

FCC CFR Title 47 Part 15 Subpart C Section 15.247 (e):

For digitally modulated systems, the power spectral density conducted from the intentional radiator to the antenna shall not be greater than 8 dBm in any 3 kHz band during any time interval of continuous transmission.

TEST CONFIGURATION

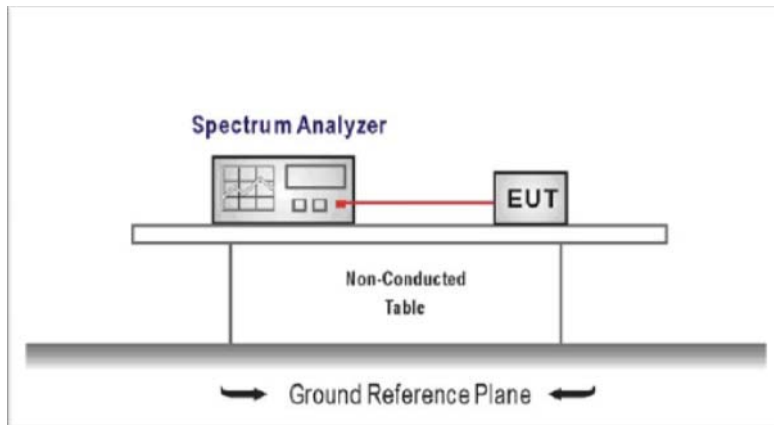

TEST PROCEDURE

1. Connect the antenna port(s) to the spectrum analyzer input,
2. Configure the spectrum analyzer as shown below:
 Center frequency=DTS channel center frequency
 Span =1.5 times the DTS bandwidth
 RBW = 3 kHz ≤ RBW ≤ 100 kHz, VBW ≥ 3 × RBW
 Sweep time = auto couple
 Detector = peak
 Trace mode = max hold
3. Place the radio in continuous transmit mode, allow the trace to stabilize, view the transmitter wave form on the spectrum analyzer.
4. Use the peak marker function to determine the maximum amplitude level within the RBW.
5. If measured value exceeds limit, reduce RBW (no less than 3 kHz) and repeat.

TEST MODE:

Please refer to the clause 3.3

TEST RESULTS

Passed Not Applicable

Type	Channel	Power Spectral Density(dBm/3KHz)	Limit (dBm/3KHz)	Result
BT-BLE	00	-24.03	≤8.00	Pass
	19	-22.95		
	39	-21.95		

Test plot as follows:

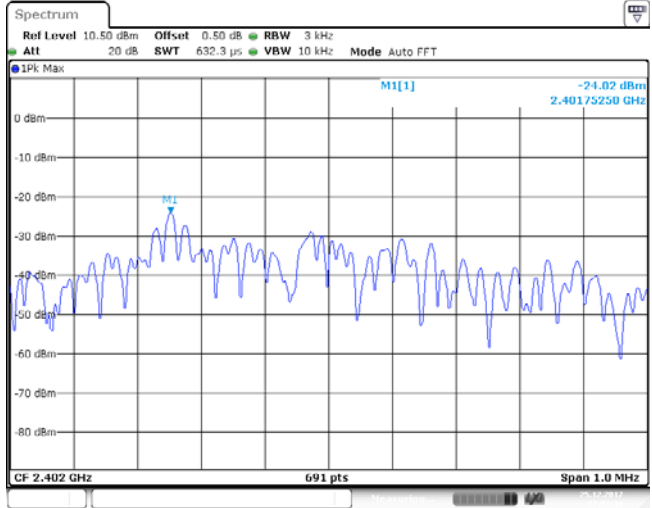
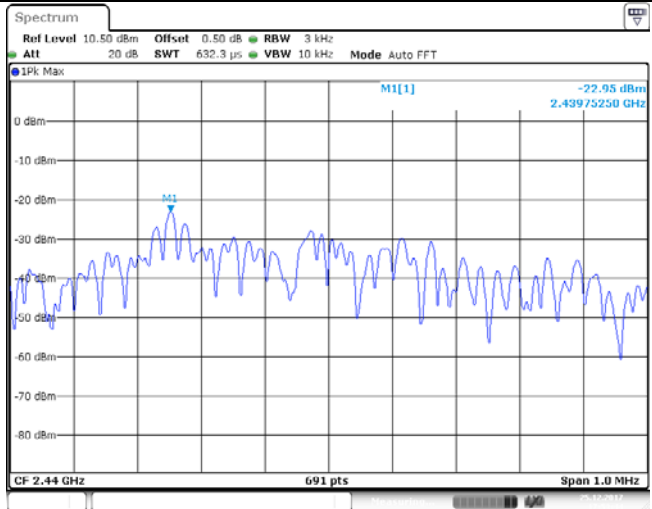
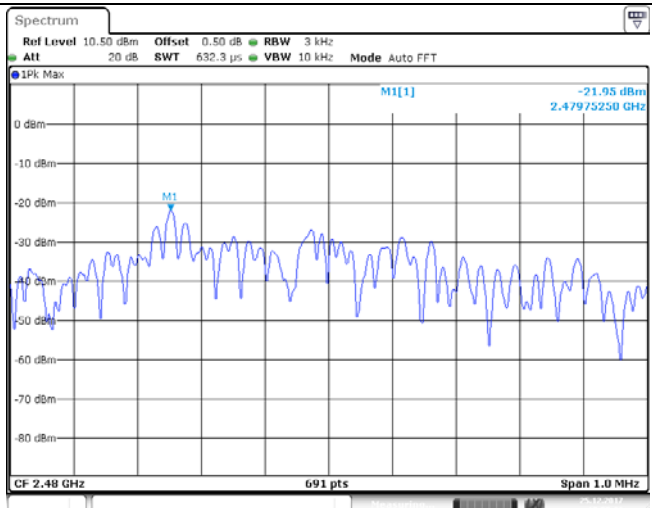
CH00	 <p>Spectrum plot for CH00. The plot shows a noisy signal with a peak at 2.40175250 GHz. The peak level is -24.02 dBm. The plot parameters are: Rel Level 10.50 dBm, Offset 0.50 dB, RBW 3 kHz, Alt 20 dB, SWT 632.3 μs, VBW 10 kHz, Mode Auto FFT. The center frequency is 2.402 GHz and the span is 1.0 MHz.</p>
CH19	 <p>Spectrum plot for CH19. The plot shows a noisy signal with a peak at 2.43975250 GHz. The peak level is -22.95 dBm. The plot parameters are: Rel Level 10.50 dBm, Offset 0.50 dB, RBW 3 kHz, Alt 20 dB, SWT 632.3 μs, VBW 10 kHz, Mode Auto FFT. The center frequency is 2.44 GHz and the span is 1.0 MHz.</p>
CH39	 <p>Spectrum plot for CH39. The plot shows a noisy signal with a peak at 2.47975250 GHz. The peak level is -21.95 dBm. The plot parameters are: Rel Level 10.50 dBm, Offset 0.50 dB, RBW 3 kHz, Alt 20 dB, SWT 632.3 μs, VBW 10 kHz, Mode Auto FFT. The center frequency is 2.48 GHz and the span is 1.0 MHz.</p>

5.5. 6dB bandwidth

LIMIT

FCC CFR Title 47 Part 15 Subpart C Section 15.247 (a)(2):

For digital modulation systems, the minimum 6 dB bandwidth shall be at least 500 kHz.

TEST CONFIGURATION

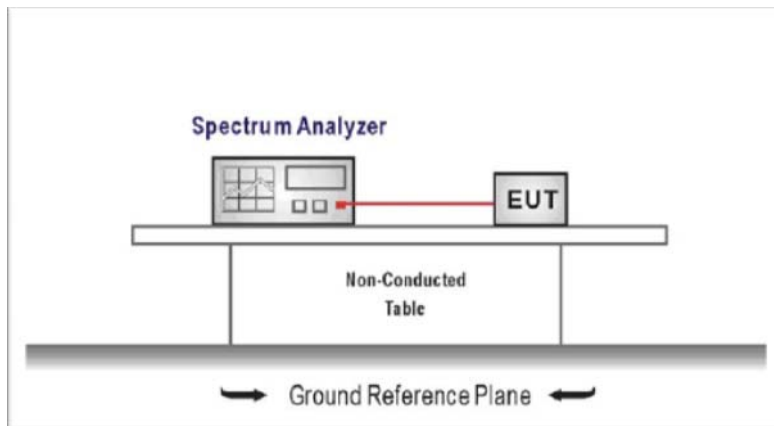

TEST PROCEDURE

1. Connect the antenna port(s) to the spectrum analyzer input.
2. Configure the spectrum analyzer as shown below (enter all losses between the transmitter output and the spectrum analyzer).
 Center Frequency =DTS channel center frequency
 Span=2 x DTS bandwidth
 RBW = 100 kHz, VBW ≥ 3 × RBW
 Sweep time= auto couple
 Detector = Peak
 Trace mode = max hold
3. Place the radio in continuous transmit mode, allow the trace to stabilize, view the transmitter waveform on the spectrum analyzer.
4. Measure the maximum width of the emission that is constrained by the frequencies associated with the two outermost amplitude points (upper and lower frequencies) that are attenuated by 6 dB relative to the maximum level measured in the fundamental emission, and record the pertinent measurements.

TEST MODE:

Please refer to the clause 3.3

TEST RESULTS

Passed Not Applicable

Type	Channel	6dB Bandwidth(MHz)	Limit (kHz)	Result
BT-BLE	00	0.51	≥500	Pass
	19	0.51		
	39	0.51		

Test plot as follows:

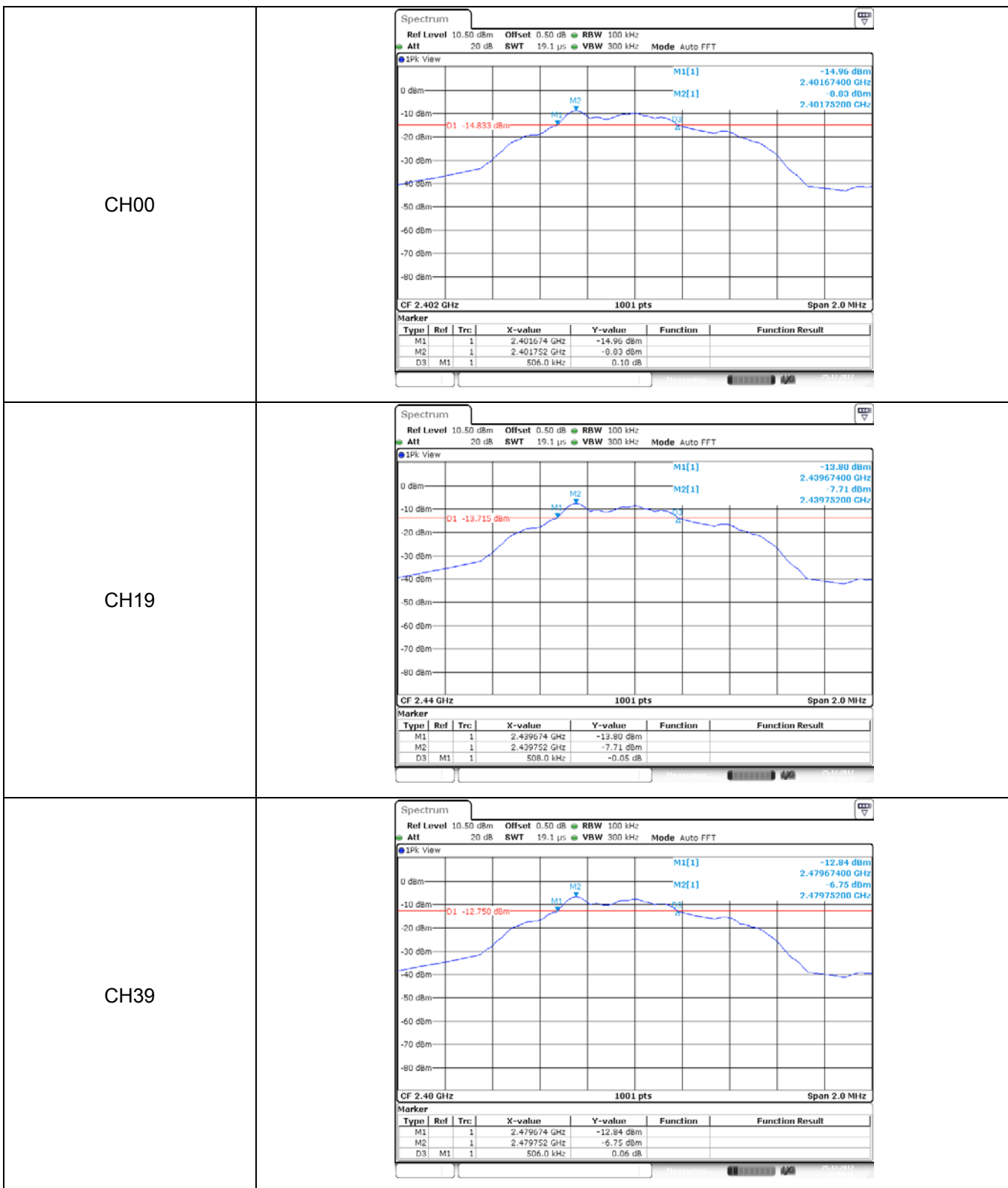

5.6. Restricted band

LIMIT

FCC CFR Title 47 Part 15 Subpart C Section 15.247 (d):

In any 100 kHz bandwidth outside the frequency band in which the spread spectrum or digitally modulated intentional radiator is operating, Radiated Emissions which fall in the restricted bands, as defined in §15.205(a), must also comply with the Radiated Emissions limits specified in §15.209(a) (see §15.205(c)).

TEST CONFIGURATION

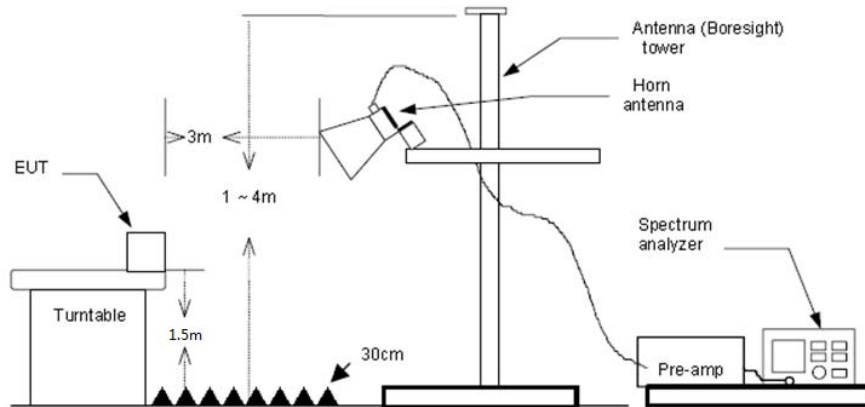

TEST PROCEDURE

1. The EUT was setup and tested according to ANSI C63.10:2013 for compliance to FCC 47CFR 15.247 requirements.
2. The EUT is placed on a turn table which is 1.5 meter above ground. The turn table is rotated 360 degrees to determine the position of the maximum emission level.
3. The EUT was positioned such that the distance from antenna to the EUT was 3 meters.
4. The antenna is scanned from 1 meter to 4 meters to find out the maximum emission level. This is repeated for both horizontal and vertical polarization of the antenna. In order to find the maximum emission, all of the interface cables were manipulated according to ANSI C63.10:2013 on radiated measurement.
5. The receiver set as follow:
 RBW=1MHz, VBW=3MHz Peak detector for Peak value.
 RBW=1MHz, VBW=3MHz RMS detector for Average value.

TEST MODE:

Please refer to the clause 3.3

TEST RESULTS

Passed Not Applicable

Note:

- 1) Final level= Read level + Antenna Factor+ Cable Loss- Preamp Factor
- 2) The peak level is lower than average limit(54 dBuV/m), this data is the too weak instrument of signal is unable to test.

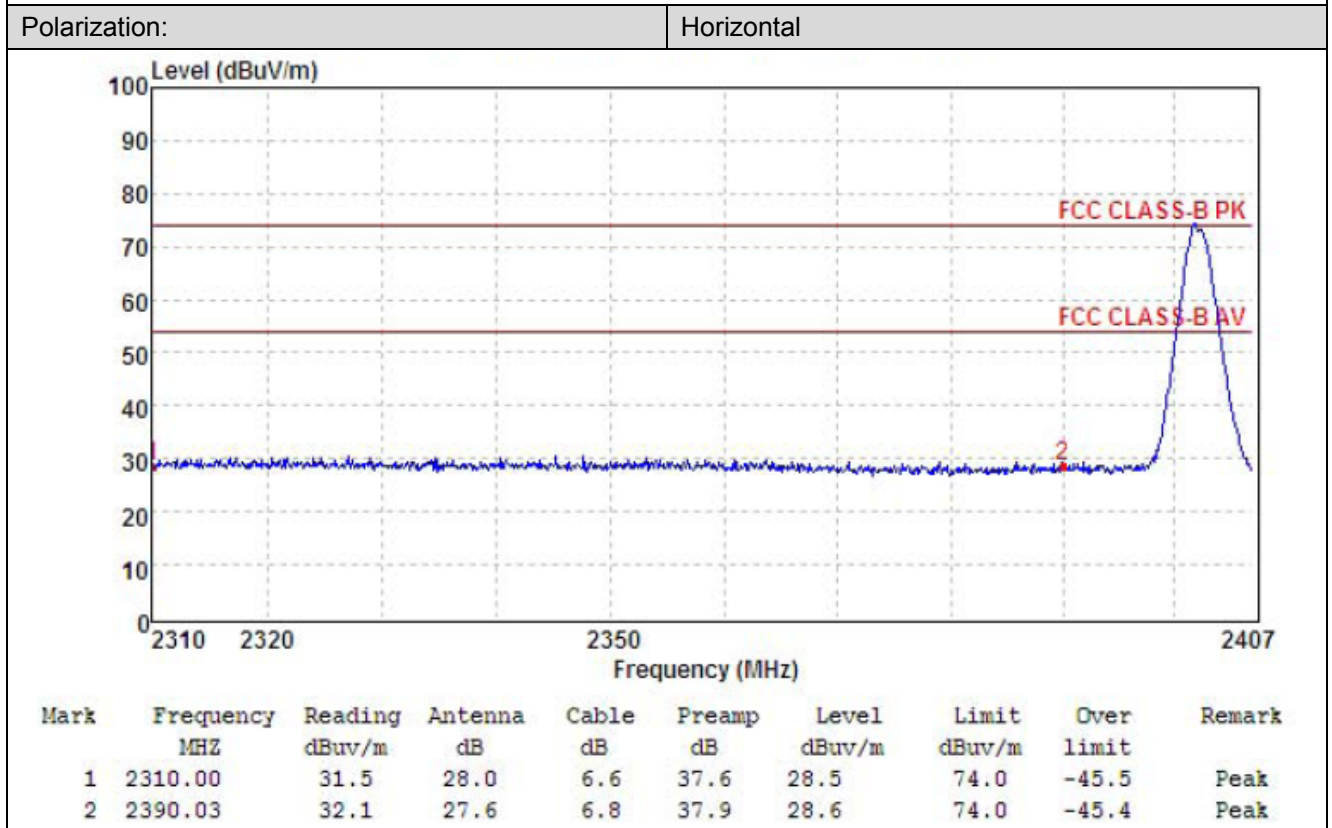
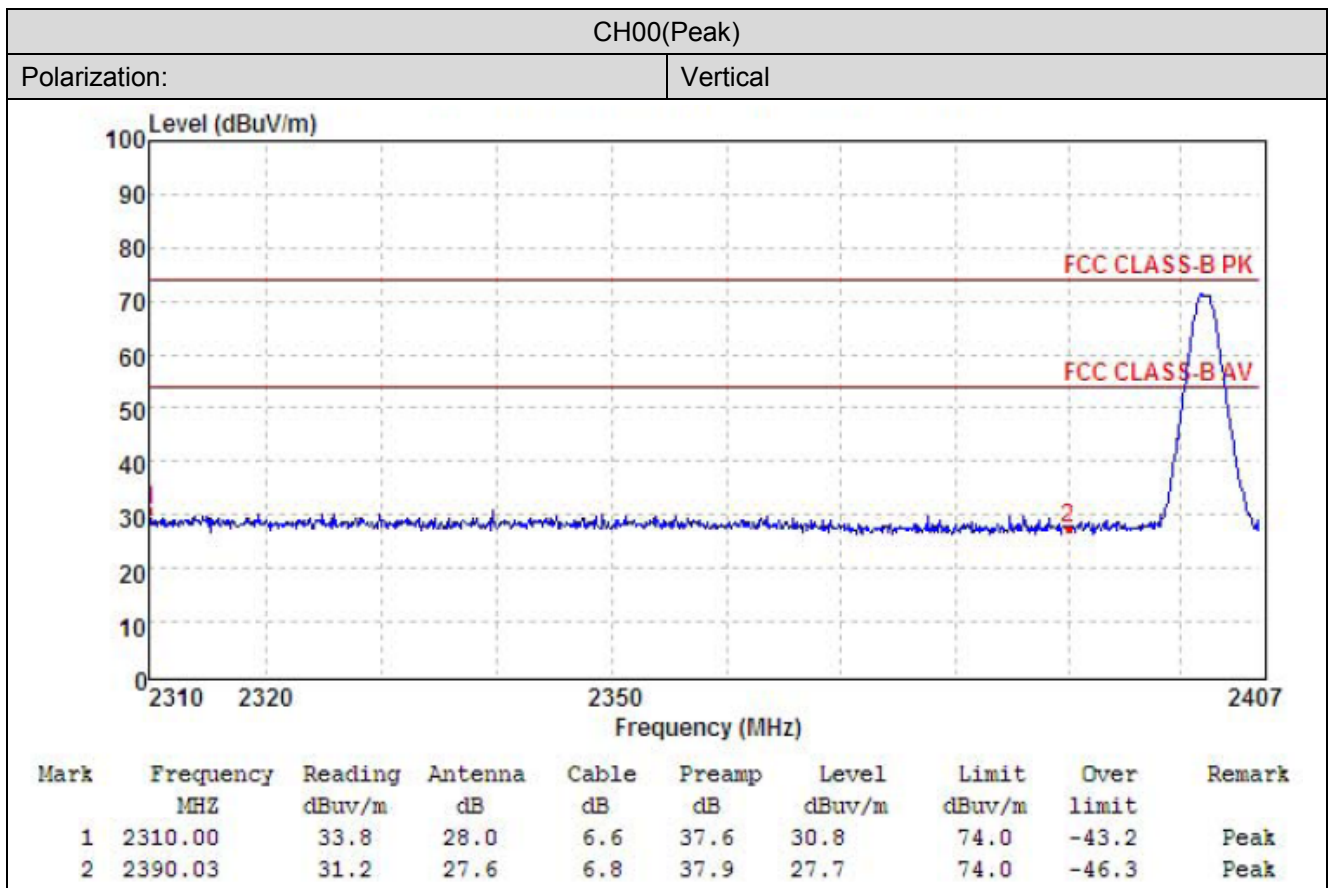

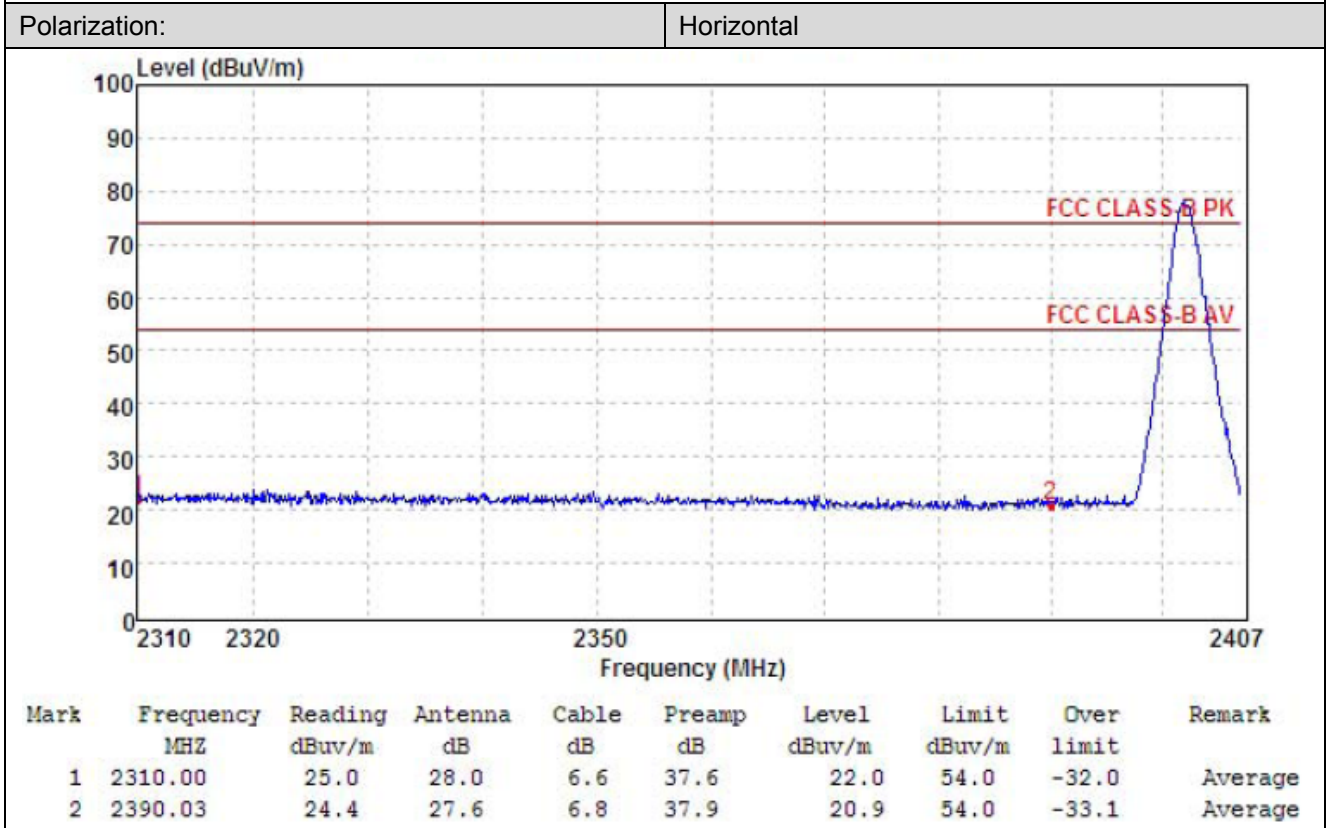
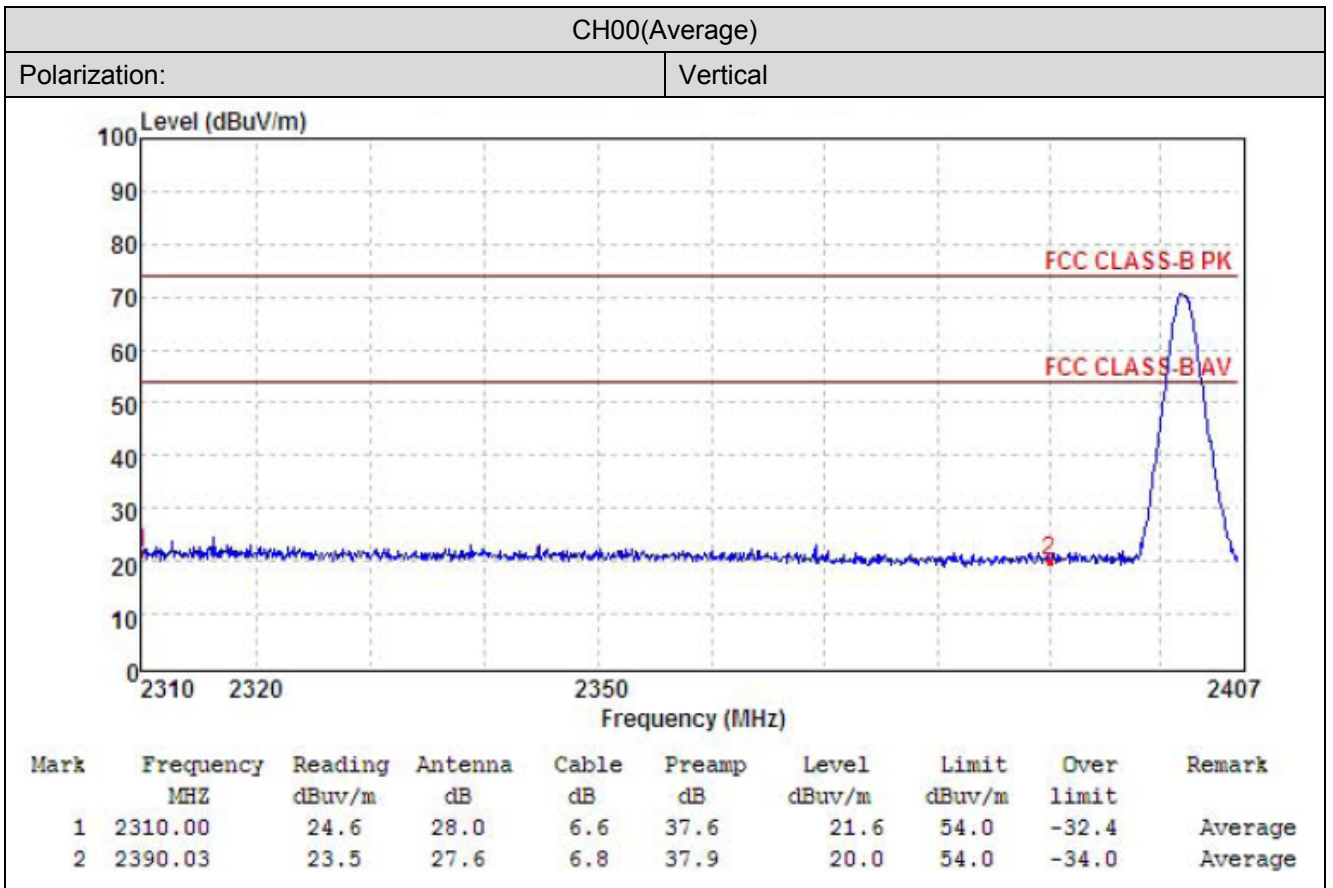

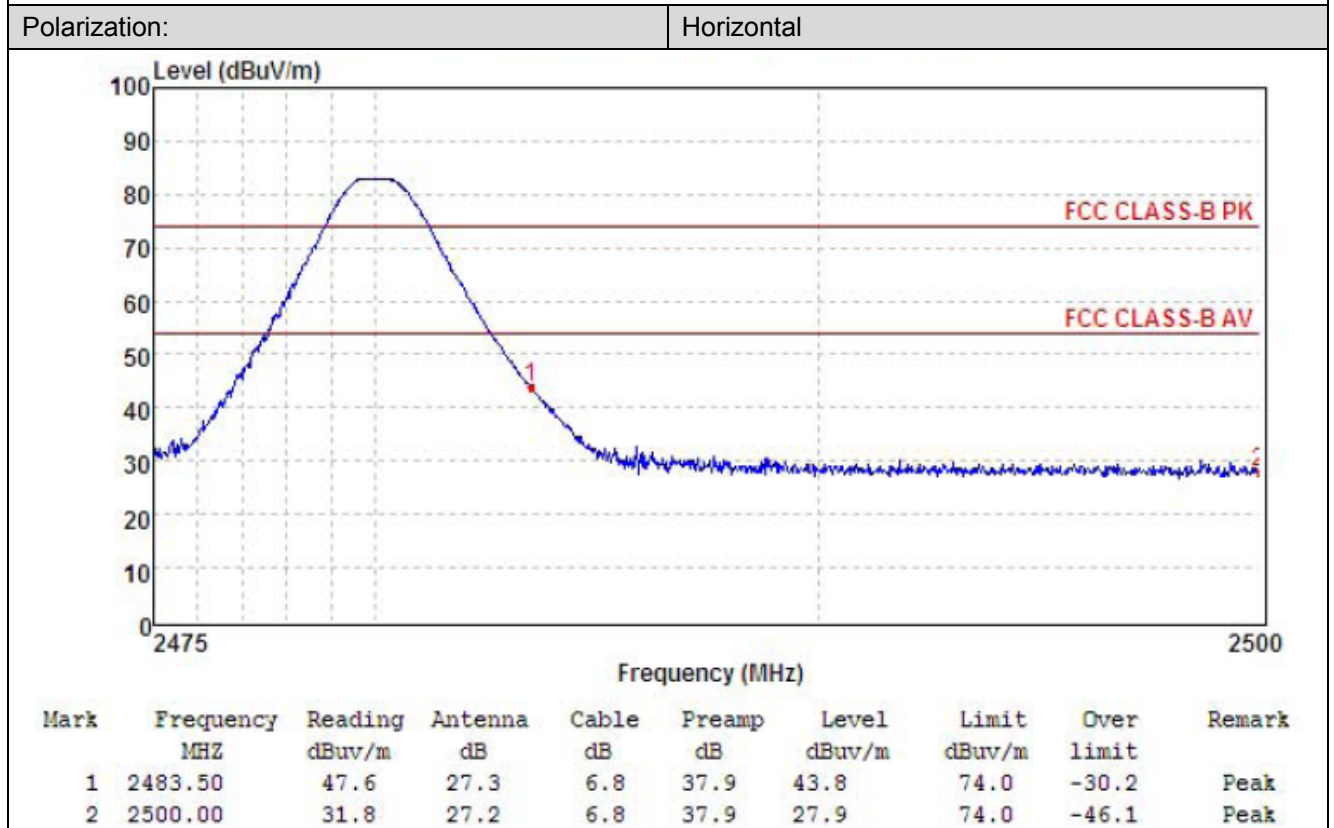
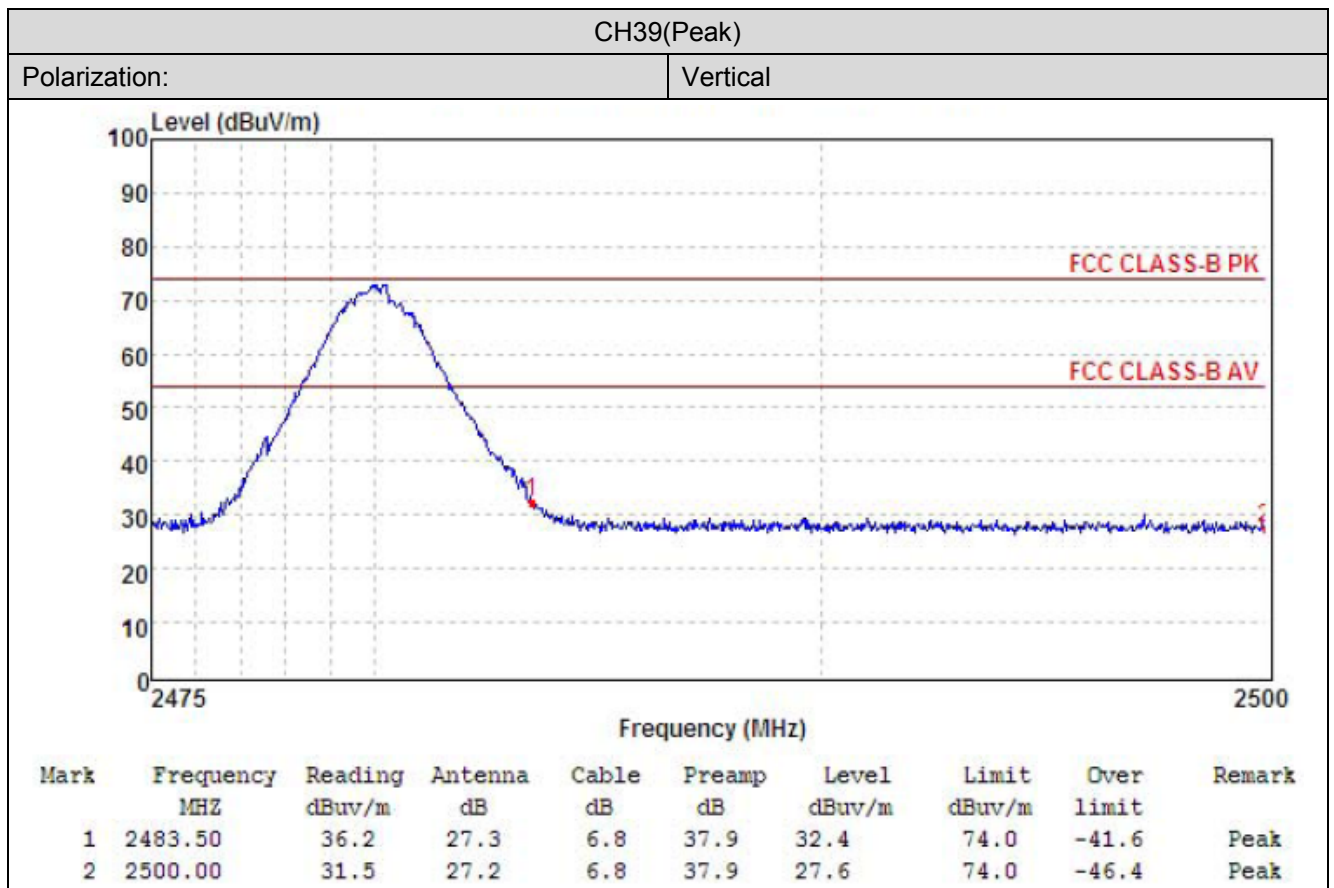

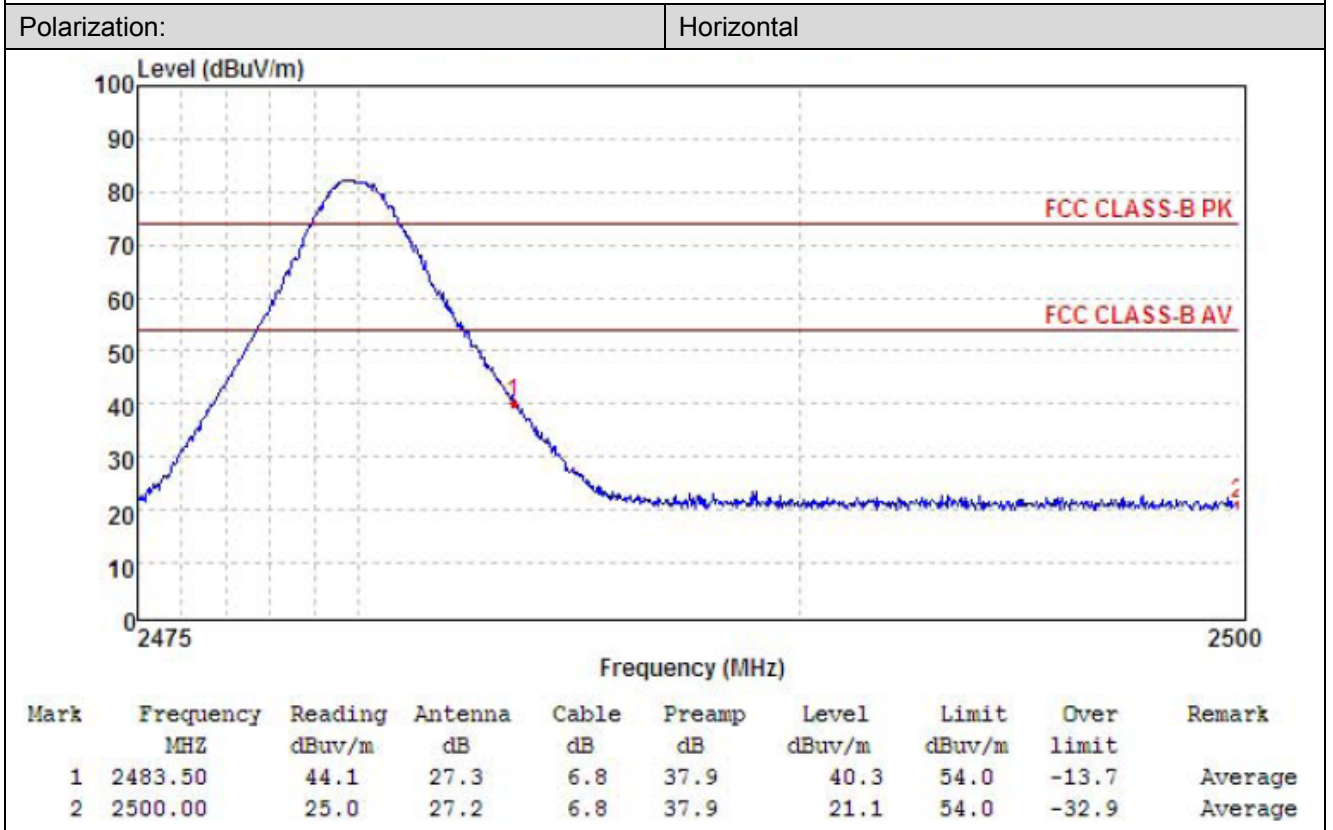
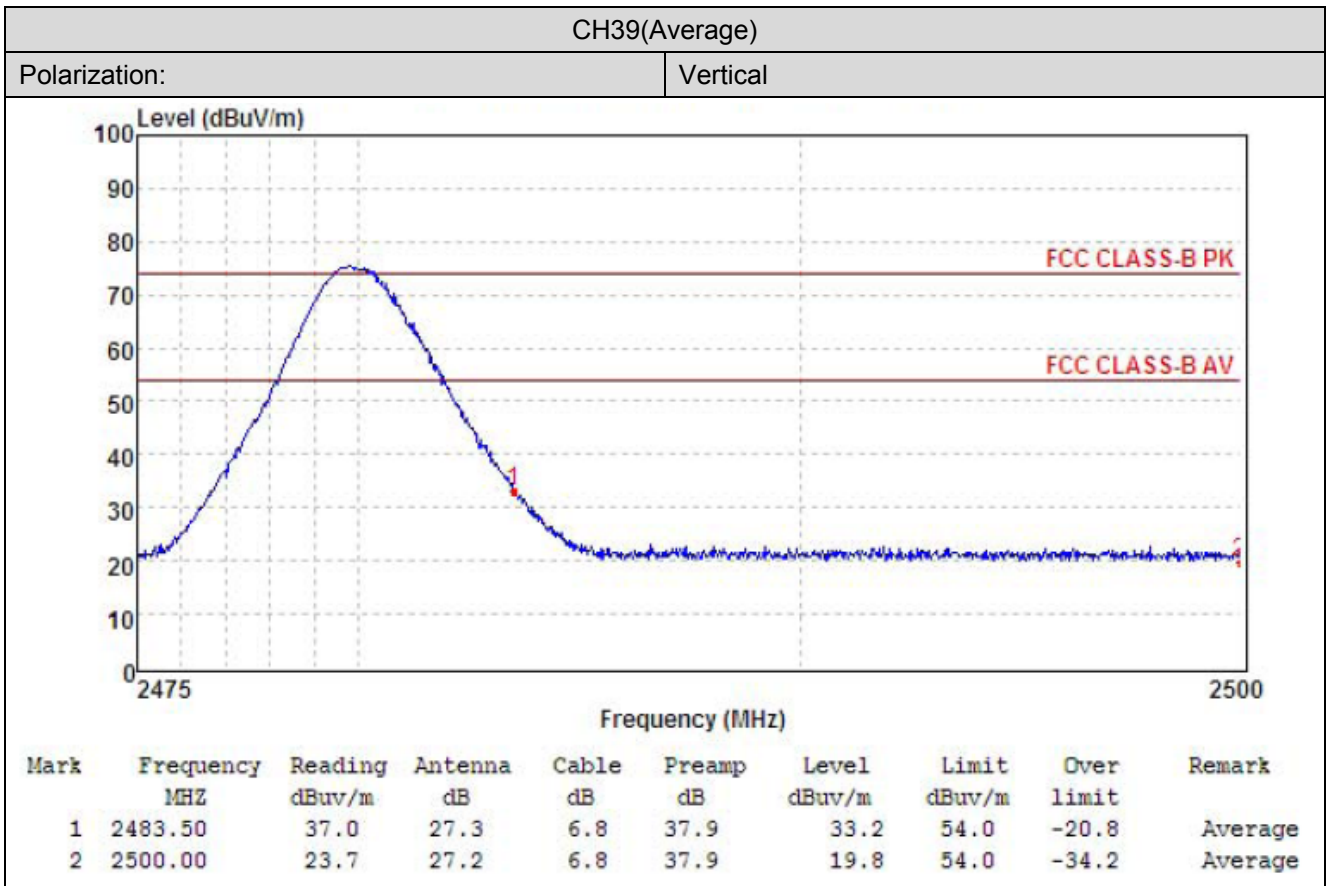

5.7. Band edge and Spurious Emissions (conducted)

LIMIT

FCC CFR Title 47 Part 15 Subpart C Section 15.247 (d): In any 100 kHz bandwidth outside the frequency band in which the spread spectrum intentional radiator is operating, the radio frequency power that is produced by the intentional radiator shall be at least 20 dB below that in the 100 kHz bandwidth within the band that contains the highest level of the desired power, based on either an RF conducted or a radiated measurement.

TEST CONFIGURATION

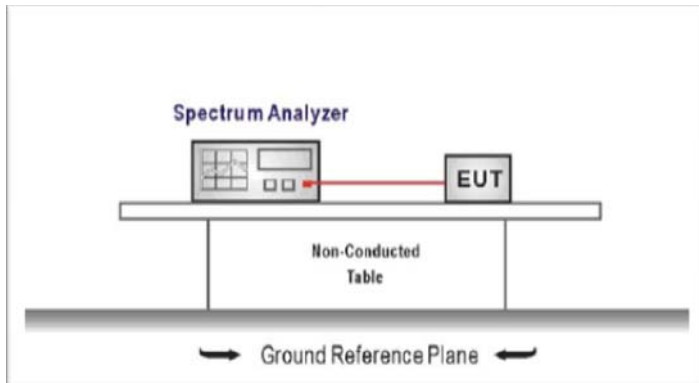

TEST PROCEDURE

1. Connect the antenna port(s) to the spectrum analyzer input.
2. Establish a reference level by using the following procedure
Center frequency=DTS channel center frequency
The span = 1.5 times the DTS bandwidth.
RBW = 100 kHz, VBW $\geq 3 \times$ RBW
Detector = peak, Sweep time = auto couple, Trace mode = max hold
Allow trace to fully stabilize
Use the peak marker function to determine the maximum PSD level

Note that the channel found to contain the maximum PSD level can be used to establish the reference level.

3. Emission level measurement
Set the center frequency and span to encompass frequency range to be measured
RBW = 100 kHz, VBW $\geq 3 \times$ RBW
Detector = peak, Sweep time = auto couple, Trace mode = max hold
Allow trace to fully stabilize
Use the peak marker function to determine the maximum amplitude level.
4. Place the radio in continuous transmit mode, allow the trace to stabilize, view the transmitter waveform on the spectrum analyzer.
5. Ensure that the amplitude of all unwanted emission outside of the authorized frequency band excluding restricted frequency bands) are attenuated by at least the minimum requirements specified (at least 20 dB relative to the maximum in-band peak PSD level in 100 kHz). Report the three highest emission relative to the limit.

TEST MODE:

Please refer to the clause 3.3

TEST RESULTS

Passed Not Applicable

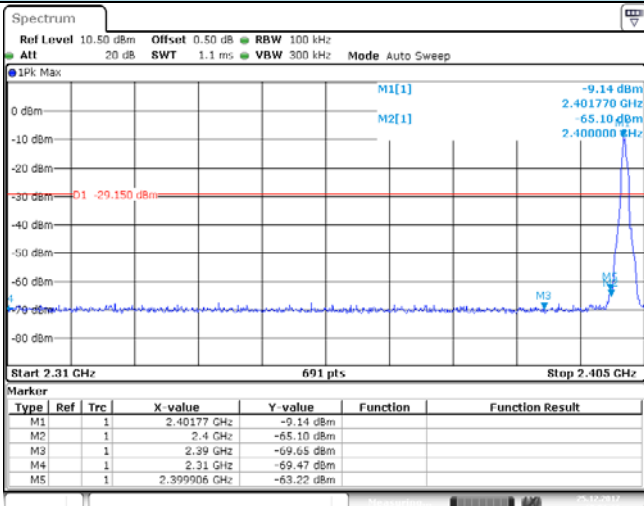
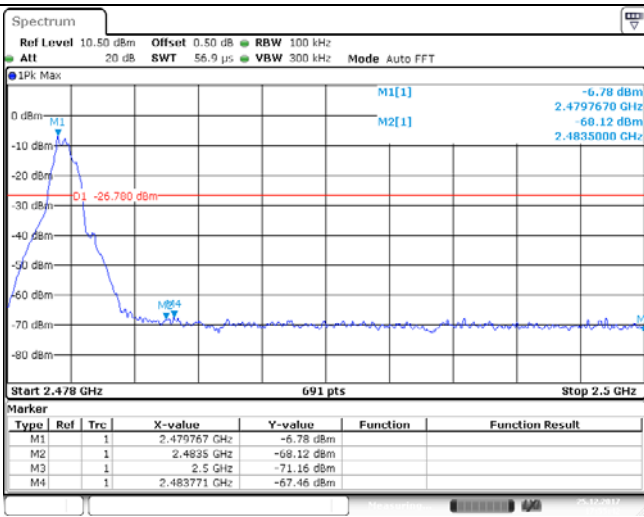
Test Item:	Band edge																																										
CH00	 <p>Spectrum</p> <p>Ref Level 10.50 dBm Offset 0.50 dB RBW 100 kHz Att 20 dB SWT 1.1 ms VBW 300 kHz Mode Auto Sweep</p> <p>1Pk Max</p> <p>M1[1] -9.14 dBm 2.401770 GHz M2[1] -65.10 dBm 2.400000 GHz</p> <p>D1 -29.150 dBm</p> <p>M3 M4</p> <p>Start 2.31 GHz 691 pts Stop 2.405 GHz</p> <table border="1"> <thead> <tr> <th>Type</th> <th>Ref</th> <th>Trc</th> <th>X-value</th> <th>Y-value</th> <th>Function</th> <th>Function Result</th> </tr> </thead> <tbody> <tr> <td>M1</td> <td>1</td> <td></td> <td>2.40177 GHz</td> <td>-9.14 dBm</td> <td></td> <td></td> </tr> <tr> <td>M2</td> <td>1</td> <td></td> <td>2.4 GHz</td> <td>-65.10 dBm</td> <td></td> <td></td> </tr> <tr> <td>M3</td> <td>1</td> <td></td> <td>2.39 GHz</td> <td>-69.65 dBm</td> <td></td> <td></td> </tr> <tr> <td>M4</td> <td>1</td> <td></td> <td>2.31 GHz</td> <td>-69.47 dBm</td> <td></td> <td></td> </tr> <tr> <td>M5</td> <td>1</td> <td></td> <td>2.399906 GHz</td> <td>-63.22 dBm</td> <td></td> <td></td> </tr> </tbody> </table>	Type	Ref	Trc	X-value	Y-value	Function	Function Result	M1	1		2.40177 GHz	-9.14 dBm			M2	1		2.4 GHz	-65.10 dBm			M3	1		2.39 GHz	-69.65 dBm			M4	1		2.31 GHz	-69.47 dBm			M5	1		2.399906 GHz	-63.22 dBm		
Type	Ref	Trc	X-value	Y-value	Function	Function Result																																					
M1	1		2.40177 GHz	-9.14 dBm																																							
M2	1		2.4 GHz	-65.10 dBm																																							
M3	1		2.39 GHz	-69.65 dBm																																							
M4	1		2.31 GHz	-69.47 dBm																																							
M5	1		2.399906 GHz	-63.22 dBm																																							
CH39	 <p>Spectrum</p> <p>Ref Level 10.50 dBm Offset 0.50 dB RBW 100 kHz Att 20 dB SWT 56.9 μs VBW 300 kHz Mode Auto FFT</p> <p>1Pk Max</p> <p>M1[1] -6.78 dBm 2.4797670 GHz M2[1] -68.12 dBm 2.4835000 GHz</p> <p>D1 -26.700 dBm</p> <p>M3 M4</p> <p>Start 2.478 GHz 691 pts Stop 2.5 GHz</p> <table border="1"> <thead> <tr> <th>Type</th> <th>Ref</th> <th>Trc</th> <th>X-value</th> <th>Y-value</th> <th>Function</th> <th>Function Result</th> </tr> </thead> <tbody> <tr> <td>M1</td> <td>1</td> <td></td> <td>2.479767 GHz</td> <td>-6.78 dBm</td> <td></td> <td></td> </tr> <tr> <td>M2</td> <td>1</td> <td></td> <td>2.4835 GHz</td> <td>-68.12 dBm</td> <td></td> <td></td> </tr> <tr> <td>M3</td> <td>1</td> <td></td> <td>2.5 GHz</td> <td>-71.16 dBm</td> <td></td> <td></td> </tr> <tr> <td>M4</td> <td>1</td> <td></td> <td>2.483771 GHz</td> <td>-67.46 dBm</td> <td></td> <td></td> </tr> </tbody> </table>	Type	Ref	Trc	X-value	Y-value	Function	Function Result	M1	1		2.479767 GHz	-6.78 dBm			M2	1		2.4835 GHz	-68.12 dBm			M3	1		2.5 GHz	-71.16 dBm			M4	1		2.483771 GHz	-67.46 dBm									
Type	Ref	Trc	X-value	Y-value	Function	Function Result																																					
M1	1		2.479767 GHz	-6.78 dBm																																							
M2	1		2.4835 GHz	-68.12 dBm																																							
M3	1		2.5 GHz	-71.16 dBm																																							
M4	1		2.483771 GHz	-67.46 dBm																																							

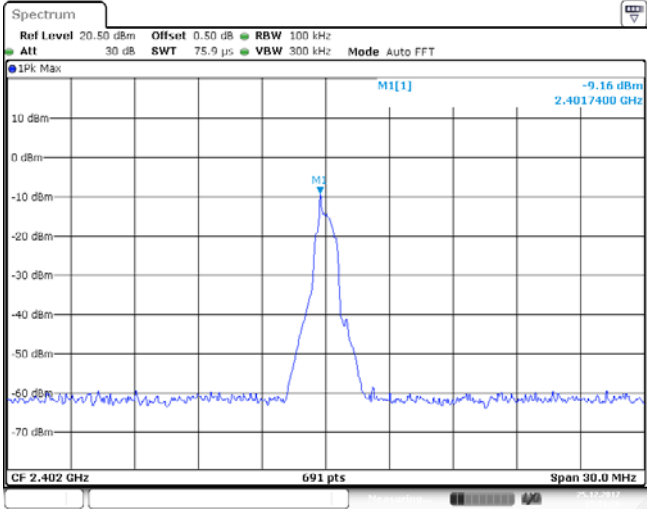
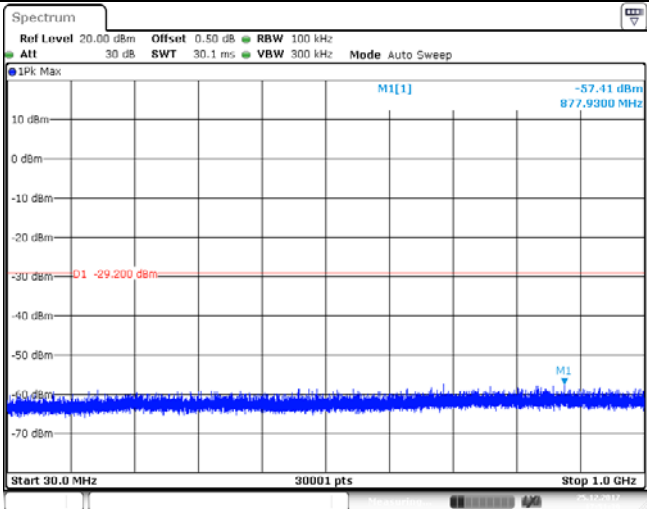
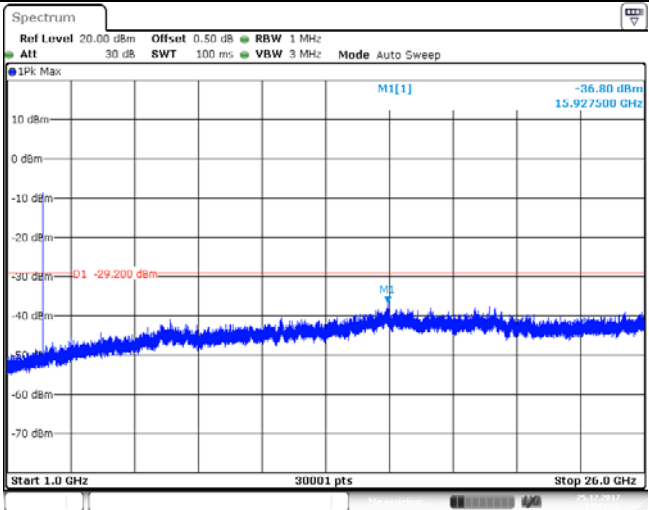
Test Item:	SE
Reference level CH00	 <p>Spectrum plot showing a peak at 2.4017400 GHz with a level of -9.16 dBm. The plot includes parameters: Rel Level 20.50 dBm, Offset 0.50 dB, RBW 100 kHz, Att 30 dB, SWT 75.9 μs, VBW 300 kHz, Mode Auto FFT. The y-axis ranges from -70 dBm to 10 dBm, and the x-axis shows a span of 30.0 MHz.</p>
CH00	 <p>Spectrum plot showing a peak at 877.9300 MHz with a level of -57.41 dBm. The plot includes parameters: Rel Level 20.00 dBm, Offset 0.50 dB, RBW 100 kHz, Att 30 dB, SWT 30.1 ms, VBW 300 kHz, Mode Auto Sweep. The y-axis ranges from -70 dBm to 10 dBm, and the x-axis shows a span from 30.0 MHz to 1.0 GHz.</p>
CH00	 <p>Spectrum plot showing a peak at 15.927500 GHz with a level of -36.80 dBm. The plot includes parameters: Rel Level 20.00 dBm, Offset 0.50 dB, RBW 1 MHz, Att 30 dB, SWT 100 ms, VBW 3 MHz, Mode Auto Sweep. The y-axis ranges from -70 dBm to 10 dBm, and the x-axis shows a span from 1.0 GHz to 26.0 GHz.</p>

Reference level CH19

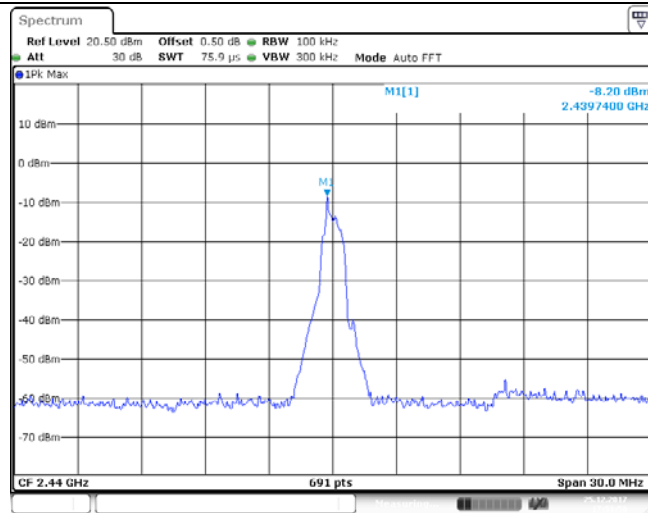

CH19

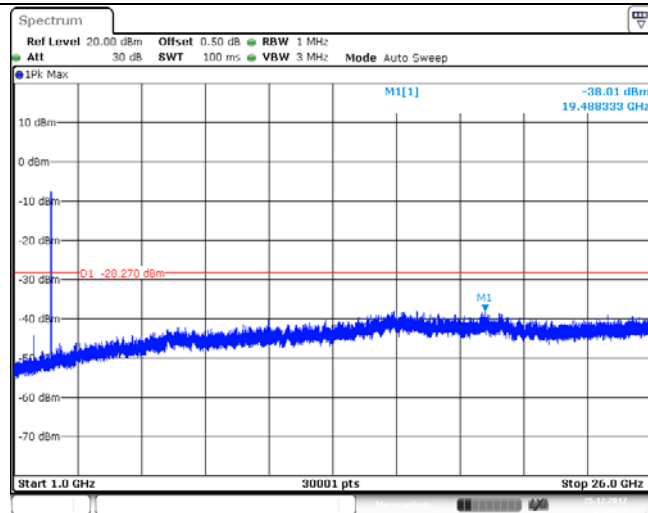
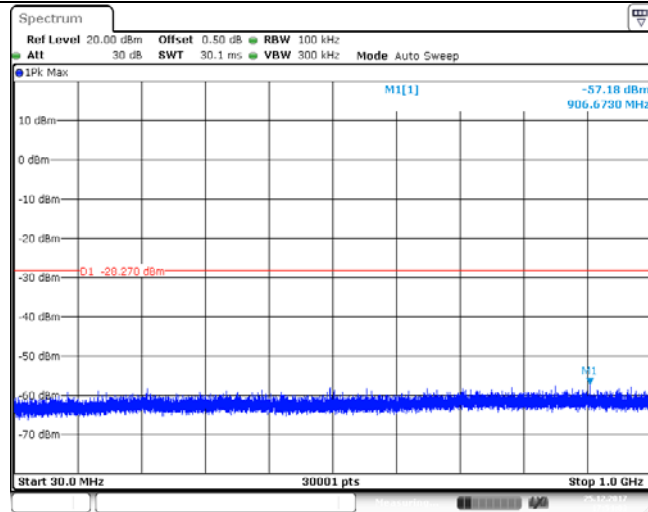

Reference level CH39

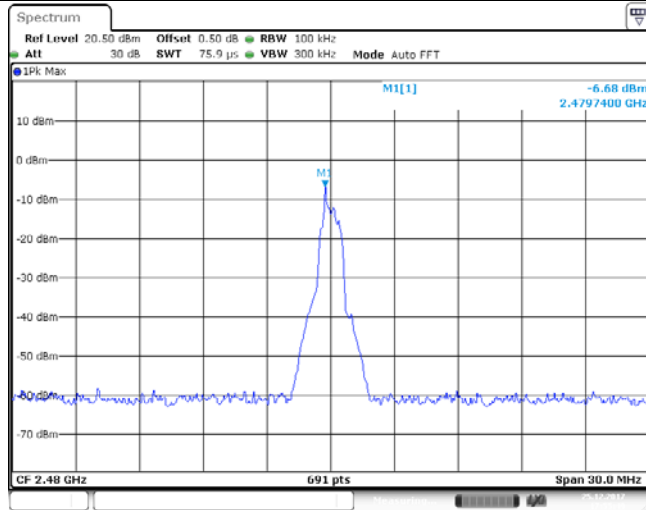

CH39

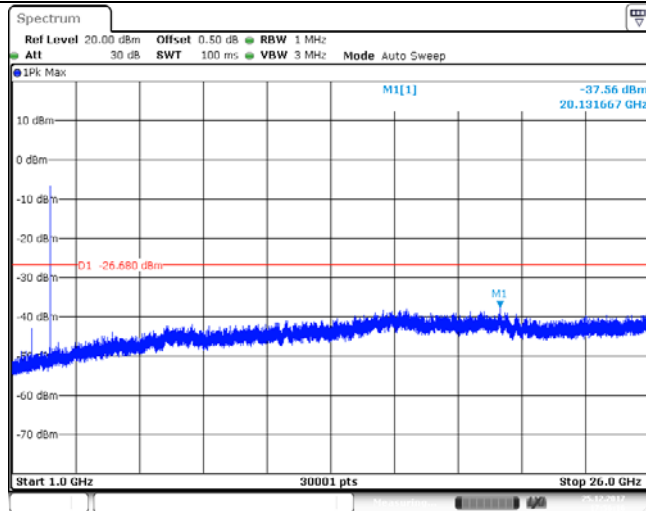
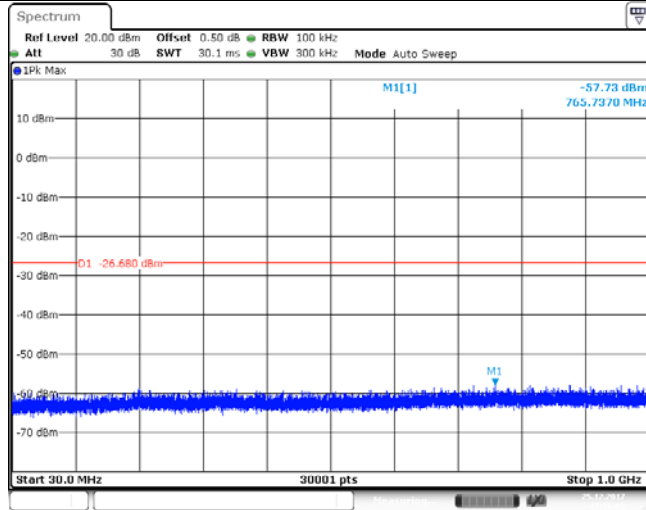

5.8. Spurious Emissions (radiated)

LIMIT

FCC CFR Title 47 Part 15 Subpart C Section 15.209

Frequency	Limit (dBuV/m @3m)	Value
30MHz~88MHz	40.00	Quasi-peak
88MHz~216MHz	43.50	Quasi-peak
216MHz~960MHz	46.00	Quasi-peak
960MHz~1GHz	54.00	Quasi-peak
Above 1GHz	54.00	Average
	74.00	Peak

TEST CONFIGURATION

- 9 kHz ~ 30 MHz

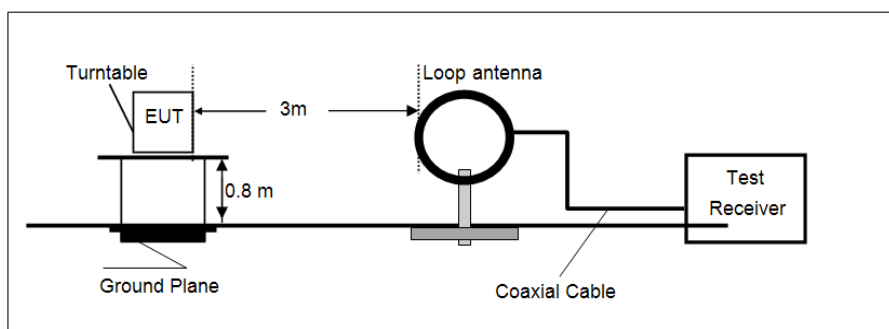

- 30 MHz ~ 1 GHz

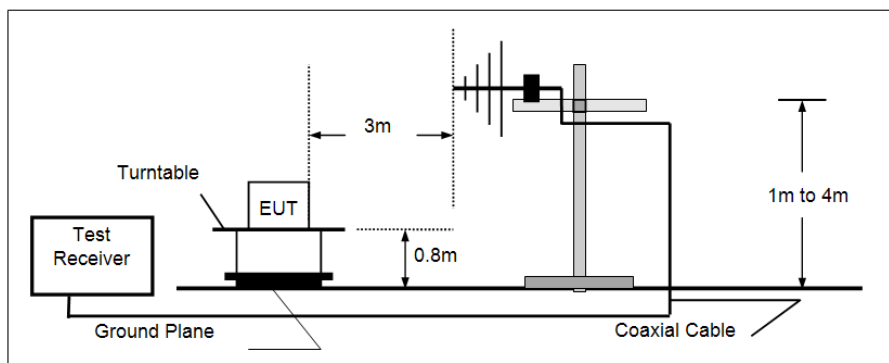

- Above 1 GHz

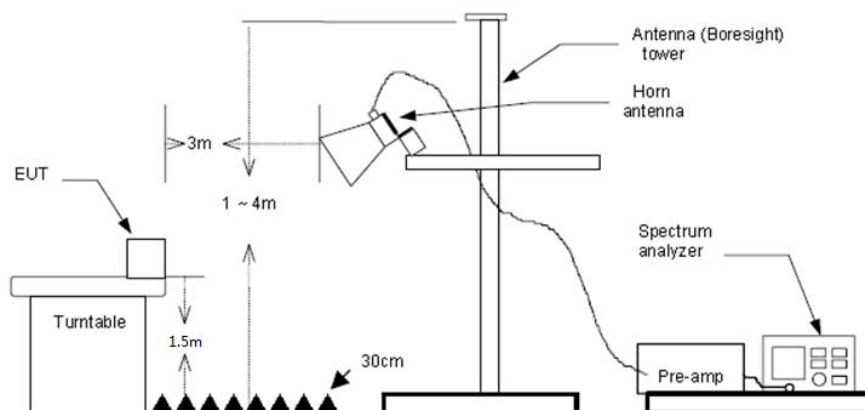

TEST PROCEDURE

1. The EUT was setup and tested according to ANSI C63.10:2013 for compliance to FCC 47CFR 15.247 requirements.
2. The EUT is placed on a turn table which is 0.8 meter above ground for below 1 GHz, and 1.5 m for above 1 GHz. The turn table is rotated 360 degrees to determine the position of the maximum emission level.
3. The EUT was set 3 meters from the receiving antenna, which was mounted on the top of a variable height antenna tower.
4. For each suspected emission, the EUT was arranged to its worst case and then tune the Antenna tower (from 1 m to 4 m) and turntable (from 0 degree to 360 degrees) to find the maximum reading. A pre-amp and a high pass filter are used for the test in order to get better signal level to comply with the guidelines.
5. Set to the maximum power setting and enable the EUT transmit continuously.
6. Use the following spectrum analyzer settings
 - (1) Span shall wide enough to fully capture the emission being measured;
 - (2) Below 1 GHz:
RBW=120 kHz, VBW=300 kHz, Sweep=auto, Detector function=peak, Trace=max hold;
If the emission level of the EUT measured by the peak detector is 3 dB lower than the applicable limit, the peak emission level will be reported. Otherwise, the emission measurement will be repeated using the quasi-peak detector and reported.
 - (3) From 1 GHz to 10th harmonic:
RBW=1MHz, VBW=3MHz Peak detector for Peak value.
RBW=1MHz, VBW=3MHz RMS detector for Average value.

TEST MODE:

Please refer to the clause 3.3

TEST RESULTS

Passed **Not Applicable**

Note:

- 1) Above 1GHz Final Level =Receiver Read level + Antenna Factor + Cable Loss – Preamplifier Factor
 - 2) The emission levels of other frequencies are very lower than the limit and not show in test report.
- **9 kHz ~ 30 MHz**
The EUT was pre-scanned the frequency band (9 kHz ~ 30 MHz), found the radiated level lower than the limit, so don't show on the report.
- **30 MHz ~ 1000 MHz**
Have pre-scan all modulation mode, found the BT-BLE mode CH39 which it was worst case, so only the worst case's data on the test report.

➤ 30 MHz ~ 1 GHz

Polarization: Vertical

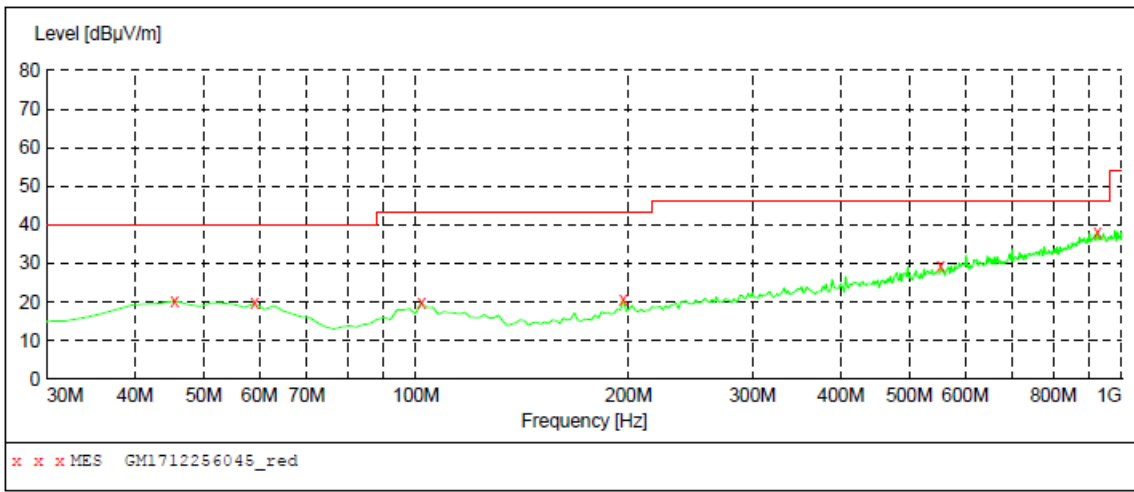

MEASUREMENT RESULT: "GM1712256045_red"

12/25/2017 3:21PM

Frequency MHz	Level dBµV/m	Transd dB	Limit dBµV/m	Margin dB	Det.	Height cm	Azimuth deg	Polarization
45.520000	20.40	-8.8	40.0	19.6	QP	100.0	116.00	VERTICAL
59.100000	19.70	-9.8	40.0	20.3	QP	100.0	211.00	VERTICAL
101.780000	19.80	-10.5	43.5	23.7	QP	100.0	211.00	VERTICAL
196.840000	20.50	-9.8	43.5	23.0	QP	100.0	227.00	VERTICAL
553.800000	29.20	-0.7	46.0	16.8	QP	100.0	227.00	VERTICAL
924.340000	38.10	7.0	46.0	7.9	QP	100.0	0.00	VERTICAL

Polarization: Horizontal

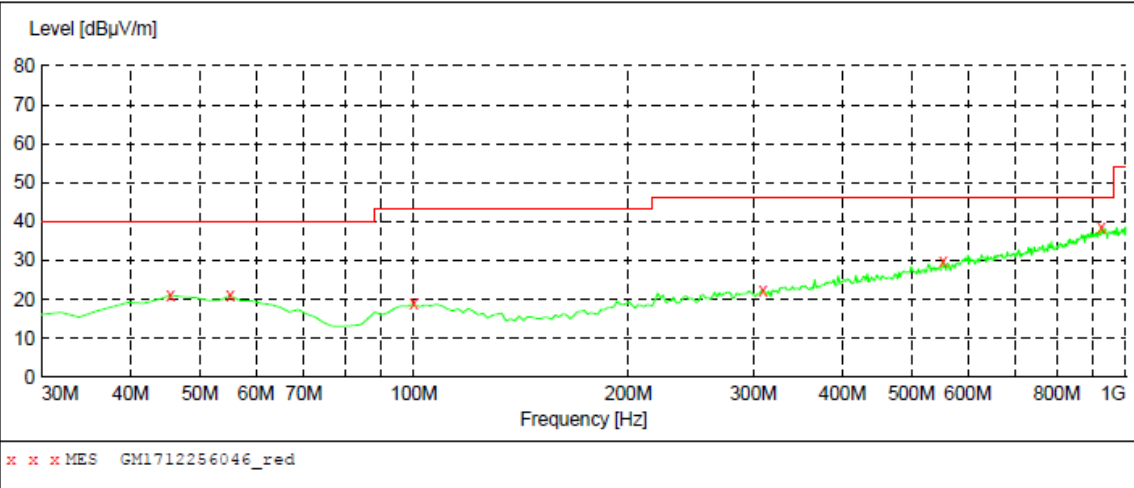

MEASUREMENT RESULT: "GM1712256046_red"

12/25/2017 3:24PM

Frequency MHz	Level dBµV/m	Transd dB	Limit dBµV/m	Margin dB	Det.	Height cm	Azimuth deg	Polarization
45.520000	21.10	-8.8	40.0	18.9	QP	300.0	3.00	HORIZONTAL
55.220000	21.00	-9.2	40.0	19.0	QP	100.0	360.00	HORIZONTAL
99.840000	18.90	-10.6	43.5	24.6	QP	300.0	326.00	HORIZONTAL
309.360000	22.30	-7.1	46.0	23.7	QP	300.0	12.00	HORIZONTAL
553.800000	29.90	-0.7	46.0	16.1	QP	300.0	109.00	HORIZONTAL
924.340000	38.40	7.0	46.0	7.6	QP	100.0	320.00	HORIZONTAL

➤ 1 GHz ~ 25 GHz

CH00									
Frequency (MHz)	Read Level (dBuV)	Antenna Factor (dB/m)	Cable Loss (dB)	Preamplifier Factor (dB)	Level (dBuV/m)	Limit Line (dBuV/m)	Over Limit (dB)	Polarization	Test value
1750.70	43.81	25.30	5.86	37.04	37.93	74.00	-36.07	Vertical	Peak
3367.66	34.27	28.20	7.92	38.49	31.90	74.00	-42.10	Vertical	Peak
4299.89	33.00	30.20	9.03	37.61	34.62	74.00	-39.38	Vertical	Peak
6396.13	30.91	33.29	10.99	35.31	39.88	74.00	-34.12	Vertical	Peak
1719.78	33.34	25.24	5.80	36.97	27.41	74.00	-46.59	Horizontal	Peak
3607.26	34.26	29.30	8.28	38.27	33.57	74.00	-40.43	Horizontal	Peak
3933.37	30.69	29.70	8.69	38.15	30.93	74.00	-43.07	Horizontal	Peak
5850.92	30.81	32.20	10.61	35.35	38.27	74.00	-35.73	Horizontal	Peak

CH19									
Frequency (MHz)	Read Level (dBuV)	Antenna Factor (dB/m)	Cable Loss (dB)	Preamplifier Factor (dB)	Level (dBuV/m)	Limit Line (dBuV/m)	Over Limit (dB)	Polarization	Test value
1514.25	35.62	25.67	5.33	36.61	30.01	74.00	-43.99	Vertical	Peak
3104.22	34.90	28.80	7.61	38.21	33.10	74.00	-40.90	Vertical	Peak
5022.19	31.53	31.59	9.69	36.38	36.43	74.00	-37.57	Vertical	Peak
7301.36	31.29	36.30	11.97	34.95	44.61	74.00	-29.39	Vertical	Peak
1613.75	34.84	24.94	5.60	36.75	28.63	74.00	-45.37	Horizontal	Peak
3993.90	33.50	29.70	8.77	38.11	33.86	74.00	-40.14	Horizontal	Peak
5138.58	31.23	31.74	9.78	36.26	36.49	74.00	-37.51	Horizontal	Peak
7245.81	31.16	36.25	11.91	35.02	44.30	74.00	-29.70	Horizontal	Peak

CH39									
Frequency (MHz)	Read Level (dBuV)	Antenna Factor (dB/m)	Cable Loss (dB)	Preamplifier Factor (dB)	Level (dBuV/m)	Limit Line (dBuV/m)	Over Limit (dB)	Polarization	Test value
1577.20	35.07	25.10	5.51	36.69	28.99	74.00	-45.01	Vertical	Peak
3719.15	33.90	29.36	8.41	38.25	33.42	74.00	-40.58	Vertical	Peak
4983.99	31.61	31.48	9.66	36.44	36.31	74.00	-37.69	Vertical	Peak
6974.36	29.95	35.15	11.82	34.82	42.10	74.00	-31.90	Vertical	Peak
1732.97	35.15	25.27	5.83	37.00	29.25	74.00	-44.75	Horizontal	Peak
3216.84	34.30	28.70	7.74	38.23	32.51	74.00	-41.49	Horizontal	Peak
4958.68	35.24	31.46	9.64	36.52	39.82	74.00	-34.18	Horizontal	Peak
7508.69	30.94	36.11	12.42	34.91	44.56	74.00	-29.44	Horizontal	Peak

Remark:

- Final Level = Receiver Read level + Antenna Factor + Cable Loss – Preamplifier Factor
- The peak level is lower than average limit(54 dBuV/m), this data is the too weak instrument of signal is unable to test.
- The emission levels of other frequencies are very lower than the limit and not show in test report.

6. TEST SETUP PHOTOS

Conducted Emissions (AC Mains)



Radiated Emissions

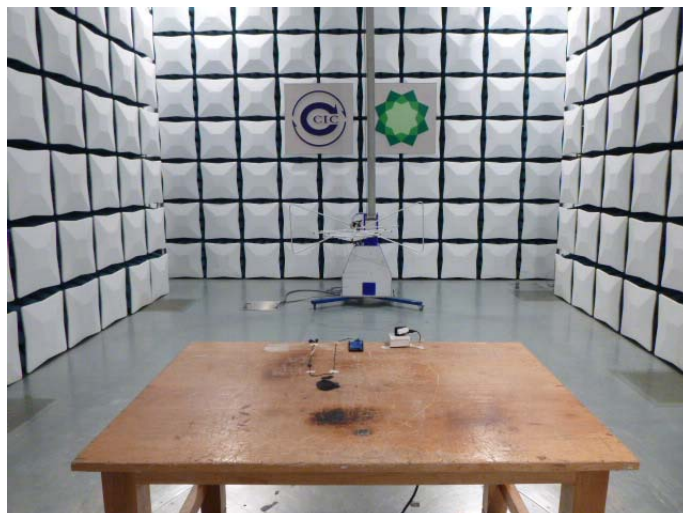



7. EXTERANAL AND INTERNAL PHOTOS

Reference to the test report No.: TRE1712020701

-----End of Report-----