



TEST REPORT

Report Reference No...... : **TRE1709023204** R/C.....: 36935

FCC ID..... : **ZSW-30-055**

Applicant's name..... : **b mobile HK Limited**

Address.....: Flat 18; 14/F Block 1; Golden Industrial Building;16-26 Kwai Tak Street; Kwai Chung; New Territories; Hong Kong.

Manufacturer.....: b mobile HK Limited

Address.....: Flat 18; 14/F Block 1; Golden Industrial Building;16-26 Kwai Tak Street; Kwai Chung; New Territories; Hong Kong.

Test item description : **Mobile Phone**

Trade Mark: Bmobile

Model/Type reference.....: AX1071

Listed Model(s): AX1072

Standard : **FCC CFR Title 47 Part 15 Subpart C Section 15.247**

Date of receipt of test sample.....: Sep.28, 2017

Date of testing.....: Sep.29, 2017 - Oct.15, 2017

Date of issue.....: Oct.16, 2017

Result.....: **PASS**

Compiled by
(Position+Printed name+Signature): File administrators Candy Liu *Candy Liu*

Supervised by
(Position+Printed name+Signature): Project Engineer : Edward Pan *Edward Pan*

Approved by
(Position+Printed name+Signature): RF Manager Hans Hu *Hans Hu*

Testing Laboratory Name : **Shenzhen Huatongwei International Inspection Co., Ltd.**

Address.....: 1/F, Bldg 3, Hongfa Hi-tech Industrial Park, Genyu Road, Tianliao, Gongming, Shenzhen, China

Shenzhen Huatongwei International Inspection Co., Ltd. All rights reserved.

This publication may be reproduced in whole or in part for non-commercial purposes as long as the Shenzhen Huatongwei International Inspection Co., Ltd. is acknowledged as copyright owner and source of the material. Shenzhen Huatongwei International Inspection Co., Ltd. takes no responsibility for and will not assume liability for damages resulting from the reader's interpretation of the reproduced material due to its placement and context.

The test report merely correspond to the test sample.

Contents

1.	<u>TEST STANDARDS AND REPORT VERSION</u>	3
1.1.	Test Standards	3
1.2.	Report version	3
2.	<u>TEST DESCRIPTION</u>	4
3.	<u>SUMMARY</u>	5
3.1.	Client Information	5
3.2.	Product Description	5
3.3.	Operation state	6
3.4.	EUT configuration	6
3.5.	Modifications	6
4.	<u>TEST ENVIRONMENT</u>	7
4.1.	Address of the test laboratory	7
4.2.	Test Facility	7
4.3.	Environmental conditions	8
4.4.	Statement of the measurement uncertainty	8
4.5.	Equipments Used during the Test	9
5.	<u>TEST CONDITIONS AND RESULTS</u>	10
5.1.	Antenna requirement	10
5.2.	Conducted Emissions (AC Main)	11
5.3.	Conducted Peak Output Power	14
5.4.	20 dB Bandwidth	18
5.5.	Carrier Frequencies Separation	22
5.6.	Hopping Channel Number	24
5.7.	Dwell Time	26
5.8.	Pseudorandom Frequency Hopping Sequence	30
5.9.	Restricted band (radiated)	31
5.10.	Band edge and Spurious Emissions (conducted)	35
5.11.	Spurious Emissions (radiated)	55
6.	<u>TEST SETUP PHOTOS</u>	59
7.	<u>EXTERANAL AND INTERNAL PHOTOS</u>	60

1. TEST STANDARDS AND REPORT VERSION

1.1. Test Standards

The tests were performed according to following standards:

[FCC Rules Part 15.247](#): Frequency Hopping, Direct Spread Spectrum and Hybrid Systems that are in operation within the bands of 902-928 MHz, 2400-2483.5 MHz, and 5725-5850 MHz

[ANSI C63.10-2013](#): American National Standard for Testing Unlicensed Wireless Devices

1.2. Report version

Version No.	Date of issue	Description
00	Oct.16, 2017	Original

2. TEST DESCRIPTION

Test Item	Section in CFR 47	Result	Test Engineer
Antenna Requirement	15.203/15.247 (c)	Pass	William Wang
AC Power Line Conducted Emissions	15.207	Pass	William Wang
Conducted Peak Output Power	15.247 (b)(1)	Pass	William Wang
20 dB Bandwidth	15.247 (a)(1)	Pass	William Wang
Carrier Frequencies Separation	15.247 (a)(1)	Pass	William Wang
Hopping Channel Number	15.247 (a)(1)	Pass	William Wang
Dwell Time	15.247 (a)(1)	Pass	William Wang
Pseudorandom Frequency Hopping Sequence	15.247(b)(4)	Pass	William Wang
Restricted band	15.247(d)/15.205	Pass	William Wang
Radiated Emissions	15.247(d)/15.209	Pass	William Wang

Note: The measurement uncertainty is not included in the test result.

3. SUMMARY

3.1. Client Information

Applicant:	b mobile HK Limited
Address:	Flat 18; 14/F Block 1; Golden Industrial Building;16-26 Kwai Tak Street; Kwai Chung; New Territories; Hong Kong.
Manufacturer:	b mobile HK Limited
Address:	Flat 18; 14/F Block 1; Golden Industrial Building;16-26 Kwai Tak Street; Kwai Chung; New Territories; Hong Kong.

3.2. Product Description

Name of EUT:	Mobile Phone
Trade Mark:	Bmobile
Model No.:	AX1071
Listed Model(s):	AX1072
IMEI 1:	356844077425636
IMEI 2:	321222222222228
Power supply:	DC 3.8V From exchange battery
Adapter information:	Input: 100-240Va.c., 50/60Hz, 0.2A Output: 5Vd.c.,1A
Hardware version:	V00
Software version:	MX2135FA_B25_E5017_SA22_N_V01_170915
Bluetooth	
Version:	Supported BT4.0+EDR
Modulation:	GFSK, $\pi/4$ DQPSK, 8DPSK
Operation frequency:	2402MHz~2480MHz
Channel number:	79
Channel separation:	1MHz
Antenna type:	PIFA Antenna
Antenna gain:	0.5dBi

3.3. Operation state

➤ **Test frequency list**

According to section 15.31(m), regards to the operating frequency range over 10 MHz, must select three channel which were tested. the Lowest frequency, the middle frequency, and the highest frequency of channel were selected to perform the test, please see the above gray bottom.

Channel	Frequency (MHz)
00	2402
01	2403
⋮	⋮
39	2441
⋮	⋮
77	2479
78	2480

➤ **TEST MODE**

For RF test items:
The engineering test program was provided and enabled to make EUT continuous transmit
For AC power line conducted emissions:
The EUT was set to connect with the Bluetooth instrument under large package sizes transmission.
For Radiated suprious emissions test item:
The EUT in each of three orthogonal axis emissions had been tested ,but only the worst case (X axis) data recorded in the report.

3.4. EUT configuration

The following peripheral devices and interface cables were connected during the measurement:

- - supplied by the manufacturer
- - supplied by the lab

/	Manufacturer:	/
	Model No.:	/
/	Manufacturer:	/
	Model No.:	/

3.5. Modifications

No modifications were implemented to meet testing criteria.

4. TEST ENVIRONMENT

4.1. Address of the test laboratory

Laboratory: Shenzhen Huatongwei International Inspection Co., Ltd.

Address: 1/F, Bldg 3, Hongfa Hi-tech Industrial Park, Genyu Road, Tianliao, Gongming, Shenzhen, China

4.2. Test Facility

CNAS-Lab Code: L1225

Shenzhen Huatongwei International Inspection Co., Ltd. has been assessed and proved to be in compliance with CNAS-CL01 Accreditation Criteria for Testing and Calibration Laboratories (identical to ISO/IEC17025: 2005 General Requirements) for the Competence of Testing and Calibration Laboratories.

A2LA-Lab Cert. No.: 3902.01

Shenzhen Huatongwei International Inspection Co., Ltd. EMC Laboratory has been accredited by A2LA for technical competence in the field of electrical testing, and proved to be in compliance with ISO/IEC 17025: 2005 General Requirements for the Competence of Testing and Calibration Laboratories and any additional program requirements in the identified field of testing.

FCC-Registration No.: 762235

Shenzhen Huatongwei International Inspection Co., Ltd. EMC Laboratory has been registered and fully described in a report filed with the FCC (Federal Communications Commission). The acceptance letter from the FCC is maintained in our files.

IC-Registration No.:5377B-1

Two 3m Alternate Test Site of Shenzhen Huatongwei International Inspection Co., Ltd. has been registered by Certification and Engineering Bureau of Industry Canada for the performance of radiated measurements with Registration No.: 5377B-1.

ACA

Shenzhen Huatongwei International Inspection Co., Ltd. EMC Laboratory can also perform testing for the Australian C-Tick mark as a result of our A2LA accreditation.

4.3. Environmental conditions

During the measurement the environmental conditions were within the listed ranges:

Temperature:	15~35°C
Relative Humidity:	30~60 %
Air Pressure:	950~1050mba

4.4. Statement of the measurement uncertainty

The data and results referenced in this document are true and accurate. The reader is cautioned that there may be errors in calibration limits of the equipment and facilities. The measurement uncertainty was calculated for all measurements listed in this test report according to TR-100028-01 "Electromagnetic compatibility and Radio spectrum Matters (ERM); Uncertainties in the measurement of mobile radio equipment characteristics; Part 1" and TR-100028-02 "Electromagnetic compatibility and Radio spectrum Matters (ERM); Uncertainties in the measurement of mobile radio equipment characteristics; Part 2" and is documented in the Shenzhen Huatongwei International Inspection Co., Ltd. quality system according to ISO/IEC 17025. Furthermore, component and process variability of devices similar to that tested may result in additional deviation. The manufacturer has the sole responsibility of continued compliance of the device.

Here after the best measurement capability for Shenzhen Huatongwei International Inspection Co., Ltd. is reported:

Test Items	Measurement Uncertainty	Notes
Transmitter power conducted	0.57 dB	(1)
Transmitter power Radiated	2.20 dB	(1)
Conducted spurious emissions 9kHz~40GHz	1.60 dB	(1)
Radiated spurious emissions 9kHz~40GHz	2.20 dB	(1)
Conducted Emissions 9kHz~30MHz	3.39 dB	(1)
Radiated Emissions 30~1000MHz	4.24 dB	(1)
Radiated Emissions 1~18GHz	5.16 dB	(1)
Radiated Emissions 18~40GHz	5.54 dB	(1)
Occupied Bandwidth	-----	(1)

(1) This uncertainty represents an expanded uncertainty expressed at approximately the 95% confidence level using a coverage factor of k=1.96.

4.5. Equipments Used during the Test

Conducted Emissions					
Item	Test Equipment	Manufacturer	Model No.	Serial No.	Last Cal.
1	Artificial Mains	Rohde&Schwarz	ESH2-Z5	100028	2016/11/13
2	EMI Test Receiver	Rohde&Schwarz	ESCI3	100038	2016/11/13
3	Pulse Limiter	Rohde&Schwarz	ESHSZ2	100044	2016/11/13
4	EMI Test Software	Rohde&Schwarz	ES-K1 V1.71	-	-

Radiated Emissions					
Item	Test Equipment	Manufacturer	Model No.	Serial No.	Last Cal.
1	EMI test receiver	Rohde&Schwarz	ESI 26	100009	2016/11/13
2	Loop Antenna	Rohde&Schwarz	HFH2-Z2	100020	2016/11/13
3	Ultra-Broadband Antenna	ShwarzBeck	VULB9163	538	2016/11/13
4	Horn antenna	ShwarzBeck	9120D	1011	2016/11/13
5	Horn Antenna	SCHWARZBECK	BBHA9170	25841	2016/11/13
6	Amplifier	Sonoma	310N	E009-13	2016/11/13
7	JS Amplifier	Rohde&Schwarz	JS4-00101800-28-5A	F201504	2016/11/13
8	Amplifier	Compliance Direction systems	PAP1-4060	120	2016/11/13
9	High pass filter	Compliance Direction systems	BSU-6	34202	2016/11/13
10	EMI test Software	Rohde&Schwarz	ESK1	-	-
11	EMI test Software	Audix	E3	-	-
12	TURNTABLE	MATURO	TT2.0	-	-
13	ANTENNA MAST	MATURO	TAM-4.0-P	-	-

RF Conducted methods					
Item	Test Equipment	Manufacturer	Model No.	Serial No.	Last Cal.
1	Spectrum Analyzer	Rohde&Schwarz	FSP	1164.4391.40	2016/11/13
2	MXA Signal Analyzer	Agilent Technologies	N9020A	MY5050187	2016/11/13

The Cal.Interval was one year.

5. TEST CONDITIONS AND RESULTS

5.1. Antenna requirement

Requirement

FCC CFR Title 47 Part 15 Subpart C Section 15.203:

An intentional radiator shall be designed to ensure that no antenna other than that furnished by the responsible party shall be used with the device. The use of a permanently attached antenna or of an antenna that uses a unique coupling to the intentional radiator, the manufacturer may design the unit so that a broken antenna can be replaced by the user, but the use of a standard antenna jack or electrical connector is prohibited.

FCC CFR Title 47 Part 15 Subpart C Section 15.247(c) (1)(i):

(i) Systems operating in the 2400~2483.5 MHz band that is used exclusively for fixed. Point-to-point operations may employ transmitting antennas with directional gain greater than 6 dBi provided the maximum conducted output power of the intentional radiator is reduced by 1 dB for every 3 dB that the directional gain of the antenna exceeds 6 dBi.

Test Result:

Passed **Not Applicable**

The directional gain of the antenna less than 6 dBi, please refer to the below antenna photo.



5.2. Conducted Emissions (AC Main)

LIMIT

FCC CFR Title 47 Part 15 Subpart C Section 15.207

Frequency range (MHz)	Limit (dBuV)	
	Quasi-peak	Average
0.15-0.5	66 to 56*	56 to 46*
0.5-5	56	46
5-30	60	50

* Decreases with the logarithm of the frequency.

TEST CONFIGURATION

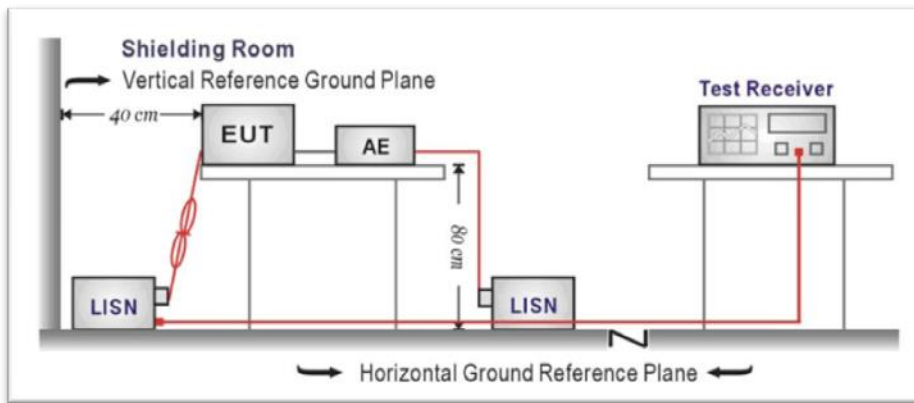

TEST PROCEDURE

1. The EUT was setup according to ANSI C63.10:2013 requirements.
2. The EUT was placed on a platform of nominal size, 1 m by 1.5 m, raised 80 cm above the conducting ground plane. The vertical conducting plane was located 40 cm to the rear of the EUT. All other surfaces of EUT were at least 80 cm from any other grounded conducting surface.
3. The EUT and simulators are connected to the main power through a line impedances stabilization network (LISN). The LISN provides a 50 ohm /50uH coupling impedance for the measuring equipment.
4. The peripheral devices are also connected to the main power through a LISN. (Please refer to the block diagram of the test setup and photographs)
5. Each current-carrying conductor of the EUT power cord, except the ground (safety) conductor, was individually connected through a LISN to the input power source.
6. The excess length of the power cord between the EUT and the LISN receptacle were folded back and forth at the center of the lead to form a bundle not exceeding 40 cm in length.
7. Conducted emissions were investigated over the frequency range from 0.15MHz to 30MHz using a receiver bandwidth of 9 kHz.
8. During the above scans, the emissions were maximized by cable manipulation.

TEST RESULTS

Passed Not Applicable

Note:

- 1) Transd= Cable lose + Pulse Limiter Factor + Artificial Mains Factor
- 2) Margin= Limit - Level

Test Line: L

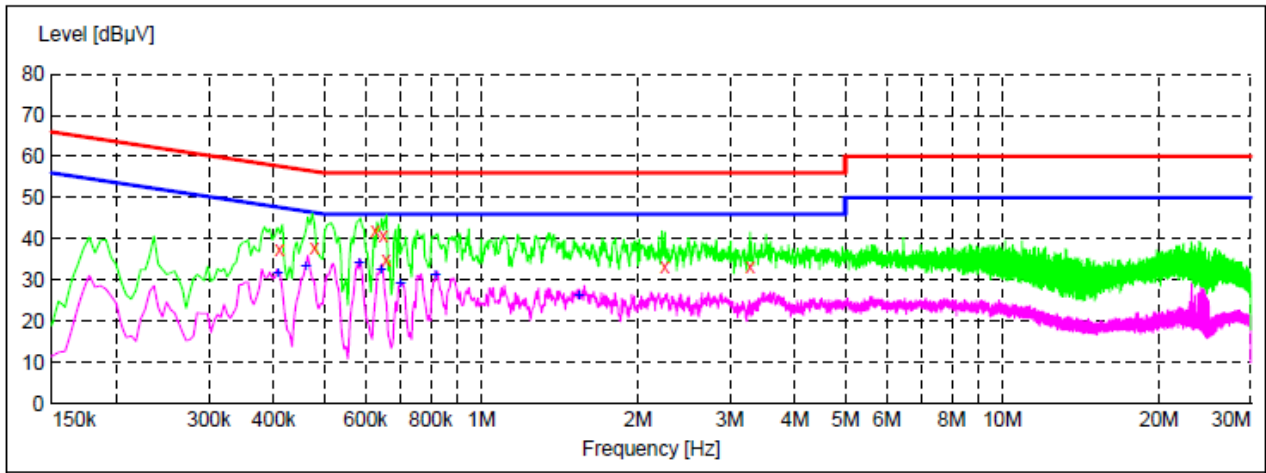

x x x MES GM1710125037_fin

MEASUREMENT RESULT: "GM1710125037_fin"

10/12/2017 1:51PM

Frequency MHz	Level dBµV	Transd dB	Limit dBµV	Margin dB	Detector	Line	PE
0.411000	37.60	10.2	58	20.0	QP	L1	GND
0.478500	38.00	10.2	56	18.4	QP	L1	GND
0.627000	42.00	10.2	56	14.0	QP	L1	GND
0.649500	40.70	10.2	56	15.3	QP	L1	GND
0.658500	35.00	10.2	56	21.0	QP	L1	GND
2.251500	33.10	10.2	56	22.9	QP	L1	GND
3.282000	33.40	10.3	56	22.6	QP	L1	GND

MEASUREMENT RESULT: "GM1710125037_fin2"

10/12/2017 1:51PM

Frequency MHz	Level dBµV	Transd dB	Limit dBµV	Margin dB	Detector	Line	PE
0.406500	31.70	10.2	48	16.0	AV	L1	GND
0.460500	33.30	10.2	47	13.4	AV	L1	GND
0.582000	34.20	10.2	46	11.8	AV	L1	GND
0.640500	32.40	10.2	46	13.6	AV	L1	GND
0.699000	29.00	10.2	46	17.0	AV	L1	GND
0.816000	31.20	10.2	46	14.8	AV	L1	GND
1.536000	26.30	10.2	46	19.7	AV	L1	GND

Test Line: N

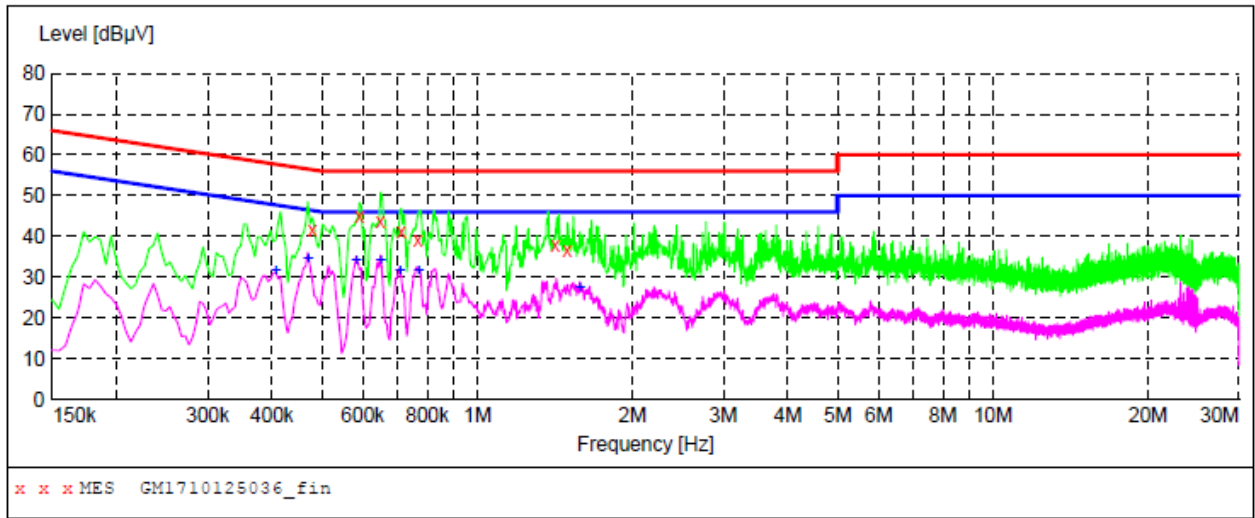

MEASUREMENT RESULT: "GM1710125036_fin"

10/12/2017 1:48PM

Frequency MHz	Level dBµV	Transd dB	Limit dBµV	Margin dB	Detector	Line	PE
0.478500	41.50	10.2	56	14.9	QP	N	GND
0.591000	45.10	10.2	56	10.9	QP	N	GND
0.649500	43.60	10.2	56	12.4	QP	N	GND
0.712500	41.20	10.2	56	14.8	QP	N	GND
0.766500	39.00	10.2	56	17.0	QP	N	GND
1.419000	38.00	10.2	56	18.0	QP	N	GND
1.495500	36.60	10.2	56	19.4	QP	N	GND

MEASUREMENT RESULT: "GM1710125036_fin2"

10/12/2017 1:48PM

Frequency MHz	Level dBµV	Transd dB	Limit dBµV	Margin dB	Detector	Line	PE
0.406500	31.40	10.2	48	16.3	AV	N	GND
0.469500	34.40	10.2	47	12.1	AV	N	GND
0.582000	34.10	10.2	46	11.9	AV	N	GND
0.649500	34.10	10.2	46	11.9	AV	N	GND
0.708000	31.50	10.2	46	14.5	AV	N	GND
0.771000	31.50	10.2	46	14.5	AV	N	GND
1.581000	27.60	10.2	46	18.4	AV	N	GND

5.3. Conducted Peak Output Power

LIMIT

FCC CFR Title 47 Part 15 Subpart C Section 15.247 (b)(1): For frequency hopping systems operating in the 2400-2483.5 MHz band employing at least 75 non-overlapping hopping channels, and all frequency hopping systems in the 5725-5850 MHz band: 1 watt. For all other frequency hopping systems in the 2400-2483.5 MHz band: 0.125 watts.

TEST CONFIGURATION

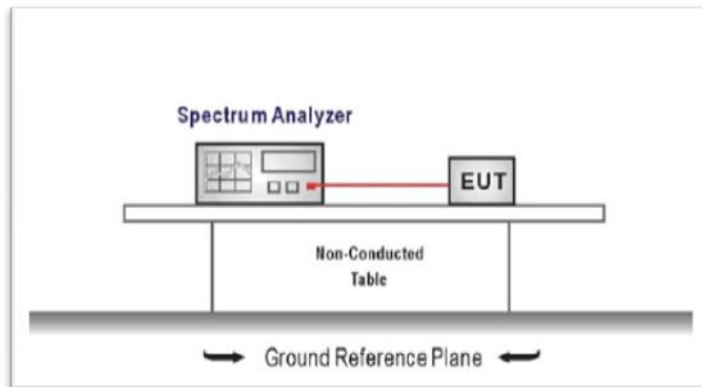

TEST PROCEDURE

1. The transmitter output was connected to the spectrum analyzer through an attenuator, the pathloss was compensated to the results for each measurement.
2. Set to the maximum power setting and enable the EUT transmit continuously
3. Use the following spectrum analyzer settings:
Span = approximately 5 times the 20 dB bandwidth, centered on a hopping channel
RBW \geq the 20 dB bandwidth of the emission being measured, VBW \geq RBW
Sweep = auto, Detector function = peak, Trace = max hold
4. Measure and record the results in the test report.



TEST MODE:

Please refer to the clause 3.3

TEST RESULTS

Passed Not Applicable

Modulation type	Channel	Output power (dBm)	Limit (dBm)	Result
GFSK	00	5.011	≤ 30.00	Pass
	39	5.707		
	78	5.270		
$\pi/4$ DQPSK	00	4.169	≤ 21.00	Pass
	39	4.935		
	78	4.451		
8DPSK	00	4.429	≤ 21.00	Pass
	39	5.121		
	78	4.696		

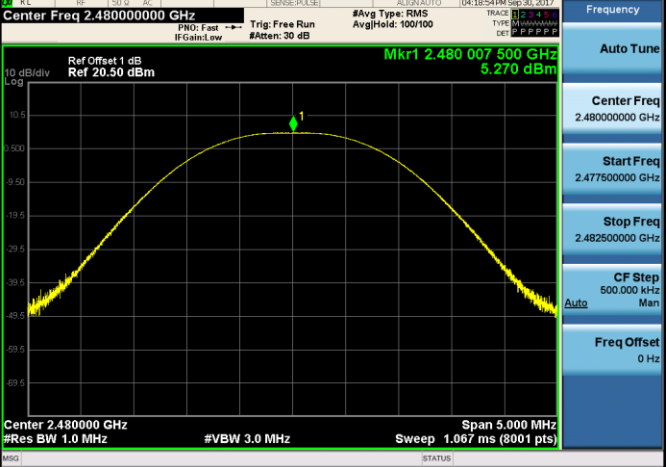
Modulation Type:		GFSK	
CH00		<p>Agilent Spectrum Analyzer - Swept SA</p> <p>Center Freq 2.40200000 GHz</p> <p>Mkr1 2.402 078 750 GHz 5.011 dBm</p> <p>Center Freq 2.40200000 GHz</p> <p>Start Freq 2.399500000 GHz</p> <p>Stop Freq 2.404500000 GHz</p> <p>CF Step 500.000 kHz</p> <p>Freq Offset 0 Hz</p> <p>Center 2.402000 GHz</p> <p>#Res BW 1.0 MHz</p> <p>#VBW 3.0 MHz</p> <p>Span 5.000 MHz</p> <p>Sweep 1.067 ms (8001 pts)</p>	
CH39		<p>Agilent Spectrum Analyzer - Swept SA</p> <p>Center Freq 2.44100000 GHz</p> <p>Mkr1 2.441 124 375 GHz 5.707 dBm</p> <p>Center Freq 2.44100000 GHz</p> <p>Start Freq 2.438500000 GHz</p> <p>Stop Freq 2.443500000 GHz</p> <p>CF Step 500.000 kHz</p> <p>Freq Offset 0 Hz</p> <p>Center 2.441000 GHz</p> <p>#Res BW 1.0 MHz</p> <p>#VBW 3.0 MHz</p> <p>Span 5.000 MHz</p> <p>Sweep 1.067 ms (8001 pts)</p>	
CH78		<p>Agilent Spectrum Analyzer - Swept SA</p> <p>Center Freq 2.48000000 GHz</p> <p>Mkr1 2.480 007 500 GHz 5.270 dBm</p> <p>Center Freq 2.48000000 GHz</p> <p>Start Freq 2.477500000 GHz</p> <p>Stop Freq 2.482500000 GHz</p> <p>CF Step 500.000 kHz</p> <p>Freq Offset 0 Hz</p> <p>Center 2.480000 GHz</p> <p>#Res BW 1.0 MHz</p> <p>#VBW 3.0 MHz</p> <p>Span 5.000 MHz</p> <p>Sweep 1.067 ms (8001 pts)</p>	

Modulation Type:		$\pi/4$ DQPSK
CH00		<p>Agilent Spectrum Analyzer - Sweep SA Center Freq 2.40200000 GHz #Avg Type: RMS AvgHold: 100/100 Mkr1 2.401 796 875 GHz 4.169 dBm Ref Offset 1 dB Ref 20.50 dBm #Res BW 2.0 MHz #VBW 6.0 MHz Sweep 1.067 ms (8001 pts) Span 5.000 MHz</p>
CH39		<p>Agilent Spectrum Analyzer - Sweep SA Center Freq 2.44100000 GHz #Avg Type: RMS AvgHold: 100/100 Mkr1 2.440 861 250 GHz 4.935 dBm Ref Offset 1 dB Ref 20.50 dBm #Res BW 2.0 MHz #VBW 6.0 MHz Sweep 1.067 ms (8001 pts) Span 5.000 MHz</p>
CH78		<p>Agilent Spectrum Analyzer - Sweep SA Center Freq 2.48000000 GHz #Avg Type: RMS AvgHold: 100/100 Mkr1 2.479 858 125 GHz 4.451 dBm Ref Offset 1 dB Ref 20.50 dBm #Res BW 2.0 MHz #VBW 6.0 MHz Sweep 1.067 ms (8001 pts) Span 5.000 MHz</p>

Modulation Type:		8DPSK
CH00	<p>Agilent Spectrum Analyzer - Sweep SA Center Freq 2.40200000 GHz Mkr1 2.40190500 GHz 4.429 dBm Ref Offset 1 dB Ref 20.50 dBm Span 5.000 MHz #Res BW 2.0 MHz #VBW 6.0 MHz Sweep 1.067 ms (8001 pts)</p>	
CH39	<p>Agilent Spectrum Analyzer - Sweep SA Center Freq 2.44100000 GHz Mkr1 2.441059375 GHz 5.121 dBm Ref Offset 1 dB Ref 20.50 dBm Span 5.000 MHz #Res BW 2.0 MHz #VBW 6.0 MHz Sweep 1.067 ms (8001 pts)</p>	
CH78	<p>Agilent Spectrum Analyzer - Sweep SA Center Freq 2.48000000 GHz Mkr1 2.479961250 GHz 4.696 dBm Ref Offset 1 dB Ref 20.50 dBm Span 5.000 MHz #Res BW 2.0 MHz #VBW 6.0 MHz Sweep 1.067 ms (8001 pts)</p>	

5.4. 20 dB Bandwidth

LIMIT

N/A

TEST CONFIGURATION

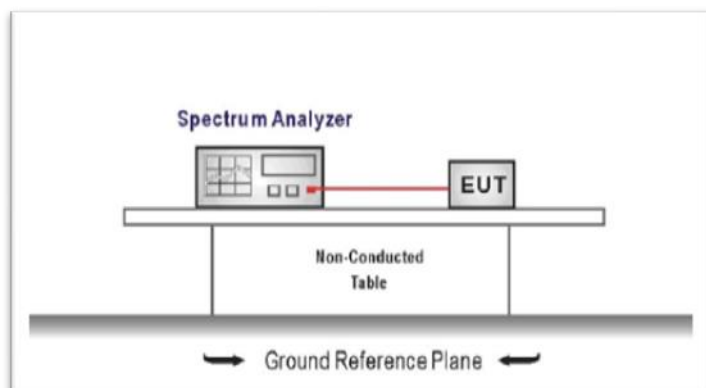

TEST PROCEDURE

1. The transmitter output was connected to the spectrum analyzer through an attenuator, the path loss was compensated to the results for each measurement.
2. Set to the maximum power setting and enable the EUT transmit continuously
3. Use the following spectrum analyzer settings:
 Span = approximately 2 to 3 times the 20 dB bandwidth, centered on a hopping channel
 RBW \geq 1% of the 20 dB bandwidth, VBW \geq RBW
 Sweep = auto, Detector function = peak, Trace = max hold
4. Measure and record the results in the test report.

TEST MODE:

Please refer to the clause 3.3

TEST RESULTS

Passed Not Applicable

Modulation type	Channel	20 dB Bandwidth (MHz)	Limit (MHz)	Result
GFSK	00	0.9117	-	Pass
	39	0.8946		
	78	0.9191		
$\pi/4$ DQPSK	00	1.289	-	Pass
	39	1.331		
	78	1.310		
8DPSK	00	1.319	-	Pass
	39	1.329		
	78	1.294		

Modulation Type:		GFSK	
CH00		<p>Agilent Spectrum Analyzer - Occupied BW</p> <p>Center Freq: 2.402000000 GHz</p> <p>Occupied Bandwidth: 880.90 kHz</p> <p>Total Power: 9.63 dBm</p> <p>Transmit Freq Error: -8.410 kHz</p> <p>x dB Bandwidth: 911.7 kHz</p> <p>OBW Power: 99.00 %</p> <p>x dB: -20.00 dB</p>	<p>Frequency</p> <p>Center Freq 2.402000000 GHz</p> <p>CF Step 200.000 kHz</p> <p>Freq Offset 0 Hz</p>
CH39		<p>Agilent Spectrum Analyzer - Occupied BW</p> <p>Center Freq: 2.441000000 GHz</p> <p>Occupied Bandwidth: 883.29 kHz</p> <p>Total Power: 10.6 dBm</p> <p>Transmit Freq Error: -14.428 kHz</p> <p>x dB Bandwidth: 894.6 kHz</p> <p>OBW Power: 99.00 %</p> <p>x dB: -20.00 dB</p>	<p>Frequency</p> <p>Center Freq 2.441000000 GHz</p> <p>CF Step 200.000 kHz</p> <p>Freq Offset 0 Hz</p>
CH78		<p>Agilent Spectrum Analyzer - Occupied BW</p> <p>Center Freq: 2.480000000 GHz</p> <p>Occupied Bandwidth: 904.80 kHz</p> <p>Total Power: 9.45 dBm</p> <p>Transmit Freq Error: 1.407 kHz</p> <p>x dB Bandwidth: 919.1 kHz</p> <p>OBW Power: 99.00 %</p> <p>x dB: -20.00 dB</p>	<p>Frequency</p> <p>Center Freq 2.480000000 GHz</p> <p>CF Step 200.000 kHz</p> <p>Freq Offset 0 Hz</p>

Modulation Type:		$\pi/4$ DQPSK
CH00	<p>Agilent Spectrum Analyzer - Occupied BW</p> <p>Center Freq 2.40200000 GHz</p> <p>Center Freq: 2.40200000 GHz</p> <p>Trig: Free Run</p> <p>#IFGain: Low</p> <p>#Atten: 20 dB</p> <p>Avg/Hold: 10/10</p> <p>Radio Std: None</p> <p>Radio Device: BTS</p> <p>Ref Offset 1 dB</p> <p>Ref 10.50 dBm</p> <p>Center 2.402 GHz</p> <p>#Res BW 30 kHz</p> <p>#VBW 100 kHz</p> <p>Span 2.5 MHz</p> <p>Sweep 2.667 ms</p> <p>Occupied Bandwidth 1.1804 MHz</p> <p>Total Power 7.56 dBm</p> <p>Transmit Freq Error -2.161 kHz</p> <p>OBW Power 99.00 %</p> <p>x dB Bandwidth 1.289 MHz</p> <p>x dB -20.00 dB</p>	<p>Frequency</p> <p>Center Freq 2.40200000 GHz</p> <p>CF Step 250.000 kHz</p> <p>Freq Offset 0 Hz</p>
CH39	<p>Agilent Spectrum Analyzer - Occupied BW</p> <p>Center Freq 2.44100000 GHz</p> <p>Center Freq: 2.44100000 GHz</p> <p>Trig: Free Run</p> <p>#IFGain: Low</p> <p>#Atten: 20 dB</p> <p>Avg/Hold: 10/10</p> <p>Radio Std: None</p> <p>Radio Device: BTS</p> <p>Ref Offset 1 dB</p> <p>Ref 10.50 dBm</p> <p>Center 2.441 GHz</p> <p>#Res BW 30 kHz</p> <p>#VBW 100 kHz</p> <p>Span 2.5 MHz</p> <p>Sweep 2.667 ms</p> <p>Occupied Bandwidth 1.1886 MHz</p> <p>Total Power 7.03 dBm</p> <p>Transmit Freq Error -7.995 kHz</p> <p>OBW Power 99.00 %</p> <p>x dB Bandwidth 1.331 MHz</p> <p>x dB -20.00 dB</p>	<p>Frequency</p> <p>Center Freq 2.44100000 GHz</p> <p>CF Step 250.000 kHz</p> <p>Freq Offset 0 Hz</p>
CH78	<p>Agilent Spectrum Analyzer - Occupied BW</p> <p>Center Freq 2.48000000 GHz</p> <p>Center Freq: 2.48000000 GHz</p> <p>Trig: Free Run</p> <p>#IFGain: Low</p> <p>#Atten: 20 dB</p> <p>Avg/Hold: 10/10</p> <p>Radio Std: None</p> <p>Radio Device: BTS</p> <p>Ref Offset 1 dB</p> <p>Ref 10.50 dBm</p> <p>Center 2.48 GHz</p> <p>#Res BW 30 kHz</p> <p>#VBW 100 kHz</p> <p>Span 2.5 MHz</p> <p>Sweep 2.667 ms</p> <p>Occupied Bandwidth 1.1973 MHz</p> <p>Total Power 7.01 dBm</p> <p>Transmit Freq Error 2.372 kHz</p> <p>OBW Power 99.00 %</p> <p>x dB Bandwidth 1.310 MHz</p> <p>x dB -20.00 dB</p>	<p>Frequency</p> <p>Center Freq 2.48000000 GHz</p> <p>CF Step 250.000 kHz</p> <p>Freq Offset 0 Hz</p>

Modulation Type:		8DPSK
CH00	<p>Agilent Spectrum Analyzer - Occupied BW</p> <p>Center Freq 2.40200000 GHz</p> <p>Center Freq: 2.40200000 GHz</p> <p>Trig: Free Run AvgHold: 10/10</p> <p>Radio Std: None</p> <p>Radio Device: BTS</p> <p>Ref Offset 1 dB</p> <p>Ref 10.50 dBm</p> <p>Center 2.402 GHz</p> <p>#Res BW 30 kHz</p> <p>#VBW 100 kHz</p> <p>Span 2.5 MHz</p> <p>Sweep 2.667 ms</p> <p>Occupied Bandwidth 1.2170 MHz</p> <p>Total Power 5.52 dBm</p> <p>Transmit Freq Error -9.641 kHz</p> <p>OBW Power 99.00 %</p> <p>x dB Bandwidth 1.319 MHz</p> <p>x dB -20.00 dB</p>	<p>Frequency</p> <p>Center Freq 2.40200000 GHz</p> <p>CF Step 250.000 kHz</p> <p>Freq Offset 0 Hz</p>
CH39	<p>Agilent Spectrum Analyzer - Occupied BW</p> <p>Center Freq 2.44100000 GHz</p> <p>Center Freq: 2.44100000 GHz</p> <p>Trig: Free Run AvgHold: 10/10</p> <p>Radio Std: None</p> <p>Radio Device: BTS</p> <p>Ref Offset 1 dB</p> <p>Ref 10.50 dBm</p> <p>Center 2.441 GHz</p> <p>#Res BW 30 kHz</p> <p>#VBW 100 kHz</p> <p>Span 2.5 MHz</p> <p>Sweep 2.667 ms</p> <p>Occupied Bandwidth 1.2020 MHz</p> <p>Total Power 7.32 dBm</p> <p>Transmit Freq Error -2.645 kHz</p> <p>OBW Power 99.00 %</p> <p>x dB Bandwidth 1.329 MHz</p> <p>x dB -20.00 dB</p>	<p>Frequency</p> <p>Center Freq 2.44100000 GHz</p> <p>CF Step 250.000 kHz</p> <p>Freq Offset 0 Hz</p>
CH78	<p>Agilent Spectrum Analyzer - Occupied BW</p> <p>Center Freq 2.48000000 GHz</p> <p>Center Freq: 2.48000000 GHz</p> <p>Trig: Free Run AvgHold: 10/10</p> <p>Radio Std: None</p> <p>Radio Device: BTS</p> <p>Ref Offset 1 dB</p> <p>Ref 10.50 dBm</p> <p>Center 2.48 GHz</p> <p>#Res BW 30 kHz</p> <p>#VBW 100 kHz</p> <p>Span 2.5 MHz</p> <p>Sweep 2.667 ms</p> <p>Occupied Bandwidth 1.1933 MHz</p> <p>Total Power 7.13 dBm</p> <p>Transmit Freq Error -16.869 kHz</p> <p>OBW Power 99.00 %</p> <p>x dB Bandwidth 1.294 MHz</p> <p>x dB -20.00 dB</p>	<p>Frequency</p> <p>Center Freq 2.48000000 GHz</p> <p>CF Step 250.000 kHz</p> <p>Freq Offset 0 Hz</p>

5.5. Carrier Frequencies Separation

LIMIT

FCC CFR Title 47 Part 15 Subpart C Section 15.247 (a)(1):Frequency hopping systems shall have hopping channel carrier frequencies separated by minimum of 25 kHz or the 2/3*20 dB bandwidth of the hopping channel, whichever is greater.

TEST CONFIGURATION

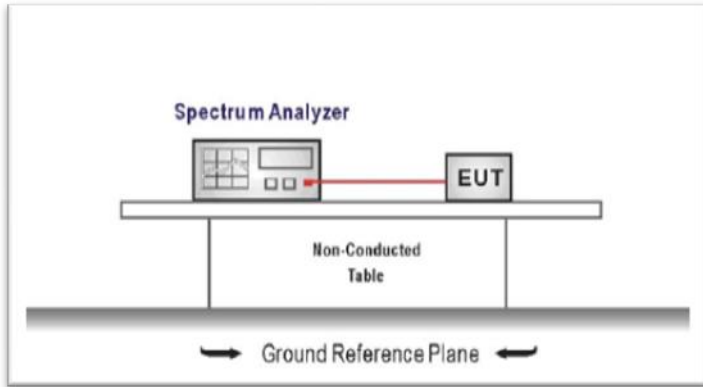

TEST PROCEDURE

1. The transmitter output was connected to the spectrum analyzer through an attenuator, the path loss was compensated to the results for each measurement.
2. Set to the maximum power setting and enable the EUT transmit continuously
3. Use the following spectrum analyzer settings:
 Span = wide enough to capture the peaks of two adjacent channels
 RBW ≥ 1% of the span, VBW ≥ RBW
 Sweep = auto, Detector function = peak, Trace = max hold
4. Measure and record the results in the test report.

TEST MODE:

Please refer to the clause 3.3

TEST RESULTS

Passed Not Applicable

Modulation type	Channel	Carrier Frequencies Separation (MHz)	Limit (MHz) *	Result
GFSK	39	1.146	≥0.919	Pass
π/4DQPSK	39	1.192	≥0.892	Pass
8DPSK	39	1.006	≥0.890	Pass

Note:

- *: GFSK limit = The maximum 20 dB Bandwidth for GFSK modulation on the section 5.4.
- π/4DQPSK limit = 2/3 * The maximum 20 dB Bandwidth for π/4DQPSK modulation on the section 5.4.
- 8DPSK limit = 2/3 * The maximum 20 dB Bandwidth for 8DPSK modulation on the section 5.4

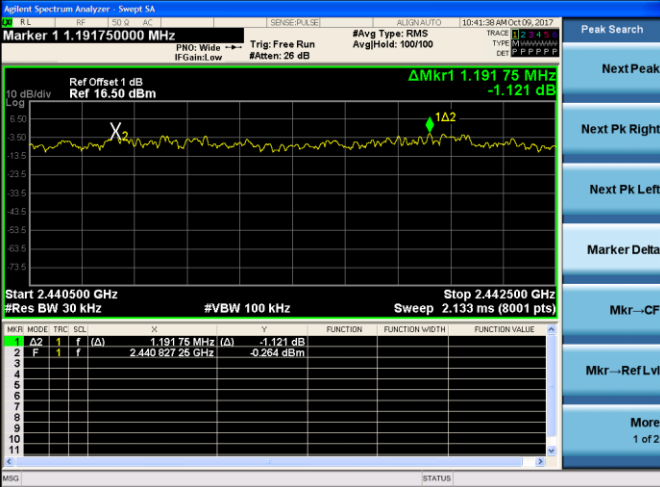
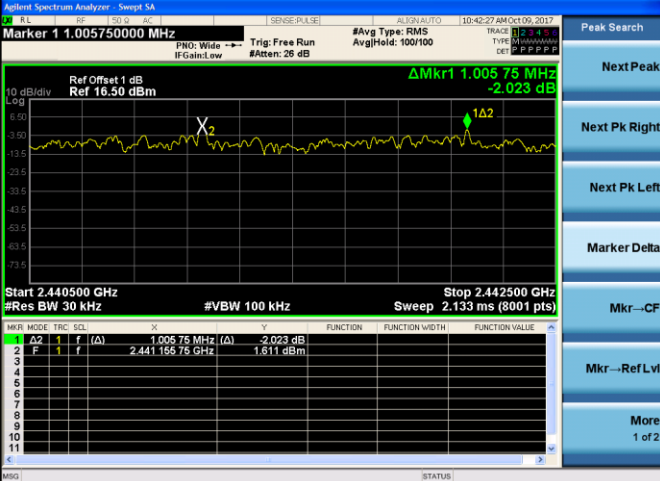
<p>GFSK</p>		<p>Sweep Setup</p> <ul style="list-style-type: none"> Swp Time Rules: Normal Sweep Type: Swept Swp Type Rules: Dynamic Range FFT Width: <411.9 kHz>
<p>$\pi/4$DQPSK</p>		<p>Peak Search</p> <ul style="list-style-type: none"> Next Peak Next Pk Right Next Pk Left Marker Delta Mkr--CF Mkr--Ref Lvl More 1 of 2
<p>8DPSK</p>		<p>Peak Search</p> <ul style="list-style-type: none"> Next Peak Next Pk Right Next Pk Left Marker Delta Mkr--CF Mkr--Ref Lvl More 1 of 2

5.6. Hopping Channel Number

LIMIT

FCC CFR Title 47 Part 15 Subpart C Section 15.247 (a)(1):Frequency hopping systems in the 2400–2483.5 MHz band shall use at least **15** channels.

TEST CONFIGURATION

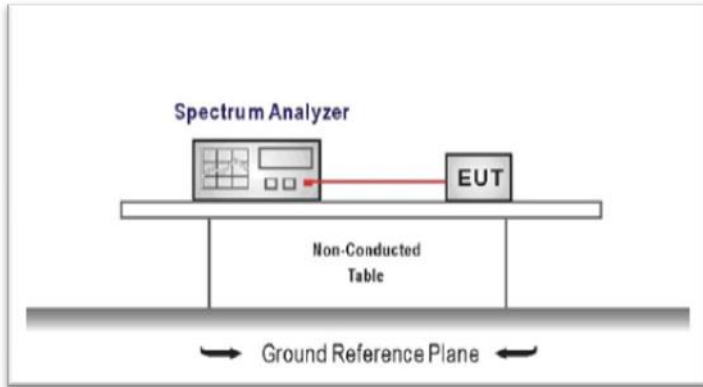

TEST PROCEDURE

1. The transmitter output was connected to the spectrum analyzer through an attenuator, the path loss was compensated to the results for each measurement.
2. Set to the maximum power setting and enable the EUT transmit continuously
3. Use the following spectrum analyzer settings:
 Span = the frequency band of operation
 RBW ≥ 1% of the span, VBW ≥ RBW
 Sweep = auto, Detector function = peak, Trace = max hold
4. Measure and record the results in the test report.

TEST MODE:

Please refer to the clause 3.3

TEST RESULTS

Passed Not Applicable

Modulation type	Channel number	Limit	Result
GFSK	79	≥15.00	Pass
π/4DQPSK	79		
8DPSK	79		

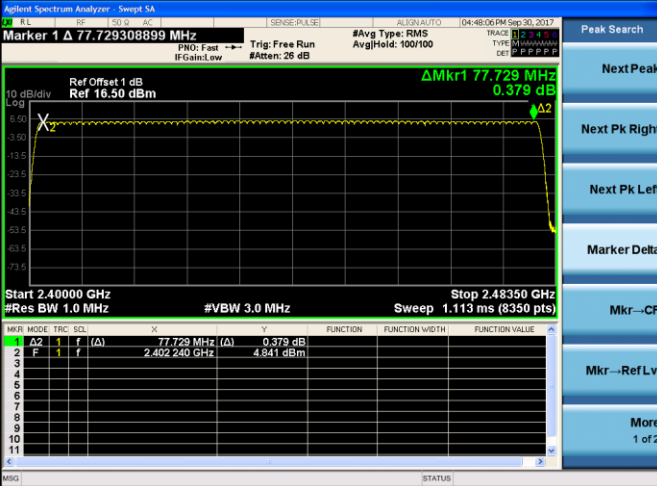
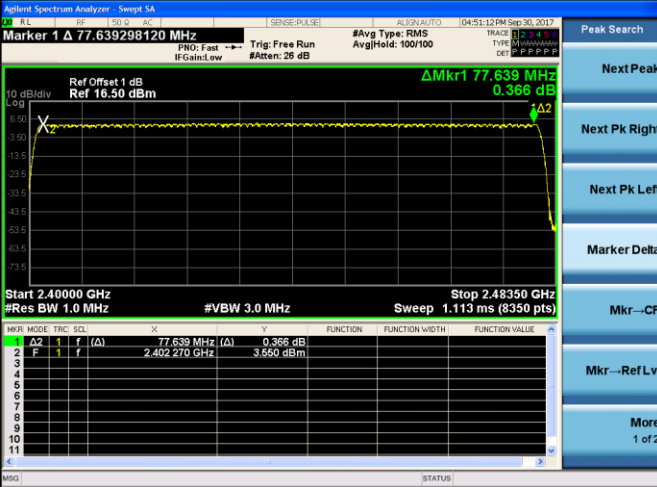
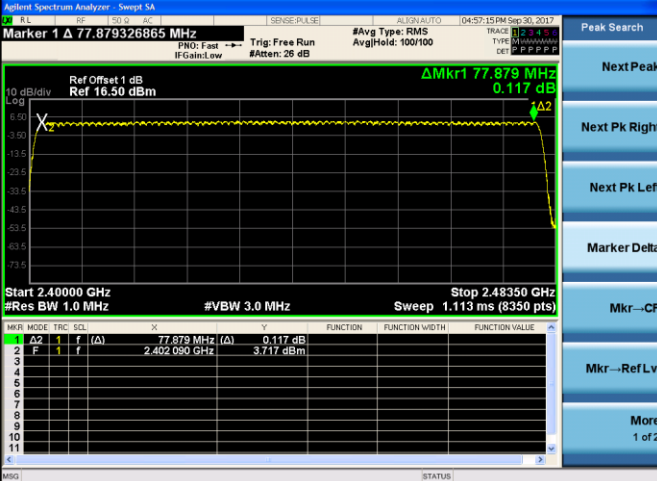
<p>GFSK</p>	 <table border="1"><thead><tr><th>MKR MODE</th><th>TRC</th><th>SCL</th><th>X</th><th>Y</th><th>FUNCTION</th><th>FUNCTION WIDTH</th><th>FUNCTION VALUE</th></tr></thead><tbody><tr><td>1</td><td>Δ2</td><td>f</td><td>77.729 MHz (Δ)</td><td>0.379 dB</td><td></td><td></td><td></td></tr><tr><td>2</td><td>F</td><td>f</td><td>2.402 240 GHz</td><td>4.841 dBm</td><td></td><td></td><td></td></tr></tbody></table>	MKR MODE	TRC	SCL	X	Y	FUNCTION	FUNCTION WIDTH	FUNCTION VALUE	1	Δ2	f	77.729 MHz (Δ)	0.379 dB				2	F	f	2.402 240 GHz	4.841 dBm				<p>Peak Search</p> <p>Next Peak</p> <p>Next Pk Right</p> <p>Next Pk Left</p> <p>Marker Delta</p> <p>Mkr--CF</p> <p>Mkr--Ref Lvl</p> <p>More 1 of 2</p>
MKR MODE	TRC	SCL	X	Y	FUNCTION	FUNCTION WIDTH	FUNCTION VALUE																			
1	Δ2	f	77.729 MHz (Δ)	0.379 dB																						
2	F	f	2.402 240 GHz	4.841 dBm																						
<p>π/4DQPSK</p>	 <table border="1"><thead><tr><th>MKR MODE</th><th>TRC</th><th>SCL</th><th>X</th><th>Y</th><th>FUNCTION</th><th>FUNCTION WIDTH</th><th>FUNCTION VALUE</th></tr></thead><tbody><tr><td>1</td><td>Δ2</td><td>f</td><td>77.639 MHz (Δ)</td><td>0.366 dB</td><td></td><td></td><td></td></tr><tr><td>2</td><td>F</td><td>f</td><td>2.402 270 GHz</td><td>3.650 dBm</td><td></td><td></td><td></td></tr></tbody></table>	MKR MODE	TRC	SCL	X	Y	FUNCTION	FUNCTION WIDTH	FUNCTION VALUE	1	Δ2	f	77.639 MHz (Δ)	0.366 dB				2	F	f	2.402 270 GHz	3.650 dBm				<p>Peak Search</p> <p>Next Peak</p> <p>Next Pk Right</p> <p>Next Pk Left</p> <p>Marker Delta</p> <p>Mkr--CF</p> <p>Mkr--Ref Lvl</p> <p>More 1 of 2</p>
MKR MODE	TRC	SCL	X	Y	FUNCTION	FUNCTION WIDTH	FUNCTION VALUE																			
1	Δ2	f	77.639 MHz (Δ)	0.366 dB																						
2	F	f	2.402 270 GHz	3.650 dBm																						
<p>8DPSK</p>	 <table border="1"><thead><tr><th>MKR MODE</th><th>TRC</th><th>SCL</th><th>X</th><th>Y</th><th>FUNCTION</th><th>FUNCTION WIDTH</th><th>FUNCTION VALUE</th></tr></thead><tbody><tr><td>1</td><td>Δ2</td><td>f</td><td>77.879 MHz (Δ)</td><td>0.117 dB</td><td></td><td></td><td></td></tr><tr><td>2</td><td>F</td><td>f</td><td>2.402 090 GHz</td><td>3.717 dBm</td><td></td><td></td><td></td></tr></tbody></table>	MKR MODE	TRC	SCL	X	Y	FUNCTION	FUNCTION WIDTH	FUNCTION VALUE	1	Δ2	f	77.879 MHz (Δ)	0.117 dB				2	F	f	2.402 090 GHz	3.717 dBm				<p>Peak Search</p> <p>Next Peak</p> <p>Next Pk Right</p> <p>Next Pk Left</p> <p>Marker Delta</p> <p>Mkr--CF</p> <p>Mkr--Ref Lvl</p> <p>More 1 of 2</p>
MKR MODE	TRC	SCL	X	Y	FUNCTION	FUNCTION WIDTH	FUNCTION VALUE																			
1	Δ2	f	77.879 MHz (Δ)	0.117 dB																						
2	F	f	2.402 090 GHz	3.717 dBm																						

5.7. Dwell Time

LIMIT

FCC CFR Title 47 Part 15 Subpart C Section 15.247 (a)(1):The average time of occupancy on any channel shall not be greater than 0.4 seconds within a pe-riod of 0.4 seconds multiplied by the number of hopping channels employed.

TEST CONFIGURATION

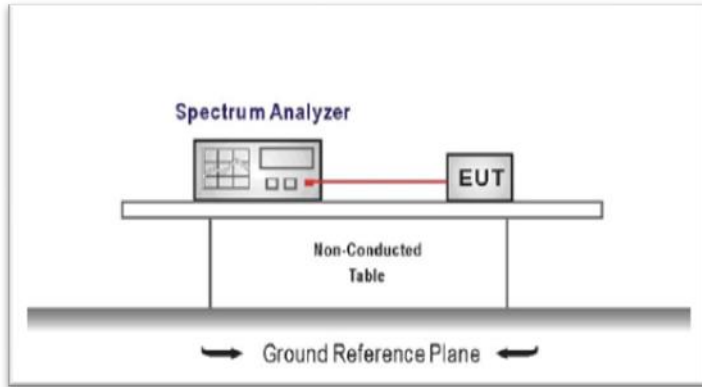

TEST PROCEDURE

1. The transmitter output was connected to the spectrum analyzer through an attenuator, the path loss was compensated to the results for each measurement.
2. Set to the maximum power setting and enable the EUT transmit continuously
3. Use the following spectrum analyzer settings:
 Span = zero span, centered on a hopping channel, RBW= 1 MHz, VBW ≥ RBW
 Sweep = as necessary to capture the entire dwell time per hopping channel,
 Detector function = peak, Trace = max hold
4. Measure and record the results in the test report.

TEST MODE:

Please refer to the clause 3.3

TEST RESULTS

Passed Not Applicable

Modulation type	Channel	Dwell time (Second)	Limit (Second)	Result
GFSK	DH1	0.118	≤ 0.40	Pass
	DH3	0.261		
	DH5	0.306		
π/4DQPSK	2DH1	0.122	≤ 0.40	Pass
	2DH3	0.261		
	2DH5	0.307		
8DPSK	3DH1	0.122	≤ 0.40	Pass
	3DH3	0.261		
	3DH5	0.307		

Note:

1. We have tested all mode at high,middle and low channel,and recoreded worst case at middle channel.
2. Dwell time=Pulse time (ms) × (1600 ÷ 2 ÷ 79) ×31.6 Second for DH1, 2DH1, 3DH1
 Dwell time=Pulse time (ms) × (1600 ÷ 4 ÷ 79) ×31.6 Second for DH3, 2DH3, 3DH3
 Dwell time=Pulse time (ms) × (1600 ÷ 6 ÷ 79) ×31.6 Second for DH5, 2DH5, 3DH5

Modulation Type:	GFSK										
DH1		<table border="1"> <tr><td>Frequency</td></tr> <tr><td>Auto Tune</td></tr> <tr><td>Center Freq 2.441000000 GHz</td></tr> <tr><td>Start Freq 2.441000000 GHz</td></tr> <tr><td>Stop Freq 2.441000000 GHz</td></tr> <tr><td>CF Step 1.000000 MHz</td></tr> <tr><td>Man</td></tr> <tr><td>Auto</td></tr> <tr><td>Freq Offset 0 Hz</td></tr> </table>	Frequency	Auto Tune	Center Freq 2.441000000 GHz	Start Freq 2.441000000 GHz	Stop Freq 2.441000000 GHz	CF Step 1.000000 MHz	Man	Auto	Freq Offset 0 Hz
Frequency											
Auto Tune											
Center Freq 2.441000000 GHz											
Start Freq 2.441000000 GHz											
Stop Freq 2.441000000 GHz											
CF Step 1.000000 MHz											
Man											
Auto											
Freq Offset 0 Hz											
DH3		<table border="1"> <tr><td>Frequency</td></tr> <tr><td>Auto Tune</td></tr> <tr><td>Center Freq 2.441000000 GHz</td></tr> <tr><td>Start Freq 2.441000000 GHz</td></tr> <tr><td>Stop Freq 2.441000000 GHz</td></tr> <tr><td>CF Step 1.000000 MHz</td></tr> <tr><td>Man</td></tr> <tr><td>Auto</td></tr> <tr><td>Freq Offset 0 Hz</td></tr> </table>	Frequency	Auto Tune	Center Freq 2.441000000 GHz	Start Freq 2.441000000 GHz	Stop Freq 2.441000000 GHz	CF Step 1.000000 MHz	Man	Auto	Freq Offset 0 Hz
Frequency											
Auto Tune											
Center Freq 2.441000000 GHz											
Start Freq 2.441000000 GHz											
Stop Freq 2.441000000 GHz											
CF Step 1.000000 MHz											
Man											
Auto											
Freq Offset 0 Hz											
DH5		<table border="1"> <tr><td>Frequency</td></tr> <tr><td>Auto Tune</td></tr> <tr><td>Center Freq 2.441000000 GHz</td></tr> <tr><td>Start Freq 2.441000000 GHz</td></tr> <tr><td>Stop Freq 2.441000000 GHz</td></tr> <tr><td>CF Step 1.000000 MHz</td></tr> <tr><td>Man</td></tr> <tr><td>Auto</td></tr> <tr><td>Freq Offset 0 Hz</td></tr> </table>	Frequency	Auto Tune	Center Freq 2.441000000 GHz	Start Freq 2.441000000 GHz	Stop Freq 2.441000000 GHz	CF Step 1.000000 MHz	Man	Auto	Freq Offset 0 Hz
Frequency											
Auto Tune											
Center Freq 2.441000000 GHz											
Start Freq 2.441000000 GHz											
Stop Freq 2.441000000 GHz											
CF Step 1.000000 MHz											
Man											
Auto											
Freq Offset 0 Hz											

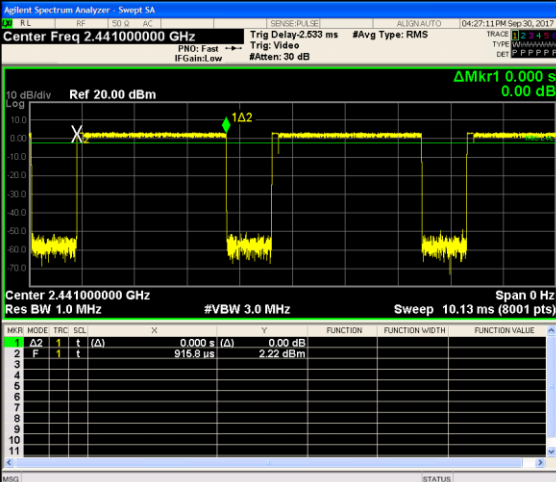
Modulation Type:		$\pi/4$ DQPSK																											
2DH1		 <table border="1" data-bbox="678 548 1236 705"> <thead> <tr> <th>MNR</th> <th>MODE</th> <th>TRC</th> <th>SCL</th> <th>X</th> <th>Y</th> <th>FUNCTION</th> <th>FUNCTION WIDTH</th> <th>FUNCTION VALUE</th> </tr> </thead> <tbody> <tr> <td>1</td> <td>Δ2</td> <td>t</td> <td>t</td> <td>(Δ)</td> <td>0.000 s</td> <td>(Δ)</td> <td>0.00 dB</td> <td></td> </tr> <tr> <td>2</td> <td>F</td> <td>t</td> <td>t</td> <td></td> <td>1.150 ms</td> <td></td> <td>1.95 dBm</td> <td></td> </tr> </tbody> </table>	MNR	MODE	TRC	SCL	X	Y	FUNCTION	FUNCTION WIDTH	FUNCTION VALUE	1	Δ 2	t	t	(Δ)	0.000 s	(Δ)	0.00 dB		2	F	t	t		1.150 ms		1.95 dBm	
MNR	MODE	TRC	SCL	X	Y	FUNCTION	FUNCTION WIDTH	FUNCTION VALUE																					
1	Δ 2	t	t	(Δ)	0.000 s	(Δ)	0.00 dB																						
2	F	t	t		1.150 ms		1.95 dBm																						
2DH3		 <table border="1" data-bbox="678 1010 1236 1198"> <thead> <tr> <th>MNR</th> <th>MODE</th> <th>TRC</th> <th>SCL</th> <th>X</th> <th>Y</th> <th>FUNCTION</th> <th>FUNCTION WIDTH</th> <th>FUNCTION VALUE</th> </tr> </thead> <tbody> <tr> <td>1</td> <td>Δ2</td> <td>t</td> <td>t</td> <td>(Δ)</td> <td>0.000 s</td> <td>(Δ)</td> <td>0.00 dB</td> <td></td> </tr> <tr> <td>2</td> <td>F</td> <td>t</td> <td>t</td> <td></td> <td>31.67 μs</td> <td></td> <td>2.42 dBm</td> <td></td> </tr> </tbody> </table>	MNR	MODE	TRC	SCL	X	Y	FUNCTION	FUNCTION WIDTH	FUNCTION VALUE	1	Δ 2	t	t	(Δ)	0.000 s	(Δ)	0.00 dB		2	F	t	t		31.67 μ s		2.42 dBm	
MNR	MODE	TRC	SCL	X	Y	FUNCTION	FUNCTION WIDTH	FUNCTION VALUE																					
1	Δ 2	t	t	(Δ)	0.000 s	(Δ)	0.00 dB																						
2	F	t	t		31.67 μ s		2.42 dBm																						
2DH5		 <table border="1" data-bbox="678 1525 1236 1691"> <thead> <tr> <th>MNR</th> <th>MODE</th> <th>TRC</th> <th>SCL</th> <th>X</th> <th>Y</th> <th>FUNCTION</th> <th>FUNCTION WIDTH</th> <th>FUNCTION VALUE</th> </tr> </thead> <tbody> <tr> <td>1</td> <td>Δ2</td> <td>t</td> <td>t</td> <td>(Δ)</td> <td>0.000 s</td> <td>(Δ)</td> <td>0.00 dB</td> <td></td> </tr> <tr> <td>2</td> <td>F</td> <td>t</td> <td>t</td> <td></td> <td>918.8 μs</td> <td></td> <td>2.22 dBm</td> <td></td> </tr> </tbody> </table>	MNR	MODE	TRC	SCL	X	Y	FUNCTION	FUNCTION WIDTH	FUNCTION VALUE	1	Δ 2	t	t	(Δ)	0.000 s	(Δ)	0.00 dB		2	F	t	t		918.8 μ s		2.22 dBm	
MNR	MODE	TRC	SCL	X	Y	FUNCTION	FUNCTION WIDTH	FUNCTION VALUE																					
1	Δ 2	t	t	(Δ)	0.000 s	(Δ)	0.00 dB																						
2	F	t	t		918.8 μ s		2.22 dBm																						

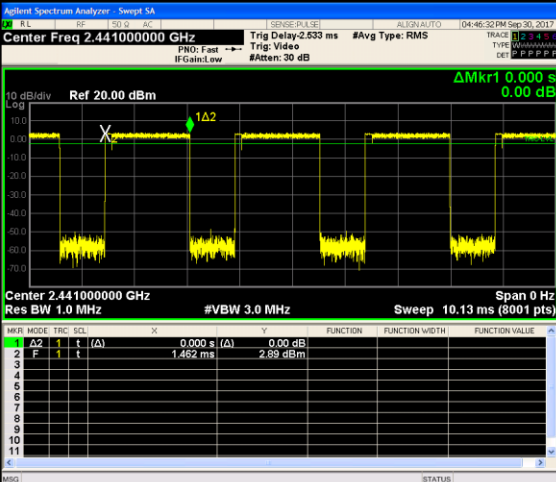
Modulation Type:		8DPSK																											
3DH1		 <table border="1" data-bbox="678 548 1236 705"> <thead> <tr> <th>MNR</th> <th>MODE</th> <th>TRC</th> <th>SCL</th> <th>X</th> <th>Y</th> <th>FUNCTION</th> <th>FUNCTION WIDTH</th> <th>FUNCTION VALUE</th> </tr> </thead> <tbody> <tr> <td>1</td> <td>Δ2</td> <td>t</td> <td>t</td> <td>(Δ)</td> <td>0.000 s (Δ)</td> <td>0.00 dB</td> <td></td> <td></td> </tr> <tr> <td>2</td> <td>F</td> <td>t</td> <td>t</td> <td>(Δ)</td> <td>31.87 μs</td> <td>2.92 dBm</td> <td></td> <td></td> </tr> </tbody> </table>	MNR	MODE	TRC	SCL	X	Y	FUNCTION	FUNCTION WIDTH	FUNCTION VALUE	1	Δ2	t	t	(Δ)	0.000 s (Δ)	0.00 dB			2	F	t	t	(Δ)	31.87 μs	2.92 dBm		
MNR	MODE	TRC	SCL	X	Y	FUNCTION	FUNCTION WIDTH	FUNCTION VALUE																					
1	Δ2	t	t	(Δ)	0.000 s (Δ)	0.00 dB																							
2	F	t	t	(Δ)	31.87 μs	2.92 dBm																							
3DH3		 <table border="1" data-bbox="678 1064 1236 1198"> <thead> <tr> <th>MNR</th> <th>MODE</th> <th>TRC</th> <th>SCL</th> <th>X</th> <th>Y</th> <th>FUNCTION</th> <th>FUNCTION WIDTH</th> <th>FUNCTION VALUE</th> </tr> </thead> <tbody> <tr> <td>1</td> <td>Δ2</td> <td>t</td> <td>t</td> <td>(Δ)</td> <td>0.000 s (Δ)</td> <td>0.00 dB</td> <td></td> <td></td> </tr> <tr> <td>2</td> <td>F</td> <td>t</td> <td>t</td> <td>(Δ)</td> <td>1.462 ms</td> <td>2.89 dBm</td> <td></td> <td></td> </tr> </tbody> </table>	MNR	MODE	TRC	SCL	X	Y	FUNCTION	FUNCTION WIDTH	FUNCTION VALUE	1	Δ2	t	t	(Δ)	0.000 s (Δ)	0.00 dB			2	F	t	t	(Δ)	1.462 ms	2.89 dBm		
MNR	MODE	TRC	SCL	X	Y	FUNCTION	FUNCTION WIDTH	FUNCTION VALUE																					
1	Δ2	t	t	(Δ)	0.000 s (Δ)	0.00 dB																							
2	F	t	t	(Δ)	1.462 ms	2.89 dBm																							
3DH5		 <table border="1" data-bbox="678 1534 1236 1691"> <thead> <tr> <th>MNR</th> <th>MODE</th> <th>TRC</th> <th>SCL</th> <th>X</th> <th>Y</th> <th>FUNCTION</th> <th>FUNCTION WIDTH</th> <th>FUNCTION VALUE</th> </tr> </thead> <tbody> <tr> <td>1</td> <td>Δ2</td> <td>t</td> <td>t</td> <td>(Δ)</td> <td>0.000 s (Δ)</td> <td>0.00 dB</td> <td></td> <td></td> </tr> <tr> <td>2</td> <td>F</td> <td>t</td> <td>t</td> <td>(Δ)</td> <td>3.559 ms</td> <td>2.47 dBm</td> <td></td> <td></td> </tr> </tbody> </table>	MNR	MODE	TRC	SCL	X	Y	FUNCTION	FUNCTION WIDTH	FUNCTION VALUE	1	Δ2	t	t	(Δ)	0.000 s (Δ)	0.00 dB			2	F	t	t	(Δ)	3.559 ms	2.47 dBm		
MNR	MODE	TRC	SCL	X	Y	FUNCTION	FUNCTION WIDTH	FUNCTION VALUE																					
1	Δ2	t	t	(Δ)	0.000 s (Δ)	0.00 dB																							
2	F	t	t	(Δ)	3.559 ms	2.47 dBm																							

5.8. Pseudorandom Frequency Hopping Sequence

LIMIT

FCC CFR Title 47 Part 15 Subpart C Section 15.247 (a)(1):Frequency hopping systems shall have hopping channel carrier frequencies separated by a minimum of 25 kHz or the 20 dB bandwidth of the hopping channel, whichever is greater. Alternatively, frequency hopping systems operating in the 2400–2483.5 MHz band may have hopping channel carrier frequencies that are separated by 25 kHz or two-thirds of the 20 dB bandwidth of the hopping channel, whichever is greater, provided the systems operate with an output power no greater than 125 mW. The system shall hop to channel frequencies that are selected at the system hopping rate from a pseudo-randomly ordered list of hopping frequencies. Each frequency must be used equally on the average by each transmitter. The system receivers shall have input bandwidths that match the hopping channel bandwidths of their corresponding transmitters and shall shift frequencies in synchronization with the transmitted signals.

TEST RESULTS

The pseudorandom frequency hopping sequence may be generated in a nine-stage shift register whose 5th and 9th stage outputs are added in a modulo-two addition stage. And the result is fed back to the input of the first stage. The sequence begins with the first one of 9 consecutive ones, for example: the shift register is initialized with nine ones.

- Number of shift register stages: 9
- Length of pseudo-random sequence: $2^9 - 1 = 511$ bits
- Longest sequence of zeros: 8 (non-inverted signal)

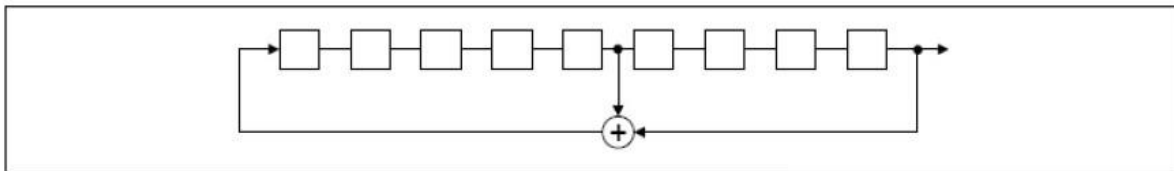

Linear Feedback Shift Register for Generation of the PRBS sequence

An example of pseudorandom frequency hopping sequence as follows:

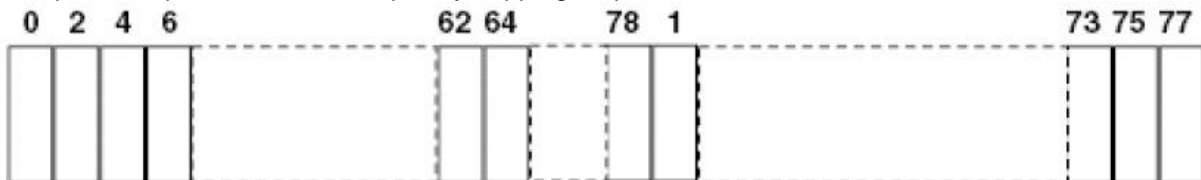

Each frequency used equally on the average by each transmitter. The system receiver has input bandwidths that match the hopping channel bandwidths of their corresponding transmitter and shift frequencies in synchronization with the transmitted signals.

5.9. Restricted band (radiated)

LIMIT

FCC CFR Title 47 Part 15 Subpart C Section 15.247 (d):

In any 100 kHz bandwidth outside the frequency band in which the spread spectrum or digitally modulated intentional radiator is operating, Radiated Emissions which fall in the restricted bands, as defined in §15.205(a), must also comply with the Radiated Emissions limits specified in §15.209(a) (see §15.205(c)).

TEST CONFIGURATION

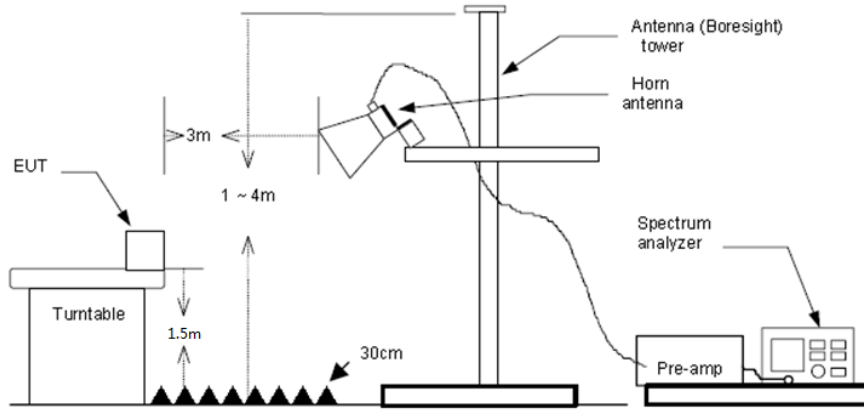

TEST PROCEDURE

1. The EUT was setup and tested according to ANSI C63.10:2013 for compliance to FCC 47CFR 15.247 requirements.
2. The EUT is placed on a turn table which is 1.5 meter above ground. The turn table is rotated 360 degrees to determine the position of the maximum emission level.
3. The EUT was positioned such that the distance from antenna to the EUT was 3 meters.
4. The antenna is scanned from 1 meter to 4 meters to find out the maximum emission level. This is repeated for both horizontal and vertical polarization of the antenna. In order to find the maximum emission, all of the interface cables were manipulated according to ANSI C63.10:2013 on radiated measurement.
5. The receiver set as follow:
 RBW=1 MHz, VBW=3 MHz Peak detector for Peak value
 RBW=1 MHz, VBW=10 Hz Peak detector for Average value.

TEST MODE:

Please refer to the clause 3.3

TEST RESULTS

Passed Not Applicable

Note:

- 1) Final level= Read level + Antenna Factor+ Cable Loss- Preamp Factor
- 2) Have pre-scan all modulation mode, found the GFSK modulation which it was worst case, so only the worst case's data on the test report.
- 3) The peak level is lower than average limit(54 dBuV/m), this data is the too weak instrument of signal is unable to test.

CH00 Peak:

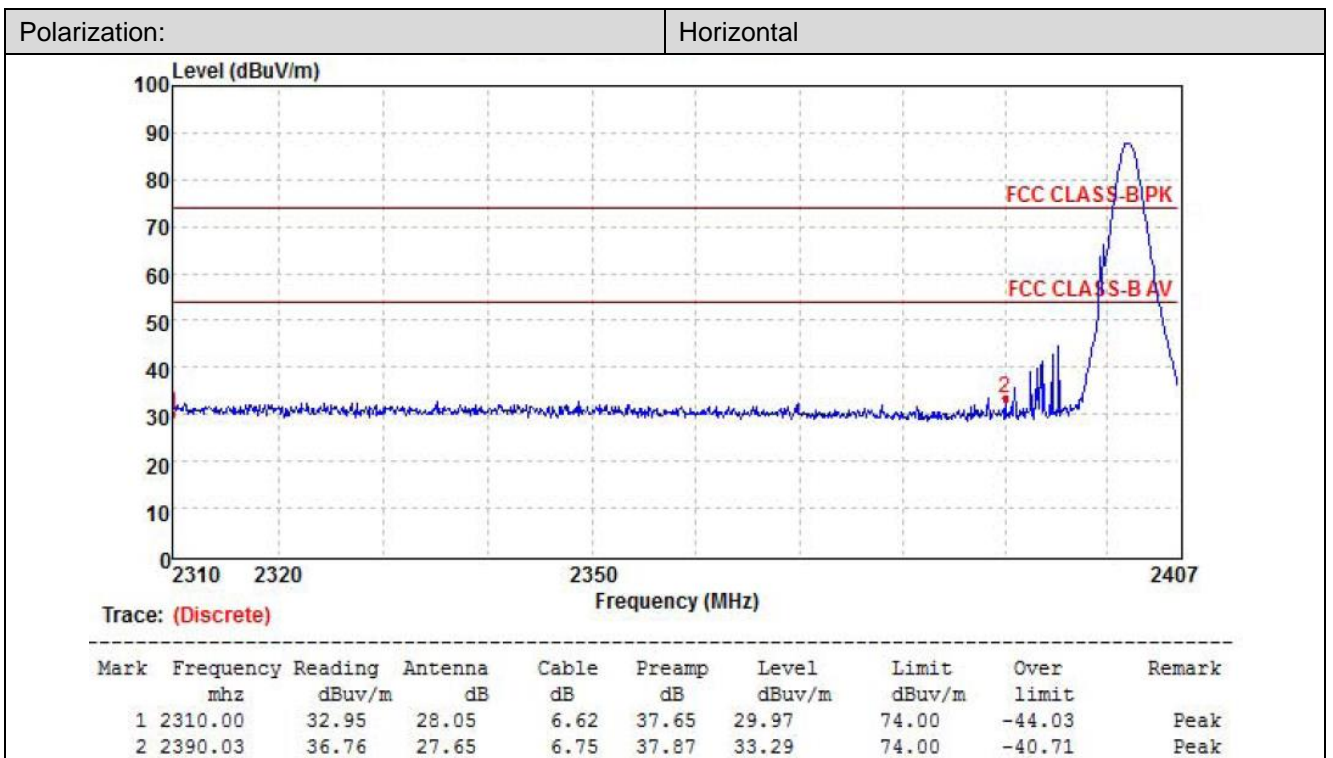
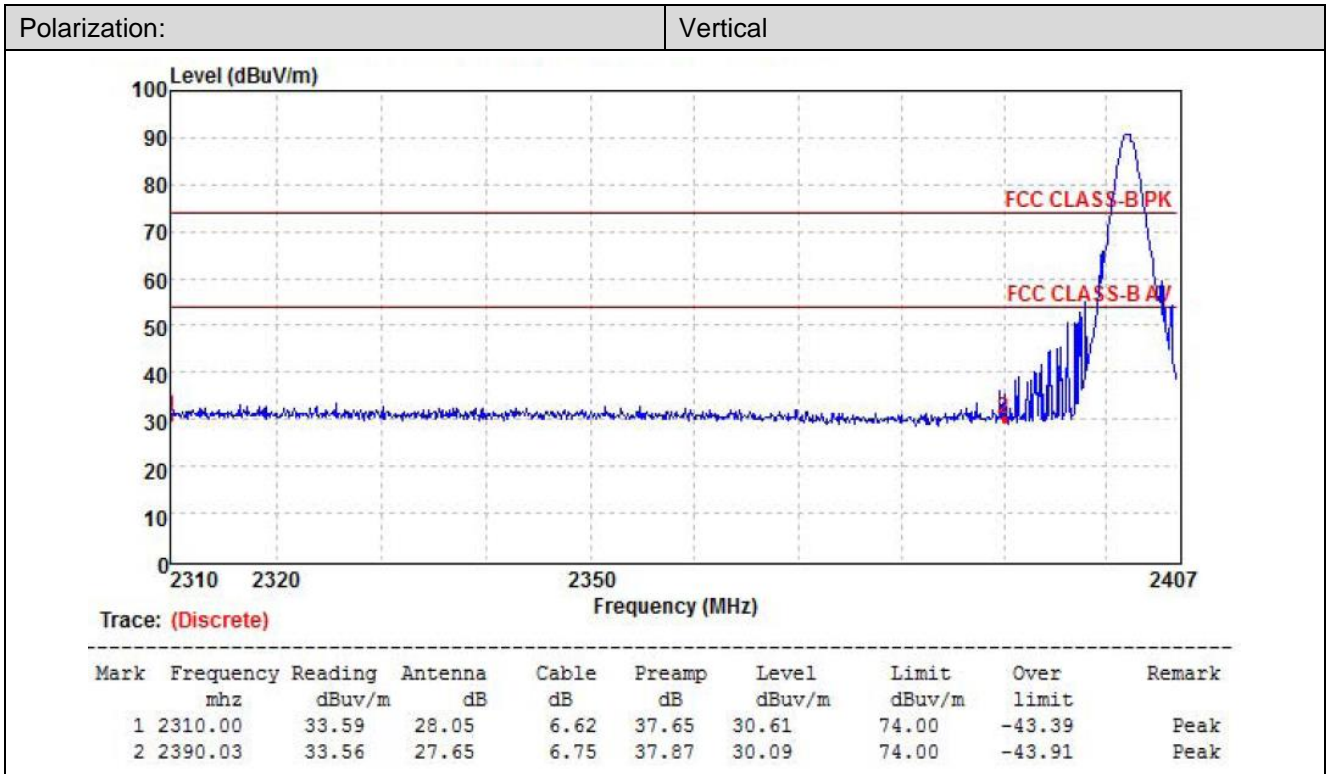

CH78 Peak:

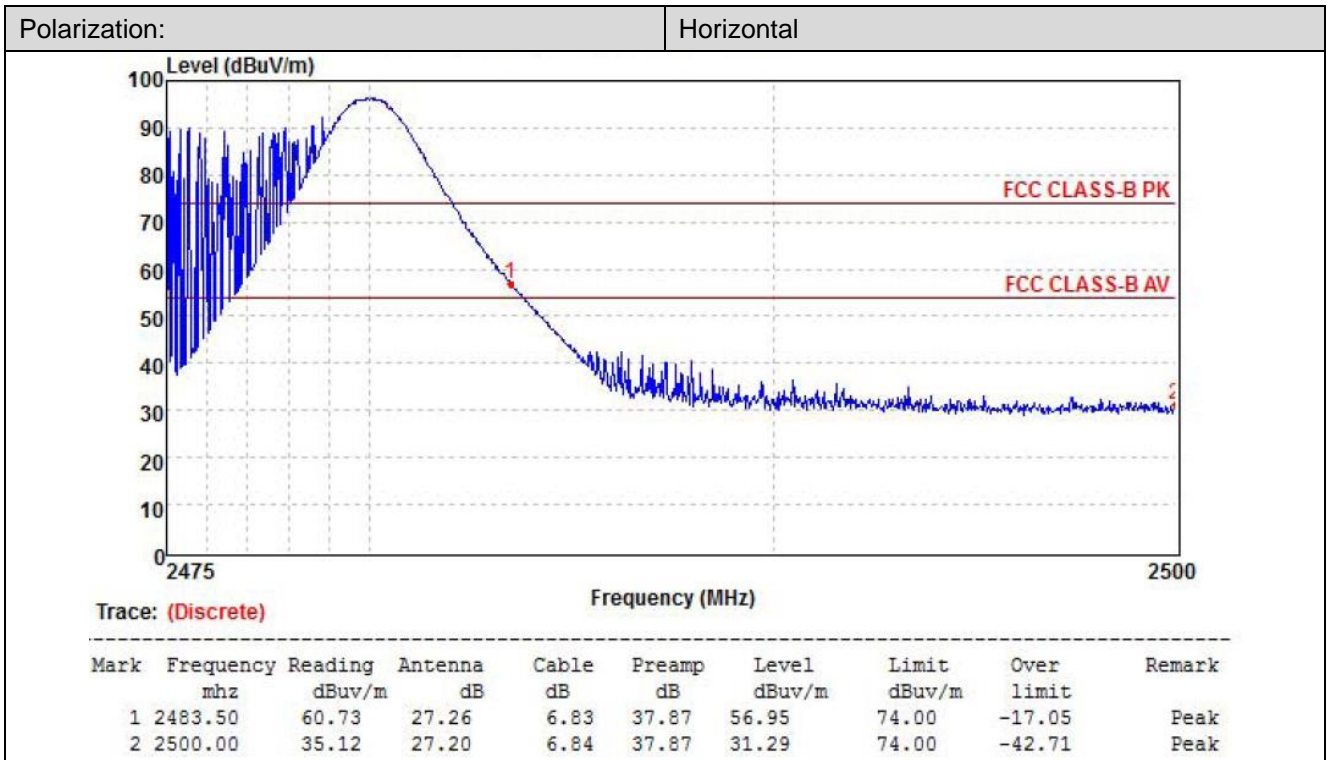
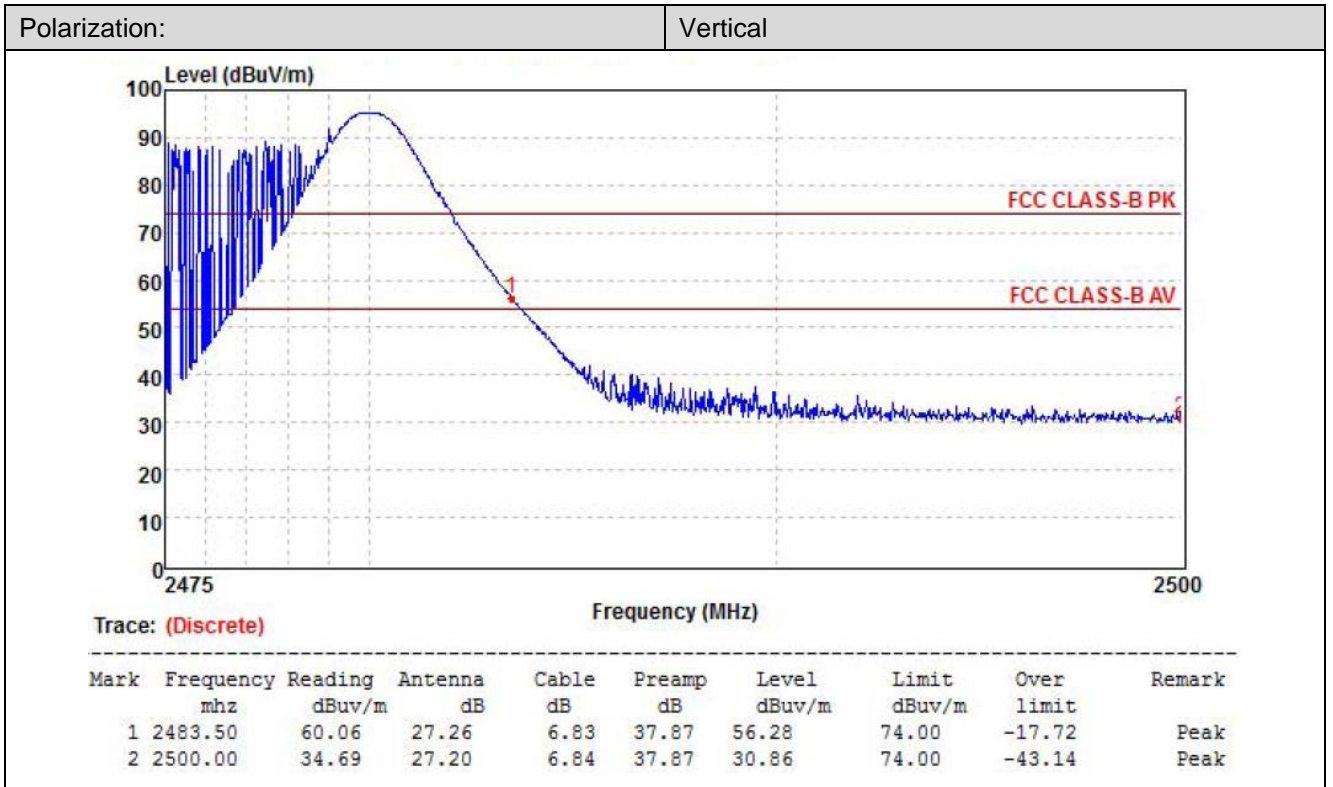

CH78 Average:

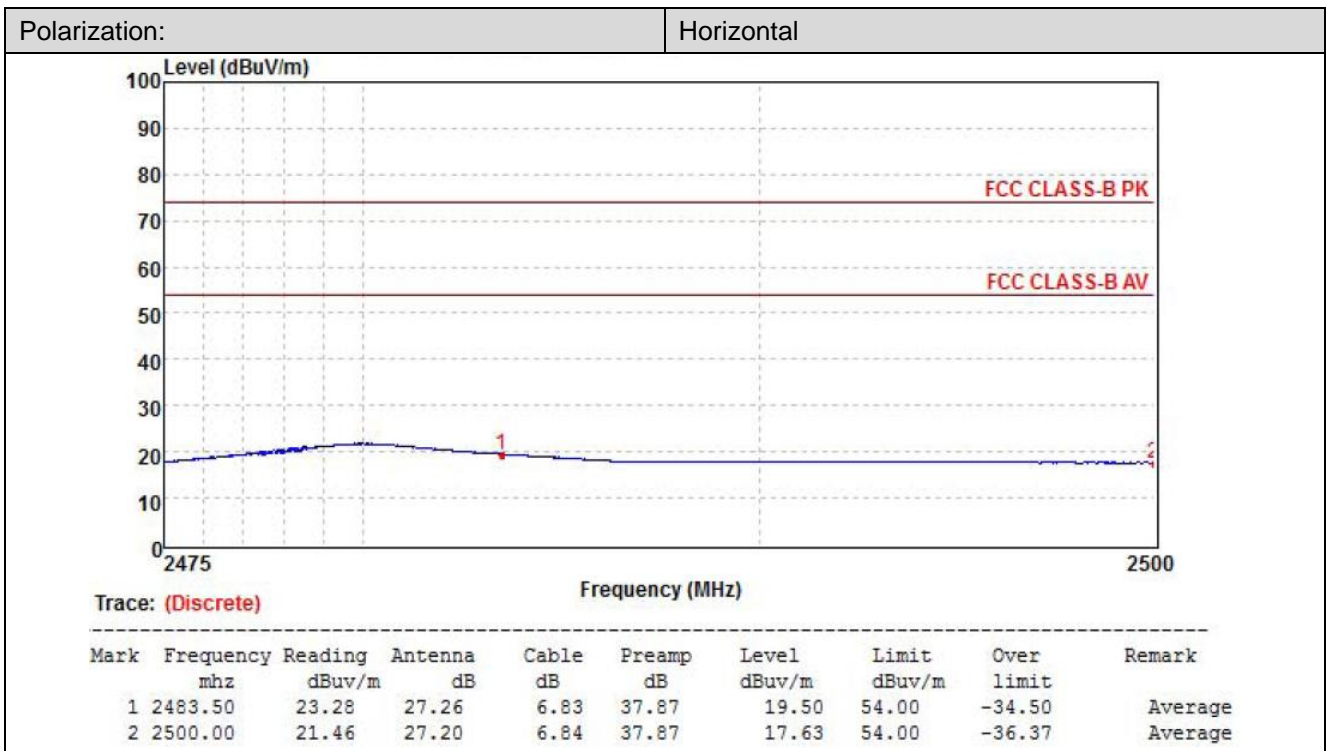
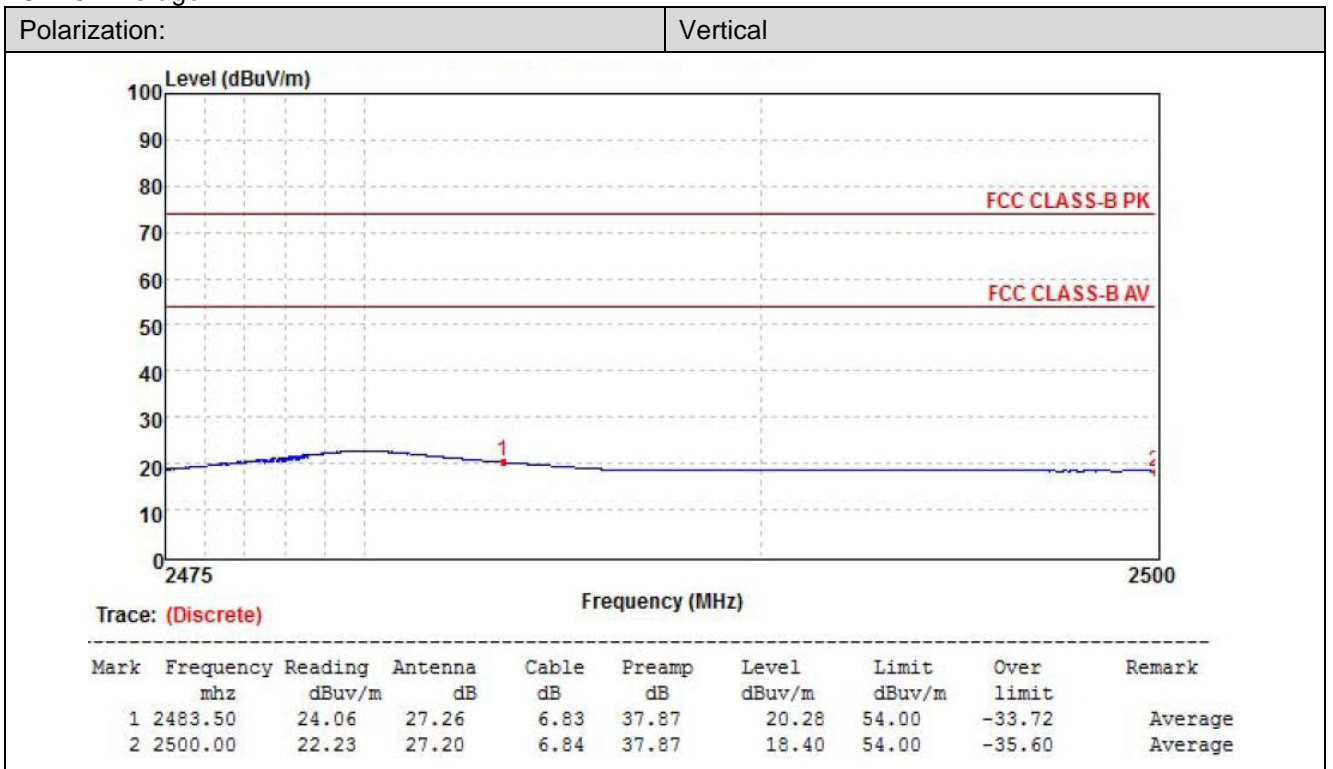

5.10. Band edge and Spurious Emissions (conducted)

LIMIT

FCC CFR Title 47 Part 15 Subpart C Section 15.247 (d): In any 100 kHz bandwidth outside the frequency band in which the spread spectrum intentional radiator is operating, the radio frequency power that is produced by the intentional radiator shall be at least 20 dB below that in the 100 kHz bandwidth within the band that contains the highest level of the desired power, based on either an RF conducted or a radiated measurement.

TEST CONFIGURATION

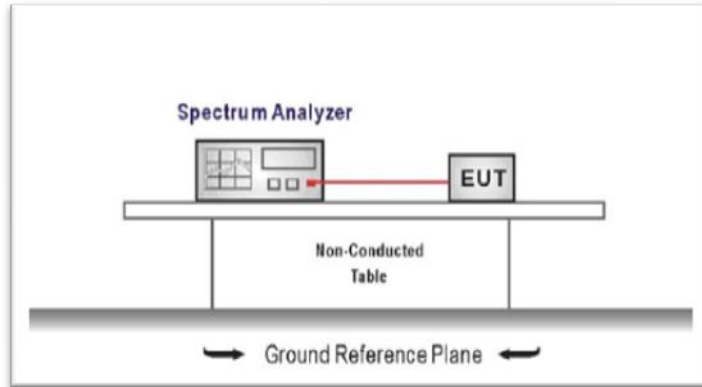

TEST PROCEDURE

1. The transmitter output was connected to the spectrum analyzer through an attenuator, the path loss was compensated to the results for each measurement.
2. Set to the maximum power setting and enable the EUT transmit continuously
3. Use the following spectrum analyzer settings:
RBW = 100 kHz, VBW \geq RBW
Sweep = auto, Detector function = peak, Trace = max hold
4. Measure and record the results in the test report.

TEST MODE:

Please refer to the clause 3.3

TEST RESULTS

Passed Not Applicable

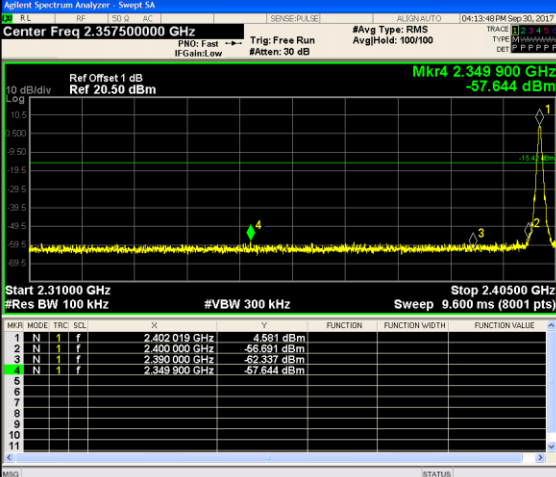
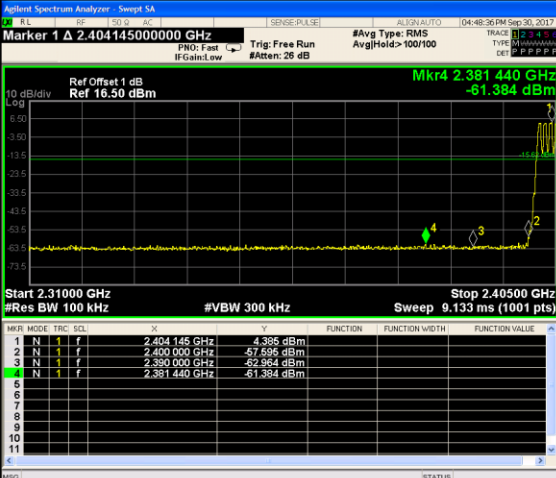
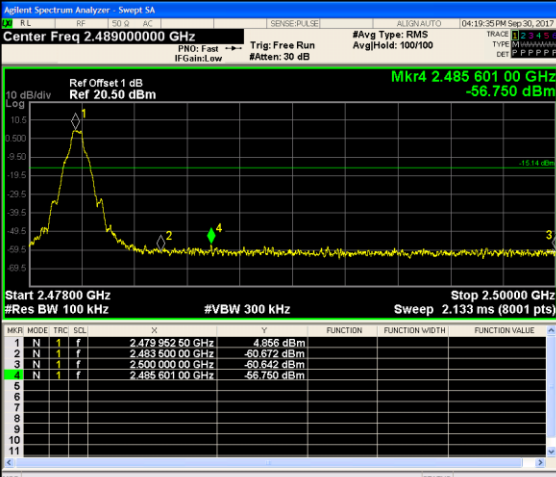
Test Item:	Band edge	Modulation type:	GFSK
<p>CH00 No hopping mode</p>			<p>Frequency</p> <p>Auto Tune</p> <p>Center Freq 2.357500000 GHz</p> <p>Start Freq 2.310000000 GHz</p> <p>Stop Freq 2.405000000 GHz</p> <p>CF Step 9.500000 MHz</p> <p>Freq Offset 0 Hz</p>
<p>CH00 Hopping mode</p>			<p>Peak Search</p> <p>Next Peak</p> <p>Next Pk Right</p> <p>Next Pk Left</p> <p>Marker Delta</p> <p>Mkr--CF</p> <p>Mkr--Ref Lvl</p> <p>More 1 of 2</p>
<p>CH78 No hopping mode</p>			<p>Frequency</p> <p>Auto Tune</p> <p>Center Freq 2.489000000 GHz</p> <p>Start Freq 2.478000000 GHz</p> <p>Stop Freq 2.500000000 GHz</p> <p>CF Step 2.200000 MHz</p> <p>Freq Offset 0 Hz</p>

CH78
Hopping mode

