



# FCC REPORT

**Report Reference No.** ..... : **TRE1709016406** R/C.....: 21830

**FCC ID** ..... : **ZSW-30-050**

**Applicant's name** ..... : **b mobile HK Limited**

**Address** ..... : Flat 18; 14/F Block 1; Golden Industrial Building; 16-26 Kwai Tak Street; Kwai Chung; New Territories; Hong Kong.

**Manufacturer**..... : b mobile HK Limited

**Address**..... : Flat 18; 14/F Block 1; Golden Industrial Building; 16-26 Kwai Tak Street; Kwai Chung; New Territories; Hong Kong.

**Test item description** ..... : **Mobile Phone**

**Trade Mark**..... : Bmobile

**Model/Type reference** ..... : AX1071

**Listed Model(s)**..... : AX1072

**Standard**..... : **47 CFR FCC Part 15 Subpart B - Unintentional Radiators**  
**ANSI C63.4: 2014**

**Date of receipt of test sample**..... : Sep.20, 2017

**Date of testing**..... : Sep.21, 2017 - Oct.09, 2017

**Date of issue**..... : Oct.10, 2017

**Result** ..... : **Pass**

Compiled by  
( position+printed name+signature) . : File administrators Candy Liu 

Supervised by  
( position+printed name+signature) . : Project Engineer : Edward Pan 

Approved by  
( position+printed name+signature) . : RF Manager Hans Hu 

**Testing Laboratory Name**..... : **Shenzhen Huatongwei International Inspection Co., Ltd.**

**Address** ..... : 1/F, Bldg 3, Hongfa Hi-tech Industrial Park, Genyu Road, Tianliao, Gongming, Shenzhen, China

**Shenzhen Huatongwei International Inspection Co., Ltd. All rights reserved.**

This publication may be reproduced in whole or in part for non-commercial purposes as long as the Shenzhen Huatongwei International Inspection Co., Ltd. is acknowledged as copyright owner and source of the material. Shenzhen Huatongwei International Inspection Co., Ltd. takes no responsibility for and will not assume liability for damages resulting from the reader's interpretation of the reproduced material due to its placement and context.

*The test report merely corresponds to the test sample.  
It is not permitted to copy extracts of these test result without the written permission of the test laboratory.*

## Contents

<b>1.</b>	<b><u>TEST STANDARDS AND REPORT VERSION</u></b>	<b>3</b>
1.1.	Test Standards	3
1.2.	Report version	3
<b>2.</b>	<b><u>TEST DESCRIPTION</u></b>	<b>4</b>
<b>3.</b>	<b><u>SUMMARY</u></b>	<b>5</b>
3.1.	Client Information	5
3.2.	Product Description	5
3.3.	EUT operation mode	6
3.4.	EUT configuration	6
3.5.	Configuration of Tested System	7
<b>4.</b>	<b><u>TEST ENVIRONMENT</u></b>	<b>8</b>
4.1.	Address of the test laboratory	8
4.2.	Test Facility	8
4.3.	Equipments Used during the Test	9
4.4.	Environmental conditions	9
4.5.	Statement of the measurement uncertainty	10
<b>5.</b>	<b><u>TEST CONDITIONS AND RESULTS</u></b>	<b>11</b>
5.1.	Conducted Emissions Test	11
5.2.	Radiated Emission Test	14
<b>6.</b>	<b><u>TEST SETUP PHOTOS OF THE EUT</u></b>	<b>18</b>
<b>7.</b>	<b><u>EXTERNAL AND INTERNAL PHOTOS OF THE EUT</u></b>	<b>19</b>

# **1. Test standards and Report version**

## **1.1. Test Standards**

The tests were performed according to following standards:

[47 CFR FCC Part 15 Subpart B](#) - Unintentional Radiators

[ANSI C63.4: 2014](#) – American National Standard for Methods of Measurement of Radio-Noise Emissions from Low-Voltage Electrical and Electronic Equipment in the Range of 9 kHz to 40GHz

## **1.2. Report version**

Version No.	Date of issue	Description
00	Oct.10, 2017	Original

## **2. Test Description**

Test Item	FCC Rule	Result
Conducted Emissions Test	15.107	Pass
Radiated Emission Test	15.109	Pass

Note: The measurement uncertainty is not included in the test result.

### **3. SUMMARY**

#### **3.1. Client Information**

Applicant:	b mobile HK Limited
Address:	Flat 18; 14/F Block 1; Golden Industrial Building;16-26 Kwai Tak Street; Kwai Chung; New Territories; Hong Kong.
Manufacturer:	b mobile HK Limited
Address:	Flat 18; 14/F Block 1; Golden Industrial Building;16-26 Kwai Tak Street; Kwai Chung; New Territories; Hong Kong.

#### **3.2. Product Description**

Name of EUT:	Mobile Phone
Trade Mark:	Bmobile
Model No.:	AX1071
Listed Model(s):	AX1072
IMEI 1:	355408080203579
IMEI 2:	355408080203868
Power supply:	DC 3.8V From exchange battery
Adapter information:	Input: 100-240Va.c., 50/60Hz, 0.2A Output: 5Vd.c.,1A
Hardware version:	V00
Software version:	MX2135FA_B25_E5017_SA11_N_V01_170906 Web Sep 6 17:20:53 CST 2017

### 3.3. EUT operation mode

Test mode	Playing Video	Connect to PC (Down loading)	Camera	Adapter
1	■			■
2		■		
3			■	■

Note:

1. ■ is operation mode.

Pre-scan above all test mode, found below test mode which it was worse case mode.

Test item	Test mode (Worse case mode)
Conducted emission	Mode 2
Radiated emission	Mode 2

### 3.4. EUT configuration

The following peripheral devices and interface cables were connected during the measurement:

- - supplied by the manufacturer
- - supplied by the lab

	Length (m) :	
	Shield :	
	Detachable :	
	Manufacturer :	
	Model No. :	-

### 3.5. Configuration of Tested System

**Configuration of Tested System**

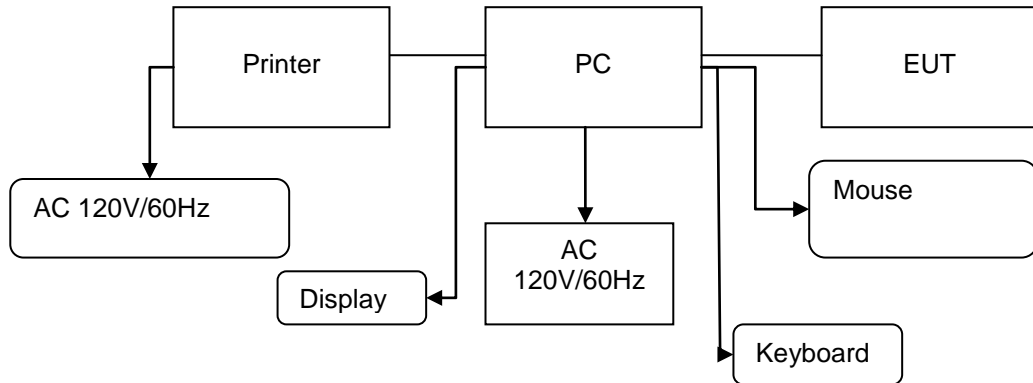

**Equipment Used in Tested System**

No.	Equipment	Manufacturer	Model No.	Serial No.	Length	shielded/unshielded	Notes
1	PC	DELL	DIMENSION E520	1RNN42X	/	/	DOC
2	Printer	ESPOn	C3990	C3990A	/	/	DOC
3	Mouse	DELL	MO56U OA	G0E02SY7	1.00m	unshielded	DOC
4	Display	DELL	1707FPt	CN-OFC237-71618-65G-AAKC	/	/	DOC
5	Keyboard	DELL	L100	CNRH65665890726009L	/	/	DOC
6	USB Cable (EUT to PC)	ITALCOM GROUP	USB 2.0	N/A	0.80m	unshielded	N/A
7	USB Cable (Printer to PC)	Genshuo	USB 2.0	N/A	1.20m	unshielded	N/A
8	Power line	/	/	N/A	1.00m	unshielded	N/A

## **4. TEST ENVIRONMENT**

### **4.1. Address of the test laboratory**

Laboratory: Shenzhen Huatongwei International Inspection Co., Ltd.

Address: 1/F, Bldg 3, Hongfa Hi-tech Industrial Park, Genyu Road, Tianliao, Gongming, Shenzhen, China

Phone: 86-755-26748019 Fax: 86-755-26748089

### **4.2. Test Facility**

The test facility is recognized, certified, or accredited by the following organizations:

#### **CNAS-Lab Code: L1225**

Shenzhen Huatongwei International Inspection Co., Ltd. has been assessed and proved to be in compliance with CNAS-CL01 Accreditation Criteria for Testing and Calibration Laboratories (identical to ISO/IEC 17025: 2005 General Requirements) for the Competence of Testing and Calibration Laboratories.

#### **A2LA-Lab Cert. No.: 3902.01**

Shenzhen Huatongwei International Inspection Co., Ltd. EMC Laboratory has been accredited by A2LA for technical competence in the field of electrical testing, and proved to be in compliance with ISO/IEC 17025: 2005 General Requirements for the Competence of Testing and Calibration Laboratories and any additional program requirements in the identified field of testing.

#### **FCC-Registration No.: 762235**

Shenzhen Huatongwei International Inspection Co., Ltd. EMC Laboratory has been registered and fully described in a report filed with the FCC (Federal Communications Commission). The acceptance letter from the FCC is maintained in our files. Registration 762235

#### **IC-Registration No.: 5377B-1**

Two 3m Alternate Test Site of Shenzhen Huatongwei International Inspection Co., Ltd. has been registered by Certification and Engineering Bureau of Industry Canada for the performance of radiated measurements with Registration No. 5377B-1.

#### **ACA**

Shenzhen Huatongwei International Inspection Co., Ltd. EMC Laboratory can also perform testing for the Australian C-Tick mark as a result of our A2LA accreditation.



### 4.3. Equipments Used during the Test

Conducted Emission					
Item	Test Equipment	Manufacturer	Model No.	Serial No.	Last Cal.
1	EMI TEST RECEIVER	Rohde & Schwarz	ESCI	100106	2016/11/13
2	ARTIFICIAL MAINS	Rohde & Schwarz	ESH2-Z5	100028	2016/11/13
3	PULSE LIMITER	Rohde & Schwarz	ESHSZ2	100044	2016/11/13
4	EMI TEST SOFTWARE	Rohde & Schwarz	ES-K1	N/A	N/A

Radiated Emission					
Item	Test Equipment	Manufacturer	Model No.	Serial No.	Last Cal.
1	ULTRA-BROADBAND ANTENNA	ShwarzBeck	VULB9163	538	2016/11/13
2	EMI TEST RECEIVER	Rohde & Schwarz	ESI 26	100009	2016/11/13
3	EMI TEST Software	Audix	E3	N/A	N/A
4	TURNTABLE	MATURO	TT2.0	----	N/A
5	ANTENNA MAST	MATURO	TAM-4.0-P	----	N/A
6	EMI TEST Software	Rohde & Schwarz	ESK1	N/A	N/A
7	ULTRA-BROADBAND ANTENNA	Rohde&Schwarz	HL562	100015	2016/11/13
8	Amplifer	Sonoma	310N	E009-13	2016/11/13
9	JS amplifer	Rohde & Schwarz	JS4-00101800-28-5A	F201504	2016/11/13
11	TURNTABLE	ETS	2088	2149	N/A
12	ANTENNA MAST	ETS	2075	2346	N/A
13	HORN ANTENNA	Rohde&Schwarz	HF906	100039	2016/11/13

The calibration interval was one year.

### 4.4. Environmental conditions

During the measurement the environmental conditions were within the listed ranges:

Temperature:	15~35°C
Relative Humidity:	30~60 %
Air Pressure:	950~1050mba

#### 4.5. Statement of the measurement uncertainty

The data and results referenced in this document are true and accurate. The reader is cautioned that there may be errors within the calibration limits of the equipment and facilities. The measurement uncertainty was calculated for all measurements listed in this test report acc. to CISPR 16 - 4 „Specification for radio disturbance and immunity measuring apparatus and methods – Part 4: Uncertainty in EMC Measurements“ and is documented in the Shenzhen Huatongwei International Inspection Co., Ltd quality system acc. to DIN EN ISO/IEC 17025. Furthermore, component and process variability of devices similar to that tested may result in additional deviation. The manufacturer has the sole responsibility of continued compliance of the device.

Hereafter the best measurement capability for Shenzhen Huatongwei laboratory is reported:

Test	Range	Measurement Uncertainty	Notes
Radiated Emission	30~1000MHz	4.24 dB	(1)
Radiated Emission	1~18GHz	5.16 dB	(1)
Radiated Emission	18-40GHz	5.54 dB	(1)
Conducted Disturbance	0.15~30MHz	3.39 dB	(1)

(1) This uncertainty represents an expanded uncertainty expressed at approximately the 95% confidence level using a coverage factor of  $k=2$ .

## 5. TEST CONDITIONS AND RESULTS

### 5.1. Conducted Emissions Test

#### LIMIT

FCC CFR Title 47 Part 15 Subpart B Section 15.107:

Frequency range (MHz)	Limit (dBuV)	
	Quasi-peak	Average
0.15-0.5	66 to 56*	56 to 46*
0.5-5	56	46
5-30	60	50

\* Decreases with the logarithm of the frequency.

#### TEST CONFIGURATION

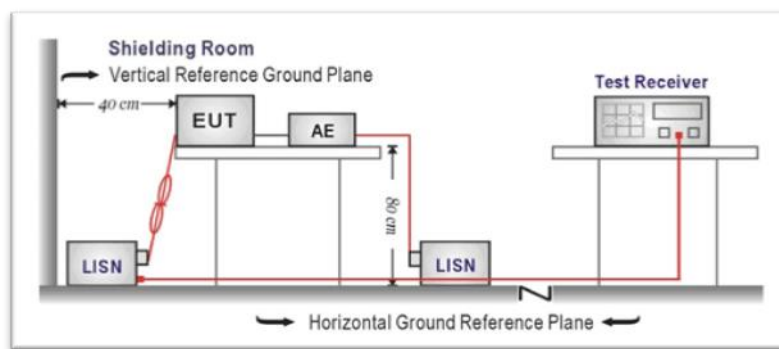

#### TEST PROCEDURE

1. The EUT was setup according to ANSI C63.4-2014.
2. The EUT was placed on a platform of nominal size, 1 m by 1.5 m, raised 80 cm above the conducting ground plane. The vertical conducting plane was located 40 cm to the rear of the EUT. All other surfaces of EUT were at least 80 cm from any other grounded conducting surface.
3. The EUT and simulators are connected to the main power through a line impedance stabilization network (LISN). The LISN provides a 50 ohm /50uH coupling impedance for the measuring equipment.
4. The peripheral devices are also connected to the main power through a LISN. (Please refer to the block diagram of the test setup and photographs)
5. Each current-carrying conductor of the EUT power cord, except the ground (safety) conductor, was individually connected through a LISN to the input power source.
6. The excess length of the power cord between the EUT and the LISN receptacle were folded back and forth at the center of the lead to form a bundle not exceeding 40 cm in length.
7. Conducted emissions were investigated over the frequency range from 0.15 MHz to 30 MHz using a receiver bandwidth of 9 kHz.
8. During the above scans, the emissions were maximized by cable manipulation.

#### TEST MODE:

Please refer to the clause 3.3

#### TEST RESULTS

**Passed**       **Not Applicable**

Note: Transd=Cable lose+ PULSE LIMITER factor+ ARTIFICIAL MAINS factor; Margin= Limit -Level

Test Line:

L

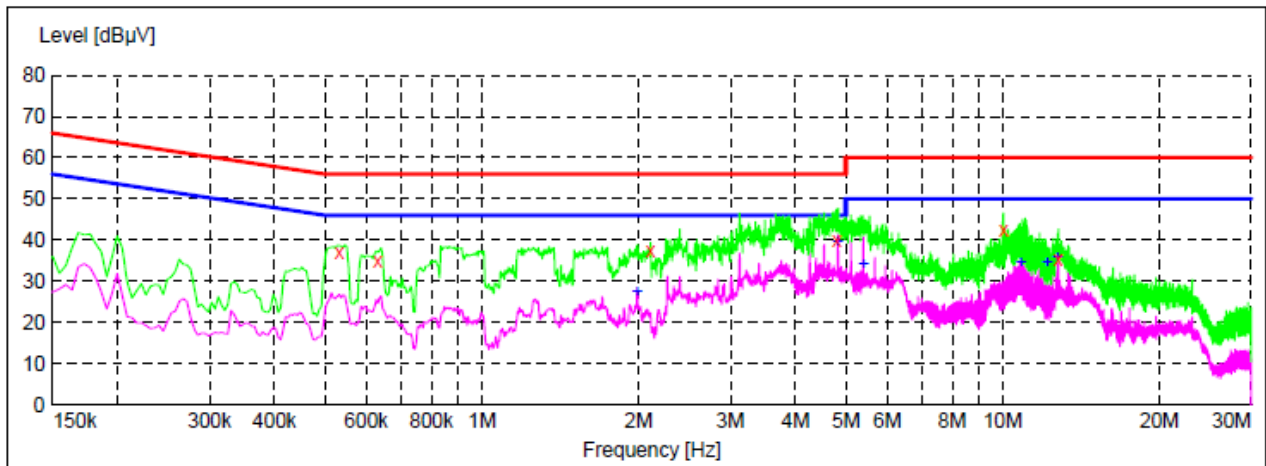

\* \* \* MES GM1709255101\_fin

**MEASUREMENT RESULT: "GM1709255101\_fin"**

9/25/2017 10:59PM

Frequency MHz	Level dBµV	Transd dB	Limit dBµV	Margin dB	Detector	Line	PE
0.532500	36.90	10.2	56	19.1	QP	L1	GND
0.631500	35.10	10.2	56	20.9	QP	L1	GND
2.107500	37.30	10.2	56	18.7	QP	L1	GND
4.812000	40.10	10.3	56	15.9	QP	L1	GND
10.032000	42.60	10.6	60	17.4	QP	L1	GND
12.777000	35.50	10.5	60	24.5	QP	L1	GND

**MEASUREMENT RESULT: "GM1709255101\_fin2"**

9/25/2017 10:59PM

Frequency MHz	Level dBµV	Transd dB	Limit dBµV	Margin dB	Detector	Line	PE
1.986000	27.50	10.2	46	18.5	AV	L1	GND
4.825500	39.50	10.3	46	6.5	AV	L1	GND
5.397000	34.00	10.3	50	16.0	AV	L1	GND
10.846500	34.30	10.6	50	15.7	AV	L1	GND
12.196500	34.40	10.5	50	15.6	AV	L1	GND
12.745500	35.70	10.5	50	14.3	AV	L1	GND

Test Line: N

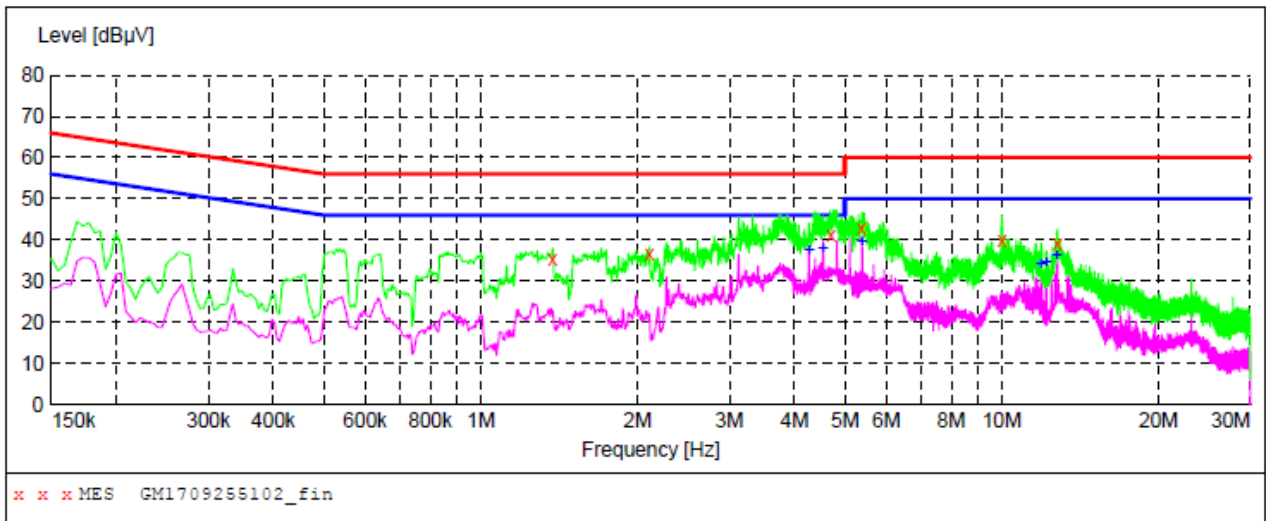

**MEASUREMENT RESULT: "GM1709255102\_fin"**

9/25/2017 11:02PM

Frequency MHz	Level dBµV	Transd dB	Limit dBµV	Margin dB	Detector	Line	PE
1.374000	35.50	10.2	56	20.5	QP	N	GND
2.107500	36.50	10.2	56	19.5	QP	N	GND
4.708500	41.20	10.3	56	14.8	QP	N	GND
5.392500	42.70	10.3	60	17.3	QP	N	GND
10.027500	39.80	10.6	60	20.2	QP	N	GND
12.808500	39.20	10.5	60	20.8	QP	N	GND

**MEASUREMENT RESULT: "GM1709255102\_fin2"**

9/25/2017 11:02PM

Frequency MHz	Level dBµV	Transd dB	Limit dBµV	Margin dB	Detector	Line	PE
4.263000	37.40	10.3	46	8.6	AV	N	GND
4.542000	38.00	10.3	46	8.0	AV	N	GND
5.392500	39.40	10.3	50	10.6	AV	N	GND
11.890500	33.90	10.6	50	16.1	AV	N	GND
12.196500	34.50	10.5	50	15.5	AV	N	GND
12.745500	36.20	10.5	50	13.8	AV	N	GND

## 5.2. Radiated Emission Test

### LIMIT

#### FCC CFR Title 47 Part 15 Subpart B Section 15.109

Frequency	Limit (dBuV/m @3m)	Value
30MHz-88MHz	40.00	Quasi-peak
88MHz-216MHz	43.50	Quasi-peak
216MHz-960MHz	46.00	Quasi-peak
960MHz-1GHz	54.00	Quasi-peak
Above 1GHz	54.00	Average
	74.00	Peak

### TEST CONFIGURATION

#### ➤ 30MHz ~ 1GHz

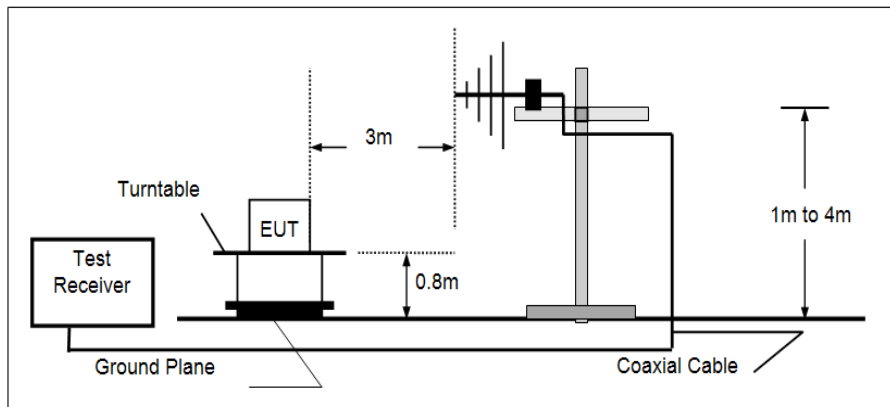

#### ➤ Above 1GHz

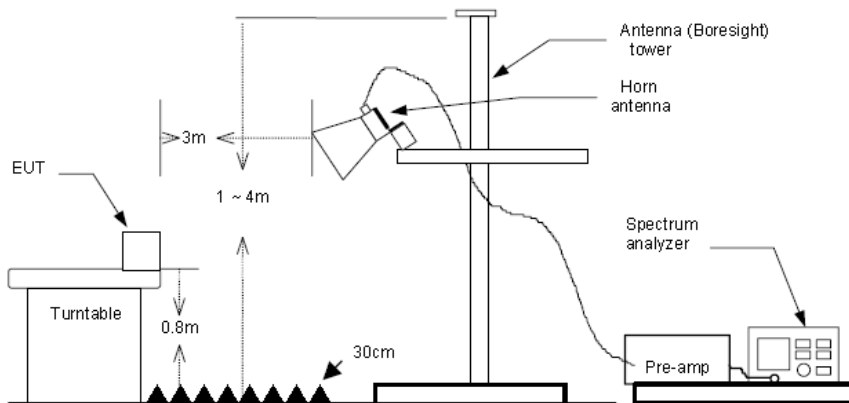

### TEST PROCEDURE

1. The EUT was tested according to ANSI C63.4:2014.
2. The EUT is placed on a turntable which is 0.8 meter above ground. The turn table is rotated 360 degrees to determine the position of the maximum emission level.
3. The EUT was positioned such that the distance from antenna to the EUT was 3 meters.
4. The antenna is scanned from 1 meter to 4 meters to find out the maximum emission level. This is repeated for both horizontal and vertical polarization of the antenna.
5. Use the following spectrum analyzer settings
  - (1) Span shall wide enough to fully capture the emission being measured;
  - (2) Below 1GHz, RBW=120KHz, VBW=300KHz, Sweep=auto, Detector function=peak, Trace=max hold; If the emission level of the EUT measured by the peak detector is 3 dB lower than the applicable limit, the peak emission level will be reported. Otherwise, the emission measurement will be repeated using

the quasi-peak detector and reported.  
(3) Above 1GHz, RBW=1MHz, VBW=3MHz

**TEST MODE:**

Please refer to the clause 3.3

**TEST RESULTS**

**Passed**       **Not Applicable**

Note: Final Level = Receiver Read level + Antenna Factor + Cable Loss - Preamplifier Factor

➤ Vertical

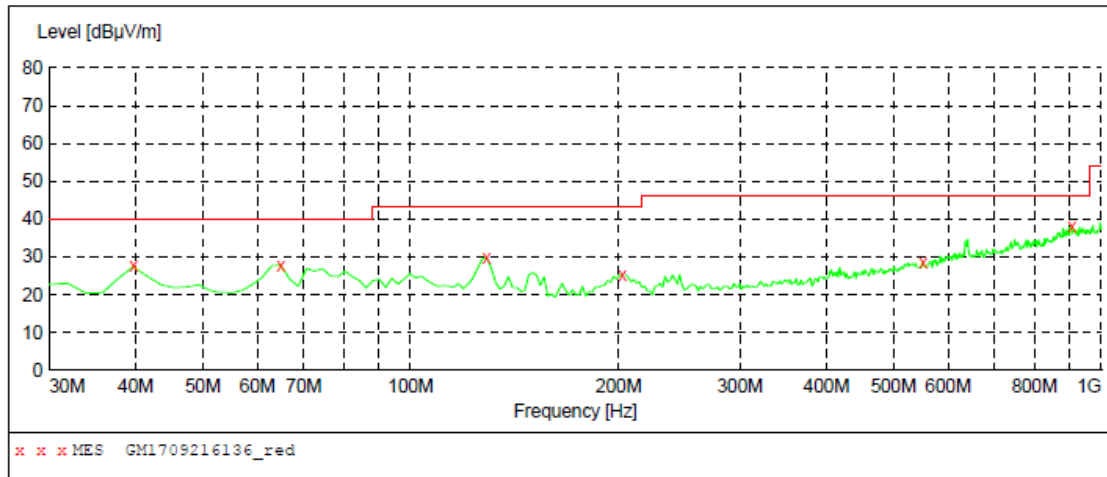

**MEASUREMENT RESULT: "GM1709216136\_red"**

9/21/2017 7:16PM

Frequency MHz	Level dBuV/m	Transd dB	Limit dBuV/m	Margin dB	Det.	Height cm	Azimuth deg	Polarization
39.700000	27.50	-10.1	40.0	12.5	QP	100.0	0.00	VERTICAL
64.920000	27.90	-11.4	40.0	12.1	QP	100.0	308.00	VERTICAL
128.940000	29.80	-13.2	43.5	13.7	QP	100.0	189.00	VERTICAL
202.660000	25.40	-10.2	43.5	18.1	QP	100.0	281.00	VERTICAL
551.860000	28.70	-0.7	46.0	17.3	QP	100.0	164.00	VERTICAL
906.880000	38.10	6.8	46.0	7.9	QP	100.0	356.00	VERTICAL

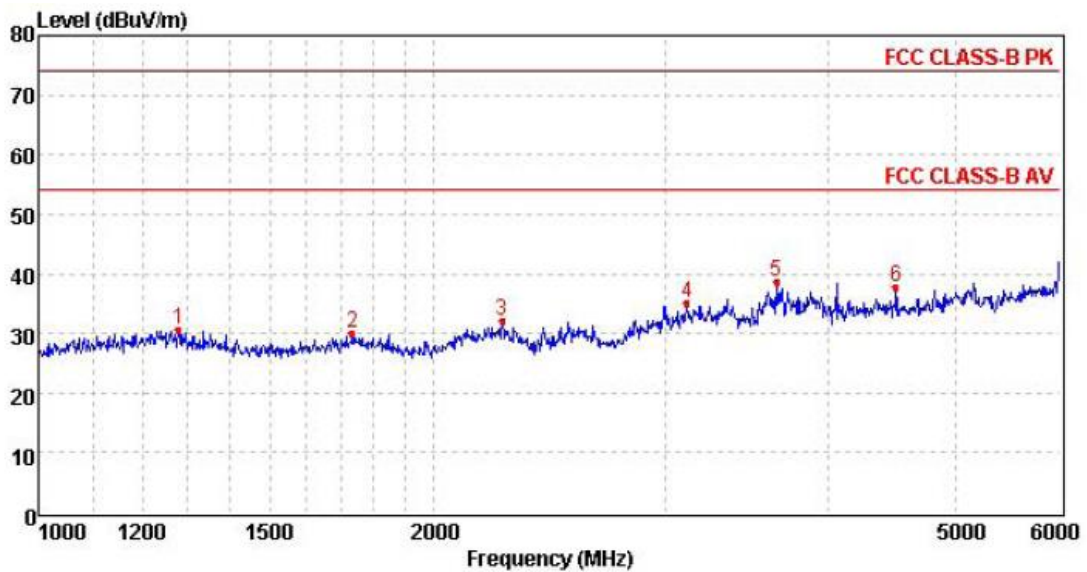

Mark	Frequency MHz	Reading dBuV/m	Antenna dB	Cable dB	Preamp dB	Level dBuV/m	Limit dBuV/m	Over limit	Remark
1	1278.22	36.28	26.22	4.79	36.53	30.76	74.00	-43.24	Peak
2	1733.38	36.02	25.27	5.83	37.00	30.12	74.00	-43.88	Peak
3	2255.70	35.21	27.84	6.53	37.50	32.08	74.00	-41.92	Peak
4	3119.80	36.85	28.80	7.62	38.21	35.06	74.00	-38.94	Peak
5	3646.07	39.28	29.30	8.32	38.26	38.64	74.00	-35.36	Peak
6	4496.44	35.11	30.69	9.29	37.40	37.69	74.00	-36.31	Peak



➤ Horizontal

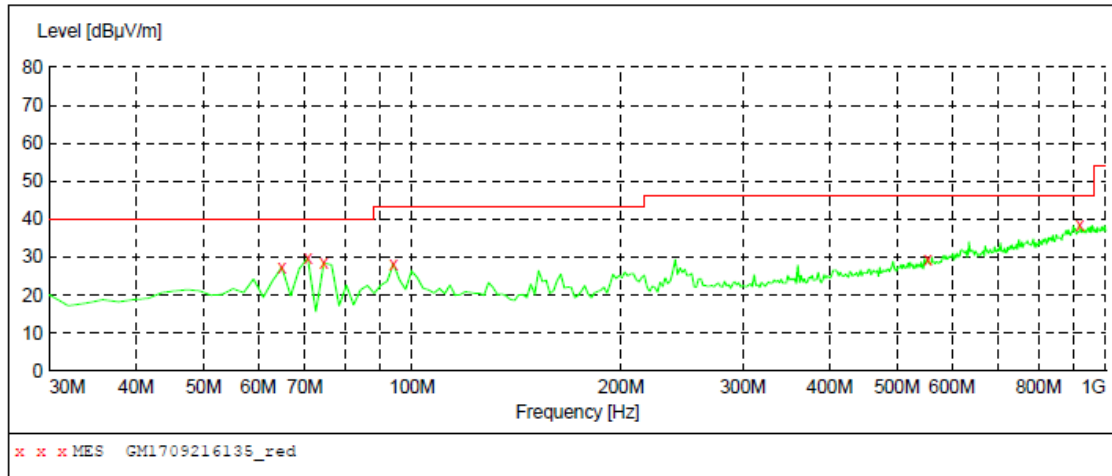

**MEASUREMENT RESULT: "GM1709216135\_red"**

9/21/2017 7:13PM

Frequency MHz	Level dBuV/m	Transd dB	Limit dBuV/m	Margin dB	Det.	Height cm	Azimuth deg	Polarization
64.920000	27.40	-11.4	40.0	12.6	QP	300.0	247.00	HORIZONTAL
70.740000	29.70	-13.3	40.0	10.3	QP	300.0	235.00	HORIZONTAL
74.620000	28.50	-14.8	40.0	11.5	QP	300.0	235.00	HORIZONTAL
94.020000	28.30	-11.7	43.5	15.2	QP	300.0	75.00	HORIZONTAL
553.800000	29.60	-0.7	46.0	16.4	QP	100.0	342.00	HORIZONTAL
916.580000	38.40	6.9	46.0	7.6	QP	300.0	183.00	HORIZONTAL

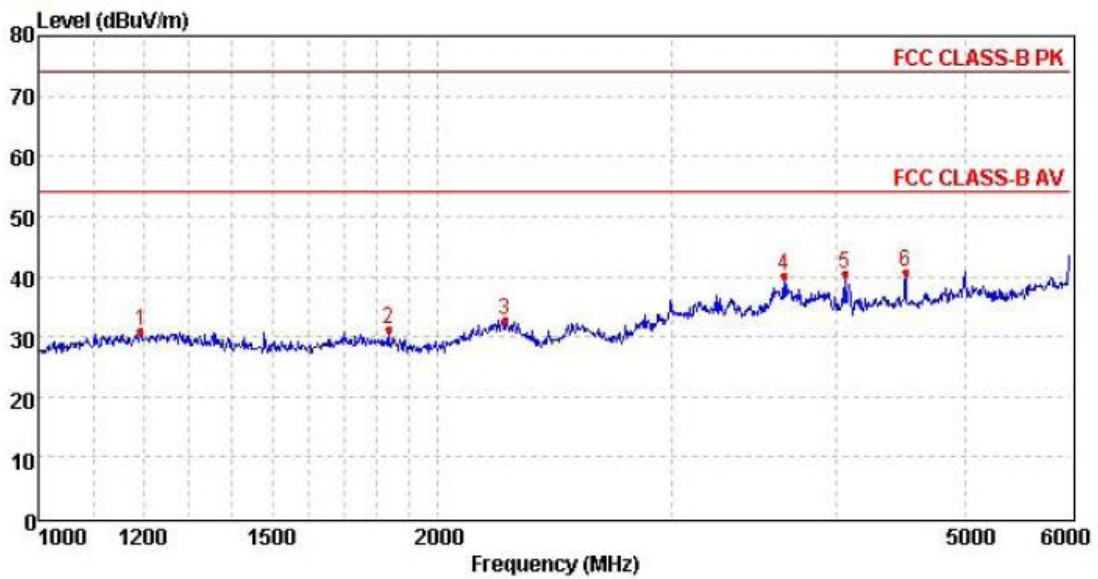

Mark	Frequency MHz	Reading dBuV/m	Antenna dB	Cable dB	Preamp dB	Level dBuV/m	Limit dBuV/m	Over limit	Remark
1	1194.09	36.63	26.25	4.65	36.57	30.96	74.00	-43.04	Peak
2	1835.66	36.87	25.36	6.02	37.17	31.08	74.00	-42.92	Peak
3	2247.63	35.91	27.79	6.52	37.47	32.75	74.00	-41.25	Peak
4	3646.07	40.92	29.30	8.32	38.26	40.28	74.00	-33.72	Peak
5	4052.62	39.79	29.81	8.82	37.99	40.43	74.00	-33.57	Peak
6	4504.51	38.18	30.71	9.30	37.39	40.80	74.00	-33.20	Peak

## 6. Test Setup Photos of the EUT

Conducted Emission Connect to PC



Radiated Emission (30MHz-1GHz) Connect to PC



Radiated Emission (above 1GHz) Connect to PC

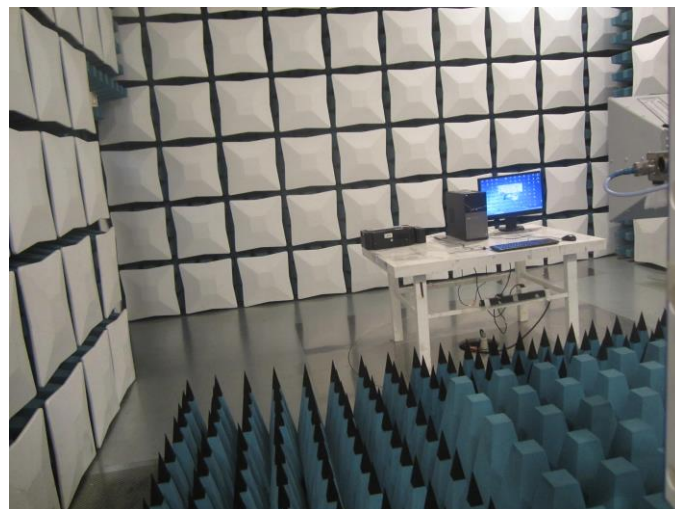



## **7. External and Internal photos of the EUT**

Reference to the test report No.: TRE1709016401.

.....**End of Report**.....