



TEST REPORT

Report Reference No...... : **TRE1709016403** R/C.....: 21830

FCC ID..... : **ZSW-30-050**

Applicant's name..... : **b mobile HK Limited**

Address..... : Flat 18; 14/F Block 1; Golden Industrial Building;16-26 Kwai Tak Street; Kwai Chung; New Territories; Hong Kong.

Manufacturer..... : b mobile HK Limited

Address..... : Flat 18; 14/F Block 1; Golden Industrial Building;16-26 Kwai Tak Street; Kwai Chung; New Territories; Hong Kong.

Test item description : **Mobile Phone**

Trade Mark : Bmobile

Model/Type reference..... : AX1071

Listed Model(s)..... : AX1072

Standard : **FCC CFR Title 47 Part 15 Subpart C Section 15.247**

Date of receipt of test sample..... : Sep.20, 2017

Date of testing..... : Sep.21, 2017 - Oct.09, 2017

Date of issue..... : Oct.10, 2017

Result..... : **PASS**

Compiled by
(position+printedname+signature).... : File administrators Candy Liu *Candy Liu*

Supervised by
(position+printedname+signature)..... : Project Engineer : Edward Pan *Edward Pan*

Approved by
(position+printedname+signature)..... : RF Manager Hans Hu *Hans Hu*

Testing Laboratory Name : **Shenzhen Huatongwei International Inspection Co., Ltd.**

Address..... : 1/F, Bldg 3, Hongfa Hi-tech Industrial Park, Genyu Road, Tianliao, Gongming, Shenzhen, China

Shenzhen Huatongwei International Inspection Co., Ltd. All rights reserved.

This publication may be reproduced in whole or in part for non-commercial purposes as long as the Shenzhen Huatongwei International Inspection Co., Ltd. is acknowledged as copyright owner and source of the material. Shenzhen Huatongwei International Inspection Co., Ltd. takes no responsibility for and will not assume liability for damages resulting from the reader's interpretation of the reproduced material due to its placement and context.

The test report merely correspond to the test sample.

Contents

| | | |
|-----------|---|-----------|
| 1. | <u>TEST STANDARDS AND REPORT VERSION</u> | 3 |
| 1.1. | Test Standards | 3 |
| 1.2. | Report version | 3 |
| 2. | <u>TEST DESCRIPTION</u> | 4 |
| 3. | <u>SUMMARY</u> | 5 |
| 3.1. | Client Information | 5 |
| 3.2. | Product Description | 5 |
| 3.3. | Operation state | 6 |
| 3.4. | EUT configuration | 6 |
| 3.5. | Modifications | 6 |
| 4. | <u>TEST ENVIRONMENT</u> | 7 |
| 4.1. | Address of the test laboratory | 7 |
| 4.2. | Test Facility | 7 |
| 4.3. | Environmental conditions | 8 |
| 4.4. | Statement of the measurement uncertainty | 8 |
| 4.5. | Equipments Used during the Test | 9 |
| 5. | <u>TEST CONDITIONS AND RESULTS</u> | 10 |
| 5.1. | Antenna requirement | 10 |
| 5.2. | Conducted Emissions (AC Main) | 11 |
| 5.3. | Conducted Peak Output Power | 14 |
| 5.4. | Power Spectral Density | 15 |
| 5.5. | 6dB bandwidth | 21 |
| 5.6. | Restricted band | 27 |
| 5.7. | Band edge and Spurious Emissions (conducted) | 38 |
| 5.8. | Spurious Emissions (radiated) | 55 |
| 6. | <u>TEST SETUP PHOTOS</u> | 62 |
| 7. | <u>EXTERANAL AND INTERNAL PHOTOS</u> | 63 |

1. TEST STANDARDS AND REPORT VERSION

1.1. Test Standards

The tests were performed according to following standards:

[FCC Rules Part 15.247](#): Frequency Hopping, Direct Spread Spectrum and Hybrid Systems that are in operation within the bands of 902-928 MHz, 2400-2483.5 MHz, and 5725-5850 MHz.

[ANSI C63.10:2013](#): American National Standard for Testing Unlicensed Wireless Devices

[KDB 558074 D01 DTS Meas Guidance v04](#): Guidance for Performing Compliance Measurements on Digital Transmission Systems (DTS) Operating under §15.247

1.2. Report version

| Version No. | Date of issue | Description |
|-------------|---------------|-------------|
| 00 | Oct.10, 2017 | Original |
| | | |
| | | |
| | | |
| | | |

2. TEST DESCRIPTION

| Test Item | FCC Rule | Result | Test Engineer |
|------------------------------------|------------------|---------------|----------------------|
| Antenna requirement | 15.203/15.247(c) | Pass | William Wang |
| Line Conducted Emissions (AC Main) | 15.207 | Pass | William Wang |
| Conducted Peak Output Power | 15.247(b)(3) | Pass | William Wang |
| Power Spectral Density | 15.247(e) | Pass | William Wang |
| 6dB Bandwidth | 15.247(a)(2) | Pass | William Wang |
| Restricted band | 15.247(d)/15.205 | Pass | William Wang |
| Spurious Emissions | 15.247(d)/15.209 | Pass | William Wang |

Note: The measurement uncertainty is not included in the test result.

3. SUMMARY

3.1. Client Information

| | |
|---------------|--|
| Applicant: | b mobile HK Limited |
| Address: | Flat 18; 14/F Block 1; Golden Industrial Building;16-26 Kwai Tak Street; Kwai Chung; New Territories; Hong Kong. |
| Manufacturer: | b mobile HK Limited |
| Address: | Flat 18; 14/F Block 1; Golden Industrial Building;16-26 Kwai Tak Street; Kwai Chung; New Territories; Hong Kong. |

3.2. Product Description

| | |
|----------------------|--|
| Name of EUT: | Mobile Phone |
| Trade Mark: | Bmobile |
| Model No.: | AX1071 |
| Listed Model(s): | AX1072 |
| IMEI 1: | 355408080203579 |
| IMEI 2: | 355408080203868 |
| Power supply: | DC 3.8V From exchange battery |
| Adapter information: | Input: 100-240Va.c., 50/60Hz, 0.2A Output: 5Vd.c., 1A |
| Hardware version: | V00 |
| Software version: | MX2135FA_B25_E5017_SA11_N_V01_170906 Web Sep 6 17:20:53 CST 2017 |
| WIFI | |
| Supported type: | 802.11b/802.11g/802.11n(HT20)/802.11n(HT40) |
| Modulation: | DSSS for 802.11b OFDM for 802.11g/802.11n(HT20)/802.11n(HT40) |
| Operation frequency: | 2412MHz~2462MHz for 802.11b/802.11g/802.11n(HT20) 2422MHz~2452MHz for 802.11n(HT40) |
| Channel number: | 11 for 802.11b/802.11g/802.11n(HT20) 7 for 802.11n(HT40) |
| Channel separation: | 5MHz |
| Antenna type: | PIFA Antenna |
| Antenna gain: | 0.5 dBi |

3.3. Operation state

➤ Test frequency list

According to section 15.31(m), regards to the operating frequency range over 10 MHz, must select three channel which were tested. the Lowest frequency, the middle frequency, and the highest frequency of channel were selected to perform the test, please see the above gray bottom.

| 802.11b/g/n(HT20) | | 802.11n(HT40) | |
|-------------------|-----------------|---------------|-----------------|
| Channel | Frequency (MHz) | Channel | Frequency (MHz) |
| 01 | 2412 | 01 | - |
| 02 | 2417 | 02 | - |
| 03 | 2422 | 03 | 2422 |
| 04 | 2427 | 04 | 2427 |
| 05 | 2432 | 05 | 2432 |
| 06 | 2437 | 06 | 2437 |
| 07 | 2442 | 07 | 2442 |
| 08 | 2447 | 08 | 2447 |
| 09 | 2452 | 09 | 2452 |
| 10 | 2457 | 10 | - |
| 11 | 2462 | 11 | - |

➤ Test mode

| |
|---|
| For RF test items |
| The engineering test program was provided and enabled to make EUT continuous transmit (duty cycle>98%). |
| For AC power line conducted emissions: |
| The EUT was set to connect with the WLAN AP under large package sizes transmission. |
| For RF test axis |
| EUT in each of three orthogonal axis emissions had been tested ,but only the worst case (X axis) data Recorded in the report. |

3.4. EUT configuration

The following peripheral devices and interface cables were connected during the measurement:

- - supplied by the manufacturer
- - supplied by the lab

| | | |
|-----|---------------|---|
| ○ / | Manufacturer: | / |
| | Model No.: | / |
| ○ / | Manufacturer: | / |
| | Model No.: | / |

3.5. Modifications

No modifications were implemented to meet testing criteria.

4. TEST ENVIRONMENT

4.1. Address of the test laboratory

Laboratory: Shenzhen Huatongwei International Inspection Co., Ltd.

Address: 1/F, Bldg 3, Hongfa Hi-tech Industrial Park, Genyu Road, Tianliao, Gongming, Shenzhen, China

4.2. Test Facility

CNAS-Lab Code: L1225

Shenzhen Huatongwei International Inspection Co., Ltd. has been assessed and proved to be in compliance with CNAS-CL01 Accreditation Criteria for Testing and Calibration Laboratories (identical to ISO/IEC17025: 2005 General Requirements) for the Competence of Testing and Calibration Laboratories.

A2LA-Lab Cert. No.: 3902.01

Shenzhen Huatongwei International Inspection Co., Ltd. EMC Laboratory has been accredited by A2LA for technical competence in the field of electrical testing, and proved to be in compliance with ISO/IEC 17025: 2005 General Requirements for the Competence of Testing and Calibration Laboratories and any additional program requirements in the identified field of testing.

FCC-Registration No.: 762235

Shenzhen Huatongwei International Inspection Co., Ltd. EMC Laboratory has been registered and fully described in a report filed with the FCC (Federal Communications Commission). The acceptance letter from the FCC is maintained in our files.

IC-Registration No.:5377B-1

Two 3m Alternate Test Site of Shenzhen Huatongwei International Inspection Co., Ltd. has been registered by Certification and Engineering Bureau of Industry Canada for the performance of radiated measurements with Registration No.: 5377B-1.

ACA

Shenzhen Huatongwei International Inspection Co., Ltd. EMC Laboratory can also perform testing for the Australian C-Tick mark as a result of our A2LA accreditation.

4.3. Environmental conditions

During the measurement the environmental conditions were within the listed ranges:

| | |
|--------------------|-------------|
| Temperature: | 15~35°C |
| Relative Humidity: | 30~60 % |
| Air Pressure: | 950~1050mba |

4.4. Statement of the measurement uncertainty

The data and results referenced in this document are true and accurate. The reader is cautioned that there may be errors in calibration limits of the equipment and facilities. The measurement uncertainty was calculated for all measurements listed in this test report according to TR-100028-01 "Electromagnetic compatibility and Radio spectrum Matters (ERM); Uncertainties in the measurement of mobile radio equipment characteristics; Part 1" and TR-100028-02 "Electromagnetic compatibility and Radio spectrum Matters (ERM); Uncertainties in the measurement of mobile radio equipment characteristics; Part 2" and is documented in the Shenzhen Huatongwei International Inspection Co., Ltd. quality system according to ISO/IEC 17025. Furthermore, component and process variability of devices similar to that tested may result in additional deviation. The manufacturer has the sole responsibility of continued compliance of the device.

Here after the best measurement capability for Shenzhen Huatongwei International Inspection Co., Ltd. is reported:

| Test Items | Measurement Uncertainty | Notes |
|---|-------------------------|-------|
| Transmitter power conducted | 0.57 dB | (1) |
| Transmitter power Radiated | 2.20 dB | (1) |
| Conducted spurious emissions 9kHz~40GHz | 1.60 dB | (1) |
| Radiated spurious emissions 9kHz~40GHz | 2.20 dB | (1) |
| Conducted Emissions 9kHz~30MHz | 3.39 dB | (1) |
| Radiated Emissions 30~1000MHz | 4.24 dB | (1) |
| Radiated Emissions 1~18GHz | 5.16 dB | (1) |
| Radiated Emissions 18~40GHz | 5.54 dB | (1) |

(1) This uncertainty represents an expanded uncertainty expressed at approximately the 95% confidence level using a coverage factor of $k=1.96$.

4.5. Equipments Used during the Test

| Conducted Emissions | | | | | |
|---------------------|-------------------|---------------|-------------|------------|------------|
| Item | Test Equipment | Manufacturer | Model No. | Serial No. | Last Cal. |
| 1 | Artificial Mains | Rohde&Schwarz | ESH2-Z5 | 100028 | 2016/11/13 |
| 2 | EMI Test Receiver | Rohde&Schwarz | ESCI3 | 100038 | 2016/11/13 |
| 3 | Pulse Limiter | Rohde&Schwarz | ESHSZ2 | 100044 | 2016/11/13 |
| 4 | EMI Test Software | Rohde&Schwarz | ES-K1 V1.71 | - | - |

| Radiated Emissions | | | | | |
|--------------------|-------------------------|------------------------------|--------------------|------------|------------|
| Item | Test Equipment | Manufacturer | Model No. | Serial No. | Last Cal. |
| 1 | EMI test receiver | Rohde&Schwarz | ESI 26 | 100009 | 2016/11/13 |
| 2 | Loop Antenna | Rohde&Schwarz | HFH2-Z2 | 100020 | 2016/11/13 |
| 3 | Ultra-Broadband Antenna | ShwarzBeck | VULB9163 | 538 | 2016/11/13 |
| 4 | Horn antenna | ShwarzBeck | 9120D | 1011 | 2016/11/13 |
| 5 | Horn Antenna | SCHWARZBECK | BBHA9170 | 25841 | 2016/11/13 |
| 6 | Amplifier | Sonoma | 310N | E009-13 | 2016/11/13 |
| 7 | JS Amplifier | Rohde&Schwarz | JS4-00101800-28-5A | F201504 | 2016/11/13 |
| 8 | Amplifier | Compliance Direction systems | PAP1-4060 | 120 | 2016/11/13 |
| 9 | High pass filter | Compliance Direction systems | BSU-6 | 34202 | 2016/11/13 |
| 10 | EMI test Software | Rohde&Schwarz | ESK1 | - | - |
| 11 | EMI test Software | Audix | E3 | - | - |
| 12 | TURNTABLE | MATURO | TT2.0 | - | - |
| 13 | ANTENNA MAST | MATURO | TAM-4.0-P | - | - |

| RF Conducted methods | | | | | |
|----------------------|---------------------|----------------------|-----------|--------------|------------|
| Item | Test Equipment | Manufacturer | Model No. | Serial No. | Last Cal. |
| 1 | Spectrum Analyzer | Rohde&Schwarz | FSP | 1164.4391.40 | 2016/11/13 |
| 2 | MXA Signal Analyzer | Agilent Technologies | N9020A | MY5050187 | 2016/11/13 |

The Cal.Interval was one year.

5. TEST CONDITIONS AND RESULTS

5.1. Antenna requirement

REQUIREMENT:

FCC CFR Title 47 Part 15 Subpart C Section 15.203:

An intentional radiator shall be designed to ensure that no antenna other than that furnished by the responsible party shall be used with the device. The use of a permanently attached antenna or of an antenna that uses a unique coupling to the intentional radiator, the manufacturer may design the unit so that a broken antenna can be replaced by the user, but the use of a standard antenna jack or electrical connector is prohibited.

FCC CFR Title 47 Part 15 Subpart C Section 15.247(c) (1)(i):

(i) Systems operating in the 2400~2483.5 MHz band that is used exclusively for fixed. Point-to-point operations may employ transmitting antennas with directional gain greater than 6 dBi provided the maximum conducted output power of the intentional radiator is reduced by 1 dB for every 3 dB that the directional gain of the antenna exceeds 6 dBi.

TEST RESULTS

Passed **Not Applicable**

The directional gain of the antenna less than 6 dBi, please refer to the below antenna photo.



5.2. Conducted Emissions (AC Main)

LIMIT

FCC CFR Title 47 Part 15 Subpart C Section 15.207:

| Frequency range (MHz) | Limit (dBuV) | |
|-----------------------|--------------|-----------|
| | Quasi-peak | Average |
| 0.15-0.5 | 66 to 56* | 56 to 46* |
| 0.5-5 | 56 | 46 |
| 5-30 | 60 | 50 |

* Decreases with the logarithm of the frequency.

TEST CONFIGURATION

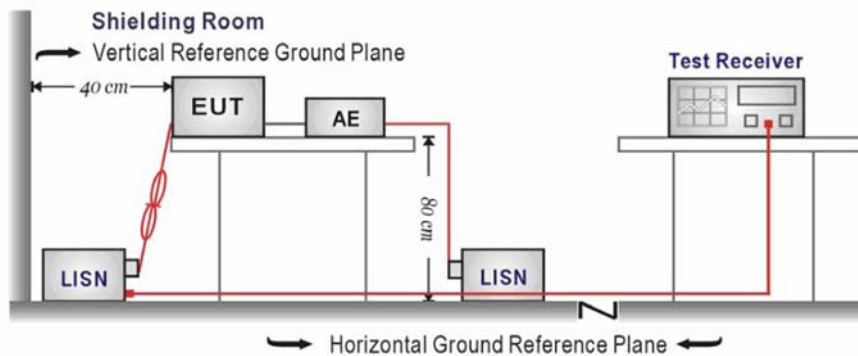

TEST PROCEDURE

1. The EUT was setup according to ANSI C63.10:2013 requirements.
2. The EUT was placed on a platform of nominal size, 1 m by 1.5 m, raised 80 cm above the conducting ground plane. The vertical conducting plane was located 40 cm to the rear of the EUT. All other surfaces of EUT were at least 80 cm from any other grounded conducting surface.
3. The EUT and simulators are connected to the main power through a line impedances stabilization network (LISN). The LISN provides a 50 ohm /50uH coupling impedance for the measuring equipment.
4. The peripheral devices are also connected to the main power through a LISN. (Please refer to the block diagram of the test setup and photographs)
5. Each current-carrying conductor of the EUT power cord, except the ground (safety) conductor, was individually connected through a LISN to the input power source.
6. The excess length of the power cord between the EUT and the LISN receptacle were folded back and forth at the center of the lead to form a bundle not exceeding 40 cm in length.
7. Conducted Emissions were investigated over the frequency range from 0.15MHz to 30MHz using a receiver bandwidth of 9 kHz.
8. During the above scans, the emissions were maximized by cable manipulation.

TEST MODE:

Please refer to the clause 3.3

TEST RESULTS

Passed Not Applicable

Note:

- 1) Transd=Cable lose+ Pulse Limiter Factor + Artificial Mains Factor
- 2) Margin= Limit -Level

Test Line: L

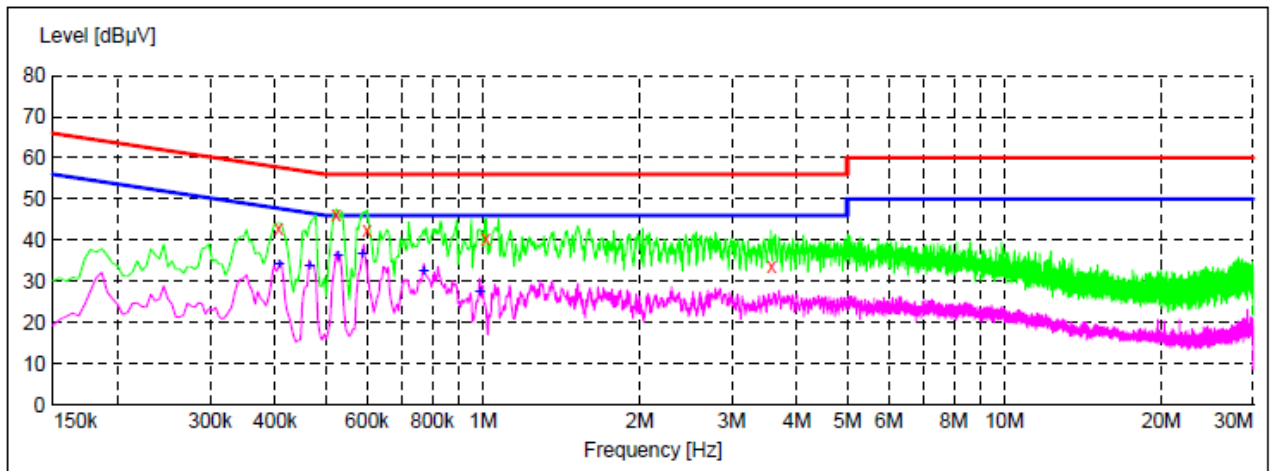

x x x MES GM1709255096_fin

MEASUREMENT RESULT: "GM1709255096_fin"

9/25/2017 10:27PM

| Frequency MHz | Level dBµV | Transd dB | Limit dBµV | Margin dB | Detector | Line | PE |
|------------------|---------------|--------------|---------------|--------------|----------|------|-----|
| 0.406500 | 42.90 | 10.2 | 58 | 14.8 | QP | L1 | GND |
| 0.523500 | 46.20 | 10.2 | 56 | 9.8 | QP | L1 | GND |
| 0.600000 | 42.40 | 10.2 | 56 | 13.6 | QP | L1 | GND |
| 1.014000 | 40.30 | 10.2 | 56 | 15.7 | QP | L1 | GND |
| 3.579000 | 33.50 | 10.3 | 56 | 22.5 | QP | L1 | GND |

MEASUREMENT RESULT: "GM1709255096_fin2"

9/25/2017 10:27PM

| Frequency MHz | Level dBµV | Transd dB | Limit dBµV | Margin dB | Detector | Line | PE |
|------------------|---------------|--------------|---------------|--------------|----------|------|-----|
| 0.406500 | 34.20 | 10.2 | 48 | 13.5 | AV | L1 | GND |
| 0.465000 | 33.80 | 10.2 | 47 | 12.8 | AV | L1 | GND |
| 0.528000 | 36.10 | 10.2 | 46 | 9.9 | AV | L1 | GND |
| 0.586500 | 36.70 | 10.2 | 46 | 9.3 | AV | L1 | GND |
| 0.771000 | 32.50 | 10.2 | 46 | 13.5 | AV | L1 | GND |
| 0.987000 | 27.30 | 10.2 | 46 | 18.7 | AV | L1 | GND |

Test Line:

N

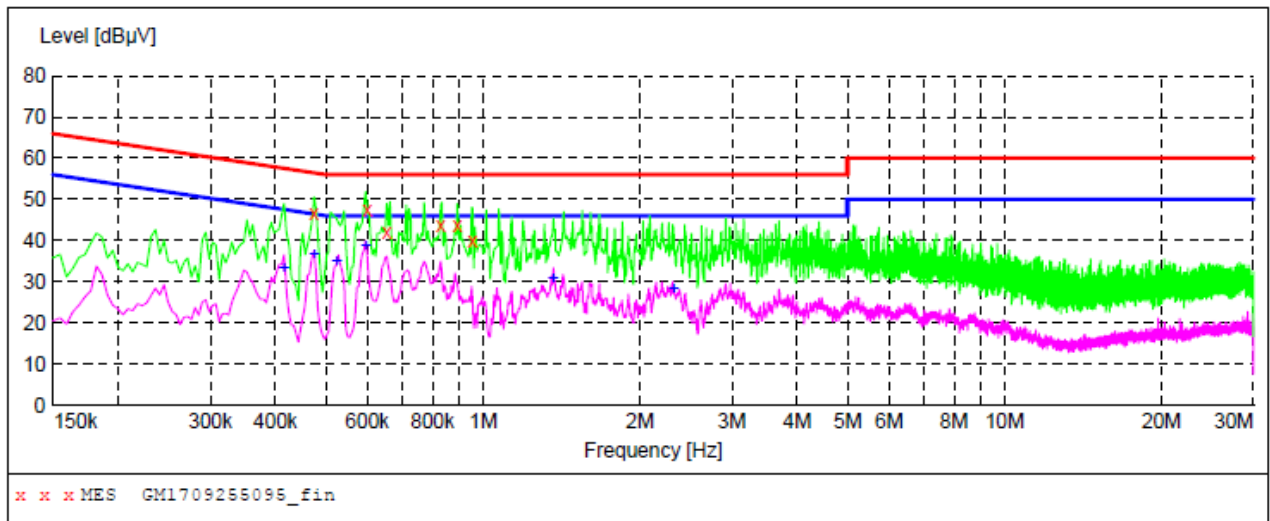

MEASUREMENT RESULT: "GM1709255095_fin"

9/25/2017 10:24PM

| Frequency MHz | Level dBµV | Transd dB | Limit dBµV | Margin dB | Detector | Line | PE |
|------------------|---------------|--------------|---------------|--------------|----------|------|-----|
| 0.474000 | 46.70 | 10.2 | 56 | 9.7 | QP | N | GND |
| 0.600000 | 47.30 | 10.2 | 56 | 8.7 | QP | N | GND |
| 0.654000 | 41.90 | 10.2 | 56 | 14.1 | QP | N | GND |
| 0.829500 | 43.90 | 10.2 | 56 | 12.1 | QP | N | GND |
| 0.892500 | 43.70 | 10.1 | 56 | 12.3 | QP | N | GND |
| 0.955500 | 39.80 | 10.2 | 56 | 16.2 | QP | N | GND |

MEASUREMENT RESULT: "GM1709255095_fin2"

9/25/2017 10:24PM

| Frequency MHz | Level dBµV | Transd dB | Limit dBµV | Margin dB | Detector | Line | PE |
|------------------|---------------|--------------|---------------|--------------|----------|------|-----|
| 0.415500 | 33.10 | 10.2 | 48 | 14.4 | AV | N | GND |
| 0.474000 | 36.70 | 10.2 | 46 | 9.7 | AV | N | GND |
| 0.523500 | 35.10 | 10.2 | 46 | 10.9 | AV | N | GND |
| 0.595500 | 38.50 | 10.2 | 46 | 7.5 | AV | N | GND |
| 1.360500 | 30.90 | 10.2 | 46 | 15.1 | AV | N | GND |
| 2.319000 | 28.40 | 10.2 | 46 | 17.6 | AV | N | GND |

5.3. Conducted Peak Output Power

LIMIT

FCC CFR Title 47 Part 15 Subpart C Section 15.247 (b)(3): **30dBm**:

TEST CONFIGURATION

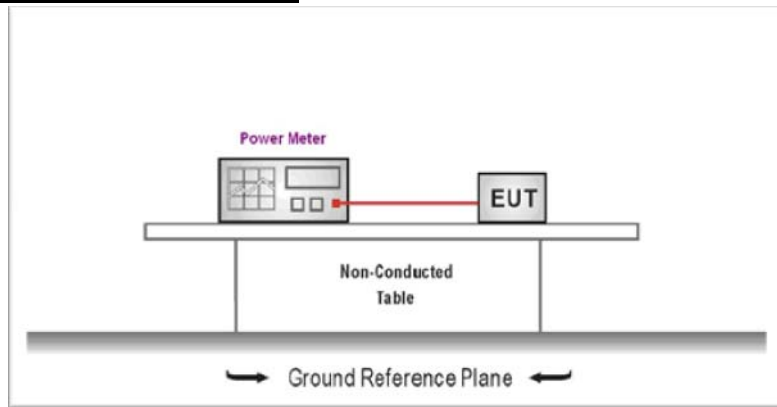

TEST PROCEDURE

1. The EUT was tested according to ANSI C63.10: 2013 and KDB 558074 D01 for compliance to FCC 47 CFR 15.247 requirements.
2. The maximum peak conducted output power may be measured using a broadband peak RF power meter.
3. The power meter shall have a video bandwidth that is greater than or equal to the DTS bandwidth and shall utilize a fast-responding diode detector
4. Record the measurement data.

TEST MODE:

Please refer to the clause 3.3

TEST RESULTS

Passed Not Applicable

| Type | Channel | Output power (dBm) | Limit (dBm) | Result |
|---------------|---------|--------------------|-------------|--------|
| 802.11b | 01 | 13.29 | ≤30.00 | Pass |
| | 06 | 13.29 | | |
| | 11 | 13.29 | | |
| 802.11g | 01 | 12.43 | ≤30.00 | Pass |
| | 06 | 12.43 | | |
| | 11 | 12.43 | | |
| 802.11n(HT20) | 01 | 11.5 | ≤30.00 | Pass |
| | 06 | 10.83 | | |
| | 11 | 11.55 | | |
| 802.11n(HT40) | 03 | 10.64 | ≤30.00 | Pass |
| | 06 | 11.7 | | |
| | 09 | 12.25 | | |

5.4. Power Spectral Density

LIMIT

FCC CFR Title 47 Part 15 Subpart C Section 15.247 (e):For digitally modulated systems, the power spectral density conducted from the intentional radiator to the antenna shall not be greater than 8 dBm in any 3 kHz band during any time interval of continuous transmission.

TEST CONFIGURATION

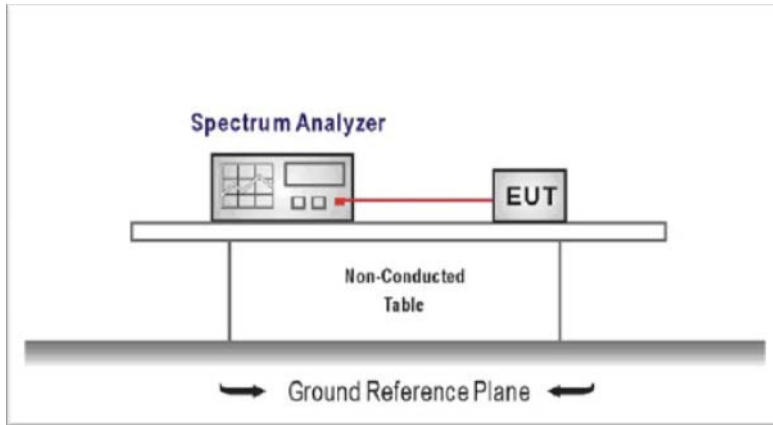

TEST PROCEDURE

1. Connect the antenna port(s) to the spectrum analyzer input,
2. Configure the spectrum analyzer as shown below:
Center frequency=DTS channel center frequency
Span =1.5 times the DTS bandwidth
RBW = 3 kHz ≤ RBW ≤ 100 kHz, VBW ≥ 3 × RBW
Sweep time = auto couple
Detector = peak
Trace mode = max hold
3. Place the radio in continuous transmit mode, allow the trace to stabilize, view the transmitter wave form on the spectrum analyzer.
4. Use the peak marker function to determine the maximum amplitude level within the RBW.
5. If measured value exceeds limit, reduce RBW (no less than 3 kHz) and repeat.

TEST MODE:



Please refer to the clause 3.3



TEST RESULTS

Passed Not Applicable

| Type | Channel | Power Spectral Density (dBm/RBW) | Limit (dBm/RBW) | Result |
|---------------|---------|----------------------------------|-----------------|--------|
| 802.11b | 01 | -3.200 | ≤8.00 | Pass |
| | 06 | 1.418 | | |
| | 11 | -1.160 | | |
| 802.11g | 01 | -10.907 | ≤8.00 | Pass |
| | 06 | -10.776 | | |
| | 11 | -10.155 | | |
| 802.11n(HT20) | 01 | -11.805 | ≤8.00 | Pass |
| | 06 | -12.698 | | |
| | 11 | -11.753 | | |
| 802.11n(HT40) | 03 | -15.667 | ≤8.00 | Pass |
| | 06 | -14.759 | | |
| | 09 | -14.185 | | |

Test plot as follows:

| Type: | | 802.11 b | |
|-------|--|--|--|
| CH01 | |  | <p>Frequency</p> <p>Auto Tune</p> <p>Center Freq 2.41200000 GHz</p> <p>Start Freq 2.404500000 GHz</p> <p>Stop Freq 2.419500000 GHz</p> <p>CF Step 1.500000 MHz Auto Man</p> <p>Freq Offset 0 Hz</p> |
| CH06 | |  | <p>Frequency</p> <p>Auto Tune</p> <p>Center Freq 2.437000000 GHz</p> <p>Start Freq 2.429500000 GHz</p> <p>Stop Freq 2.444500000 GHz</p> <p>CF Step 1.500000 MHz Auto Man</p> <p>Freq Offset 0 Hz</p> |
| CH11 | |  | <p>Frequency</p> <p>Auto Tune</p> <p>Center Freq 2.462000000 GHz</p> <p>Start Freq 2.454500000 GHz</p> <p>Stop Freq 2.469500000 GHz</p> <p>CF Step 1.500000 MHz Auto Man</p> <p>Freq Offset 0 Hz</p> |

| Type: | | 802.11 g | |
|-------|--|---|---|
| CH01 |  | Agilent Spectrum Analyzer - Swept SA Center Freq 2.41200000 GHz Ref Offset 1 dB Ref 7.00 dBm Mkr1 2.412 622 GHz -10.907 dBm Span 25.00 MHz #Res BW 30 kHz #VBW 100 kHz Sweep 26.67 ms (8001 pts) | Frequency Auto Tune Center Freq 2.41200000 GHz Start Freq 2.399500000 GHz Stop Freq 2.424500000 GHz CF Step 2.500000 MHz Auto Man Freq Offset 0 Hz |
| CH06 |  | Agilent Spectrum Analyzer - Swept SA Center Freq 2.43700000 GHz Ref Offset 1 dB Ref 7.00 dBm Mkr1 2.433 247 GHz -10.776 dBm Span 25.00 MHz #Res BW 30 kHz #VBW 100 kHz Sweep 26.67 ms (8001 pts) | Frequency Auto Tune Center Freq 2.43700000 GHz Start Freq 2.424500000 GHz Stop Freq 2.449500000 GHz CF Step 2.500000 MHz Auto Man Freq Offset 0 Hz |
| CH11 |  | Agilent Spectrum Analyzer - Swept SA Center Freq 2.46200000 GHz Ref Offset 1 dB Ref 7.00 dBm Mkr1 2.454 494 GHz -10.155 dBm Span 25.00 MHz #Res BW 30 kHz #VBW 100 kHz Sweep 26.67 ms (8001 pts) | Frequency Auto Tune Center Freq 2.46200000 GHz Start Freq 2.449500000 GHz Stop Freq 2.474500000 GHz CF Step 2.500000 MHz Auto Man Freq Offset 0 Hz |

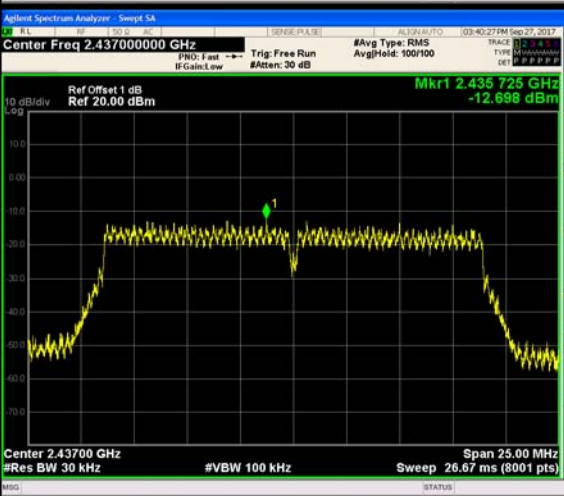
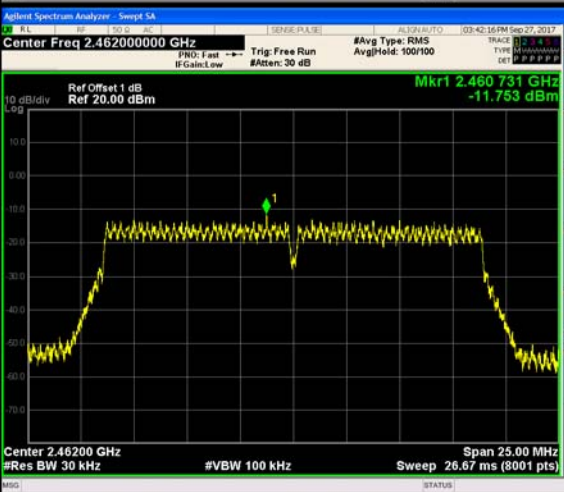
| Type: | | 802.11n(HT20) | |
|-------|--|--|---|
| CH01 | |  | <p>Frequency</p> <p>Auto Tune</p> <p>Center Freq 2.41200000 GHz</p> <p>Start Freq 2.39950000 GHz</p> <p>Stop Freq 2.42450000 GHz</p> <p>CF Step Auto 2.500000 MHz Man</p> <p>Freq Offset 0 Hz</p> |
| CH06 | |  | <p>Frequency</p> <p>Auto Tune</p> <p>Center Freq 2.43700000 GHz</p> <p>Start Freq 2.42450000 GHz</p> <p>Stop Freq 2.44950000 GHz</p> <p>CF Step Auto 2.500000 MHz Man</p> <p>Freq Offset 0 Hz</p> |
| CH11 | |  | <p>Frequency</p> <p>Auto Tune</p> <p>Center Freq 2.46200000 GHz</p> <p>Start Freq 2.44950000 GHz</p> <p>Stop Freq 2.47450000 GHz</p> <p>CF Step Auto 2.500000 MHz Man</p> <p>Freq Offset 0 Hz</p> |

| Type: | | 802.11n(HT40) | |
|-------|--|--|--|
| CH03 | | <p>Agilent Spectrum Analyzer - Swept SA Center Freq 2.42200000 GHz Ref Offset 1 dB Ref 7.00 dBm Mkr1 2.417 002 GHz -15.667 dBm Span 55.00 MHz #Res BW 30 kHz #VBW 100 kHz Sweep 58.13 ms (8001 pts)</p> | <p>Frequency</p> <p>Auto Tune</p> <p>Center Freq 2.42200000 GHz</p> <p>Start Freq 2.394500000 GHz</p> <p>Stop Freq 2.449500000 GHz</p> <p>CF Step 5.500000 MHz Auto Man</p> <p>Freq Offset 0 Hz</p> |
| CH06 | | <p>Agilent Spectrum Analyzer - Swept SA Center Freq 2.43700000 GHz Ref Offset 1 dB Ref 7.00 dBm Mkr1 2.425 732 GHz -14.759 dBm Span 55.00 MHz #Res BW 30 kHz #VBW 100 kHz Sweep 58.13 ms (8001 pts)</p> | <p>Frequency</p> <p>Auto Tune</p> <p>Center Freq 2.437000000 GHz</p> <p>Start Freq 2.409500000 GHz</p> <p>Stop Freq 2.464500000 GHz</p> <p>CF Step 5.500000 MHz Auto Man</p> <p>Freq Offset 0 Hz</p> |
| CH09 | | <p>Agilent Spectrum Analyzer - Swept SA Center Freq 2.45200000 GHz Ref Offset 1 dB Ref 7.00 dBm Mkr1 2.440 725 GHz -14.185 dBm Span 55.00 MHz #Res BW 30 kHz #VBW 100 kHz Sweep 58.13 ms (8001 pts)</p> | <p>Frequency</p> <p>Auto Tune</p> <p>Center Freq 2.452000000 GHz</p> <p>Start Freq 2.424500000 GHz</p> <p>Stop Freq 2.479500000 GHz</p> <p>CF Step 5.500000 MHz Auto Man</p> <p>Freq Offset 0 Hz</p> |

5.5. 6dB bandwidth

LIMIT

FCC CFR Title 47 Part 15 Subpart C Section 15.247 (a)(2):For digital modulation systems, the minimum 6 dB bandwidth shall be at least 500 kHz.

TEST CONFIGURATION

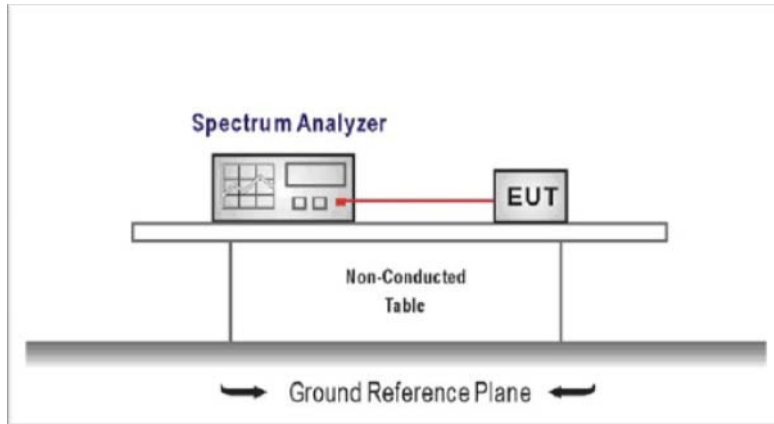

TEST PROCEDURE

1. Connect the antenna port(s) to the spectrum analyzer input.
2. Configure the spectrum analyzer as shown below (enter all losses between the transmitter output and the spectrum analyzer).
Center Frequency = DTS channel center frequency
Span = 2 x DTS bandwidth
RBW = 100 kHz, VBW \geq 3 x RBW
Sweep time = auto couple
Detector = Peak
Trace mode = max hold
3. Place the radio in continuous transmit mode, allow the trace to stabilize, view the transmitter wave form on the spectrum analyzer.
4. Measure the maximum width of the emission that is constrained by the frequencies associated with the two outermost amplitude points (upper and lower frequencies) that are attenuated by 6 dB relative to the maximum level measured in the fundamental emission, and record the pertinent measurements.

TEST MODE:

Please refer to the clause 3.3

TEST RESULTS

Passed Not Applicable

| Type | Channel | 6dB Bandwidth (MHz) | Limit (kHz) | Result |
|---------------|---------|---------------------|-------------|--------|
| 802.11b | 01 | 10.05 | ≥500 | Pass |
| | 06 | 9.736 | | |
| | 11 | 8.977 | | |
| 802.11g | 01 | 16.35 | ≥500 | Pass |
| | 06 | 16.43 | | |
| | 11 | 16.35 | | |
| 802.11n(HT20) | 01 | 17.56 | ≥500 | Pass |
| | 06 | 17.45 | | |
| | 11 | 17.78 | | |
| 802.11n(HT40) | 03 | 28.58 | ≥500 | Pass |
| | 06 | 25.67 | | |
| | 09 | 35.66 | | |

Test plot as follows:

| Type: | | 802.11 b |
|-------|--|----------|
| CH01 | <p>Agilent Spectrum Analyzer - Occupied BW</p> <p>Center Freq: 2.412000000 GHz</p> <p>Occupied Bandwidth: 13.708 MHz</p> <p>Total Power: 14.9 dBm</p> <p>Transmit Freq Error: -86.869 kHz</p> <p>x dB Bandwidth: 10.05 MHz</p> <p>OBW Power: 99.00 %</p> <p>x dB: -6.00 dB</p> | |
| CH06 | <p>Agilent Spectrum Analyzer - Occupied BW</p> <p>Center Freq: 2.437000000 GHz</p> <p>Occupied Bandwidth: 13.473 MHz</p> <p>Total Power: 15.1 dBm</p> <p>Transmit Freq Error: -226.05 kHz</p> <p>x dB Bandwidth: 9.736 MHz</p> <p>OBW Power: 99.00 %</p> <p>x dB: -6.00 dB</p> | |
| CH11 | <p>Agilent Spectrum Analyzer - Occupied BW</p> <p>Center Freq: 2.462000000 GHz</p> <p>Occupied Bandwidth: 13.144 MHz</p> <p>Total Power: 16.5 dBm</p> <p>Transmit Freq Error: -18.181 kHz</p> <p>x dB Bandwidth: 8.977 MHz</p> <p>OBW Power: 99.00 %</p> <p>x dB: -6.00 dB</p> | |

| Type: | | 802.11 g |
|-------|--|----------|
| CH01 | <p>Agilent Spectrum Analyzer - Occupied BW</p> <p>Center Freq 2.412000000 GHz</p> <p>Ref Offset 1 dB Ref 20.50 dBm</p> <p>Center 2.412 GHz #Res BW 100 kHz</p> <p>Occupied Bandwidth 16.382 MHz</p> <p>Total Power 10.6 dBm</p> <p>Transmit Freq Error -287 Hz</p> <p>x dB Bandwidth 16.35 MHz</p> <p>OBW Power 99.00 %</p> <p>x dB -6.00 dB</p> | |
| CH06 | <p>Agilent Spectrum Analyzer - Occupied BW</p> <p>Center Freq 2.437000000 GHz</p> <p>Ref Offset 1 dB Ref 20.50 dBm</p> <p>Center 2.437 GHz #Res BW 100 kHz</p> <p>Occupied Bandwidth 16.430 MHz</p> <p>Total Power 9.18 dBm</p> <p>Transmit Freq Error -26.195 kHz</p> <p>x dB Bandwidth 16.43 MHz</p> <p>OBW Power 99.00 %</p> <p>x dB -6.00 dB</p> | |
| CH11 | <p>Agilent Spectrum Analyzer - Occupied BW</p> <p>Center Freq 2.462000000 GHz</p> <p>Ref Offset 1 dB Ref 20.50 dBm</p> <p>Center 2.462 GHz #Res BW 100 kHz</p> <p>Occupied Bandwidth 16.485 MHz</p> <p>Total Power 10.1 dBm</p> <p>Transmit Freq Error -22.175 kHz</p> <p>x dB Bandwidth 16.35 MHz</p> <p>OBW Power 99.00 %</p> <p>x dB -6.00 dB</p> | |

| Type: | | 802.11n(HT20) | |
|-------|--|--|---|
| CH01 | | <p>Agilent Spectrum Analyzer - Occupied BW</p> <p>Center Freq 2.412000000 GHz</p> <p>Ref Offset 1 dB Ref 20.50 dBm</p> <p>Center 2.412 GHz #Res BW 100 kHz</p> <p>Occupied Bandwidth 17.620 MHz</p> <p>Total Power 7.71 dBm</p> <p>Transmit Freq Error -12.066 kHz</p> <p>x dB Bandwidth 17.56 MHz</p> <p>OBW Power 99.00 %</p> <p>x dB -6.00 dB</p> | <p>Frequency</p> <p>Center Freq 2.412000000 GHz</p> <p>CF Step 4.000000 MHz</p> <p>Freq Offset 0 Hz</p> |
| CH06 | | <p>Agilent Spectrum Analyzer - Occupied BW</p> <p>Center Freq 2.437000000 GHz</p> <p>Ref Offset 1 dB Ref 20.50 dBm</p> <p>Center 2.437 GHz #Res BW 100 kHz</p> <p>Occupied Bandwidth 17.652 MHz</p> <p>Total Power 7.03 dBm</p> <p>Transmit Freq Error -25.300 kHz</p> <p>x dB Bandwidth 17.45 MHz</p> <p>OBW Power 99.00 %</p> <p>x dB -6.00 dB</p> | <p>Frequency</p> <p>Center Freq 2.437000000 GHz</p> <p>CF Step 4.000000 MHz</p> <p>Freq Offset 0 Hz</p> |
| CH11 | | <p>Agilent Spectrum Analyzer - Occupied BW</p> <p>Center Freq 2.462000000 GHz</p> <p>Ref Offset 1 dB Ref 20.50 dBm</p> <p>Center 2.462 GHz #Res BW 100 kHz</p> <p>Occupied Bandwidth 17.688 MHz</p> <p>Total Power 7.71 dBm</p> <p>Transmit Freq Error -2.193 kHz</p> <p>x dB Bandwidth 17.78 MHz</p> <p>OBW Power 99.00 %</p> <p>x dB -6.00 dB</p> | <p>Frequency</p> <p>Center Freq 2.462000000 GHz</p> <p>CF Step 4.000000 MHz</p> <p>Freq Offset 0 Hz</p> |

| Type: | | 802.11n(HT40) | |
|-------|--|--|---|
| CH03 | | <p>Agilent Spectrum Analyzer - Occupied BW</p> <p>Center Freq 2.422000000 GHz</p> <p>Center Freq: 2.422000000 GHz</p> <p>Trig: Free Run Avg/Hold: 10/10</p> <p>Radio Std: None</p> <p>Radio Device: BTS</p> <p>Ref Offset 1 dB Ref 20.50 dBm</p> <p>Mkr1 2.422 GHz -21.742 dBm</p> <p>Center 2.422 GHz</p> <p>#Res BW 100 kHz #VBW 300 kHz Span 80 MHz Sweep 8 ms</p> <p>Occupied Bandwidth 36.046 MHz</p> <p>Total Power 6.95 dBm</p> <p>Transmit Freq Error -53.558 kHz</p> <p>OBW Power 99.00 %</p> <p>x dB Bandwidth 28.58 MHz x dB -6.00 dB</p> | <p>Frequency</p> <p>Center Freq 2.422000000 GHz</p> <p>CF Step 8.000000 MHz</p> <p>Freq Offset 0 Hz</p> |
| CH06 | | <p>Agilent Spectrum Analyzer - Occupied BW</p> <p>Center Freq 2.437000000 GHz</p> <p>Center Freq: 2.437000000 GHz</p> <p>Trig: Free Run Avg/Hold: 10/10</p> <p>Radio Std: None</p> <p>Radio Device: BTS</p> <p>Ref Offset 1 dB Ref 20.50 dBm</p> <p>Mkr1 2.437 GHz -25.308 dBm</p> <p>Center 2.437 GHz</p> <p>#Res BW 100 kHz #VBW 300 kHz Span 80 MHz Sweep 8 ms</p> <p>Occupied Bandwidth 36.013 MHz</p> <p>Total Power 8.05 dBm</p> <p>Transmit Freq Error -114.23 kHz</p> <p>OBW Power 99.00 %</p> <p>x dB Bandwidth 25.67 MHz x dB -6.00 dB</p> | <p>Frequency</p> <p>Center Freq 2.437000000 GHz</p> <p>CF Step 8.000000 MHz</p> <p>Freq Offset 0 Hz</p> |
| CH09 | | <p>Agilent Spectrum Analyzer - Occupied BW</p> <p>Center Freq 2.452000000 GHz</p> <p>Center Freq: 2.452000000 GHz</p> <p>Trig: Free Run Avg/Hold: 10/10</p> <p>Radio Std: None</p> <p>Radio Device: BTS</p> <p>Ref Offset 1 dB Ref 20.50 dBm</p> <p>Center 2.452 GHz</p> <p>#Res BW 100 kHz #VBW 300 kHz Span 80 MHz Sweep 8 ms</p> <p>Occupied Bandwidth 36.101 MHz</p> <p>Total Power 8.65 dBm</p> <p>Transmit Freq Error -44.643 kHz</p> <p>OBW Power 99.00 %</p> <p>x dB Bandwidth 35.66 MHz x dB -6.00 dB</p> | <p>Frequency</p> <p>Center Freq 2.452000000 GHz</p> <p>CF Step 8.000000 MHz</p> <p>Freq Offset 0 Hz</p> |

5.6. Restricted band

LIMIT

FCC CFR Title 47 Part 15 Subpart C Section 15.247 (d): In any 100 kHz bandwidth outside the frequency band in which the spread spectrum or digitally modulated intentional radiator is operating, Radiated Emissions which fall in the restricted bands, as defined in §15.205(a), must also comply with the Radiated Emissions limits specified in §15.209(a) (see §15.205(c)).

TEST CONFIGURATION

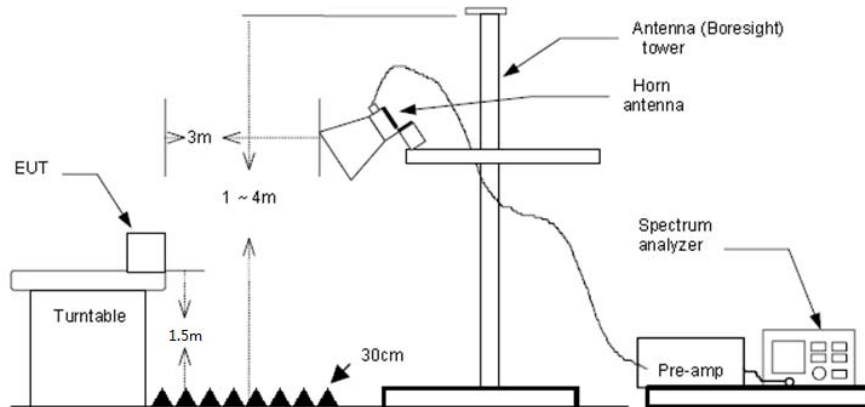

TEST PROCEDURE

- 1) The EUT was setup and tested according to ANSI C63.10:2013 for compliance to FCC 47CFR 15.247 requirements.
- 2) The EUT is placed on a turn table which is 1.5 meter above ground. The turn table is rotated 360 degrees to determine the position of the maximum emission level.
- 3) The EUT was positioned such that the distance from antenna to the EUT was 3 meters.
- 4) The antenna is scanned from 1 meter to 4 meters to find out the maximum emission level. This is repeated for both horizontal and vertical polarization of the antenna. In order to find the maximum emission, all of the interface cables were manipulated according to ANSI C63.10:2013 on radiated measurement.
- 5) The receiver set as follow:
 RBW=1MHz, VBW=3MHz PEAK detector for Peak value.
 RBW=1MHz, VBW=3MHz RMS detector for Average value.

TEST MODE:

Please refer to the clause 3.3

TEST RESULTS

Passed Not Applicable

Note:

- 1) Final level= Read level + Antenna Factor+ Cable Loss- Preamp Factor

| 802.11b | | | | | CH01 | | | | |
|-----------------|-------------------|-----------------------|-----------------|--------------------|----------------|---------------------|-----------------|--------------|------------|
| Frequency (MHz) | Read Level (dBuV) | Antenna Factor (dB/m) | Cable Loss (dB) | Preamp Factor (dB) | Level (dBuV/m) | Limit Line (dBuV/m) | Over Limit (dB) | Polarization | Test value |
| 2310.00 | 14.75 | 28.05 | 6.62 | 0.00 | 49.42 | 74.00 | -24.58 | Vertical | Peak |
| 2390.01 | 12.88 | 27.65 | 6.75 | 0.00 | 47.28 | 74.00 | -26.72 | Vertical | Peak |
| 2310.00 | 12.55 | 28.05 | 6.62 | 0.00 | 47.22 | 74.00 | -26.78 | Horizontal | Peak |
| 2390.01 | 12.46 | 27.65 | 6.75 | 0.00 | 46.86 | 74.00 | -27.14 | Horizontal | Peak |

| 802.11b | | | | | CH11 | | | | |
|-----------------|-------------------|-----------------------|-----------------|--------------------|----------------|---------------------|-----------------|--------------|------------|
| Frequency (MHz) | Read Level (dBuV) | Antenna Factor (dB/m) | Cable Loss (dB) | Preamp Factor (dB) | Level (dBuV/m) | Limit Line (dBuV/m) | Over Limit (dB) | Polarization | Test value |
| 2483.49 | 14.10 | 27.26 | 6.83 | 0.00 | 48.19 | 74.00 | -25.81 | Vertical | Peak |
| 2500.00 | 11.84 | 27.20 | 6.84 | 0.00 | 45.88 | 74.00 | -28.12 | Vertical | Peak |
| 2483.49 | 13.65 | 27.26 | 6.83 | 0.00 | 47.74 | 74.00 | -26.26 | Horizontal | Peak |
| 2500.00 | 15.25 | 27.20 | 6.84 | 0.00 | 49.29 | 74.00 | -24.71 | Horizontal | Peak |

| 802.11g | | | | | CH01 | | | | |
|-----------------|-------------------|-----------------------|-----------------|--------------------|----------------|---------------------|-----------------|--------------|------------|
| Frequency (MHz) | Read Level (dBuV) | Antenna Factor (dB/m) | Cable Loss (dB) | Preamp Factor (dB) | Level (dBuV/m) | Limit Line (dBuV/m) | Over Limit (dB) | Polarization | Test value |
| 2310.00 | 13.86 | 28.05 | 6.62 | 0.00 | 48.53 | 74.00 | -25.47 | Vertical | Peak |
| 2390.01 | 13.55 | 27.65 | 6.75 | 0.00 | 47.95 | 74.00 | -26.05 | Vertical | Peak |
| 2310.00 | 13.50 | 28.05 | 6.62 | 0.00 | 48.17 | 74.00 | -25.83 | Horizontal | Peak |
| 2390.01 | 12.96 | 27.65 | 6.75 | 0.00 | 47.36 | 74.00 | -26.64 | Horizontal | Peak |

| 802.11g | | | | | CH11 | | | | |
|-----------------|-------------------|-----------------------|-----------------|--------------------|----------------|---------------------|-----------------|--------------|------------|
| Frequency (MHz) | Read Level (dBuV) | Antenna Factor (dB/m) | Cable Loss (dB) | Preamp Factor (dB) | Level (dBuV/m) | Limit Line (dBuV/m) | Over Limit (dB) | Polarization | Test value |
| 2483.49 | 15.03 | 27.26 | 6.83 | 0.00 | 49.12 | 74.00 | -24.88 | Vertical | Peak |
| 2500.00 | 12.56 | 27.20 | 6.84 | 0.00 | 46.60 | 74.00 | -27.40 | Vertical | Peak |
| 2483.49 | 13.73 | 27.26 | 6.83 | 0.00 | 47.82 | 74.00 | -26.18 | Horizontal | Peak |
| 2500.00 | 13.43 | 27.20 | 6.84 | 0.00 | 47.47 | 74.00 | -26.53 | Horizontal | Peak |

| 802.11n(HT20) | | | | | CH01 | | | | |
|-----------------|-------------------|-----------------------|-----------------|--------------------|----------------|---------------------|-----------------|--------------|------------|
| Frequency (MHz) | Read Level (dBuV) | Antenna Factor (dB/m) | Cable Loss (dB) | Preamp Factor (dB) | Level (dBuV/m) | Limit Line (dBuV/m) | Over Limit (dB) | Polarization | Test value |
| 2310.00 | 13.86 | 28.05 | 6.62 | 0.00 | 48.53 | 74.00 | -25.47 | Vertical | Peak |
| 2390.01 | 13.55 | 27.65 | 6.75 | 0.00 | 47.95 | 74.00 | -26.05 | Vertical | Peak |
| 2310.00 | 13.50 | 28.05 | 6.62 | 0.00 | 48.17 | 74.00 | -25.83 | Horizontal | Peak |
| 2390.01 | 12.96 | 27.65 | 6.75 | 0.00 | 47.36 | 74.00 | -26.64 | Horizontal | Peak |

| 802.11n(HT20) | | | | | CH11 | | | | |
|-----------------|-------------------|-----------------------|-----------------|--------------------|----------------|---------------------|-----------------|--------------|------------|
| Frequency (MHz) | Read Level (dBuV) | Antenna Factor (dB/m) | Cable Loss (dB) | Preamp Factor (dB) | Level (dBuV/m) | Limit Line (dBuV/m) | Over Limit (dB) | Polarization | Test value |
| 2483.49 | 15.03 | 27.26 | 6.83 | 0.00 | 49.12 | 74.00 | -24.88 | Vertical | Peak |
| 2500.00 | 12.56 | 27.20 | 6.84 | 0.00 | 46.60 | 74.00 | -27.40 | Vertical | Peak |
| 2483.49 | 13.73 | 27.26 | 6.83 | 0.00 | 47.82 | 74.00 | -26.18 | Horizontal | Peak |
| 2500.00 | 13.43 | 27.20 | 6.84 | 0.00 | 47.47 | 74.00 | -26.53 | Horizontal | Peak |

| 802.11n(HT40) | | | | | CH03 | | | | |
|-----------------|-------------------|-----------------------|-----------------|--------------------|----------------|---------------------|-----------------|--------------|------------|
| Frequency (MHz) | Read Level (dBuV) | Antenna Factor (dB/m) | Cable Loss (dB) | Preamp Factor (dB) | Level (dBuV/m) | Limit Line (dBuV/m) | Over Limit (dB) | Polarization | Test value |
| 2310.00 | 13.34 | 28.05 | 6.62 | 0.00 | 48.01 | 74.00 | -25.99 | Vertical | Peak |
| 2389.99 | 15.25 | 27.65 | 6.75 | 0.00 | 49.65 | 74.00 | -24.35 | Vertical | Peak |
| 2310.00 | 13.76 | 28.05 | 6.62 | 0.00 | 48.43 | 74.00 | -25.57 | Horizontal | Peak |
| 2389.99 | 20.90 | 27.65 | 6.75 | 0.00 | 55.30 | 74.00 | -18.70 | Horizontal | Peak |

| 802.11n(HT40) | | | | | CH09 | | | | |
|-----------------|-------------------|-----------------------|-----------------|--------------------|----------------|---------------------|-----------------|--------------|------------|
| Frequency (MHz) | Read Level (dBuV) | Antenna Factor (dB/m) | Cable Loss (dB) | Preamp Factor (dB) | Level (dBuV/m) | Limit Line (dBuV/m) | Over Limit (dB) | Polarization | Test value |
| 2483.50 | 15.48 | 27.26 | 6.83 | 0.00 | 49.57 | 74.00 | -24.43 | Vertical | Peak |
| 2500.00 | 14.00 | 27.20 | 6.84 | 0.00 | 48.04 | 74.00 | -25.96 | Vertical | Peak |
| 2483.50 | 15.66 | 27.26 | 6.83 | 0.00 | 49.75 | 74.00 | -24.25 | Horizontal | Peak |
| 2500.00 | 13.49 | 27.20 | 6.84 | 0.00 | 47.53 | 74.00 | -26.47 | Horizontal | Peak |

802.11b-2412MHz Peak:

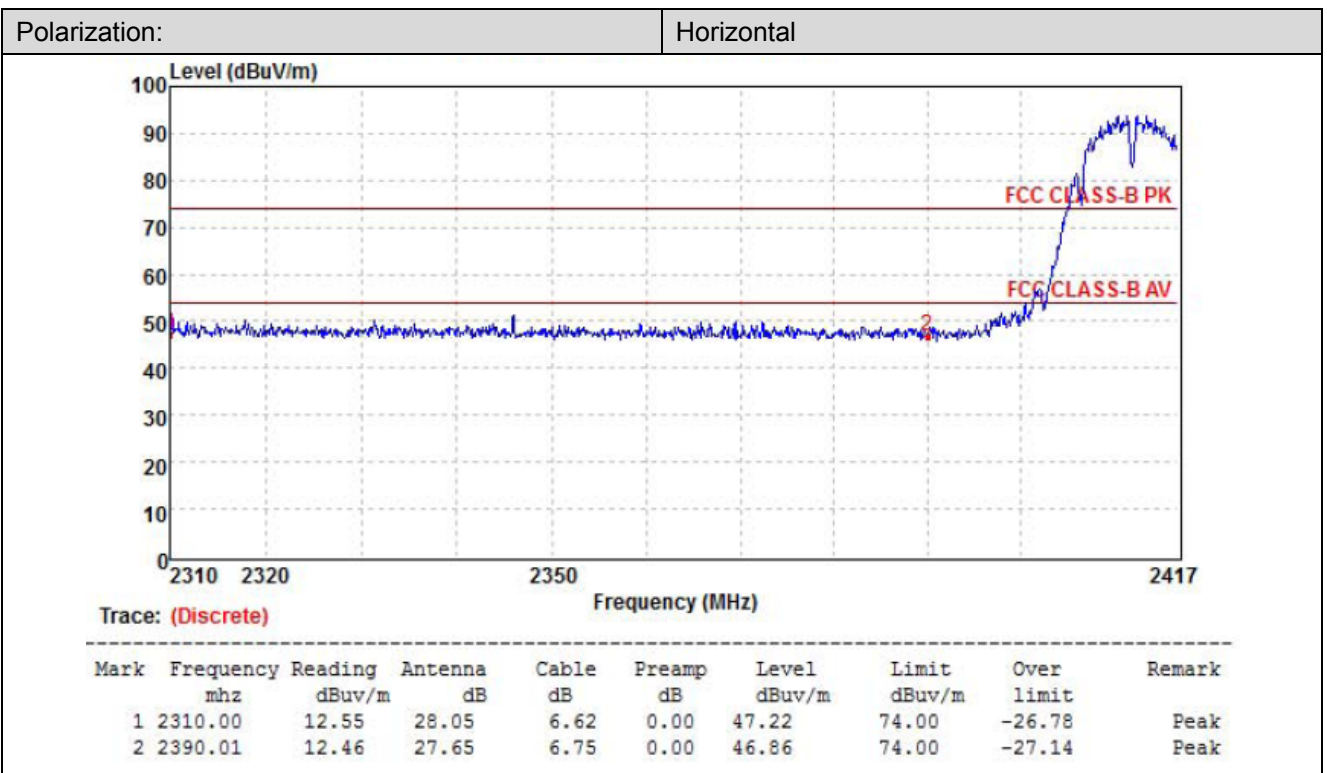
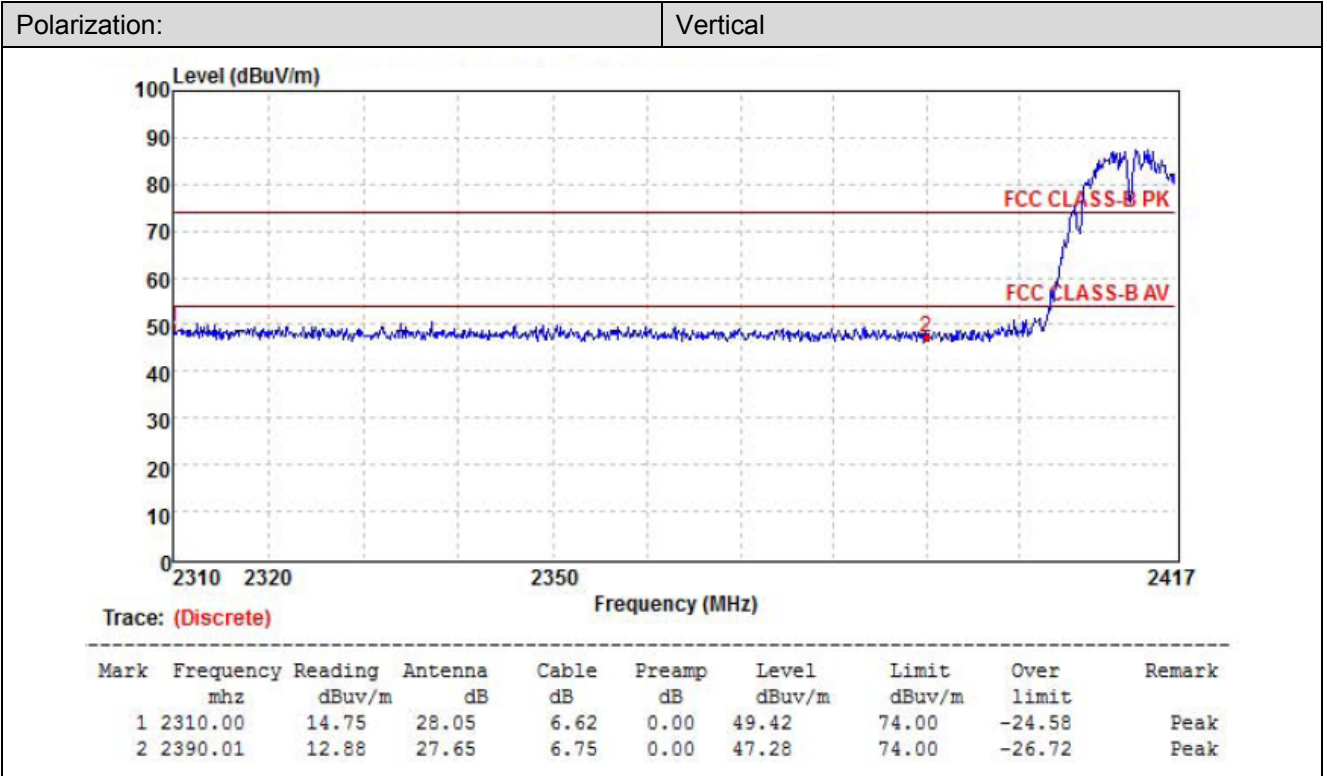

802.11b-2462MHz Peak:

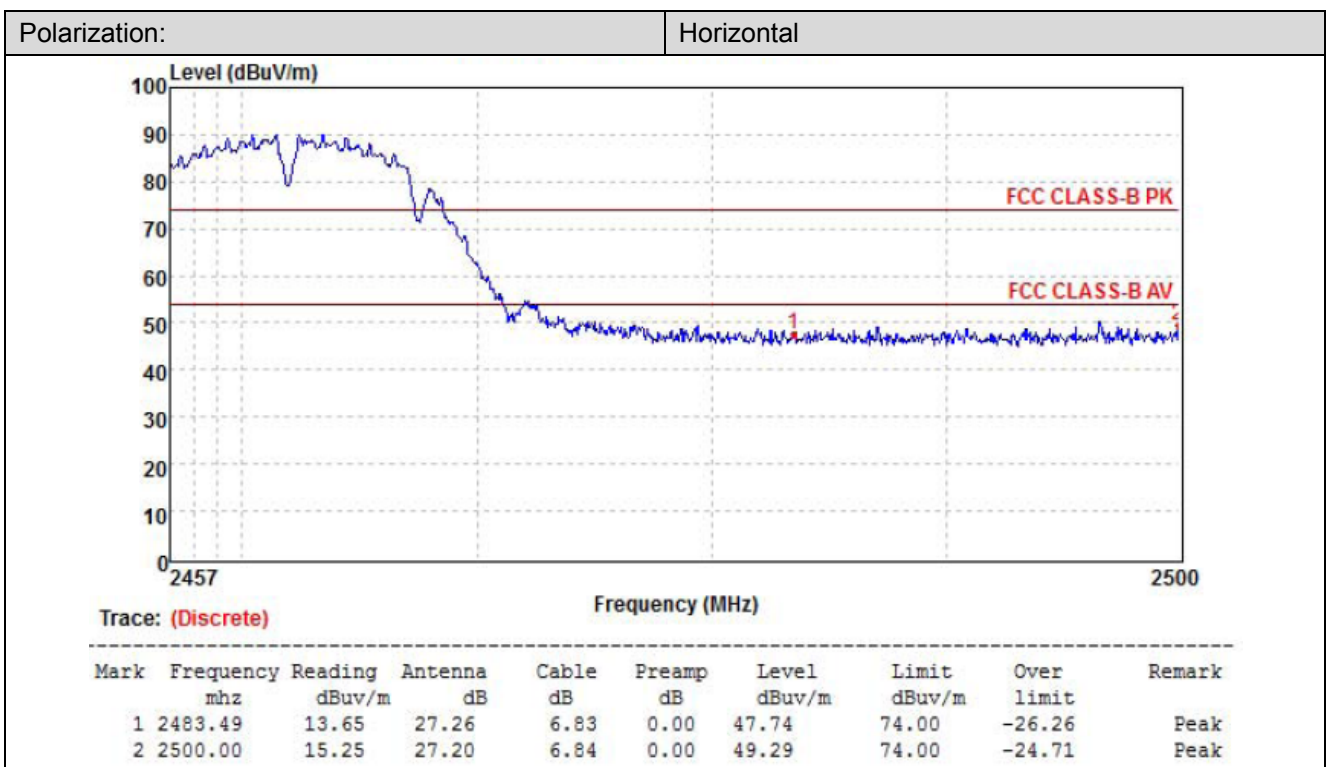
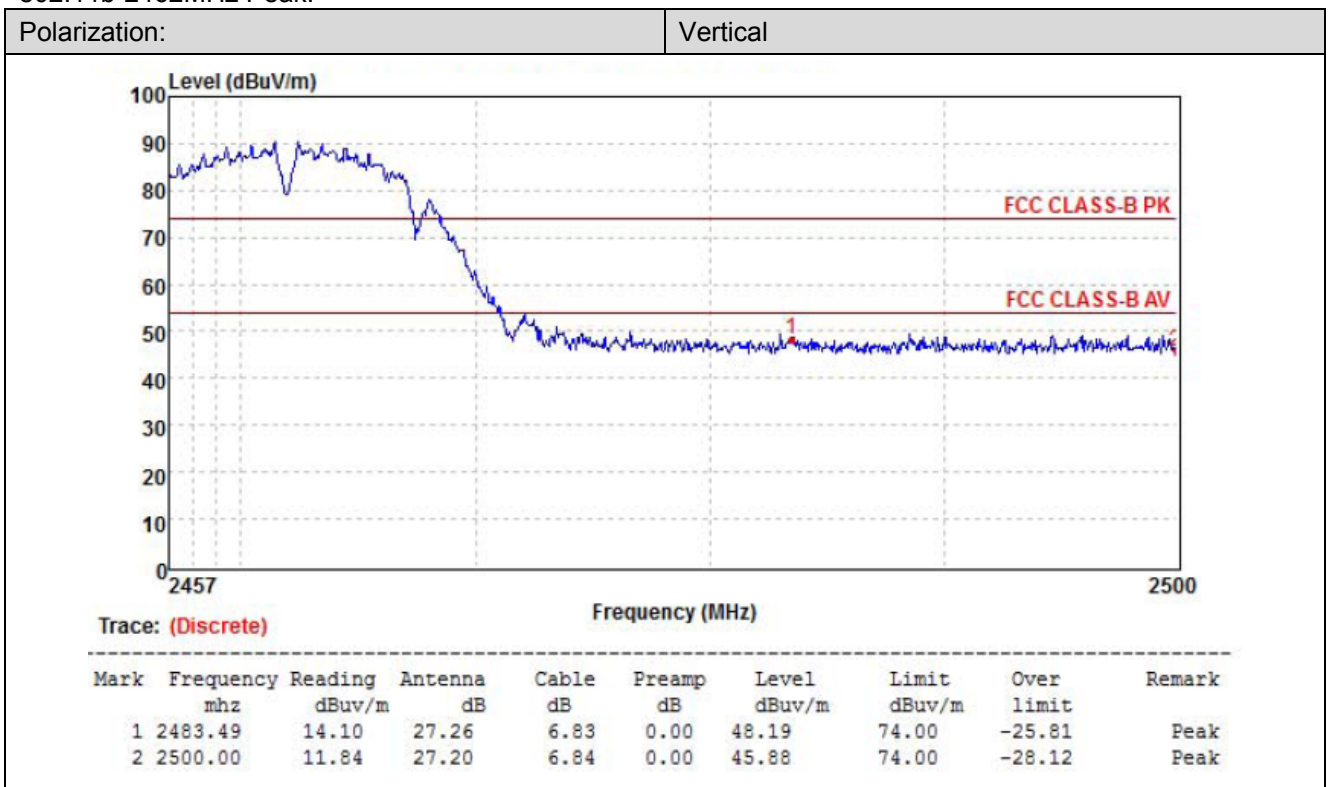

802.11g-2412MHz Peak:

