



# FCC REPORT

**Report Reference No.** ..... : **TRE1709017506** R/C.....: 49459

**FCC ID** ..... : **ZSW-30-048**

**Applicant's name** ..... : **b mobile HK Limited**

**Address** ..... : Flat 18; 14/F Block 1; Golden Industrial Building; 16-26 Kwai Tak Street; Kwai Chung; New Territories; Hong Kong.

**Manufacturer**..... : b mobile HK Limited

**Address**..... : Flat 18; 14/F Block 1; Golden Industrial Building; 16-26 Kwai Tak Street; Kwai Chung; New Territories; Hong Kong.

**Test item description** ..... : **Mobile Phone**

**Trade Mark**..... : Bmobile

**Model/Type reference** ..... : AX1015

**Listed Model(s)**..... : -

**Standard**..... : **47 CFR FCC Part 15 Subpart B - Unintentional Radiators**  
**ANSI C63.4: 2014**

**Date of receipt of test sample**..... : Sep.20, 2017

**Date of testing**..... : Sep.21, 2017 - Oct.10, 2017

**Date of issue**..... : Oct.11, 2017

**Result** ..... : **Pass**

Compiled by  
( position+printed name+signature) . : File administrators Candy Liu 

Supervised by  
( position+printed name+signature) . : Project Engineer : Edward Pan 

Approved by  
( position+printed name+signature) . : RF Manager Hans Hu 

**Testing Laboratory Name**..... : **Shenzhen Huatongwei International Inspection Co., Ltd.**

**Address** ..... : 1/F, Bldg 3, Hongfa Hi-tech Industrial Park, Genyu Road, Tianliao, Gongming, Shenzhen, China

**Shenzhen Huatongwei International Inspection Co., Ltd. All rights reserved.**

This publication may be reproduced in whole or in part for non-commercial purposes as long as the Shenzhen Huatongwei International Inspection Co., Ltd. is acknowledged as copyright owner and source of the material. Shenzhen Huatongwei International Inspection Co., Ltd. takes no responsibility for and will not assume liability for damages resulting from the reader's interpretation of the reproduced material due to its placement and context.

*The test report merely corresponds to the test sample.  
It is not permitted to copy extracts of these test result without the written permission of the test laboratory.*

## Contents

|           |   |           |
|-----------|---|-----------|
| <b>1.</b> | <b><u>TEST STANDARDS AND REPORT VERSION</u></b>       | <b>3</b>  |
| 1.1.      | Test Standards  | 3         |
| 1.2.      | Report version  | 3         |
| <b>2.</b> | <b><u>TEST DESCRIPTION</u></b>                        | <b>4</b>  |
| <b>3.</b> | <b><u>SUMMARY</u></b>                                 | <b>5</b>  |
| 3.1.      | Client Information                                    | 5         |
| 3.2.      | Product Description                                   | 5         |
| 3.3.      | EUT operation mode                                    | 6         |
| 3.4.      | EUT configuration                                     | 6         |
| 3.5.      | Configuration of Tested System                        | 7         |
| <b>4.</b> | <b><u>TEST ENVIRONMENT</u></b>                        | <b>8</b>  |
| 4.1.      | Address of the test laboratory                        | 8         |
| 4.2.      | Test Facility   | 8         |
| 4.3.      | Equipments Used during the Test                       | 9         |
| 4.4.      | Environmental conditions                              | 9         |
| 4.5.      | Statement of the measurement uncertainty              | 10        |
| <b>5.</b> | <b><u>TEST CONDITIONS AND RESULTS</u></b>             | <b>11</b> |
| 5.1.      | Conducted Emissions Test                              | 11        |
| 5.2.      | Radiated Emission Test                                | 14        |
| <b>6.</b> | <b><u>TEST SETUP PHOTOS OF THE EUT</u></b>            | <b>18</b> |
| <b>7.</b> | <b><u>EXTERNAL AND INTERNAL PHOTOS OF THE EUT</u></b> | <b>19</b> |

# **1. Test standards and Report version**

## **1.1. Test Standards**

The tests were performed according to following standards:

[47 CFR FCC Part 15 Subpart B](#) - Unintentional Radiators

[ANSI C63.4: 2014](#) – American National Standard for Methods of Measurement of Radio-Noise Emissions from Low-Voltage Electrical and Electronic Equipment in the Range of 9 kHz to 40GHz

## **1.2. Report version**

| Version No. | Date of issue | Description |
|-------------|---------------|-------------|
| 00          | Oct.11, 2017  | Original    |
|             |               |             |
|             |               |             |
|             |               |             |
|             |               |             |

## **2. Test Description**

| Test Item                | FCC Rule | Result |
|--------------------------|----------|--------|
| Conducted Emissions Test | 15.107   | Pass   |
| Radiated Emission Test   | 15.109   | Pass   |

Note: The measurement uncertainty is not included in the test result.

### **3. SUMMARY**

#### **3.1. Client Information**

|               |  |
|---------------|--|
| Applicant:    | b mobile HK Limited  |
| Address:      | Flat 18; 14/F Block 1; Golden Industrial Building;16-26 Kwai Tak Street; Kwai Chung; New Territories; Hong Kong. |
| Manufacturer: | b mobile HK Limited  |
| Address:      | Flat 18; 14/F Block 1; Golden Industrial Building;16-26 Kwai Tak Street; Kwai Chung; New Territories; Hong Kong. |

#### **3.2. Product Description**

|                      |   |
|----------------------|---|
| Name of EUT:         | Mobile Phone  |
| Trade Mark:          | Bmobile   |
| Model No.:           | AX1015  |
| Listed Model(s):     | -   |
| IMEI 1:              | 861638031655405   |
| IMEI 2:              | 861638031655413   |
| Power supply:        | DC 3.8V From exchange battery                               |
| Adapter information: | Input: 100-240Va.c., 50/60Hz, 0.2A<br>Output: 5Vd.c., 500mA |
| Hardware version:    | SPR_S3215_V4.0  |
| Software version:    | Bmobile_AX1015_TIGO_V004                                    |

### 3.3. EUT operation mode

| Test mode | Playing Video | Connect to PC (Down loading) | Camera | Adapter |
|-----------|---------------|------------------------------|--------|---------|
| 1         | ■             |                              |        | ■       |
| 2         |               | ■                            |        |         |
| 3         |               |                              | ■      | ■       |

Note:

1. ■ is operation mode.

Pre-scan above all test mode, found below test mode which it was worse case mode.

| Test item          | Test mode (Worse case mode) |
|--------------------|-----------------------------|
| Conducted emission | Mode 2                      |
| Radiated emission  | Mode 2                      |

### 3.4. EUT configuration

The following peripheral devices and interface cables were connected during the measurement:

- - supplied by the manufacturer
- - supplied by the lab

|  |                |   |
|--|----------------|---|
|  | Length (m) :   |   |
|  | Shield :       |   |
|  | Detachable :   |   |
|  | Manufacturer : |   |
|  | Model No. :    | - |

### 3.5. Configuration of Tested System

**Configuration of Tested System**

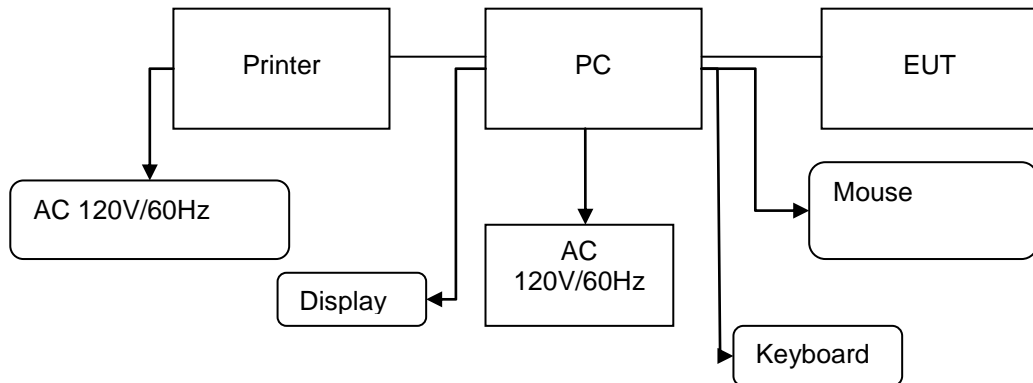

**Equipment Used in Tested System**

| No. | Equipment                 | Manufacturer  | Model No.      | Serial No.               | Length | shielded/unshielded | Notes |
|-----|---------------------------|---------------|----------------|--------------------------|--------|---------------------|-------|
| 1   | PC                        | DELL          | DIMENSION E520 | 1RNN42X                  | /      | /                   | DOC   |
| 2   | Printer                   | ESPOn         | C3990          | C3990A                   | /      | /                   | DOC   |
| 3   | Mouse                     | DELL          | MO56U OA       | G0E02SY7                 | 1.00m  | unshielded          | DOC   |
| 4   | Display                   | DELL          | 1707FPt        | CN-OFC237-71618-65G-AAKC | /      | /                   | DOC   |
| 5   | Keyboard                  | DELL          | L100           | CNRH65665890726009L      | /      | /                   | DOC   |
| 6   | USB Cable (EUT to PC)     | ITALCOM GROUP | USB 2.0        | N/A                      | 0.80m  | unshielded          | N/A   |
| 7   | USB Cable (Printer to PC) | Genshuo       | USB 2.0        | N/A                      | 1.20m  | unshielded          | N/A   |
| 8   | Power line                | /             | /              | N/A                      | 1.00m  | unshielded          | N/A   |

## **4. TEST ENVIRONMENT**

### **4.1. Address of the test laboratory**

Laboratory: Shenzhen Huatongwei International Inspection Co., Ltd.

Address: 1/F, Bldg 3, Hongfa Hi-tech Industrial Park, Genyu Road, Tianliao, Gongming, Shenzhen, China

Phone: 86-755-26748019 Fax: 86-755-26748089

### **4.2. Test Facility**

The test facility is recognized, certified, or accredited by the following organizations:

#### **CNAS-Lab Code: L1225**

Shenzhen Huatongwei International Inspection Co., Ltd. has been assessed and proved to be in compliance with CNAS-CL01 Accreditation Criteria for Testing and Calibration Laboratories (identical to ISO/IEC 17025: 2005 General Requirements) for the Competence of Testing and Calibration Laboratories.

#### **A2LA-Lab Cert. No.: 3902.01**

Shenzhen Huatongwei International Inspection Co., Ltd. EMC Laboratory has been accredited by A2LA for technical competence in the field of electrical testing, and proved to be in compliance with ISO/IEC 17025: 2005 General Requirements for the Competence of Testing and Calibration Laboratories and any additional program requirements in the identified field of testing.

#### **FCC-Registration No.: 762235**

Shenzhen Huatongwei International Inspection Co., Ltd. EMC Laboratory has been registered and fully described in a report filed with the FCC (Federal Communications Commission). The acceptance letter from the FCC is maintained in our files. Registration 762235

#### **IC-Registration No.: 5377B-1**

Two 3m Alternate Test Site of Shenzhen Huatongwei International Inspection Co., Ltd. has been registered by Certification and Engineering Bureau of Industry Canada for the performance of radiated measurements with Registration No. 5377B-1.

#### **ACA**

Shenzhen Huatongwei International Inspection Co., Ltd. EMC Laboratory can also perform testing for the Australian C-Tick mark as a result of our A2LA accreditation.



### 4.3. Equipments Used during the Test

| Conducted Emission |                   |                 |           |            |            |
|--------------------|-------------------|-----------------|-----------|------------|------------|
| Item               | Test Equipment    | Manufacturer    | Model No. | Serial No. | Last Cal.  |
| 1                  | EMI TEST RECEIVER | Rohde & Schwarz | ESCI      | 100106     | 2016/11/13 |
| 2                  | ARTIFICIAL MAINS  | Rohde & Schwarz | ESH2-Z5   | 100028     | 2016/11/13 |
| 3                  | PULSE LIMITER     | Rohde & Schwarz | ESHSZ2    | 100044     | 2016/11/13 |
| 4                  | EMI TEST SOFTWARE | Rohde & Schwarz | ES-K1     | N/A        | N/A        |

| Radiated Emission |                         |                 |                    |            |            |
|-------------------|-------------------------|-----------------|--------------------|------------|------------|
| Item              | Test Equipment          | Manufacturer    | Model No.          | Serial No. | Last Cal.  |
| 1                 | ULTRA-BROADBAND ANTENNA | ShwarzBeck      | VULB9163           | 538        | 2016/11/13 |
| 2                 | EMI TEST RECEIVER       | Rohde & Schwarz | ESI 26             | 100009     | 2016/11/13 |
| 3                 | EMI TEST Software       | Audix           | E3                 | N/A        | N/A        |
| 4                 | TURNTABLE               | MATURO          | TT2.0              | ----       | N/A        |
| 5                 | ANTENNA MAST            | MATURO          | TAM-4.0-P          | ----       | N/A        |
| 6                 | EMI TEST Software       | Rohde & Schwarz | ESK1               | N/A        | N/A        |
| 7                 | ULTRA-BROADBAND ANTENNA | Rohde&Schwarz   | HL562              | 100015     | 2016/11/13 |
| 8                 | Amplifer                | Sonoma          | 310N               | E009-13    | 2016/11/13 |
| 9                 | JS amplifer             | Rohde & Schwarz | JS4-00101800-28-5A | F201504    | 2016/11/13 |
| 11                | TURNTABLE               | ETS             | 2088               | 2149       | N/A        |
| 12                | ANTENNA MAST            | ETS             | 2075               | 2346       | N/A        |
| 13                | HORN ANTENNA            | Rohde&Schwarz   | HF906              | 100039     | 2016/11/13 |

The calibration interval was one year.

### 4.4. Environmental conditions

During the measurement the environmental conditions were within the listed ranges:

|                    |             |
|--------------------|-------------|
| Temperature:       | 15~35°C     |
| Relative Humidity: | 30~60 %     |
| Air Pressure:      | 950~1050mba |

#### 4.5. Statement of the measurement uncertainty

The data and results referenced in this document are true and accurate. The reader is cautioned that there may be errors within the calibration limits of the equipment and facilities. The measurement uncertainty was calculated for all measurements listed in this test report acc. to CISPR 16 - 4 „Specification for radio disturbance and immunity measuring apparatus and methods – Part 4: Uncertainty in EMC Measurements“ and is documented in the Shenzhen Huatongwei International Inspection Co., Ltd quality system acc. to DIN EN ISO/IEC 17025. Furthermore, component and process variability of devices similar to that tested may result in additional deviation. The manufacturer has the sole responsibility of continued compliance of the device.

Hereafter the best measurement capability for Shenzhen Huatongwei laboratory is reported:

| Test                  | Range      | Measurement Uncertainty | Notes |
|-----------------------|------------|-------------------------|-------|
| Radiated Emission     | 30~1000MHz | 4.24 dB                 | (1)   |
| Radiated Emission     | 1~18GHz    | 5.16 dB                 | (1)   |
| Radiated Emission     | 18-40GHz   | 5.54 dB                 | (1)   |
| Conducted Disturbance | 0.15~30MHz | 3.39 dB                 | (1)   |

(1) This uncertainty represents an expanded uncertainty expressed at approximately the 95% confidence level using a coverage factor of  $k=2$ .

## 5. TEST CONDITIONS AND RESULTS

### 5.1. Conducted Emissions Test

#### LIMIT

FCC CFR Title 47 Part 15 Subpart B Section 15.107:

| Frequency range (MHz) | Limit (dBuV) |           |
|-----------------------|--------------|-----------|
|                       | Quasi-peak   | Average   |
| 0.15-0.5              | 66 to 56*    | 56 to 46* |
| 0.5-5                 | 56           | 46        |
| 5-30                  | 60           | 50        |

\* Decreases with the logarithm of the frequency.

#### TEST CONFIGURATION

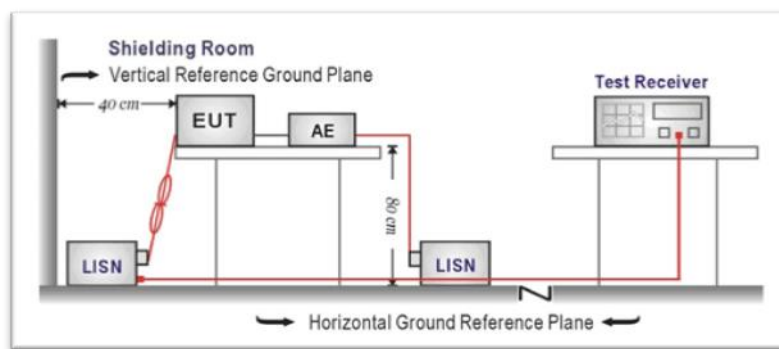

#### TEST PROCEDURE

1. The EUT was setup according to ANSI C63.4-2014.
2. The EUT was placed on a platform of nominal size, 1 m by 1.5 m, raised 80 cm above the conducting ground plane. The vertical conducting plane was located 40 cm to the rear of the EUT. All other surfaces of EUT were at least 80 cm from any other grounded conducting surface.
3. The EUT and simulators are connected to the main power through a line impedance stabilization network (LISN). The LISN provides a 50 ohm /50uH coupling impedance for the measuring equipment.
4. The peripheral devices are also connected to the main power through a LISN. (Please refer to the block diagram of the test setup and photographs)
5. Each current-carrying conductor of the EUT power cord, except the ground (safety) conductor, was individually connected through a LISN to the input power source.
6. The excess length of the power cord between the EUT and the LISN receptacle were folded back and forth at the center of the lead to form a bundle not exceeding 40 cm in length.
7. Conducted emissions were investigated over the frequency range from 0.15MHz to 30MHz using a receiver bandwidth of 9 kHz.
8. During the above scans, the emissions were maximized by cable manipulation.

#### TEST MODE:

Please refer to the clause 3.3

#### TEST RESULTS

**Passed**       **Not Applicable**

Note: Transd=Cable lose+ PULSE LIMITER factor+ ARTIFICIAL MAINS factor; Margin= Limit -Level

Test Line:

L

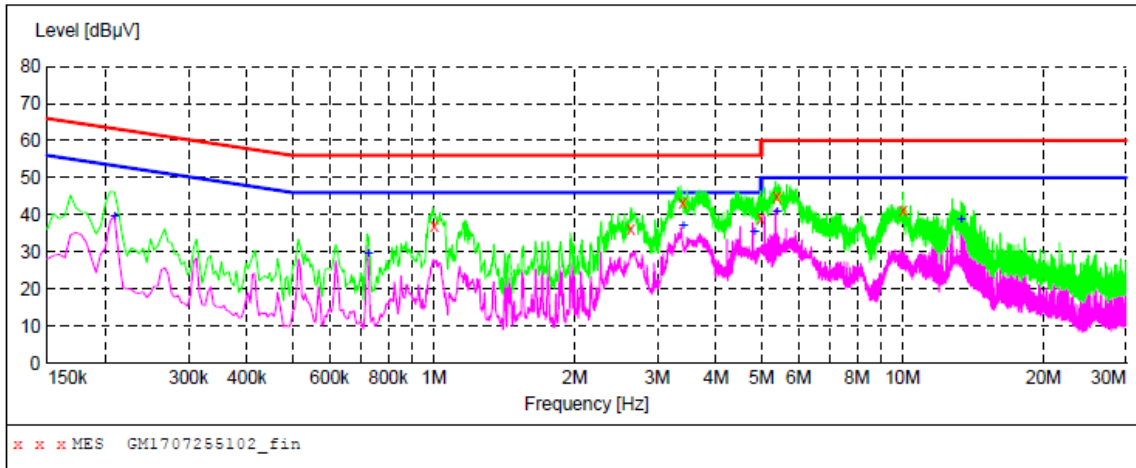

| Frequency<br>MHz | Level<br>dBµV | Transd<br>dB | Limit<br>dBµV | Margin<br>dB | Detector | Line | PE  |
|------------------|---------------|--------------|---------------|--------------|----------|------|-----|
| 1.005000         | 37.10         | 10.2         | 56            | 18.9         | QP       | L1   | GND |
| 2.638500         | 36.10         | 10.2         | 56            | 19.9         | QP       | L1   | GND |
| 3.408000         | 43.40         | 10.3         | 56            | 12.6         | QP       | L1   | GND |
| 4.996500         | 39.20         | 10.3         | 56            | 16.8         | QP       | L1   | GND |
| 5.397000         | 44.90         | 10.3         | 60            | 15.1         | QP       | L1   | GND |
| 10.045500        | 41.10         | 10.6         | 60            | 18.9         | QP       | L1   | GND |
| Frequency<br>MHz | Level<br>dBµV | Transd<br>dB | Limit<br>dBµV | Margin<br>dB | Detector | Line | PE  |
| 0.208500         | 39.40         | 10.3         | 53            | 13.9         | AV       | L1   | GND |
| 0.726000         | 29.40         | 10.2         | 46            | 16.6         | AV       | L1   | GND |
| 3.408000         | 37.00         | 10.3         | 46            | 9.0          | AV       | L1   | GND |
| 4.830000         | 35.50         | 10.3         | 46            | 10.5         | AV       | L1   | GND |
| 5.397000         | 40.80         | 10.3         | 50            | 9.2          | AV       | L1   | GND |
| 13.357500        | 38.50         | 10.5         | 50            | 11.5         | AV       | L1   | GND |

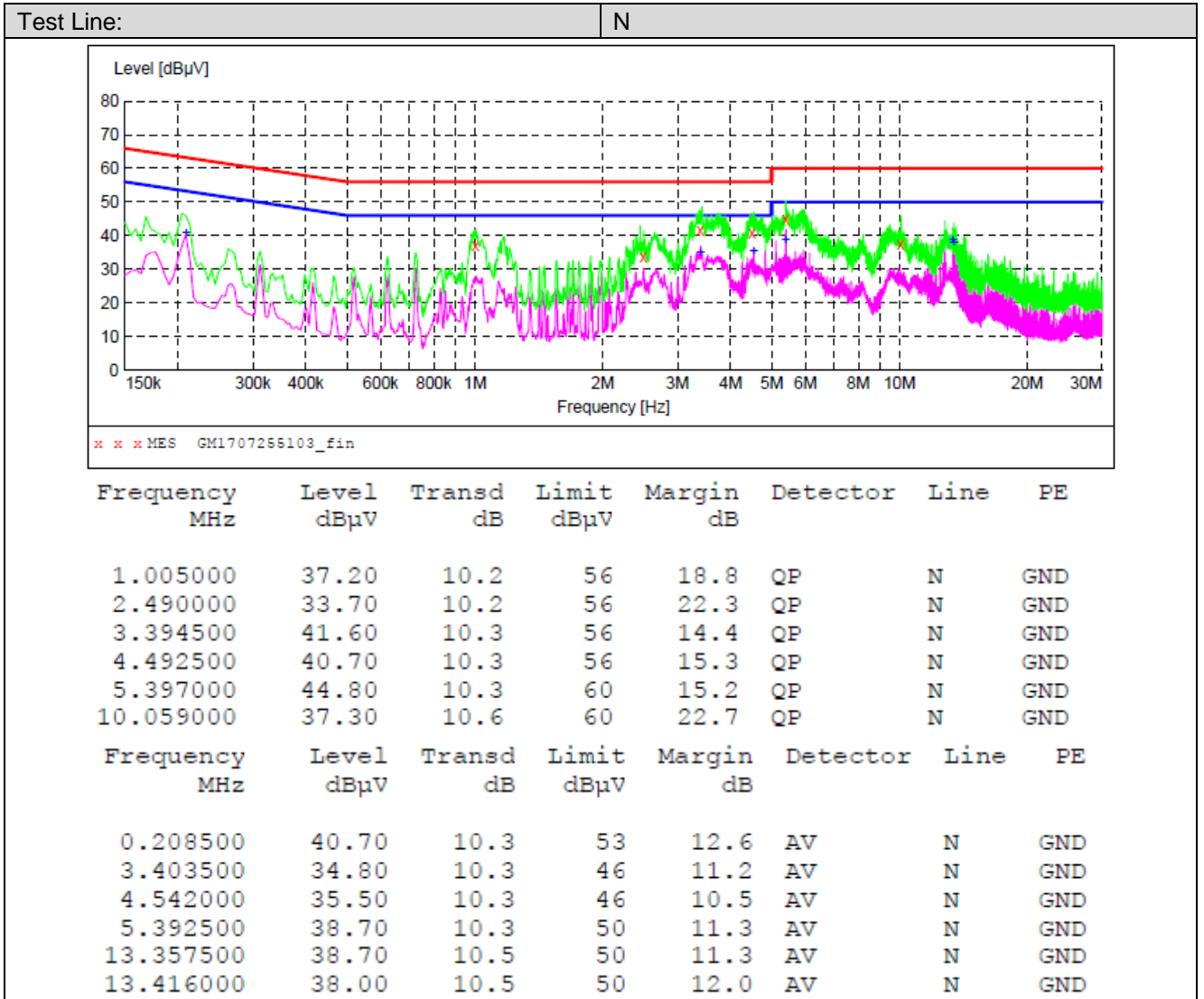

## 5.2. Radiated Emission Test

### LIMIT

#### FCC CFR Title 47 Part 15 Subpart B Section 15.109

| Frequency     | Limit (dBuV/m @3m) | Value      |
|---------------|--------------------|------------|
| 30MHz-88MHz   | 40.00              | Quasi-peak |
| 88MHz-216MHz  | 43.50              | Quasi-peak |
| 216MHz-960MHz | 46.00              | Quasi-peak |
| 960MHz-1GHz   | 54.00              | Quasi-peak |
| Above 1GHz    | 54.00              | Average    |
|               | 74.00              | Peak       |

### TEST CONFIGURATION

#### ➤ 30MHz ~ 1GHz

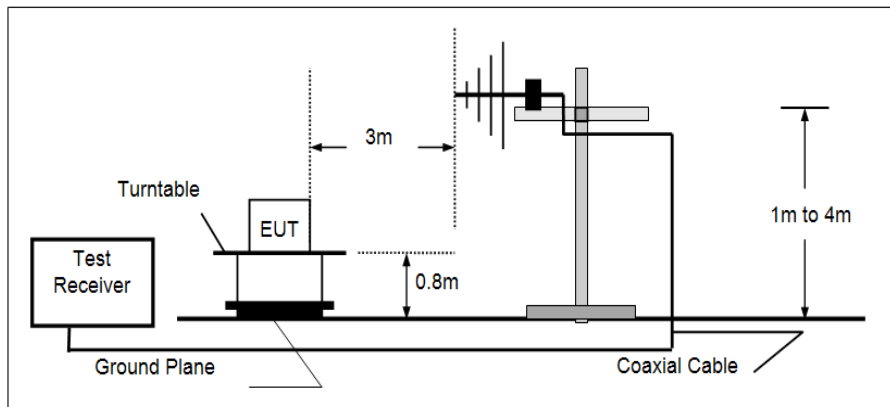

#### ➤ Above 1GHz

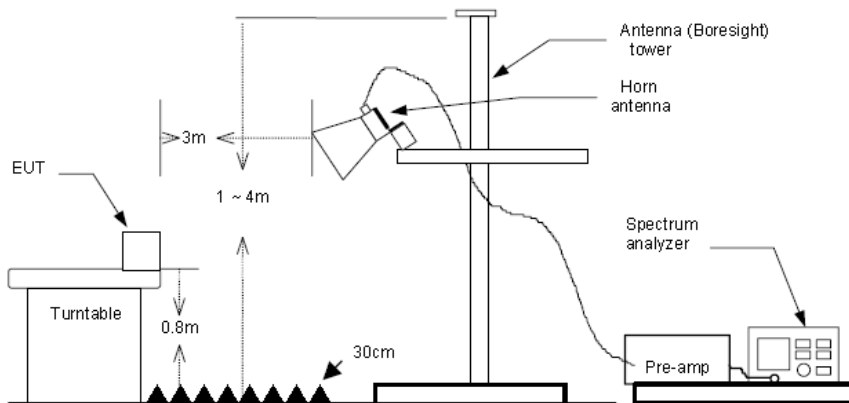

### TEST PROCEDURE

1. The EUT was tested according to ANSI C63.4:2014.
2. The EUT is placed on a turntable which is 0.8 meter above ground. The turn table is rotated 360 degrees to determine the position of the maximum emission level.
3. The EUT was positioned such that the distance from antenna to the EUT was 3 meters.
4. The antenna is scanned from 1 meter to 4 meters to find out the maximum emission level. This is repeated for both horizontal and vertical polarization of the antenna.
5. Use the following spectrum analyzer settings
  - (1) Span shall wide enough to fully capture the emission being measured;
  - (2) Below 1GHz, RBW=120KHz, VBW=300KHz, Sweep=auto, Detector function=peak, Trace=max hold; If the emission level of the EUT measured by the peak detector is 3 dB lower than the applicable limit, the peak emission level will be reported. Otherwise, the emission measurement will be repeated using

the quasi-peak detector and reported.  
(3) Above 1GHz, RBW=1MHz, VBW=3MHz

**TEST MODE:**

Please refer to the clause 3.3

**TEST RESULTS**

**Passed**       **Not Applicable**

Note: Final Level = Receiver Read level + Antenna Factor + Cable Loss - Preamplifier Factor

➤ Vertical

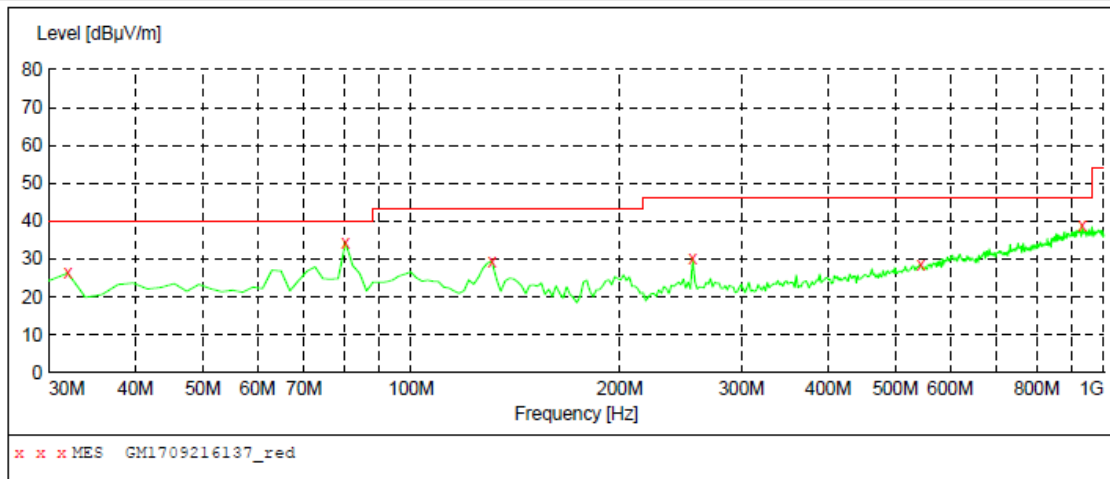

**MEASUREMENT RESULT: "GM1709216137\_red"**

9/21/2017 7:32PM

| Frequency<br>MHz | Level<br>dBuV/m | Transd<br>dB | Limit<br>dBuV/m | Margin<br>dB | Det. | Height<br>cm | Azimuth<br>deg | Polarization |
|------------------|-----------------|--------------|-----------------|--------------|------|--------------|----------------|--------------|
| 31.940000        | 26.30           | -13.2        | 40.0            | 13.7         | QP   | 100.0        | 39.00          | VERTICAL     |
| 80.440000        | 34.40           | -15.5        | 40.0            | 5.6          | QP   | 100.0        | 292.00         | VERTICAL     |
| 130.880000       | 29.40           | -13.4        | 43.5            | 14.1         | QP   | 100.0        | 171.00         | VERTICAL     |
| 255.040000       | 30.10           | -8.3         | 46.0            | 15.9         | QP   | 100.0        | 279.00         | VERTICAL     |
| 544.100000       | 28.50           | -0.9         | 46.0            | 17.5         | QP   | 100.0        | 267.00         | VERTICAL     |
| 930.160000       | 38.80           | 7.1          | 46.0            | 7.2          | QP   | 100.0        | 51.00          | VERTICAL     |

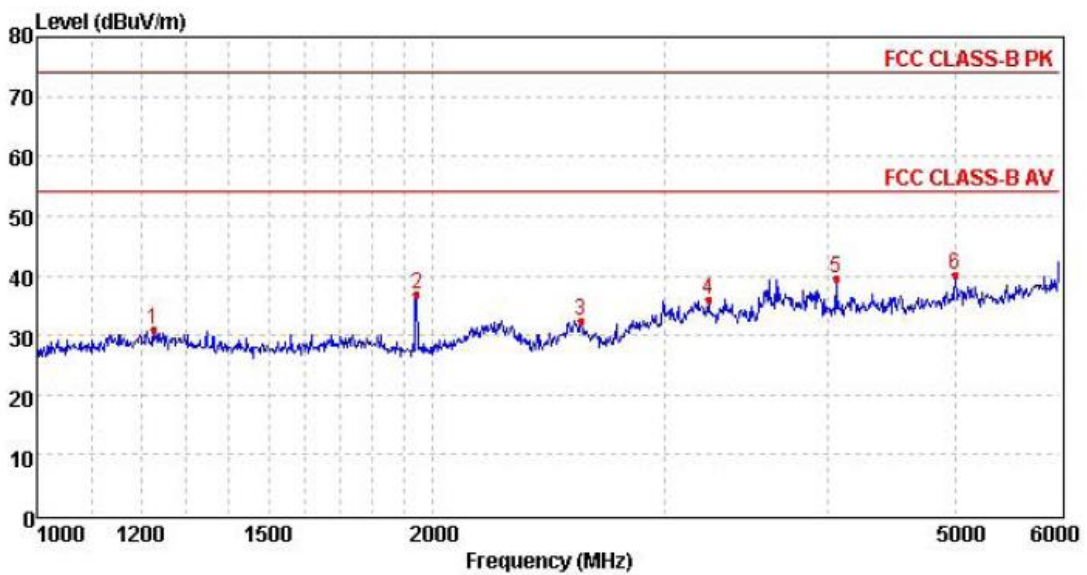

| Mark | Frequency<br>MHz | Reading<br>dBuV/m | Antenna<br>dB | Cable<br>dB | Preamp<br>dB | Level<br>dBuV/m | Limit<br>dBuV/m | Over<br>limit | Remark |
|------|------------------|-------------------|---------------|-------------|--------------|-----------------|-----------------|---------------|--------|
| 1    | 1226.62          | 36.58             | 26.27         | 4.71        | 36.56        | 31.00           | 74.00           | -43.00        | Peak   |
| 2    | 1943.99          | 42.28             | 25.75         | 6.18        | 37.26        | 36.95           | 74.00           | -37.05        | Peak   |
| 3    | 2594.04          | 35.67             | 27.76         | 6.91        | 37.84        | 32.50           | 74.00           | -41.50        | Peak   |
| 4    | 3239.42          | 37.97             | 28.56         | 7.77        | 38.27        | 36.03           | 74.00           | -37.97        | Peak   |
| 5    | 4052.62          | 38.90             | 29.81         | 8.82        | 37.99        | 39.54           | 74.00           | -34.46        | Peak   |
| 6    | 4988.86          | 35.32             | 31.49         | 9.66        | 36.43        | 40.04           | 74.00           | -33.96        | Peak   |



➤ Horizontal

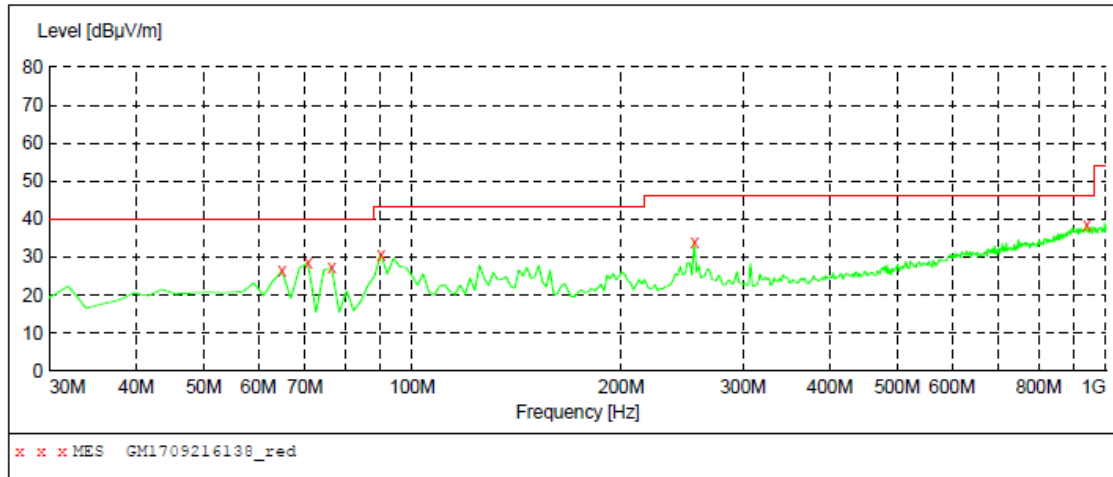

**MEASUREMENT RESULT: "GM1709216138\_red"**

9/21/2017 7:36PM

| Frequency<br>MHz | Level<br>dBuV/m | Transd<br>dB | Limit<br>dBuV/m | Margin<br>dB | Det. | Height<br>cm | Azimuth<br>deg | Polarization |
|------------------|-----------------|--------------|-----------------|--------------|------|--------------|----------------|--------------|
| 64.920000        | 26.30           | -11.4        | 40.0            | 13.7         | QP   | 300.0        | 202.00         | HORIZONTAL   |
| 70.740000        | 28.50           | -13.3        | 40.0            | 11.5         | QP   | 300.0        | 85.00          | HORIZONTAL   |
| 76.560000        | 27.10           | -15.3        | 40.0            | 12.9         | QP   | 300.0        | 228.00         | HORIZONTAL   |
| 90.140000        | 30.80           | -12.7        | 43.5            | 12.7         | QP   | 300.0        | 267.00         | HORIZONTAL   |
| 255.040000       | 34.10           | -8.3         | 46.0            | 11.9         | QP   | 100.0        | 285.00         | HORIZONTAL   |
| 937.920000       | 38.40           | 7.1          | 46.0            | 7.6          | QP   | 300.0        | 110.00         | HORIZONTAL   |

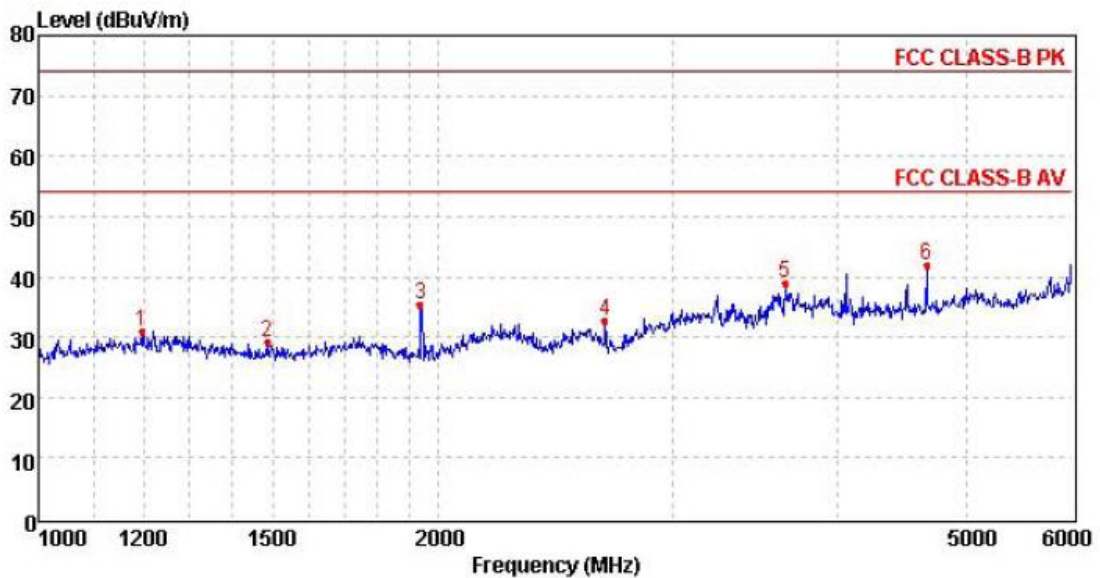

| Mark | Frequency<br>MHz | Reading<br>dBuV/m | Antenna<br>dB | Cable<br>dB | Preamp<br>dB | Level<br>dBuV/m | Limit<br>dBuV/m | Over<br>limit | Remark |
|------|------------------|-------------------|---------------|-------------|--------------|-----------------|-----------------|---------------|--------|
| 1    | 1196.23          | 36.70             | 26.27         | 4.65        | 36.57        | 31.05           | 74.00           | -42.95        | Peak   |
| 2    | 1485.84          | 34.70             | 25.81         | 5.24        | 36.57        | 29.18           | 74.00           | -44.82        | Peak   |
| 3    | 1940.51          | 40.68             | 25.71         | 6.18        | 37.25        | 35.32           | 74.00           | -38.68        | Peak   |
| 4    | 2669.48          | 35.73             | 28.01         | 7.07        | 38.02        | 32.79           | 74.00           | -41.21        | Peak   |
| 5    | 3646.07          | 39.74             | 29.30         | 8.32        | 38.26        | 39.10           | 74.00           | -34.90        | Peak   |
| 6    | 4660.49          | 38.63             | 31.08         | 9.48        | 37.15        | 42.04           | 74.00           | -31.96        | Peak   |

## 6. Test Setup Photos of the EUT

Conducted Emission Connect to PC



Radiated Emission (30MHz-1GHz) Connect to PC



Radiated Emission (above 1GHz) Connect to PC

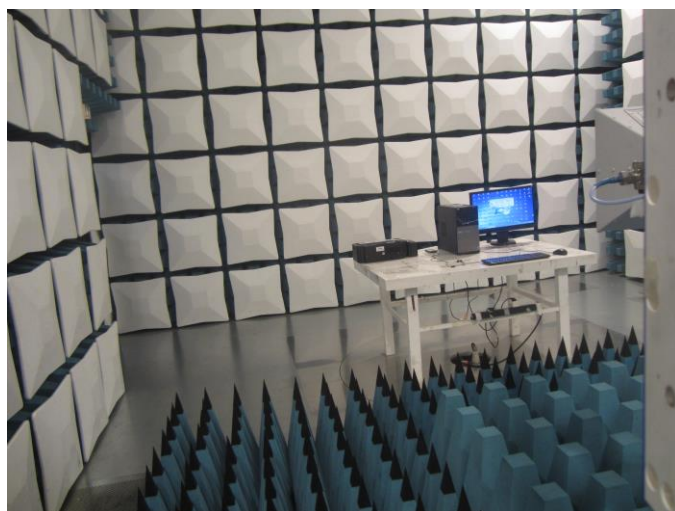



## **7. External and Internal photos of the EUT**

Reference to Test Report No.: TRE1709017501.

.....**End of Report**.....