



TEST REPORT

Report Reference No...... : **TRE1709017505** R/C.....: 49459

FCC ID..... : **ZSW-30-048**

Applicant's name..... : **b mobile HK Limited**

Address..... : Flat 18; 14/F Block 1; Golden Industrial Building;16-26 Kwai Tak Street; Kwai Chung; New Territories; Hong Kong.

Manufacturer..... : b mobile HK Limited

Address..... : Flat 18; 14/F Block 1; Golden Industrial Building;16-26 Kwai Tak Street; Kwai Chung; New Territories; Hong Kong.

Test item description : **Mobile Phone**

Trade Mark : Bmobile

Model/Type reference..... : AX1015

Listed Model(s)..... : -

Standard : **FCC CFR Title 47 Part 15 Subpart C Section 15.247**

Date of receipt of test sample..... : Sep.20, 2017

Date of testing..... : Sep.21, 2017 - Oct.10, 2017

Date of issue..... : Oct.11, 2017

Result..... : **PASS**

Compiled by
(Position+Printed name+Signature) : File administrators Candy Liu *Candy Liu*

Supervised by
(Position+Printed name+Signature) : Project Engineer : Edward Pan *Edward Pan*

Approved by
(Position+Printed name+Signature) : RF Manager Hans Hu *Hans Hu*

Testing Laboratory Name : **Shenzhen Huatongwei International Inspection Co., Ltd.**

Address..... : 1/F, Bldg 3, Hongfa Hi-tech Industrial Park, Genyu Road, Tianliao, Gongming, Shenzhen, China

Shenzhen Huatongwei International Inspection Co., Ltd. All rights reserved.

This publication may be reproduced in whole or in part for non-commercial purposes as long as the Shenzhen Huatongwei International Inspection Co., Ltd. is acknowledged as copyright owner and source of the material. Shenzhen Huatongwei International Inspection Co., Ltd. takes no responsibility for and will not assume liability for damages resulting from the reader's interpretation of the reproduced material due to its placement and context.

The test report merely correspond to the test sample.

Contents

1.	<u>TEST STANDARDS AND REPORT VERSION</u>	3
1.1.	Test Standards	3
1.2.	Report version	3
2.	<u>TEST DESCRIPTION</u>	4
3.	<u>SUMMARY</u>	5
3.1.	Client Information	5
3.2.	Product Description	5
3.3.	Operation state	6
3.4.	EUT configuration	6
3.5.	Modifications	6
4.	<u>TEST ENVIRONMENT</u>	7
4.1.	Address of the test laboratory	7
4.2.	Test Facility	7
4.3.	Environmental conditions	8
4.4.	Statement of the measurement uncertainty	8
4.5.	Equipments Used during the Test	9
5.	<u>TEST CONDITIONS AND RESULTS</u>	10
5.1.	Antenna Requirement	10
5.2.	Conducted Emissions (AC Main)	11
5.3.	Conducted Peak Output Power	14
5.4.	Power Spectral Density	15
5.5.	6dB bandwidth	17
5.6.	Restricted band	19
5.7.	Band edge and Spurious Emissions (conducted)	23
5.8.	Spurious Emissions (radiated)	31
6.	<u>TEST SETUP PHOTOS</u>	35
7.	<u>EXTERANAL AND INTERNAL PHOTOS</u>	36

1. TEST STANDARDS AND REPORT VERSION

1.1. Test Standards

The tests were performed according to following standards:

[FCC Rules Part 15.247](#): Frequency Hopping, Direct Spread Spectrum and Hybrid Systems that are in operation within the bands of 902-928 MHz, 2400-2483.5 MHz, and 5725-5850 MHz

[ANSI C63.10:2013](#): American National Standard for Testing Unlicensed Wireless Devices

[KDB 558074 D01 DTS Meas Guidance v04](#): Guidance for Performing Compliance Measurements on Digital Transmission Systems (DTS) Operating under §15.247

1.2. Report version

Version No.	Date of issue	Description
00	Oct.11, 2017	Original

2. TEST DESCRIPTION

Test Item	FCC Rule	Result	Test Engineer
Antenna requirement	15.203/15.247(c)	Pass	William Wang
Line Conducted Emissions (AC Main)	15.207	Pass	William Wang
Conducted Peak Output Power	15.247(b)(3)	Pass	William Wang
Power Spectral Density	15.247(e)	Pass	William Wang
6dB Bandwidth	15.247(a)(2)	Pass	William Wang
Restricted band	15.247(d)/15.205	Pass	William Wang
Spurious Emissions	15.247(d)/15.209	Pass	William Wang

Note: The measurement uncertainty is not included in the test result.

3. SUMMARY

3.1. Client Information

Applicant:	b mobile HK Limited
Address:	Flat 18; 14/F Block 1; Golden Industrial Building;16-26 Kwai Tak Street; Kwai Chung; New Territories; Hong Kong.
Manufacturer:	b mobile HK Limited
Address:	Flat 18; 14/F Block 1; Golden Industrial Building;16-26 Kwai Tak Street; Kwai Chung; New Territories; Hong Kong.

3.2. Product Description

Name of EUT:	Mobile Phone
Trade Mark:	Bmobile
Model No.:	AX1015
Listed Model(s):	-
IMEI 1:	861638031655405
IMEI 2:	861638031655413
Power supply:	DC 3.8V From exchange battery
Adapter information:	Input: 100-240Va.c., 50/60Hz, 0.2A Output: 5Vd.c., 500mA
Hardware version:	SPR_S3215_V4.0
Software version:	Bmobile_AX1015_TIGO_V004
Bluetooth	
Version:	Supported BT4.0+BLE
Modulation:	GFSK
Operation frequency:	2402MHz~2480MHz
Channel number:	40
Channel separation:	2MHz
Antenna type:	PIFA Antenna
Antenna gain:	0.8 dBi

3.3. Operation state

➤ **Test frequency list**

According to section 15.31(m), regards to the operating frequency range over 10 MHz, must select three channel which were tested. the Lowest frequency, the middle frequency, and the highest frequency of channel were selected to perform the test, please see the above gray bottom.

Channel	Frequency (MHz)
00	2402
01	2404
⋮	⋮
19	2440
⋮	⋮
38	2478
39	2480

➤ **Test mode**

For RF test items
The engineering test program was provided and enabled to make EUT continuous transmit (duty cycle>98%).
For AC power line conducted emissions:
The EUT was set to connect with the Bluetooth instrument under large package sizes transmission.
For RF test axis
EUT in each of three orthogonal axis emissions had been tested ,but only the worst case (X axis) data Recorded in the report.

3.4. EUT configuration

The following peripheral devices and interface cables were connected during the measurement:

- - supplied by the manufacturer
- - supplied by the lab

/	Manufacturer:	/
	Model No.:	/
/	Manufacturer:	/
	Model No.:	/

3.5. Modifications

No modifications were implemented to meet testing criteria.

4. TEST ENVIRONMENT

4.1. Address of the test laboratory

Laboratory: Shenzhen Huatongwei International Inspection Co., Ltd.

Address: 1/F, Bldg 3, Hongfa Hi-tech Industrial Park, Genyu Road, Tianliao, Gongming, Shenzhen, China

4.2. Test Facility

CNAS-Lab Code: L1225

Shenzhen Huatongwei International Inspection Co., Ltd. has been assessed and proved to be in compliance with CNAS-CL01 Accreditation Criteria for Testing and Calibration Laboratories (identical to ISO/IEC17025: 2005 General Requirements) for the Competence of Testing and Calibration Laboratories.

A2LA-Lab Cert. No.: 3902.01

Shenzhen Huatongwei International Inspection Co., Ltd. EMC Laboratory has been accredited by A2LA for technical competence in the field of electrical testing, and proved to be in compliance with ISO/IEC 17025: 2005 General Requirements for the Competence of Testing and Calibration Laboratories and any additional program requirements in the identified field of testing.

FCC-Registration No.: 762235

Shenzhen Huatongwei International Inspection Co., Ltd. EMC Laboratory has been registered and fully described in a report filed with the FCC (Federal Communications Commission). The acceptance letter from the FCC is maintained in our files.

IC-Registration No.:5377B-1

Two 3m Alternate Test Site of Shenzhen Huatongwei International Inspection Co., Ltd. has been registered by Certification and Engineering Bureau of Industry Canada for the performance of radiated measurements with Registration No.: 5377B-1.

ACA

Shenzhen Huatongwei International Inspection Co., Ltd. EMC Laboratory can also perform testing for the Australian C-Tick mark as a result of our A2LA accreditation.

4.3. Environmental conditions

During the measurement the environmental conditions were within the listed ranges:

Temperature:	15~35°C
Relative Humidity:	30~60 %
Air Pressure:	950~1050mba

4.4. Statement of the measurement uncertainty

The data and results referenced in this document are true and accurate. The reader is cautioned that there may be errors in calibration limits of the equipment and facilities. The measurement uncertainty was calculated for all measurements listed in this test report according to TR-100028-01 "Electromagnetic compatibility and Radio spectrum Matters (ERM); Uncertainties in the measurement of mobile radio equipment characteristics; Part 1" and TR-100028-02 "Electromagnetic compatibility and Radio spectrum Matters (ERM); Uncertainties in the measurement of mobile radio equipment characteristics; Part 2" and is documented in the Shenzhen Huatongwei International Inspection Co., Ltd. quality system according to ISO/IEC 17025. Furthermore, component and process variability of devices similar to that tested may result in additional deviation. The manufacturer has the sole responsibility of continued compliance of the device.

Here after the best measurement capability for Shenzhen Huatongwei International Inspection Co., Ltd. is reported:

Test Items	Measurement Uncertainty	Notes
Transmitter power conducted	0.57 dB	(1)
Transmitter power Radiated	2.20 dB	(1)
Conducted spurious emissions 9kHz~40GHz	1.60 dB	(1)
Radiated spurious emissions 9kHz~40GHz	2.20 dB	(1)
Conducted Emissions 9kHz~30MHz	3.39 dB	(1)
Radiated Emissions 30~1000MHz	4.24 dB	(1)
Radiated Emissions 1~18GHz	5.16 dB	(1)
Radiated Emissions 18~40GHz	5.54 dB	(1)

(1) This uncertainty represents an expanded uncertainty expressed at approximately the 95% confidence level using a coverage factor of k=1.96.

4.5. Equipments Used during the Test

Conducted Emissions					
Item	Test Equipment	Manufacturer	Model No.	Serial No.	Last Cal.
1	Artificial Mains	Rohde&Schwarz	ESH2-Z5	100028	2016/11/13
2	EMI Test Receiver	Rohde&Schwarz	ESCI3	100038	2016/11/13
3	Pulse Limiter	Rohde&Schwarz	ESHSZ2	100044	2016/11/13
4	EMI Test Software	Rohde&Schwarz	ES-K1 V1.71	-	-

Radiated Emissions					
Item	Test Equipment	Manufacturer	Model No.	Serial No.	Last Cal.
1	EMI test receiver	Rohde&Schwarz	ESI 26	100009	2016/11/13
2	Loop Antenna	Rohde&Schwarz	HFH2-Z2	100020	2016/11/13
3	Ultra-Broadband Antenna	ShwarzBeck	VULB9163	538	2016/11/13
4	Horn antenna	ShwarzBeck	9120D	1011	2016/11/13
5	Horn Antenna	SCHWARZBECK	BBHA9170	25841	2016/11/13
6	Amplifier	Sonoma	310N	E009-13	2016/11/13
7	JS Amplifier	Rohde&Schwarz	JS4-00101800-28-5A	F201504	2016/11/13
8	Amplifier	Compliance Direction systems	PAP1-4060	120	2016/11/13
9	High pass filter	Compliance Direction systems	BSU-6	34202	2016/11/13
10	EMI test Software	Rohde&Schwarz	ESK1	-	-
11	EMI test Software	Audix	E3	-	-
12	TURNTABLE	MATURO	TT2.0	-	-
13	ANTENNA MAST	MATURO	TAM-4.0-P	-	-

RF Conducted methods					
Item	Test Equipment	Manufacturer	Model No.	Serial No.	Last Cal.
1	Spectrum Analyzer	Rohde&Schwarz	FSP	1164.4391.40	2016/11/13
2	MXA Signal Analyzer	Agilent Technologies	N9020A	MY5050187	2016/11/13

The Cal.Interval was one year.

5. TEST CONDITIONS AND RESULTS

5.1. Antenna Requirement

Requirement

FCC CFR Title 47 Part 15 Subpart C Section 15.203:

An intentional radiator shall be designed to ensure that no antenna other than that furnished by the responsible party shall be used with the device. The use of a permanently attached antenna or of an antenna that uses a unique coupling to the intentional radiator, the manufacturer may design the unit so that a broken antenna can be replaced by the user, but the use of a standard antenna jack or electrical connector is prohibited.

FCC CFR Title 47 Part 15 Subpart C Section 15.247(c) (1)(i):

(i) Systems operating in the 2400-2483.5 MHz band that is used exclusively for fixed. Point-to-point operations may employ transmitting antennas with directional gain greater than 6 dBi provided the maximum conducted output power of the intentional radiator is reduced by 1 dB for every 3 dB that the directional gain of the antenna exceeds 6 dBi.

TEST RESULTS

Passed Not Applicable

The directional gain of the antenna less than 6 dBi, please refer to the below antenna photo.



5.2. Conducted Emissions (AC Main)

LIMIT

FCC CFR Title 47 Part 15 Subpart C Section 15.207

Frequency range (MHz)	Limit (dBuV)	
	Quasi-peak	Average
0.15-0.5	66 to 56*	56 to 46*
0.5-5	56	46
5-30	60	50

* Decreases with the logarithm of the frequency.

TEST CONFIGURATION

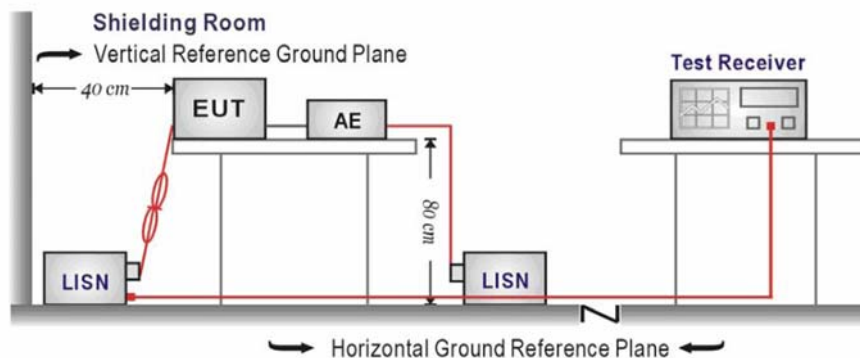

TEST PROCEDURE

1. The EUT was setup according to ANSI C63.10:2013 requirements.
2. The EUT was placed on a platform of nominal size, 1 m by 1.5 m, raised 80 cm above the conducting ground plane. The vertical conducting plane was located 40 cm to the rear of the EUT. All other surfaces of EUT were at least 80 cm from any other grounded conducting surface.
3. The EUT and simulators are connected to the main power through a line impedances stabilization network (LISN). The LISN provides a 50 ohm /50uH coupling impedance for the measuring equipment.
4. The peripheral devices are also connected to the main power through a LISN. (Please refer to the block diagram of the test setup and photographs)
5. Each current-carrying conductor of the EUT power cord, except the ground (safety) conductor, was individually connected through a LISN to the input power source.
6. The excess length of the power cord between the EUT and the LISN receptacle were folded back and forth at the center of the lead to form a bundle not exceeding 40 cm in length.
7. Conducted emissions were investigated over the frequency range from 0.15MHz to 30MHz using a receiver bandwidth of 9 kHz.
8. During the above scans, the emissions were maximized by cable manipulation.

TEST MODE:

Please refer to the clause 3.3

TEST RESULTS

Passed Not Applicable

Note:

- 1) Transd = Cable lose + Pulse Limiter Factor + Artificial Mains Factor
- 2) Margin = Limit - Level

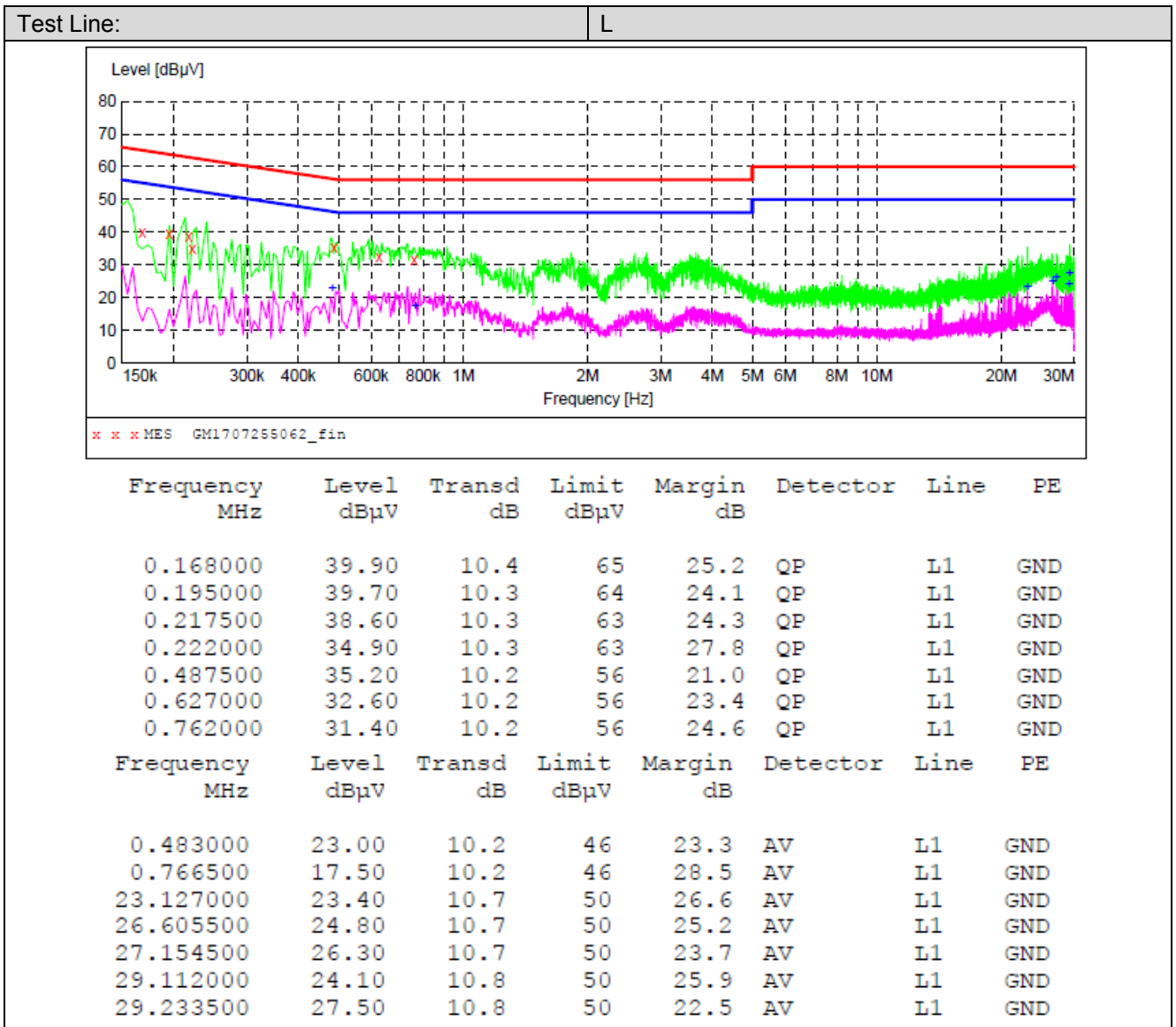

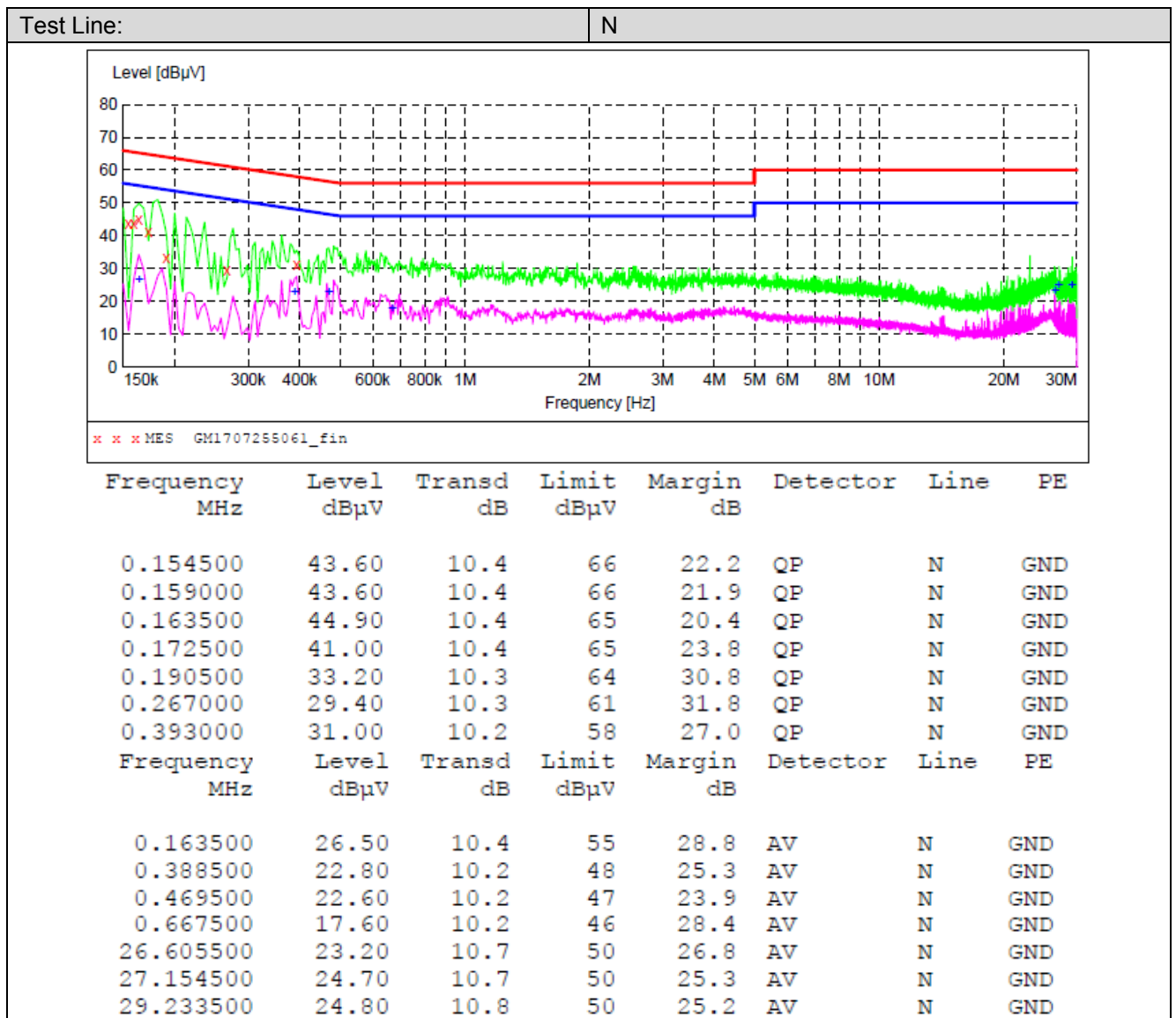

5.3. Conducted Peak Output Power

LIMIT

FCC CFR Title 47 Part 15 Subpart C Section 15.247 (b)(3): **30 dBm**

TEST CONFIGURATION

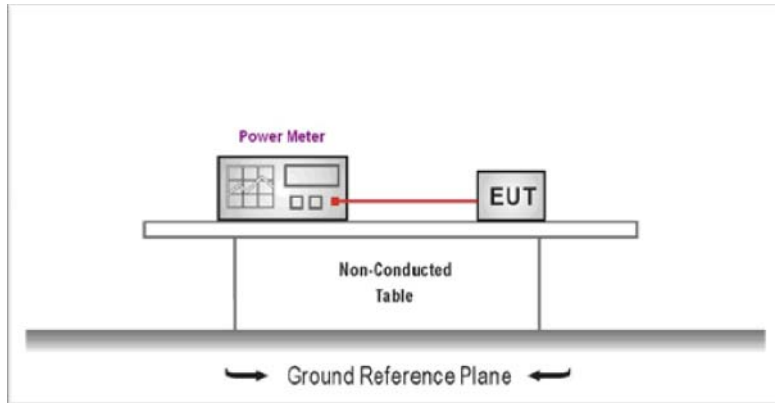

TEST PROCEDURE

1. The EUT was tested according to ANSI C63.10: 2013 and KDB 558074 D01 for compliance to FCC 47 CFR 15.247 requirements.
2. The maximum peak conducted output power may be measured using a broadband peak RF power meter.
3. The power meter shall have a video bandwidth that is greater than or equal to the DTS bandwidth and shall utilize a fast-responding diode detector.
4. Record the measurement data.

TEST MODE:

Please refer to the clause 3.3

TEST RESULTS

Passed **Not Applicable**

Type	Channel	Output power (dBm)	Limit (dBm)	Result
BT-BLE	00	-5.527	≤30.00	Pass
	19	-6.564		
	39	-5.173		

5.4. Power Spectral Density

LIMIT

FCC CFR Title 47 Part 15 Subpart C Section 15.247 (e): For digitally modulated systems, the power spectral density conducted from the intentional radiator to the antenna shall not be greater than 8 dBm in any 3 kHz band during any time interval of continuous transmission.

TEST CONFIGURATION

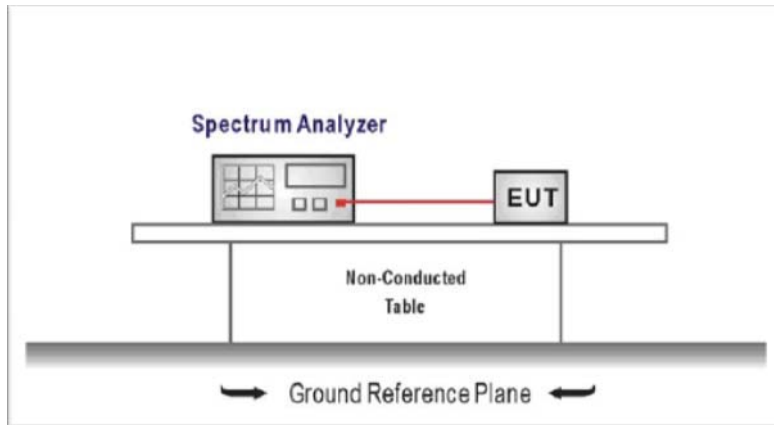

TEST PROCEDURE

1. Connect the antenna port(s) to the spectrum analyzer input,
2. Configure the spectrum analyzer as shown below:
 Center frequency=DTS channel center frequency
 Span =1.5 times the DTS bandwidth
 RBW = 3 kHz ≤ RBW ≤ 100 kHz, VBW ≥ 3 × RBW
 Sweep time = auto couple
 Detector = peak
 Trace mode = max hold
3. Place the radio in continuous transmit mode, allow the trace to stabilize, view the transmitter wave form on the spectrum analyzer.
4. Use the peak marker function to determine the maximum amplitude level within the RBW.
5. If measured value exceeds limit, reduce RBW (no less than 3 kHz) and repeat.

TEST MODE:



Please refer to the clause 3.3

TEST RESULTS

Passed Not Applicable

Type	Channel	Power Spectral Density(dBm/RBW)	Limit (dBm/RBW)	Result
BT-BLE	00	-20.232	≤8.00	Pass
	19	-21.359		
	39	-19.958		

Test plot as follows:

<p>CH00</p>		<p>Frequency</p> <p>Auto Tune</p> <p>Center Freq 2.40200000 GHz</p> <p>Start Freq 2.40150000 GHz</p> <p>Stop Freq 2.40250000 GHz</p> <p>CF Step 100.000 kHz Auto</p> <p>Freq Offset 0 Hz</p>
<p>CH19</p>		<p>Frequency</p> <p>Auto Tune</p> <p>Center Freq 2.44000000 GHz</p> <p>Start Freq 2.43950000 GHz</p> <p>Stop Freq 2.44050000 GHz</p> <p>CF Step 100.000 kHz Auto</p> <p>Freq Offset 0 Hz</p>
<p>CH39</p>		<p>Frequency</p> <p>Auto Tune</p> <p>Center Freq 2.48000000 GHz</p> <p>Start Freq 2.47950000 GHz</p> <p>Stop Freq 2.48050000 GHz</p> <p>CF Step 100.000 kHz Auto</p> <p>Freq Offset 0 Hz</p>

5.5. 6dB bandwidth

LIMIT

FCC CFR Title 47 Part 15 Subpart C Section 15.247 (a)(2):For digital modulation systems, the minimum 6 dB bandwidth shall be at least 500 kHz.

TEST CONFIGURATION

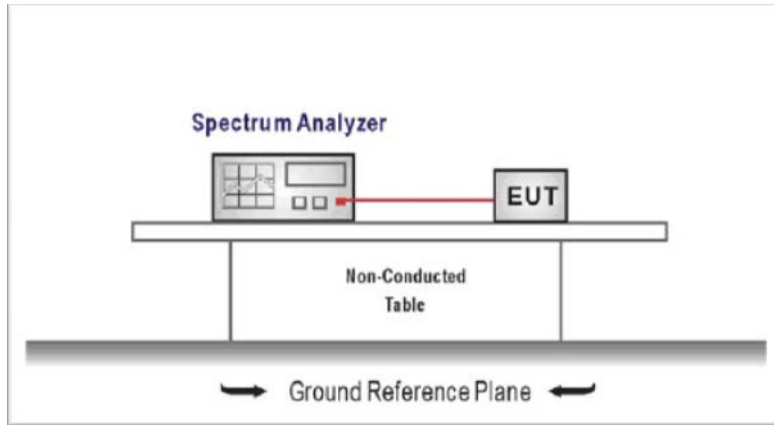

TEST PROCEDURE

1. Connect the antenna port(s) to the spectrum analyzer input.
2. Configure the spectrum analyzer as shown below (enter all losses between the transmitter output and the spectrum analyzer).
 Center Frequency =DTS channel center frequency
 Span=2 x DTS bandwidth
 RBW = 100 kHz, VBW ≥ 3 × RBW
 Sweep time= auto couple
 Detector = Peak
 Trace mode = max hold
3. Place the radio in continuous transmit mode, allow the trace to stabilize, view the transmitter waveform on the spectrum analyzer.
4. Measure the maximum width of the emission that is constrained by the frequencies associated with the two outermost amplitude points (upper and lower frequencies) that are attenuated by 6 dB relative to the maximum level measured in the fundamental emission, and record the pertinent measurements.

TEST MODE:

Please refer to the clause 3.3

TEST RESULTS

Passed Not Applicable

Type	Channel	6dB Bandwidth(kHz)	Limit (kHz)	Result
BT-BLE	00	0.6227	≥500	Pass
	19	0.6825		
	39	0.6734		

Test plot as follows:

<p>CH00</p>		<p>Frequency</p> <p>Center Freq 2.402000000 GHz</p> <p>CF Step 200.000 kHz</p> <p>Freq Offset 0 Hz</p>
<p>CH19</p>		<p>Frequency</p> <p>Center Freq 2.440000000 GHz</p> <p>CF Step 200.000 kHz</p> <p>Freq Offset 0 Hz</p>
<p>CH39</p>		<p>Frequency</p> <p>Center Freq 2.480000000 GHz</p> <p>CF Step 200.000 kHz</p> <p>Freq Offset 0 Hz</p>

5.6. Restricted band

LIMIT

FCC CFR Title 47 Part 15 Subpart C Section 15.247 (d):In any 100 kHz bandwidth outside the frequency band in which the spread spectrum or digitally modulated intentional radiator is operating, Radiated Emissions which fall in the restricted bands, as defined in §15.205(a), must also comply with the Radiated Emissions limits specified in §15.209(a) (see §15.205(c)).

TEST CONFIGURATION

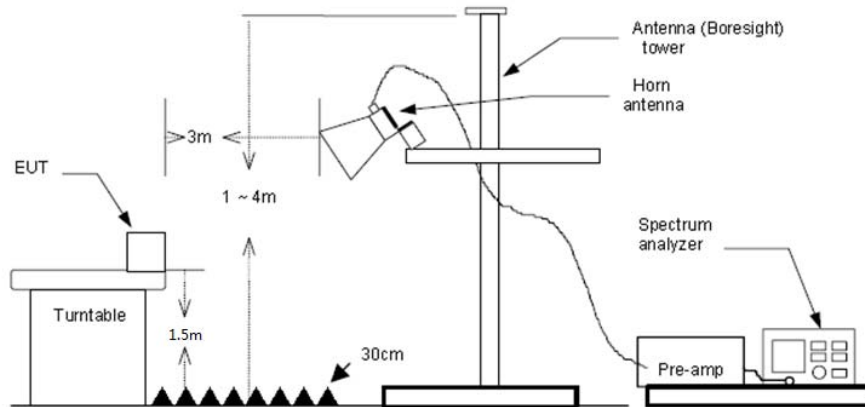

TEST PROCEDURE

1. The EUT was setup and tested according to ANSI C63.10:2013 for compliance to FCC 47CFR 15.247 requirements.
2. The EUT is placed on a turn table which is 1.5 meter above ground. The turn table is rotated 360 degrees to determine the position of the maximum emission level.
3. The EUT was positioned such that the distance from antenna to the EUT was 3 meters.
4. The antenna is scanned from 1 meter to 4 meters to find out the maximum emission level. This is repeated for both horizontal and vertical polarization of the antenna. In order to find the maximum emission, all of the interface cables were manipulated according to ANSI C63.10:2013 on radiated measurement.
5. The receiver set as follow:
 RBW=1MHz, VBW=3MHz Peak detector for Peak value.
 RBW=1MHz, VBW=3MHz RMS detector for Average value.

TEST MODE:

Please refer to the clause 3.3

TEST RESULTS

Passed **Not Applicable**

Note:

- 1) Final level= Read level + Antenna Factor+ Cable Loss- Preamp Factor
- 2) The peak level is lower than average limit(54 dBuV/m), this data is the too weak instrument of signal is unable to test.

CH00									
Frequency (MHz)	Read Level (dBuV)	Antenna Factor (dB/m)	Cable Loss (dB)	Preamp Factor (dB)	Level (dBuV/m)	Limit Line (dBuV/m)	Over Limit (dB)	Polarization	Test value
2310.00	34.14	28.05	6.62	37.65	31.16	74.00	-42.84	Vertical	Peak
2390.03	33.91	27.65	6.75	37.87	30.44	74.00	-43.56	Vertical	Peak
2310.00	34.06	28.05	6.62	37.65	31.08	74.00	-42.92	Horizontal	Peak
2390.03	35.11	27.65	6.75	37.87	31.64	74.00	-42.36	Horizontal	Peak

CH39									
Frequency (MHz)	Read Level (dBuV)	Antenna Factor (dB/m)	Cable Loss (dB)	Preamp Factor (dB)	Level (dBuV/m)	Limit Line (dBuV/m)	Over Limit (dB)	Polarization	Test value
2483.50	44.07	27.26	6.83	37.87	40.29	74.00	-33.71	Vertical	Peak
2500.00	34.46	27.20	6.84	37.87	30.63	74.00	-43.37	Vertical	Peak
2483.50	38.78	27.26	6.83	37.87	35.00	74.00	-39.00	Horizontal	Peak
2500.00	35.12	27.20	6.84	37.87	31.29	74.00	-42.71	Horizontal	Peak

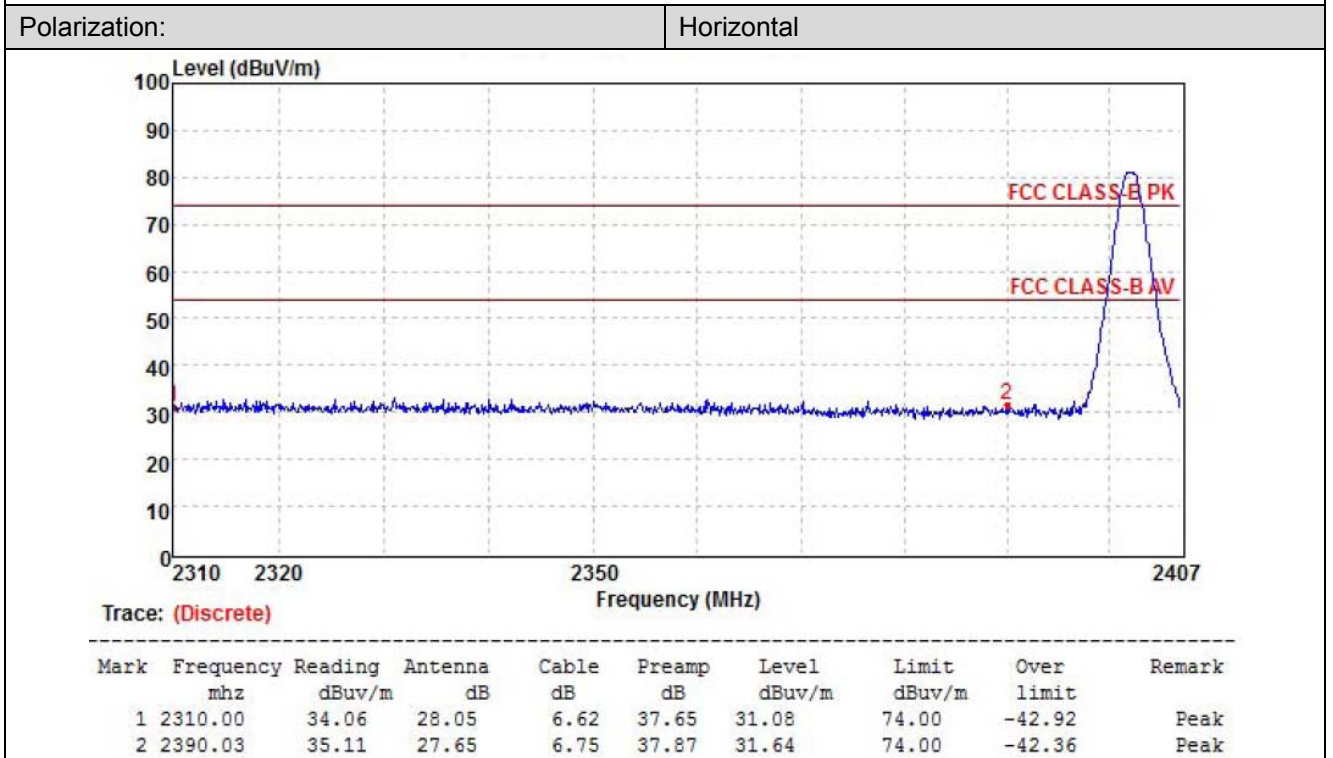
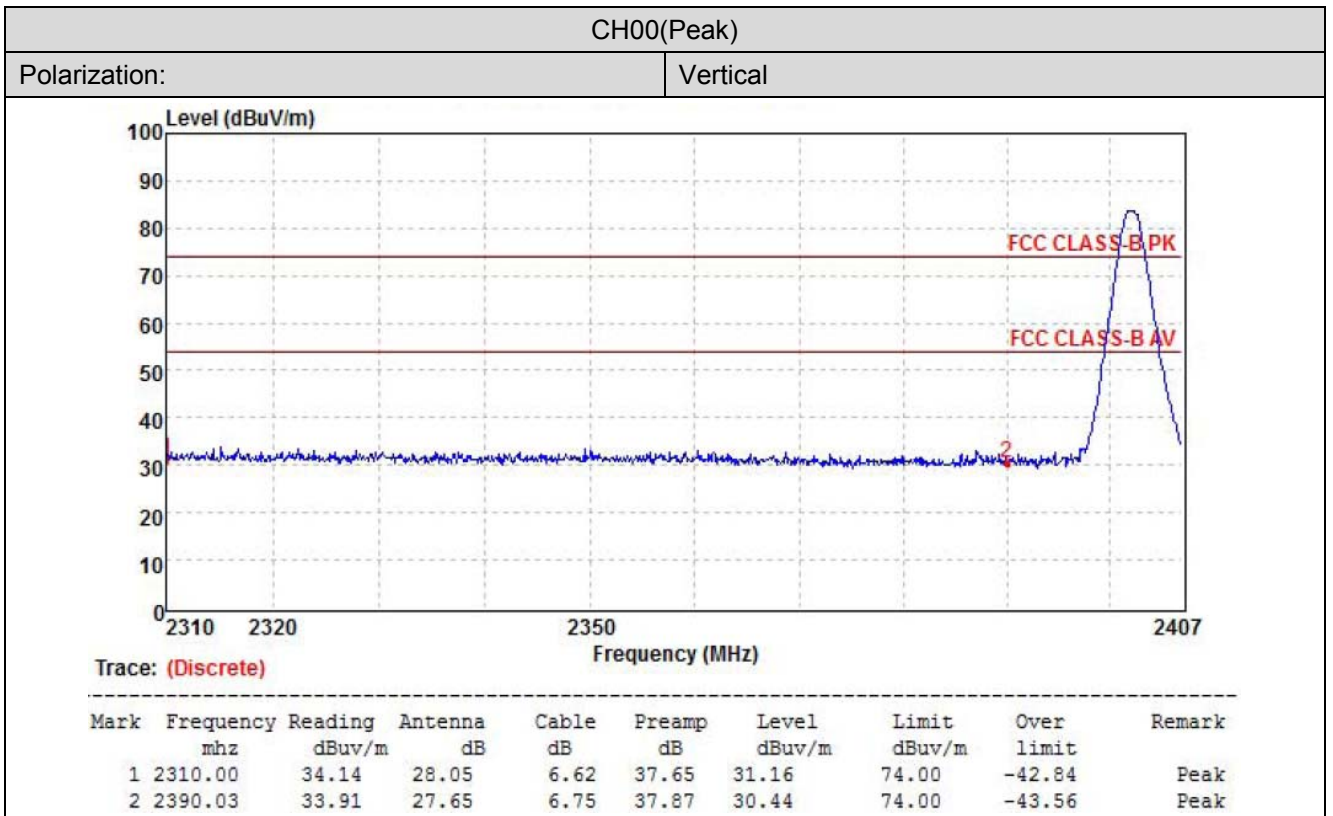

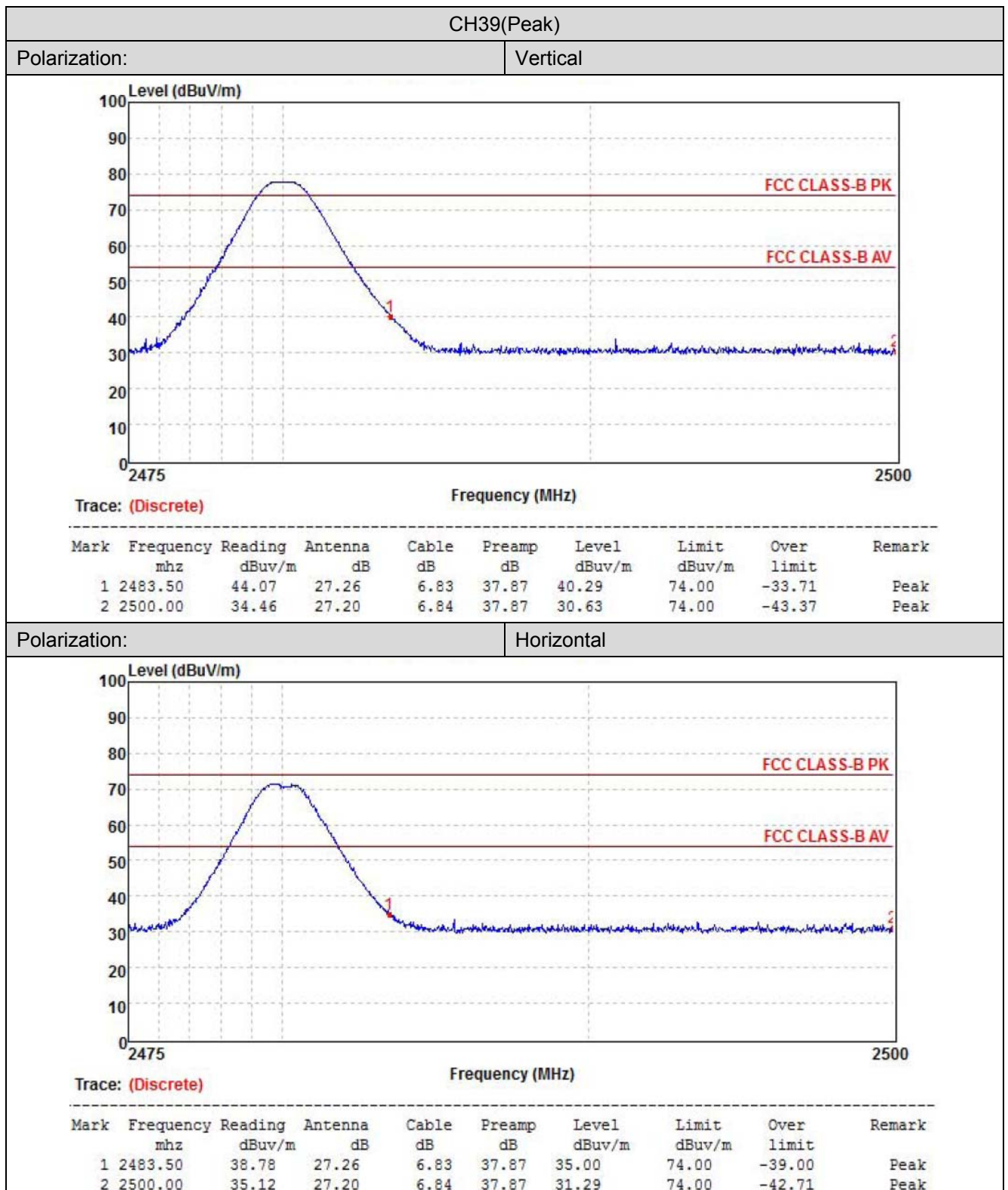

5.7. Band edge and Spurious Emissions (conducted)

LIMIT

FCC CFR Title 47 Part 15 Subpart C Section 15.247 (d): In any 100 kHz bandwidth outside the frequency band in which the spread spectrum intentional radiator is operating, the radio frequency power that is produced by the intentional radiator shall be at least 20 dB below that in the 100 kHz bandwidth within the band that contains the highest level of the desired power, based on either an RF conducted or a radiated measurement.

TEST CONFIGURATION

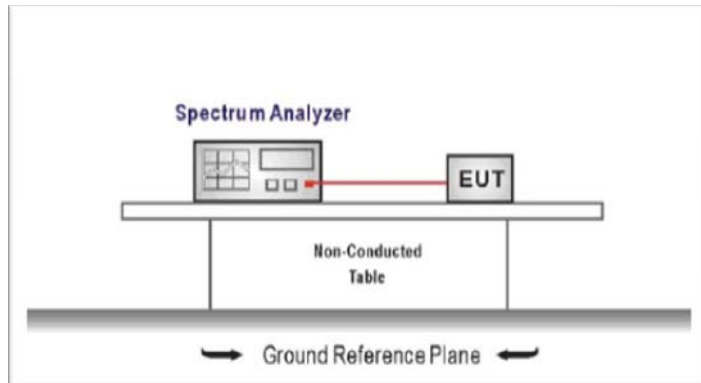

TEST PROCEDURE

1. Connect the antenna port(s) to the spectrum analyzer input.
2. Establish a reference level by using the following procedure
Center frequency=DTS channel center frequency
The span = 1.5 times the DTS bandwidth.
RBW = 100 kHz, VBW $\geq 3 \times$ RBW
Detector = peak, Sweep time = auto couple, Trace mode = max hold
Allow trace to fully stabilize
Use the peak marker function to determine the maximum PSD level

Note that the channel found to contain the maximum PSD level can be used to establish the reference level.

3. Emission level measurement
Set the center frequency and span to encompass frequency range to be measured
RBW = 100 kHz, VBW $\geq 3 \times$ RBW
Detector = peak, Sweep time = auto couple, Trace mode = max hold
Allow trace to fully stabilize
Use the peak marker function to determine the maximum amplitude level.
4. Place the radio in continuous transmit mode, allow the trace to stabilize, view the transmitter waveform on the spectrum analyzer.
5. Ensure that the amplitude of all unwanted emission outside of the authorized frequency band excluding restricted frequency bands) are attenuated by at least the minimum requirements specified (at least 20 dB relative to the maximum in-band peak PSD level in 100 kHz). Report the three highest emission relative to the limit.



TEST MODE:



Please refer to the clause 3.3

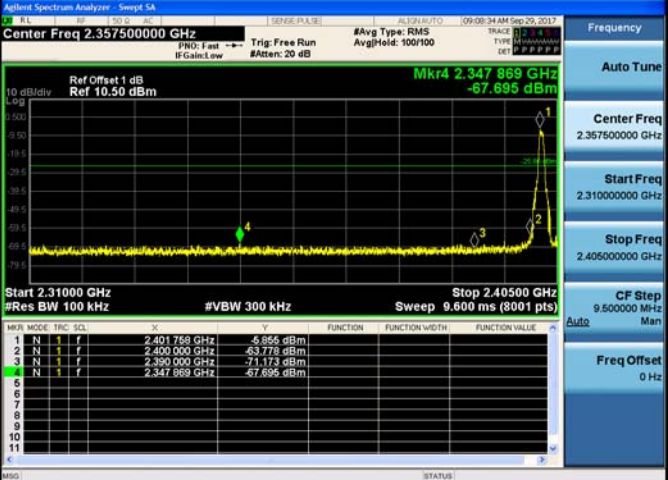
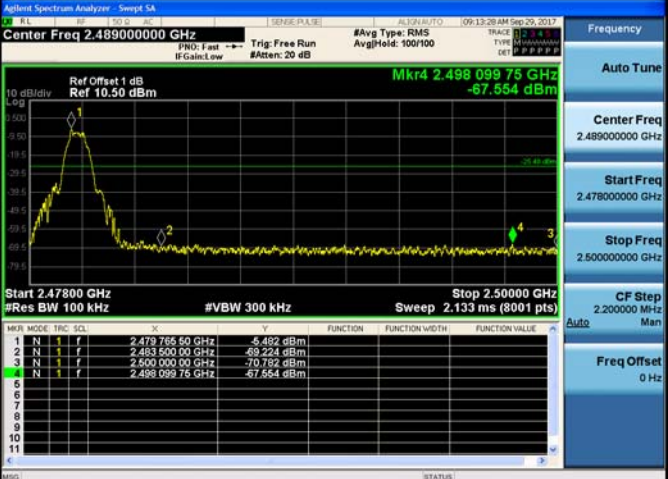

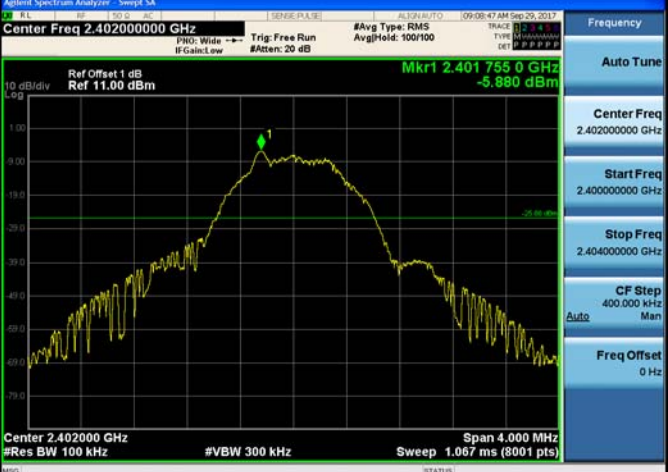
TEST RESULTS

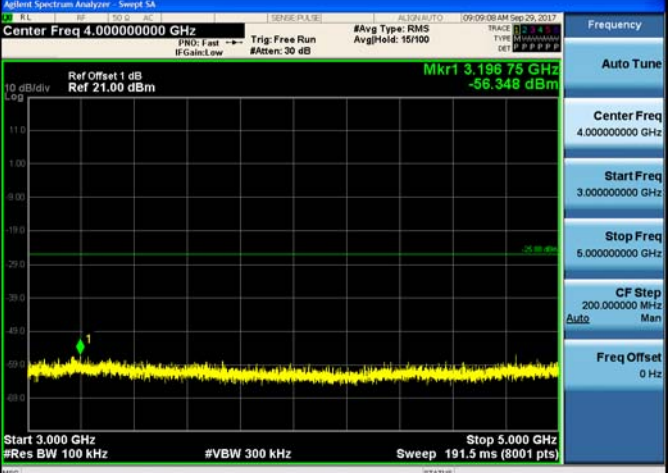

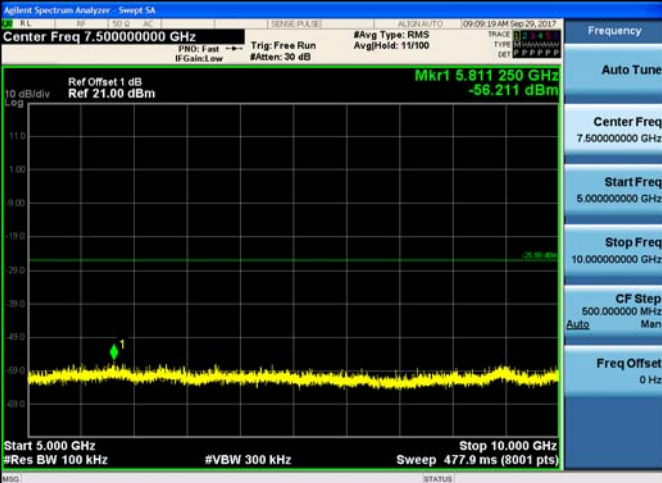
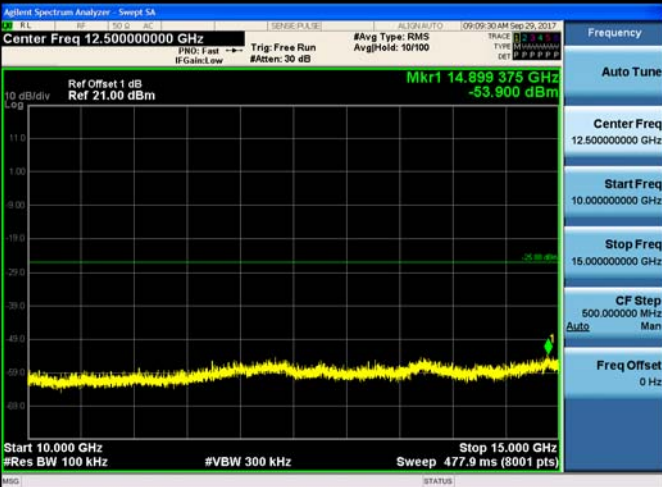
Passed Not Applicable

Test Item:	Band edge																																													
CH00	 <p>Agilent Spectrum Analyzer - Sweep SA</p> <p>Center Freq 2.357500000 GHz</p> <p>Ref Offset 1 dB Ref 10.50 dBm</p> <p>Mkr4 2.347 899 GHz -67.695 dBm</p> <p>Start 2.31000 GHz #Res BW 100 kHz</p> <p>Stop 2.40500 GHz #VBW 300 kHz Sweep 9.600 ms (8001 pts)</p> <table border="1"> <thead> <tr> <th>MRK</th> <th>MODE</th> <th>TRC</th> <th>SCL</th> <th>X</th> <th>Y</th> <th>FUNCTION</th> <th>FUNCTION WIDTH</th> <th>FUNCTION VALUE</th> </tr> </thead> <tbody> <tr> <td>1</td> <td>N</td> <td>1</td> <td>f</td> <td>2.401 758 GHz</td> <td>-5.856 dBm</td> <td></td> <td></td> <td></td> </tr> <tr> <td>2</td> <td>N</td> <td>1</td> <td>f</td> <td>2.400 000 GHz</td> <td>-63.778 dBm</td> <td></td> <td></td> <td></td> </tr> <tr> <td>3</td> <td>N</td> <td>1</td> <td>f</td> <td>2.393 000 GHz</td> <td>-71.173 dBm</td> <td></td> <td></td> <td></td> </tr> <tr> <td>4</td> <td>N</td> <td>1</td> <td>f</td> <td>2.347 899 GHz</td> <td>-67.695 dBm</td> <td></td> <td></td> <td></td> </tr> </tbody> </table> <p>Frequency</p> <p>Auto Tune</p> <p>Center Freq 2.357500000 GHz</p> <p>Start Freq 2.310000000 GHz</p> <p>Stop Freq 2.405000000 GHz</p> <p>CF Step 9.500000 MHz</p> <p>Freq Offset 0 Hz</p>	MRK	MODE	TRC	SCL	X	Y	FUNCTION	FUNCTION WIDTH	FUNCTION VALUE	1	N	1	f	2.401 758 GHz	-5.856 dBm				2	N	1	f	2.400 000 GHz	-63.778 dBm				3	N	1	f	2.393 000 GHz	-71.173 dBm				4	N	1	f	2.347 899 GHz	-67.695 dBm			
MRK	MODE	TRC	SCL	X	Y	FUNCTION	FUNCTION WIDTH	FUNCTION VALUE																																						
1	N	1	f	2.401 758 GHz	-5.856 dBm																																									
2	N	1	f	2.400 000 GHz	-63.778 dBm																																									
3	N	1	f	2.393 000 GHz	-71.173 dBm																																									
4	N	1	f	2.347 899 GHz	-67.695 dBm																																									
CH39	 <p>Agilent Spectrum Analyzer - Sweep SA</p> <p>Center Freq 2.489000000 GHz</p> <p>Ref Offset 1 dB Ref 10.50 dBm</p> <p>Mkr4 2.498 099 75 GHz -67.554 dBm</p> <p>Start 2.47800 GHz #Res BW 100 kHz</p> <p>Stop 2.50000 GHz #VBW 300 kHz Sweep 2.133 ms (8001 pts)</p> <table border="1"> <thead> <tr> <th>MRK</th> <th>MODE</th> <th>TRC</th> <th>SCL</th> <th>X</th> <th>Y</th> <th>FUNCTION</th> <th>FUNCTION WIDTH</th> <th>FUNCTION VALUE</th> </tr> </thead> <tbody> <tr> <td>1</td> <td>N</td> <td>1</td> <td>f</td> <td>2.479 765 50 GHz</td> <td>-5.482 dBm</td> <td></td> <td></td> <td></td> </tr> <tr> <td>2</td> <td>N</td> <td>1</td> <td>f</td> <td>2.483 500 00 GHz</td> <td>-69.224 dBm</td> <td></td> <td></td> <td></td> </tr> <tr> <td>3</td> <td>N</td> <td>1</td> <td>f</td> <td>2.500 000 00 GHz</td> <td>-70.782 dBm</td> <td></td> <td></td> <td></td> </tr> <tr> <td>4</td> <td>N</td> <td>1</td> <td>f</td> <td>2.498 099 75 GHz</td> <td>-67.554 dBm</td> <td></td> <td></td> <td></td> </tr> </tbody> </table> <p>Frequency</p> <p>Auto Tune</p> <p>Center Freq 2.489000000 GHz</p> <p>Start Freq 2.478000000 GHz</p> <p>Stop Freq 2.500000000 GHz</p> <p>CF Step 2.200000 MHz</p> <p>Freq Offset 0 Hz</p>	MRK	MODE	TRC	SCL	X	Y	FUNCTION	FUNCTION WIDTH	FUNCTION VALUE	1	N	1	f	2.479 765 50 GHz	-5.482 dBm				2	N	1	f	2.483 500 00 GHz	-69.224 dBm				3	N	1	f	2.500 000 00 GHz	-70.782 dBm				4	N	1	f	2.498 099 75 GHz	-67.554 dBm			
MRK	MODE	TRC	SCL	X	Y	FUNCTION	FUNCTION WIDTH	FUNCTION VALUE																																						
1	N	1	f	2.479 765 50 GHz	-5.482 dBm																																									
2	N	1	f	2.483 500 00 GHz	-69.224 dBm																																									
3	N	1	f	2.500 000 00 GHz	-70.782 dBm																																									
4	N	1	f	2.498 099 75 GHz	-67.554 dBm																																									

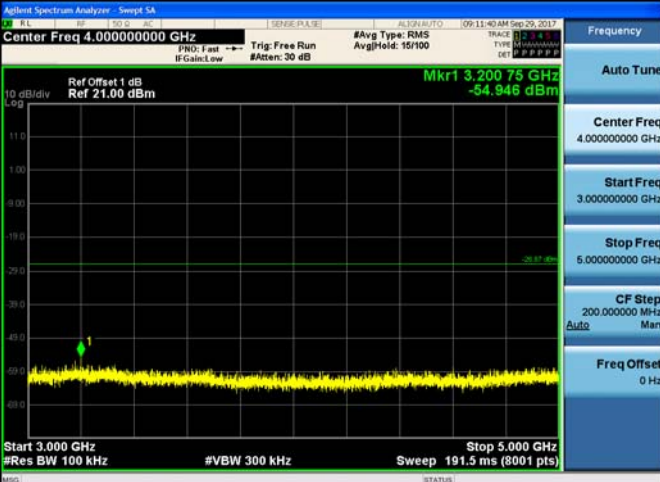

Test Item:	SE
<p>CH00 Reference level</p>	 <p>Agilent Spectrum Analyzer - Sweep SA Center Freq 2.402000000 GHz Ref Offset 1 dB Ref 11.00 dBm Mkr1 2.401755 0 GHz -5.980 dBm Span 4.000 MHz #Res BW 100 kHz #VBW 300 kHz Sweep 1.067 ms (8001 pts)</p>
<p>CH00 30MHz~3GHz</p>	 <p>Agilent Spectrum Analyzer - Sweep SA Center Freq 1.515000000 GHz Ref Offset 1 dB Ref 21.00 dBm Mkr2 2.647 3 GHz -56.253 dBm Start 30 MHz Stop 3.000 GHz #Res BW 100 kHz #VBW 300 kHz Sweep 284.3 ms (8001 pts)</p>
<p>CH00 3GHz~5GHz</p>	 <p>Agilent Spectrum Analyzer - Sweep SA Center Freq 4.000000000 GHz Ref Offset 1 dB Ref 21.00 dBm Mkr1 3.196 75 GHz -56.348 dBm Start 3.000 GHz Stop 5.000 GHz #Res BW 100 kHz #VBW 300 kHz Sweep 191.5 ms (8001 pts)</p>

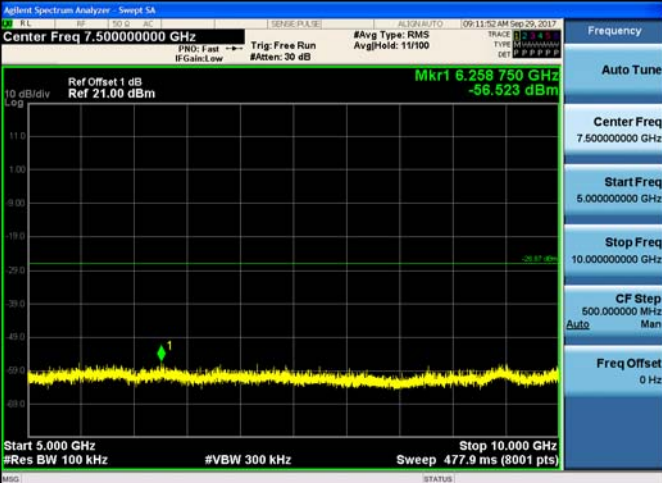
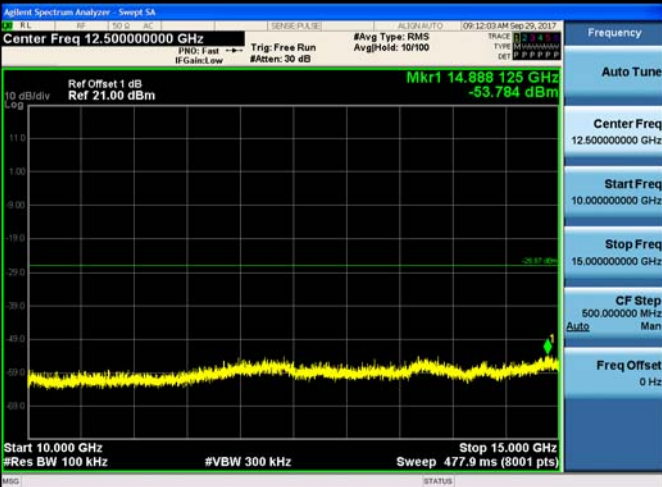
<p>CH00 5GHz~10GHz</p>	
<p>CH00 10GHz~15GHz</p>	
<p>CH00 15GHz~25GHz</p>	

<p>CH19 Reference level</p>	 <p>Agilent Spectrum Analyzer - Sweep SA Center Freq 2.44000000 GHz Ref Offset 1 dB Ref 11.00 dBm Mkr1 2.439 753 5 GHz -6.870 dBm Span 4.000 MHz #Res BW 100 kHz #VBW 300 kHz Sweep 1.067 ms (8001 pts)</p>
<p>CH19 30MHz~3GHz</p>	 <p>Agilent Spectrum Analyzer - Sweep SA Center Freq 1.51500000 GHz Ref Offset 1 dB Ref 21.00 dBm Mkr2 2.837 4 GHz -55.730 dBm Stop 3.000 GHz #Res BW 100 kHz #VBW 300 kHz Sweep 284.3 ms (8001 pts)</p>
<p>CH19 3GHz~5GHz</p>	 <p>Agilent Spectrum Analyzer - Sweep SA Center Freq 4.00000000 GHz Ref Offset 1 dB Ref 21.00 dBm Mkr1 3.200 75 GHz -54.946 dBm Stop 5.000 GHz #Res BW 100 kHz #VBW 300 kHz Sweep 191.5 ms (8001 pts)</p>

<p>CH19 5GHz~10GHz</p>	
<p>CH19 10GHz~15GHz</p>	
<p>CH19 15GHz~25GHz</p>	

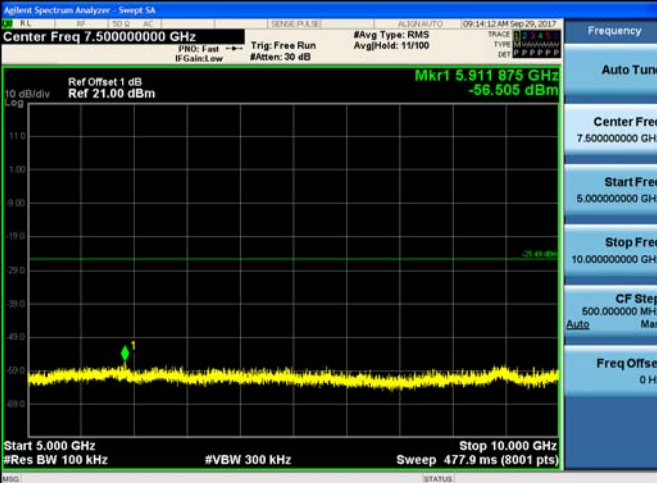
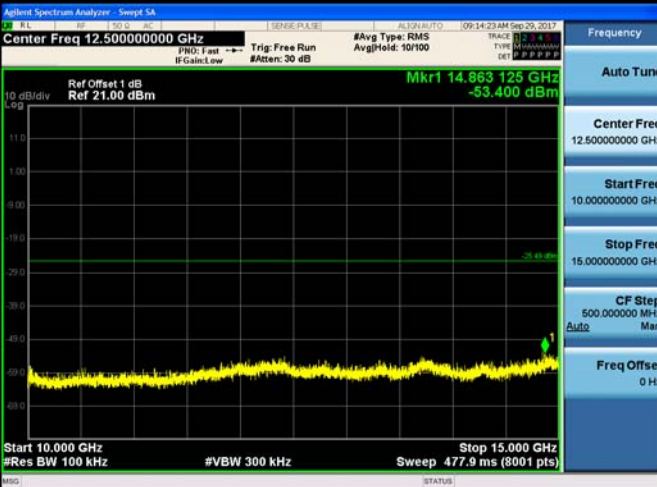
<p>CH39 Reference level</p>	<p>Agilent Spectrum Analyzer - Sweep SA Center Freq 2.48000000 GHz Ref Offset 1 dB Ref 11.00 dBm Mkr1 2.479 754 5 GHz -5.487 dBm Span 4.000 MHz #Res BW 100 kHz #VBW 300 kHz Sweep 1.067 ms (8001 pts)</p>
<p>CH39 30MHz~3GHz</p>	<p>Agilent Spectrum Analyzer - Sweep SA Center Freq 1.51500000 GHz Ref Offset 1 dB Ref 21.00 dBm Mkr2 2.708 6 GHz -55.448 dBm Start 30 MHz Stop 3.000 GHz #Res BW 100 kHz #VBW 300 kHz Sweep 284.3 ms (8001 pts)</p>
<p>CH39 3GHz~5GHz</p>	<p>Agilent Spectrum Analyzer - Sweep SA Center Freq 4.00000000 GHz Ref Offset 1 dB Ref 21.00 dBm Mkr1 3.184 25 GHz -56.087 dBm Start 3.000 GHz Stop 5.000 GHz #Res BW 100 kHz #VBW 300 kHz Sweep 191.5 ms (8001 pts)</p>

<p>CH39 5GHz~10GHz</p>	 <p>Agilent Spectrum Analyzer - Sweep SA Center Freq 7.500000000 GHz Ref Offset 1 dB Ref 21.00 dBm Mkr1 5.911875 GHz -56.505 dBm Start 5.0000 GHz #Res BW 100 kHz #VBW 300 kHz Sweep 477.9 ms (8001 pts)</p>
<p>CH39 10GHz~15GHz</p>	 <p>Agilent Spectrum Analyzer - Sweep SA Center Freq 12.500000000 GHz Ref Offset 1 dB Ref 21.00 dBm Mkr1 14.863125 GHz -53.400 dBm Start 10.0000 GHz #Res BW 100 kHz #VBW 300 kHz Sweep 477.9 ms (8001 pts)</p>
<p>CH39 15GHz~25GHz</p>	 <p>Agilent Spectrum Analyzer - Sweep SA Center Freq 20.000000000 GHz Ref Offset 1 dB Ref 23.00 dBm Mkr1 24.46875 GHz -44.367 dBm Start 15.0000 GHz #Res BW 100 kHz #VBW 300 kHz Sweep 955.7 ms (8001 pts)</p>

5.8. Spurious Emissions (radiated)

LIMIT

FCC CFR Title 47 Part 15 Subpart C Section 15.209

Frequency	Limit (dBuV/m @3m)	Value
30MHz~88MHz	40.00	Quasi-peak
88MHz~216MHz	43.50	Quasi-peak
216MHz~960MHz	46.00	Quasi-peak
960MHz~1GHz	54.00	Quasi-peak
Above 1GHz	54.00	Average
	74.00	Peak

TEST CONFIGURATION

- 9 kHz ~ 30 MHz

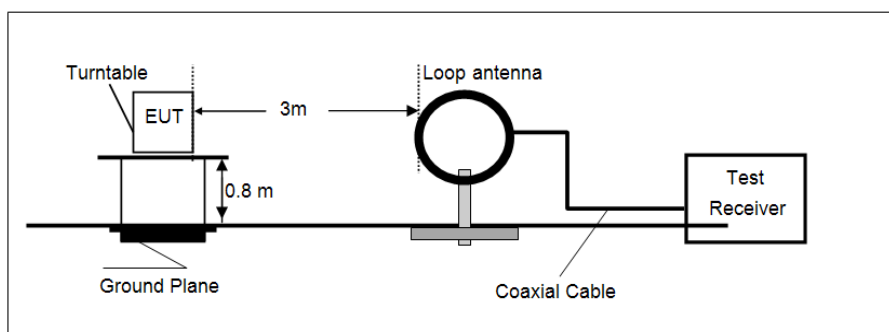

- 30 MHz ~ 1 GHz

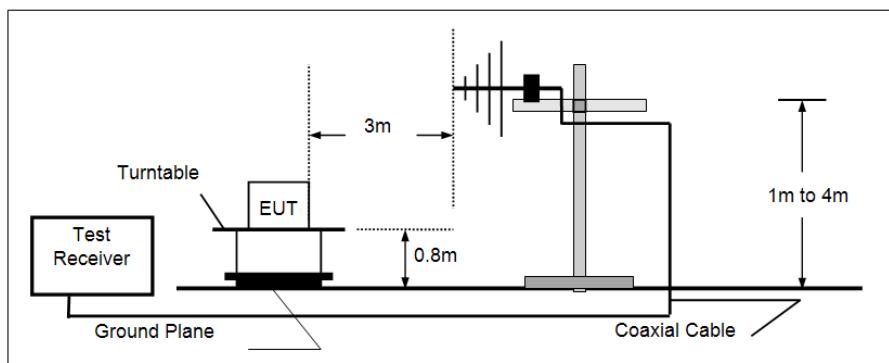

- Above 1 GHz

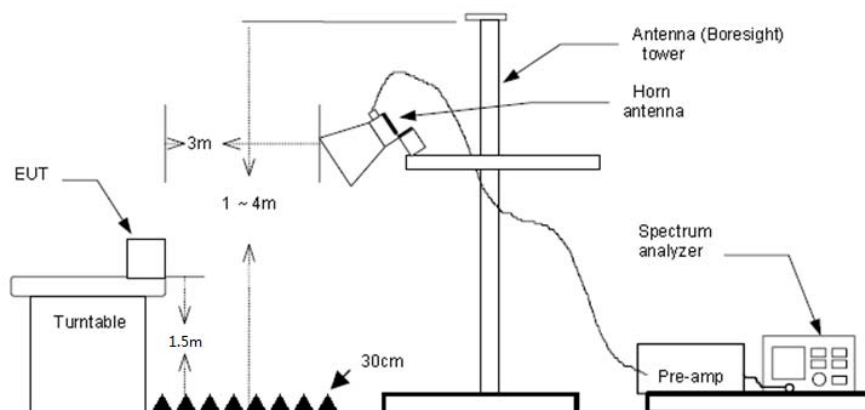

TEST PROCEDURE

1. The EUT was setup and tested according to ANSI C63.10:2013 for compliance to FCC 47CFR 15.247 requirements.
2. The EUT is placed on a turn table which is 0.8 meter above ground for below 1 GHz, and 1.5 m for above 1 GHz. The turn table is rotated 360 degrees to determine the position of the maximum emission level.
3. The EUT was positioned such that the distance from antenna to the EUT was 3 meters.
4. The antenna is scanned from 1 meter to 4 meters to find out the maximum emission level. This is repeated for both horizontal and vertical polarization of the antenna. In order to find the maximum emission, all of the interface cables were manipulated according to ANSI C63.10:2013 on radiated measurement.
5. Use the following spectrum analyzer settings
 - (1) Span shall wide enough to fully capture the emission being measured;
 - (2) Below 1 GHz, RBW=120 kHz, VBW=300 kHz, Sweep=auto, Detector function=peak, Trace=max hold;
If the emission level of the EUT measured by the peak detector is 3 dB lower than the applicable limit, the peak emission level will be reported. Otherwise, the emission measurement will be repeated using the quasi-peak detector and reported.
 - (3) Above 1GHz, RBW=1MHz, VBW=3MHz Peak detector for Peak value.
RBW=1MHz, VBW=3MHz RMS detector for Average value.

TEST MODE:

Please refer to the clause 3.3

TEST RESULTS

Passed **Not Applicable**

Note:

- 1) Above 1GHz Final Level =Receiver Read level + Antenna Factor + Cable Loss – Preamplifier Factor
 - 2) The emission levels of other frequencies are very lower than the limit and not show in test report.
- **9 kHz ~ 30 MHz**
The EUT was pre-scanned the frequency band (9 kHz ~ 30 MHz), found the radiated level lower than the limit, so don't show on the report.
- **30 MHz ~ 1000 MHz**
Have pre-scan all modulation mode, found the BT-BLE mode CH39 which it was worst case, so only the worst case's data on the test report.

➤ 30 MHz ~ 1 GHz

Polarization: Vertical

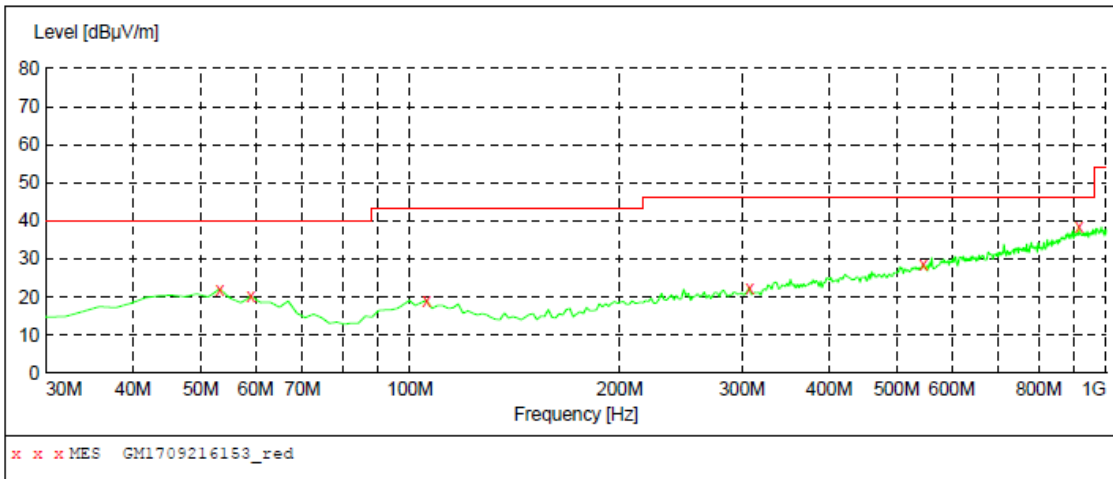

MEASUREMENT RESULT: "GM1709216153_red"

9/21/2017 8:47PM

Frequency MHz	Level dBuV/m	Transd dB	Limit dBuV/m	Margin dB	Det.	Height cm	Azimuth deg	Polarization
53.280000	22.10	-9.0	40.0	17.9	QP	100.0	300.00	VERTICAL
59.100000	20.20	-9.8	40.0	19.8	QP	100.0	78.00	VERTICAL
105.660000	19.20	-10.5	43.5	24.3	QP	100.0	197.00	VERTICAL
307.420000	22.50	-7.1	46.0	23.5	QP	100.0	289.00	VERTICAL
546.040000	28.40	-0.8	46.0	17.6	QP	100.0	237.00	VERTICAL
914.640000	38.30	6.9	46.0	7.7	QP	100.0	129.00	VERTICAL

Polarization: Horizontal

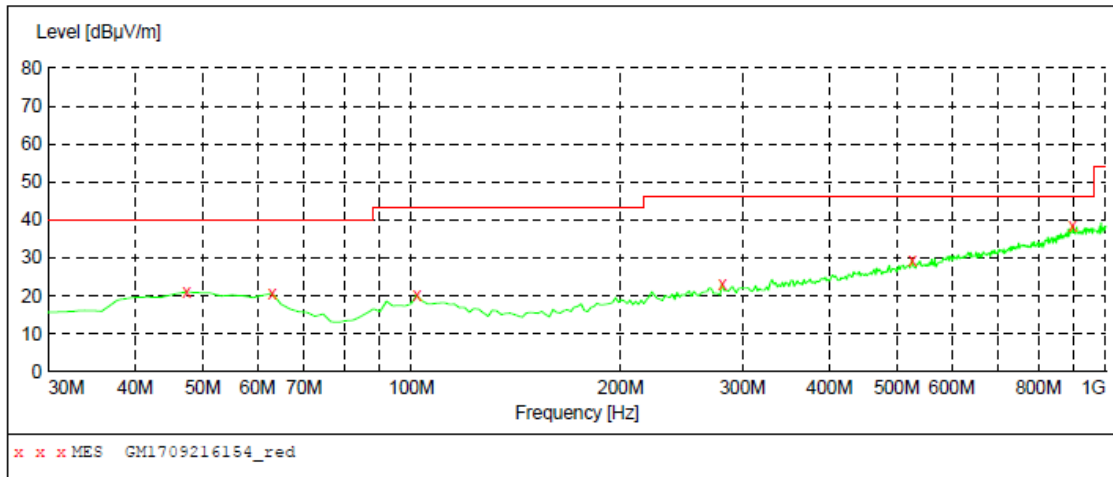

MEASUREMENT RESULT: "GM1709216154_red"

9/21/2017 8:50PM

Frequency MHz	Level dBuV/m	Transd dB	Limit dBuV/m	Margin dB	Det.	Height cm	Azimuth deg	Polarization
47.460000	21.10	-8.8	40.0	18.9	QP	300.0	247.00	HORIZONTAL
62.980000	20.70	-10.8	40.0	19.3	QP	300.0	196.00	HORIZONTAL
101.780000	20.20	-10.5	43.5	23.3	QP	300.0	360.00	HORIZONTAL
280.260000	23.10	-7.7	46.0	22.9	QP	300.0	326.00	HORIZONTAL
526.640000	29.30	-1.2	46.0	16.7	QP	300.0	117.00	HORIZONTAL
895.240000	38.30	6.6	46.0	7.7	QP	100.0	268.00	HORIZONTAL

➤ Above 1 GHz

CH00									
Frequency (MHz)	Read Level (dBuV)	Antenna Factor (dB/m)	Cable Loss (dB)	Preamp Factor (dB)	Level (dBuV/m)	Limit Line (dBuV/m)	Over Limit (dB)	Polarization	Test value
1402.92	38.13	25.90	5.01	36.46	32.58	74.00	-41.42	Vertical	Peak
3973.62	35.84	29.70	8.74	38.13	36.15	74.00	-37.85	Vertical	Peak
4809.50	37.17	31.58	9.55	36.93	41.37	74.00	-32.63	Vertical	Peak
7981.72	33.09	37.03	12.39	34.58	47.93	74.00	-26.07	Vertical	Peak
1541.48	36.93	25.42	5.40	36.64	31.11	74.00	-42.89	Horizontal	Peak
3973.62	35.16	29.70	8.74	38.13	35.47	74.00	-38.53	Horizontal	Peak
5518.20	32.91	31.88	10.21	36.25	38.75	74.00	-35.25	Horizontal	Peak
6886.15	32.85	34.60	11.71	34.90	44.26	74.00	-29.74	Horizontal	Peak

CH19									
Frequency (MHz)	Read Level (dBuV)	Antenna Factor (dB/m)	Cable Loss (dB)	Preamp Factor (dB)	Level (dBuV/m)	Limit Line (dBuV/m)	Over Limit (dB)	Polarization	Test value
1953.21	41.06	25.84	6.20	37.26	35.84	74.00	-38.16	Vertical	Peak
4014.29	35.67	29.73	8.79	38.08	36.11	74.00	-37.89	Vertical	Peak
5631.73	33.17	31.74	10.32	35.78	39.45	74.00	-34.55	Vertical	Peak
6992.14	31.60	35.25	11.84	34.80	43.89	74.00	-30.11	Vertical	Peak
1711.05	38.08	25.22	5.79	36.95	32.14	74.00	-41.86	Horizontal	Peak
3607.26	36.22	29.30	8.28	38.27	35.53	74.00	-38.47	Horizontal	Peak
5047.83	33.46	31.69	9.71	36.35	38.51	74.00	-35.49	Horizontal	Peak
7172.41	33.00	36.04	11.86	35.04	45.86	74.00	-28.14	Horizontal	Peak

CH39									
Frequency (MHz)	Read Level (dBuV)	Antenna Factor (dB/m)	Cable Loss (dB)	Preamp Factor (dB)	Level (dBuV/m)	Limit Line (dBuV/m)	Over Limit (dB)	Polarization	Test value
1768.62	38.22	25.34	5.90	37.07	32.39	74.00	-41.61	Vertical	Peak
3795.66	35.92	29.59	8.50	38.23	35.78	74.00	-38.22	Vertical	Peak
5776.92	32.98	31.99	10.55	35.38	40.14	74.00	-33.86	Vertical	Peak
6992.14	31.35	35.25	11.84	34.80	43.64	74.00	-30.36	Vertical	Peak
1750.70	37.19	25.30	5.86	37.04	31.31	74.00	-42.69	Horizontal	Peak
3525.56	35.73	29.08	8.15	38.37	34.59	74.00	-39.41	Horizontal	Peak
5099.49	33.41	31.90	9.75	36.30	38.76	74.00	-35.24	Horizontal	Peak
7135.98	31.84	35.82	11.86	34.99	44.53	74.00	-29.47	Horizontal	Peak

Remark:

1. Final Level = Receiver Read level + Antenna Factor + Cable Loss – Pre-amplifier Factor
2. The peak level is lower than average limit (54 dBuV/m), this data is the too weak instrument of signal is unable to test.
3. The emission levels of other frequencies are very lower than the limit and not show in test report.

6. TEST SETUP PHOTOS

Conducted Emissions



Radiated Emissions



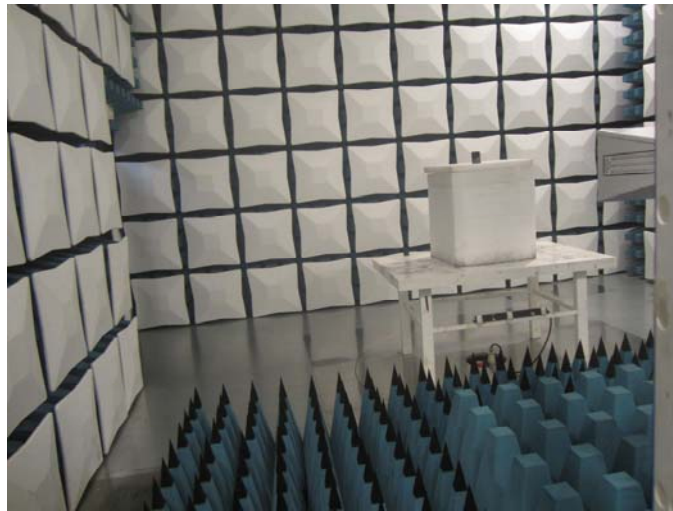

7. EXTERANAL AND INTERNAL PHOTOS

Reference to the test report No.: TRE1709017501.

.....**End of Report**.....