



TEST REPORT

Report Reference No...... : **TRE1707003004** R/C.....: 80042

FCC ID..... : **ZSW-30-047**

Applicant's name..... : **b mobile HK Limited**

Address..... : Flat 18; 14/F Block 1; Golden Industrial Building;16-26 KwaiTak Street; Kwai Chung; New Territories; Hong Kong.

Manufacturer..... : b mobile HK Limited

Address..... : Flat 18; 14/F Block 1; Golden Industrial Building;16-26 KwaiTak Street; Kwai Chung; New Territories; Hong Kong.

Test item description : **Mobile Phone**

Trade Mark : Bmobile

Model/Type reference..... : AX1015

Listed Model(s)..... : -

Standard : **FCC CFR Title 47 Part 15 Subpart C Section 15.247**

Date of receipt of test sample..... : Jul.05, 2017

Date of testing..... : Jul.06, 2017- Jul.28, 2017

Date of issue..... : Jul.29, 2017

Result..... : **PASS**

Compiled by
(position+printedname+signature).... : File administrators Candy Liu

Supervised by
(position+printedname+signature)..... : Project Engineer Lion Cai

Approved by
(position+printedname+signature)..... : RF Manager Hans Hu

Testing Laboratory Name : **Shenzhen Huatongwei International Inspection Co., Ltd.**

Address..... : 1/F, Bldg 3, Hongfa Hi-tech Industrial Park, Genyu Road, Tianliao, Gongming, Shenzhen, China

Shenzhen Huatongwei International Inspection Co., Ltd. All rights reserved.

This publication may be reproduced in whole or in part for non-commercial purposes as long as the Shenzhen Huatongwei International Inspection Co., Ltd. is acknowledged as copyright owner and source of the material. Shenzhen Huatongwei International Inspection Co., Ltd. takes no responsibility for and will not assume liability for damages resulting from the reader's interpretation of the reproduced material due to its placement and context.

Contents

1.	<u>TEST STANDARDS AND TEST DESCRIPTION</u>	3
1.1.	Test Standards	3
1.2.	Report version	3
2.	<u>TEST DESCRIPTION</u>	4
3.	<u>SUMMARY</u>	5
3.1.	Client Information	5
3.2.	Product Description	5
3.3.	Operation state	6
3.4.	EUT configuration	6
3.5.	Modifications	6
4.	<u>TEST ENVIRONMENT</u>	7
4.1.	Address of the test laboratory	7
4.2.	Test Facility	7
4.3.	Environmental conditions	8
4.4.	Statement of the measurement uncertainty	8
4.5.	Equipments Used during the Test	9
5.	<u>TEST CONDITIONS AND RESULTS</u>	10
5.1.	Antenna requirement	10
5.2.	Conducted Emission (AC Main)	11
5.3.	Conducted Peak Output Power	14
5.4.	20dB Emission Bandwidth	17
5.5.	Carrier Frequencies Separation	20
5.6.	Hopping Channel Number	22
5.7.	Dwell Time	24
5.8.	Pseudorandom Frequency Hopping Sequence	27
5.9.	Restricted band (radiated)	28
5.10.	Bandedge and Spurious Emission (conducted)	30
5.11.	Spurious Emission (radiated)	34
6.	<u>TEST SETUP PHOTOS OF THE EUT</u>	38
7.	<u>EXTERNAL AND INTERNAL PHOTOS OF THE EUT</u>	39

1. TEST STANDARDS AND TEST DESCRIPTION

1.1. Test Standards

The tests were performed according to following standards:

[FCC Rules Part 15.247](#): Frequency Hopping, Direct Spread Spectrum and Hybrid Systems that are in operation within the bands of 902-928 MHz, 2400-2483.5 MHz, and 5725-5850 MHz

[ANSI C63.10-2013](#): American National Standard for Testing Unlicensed Wireless Devices

1.2. Report version

Version No.	Date of issue	Description
00	Jul. 29, 2017	Original

2. Test Description

Test Item	Section in CFR 47	Result
Antenna Requirement	15.203/15.247 (c)	Pass
AC Power Line Conducted Emission	15.207	Pass
Conducted Peak Output Power	15.247 (b)(1)	Pass
20dB Occupied Bandwidth	15.247 (a)(1)	Pass
Carrier Frequencies Separation	15.247 (a)(1)	Pass
Hopping Channel Number	15.247 (a)(1)	Pass
Dwell Time	15.247 (a)(1)	Pass
Pseudorandom Frequency Hopping Sequence	15.247(b)(4)&TCB Exclusion List (7 July 2002)	Pass
Restricted band	15.247(d)/15.205	Pass
Radiated Emission	15.247(d)/15.209	Pass

Note: The measurement uncertainty is not included in the test result.

3. SUMMARY

3.1. Client Information

Applicant:	b mobile HK Limited
Address:	Flat 18; 14/F Block 1; Golden Industrial Building;16-26 Kwai Tak Street; Kwai Chung; New Territories; Hong Kong
Manufacturer:	b mobile HK Limited
Address:	Flat 18; 14/F Block 1; Golden Industrial Building;16-26 Kwai Tak Street; Kwai Chung; New Territories; Hong Kong

3.2. Product Description

Name of EUT:	Mobile Phone
Trade Mark:	Bmobile
Model No.:	AX1015
Listed Model(s):	-
IMEI:	861638030039908
Power supply:	DC 3.8V From internal battery
Adapter information:	Input:100-240Va.c., 50-60Hz, 0.2A Output: 5Vd.c.,500mA
Hardware version:	SPR_S3215_V4.0
Software version:	Bmobile_AX1015_TEM_V002
Bluetooth	
Version:	Supported BT4.0+EDR
Modulation:	GFSK, $\pi/4$ DQPSK, 8DPSK
Operation frequency:	2402MHz~2480MHz
Channel number:	79
Channel separation:	1MHz
Antenna type:	Integral Antenna
Antenna gain:	0dBi

3.3. Operation state

➤ **Test frequency list**

According to section 15.31(m), regards to the operating frequency range over 10 MHz, must select three channel which were tested. the Lowest frequency, the middle frequency, and the highest frequency of channel were selected to perform the test, please see the above gray bottom.

Channel	Frequency (MHz)
0	2402
1	2403
⋮	⋮
39	2441
⋮	⋮
77	2479
78	2480

➤ **Test mode**

For RF test items
The engineering test program was provided and enabled to make EUT continuous transmit (duty cycle>98%).
For AC power line conducted emissions:
The EUT was set to connect with the Bluetooth instrument under large package sizes transmission.
For RF test axis
EUT in each of three orthogonal axis emissions had been tested ,but only the worst case (X axis) data Recorded in the report.

3.4. EUT configuration

The following peripheral devices and interface cables were connected during the measurement:

- - supplied by the manufacturer
- - supplied by the lab

<input type="radio"/>	Power Cable	Length (m):	/
		Shield:	/
		Detachable:	/
<input type="radio"/>	Multimeter	Manufacturer:	/
		Model No.:	/

3.5. Modifications

No modifications were implemented to meet testing criteria.

4. TEST ENVIRONMENT

4.1. Address of the test laboratory

Laboratory: Shenzhen Huatongwei International Inspection Co., Ltd.

Address: 1/F, Bldg 3, Hongfa Hi-tech Industrial Park, Genyu Road, Tianliao, Gongming, Shenzhen, China

Phone: 86-755-26748019 Fax: 86-755-26748089

4.2. Test Facility

The test facility is recognized, certified, or accredited by the following organizations:

CNAS-Lab Code: L1225

Shenzhen Huatongwei International Inspection Co., Ltd. has been assessed and proved to be in compliance with CNAS-CL01 Accreditation Criteria for Testing and Calibration Laboratories (identical to ISO/IEC17025: 2005 General Requirements) for the Competence of Testing and Calibration Laboratories.

A2LA-Lab Cert. No.: 3902.01

Shenzhen Huatongwei International Inspection Co., Ltd. EMC Laboratory has been accredited by A2LA for technical competence in the field of electrical testing, and proved to be in compliance with ISO/IEC 17025: 2005 General Requirements for the Competence of Testing and Calibration Laboratories and any additional program requirements in the identified field of testing.

FCC-Registration No.: 762235

Shenzhen Huatongwei International Inspection Co., Ltd. EMC Laboratory has been registered and fully described in a report filed with the FCC (Federal Communications Commission). The acceptance letter from the FCC is maintained in our files. Registration 762235

IC-Registration No.: 5377B

Two 3m Alternate Test Site of Shenzhen Huatongwei International Inspection Co., Ltd. has been registered by Certification and Engineering Bureau of Industry Canada for the performance of radiated measurements with Registration No. 5377B.

ACA

Shenzhen Huatongwei International Inspection Co., Ltd. EMC Laboratory can also perform testing for the Australian C-Tick mark as a result of our A2LA accreditation.

4.3. Environmental conditions

During the measurement the environmental conditions were within the listed ranges:

Temperature:	15~35°C
Relative Humidity:	30~60 %
Air Pressure:	950~1050mba

4.4. Statement of the measurement uncertainty

The data and results referenced in this document are true and accurate. The reader is cautioned that there may be errors within the calibration limits of the equipment and facilities. The measurement uncertainty was calculated for all measurements listed in this test report acc. to TR-100028-01 "Electromagnetic compatibility and Radio spectrum Matters (ERM); Uncertainties in the measurement of mobile radio equipment characteristics; Part 1" and TR-100028-02 "Electromagnetic compatibility and Radio spectrum Matters (ERM); Uncertainties in the measurement of mobile radio equipment characteristics; Part 2" and is documented in the Shenzhen Huatongwei International Inspection Co., Ltd quality system acc. to DIN EN ISO/IEC 17025. Furthermore, component and process variability of devices similar to that tested may result in additional deviation. The manufacturer has the sole responsibility of continued compliance of the device.

Hereafter the best measurement capability for Shenzhen Huatongwei laboratory is reported:

Test Items	Measurement Uncertainty	Notes
Transmitter Power Conducted	0.57 dB	(1)
Transmitter Power Radiated	2.20 dB	(1)
Conducted Spurious Emission 9 kHz ~ 40 GHz	1.60 dB	(1)
Radiated Spurious Emission 9 kHz ~ 40 GHz	2.20 dB	(1)
Conducted Emission 9 kHz ~30 MHz	3.39 dB	(1)
Radiated Emission 30 ~1000 MHz	4.24 dB	(1)
Radiated Emission 1 ~ 18 GHz	5.16 dB	(1)
Radiated Emission 18 ~ 40 GHz	5.54 dB	(1)
Occupied Bandwidth	-----	(1)

(1) This uncertainty represents an expanded uncertainty expressed at approximately the 95% confidence level using a coverage factor of $k=1.96$.

4.5. Equipments Used during the Test

Conducted Emission (AC Main)					
Item	Test Equipment	Manufacturer	Model No.	Serial No.	Last Cal.
1	Artificial Mains	Rohde&Schwarz	ESH2-Z5	100028	2016/11/13
2	EMI Test Receiver	Rohde&Schwarz	ESCI3	100038	2016/11/13
3	Pulse Limiter	Rohde&Schwarz	ESHSZ2	100044	2016/11/13
4	EMI Test Software	Rohde&Schwarz	ES-K1 V1.71	N/A	N/A

Radiated Emission					
Item	Test Equipment	Manufacturer	Model No.	Serial No.	Last Cal.
1	Ultra-Broadband Antenna	ShwarzBeck	VULB9163	538	2016/11/13
2	EMI TEST RECEIVER	Rohde&Schwarz	ESI 26	100009	2016/11/13
3	EMI TEST Software	Audix	E3	N/A	N/A
4	TURNTABLE	ETS	2088	2149	N/A
5	ANTENNA MAST	ETS	2075	2346	N/A
6	EMI TEST Software	Rohde&Schwarz	ESK1	N/A	N/A
7	HORNANTENNA	ShwarzBeck	9120D	1011	2016/11/13
8	Amplifer	Sonoma	310N	E009-13	2016/11/13
9	JS amplifer	Rohde&Schwarz	JS4-00101800-28-5A	F201504	2016/11/13
10	High pass filter	Compliance Direction systems	BSU-6	34202	2016/11/13
11	HORNANTENNA	ShwarzBeck	9120D	1012	2016/11/13
12	Amplifer	Compliance Direction systems	PAP1-4060	120	2016/11/13
13	Loop Antenna	Rohde&Schwarz	HFH2-Z2	100020	2016/11/13
14	TURNTABLE	MATURO	TT2.0	----	N/A
15	ANTENNA MAST	MATURO	TAM-4.0-P	----	N/A
16	Horn Antenna	SCHWARZBECK	BBHA9170	25841	2016/11/13
17	ULTRA-BROADBAND ANTENNA	Rohde&Schwarz	HL562	100015	2016/11/13

Maximum Peak Output Power / Power Spectral Density / 6dB Bandwidth / Band Edge Compliance of RF Emission / Spurious RF Conducted Emission					
Item	Test Equipment	Manufacturer	Model No.	Serial No.	Last Cal
1	Spectrum Analyzer	Rohde&Schwarz	FSP	1164.4391.40	2016/11/13

The Cal.Interval was one year

5. TEST CONDITIONS AND RESULTS

5.1. Antenna requirement

Requirement

FCC CFR Title 47 Part 15 Subpart C Section 15.203:

An intentional radiator shall be designed to ensure that no antenna other than that furnished by the responsible party shall be used with the device. The use of a permanently attached antenna or of an antenna that uses a unique coupling to the intentional radiator, the manufacturer may design the unit so that a broken antenna can be replaced by the user, but the use of a standard antenna jack or electrical connector is prohibited.

FCC CFR Title 47 Part 15 Subpart C Section 15.247(c) (1)(i):

(i) Systems operating in the 2400~2483.5 MHz band that is used exclusively for fixed. Point-to-point operations may employ transmitting antennas with directional gain greater than 6 dBi provided the maximum conducted output power of the intentional radiator is reduced by 1 dB for every 3 dB that the directional gain of the antenna exceeds 6 dBi.

Test Result:

Passed **Not Applicable**

The antenna is integral antenna, the best case gain of the antenna is 0.0dBi.

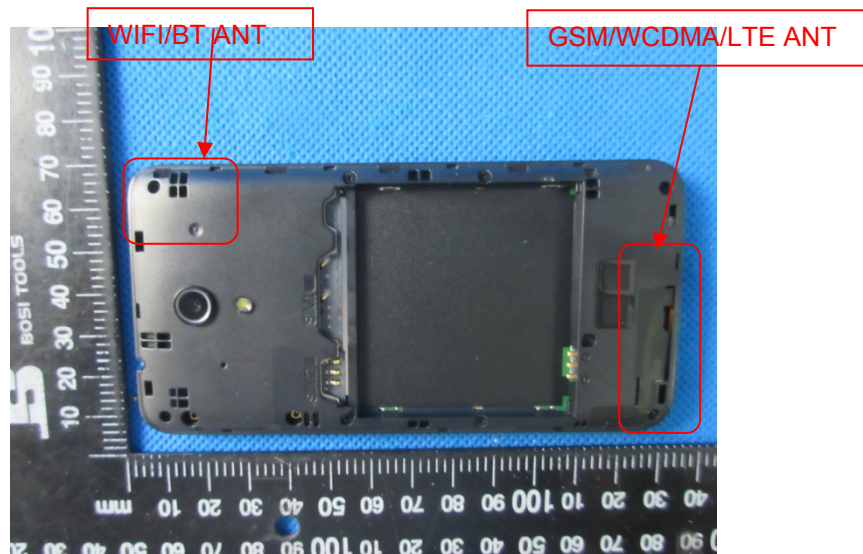

5.2. Conducted Emission (AC Main)

LIMIT

FCC CFR Title 47 Part 15 Subpart C Section 15.207

Frequency range (MHz)	Limit (dBuV)	
	Quasi-peak	Average
0.15-0.5	66 to 56*	56 to 46*
0.5-5	56	46
5-30	60	50

* Decreases with the logarithm of the frequency.

TEST CONFIGURATION

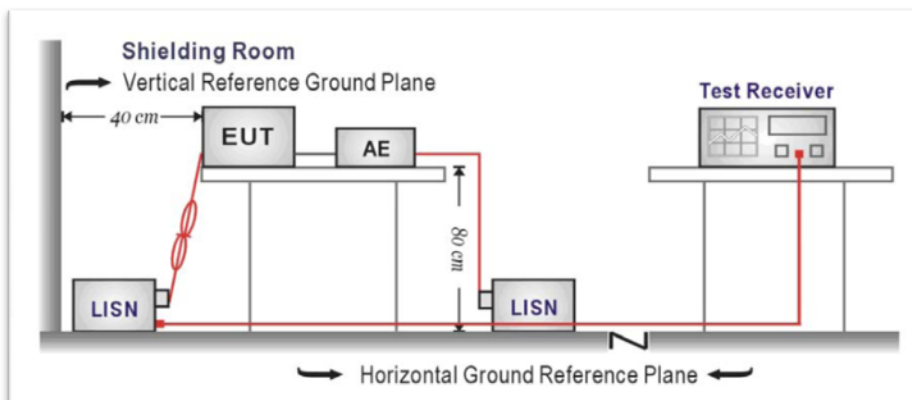

TEST PROCEDURE

1. The EUT was setup according to ANSI C63.10:2013 for compliance to FCC 47CFR 15.247 requirements.
2. The EUT was placed on a platform of nominal size, 1 m by 1.5 m, raised 80 cm above the conducting ground plane. The vertical conducting plane was located 40 cm to the rear of the EUT. All other surfaces of EUT were at least 80 cm from any other grounded conducting surface.
3. The EUT and simulators are connected to the main power through a line impedance stabilization network (LISN). The LISN provides a 50 ohm /50uH coupling impedance for the measuring equipment.
4. The peripheral devices are also connected to the main power through a LISN. (Please refer to the block diagram of the test setup and photographs)
5. Each current-carrying conductor of the EUT power cord, except the ground (safety) conductor, was individually connected through a LISN to the input power source.
6. The excess length of the power cord between the EUT and the LISN receptacle were folded back and forth at the center of the lead to form a bundle not exceeding 40 cm in length.
7. Conducted emissions were investigated over the frequency range from 0.15 MHz to 30 MHz using a receiver bandwidth of 9 kHz.
8. During the above scans, the emissions were maximized by cable manipulation.
- 9.

TEST RESULTS

Passed Not Applicable

Note:

- 1) Transd= Cable lose + Pulse Limiter Factor + Artificial Mains Factor
- 2) Margin= Limit - Level

Test Line: _____

L

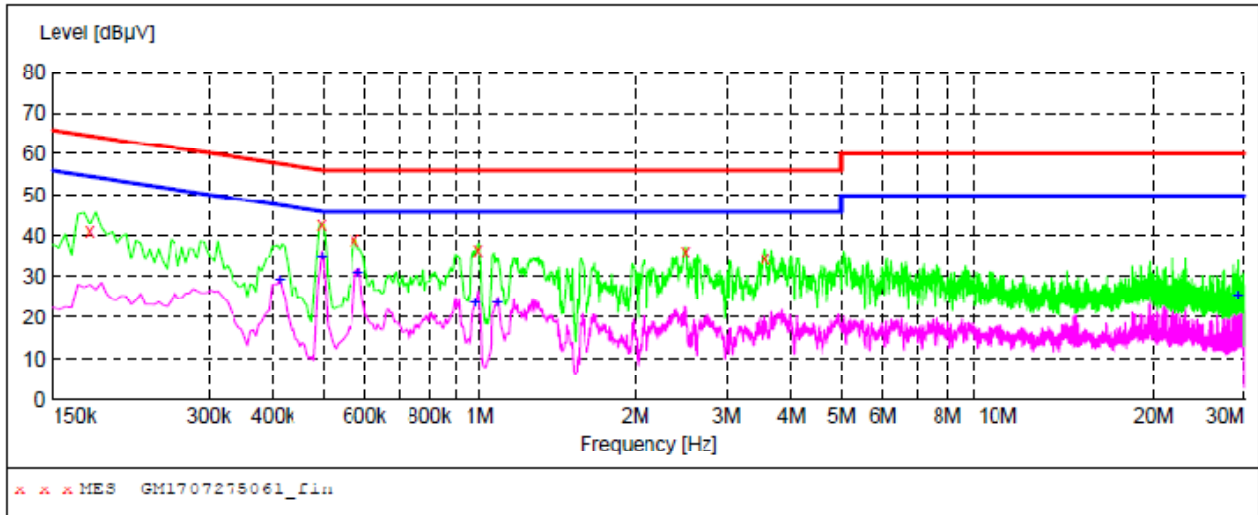

MEASUREMENT RESULT: "GM1707275061_fin"

7/27/2017 8:52PM

Frequency MHz	Level dBµV	Transd dB	Limit dBµV	Margin dB	Detector	Line	PE
0.177000	41.10	10.4	65	23.5	QP	L1	GND
0.496500	42.70	10.2	56	13.4	QP	L1	GND
0.573000	39.00	10.2	56	17.0	QP	L1	GND
0.996000	36.50	10.2	56	19.5	QP	L1	GND
2.499000	36.10	10.2	56	19.9	QP	L1	GND
3.565500	34.70	10.3	56	21.3	QP	L1	GND

MEASUREMENT RESULT: "GM1707275061_fin2"

7/27/2017 8:52PM

Frequency MHz	Level dBµV	Transd dB	Limit dBµV	Margin dB	Detector	Line	PE
0.411000	29.10	10.2	48	18.5	AV	L1	GND
0.496500	34.80	10.2	46	11.3	AV	L1	GND
0.582000	30.60	10.2	46	15.4	AV	L1	GND
0.982500	23.70	10.2	46	22.3	AV	L1	GND
1.081500	23.70	10.2	46	22.3	AV	L1	GND
29.233500	25.30	10.8	50	24.7	AV	L1	GND

Test Line: N

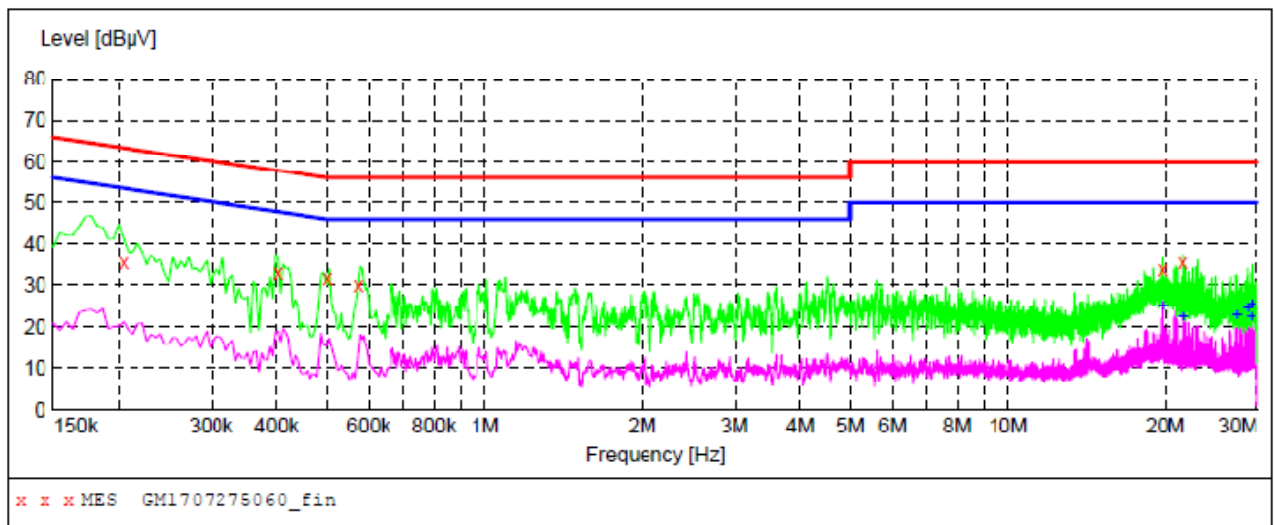

MEASUREMENT RESULT: "GM1707275060_fin"

7/27/2017 8:44PM

Frequency MHz	Level dBµV	Transd dB	Limit dBµV	Margin dB	Detector	Line	PE
0.204000	35.30	10.3	63	28.1	QP	N	GND
0.402000	33.00	10.2	58	24.8	QP	N	GND
0.501000	31.40	10.2	56	24.6	QP	N	GND
0.573000	30.00	10.2	56	26.0	QP	N	GND
19.707000	33.60	10.5	60	26.4	QP	N	GND
21.660000	35.20	10.6	60	24.8	QP	N	GND

MEASUREMENT RESULT: "GM1707275060_fin2"

7/27/2017 8:44PM

Frequency MHz	Level dBµV	Transd dB	Limit dBµV	Margin dB	Detector	Line	PE
19.707000	25.00	10.5	50	25.0	AV	N	GND
21.664500	22.30	10.6	50	27.7	AV	N	GND
27.339000	22.90	10.7	50	27.1	AV	N	GND
28.684500	24.40	10.8	50	25.6	AV	N	GND
29.112000	22.30	10.8	50	27.7	AV	N	GND
29.233500	25.20	10.8	50	24.8	AV	N	GND

5.3. Conducted Peak Output Power

LIMIT

FCC CFR Title 47 Part 15 Subpart C Section 15.247 (b)(3): **30dBm**

TEST CONFIGURATION

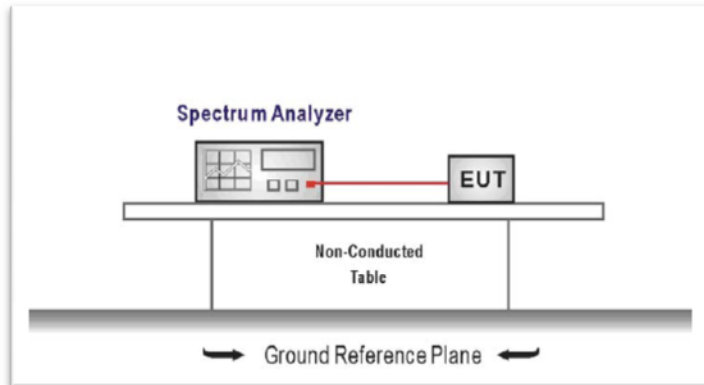

TEST PROCEDURE

1. The transmitter output was connected to the spectrum analyzer through an attenuator, the path loss was compensated to the results for each measurement.
2. Set to the maximum power setting and enable the EUT transmit continuously
3. Use the following spectrum analyzer settings:
 Span = approximately 5 times the 20 dB bandwidth, centered on a hopping channel
 RBW ≥ the 20 dB bandwidth of the emission being measured, VBW ≥ RBW
 Sweep = auto, Detector function = peak, Trace = max hold
4. Measure and record the results in the test report.

TEST MODE:

Please refer to the clause 3.3

TEST RESULTS

Passed **Not Applicable**

Modulation type	Channel	Output power (dBm)	Limit (dBm)	Result
GFSK	00	-2.14	30.00	Pass
	39	-2.05		
	78	-1.20		
π/4DQPSK	00	-0.56	21.00	Pass
	39	-1.20		
	78	0.27		
8DPSK	00	-0.27	21.00	Pass
	39	-0.87		
	78	0.54		

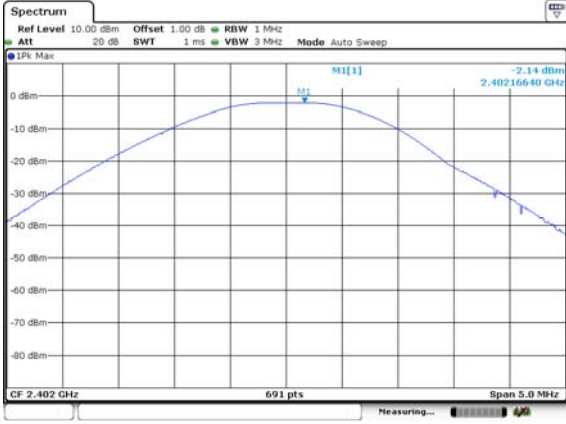
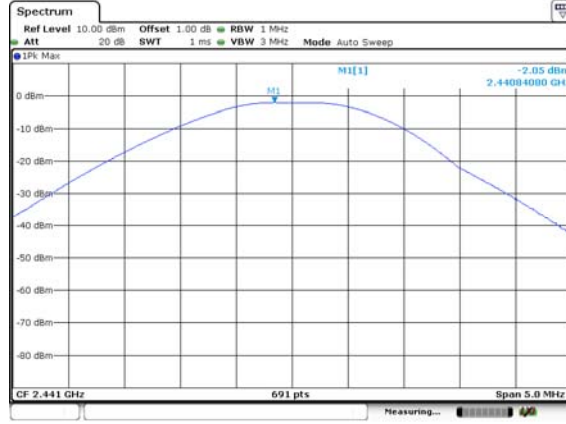
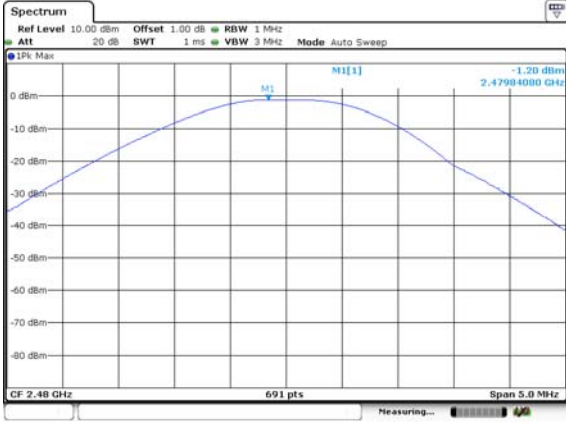
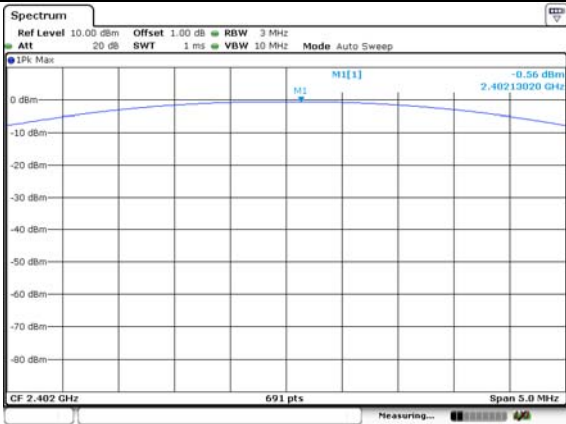
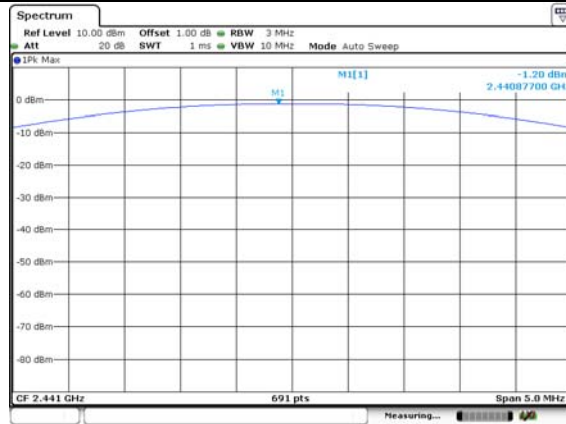
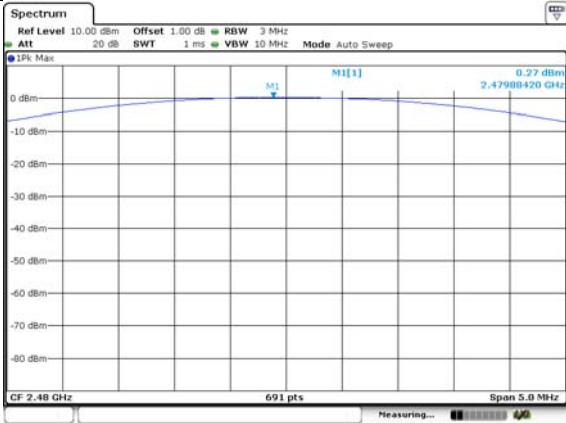
GFSK	
	
CH00	CH39
	No Plot
CH78	-
π/4DQPSK	
	
CH00	CH39
	No Plot
CH78	-

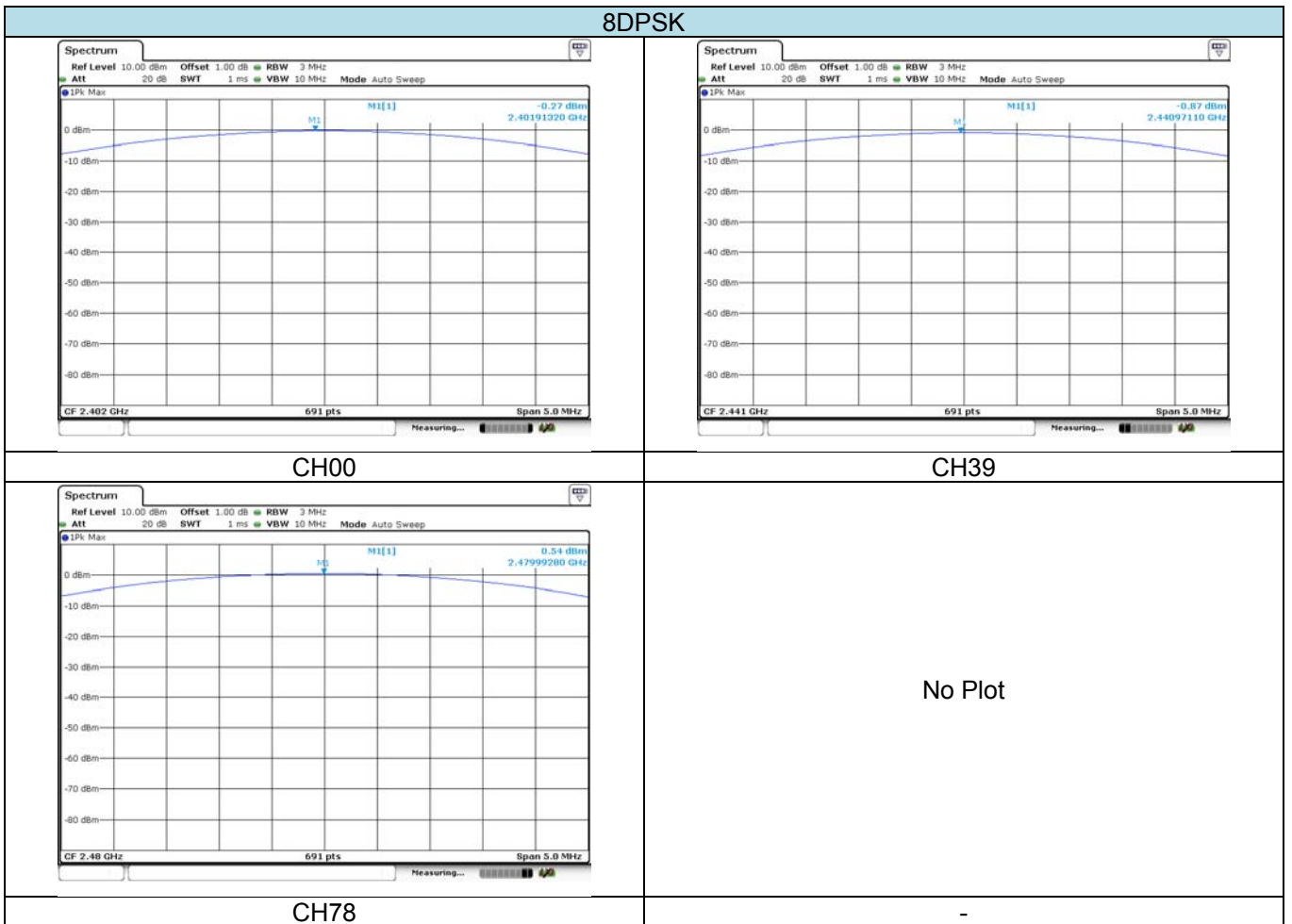

5.4. 20dB Emission Bandwidth

LIMIT

N/A

TEST CONFIGURATION

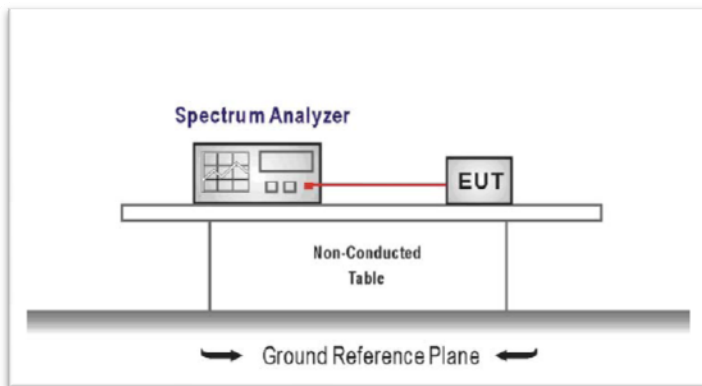

TEST PROCEDURE

1. The transmitter output was connected to the spectrum analyzer through an attenuator, the path loss was compensated to the results for each measurement.
2. Set to the maximum power setting and enable the EUT transmit continuously
3. Use the following spectrum analyzer settings:
 Span = approximately 2 to 3 times the 20 dB bandwidth, centered on a hopping channel
 RBW ≥ 1% of the 20 dB bandwidth, VBW ≥ RBW
 Sweep = auto, Detector function = peak, Trace = max hold
4. Measure and record the results in the test report.

TEST MODE:

Please refer to the clause 3.3

TEST RESULTS

Passed **Not Applicable**

Modulation type	Channel	20dB Bandwidth (MHz)	Limit (MHz)	Result
GFSK	00	0.923	-	Pass
	39	0.926		
	78	0.923		
π/4DQPSK	00	1.313	-	Pass
	39	1.321		
	78	1.310		
8DPSK	00	1.302	-	Pass
	39	1.313		
	78	1.313		

GFSK

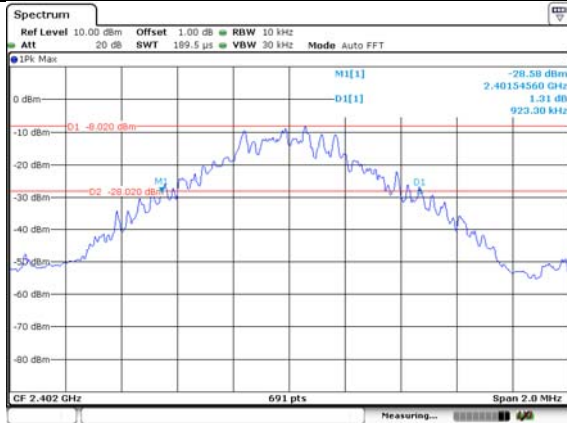

CH00

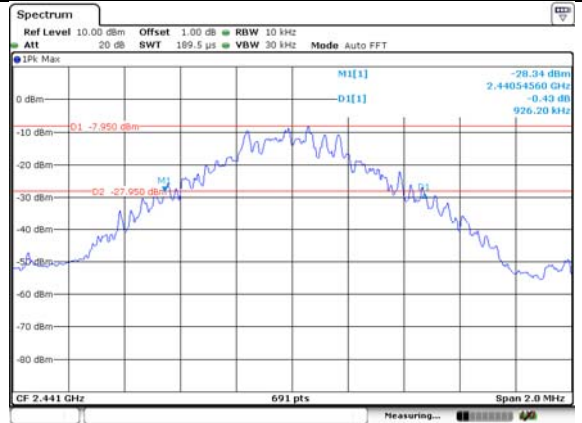

CH39

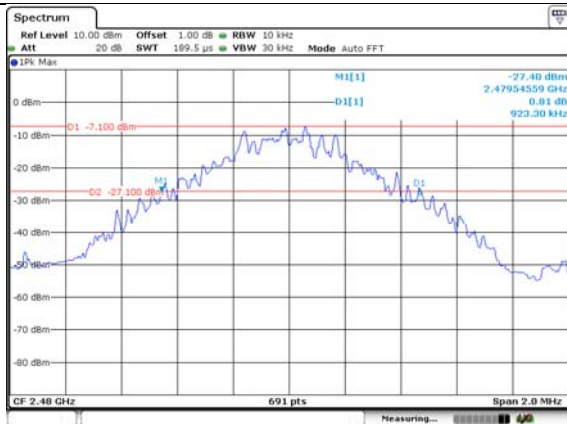

CH78

No Plot

$\pi/4$ DQPSK

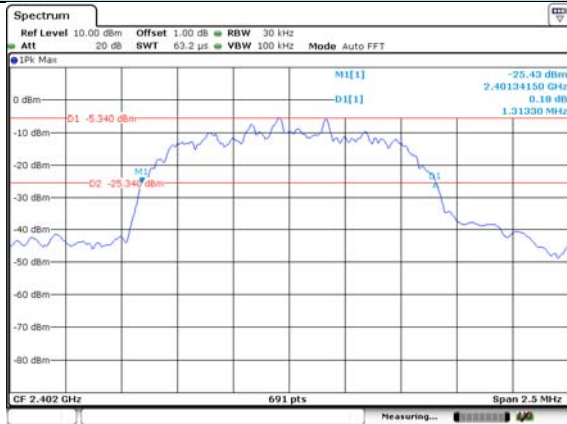

CH00

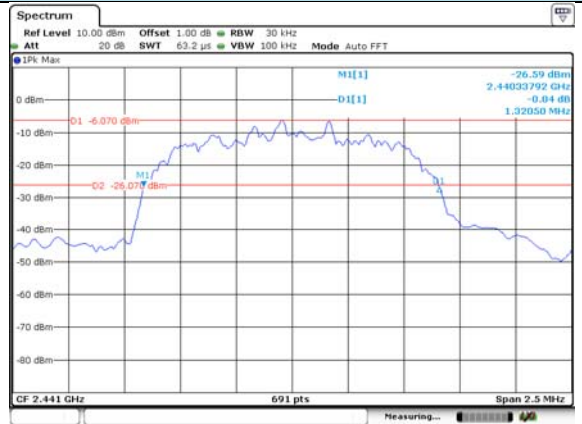

CH39

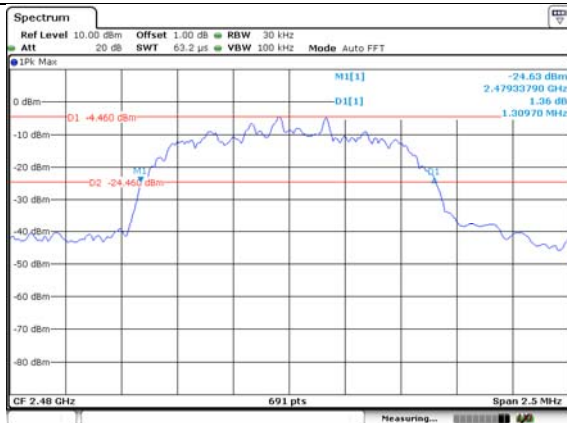

CH78

No Plot

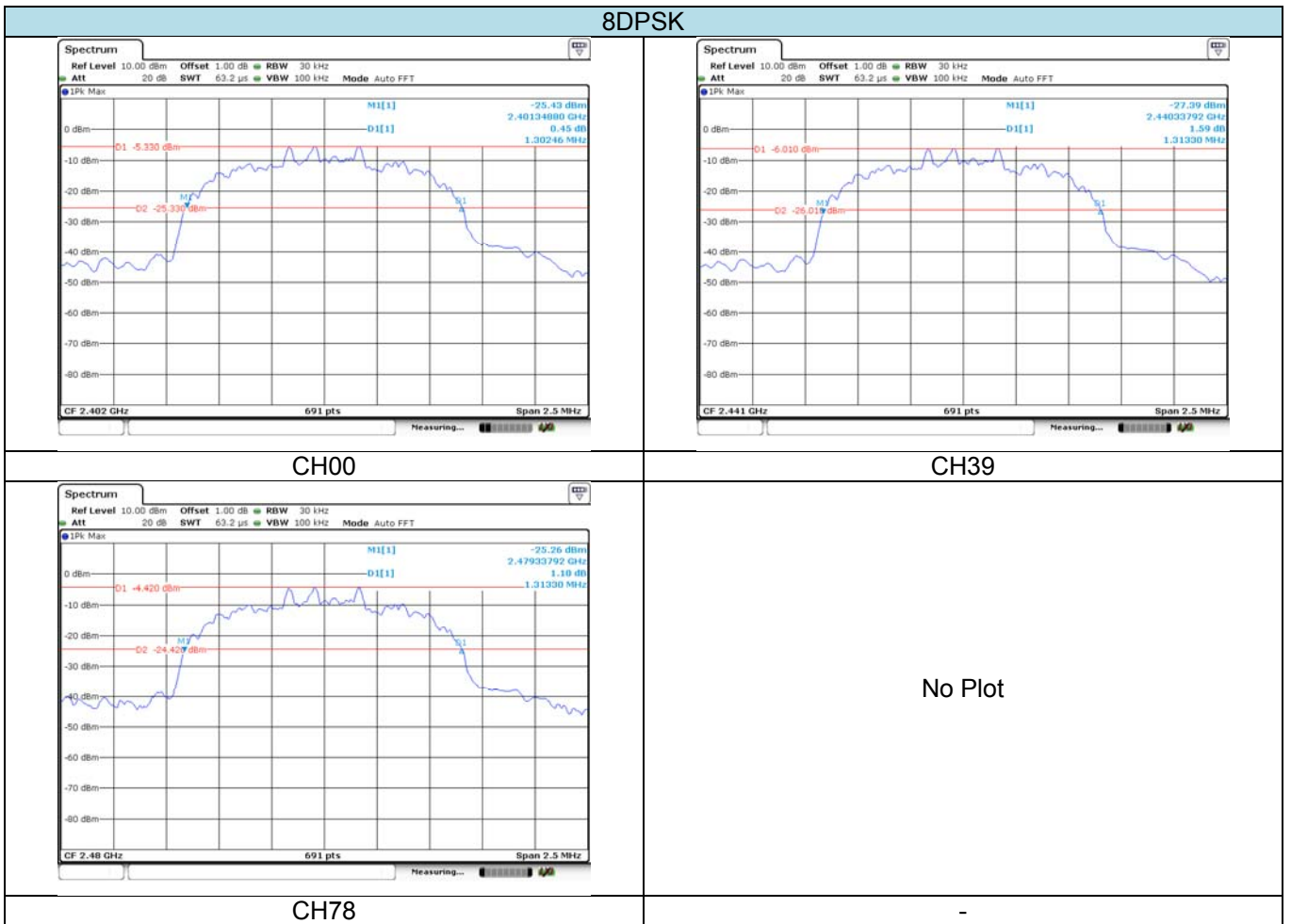

5.5. Carrier Frequencies Separation

LIMIT

FCC CFR Title 47 Part 15 Subpart C Section 15.247 (a)(1):
 frequency hopping systems shall have hopping channel carrier frequencies separated by minimum of 25 kHz or the 2/3*20 dB bandwidth of the hopping channel, whichever is greater.

TEST CONFIGURATION

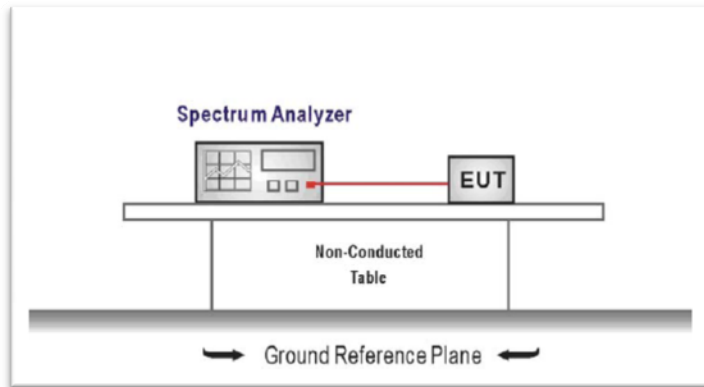

TEST PROCEDURE

1. The transmitter output was connected to the spectrum analyzer through an attenuator, the path loss was compensated to the results for each measurement.
2. Set to the maximum power setting and enable the EUT transmit continuously
3. Use the following spectrum analyzer settings:
 Span = wide enough to capture the peaks of two adjacent channels
 RBW ≥ 1% of the span, VBW ≥ RBW
 Sweep = auto, Detector function = peak, Trace = max hold
4. Measure and record the results in the test report.

TEST MODE:

Please refer to the clause 3.3

TEST RESULTS

Passed **Not Applicable**

Modulation type	Channel	Carrier Frequencies Separation (MHz)	Limit (MHz)	Result
GFSK	39	0.996	0.926	Pass
π/4DQPSK	39	1.001	0.880	Pass
8DPSK	39	1.001	0.876	Pass

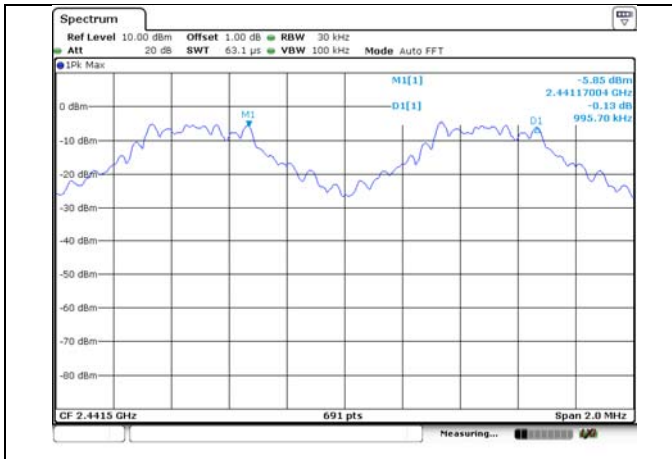

GFSK

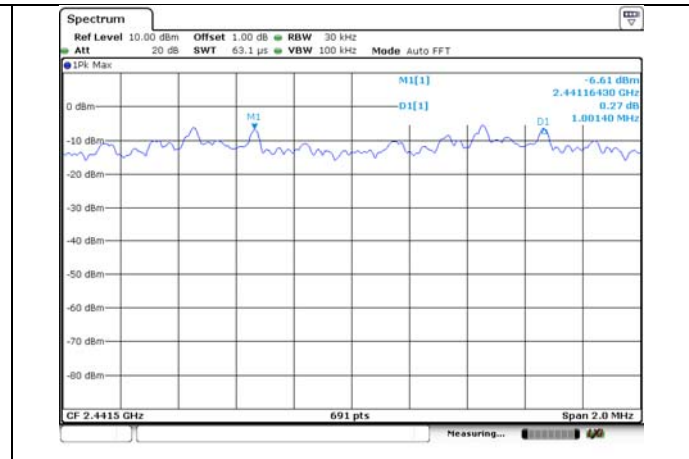

$\pi/4$ DQPSK

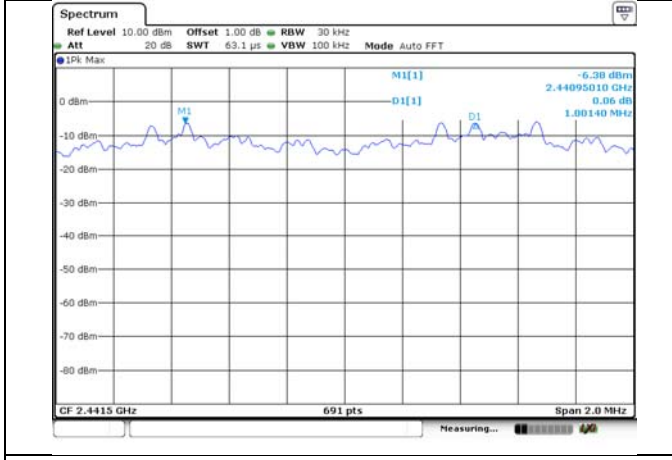

8DPSK

No Plot

5.6. Hopping Channel Number

LIMIT

FCC CFR Title 47 Part 15 Subpart C Section 15.247 (a)(1):
 Frequency hopping systems in the 2400–2483.5 MHz band shall use at least **15** channels.

TEST CONFIGURATION

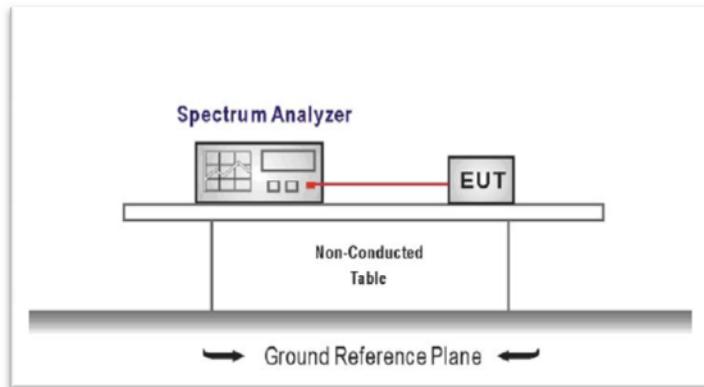

TEST PROCEDURE

1. The transmitter output was connected to the spectrum analyzer through an attenuator, the path loss was compensated to the results for each measurement.
2. Set to the maximum power setting and enable the EUT transmit continuously
3. Use the following spectrum analyzer settings:
 Span = the frequency band of operation
 RBW \geq 1% of the span, VBW \geq RBW
 Sweep = auto, Detector function = peak, Trace = max hold
4. Measure and record the results in the test report.

TEST MODE:

Please refer to the clause 3.3

TEST RESULTS

Passed **Not Applicable**

Modulation type	Channel number	Limit	Result
GFSK	79	15.00	Pass
$\pi/4$ DQPSK	79		
8DPSK	79		

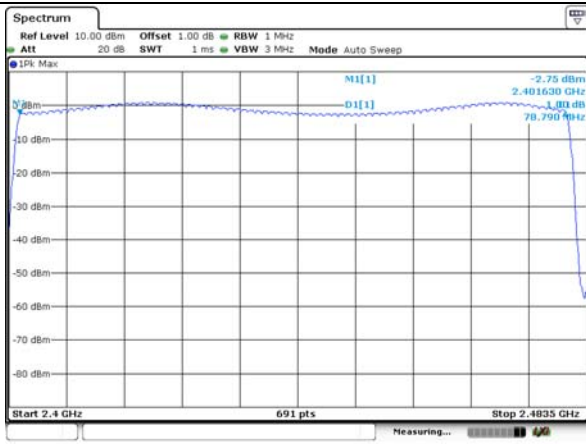

GFSK

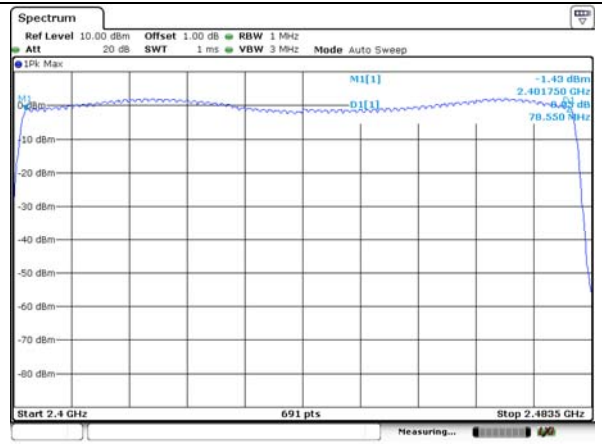

$\pi/4$ DQPSK

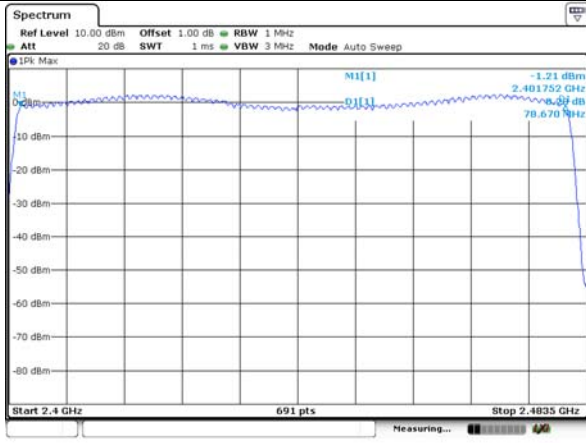

8DPSK

No Plot

5.7. Dwell Time

LIMIT

FCC CFR Title 47 Part 15 Subpart C Section 15.247 (a)(1):

The average time of occupancy on any channel shall not be greater than 0.4 seconds within a pe-riod of 0.4 seconds multiplied by the number of hopping channels employed.

TEST CONFIGURATION

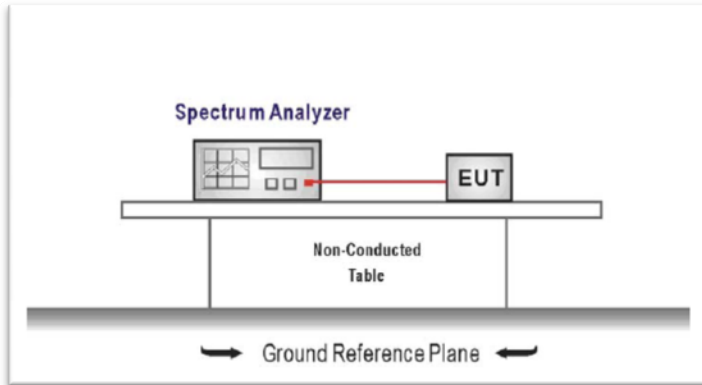

TEST PROCEDURE

1. The transmitter output was connected to the spectrum analyzer through an attenuator, the path loss was compensated to the results for each measurement.
2. Set to the maximum power setting and enable the EUT transmit continuously
3. Use the following spectrum analyzer settings:
 Span = zero span, centered on a hopping channel, RBW= 1 MHz, VBW ≥ RBW
 Sweep = as necessary to capture the entire dwell time per hopping channel,
 Detector function = peak, Trace = max hold
4. Measure and record the results in the test report.

TEST MODE:

Please refer to the clause 3.3

TEST RESULTS

Passed Not Applicable

Modulation type	Channel	Dwell time (Second)	Limit (Second)	Result
GFSK	DH1	0.125	0.40	Pass
	DH3	0.264		
	DH5	0.309		
π/4DQPSK	2-DH1	0.121	0.40	Pass
	2-DH3	0.260		
	2-DH5	0.306		
8DPSK	3-DH1	0.121	0.40	Pass
	3-DH3	0.257		
	3-DH5	0.308		

Note:

1. We have tested all mode at high,middle and low channel,and recoreded worst case at middle channel.
2. Dwell time=Pulse time (ms) × (1600 ÷ 2 ÷ 79) ×31.6 Second for DH1, 2-DH1, 3-DH1
 Dwell time=Pulse time (ms) × (1600 ÷ 4 ÷ 79) ×31.6 Second for DH3, 2-DH3, 3-DH3
 Dwell time=Pulse time (ms) × (1600 ÷ 6 ÷ 79) ×31.6 Second for DH5, 2-DH5, 3-DH5

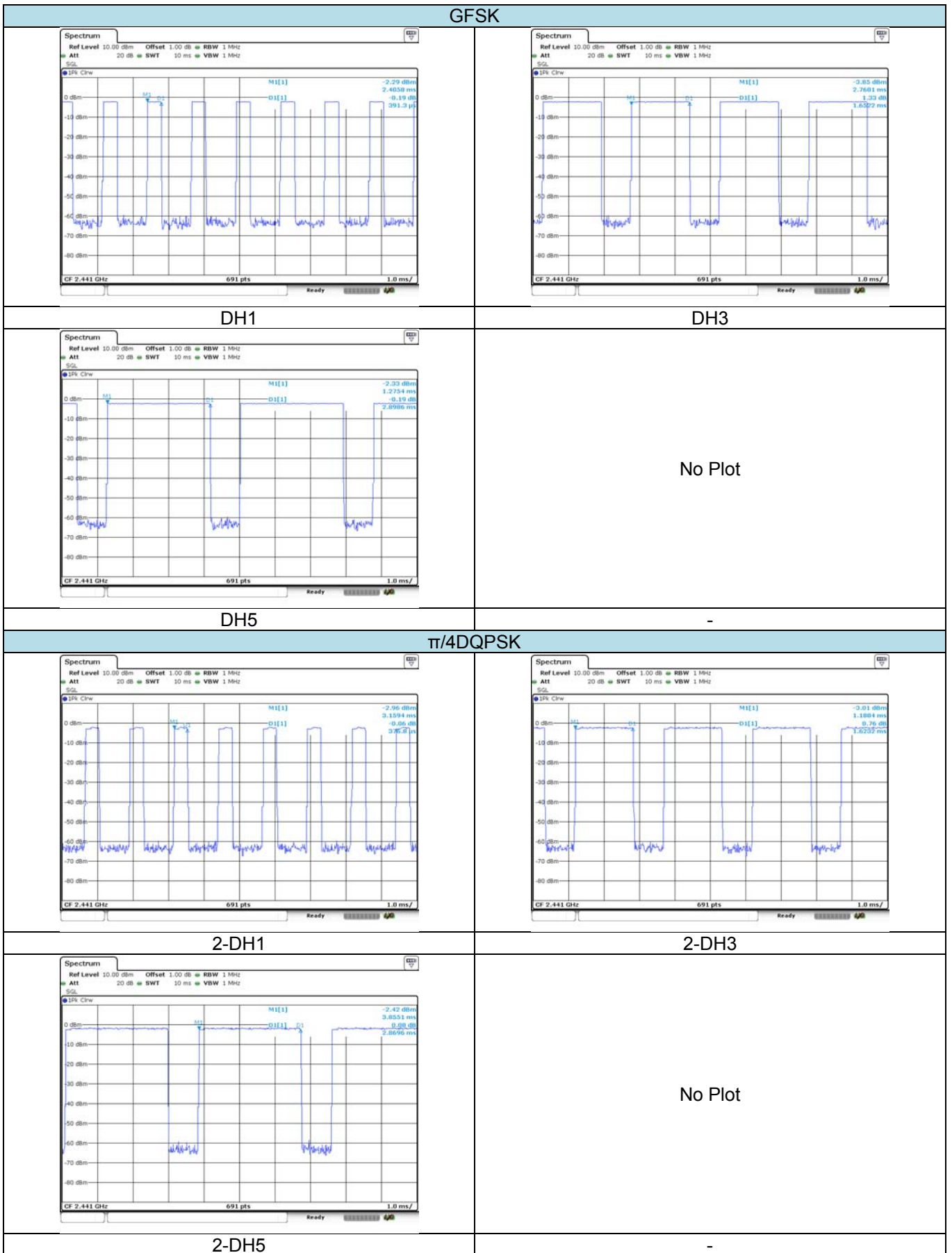

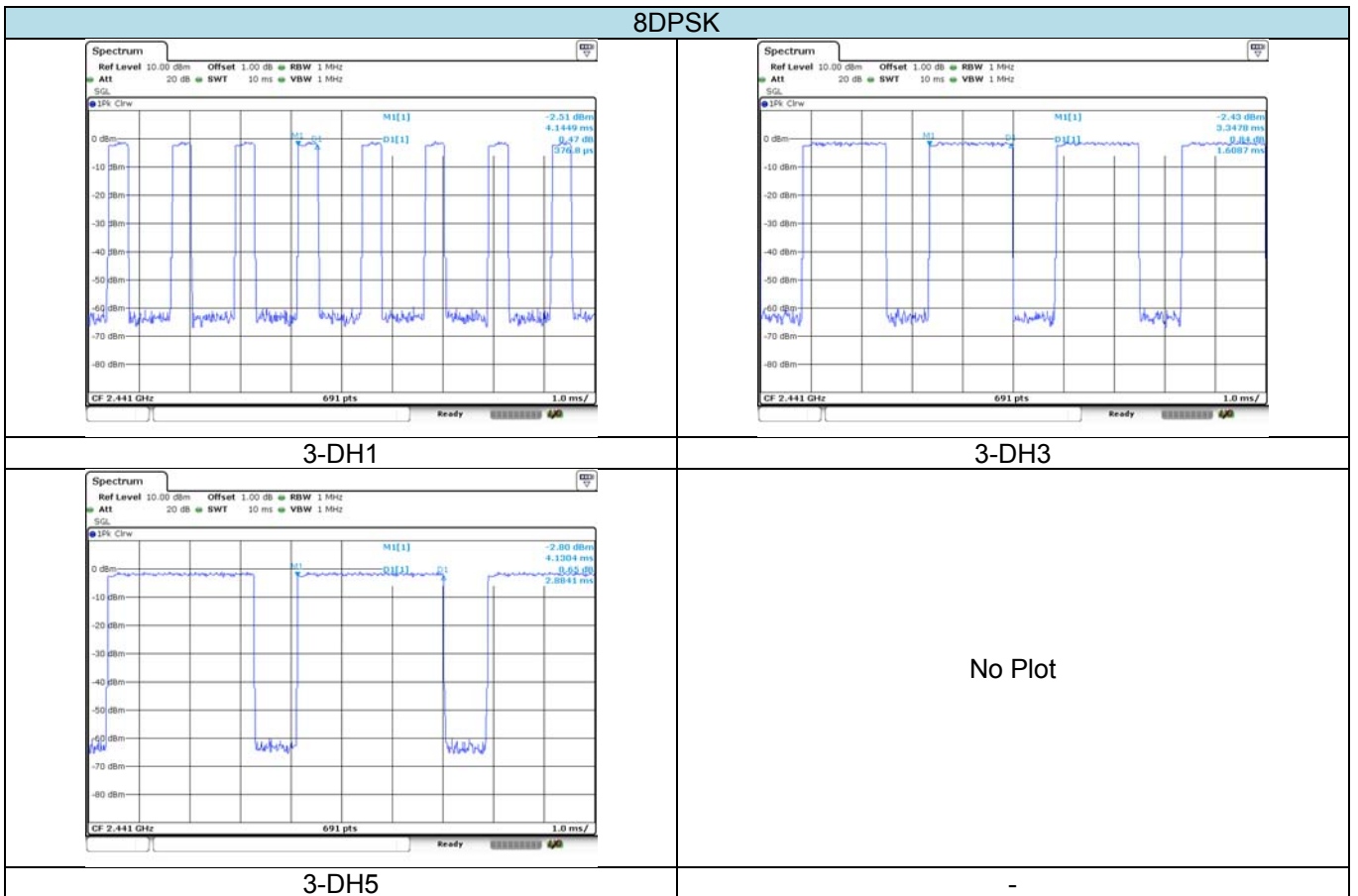

5.8. Pseudorandom Frequency Hopping Sequence

LIMIT

FCC CFR Title 47 Part 15 Subpart C Section 15.247 (a)(1):

Frequency hopping systems shall have hopping channel carrier frequencies separated by a minimum of 25 kHz or the 20 dB bandwidth of the hopping channel, whichever is greater. Alternatively, frequency hopping systems operating in the 2400–2483.5 MHz band may have hopping channel carrier frequencies that are separated by 25 kHz or two-thirds of the 20 dB bandwidth of the hopping channel, whichever is greater, provided the systems operate with an output power no greater than 125 mW. The system shall hop to channel frequencies that are selected at the system hopping rate from a pseudo-randomly ordered list of hopping frequencies. Each frequency must be used equally on the average by each transmitter. The system receivers shall have input bandwidths that match the hopping channel bandwidths of their corresponding transmitters and shall shift frequencies in synchronization with the transmitted signals.

TEST RESULTS

The pseudorandom frequency hopping sequence may be generated in a nine-stage shift register whose 5th and 9th stage outputs are added in a modulo-two addition stage. And the result is fed back to the input of the first stage. The sequence begins with the first one of 9 consecutive ones, for example: the shift register is initialized with nine ones.

- Number of shift register stages: 9
- Length of pseudo-random sequence: $2^9 - 1 = 511$ bits
- Longest sequence of zeros: 8 (non-inverted signal)

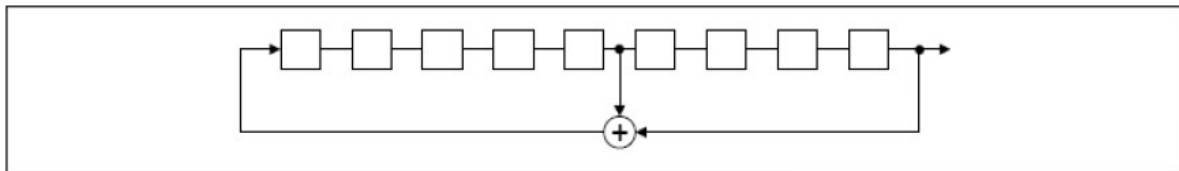

Linear Feedback Shift Register for Generation of the PRBS sequence

An example of pseudorandom frequency hopping sequence as follows:

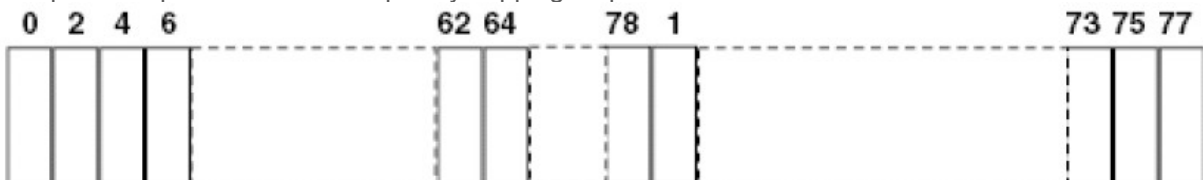

Each frequency used equally on the average by each transmitter. The system receiver has input bandwidths that match the hopping channel bandwidths of their corresponding transmitter and shift frequencies in synchronization with the transmitted signals.

5.9. Restricted band (radiated)

LIMIT

FCC CFR Title 47 Part 15 Subpart C Section 15.247 (d):

In any 100 kHz bandwidth outside the frequency band in which the spread spectrum or digitally modulated intentional radiator is operating, radiated emissions which fall in the restricted bands, as defined in §15.205(a), must also comply with the radiated emission limits specified in §15.209(a) (see §15.205(c)).

TEST CONFIGURATION

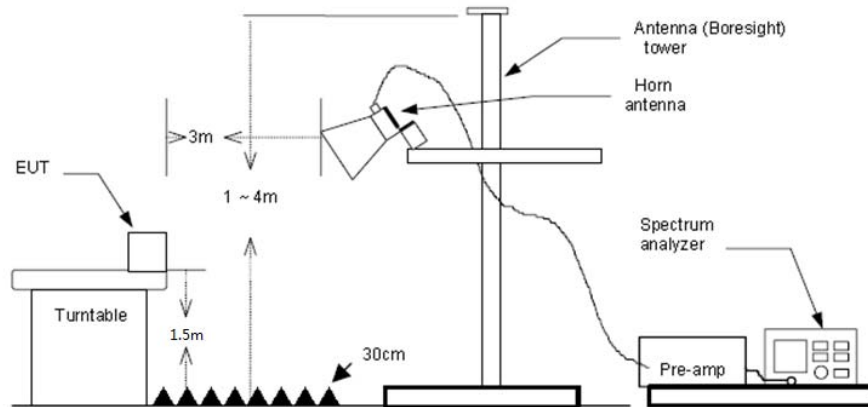

TEST PROCEDURE

1. The EUT was setup and tested according to ANSI C63.10:2013 for compliance to FCC 47CFR 15.247 requirements.
2. The EUT is placed on a turn table which is 1.5 meter above ground. The turn table is rotated 360 degrees to determine the position of the maximum emission level.
3. The EUT was positioned such that the distance from antenna to the EUT was 3 meters.
4. The antenna is scanned from 1 meter to 4 meters to find out the maximum emission level. This is repeated for both horizontal and vertical polarization of the antenna. In order to find the maximum emission, all of the interface cables were manipulated according to ANSI C63.10:2013 on radiated measurement.
5. The receiver set as follow:
 RBW=1 MHz, VBW=3 MHz for Peak value
 RBW=1 MHz, VBW=10 Hz for Average value.

TEST MODE:

Please refer to the clause 3.3

TEST RESULTS

Passed **Not Applicable**

Note:

- 1) Final level= Read level + Antenna Factor+ Cable Loss- Preamp Factor
- 2) Have pre-scan all modulation mode, found the GFSK modulation which it was worst case, so only the worst case's data on the test report.
- 3) The peak level is lower than average limit(54 dBuV/m), this data is the too weak instrument of signal is unable to test.

CH00									
Frequency (MHz)	Read Level (dBuV)	Antenna Factor (dB/m)	Cable Loss (dB)	Preamp Factor (dB)	Level (dBuV/m)	Limit Line (dBuV/m)	Margin Limit (dB)	Polarization	Test value
2310.00	34.73	28.05	6.62	37.65	31.75	74.00	-42.25	Vertical	Peak
2390.03	34.13	27.65	6.75	37.87	30.66	74.00	-43.34	Vertical	
2310.00	34.48	28.05	6.62	37.65	31.50	74.00	-42.50	Horizontal	
2390.03	35.39	27.65	6.75	37.87	31.92	74.00	-42.08	Horizontal	

CH78									
Frequency (MHz)	Read Level (dBuV)	Antenna Factor (dB/m)	Cable Loss (dB)	Preamp Factor (dB)	Level (dBuV/m)	Limit Line (dBuV/m)	Margin Limit (dB)	Polarization	Test value
2483.50	48.76	27.26	6.83	37.87	44.98	74.00	-29.02	Vertical	Peak
2500.00	33.52	27.20	6.84	37.87	29.69	74.00	-44.31	Vertical	
2483.50	49.05	27.26	6.83	37.87	45.27	74.00	-28.73	Horizontal	Peak
2500.00	33.90	27.20	6.84	37.87	30.07	74.00	-43.93	Horizontal	

5.10. Bandedge and Spurious Emission (conducted)

LIMIT

FCC CFR Title 47 Part 15 Subpart C Section 15.247 (d):

In any 100 kHz bandwidth outside the frequency band in which the spread spectrum intentional radiator is operating, the radio frequency power that is produced by the intentional radiator shall be at least 20 dB below that in the 100 kHz bandwidth within the band that contains the highest level of the desired power, based on either an RF conducted or a radiated measurement.

TEST CONFIGURATION

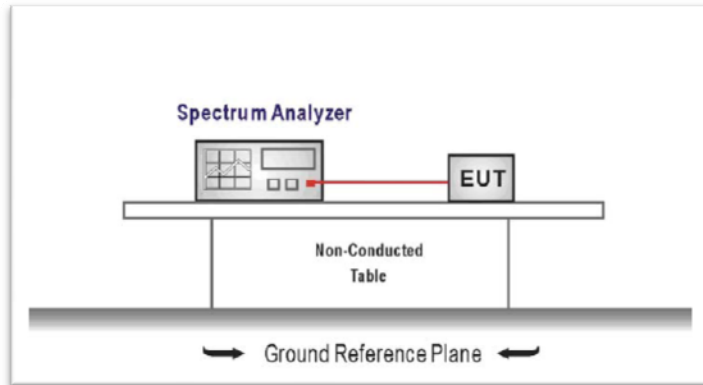

TEST PROCEDURE

1. The transmitter output was connected to the spectrum analyzer through an attenuator, the path loss was compensated to the results for each measurement.
2. Set to the maximum power setting and enable the EUT transmit continuously
3. Use the following spectrum analyzer settings:
RBW = 100 kHz, VBW \geq RBW
Sweep = auto, Detector function = peak, Trace = max hold
4. Measure and record the results in the test report.

TEST MODE:

Please refer to the clause 3.3

TEST RESULTS

Passed **Not Applicable**

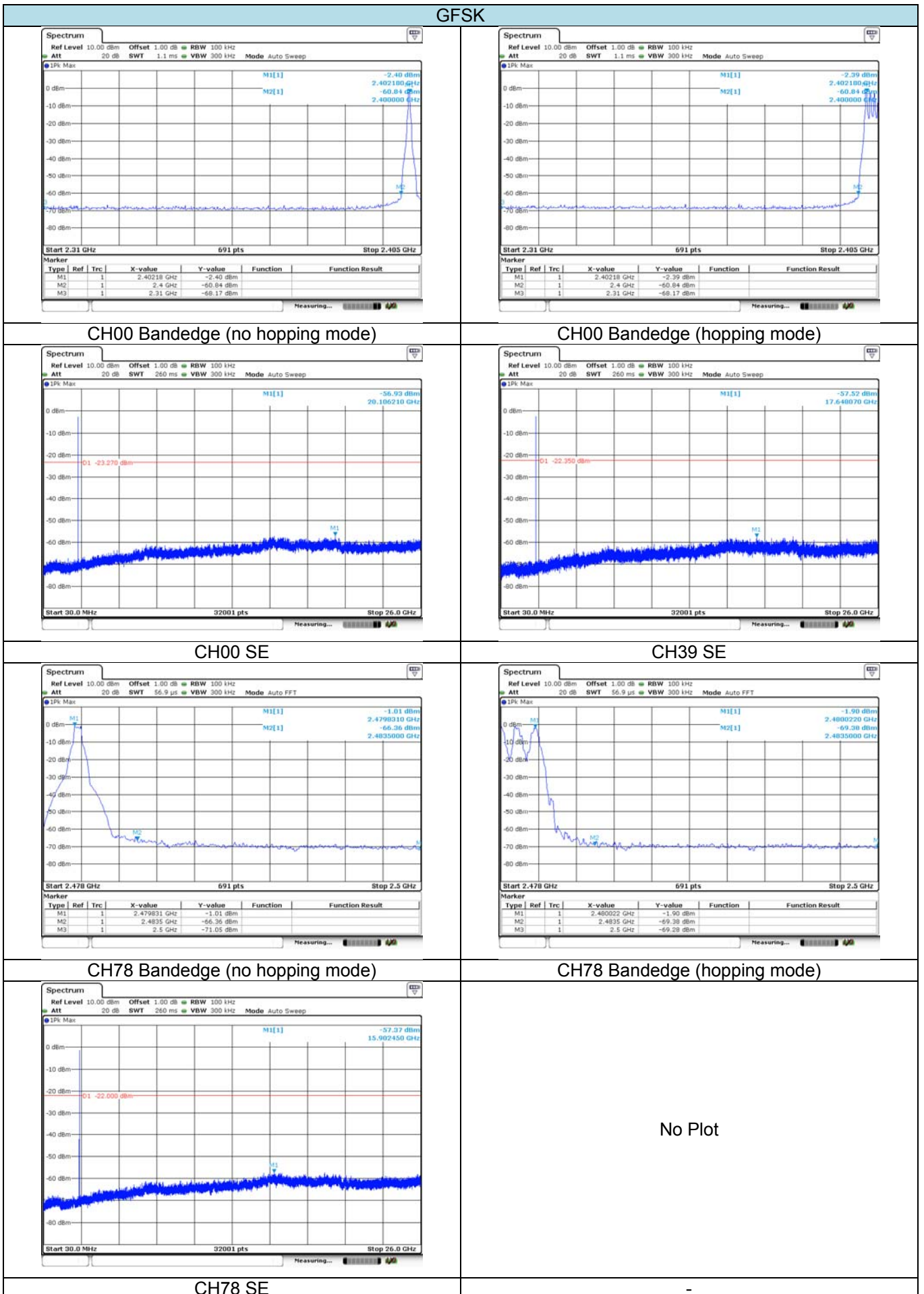

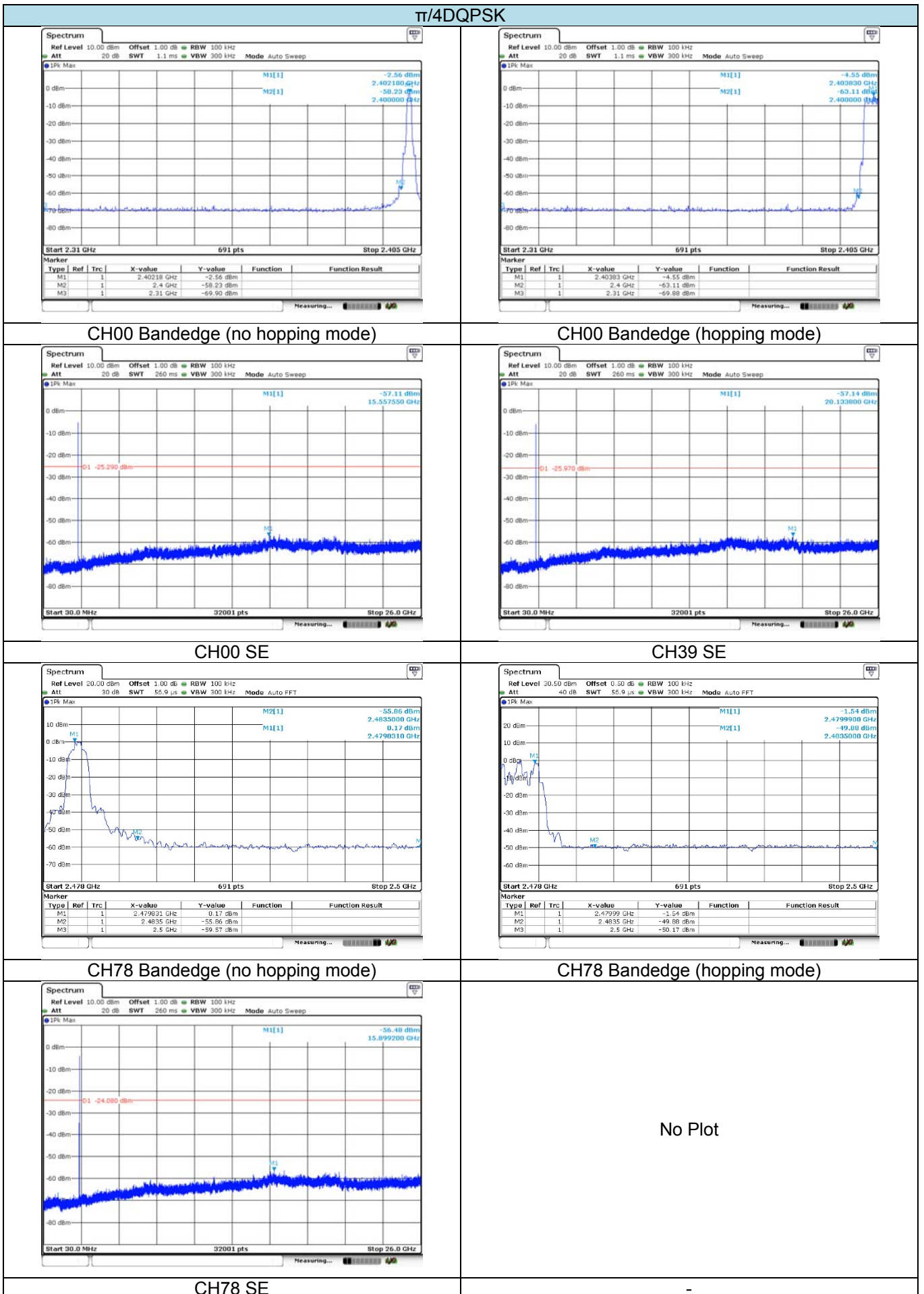

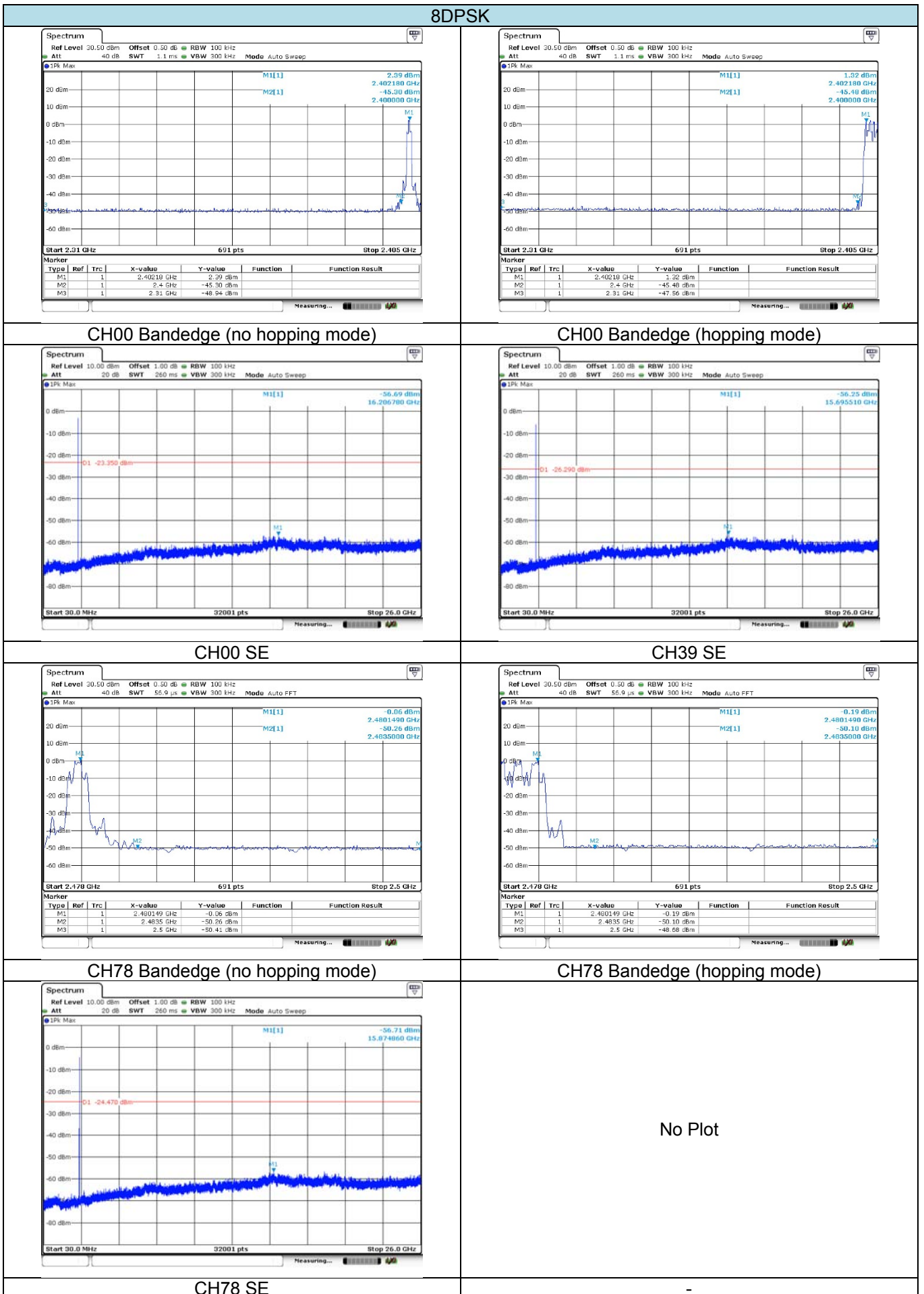

5.11. Spurious Emission (radiated)

LIMIT

FCC CFR Title 47 Part 15 Subpart C Section 15.209

Frequency	Limit (dBuV/m @3m)	Value
30 MHz ~ 88 MHz	40.00	Quasi-peak
88 MHz ~ 216 MHz	43.50	Quasi-peak
216 MHz ~ 960 MHz	46.00	Quasi-peak
960 MHz ~ 1 GHz	54.00	Quasi-peak
Above 1 GHz	54.00	Average
	74.00	Peak

TEST CONFIGURATION

➤ Below 30 MHz

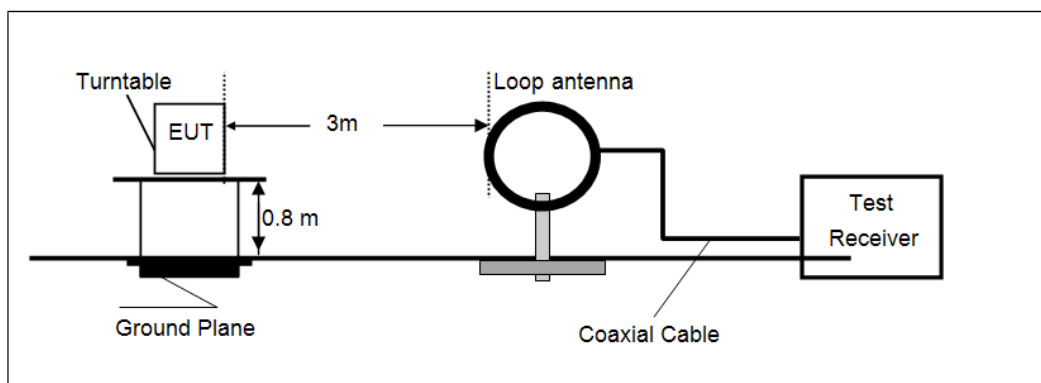

➤ 30 MHz ~1000 MHz

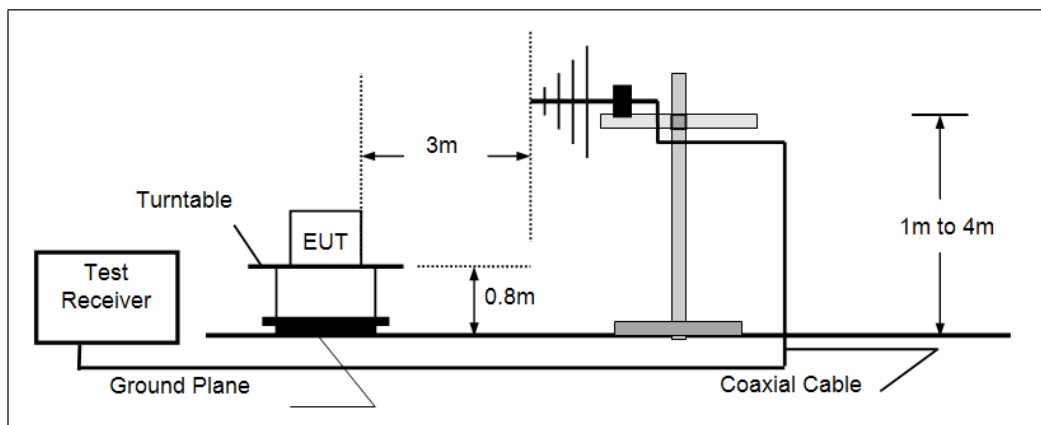

➤ Above 1 GHz

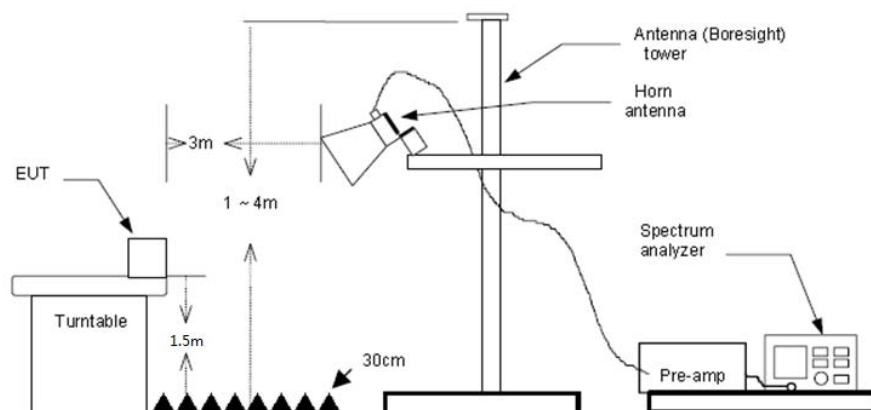

TEST PROCEDURE

1. The EUT was tested according to ANSI C63.10:2013 for compliance to FCC 47CFR 15.247 requirements.
2. The EUT is placed on a turn table which is 0.8 meter above ground. The turn table is rotated 360 degrees to determine the position of the maximum emission level.
3. The EUT was positioned such that the distance from antenna to the EUT was 3 meters.
4. The antenna is scanned from 1 meter to 4 meters to find out the maximum emission level. This is repeated for both horizontal and vertical polarization of the antenna.
5. Use the following spectrum analyzer settings
 - (1) Span shall wide enough to fully capture the emission being measured;
 - (2) Below 1 GHz, RBW=120 kHz, VBW=300 kHz, Sweep=auto, Detector function=peak, Trace=max hold; If the emission level of the EUT measured by the peak detector is 3 dB lower than the applicable limit, the peak emission level will be reported. Otherwise, the emission measurement will be repeated using the quasi-peak detector and reported.
 - (3) Above 1 GHz, RBW=1 MHz, VBW=3 MHz for Peak value
RBW=1 MHz, VBW=10 Hz for Average value.

TEST MODE:

Please refer to the clause 3.3

TEST RESULTS

Passed **Not Applicable**

Note:

- 1) Final Level = Receiver Read level + Antenna Factor + Cable Loss – Preamplifier Factor
- 2) The emission levels of other frequencies are very lower than the limit and not show in test report.
- 3) Below 1 GHz, Have pre-scan all modulation mode, found the GFSK modulation High channel which it was worst case, so only the worst case's data on the test report.
- 4) Above 1 GHz, Have pre-scan all modulation mode, found the GFSK modulation which it was worst case, so only the worst case's data on the test report
- 5) The peak level is lower than average limit (54 dBuV/m), this data is the too weak instrument of signal is unable to test.

➤ **9 kHz ~ 30 MHz**

The low frequency, which started from 9 kHz to 30 MHz, was pre-scanned and the result which was 20 dB lower than the limit line per 15.31(o) was not reported.

➤ 30 MHz ~ 1 GHz

Polarization: Vertical

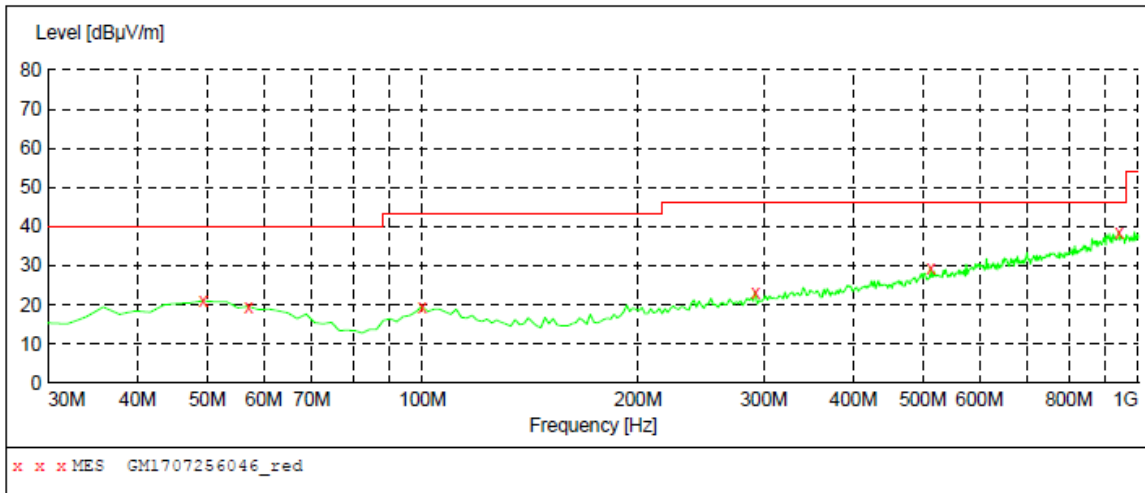

MEASUREMENT RESULT: "GM1707256046_red"

7/25/2017 2:26PM

Frequency MHz	Level dBuV/m	Transd dB	Limit dBuV/m	Margin dB	Det.	Height cm	Azimuth deg	Polarization
49.400000	21.10	-8.7	40.0	18.9	QP	100.0	193.00	VERTICAL
57.160000	19.60	-9.4	40.0	20.4	QP	100.0	193.00	VERTICAL
99.840000	19.60	-10.6	43.5	23.9	QP	100.0	278.00	VERTICAL
291.900000	23.30	-7.4	46.0	22.7	QP	100.0	325.00	VERTICAL
513.060000	29.50	-1.4	46.0	16.5	QP	100.0	55.00	VERTICAL
939.860000	38.70	7.2	46.0	7.3	QP	100.0	251.00	VERTICAL

Polarization: Horizontal

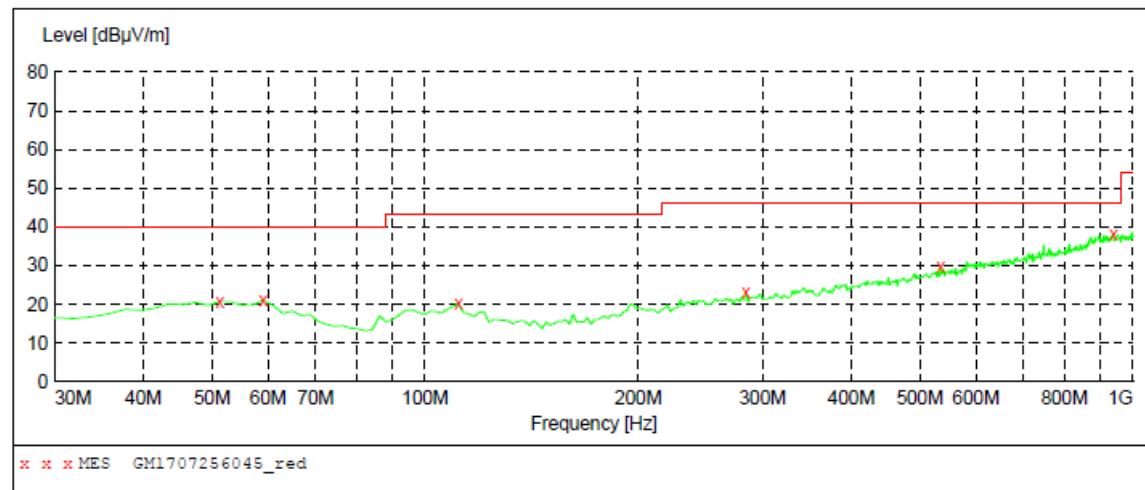

MEASUREMENT RESULT: "GM1707256045_red"

7/25/2017 2:24PM

Frequency MHz	Level dBuV/m	Transd dB	Limit dBuV/m	Margin dB	Det.	Height cm	Azimuth deg	Polarization
51.340000	20.80	-8.8	40.0	19.2	QP	300.0	14.00	HORIZONTAL
59.100000	21.10	-9.8	40.0	18.9	QP	100.0	86.00	HORIZONTAL
111.480000	20.20	-11.0	43.5	23.3	QP	100.0	331.00	HORIZONTAL
284.140000	23.10	-7.6	46.0	22.9	QP	100.0	342.00	HORIZONTAL
534.400000	29.70	-1.1	46.0	16.3	QP	100.0	234.00	HORIZONTAL
937.920000	38.20	7.1	46.0	7.8	QP	100.0	198.00	HORIZONTAL

➤ Above 1 GHz

CH00 for GFSK									
Frequency (MHz)	Read Level (dBuV)	Antenna Factor (dB/m)	Cable Loss (dB)	Preamp Factor (dB)	Level (dBuV/m)	Limit Line (dBuV/m)	Margin Limit (dB)	Polarization	Test value
1195.05	37.78	26.26	4.65	36.57	32.12	74.00	-41.88	Vertical	Peak
3507.65	36.40	29.02	8.13	38.40	35.15	74.00	-38.85	Vertical	
4809.50	41.58	31.58	9.55	36.93	45.78	74.00	-28.22	Vertical	
9181.20	32.79	38.53	13.48	35.71	49.09	74.00	-24.91	Vertical	
1424.51	36.55	25.87	5.07	36.49	31.00	74.00	-43.00	Horizontal	Peak
3854.08	35.70	29.65	8.58	38.20	35.73	74.00	-38.27	Horizontal	
4809.50	41.58	31.58	9.55	36.93	45.78	74.00	-28.22	Horizontal	
7338.62	32.07	36.30	12.01	34.90	45.48	74.00	-28.52	Horizontal	

CH39 for GFSK									
Frequency (MHz)	Read Level (dBuV)	Antenna Factor (dB/m)	Cable Loss (dB)	Preamp Factor (dB)	Level (dBuV/m)	Limit Line (dBuV/m)	Margin Limit (dB)	Polarization	Test value
1450.12	34.52	25.85	5.14	36.53	28.98	74.00	-45.02	Vertical	Peak
2140.66	36.18	27.03	6.39	37.33	32.27	74.00	-41.73	Vertical	
3834.51	36.02	29.63	8.55	38.21	35.99	74.00	-38.01	Vertical	
7319.96	31.97	36.30	11.99	34.92	45.34	74.00	-28.66	Vertical	
1487.51	36.69	25.81	5.25	36.57	31.18	74.00	-42.82	Horizontal	Peak
4202.50	34.08	30.01	8.94	37.65	35.38	74.00	-38.62	Horizontal	
4883.52	35.07	31.43	9.59	36.73	39.36	74.00	-34.64	Horizontal	
6833.77	33.66	34.24	11.64	34.96	44.58	74.00	-29.42	Horizontal	

CH78 for GFSK									
Frequency (MHz)	Read Level (dBuV)	Antenna Factor (dB/m)	Cable Loss (dB)	Preamp Factor (dB)	Level (dBuV/m)	Limit Line (dBuV/m)	Margin Limit (dB)	Polarization	Test value
1529.75	36.98	25.53	5.37	36.63	31.25	74.00	-42.75	Vertical	Peak
4034.78	34.81	29.77	8.81	38.03	35.36	74.00	-38.64	Vertical	
4958.68	42.23	31.46	9.64	36.52	46.81	74.00	-27.19	Vertical	
7027.82	30.91	35.38	11.85	34.83	43.31	74.00	-30.69	Vertical	
1364.18	37.03	26.00	4.94	36.48	31.49	74.00	-42.51	Horizontal	Peak
4086.46	35.65	29.87	8.85	37.91	36.46	74.00	-37.54	Horizontal	
4958.68	38.07	31.46	9.64	36.52	42.65	74.00	-31.35	Horizontal	
7547.01	32.50	36.15	12.55	34.94	46.26	74.00	-27.74	Horizontal	

6. Test Setup Photos of the EUT

Conducted Emission (AC Mains)



Radiated Emission



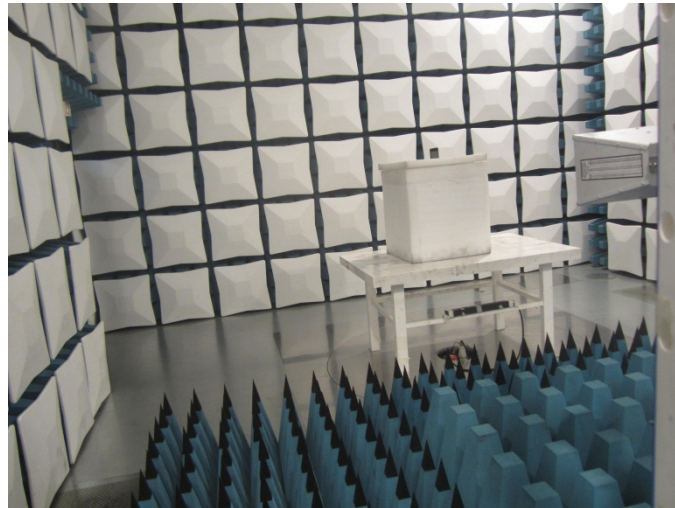

7. External and Internal Photos of the EUT

Reference to Test Report No.: TRE1707003001.

.....**End of Report**.....