

GFSK

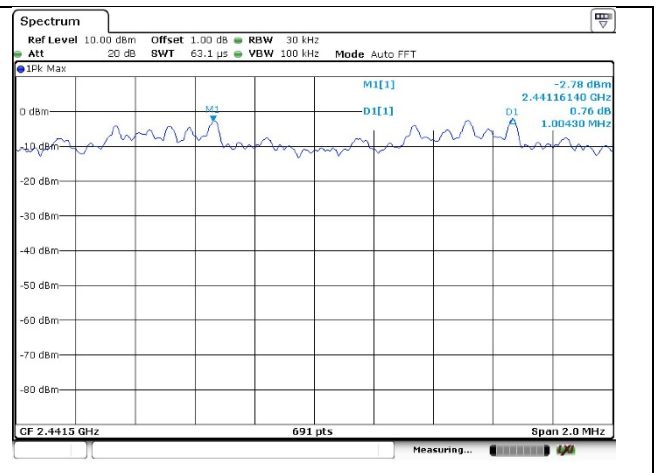

$\pi/4$ DQPSK

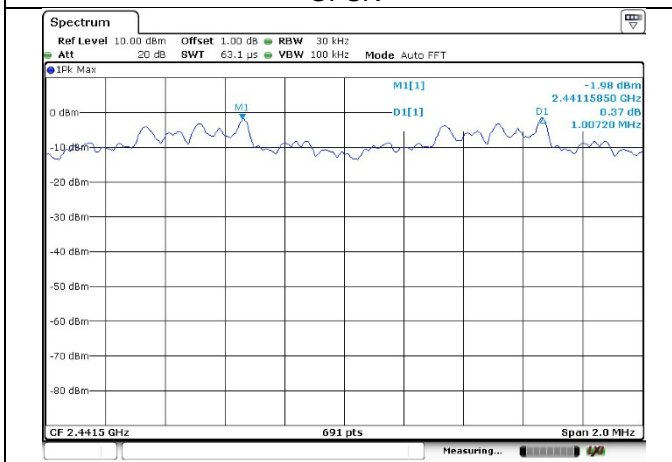

8DPSK

No Plot

5.6. Hopping Channel Number

LIMIT

FCC CFR Title 47 Part 15 Subpart C Section 15.247 (a)(1):
 Frequency hopping systems in the 2400–2483.5 MHz band shall use at least **15** channels.

TEST CONFIGURATION

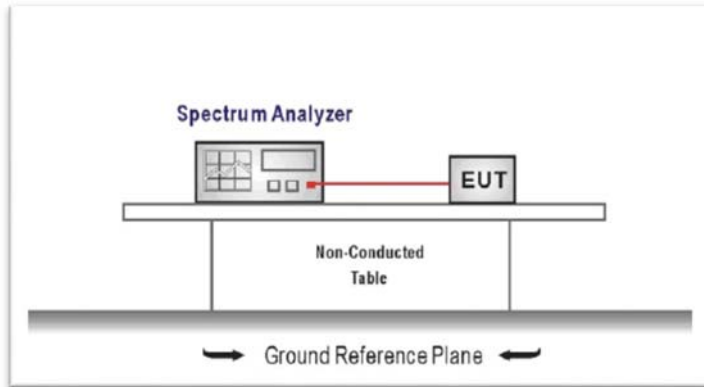

TEST PROCEDURE

1. The transmitter output was connected to the spectrum analyzer through an attenuator, the path loss was compensated to the results for each measurement.
2. Set to the maximum power setting and enable the EUT transmit continuously
3. Use the following spectrum analyzer settings:
 Span = the frequency band of operation
 RBW \geq 1% of the span, VBW \geq RBW
 Sweep = auto, Detector function = peak, Trace = max hold
4. Measure and record the results in the test report.

TEST MODE:

Please refer to the clause 3.3

TEST RESULTS

Passed **Not Applicable**

Modulation type	Channel number	Limit	Result
GFSK	79	15.00	Pass
$\pi/4$ DQPSK	79		
8DPSK	79		

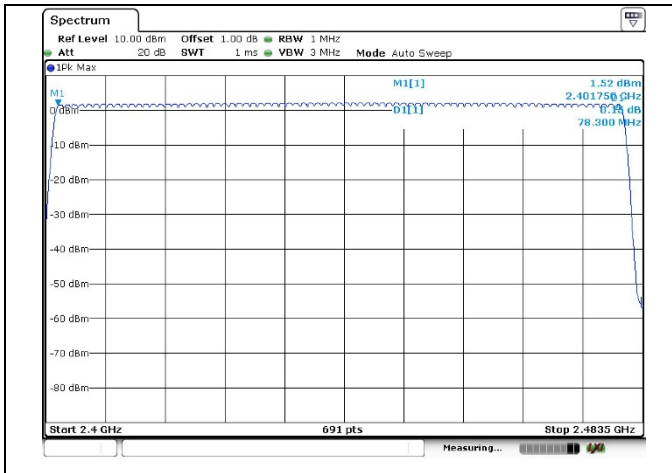

GFSK

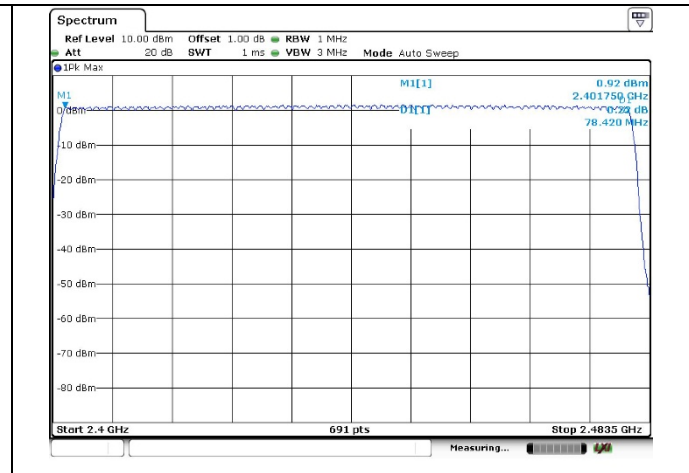

$\pi/4$ DQPSK

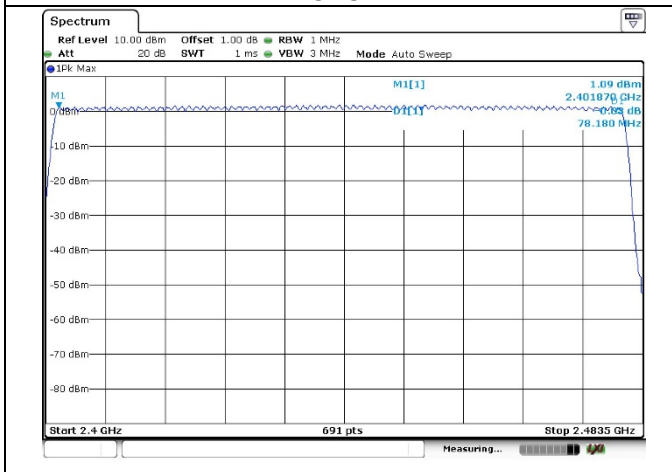

8DPSK

No Plot

5.7. Dwell Time

LIMIT

FCC CFR Title 47 Part 15 Subpart C Section 15.247 (a)(1):

The average time of occupancy on any channel shall not be greater than 0.4 seconds within a pe-riod of 0.4 seconds multiplied by the number of hopping channels employed.

TEST CONFIGURATION

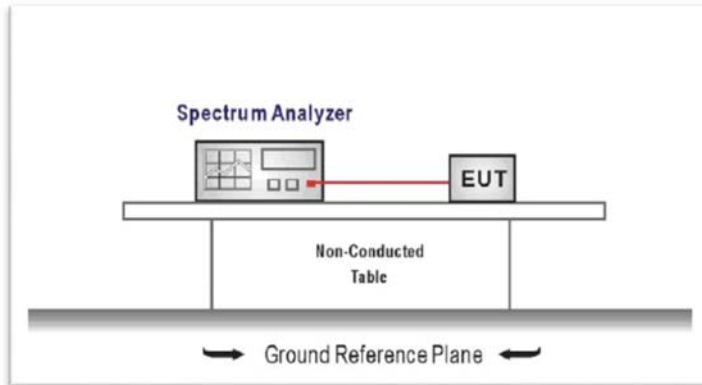

TEST PROCEDURE

1. The transmitter output was connected to the spectrum analyzer through an attenuator, the path loss was compensated to the results for each measurement.
2. Set to the maximum power setting and enable the EUT transmit continuously
3. Use the following spectrum analyzer settings:
 Span = zero span, centered on a hopping channel, RBW= 1 MHz, VBW ≥ RBW
 Sweep = as necessary to capture the entire dwell time per hopping channel,
 Detector function = peak, Trace = max hold
4. Measure and record the results in the test report.

TEST MODE:

Please refer to the clause 3.3

TEST RESULTS

Passed Not Applicable

Modulation type	Channel	Dwell time (Second)	Limit (Second)	Result
GFSK	DH1	0.116	0.40	Pass
	DH3	0.260		
	DH5	0.306		
π/4DQPSK	2-DH1	0.121	0.40	Pass
	2-DH3	0.257		
	2-DH5	0.308		
8DPSK	3-DH1	0.121	0.40	Pass
	3-DH3	0.262		
	3-DH5	0.306		

Note:

1. We have tested all mode at high,middle and low channel,and recoreded worst case at middle channel.
2. Dwell time=Pulse time (ms) × (1600 ÷ 2 ÷ 79) ×31.6 Second for DH1, 2-DH1, 3-DH1
 Dwell time=Pulse time (ms) × (1600 ÷ 4 ÷ 79) ×31.6 Second for DH3, 2-DH3, 3-DH3
 Dwell time=Pulse time (ms) × (1600 ÷ 6 ÷ 79) ×31.6 Second for DH5, 2-DH5, 3-DH5

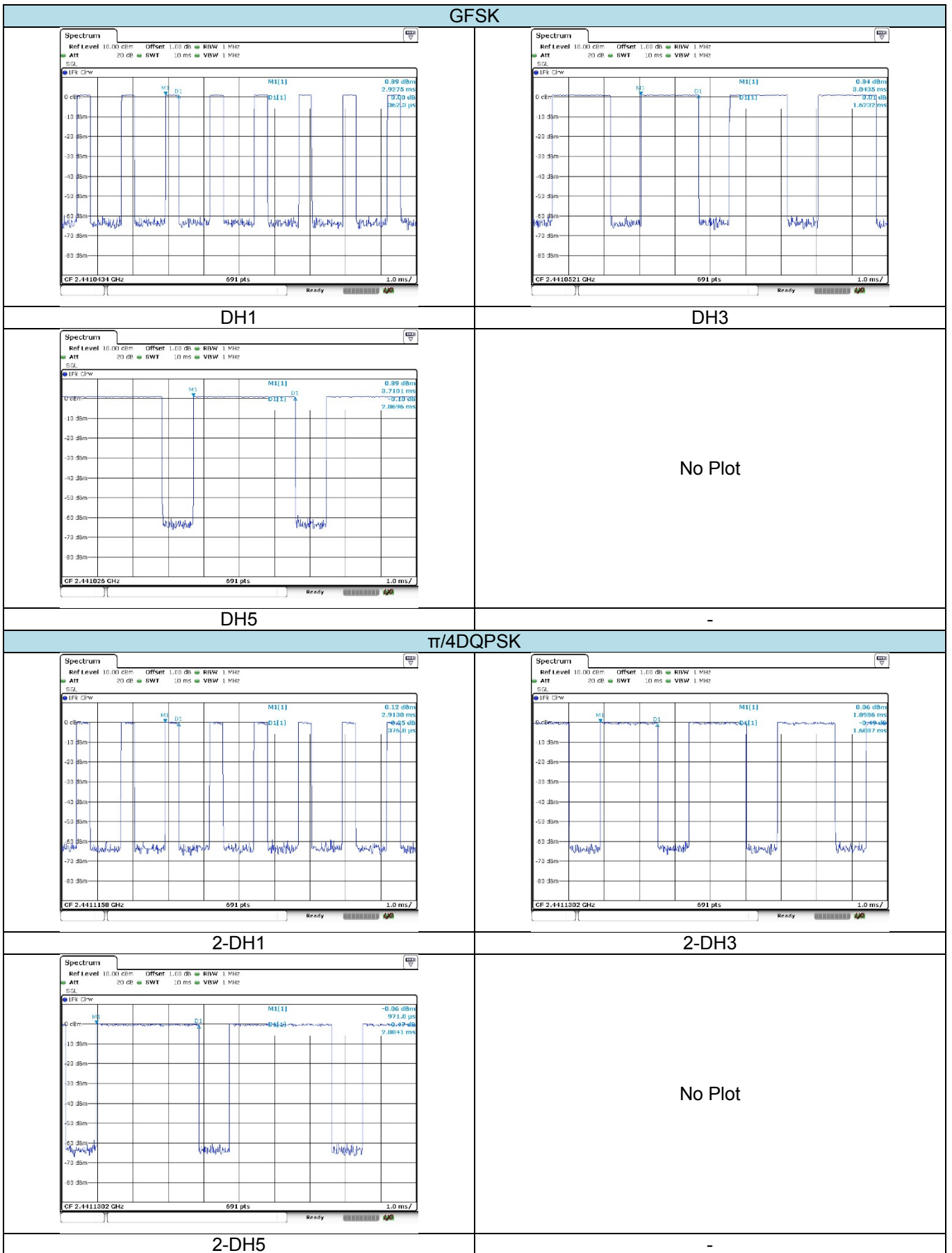

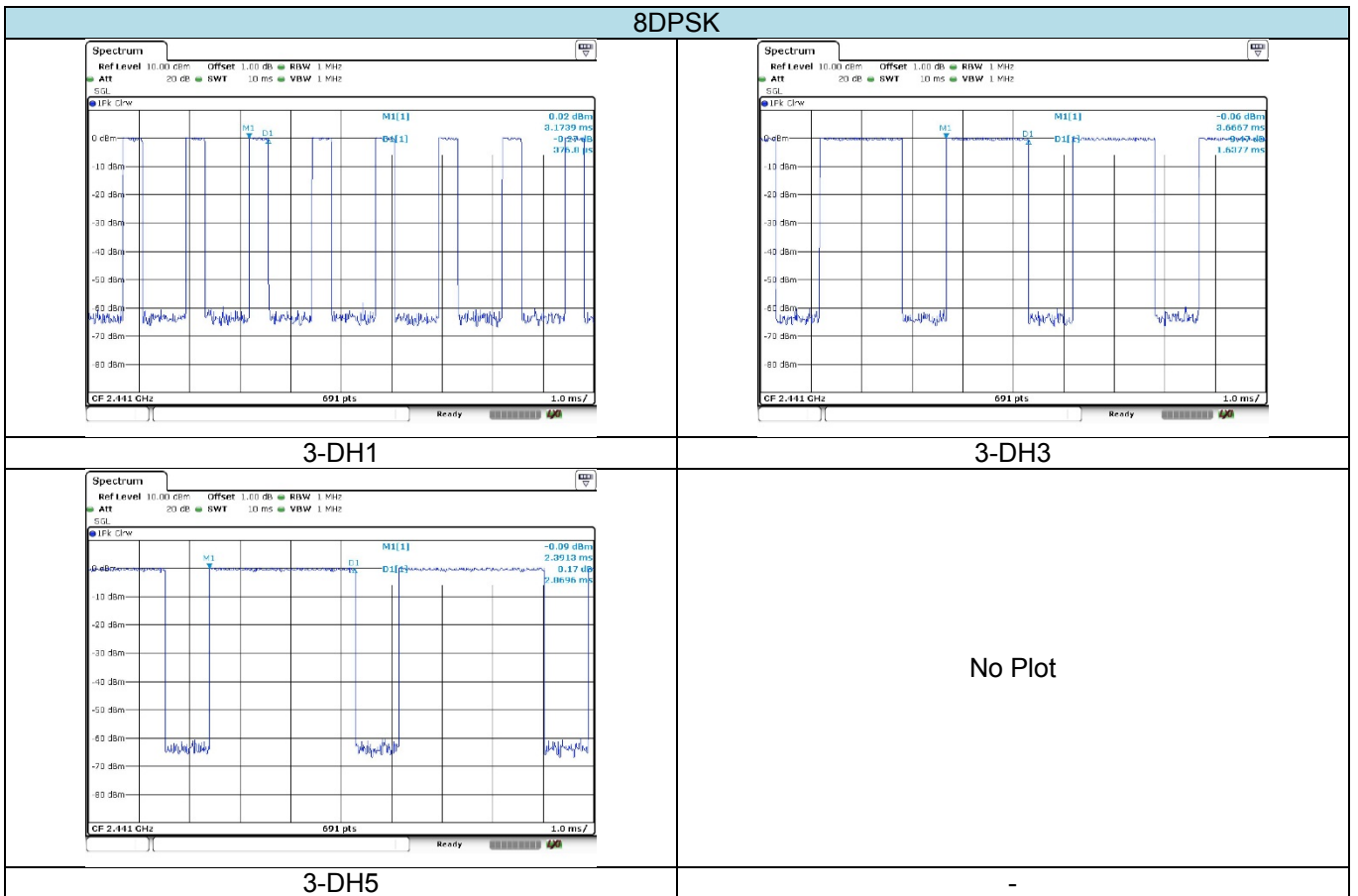

5.8. Pseudorandom Frequency Hopping Sequence

LIMIT

FCC CFR Title 47 Part 15 Subpart C Section 15.247 (a)(1):

Frequency hopping systems shall have hopping channel carrier frequencies separated by a minimum of 25 kHz or the 20 dB bandwidth of the hopping channel, whichever is greater. Alternatively, frequency hopping systems operating in the 2400–2483.5 MHz band may have hopping channel carrier frequencies that are separated by 25 kHz or two-thirds of the 20 dB bandwidth of the hopping channel, whichever is greater, provided the systems operate with an output power no greater than 125 mW. The system shall hop to channel frequencies that are selected at the system hopping rate from a pseudo-randomly ordered list of hopping frequencies. Each frequency must be used equally on the average by each transmitter. The system receivers shall have input bandwidths that match the hopping channel bandwidths of their corresponding transmitters and shall shift frequencies in synchronization with the transmitted signals.

TEST RESULTS

The pseudorandom frequency hopping sequence may be generated in a nine-stage shift register whose 5th and 9th stage outputs are added in a modulo-two addition stage. And the result is fed back to the input of the first stage. The sequence begins with the first one of 9 consecutive ones, for example: the shift register is initialized with nine ones.

- Number of shift register stages: 9
- Length of pseudo-random sequence: $2^9 - 1 = 511$ bits
- Longest sequence of zeros: 8 (non-inverted signal)

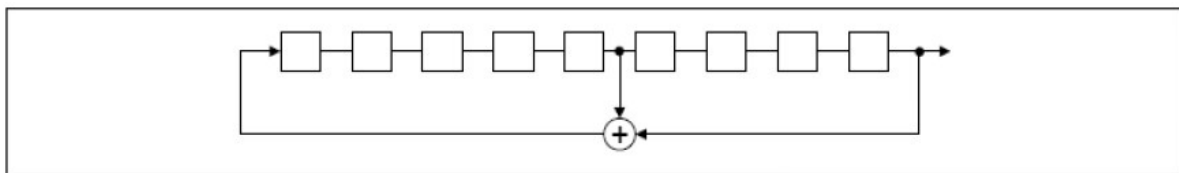

Linear Feedback Shift Register for Generation of the PRBS sequence

An example of pseudorandom frequency hopping sequence as follows:

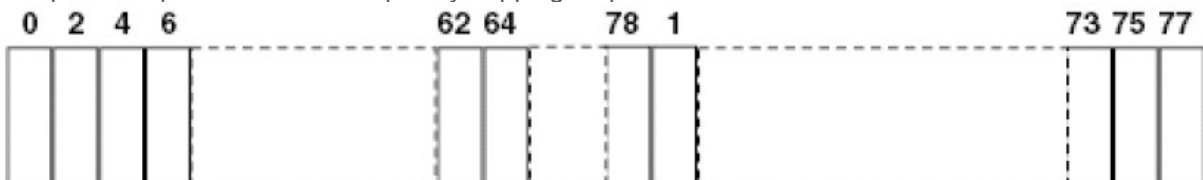

Each frequency used equally on the average by each transmitter. The system receiver has input bandwidths that match the hopping channel bandwidths of their corresponding transmitter and shift frequencies in synchronization with the transmitted signals.

5.9. Restricted band (radiated)

LIMIT

FCC CFR Title 47 Part 15 Subpart C Section 15.247 (d):

In any 100 kHz bandwidth outside the frequency band in which the spread spectrum or digitally modulated intentional radiator is operating, radiated emissions which fall in the restricted bands, as defined in §15.205(a), must also comply with the radiated emission limits specified in §15.209(a) (see §15.205(c)).

TEST CONFIGURATION

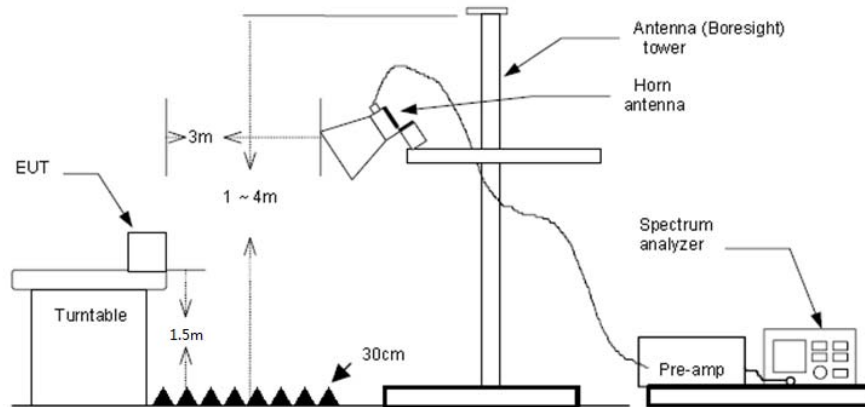

TEST PROCEDURE

1. The EUT was setup and tested according to ANSI C63.10:2013 for compliance to FCC 47CFR 15.247 requirements.
2. The EUT is placed on a turn table which is 1.5 meter above ground. The turn table is rotated 360 degrees to determine the position of the maximum emission level.
3. The EUT was positioned such that the distance from antenna to the EUT was 3 meters.
4. The antenna is scanned from 1 meter to 4 meters to find out the maximum emission level. This is repeated for both horizontal and vertical polarization of the antenna. In order to find the maximum emission, all of the interface cables were manipulated according to ANSI C63.10:2013 on radiated measurement.
5. The receiver set as follow:
 RBW=1 MHz, VBW=3 MHz for Peak value
 RBW=1 MHz, VBW=10 Hz for Average value.

TEST MODE:

Please refer to the clause 3.3

TEST RESULTS

Passed **Not Applicable**

Note:

- 1) Final level= Read level + Antenna Factor+ Cable Loss- Preamp Factor
- 2) Have pre-scan all modulation mode, found the GFSK modulation which it was worst case, so only the worst case's data on the test report.
- 3) The peak level is lower than average limit(54 dBuV/m), this data is the too weak instrument of signal is unable to test.

CH00									
Frequency (MHz)	Read Level (dBuV)	Antenna Factor (dB/m)	Cable Loss (dB)	Preamp Factor (dB)	Level (dBuV/m)	Limit Line (dBuV/m)	Margin Limit (dB)	Polarization	Test value
2310.00	35.76	28.05	6.62	37.65	32.78	74.00	-41.22	Vertical	Peak
2390.00	60.86	27.65	6.75	37.87	57.39	74.00	-16.61	Vertical	
2310.00	35.46	28.05	6.62	37.65	32.48	74.00	-41.52	Vertical	Average
2390.00	64.36	27.65	6.75	37.87	60.89	74.00	-13.11	Vertical	
2310.00	24.48	28.05	6.62	37.65	21.50	54.00	-32.50	Horizontal	Peak
2390.00	24.17	27.65	6.75	37.87	20.70	54.00	-33.30	Horizontal	
2310.00	23.77	28.05	6.62	37.65	20.79	54.00	-33.21	Horizontal	Average
2390.00	23.29	27.65	6.75	37.87	19.82	54.00	-34.18	Horizontal	

CH78									
Frequency (MHz)	Read Level (dBuV)	Antenna Factor (dB/m)	Cable Loss (dB)	Preamp Factor (dB)	Level (dBuV/m)	Limit Line (dBuV/m)	Margin Limit (dB)	Polarization	Test value
2483.50	58.57	27.26	6.83	37.87	54.79	74.00	-19.21	Vertical	Peak
2500.00	35.42	27.20	6.84	37.87	31.59	74.00	-42.41	Vertical	
2483.50	56.38	27.26	6.83	37.87	52.60	74.00	-21.40	Vertical	Average
2500.00	51.41	27.20	6.84	37.87	47.58	74.00	-26.42	Vertical	
2483.50	30.03	27.26	6.83	37.87	26.25	54.00	-27.75	Horizontal	Peak
2500.00	23.44	27.20	6.84	37.87	19.61	54.00	-34.39	Horizontal	
2483.50	31.71	27.26	6.83	37.87	27.93	54.00	-26.07	Horizontal	Average
2500.00	23.76	27.20	6.84	37.87	19.93	54.00	-34.07	Horizontal	

5.10. Bandedge and Spurious Emission (conducted)

LIMIT

FCC CFR Title 47 Part 15 Subpart C Section 15.247 (d):

In any 100 kHz bandwidth outside the frequency band in which the spread spectrum intentional radiator is operating, the radio frequency power that is produced by the intentional radiator shall be at least 20 dB below that in the 100 kHz bandwidth within the band that contains the highest level of the desired power, based on either an RF conducted or a radiated measurement.

TEST CONFIGURATION

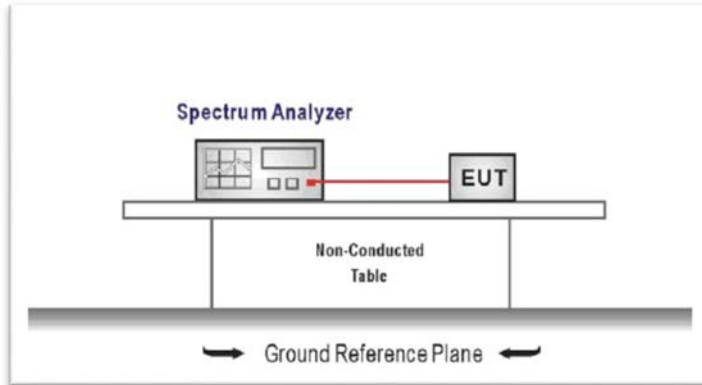

TEST PROCEDURE

1. The transmitter output was connected to the spectrum analyzer through an attenuator, the path loss was compensated to the results for each measurement.
2. Set to the maximum power setting and enable the EUT transmit continuously
3. Use the following spectrum analyzer settings:
RBW = 100 kHz, VBW \geq RBW
Sweep = auto, Detector function = peak, Trace = max hold
4. Measure and record the results in the test report.

TEST MODE:

Please refer to the clause 3.3

TEST RESULTS

Passed **Not Applicable**

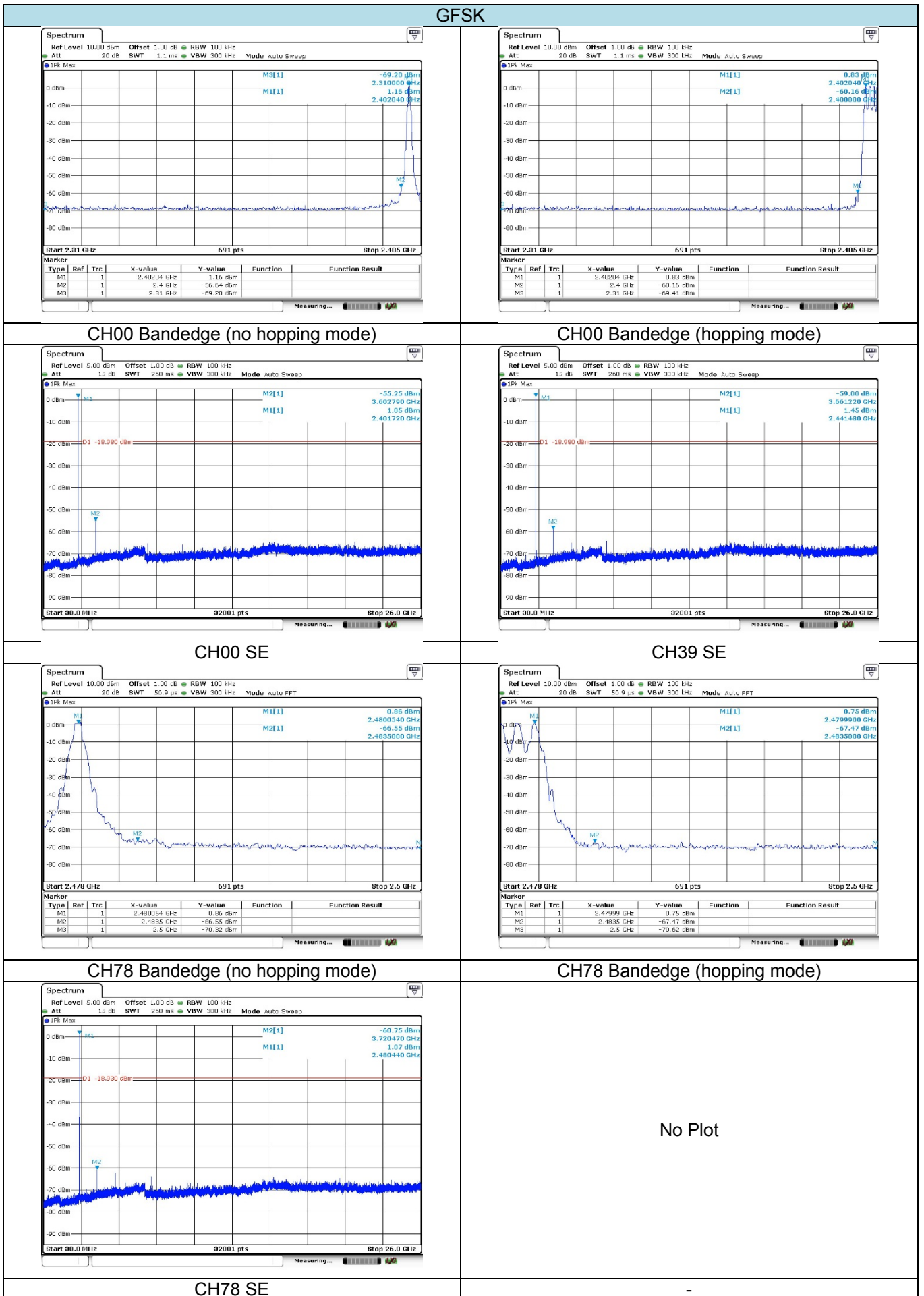

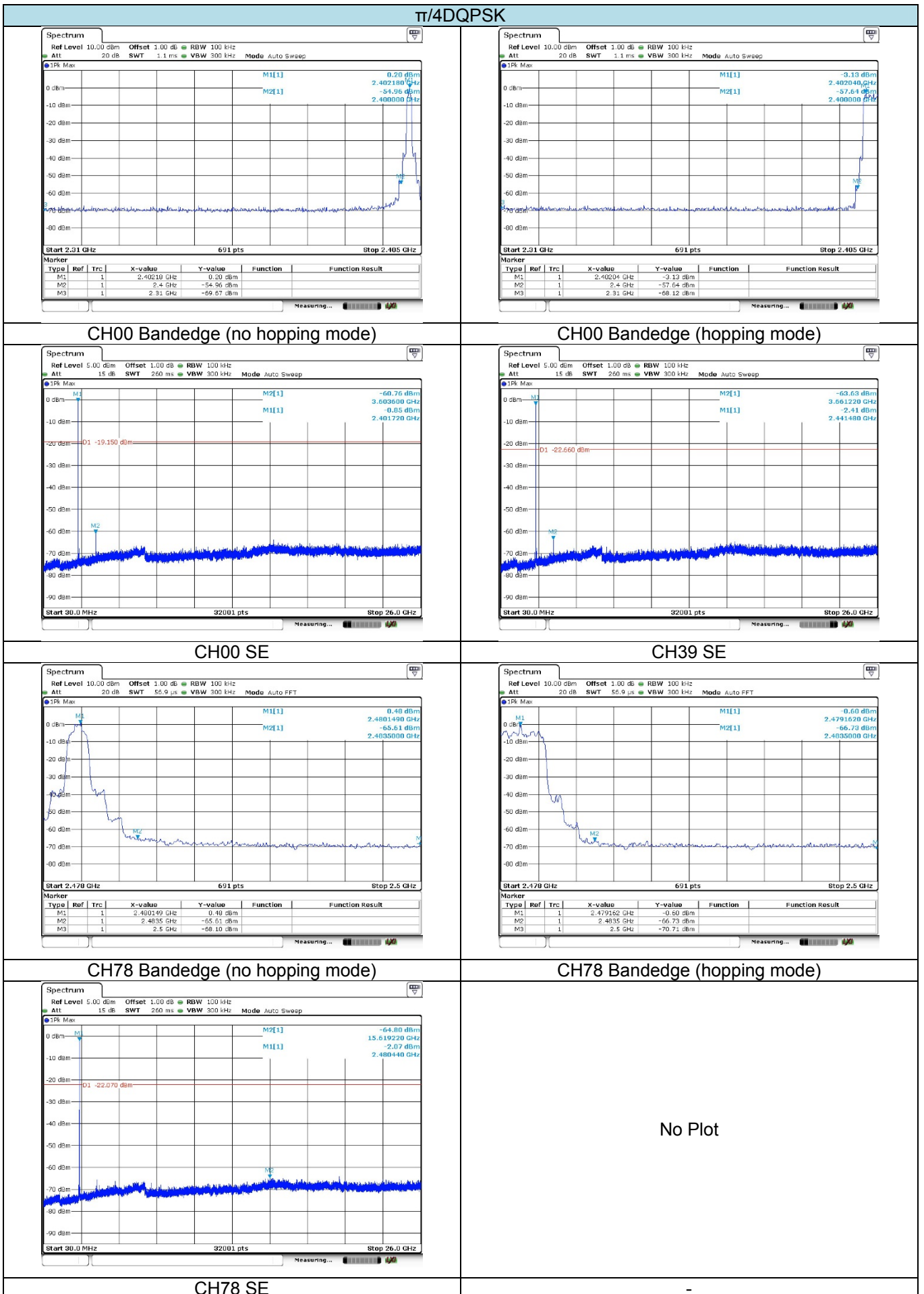

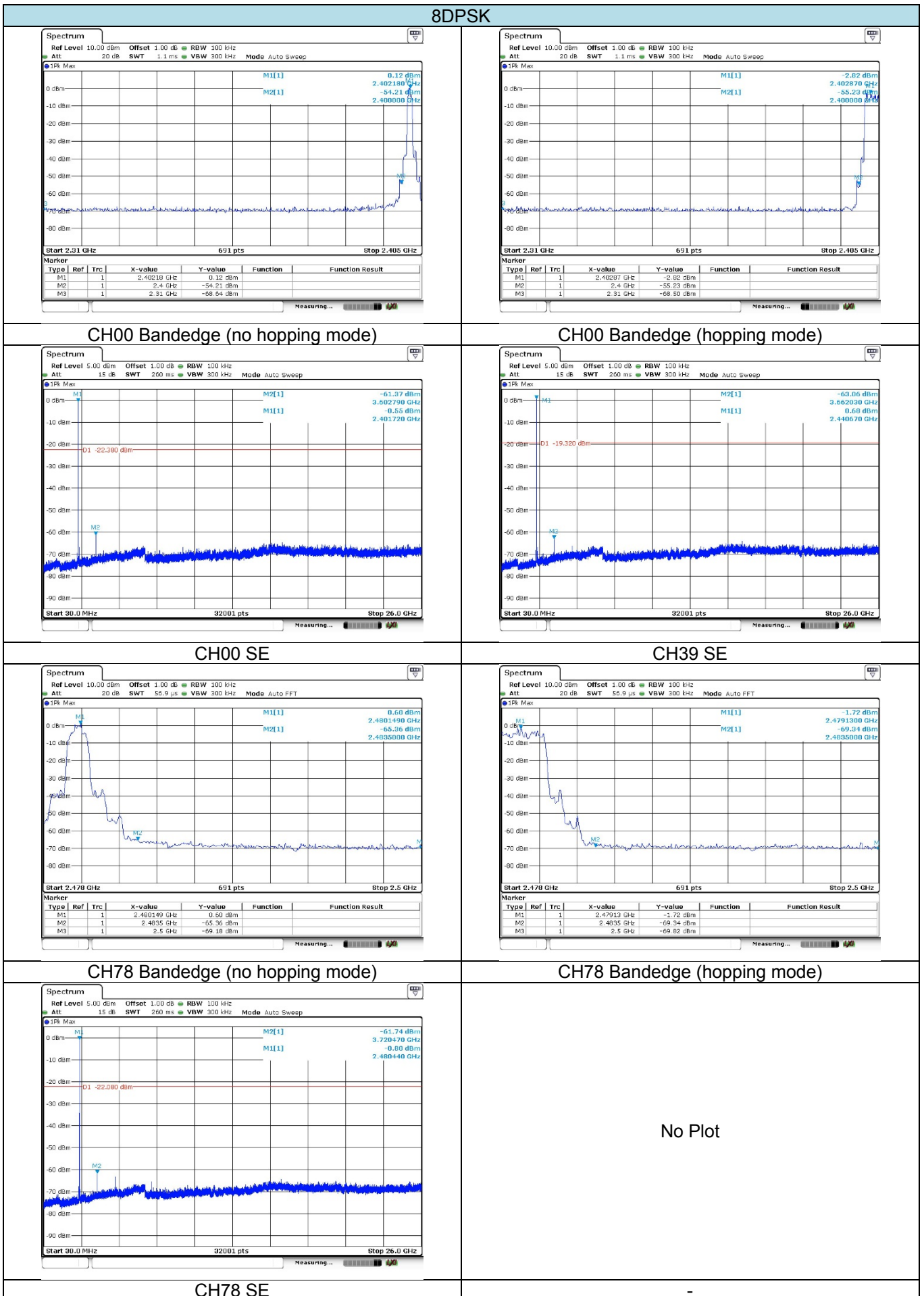

5.11. Spurious Emission (radiated)

LIMIT

FCC CFR Title 47 Part 15 Subpart C Section 15.209

Frequency	Limit (dBuV/m @3m)	Value
30 MHz ~ 88 MHz	40.00	Quasi-peak
88 MHz ~ 216 MHz	43.50	Quasi-peak
216 MHz ~ 960 MHz	46.00	Quasi-peak
960 MHz ~ 1 GHz	54.00	Quasi-peak
Above 1 GHz	54.00	Average
	74.00	Peak

TEST CONFIGURATION

➤ Below 30 MHz

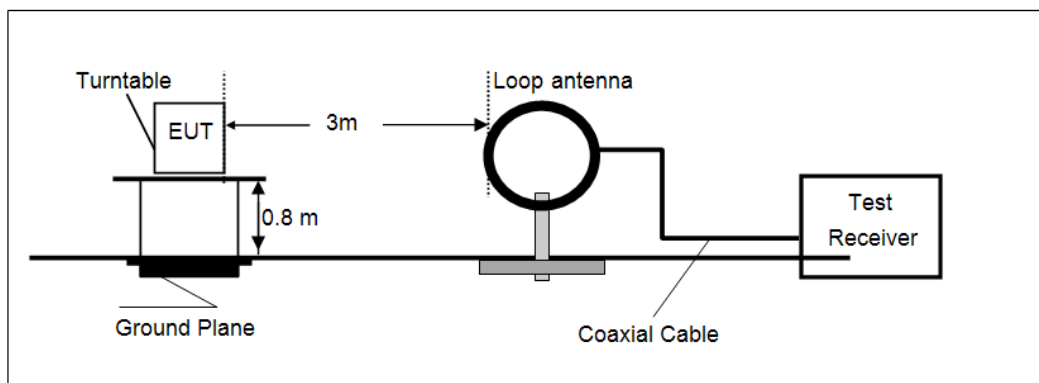

➤ 30 MHz ~1000 MHz

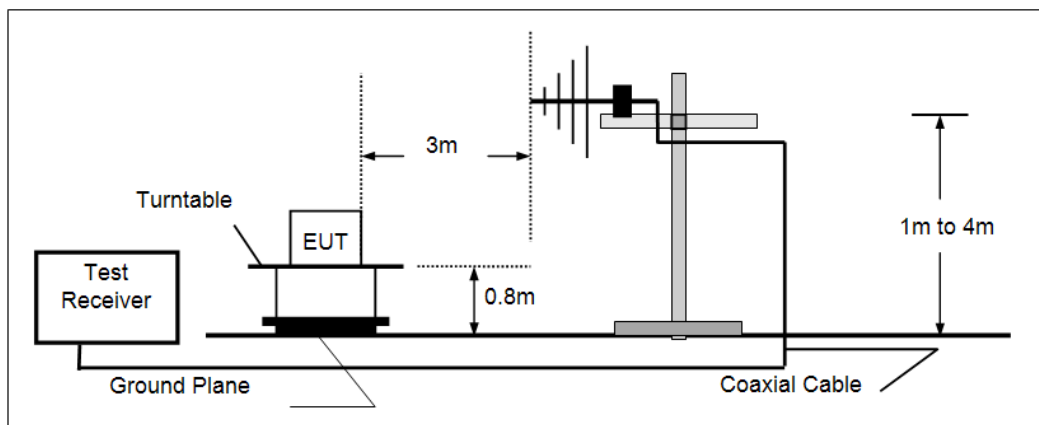

➤ Above 1 GHz

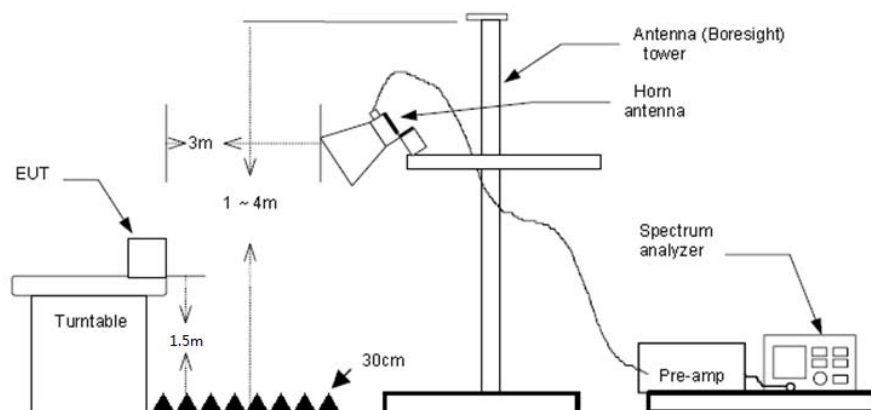

TEST PROCEDURE

1. The EUT was tested according to ANSI C63.10:2013 for compliance to FCC 47CFR 15.247 requirements.
2. The EUT is placed on a turn table which is 0.8 meter above ground. The turn table is rotated 360 degrees to determine the position of the maximum emission level.
3. The EUT was positioned such that the distance from antenna to the EUT was 3 meters.
4. The antenna is scanned from 1 meter to 4 meters to find out the maximum emission level. This is repeated for both horizontal and vertical polarization of the antenna.
5. Use the following spectrum analyzer settings
 - (1) Span shall wide enough to fully capture the emission being measured;
 - (2) Below 1 GHz, RBW=120 kHz, VBW=300 kHz, Sweep=auto, Detector function=peak, Trace=max hold; If the emission level of the EUT measured by the peak detector is 3 dB lower than the applicable limit, the peak emission level will be reported. Otherwise, the emission measurement will be repeated using the quasi-peak detector and reported.
 - (3) Above 1 GHz, RBW=1 MHz, VBW=3 MHz for Peak value
RBW=1 MHz, VBW=10 Hz for Average value.

TEST MODE:

Please refer to the clause 3.3

TEST RESULTS

Passed **Not Applicable**

Note:

- 1) Final Level = Receiver Read level + Antenna Factor + Cable Loss – Preamplifier Factor
- 2) The emission levels of other frequencies are very lower than the limit and not show in test report.
- 3) Below 1 GHz, Have pre-scan all modulation mode, found the GFSK modulation High channel which it was worst case, so only the worst case's data on the test report.
- 4) Above 1 GHz, Have pre-scan all modulation mode, found the GFSK modulation which it was worst case, so only the worst case's data on the test report
- 5) The peak level is lower than average limit (54 dBuV/m), this data is the too weak instrument of signal is unable to test.

➤ **9 kHz ~ 30 MHz**

The low frequency, which started from 9 kHz to 30 MHz, was pre-scanned and the result which was 20 dB lower than the limit line per 15.31(o) was not reported.

➤ 30 MHz ~ 1 GHz

Polarization:

Vertical

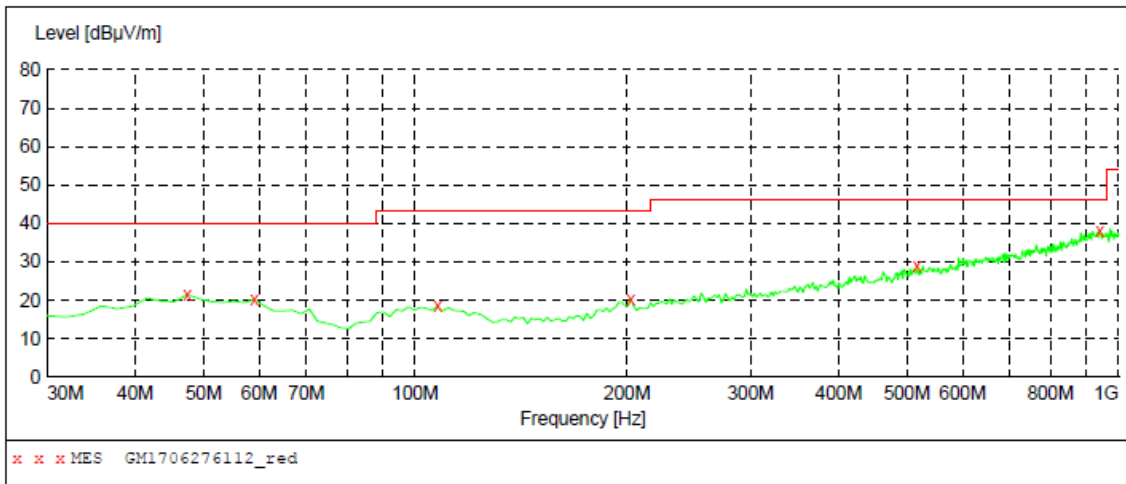

MEASUREMENT RESULT: "GM1706276112_red"

6/27/2017 8:53PM

Frequency MHz	Level dBµV/m	Transd dB	Limit dBµV/m	Margin dB	Det.	Height cm	Azimuth deg	Polarization
47.460000	21.50	-8.8	40.0	18.5	QP	100.0	241.00	VERTICAL
59.100000	20.20	-9.8	40.0	19.8	QP	100.0	11.00	VERTICAL
107.600000	18.50	-10.6	43.5	25.0	QP	100.0	253.00	VERTICAL
202.660000	20.40	-10.2	43.5	23.1	QP	100.0	293.00	VERTICAL
516.940000	29.10	-1.4	46.0	16.9	QP	100.0	241.00	VERTICAL
939.860000	38.20	7.2	46.0	7.8	QP	100.0	200.00	VERTICAL

Polarization:

Horizontal

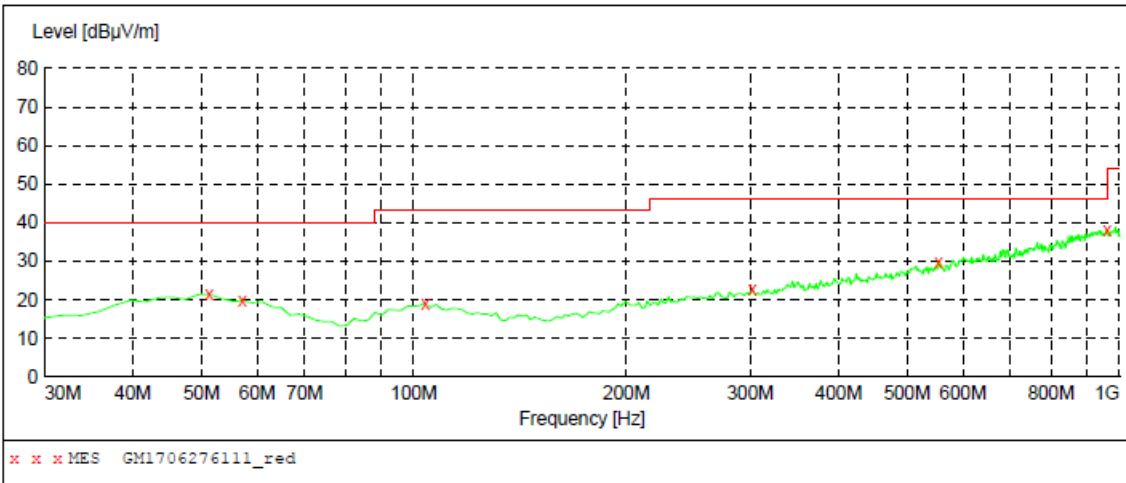

MEASUREMENT RESULT: "GM1706276111_red"

6/27/2017 8:51PM

Frequency MHz	Level dBµV/m	Transd dB	Limit dBµV/m	Margin dB	Det.	Height cm	Azimuth deg	Polarization
51.340000	21.50	-8.8	40.0	18.5	QP	100.0	96.00	HORIZONTAL
57.160000	19.70	-9.4	40.0	20.3	QP	100.0	251.00	HORIZONTAL
103.720000	19.20	-10.5	43.5	24.3	QP	100.0	73.00	HORIZONTAL
301.600000	22.60	-7.2	46.0	23.4	QP	300.0	344.00	HORIZONTAL
553.800000	30.00	-0.7	46.0	16.0	QP	100.0	0.00	HORIZONTAL
959.260000	38.00	7.3	46.0	8.0	QP	300.0	226.00	HORIZONTAL

➤ Above 1 GHz

CH00 for GFSK									
Frequency (MHz)	Read Level (dBuV)	Antenna Factor (dB/m)	Cable Loss (dB)	Preamp Factor (dB)	Level (dBuV/m)	Limit Line (dBuV/m)	Margin Limit (dB)	Polarization	Test value
1431.78	38.90	25.87	5.09	36.50	33.36	74.00	-40.64	Vertical	Peak
2980.33	45.34	28.58	7.47	38.24	43.15	74.00	-30.85	Vertical	
4809.50	51.08	31.58	9.55	36.93	55.28	74.00	-18.72	Vertical	
7209.02	36.89	36.21	11.87	35.07	49.90	74.00	-24.10	Vertical	
4809.50	31.41	31.58	9.55	36.93	35.61	54.00	-18.39	Vertical	Average
1431.78	38.34	25.87	5.09	36.50	32.80	74.00	-41.20	Horizontal	Peak
3498.74	37.61	28.99	8.11	38.41	36.30	74.00	-37.70	Horizontal	
4809.50	47.94	31.58	9.55	36.93	52.14	74.00	-21.86	Horizontal	
7470.56	33.07	36.16	12.30	34.88	46.65	74.00	-27.35	Horizontal	
4809.50	30.71	31.58	9.55	36.93	34.91	54.00	-19.09	Horizontal	Average

CH39 for GFSK									
Frequency (MHz)	Read Level (dBuV)	Antenna Factor (dB/m)	Cable Loss (dB)	Preamp Factor (dB)	Level (dBuV/m)	Limit Line (dBuV/m)	Margin Limit (dB)	Polarization	Test value
1289.89	37.85	26.21	4.81	36.52	32.35	74.00	-41.65	Vertical	Peak
3507.65	36.77	29.02	8.13	38.40	35.52	74.00	-38.48	Vertical	
4871.10	46.30	31.46	9.59	36.76	50.59	74.00	-23.41	Vertical	
7027.82	32.34	35.38	11.85	34.83	44.74	74.00	-29.26	Vertical	
1424.51	38.28	25.87	5.07	36.49	32.73	74.00	-41.27	Horizontal	Peak
3598.09	37.43	29.29	8.27	38.27	36.72	74.00	-37.28	Horizontal	
4883.52	49.48	31.43	9.59	36.73	53.77	74.00	-20.23	Horizontal	
7301.36	36.11	36.30	11.97	34.95	49.43	74.00	-24.57	Horizontal	
4883.52	28.49	31.43	9.59	36.73	32.78	54.00	-21.22	Horizontal	Average

CH78 for GFSK									
Frequency (MHz)	Read Level (dBuV)	Antenna Factor (dB/m)	Cable Loss (dB)	Preamp Factor (dB)	Level (dBuV/m)	Limit Line (dBuV/m)	Margin Limit (dB)	Polarization	Test value
1613.75	38.92	24.94	5.60	36.75	32.71	74.00	-41.29	Vertical	Peak
3200.50	39.11	28.80	7.72	38.20	37.43	74.00	-36.57	Vertical	
4958.68	43.29	31.46	9.64	36.52	47.87	74.00	-26.13	Vertical	
7451.57	36.08	36.20	12.24	34.86	49.66	74.00	-24.34	Vertical	
1435.43	37.86	25.86	5.10	36.51	32.31	74.00	-41.69	Horizontal	Peak
3653.46	36.09	29.30	8.33	38.26	35.46	74.00	-38.54	Horizontal	
4958.68	44.33	31.46	9.64	36.52	48.91	74.00	-25.09	Horizontal	
7451.57	33.14	36.20	12.24	34.86	46.72	74.00	-27.28	Horizontal	

6. Test Setup Photos of the EUT

Conducted Emission (AC Mains)



Radiated Emission





7. External and Internal Photos of the EUT

Reference to Test Report No.: TRE1706012501.

.....End of Report.....