



TEST REPORT

Report Reference No...... : **TRE16120215** R/C.....: 71029
FCC ID..... : **ZSW-30-040**
Applicant's name..... : **b mobile HK Limited**
 Address..... : Flat 18; 14/F Block 1; Golden Industrial Building;16-26 Kwai Tak Street; Kwai Chung; New Territories; Hong Kong.
 Manufacturer..... : b mobile HK Limited
 Address..... : Flat 18; 14/F Block 1; Golden Industrial Building;16-26 Kwai Tak Street; Kwai Chung; New Territories; Hong Kong.
Test item description : Mobile Phone
 Trade Mark : Bmobile
 Model/Type reference..... : AX1075
 Listed Model(s)..... : -
Standard : **FCC 47 CFR Part2.1093**
ANSI/IEEE C95.1: 1999
IEEE 1528: 2013
 Date of receipt of test sample..... : Dec. 30, 2016
 Date of testing..... : Dec. 30, 2016- Feb. 20, 2017
 Date of issue..... : Feb. 20, 2017
Result..... : **PASS**

Compiled by
 (position+printedname+signature)....: File administrators:SiyuanRao

Siyuan Rao

Supervised by
 (position+printedname+signature)....: Test Engineer: SiyuanRao

Siyuan Rao

Approved by
 (position+printedname+signature)....: Manager: Hans Hu

Hans Hu

Testing Laboratory Name : **Shenzhen Huatongwei International Inspection Co., Ltd**
 Address..... : 1/F, Bldg 3, Hongfa Hi-tech Industrial Park, Genyu Road, Tianliao, Gongming, Shenzhen, China

Shenzhen Huatongwei International Inspection Co., Ltd. All rights reserved.

This publication may be reproduced in whole or in part for non-commercial purposes as long as the Shenzhen Huatongwei International Inspection Co., Ltd is acknowledged as copyright owner and source of the material. Shenzhen Huatongwei International Inspection Co., Ltd takes no responsibility for and will not assume liability for damages resulting from the reader's interpretation of the reproduced material due to its placement and context.

Contents

<u>1.</u>	<u>Test Standards and Report version</u>	<u>3</u>
1.1.	Test Standards	3
1.2.	Report version	3
<u>2.</u>	<u>Summary</u>	<u>4</u>
2.1.	Client Information	4
2.2.	Product Description	4
<u>3.</u>	<u>Test Environment</u>	<u>6</u>
3.1.	Address of the test laboratory	6
3.2.	Test Facility	6
<u>4.</u>	<u>Equipments Used during the Test</u>	<u>7</u>
<u>5.</u>	<u>Measurement Uncertainty</u>	<u>8</u>
<u>6.</u>	<u>SAR Measurements System Configuration</u>	<u>10</u>
6.1.	SAR Measurement Set-up	10
6.2.	DASY5 E-field Probe System	11
6.3.	Phantoms	12
6.4.	Device Holder	12
<u>7.</u>	<u>SAR Test Procedure</u>	<u>13</u>
7.1.	Scanning Procedure	13
7.2.	Data Storage and Evaluation	14
<u>8.</u>	<u>Position of the wireless device in relation to the phantom</u>	<u>16</u>
8.1.	Head Position	16
8.2.	Body Position	17
8.3.	Hotspot Mode Exposure conditions	17
<u>9.</u>	<u>System Check</u>	<u>18</u>
9.1.	Tissue Dielectric Parameters	18
9.2.	SAR System Check	20
<u>10.</u>	<u>SAR Exposure Limits</u>	<u>32</u>
<u>11.</u>	<u>Conducted Power Measurement Results</u>	<u>33</u>
<u>12.</u>	<u>Maximum Tune-up Limit</u>	<u>44</u>
<u>13.</u>	<u>Antenna Location</u>	<u>46</u>
<u>14.</u>	<u>SAR Measurement Results</u>	<u>47</u>
<u>15.</u>	<u>Simultaneous Transmission analysis</u>	<u>77</u>
<u>16.</u>	<u>TestSetup Photos</u>	<u>83</u>
<u>17.</u>	<u>External and Internal Photos of the EUT</u>	<u>85</u>

1 . Test Standards and Report version

1.1. Test Standards

The tests were performed according to following standards:

[FCC 47 Part 2.1093](#) Radiofrequency Radiation Exposure Evaluation:Portable Devices

[IEEE Std C95.1, 1999](#): IEEE Standard for Safety Levels with Respect to Human Exposure to Radio Frequency Electromagnetic Fields, 3 KHz to 300 GHz.

[IEEE Std 1528™-2013](#): IEEE Recommended Practice for Determining the Peak Spatial-Average Specific Absorption Rate (SAR) in the Human Head from Wireless Communications Devices: Measurement Techniques.

[KDB 865664 D01 SAR Measurement 100 MHz to 6 GHz v01r04](#): SAR Measurement Requirements for 100 MHz to 6 GHz

[KDB 865664 D02 RF Exposure Reporting v01r02](#): RF Exposure Compliance Reporting and Documentation Considerations

[KDB 447498 D01 General RF Exposure Guidance v06](#): Mobile and Portable Device RF Exposure Procedures and Equipment Authorization Policies

[KDB248227 D01 802.11 Wi-Fi SAR v02r02](#): SAR Measurement Proceduresfor802.11 a/b/g Transmitters

[KDB 648474 D04 Handset SAR v01r03](#): SAR Evaluation Considerations for Wireless Handsets

[KDB 616217 D04 SAR for laptop and tablets v01r02](#):SAR Evaluation Considerations for Laptop, Notebook, Netbook and Tablet Computers

[KDB941225 D01 3G SAR Procedures v03r01](#): SAR Measurement Procedures for 3G Devices

[KDB 941225 D06 Hotspot Mode v02r01](#): SAR Evaluation Procedures for Portable Devices with Wireless Router Capabilities

[KDB941225 D05 SAR for LTE Devices v02r04](#): SAR Evaluation Considerations for LTE Devices

1.2. Report version

Version No.	Date of issue	Description
00	Feb.20, 2017	Original

2. Summary

2.1. Client Information

Applicant:	b mobile HK Limited
Address:	Flat 18; 14/F Block 1; Golden Industrial Building;16-26 Kwai Tak Street; Kwai Chung; New Territories; Hong Kong.
Manufacturer:	b mobile HK Limited
Address:	Flat 18; 14/F Block 1; Golden Industrial Building;16-26 Kwai Tak Street; Kwai Chung; New Territories; Hong Kong.

2.2. Product Description

Name of EUT	Mobile Phone	
Trade Mark:	Bmobile	
Model No.:	AX1075	
Listed Model(s):	-	
Power supply:	DC 3.8V From internal battery	
Device Category:	Portable	
Product stage:	Production unit	
RF Exposure Environment:	General Population / Uncontrolled	
IMEI:	866270029864016	
Device Class:	B	
Hardware version:	V2.0	
Software version:	Bmobile_AX1075_TEM_MX_V015	
Maximum SAR Value		
Separation Distance:	Head:	0mm
	Body:	10mm
Max Report SAR Value (1g):	Head:	0.32 W/Kg
	Body:	0.85 W/Kg
GSM		
Support Network:	GSM, GPRS	
Support Band:	GSM850, PCS1900	
Modulation:	GSM/GPRS: GMSK	
Transmit Frequency:	GSM850: 824.20MHz-848.80MHz PCS1900: 1850.20MHz-1909.80MHz	
Receive Frequency:	GSM850: 869.20MHz-893.80MHz PCS1900: 1930.20MHz-1989.80MHz	
GPRS Class:	12	
EGPRS Class:	-	
Antenna type:	Intergal Antenna	
WCDMA		
Operation Band:	FDD Band II and FDD Band V	
Power Class:	Power Class 3	
Modulation Type:	QPSK/16QAM/64QAM/HSUPA/HSDPA	
DC-HSUPA Release Version:	Not Supported	
Antenna type:	Intergal Antenna	

LTE	
Operation Band:	FDD Band 2,FDD Band 4, FDD Band 7
Modulation Type:	QPSK , 16QAM
WIFI	
Supported type:	802.11b/802.11g/802.11n(H20)/802.11n(H40)
Modulation:	802.11b: DSSS (DBPSK / DQPSK / CCK) 802.11g/n(H20)/ n(H40): OFDM (BPSK / QPSK / 16QAM / 64QAM)
Operation frequency:	802.11b/g/n(H20): 2412MHz~2462MHz 802.11n(H40): 2422MHz~2452MHz
Channel number:	802.11b/g/n(H20): 11 802.11n(H40):7
Channel separation:	5MHz
Antenna type:	Internal Antenna
Bluetooth	
Version:	Supported BT4.1+EDR
Modulation:	GFSK, $\pi/4$ DQPSK, 8DPSK
Operation frequency:	2402MHz~2480MHz
Channel number:	79
Channel separation:	1MHz
Antenna type:	Integral Antenna
Bluetooth-BLE	
Version:	Supported BT4.1+BLE
Modulation:	GFSK
Operation frequency:	2402MHz~2480MHz
Channel number:	40
Channel separation:	2MHz
Antenna type:	Integral Antenna
<i>Remark:</i> The EUT battery must be fully charged and checked periodically during the test to ascertain uniform power	

3. Test Environment

3.1. Address of the test laboratory

Laboratory: Shenzhen Huatongwei International Inspection Co., Ltd.

Address: 1/F, Bldg 3, Hongfa Hi-tech Industrial Park, Genyu Road, Tianliao, Gongming, Shenzhen, China

Phone: 86-755-26748019 Fax: 86-755-26748089

3.2. Test Facility

The test facility is recognized, certified, or accredited by the following organizations:

CNAS-Lab Code: L1225

Shenzhen Huatongwei International Inspection Co., Ltd. has been assessed and proved to be in compliance with CNAS-CL01 Accreditation Criteria for Testing and Calibration Laboratories (identical to ISO/IEC 17025: 2005 General Requirements) for the Competence of Testing and Calibration Laboratories, Date of Registration: February 28, 2015. Valid time is until February 27, 2018.

A2LA-Lab Cert. No. 3902.01

Shenzhen Huatongwei International Inspection Co., Ltd. EMC Laboratory has been accredited by A2LA for technical competence in the field of electrical testing, and proved to be in compliance with ISO/IEC 17025: 2005 General Requirements for the Competence of Testing and Calibration Laboratories and any additional program requirements in the identified field of testing. Valid time is until February 27, 2018.

FCC-Registration No.: 317478

Shenzhen Huatongwei International Inspection Co., Ltd. EMC Laboratory has been registered and fully described in a report filed with the FCC (Federal Communications Commission). The acceptance letter from the FCC is maintained in our files. Registration 317478, Renewal date Jul. 18, 2014, valid time is until Jul. 18, 2017.

IC-Registration No.: 5377B

Two 3m Alternate Test Site of Shenzhen Huatongwei International Inspection Co., Ltd. has been registered by Certification and Engineering Bureau of Industry Canada for the performance of radiated measurements with Registration No.: 5377B on Dec.03, 2014, valid time is until Dec.03, 2017.

ACA

Shenzhen Huatongwei International Inspection Co., Ltd. EMC Laboratory can also perform testing for the Australian C-Tick mark as a result of our A2LA accreditation.

4. Equipments Used during the Test

Test Equipment	Manufacturer	Type/Model	Serial Number	Calibration	
				Last Calibration	Calibration Interval
Data Acquisition Electronics DAEx	SPEAG	DAE4	1315	2016/07/26	1
E-field Probe	SPEAG	ES3DV3	3292	2016/09/02	1
System Validation Dipole D835V2	SPEAG	D835V2	4d134	2014/07/24	3
System Validation Dipole D1750V2	SPEAG	D1750V2	1062	2015/07/25	3
System Validation Dipole D1900V2	SPEAG	D1900V2	5d101	2015/07/23	3
System Validation Dipole D2450V2	SPEAG	D2450V2	884	2015/09/01	3
System Validation Dipole D2600V2	SPEAG	D2600V2	1120	2016/02/03	3
Dielectric Probe Kit	Agilent	85070E	US44020288	/	/
Power meter	Agilent	E4417A	GB41292254	2016/10/25	1
Power sensor	Agilent	8481H	MY41095360	2016/10/25	1
Power sensor	Agilent	E9327A	US40441621	2016/10/25	1
Network analyzer	Agilent	8753E	US37390562	2016/10/24	1
Universal Radio Communication Tester	ROHDE & SCHWARZ	CMU200	112012	2016/10/22	1
Universal Radio Communication Tester	ROHDE & SCHWARZ	CMW500	1556902	2016/12/27	1
Signal Generator	ROHDE & SCHWARZ	SMBV100A	258525	2016/10/22	1
Power Divider	ARRA	A3200-2	N/A	N/A	N/A
Dual Directional Coupler	Agilent	778D	50783	Note	
Attenuator 1	PE	PE7005-10	N/A	Note	
Attenuator 2	PE	PE7005-10	N/A	Note	
Attenuator 3	PE	PE7005-3	N/A	Note	
Power Amplifier	AR	5S1G4M2	0328798	Note	

Note:

1. The Probe, Dipole and DAE calibration reference to the Appendix A.
2. Referring to KDB865664 D01, the dipole calibration interval can be extended to 3 years with justification. The dipole are also not physically damaged or repaired during the interval.

5. Measurement Uncertainty

Measurement Uncertainty										
No.	Error Description	Type	Uncertainty Value	Probably Distribution	Div.	(Ci) 1g	(Ci) 10g	Std. Unc. (1g)	Std. Unc. (10g)	Degree of freedom
Measurement System										
1	Probe calibration	B	6.0%	N	1	1	1	6.0%	6.0%	∞
2	Axial isotropy	B	4.70%	R	$\sqrt{3}$	0.7	0.7	1.90%	1.90%	∞
3	Hemispherical isotropy	B	9.60%	R	$\sqrt{3}$	0.7	0.7	3.90%	3.90%	∞
4	Boundary Effects	B	1.00%	R	$\sqrt{3}$	1	1	0.60%	0.60%	∞
5	Probe Linearity	B	4.70%	R	$\sqrt{3}$	1	1	2.70%	2.70%	∞
6	Detection limit	B	1.00%	R	$\sqrt{3}$	1	1	0.60%	0.60%	∞
7	RF ambient conditions-noise	B	0.00%	R	$\sqrt{3}$	1	1	0.00%	0.00%	∞
8	RF ambient conditions-reflection	B	0.00%	R	$\sqrt{3}$	1	1	0.00%	0.00%	∞
9	Response time	B	0.80%	R	$\sqrt{3}$	1	1	0.50%	0.50%	∞
10	Integration time	B	5.00%	R	$\sqrt{3}$	1	1	2.90%	2.90%	∞
11	RF ambient	B	3.00%	R	$\sqrt{3}$	1	1	1.70%	1.70%	∞
12	Probe positioned mech. restrictions	B	0.40%	R	$\sqrt{3}$	1	1	0.20%	0.20%	∞
13	Probe positioning with respect to phantom shell	B	2.90%	R	$\sqrt{3}$	1	1	1.70%	1.70%	∞
14	Max.SAR evaluation	B	3.90%	R	$\sqrt{3}$	1	1	2.30%	2.30%	∞
Test Sample Related										
15	Test sample positioning	A	1.86%	N	1	1	1	1.86%	1.86%	∞
16	Device holder uncertainty	A	1.70%	N	1	1	1	1.70%	1.70%	∞
17	Drift of output power	B	5.00%	R	$\sqrt{3}$	1	1	2.90%	2.90%	∞
Phantom and Set-up										
18	Phantom uncertainty	B	4.00%	R	$\sqrt{3}$	1	1	2.30%	2.30%	∞
19	Liquid conductivity (target)	B	5.00%	R	$\sqrt{3}$	0.64	0.43	1.80%	1.20%	∞
20	Liquid conductivity (meas.)	A	0.50%	N	1	0.64	0.43	0.32%	0.26%	∞
21	Liquid permittivity (target)	B	5.00%	R	$\sqrt{3}$	0.64	0.43	1.80%	1.20%	∞
22	Liquid permittivity (meas.)	A	0.16%	N	1	0.64	0.43	0.10%	0.07%	∞
Combined standard uncertainty		$u_c = \sqrt{\sum_{i=1}^{22} c_i^2 u_i^2}$		/	/	/	/	9.79%	9.67%	∞
Expanded uncertainty (confidence interval of 95 %)		$u_e = 2u_c$		R	K=2	/	/	19.57%	19.34%	∞

System Check Uncertainty										
No.	Error Description	Type	Uncertainty Value	Probably Distribution	Div.	(Ci) 1g	(Ci) 10g	Std. Unc. (1g)	Std. Unc. (10g)	Degree of freedom
Measurement System										
1	Probe calibration	B	6.0%	N	1	1	1	6.0%	6.0%	∞
2	Axial isotropy	B	4.70%	R	$\sqrt{3}$	0.7	0.7	1.90%	1.90%	∞
3	Hemispherical isotropy	B	9.60%	R	$\sqrt{3}$	0.7	0.7	3.90%	3.90%	∞
4	Boundary Effects	B	1.00%	R	$\sqrt{3}$	1	1	0.60%	0.60%	∞
5	Probe Linearity	B	4.70%	R	$\sqrt{3}$	1	1	2.70%	2.70%	∞
6	Detection limit	B	1.00%	R	$\sqrt{3}$	1	1	0.60%	0.60%	∞
7	RF ambient conditions-noise	B	0.00%	R	$\sqrt{3}$	1	1	0.00%	0.00%	∞
8	RF ambient conditions-reflection	B	0.00%	R	$\sqrt{3}$	1	1	0.00%	0.00%	∞
9	Response time	B	0.80%	R	$\sqrt{3}$	1	1	0.50%	0.50%	∞
10	Integration time	B	5.00%	R	$\sqrt{3}$	1	1	2.90%	2.90%	∞
11	RF ambient	B	3.00%	R	$\sqrt{3}$	1	1	1.70%	1.70%	∞
12	Probe positioned mech. restrictions	B	0.40%	R	$\sqrt{3}$	1	1	0.20%	0.20%	∞
13	Probe positioning with respect to phantom shell	B	2.90%	R	$\sqrt{3}$	1	1	1.70%	1.70%	∞
14	Max.SAR evaluation	B	3.90%	R	$\sqrt{3}$	1	1	2.30%	2.30%	∞
System validation source-dipole										
15	Deviation of experimental dipole from numerical dipole	A	1.58%	N	1	1	1	1.58%	1.58%	∞
16	Dipole axis to liquid distance	A	1.35%	N	1	1	1	1.35%	1.35%	∞
17	Input power and SAR drift	B	4.00%	R	$\sqrt{3}$	1	1	2.30%	2.30%	∞
Phantom and Set-up										
18	Phantom uncertainty	B	4.00%	R	$\sqrt{3}$	1	1	2.30%	2.30%	∞
20	Liquid conductivity (meas.)	A	0.50%	N	1	0.64	0.43	0.32%	0.26%	∞
22	Liquid cpermittivity (meas.)	A	0.16%	N	1	0.64	0.43	0.10%	0.07%	∞
Combined standard uncertainty		$u_c = \sqrt{\sum_{i=1}^{22} c_i^2 u_i^2}$		/	/	/	/	8.80%	8.79%	∞
Expanded uncertainty (confidence interval of 95 %)		$u_e = 2u_c$		R	K=2	/	/	17.59%	17.58%	∞

6. SAR Measurements System Configuration

6.1. SAR Measurement Set-up

The DASY5 system for performing compliance tests consists of the following items:

A standard high precision 6-axis robot (Stäubli RX family) with controller and software. An arm extension for accommodating the data acquisition electronics (DAE).

A dosimetric probe, i.e. an isotropic E-field probe optimized and calibrated for usage in tissue simulating liquid. The probe is equipped with an optical surface detector system.

A data acquisition electronic (DAE) which performs the signal amplification, signal multiplexing, AD-conversion, offset measurements, mechanical surface detection, collision detection, etc. The unit is battery powered with standard or rechargeable batteries. The signal is optically transmitted to the EOC.

A unit to operate the optical surface detector which is connected to the EOC.

The Electro-Optical Coupler (EOC) performs the conversion from the optical into a digital electric signal of the DAE. The EOC is connected to the DASY5 measurement server.

The DASY5 measurement server, which performs all real-time data evaluation for field measurements and surface detection, controls robot movements and handles safety operation. A computer operating Windows 2003.

DASY5 software and SEMCAD data evaluation software.

Remote control with teach panel and additional circuitry for robot safety such as warning lamps, etc.

The generic twin phantom enabling the testing of left-hand and right-hand usage.

The device holder for handheld Mobile Phones.

Tissue simulating liquid mixed according to the given recipes.

System validation dipoles allowing to validate the proper functioning of the system.

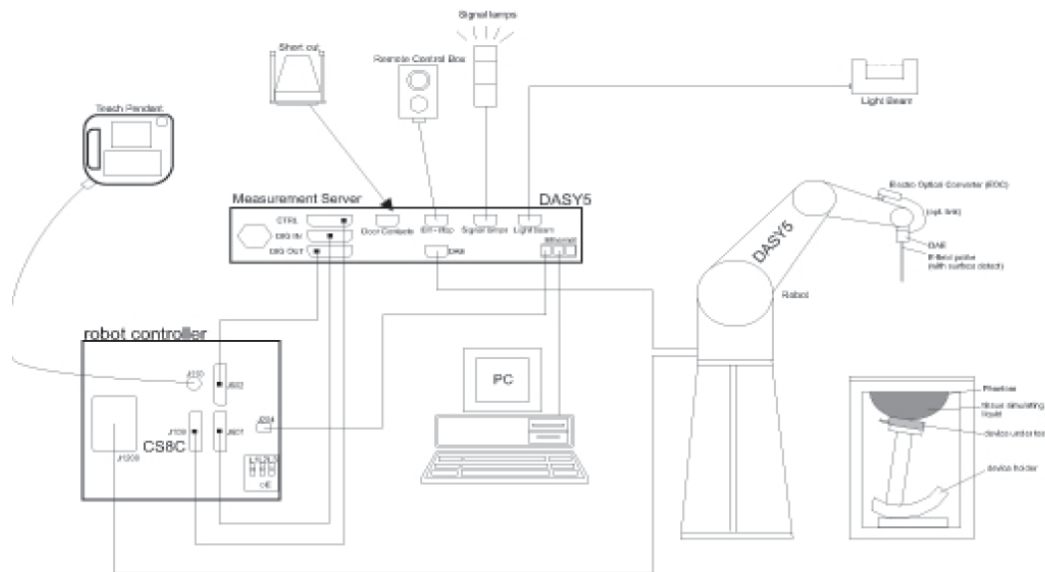

6.2. DASY5 E-field Probe System

The SAR measurements were conducted with the dosimetric probe ES3DV3 (manufactured by SPEAG), designed in the classical triangular configuration and optimized for dosimetric evaluation.

● Probe Specification

Construction Symmetrical design with triangular core
 Interleaved sensors
 Built-in shielding against static charges
 PEEK enclosure material (resistant to organic solvents, e.g., DGBE)

Calibration ISO/IEC 17025 calibration service available.

Frequency	10 MHz to 4 GHz; Linearity: ± 0.2 dB (30 MHz to 4 GHz)
Directivity	± 0.2 dB in HSL (rotation around probe axis) ± 0.3 dB in tissue material (rotation normal to probe axis)
Dynamic Range	5 μ W/g to > 100 mW/g; Linearity: ± 0.2 dB
Dimensions	Overall length: 337 mm (Tip: 20 mm) Tip diameter: 3.9 mm (Body: 12 mm) Distance from probe tip to dipole centers: 2.0 mm
Application	General dosimetry up to 4 GHz Dosimetry in strong gradient fields Compliance tests of Mobile Phones
Compatibility	DASY3, DASY4, DASY52 SAR and higher, EASY4/MRI



● Isotropic E-Field Probe

The isotropic E-Field probe has been fully calibrated and assessed for isotropicity, and boundary effect within a controlled environment. Depending on the frequency for which the probe is calibrated the method utilized for calibration will change.

The E-Field probe utilizes a triangular sensor arrangement as detailed in the diagram below:

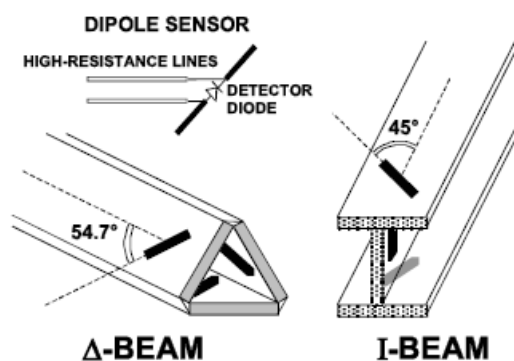

6.3. Phantoms

The phantom used for all tests i.e. for both system checks and device testing, was the twin-headed "SAM Phantom", manufactured by SPEAG. The SAM twin phantom is a fiberglass shell phantom with 2mm shell thickness (except the ear region, where shell thickness increases to 6mm).

System checking was performed using the flat section, whilst Head SAR tests used the left and right head profile sections. Body SAR testing also used the flat section between the head profiles.

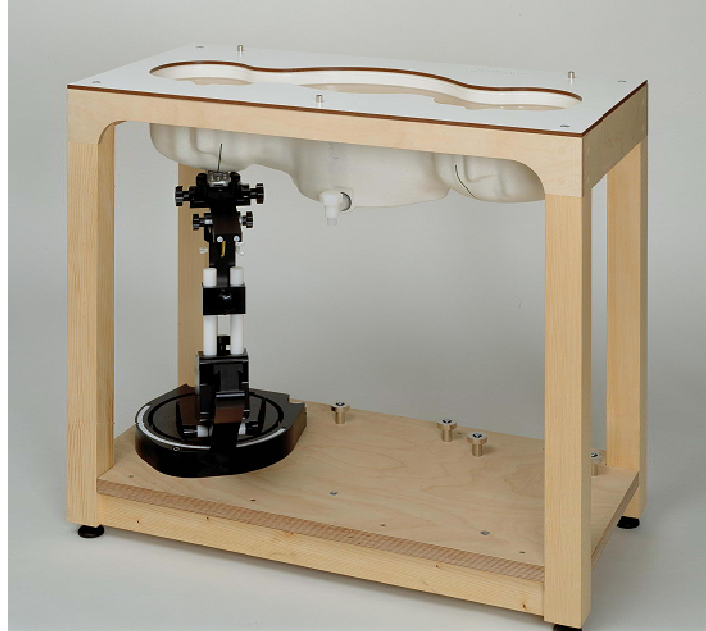

SAM Twin Phantom

6.4. Device Holder

The device was placed in the device holder (illustrated below) that is supplied by SPEAG as an integral part of the DASY system.

The DASY device holder is designed to cope with the different positions given in the standard. It has two scales for device rotation (with respect to the body axis) and device inclination (with respect to the line between the ear reference points). The rotation centers for both scales is the ear reference point (ERP). Thus the device needs no repositioning when changing the angles.



Device holder supplied by SPEAG

7. SAR Test Procedure

7.1. Scanning Procedure

The DASY5 installation includes predefined files with recommended procedures for measurements and validation. They are read-only document files and destined as fully defined but unmeasured masks. All test positions (head or body-worn) are tested with the same configuration of test steps differing only in the grid definition for the different test positions.

The “reference” and “drift” measurements are located at the beginning and end of the batch process. They measure the field drift at one single point in the liquid over the complete procedure. The indicated drift is mainly the variation of the DUT’s output power and should vary max. $\pm 5\%$.

The “surface check” measurement tests the optical surface detection system of the DASY5 system by repeatedly detecting the surface with the optical and mechanical surface detector and comparing the results. The output gives the detecting heights of both systems, the difference between the two systems and the standard deviation of the detection repeatability. Air bubbles or refraction in the liquid due to separation of the sugar-water mixture gives poor repeatability (above $\pm 0.1\text{mm}$). To prevent wrong results tests are only executed when the liquid is free of air bubbles. The difference between the optical surface detection and the actual surface depends on the probe and is specified with each probe (It does not depend on the surface reflectivity or the probe angle to the surface within $\pm 30^\circ$.)

Area Scan

The Area Scan is used as a fast scan in two dimensions to find the area of high field values before running a detailed measurement around the hot spot. Before starting the area scan a grid spacing of 15 mm x 15 mm is set. During the scan the distance of the probe to the phantom remains unchanged. After finishing area scan, the field maxima within a range of 2 dB will be ascertained.

Zoom Scan

Zoom Scans are used to estimate the peak spatial SAR values within a cubic averaging volume containing 1 g and 10 g of simulated tissue. The default Zoom Scan is done by 7x7x5 points within a cube whose base is centered around the maxima found in the preceding area scan.

Spatial Peak Detection

The procedure for spatial peak SAR evaluation has been implemented and can determine values of masses of 1g and 10g, as well as for user-specific masses. The DASY5 system allows evaluations that combine measured data and robot positions, such as: • maximum search • extrapolation • boundary correction • peak search for averaged SAR. During a maximum search, global and local maxima searches are automatically performed in 2-D after each Area Scan measurement with at least 6 measurement points. It is based on the evaluation of the local SAR gradient calculated by the Quadratic Shepard’s method. The algorithm will find the global maximum and all local maxima within -2 dB of the global maxima for all SAR distributions.

Extrapolation routines are used to obtain SAR values between the lowest measurement points and the inner phantom surface. The extrapolation distance is determined by the surface detection distance and the probe sensor offset. Several measurements at different distances are necessary for the extrapolation. Extrapolation routines require at least 10 measurement points in 3-D space. They are used in the Zoom Scan to obtain SAR values between the lowest measurement points and the inner phantom surface. The routine uses the modified Quadratic Shepard’s method for extrapolation. For a grid using 7x7x5 measurement points with 5mm resolution amounting to 343 measurement points, the uncertainty of the extrapolation routines is less than 1% for 1g and 10g cubes.

A Z-axis scan measures the total SAR value at the x-and y-position of the maximum SAR value found during the cube 7x7x5 scan. The probe is moved away in z-direction from the bottom of the SAM phantom in 5mm steps.

7.2. Data Storage and Evaluation

Data Storage

The DASY5 software stores the acquired data from the data acquisition electronics as raw data (in microvolt readings from the probe sensors),s together with all necessary software parameters for the data evaluation (probe calibration data, liquid parameters and device frequency and modulation data) in measurement files with the extension ".DA4". The software evaluates the desired unit and format for output each time the data is visualized or exported. This allows verification of the complete software setup even after the measurement and allows correction of incorrect parameter settings. For example, if a measurement has been performed with a wrong crest factor parameter in the device setup, the parameter can be corrected afterwards and the data can be re-evaluated.

The measured data can be visualized or exported in different units or formats, depending on the selected probe type ([V/m], [A/m], [°C], [mW/g], [mW/cm²], [dBrel], etc.). Some of these units are not available in certain situations or show meaningless results, e.g., a SAR output in a lossless media will always be zero. Raw data can also be exported to perform the evaluation with other software packages.

Data Evaluation

The SEMCAD software automatically executes the following procedures to calculate the field units from the microvolt readings at the probe connector. The parameters used in the evaluation are stored in the configuration modules of the software:

Probe parameters:	Sensitivity:	Normi, ai0, ai1, ai2
	Conversion factor:	ConvFi
	Diode compression point:	Dcpi
Device parameters:	Frequency:	f
	Crest factor:	cf
Media parameters:	Conductivity:	σ
	Density:	ρ

These parameters must be set correctly in the software. They can be found in the component documents or they can be imported into the software from the configuration files issued for the DASY5 components. In the direct measuring mode of the multimeter option, the parameters of the actual system setup are used. In the scan visualization and export modes, the parameters stored in the corresponding document files are used.

The first step of the evaluation is a linearization of the filtered input signal to account for the compression characteristics of the detector diode. The compensation depends on the input signal, the diode type and the DC-transmission factor from the diode to the evaluation electronics. If the exciting field is pulsed, the crest factor of the signal must be known to correctly compensate for peak power. The formula for each channel can be given as:

$$V_i = U_i + U_i^2 \cdot \frac{cf}{dcp_i}$$

Vi:	compensated signal of channel (i = x, y, z)
Ui:	input signal of channel (i = x, y, z)
cf:	crest factor of exciting field (DASY parameter)
dcp _i :	diode compression point (DASY parameter)

From the compensated input signals the primary field data for each channel can be evaluated:

$$\mathbf{E} - \text{fieldprobes : } E_i = \sqrt{\frac{V_i}{Norm_i \cdot ConvF}}$$

$$\mathbf{H} - \text{fieldprobes : } H_i = \sqrt{V_i} \cdot \frac{a_{i0} + a_{i1}f + a_{i2}f^2}{f}$$

Vi:	compensated signal of channel (i = x, y, z)
Normi:	sensor sensitivity of channel (i = x, y, z), [mV/(V/m)²] for E-field Probes
ConvF:	sensitivity enhancement in solution
aij:	sensor sensitivity factors for H-field probes
f:	carrier frequency [GHz]
Ei:	electric field strength of channel i in V/m
Hi:	magnetic field strength of channel i in A/m

The RSS value of the field components gives the total field strength (Hermitian magnitude):

$$E_{tot} = \sqrt{E_x^2 + E_y^2 + E_z^2}$$

The primary field data are used to calculate the derived field units.

$$SAR = E_{tot}^2 \cdot \frac{\sigma}{\rho \cdot 1'000}$$

SAR: local specific absorption rate in mW/g
Etot: total field strength in V/m
 σ : conductivity in [mho/m] or [Siemens/m]
 ρ : equivalent tissue density in g/cm³

Note that the density is normally set to 1 (or 1.06), to account for actual brain density rather than the density of the simulation liquid.

8. Position of the wireless device in relation to the phantom

8.1. Head Position

The wireless device define two imaginary lines on the handset, the vertical centreline and the horizontal line, for the handset in vertical orientation as shown in Figures 5a and 5b.

The vertical centreline passes through two points on the front side of the handset: the midpoint of the width W_t of the handset at the level of the acoustic output (point A in Figures 5a and 5b), and the midpoint of the width W_b of the bottom of the handset (point B).

The horizontal line is perpendicular to the vertical centreline and passes through the centre of the acoustic output (see Figures 5a and 5b). The two lines intersect at point A.

Note that for many handsets, point A coincides with the centre of the acoustic output. However, the acoustic output may be located elsewhere on the horizontal line. Also note that the vertical centreline is not necessarily parallel to the front face of the handset (see Figure 5b), especially for clam-shell handsets, handsets with flip cover pieces, and other irregularly shaped handsets.



Figures 5a

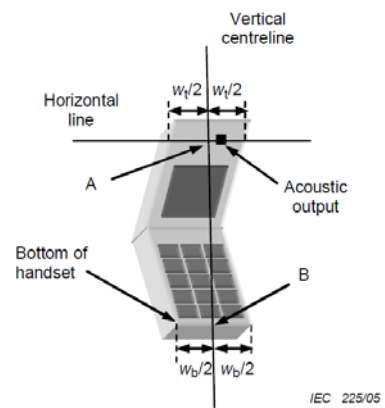

Figures 5b

- W_t Width of the handset at the level of the acoustic
- W_b Width of the bottom of the handset
- A Midpoint of the width w_t of the handset at the level of the acoustic output
- B Midpoint of the width w_b of the bottom of the handset

Cheek position

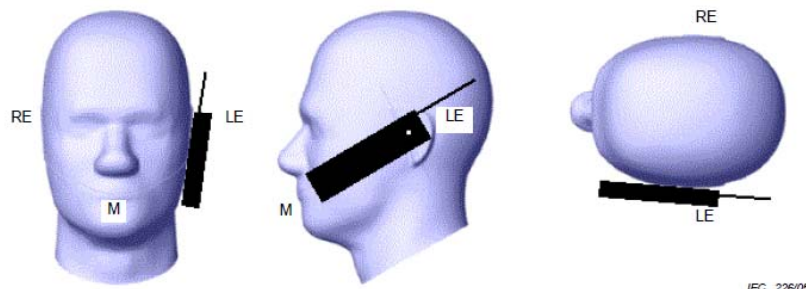

Picture 2 Cheek position of the wireless device on the left side of SAM

Tilt position

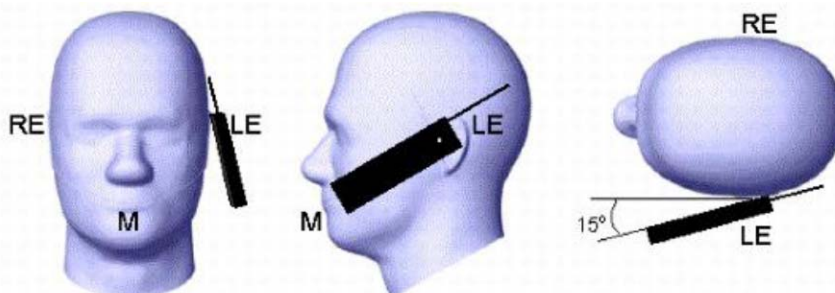

Picture 3 Tilt position of the wireless device on the left side of SAM

8.2. Body Position

Devices that support transmission while used with body-worn accessories must be tested for body-worn accessory SAR compliance, typically according to the smallest test separation distance required for the group of body-worn accessories with similar operating and exposure characteristics. Devices that are designed to operate on the body of users using lanyards and straps or without requiring additional body-worn accessories must be tested for SAR compliance using a conservative minimum test separation distance $\leq 5 \text{ mm}$ to support compliance

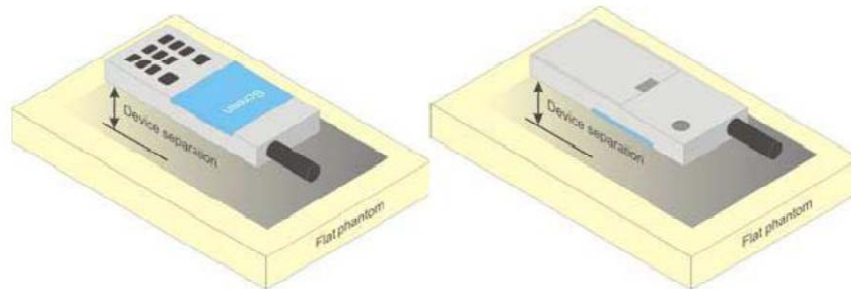

Picture 4 Test positions for body-worn devices

8.3. Hotspot Mode Exposure conditions

The hotspot mode and body-worn accessory SAR test configurations may overlap for handsets. When the same wireless mode transmission configurations for voice and data are required for SAR measurements, the more conservative configuration with a smaller separation distance should be tested for the overlapping SAR configurations. This typically applies to the back and front surfaces of a handset when SAR is required for both hotspot mode and body-worn accessory exposure conditions. Depending on the form factor and dimensions of a device, the test separation distance used for hotspot mode SAR measurement is either **10 mm** or that used in the body-worn accessory configuration, whichever is less for devices with dimension $> 9 \text{ cm} \times 5 \text{ cm}$. For smaller devices with dimensions $\leq 9 \text{ cm} \times 5 \text{ cm}$ because of a greater potential for next to body use a test separation of $\leq 5 \text{ mm}$ must be used.

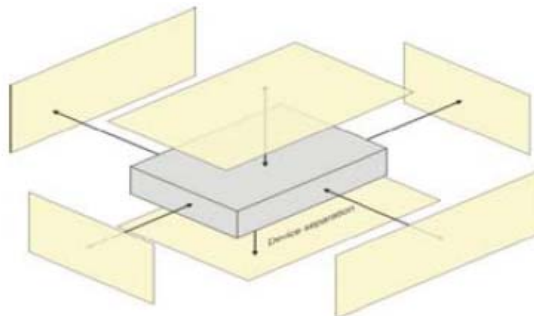

Picture 5 Test positions for Hotspot Mode

9. System Check

9.1. Tissue Dielectric Parameters

The liquid is consisted of water,salt,Glycol,Sugar,Preventol and Cellulose.The liquid has previously been proven to be suited for worst-case.The table 3 and table 4 show the detail solition.It's satisfying the latest tissue dielectric parameters requirements proposed by the KDB865664.

Frequency (MHz)	Water (%)	Sugar (%)	Cellulose (%)	Salt (%)	Preventol (%)	DGBE (%)	Conductivity (σ)	Permittivity (ϵ_r)
For Head								
835	40.3	57.9	0.2	1.4	0.2	0	0.9	41.5
1800,1900,2000	55.2	0	0	0.3	0	44.5	1.4	40
2450	55	0	0	0	0	45	1.8	39.2
For Body								
835	50.8	48.2	0	0.9	0.1	0	0.97	55.2
1800.1900.2000	70.2	0	0	0.4	0	29.4	1.52	53.3
2450	68.6	0	0	0	0	31.4	1.95	52.7

Tissue dielectric parameters for head and body phantoms				
Target Frequency (MHz)	Head		Body	
	ϵ_r	σ (s/m)	ϵ_r	σ (s/m)
750	41.94	0.89	55.5	0.96
835	41.5	0.90	55.2	0.97
1800-2000	40.0	1.40	53.3	1.52
2450	39.2	1.80	52.7	1.95
2600	39.0	1.96	52.5	2.16

Check Result:

Dielectric performance of Head tissue simulating liquid				
Frequency (MHz)	Description	DielectricParameters		Temp
		ϵ_r	σ (s/m)	°C
835	Recommended result ±5% window	41.50 39.43 to 43.58	0.90 0.86 to 0.95	/
	Measurement value 2017-01-16	41.62	0.92	21
1750	Recommended result ±5% window	40.10 38.10- 42.11	1.37 1.30 - 1.44	/
	Measurement value 2017-01-18	40.73	1.41	21
1900	Recommended result ±5% window	40.0 38.00 to 42.00	1.40 1.33 to 1.47	/
	Measurement value 2017-01-22	40.05	1.42	21
2450	Recommended result ±5% window	39.2 37.24 to 41.16	1.80 1.71 to 1.89	/
	Measurement value 2017-01-24	39.11	1.79	21
2600	Recommended result ±5% window	39.0 37.05 to 40.95	1.96 1.86 to 2.06	/
	Measurement value 2017-01-24	38.83	1.93	21

Dielectric performance of Body tissue simulating liquid				
Frequency (MHz)	Description	DielectricParameters		Temp
		ϵ_r	σ (s/m)	°C
835	Recommended result ±5% window	55.2 52.44 to 57.96	0.97 0.92 to 1.02	/
	Measurement value 2017-01-16	55.15	0.96	21
1750	Recommended result ±5% window	53.4 50.73–56.07	1.49 1.42 - 1.56	/
	Measurement value 2017-01-22	53.52	1.44	21
1900	Recommended result ±5% window	53.3 50.64 to 55.97	1.52 1.44 to 1.60	/
	Measurement value 2017-01-18	53.12	1.53	21
2450	Recommended result ±5% window	52.7 50.07 to 55.34	1.95 1.85 to 2.05	/
	Measurement value 2017-01-24	52.52	1.94	21
2600	Recommended result ±5% window	52.5 49.88 to 55.13	2.16 2.05 to 2.27	/
	Measurement value 2017-01-24	51.12	2.14	21

9.2. SAR System Check

The purpose of the system check is to verify that the system operates within its specifications at the device test frequency. The system check is simple check of repeatability to make sure that the system works correctly at the time of the compliance test;

System check results have to be equal or near the values determined during dipole calibration with the relevant liquids and test system ($\pm 10\%$).

System check is performed regularly on all frequency bands where tests are performed with the DASY5 system.

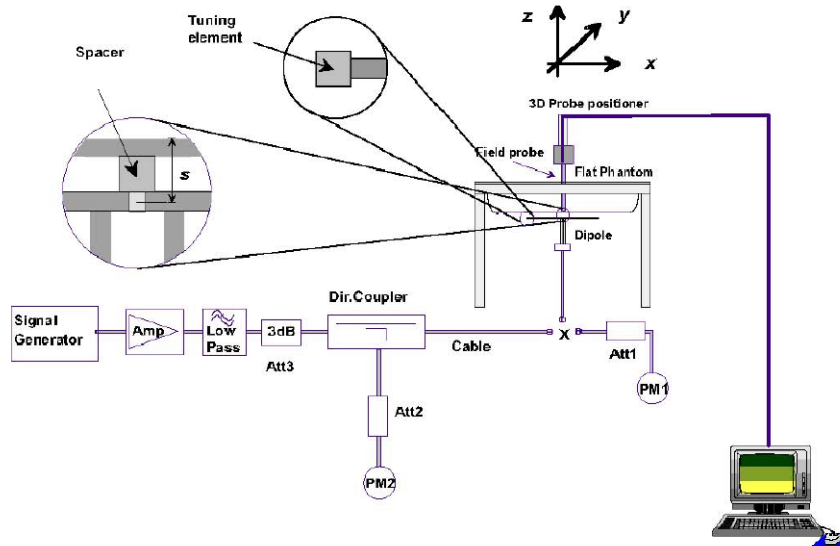

The output power on dipole port must be calibrated to 24 dBm (250mW) before dipole is connected.

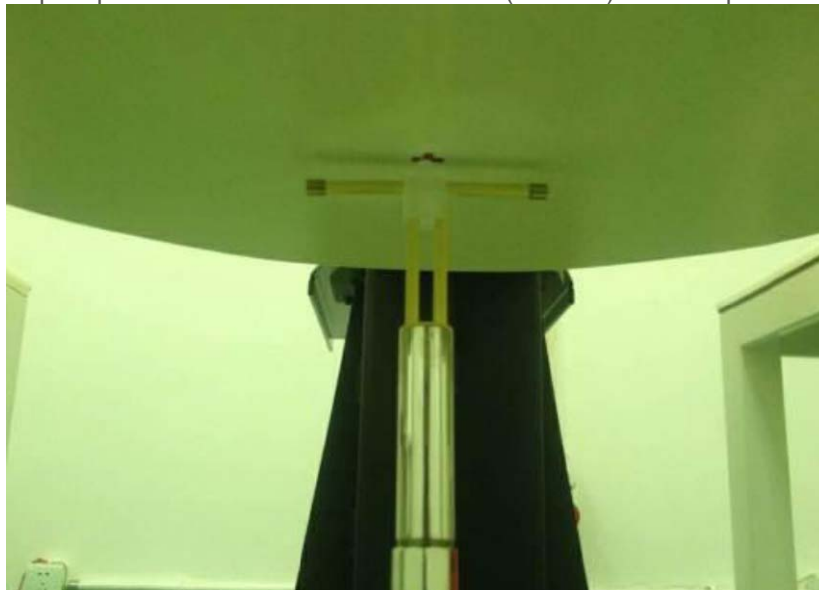

Photo of Dipole Setup

Check Result:

Head				
Frequency (MHz)	Description	SAR(W/kg)		Temp
		1g	10g	°C
835	Recommended result ±5% window	2.41 2.29 - 2.53	1.57 1.49 - 1.65	/
	Measurement value 2017-01-16	2.34	1.52	21
1750	Recommended result ±5% window	9.20 8.28 - 10.12	4.97 4.48 - 5.46	/
	Measurement value 2017-01-18	9.62	4.98	21
1900	Recommended result ±5% window	10.10 9.60 - 10.61	5.34 5.07 - 5.61	/
	Measurement value 2017-01-22	9.72	5.16	21
2450	Recommended result ±5% window	13.1 11.79 - 14.41	6.17 5.56 - 6.78	/
	Measurement value 2017-01-24	12.40	5.80	21
2600	Recommended result ±5% window	13.7 13.02 - 14.39	6.07 5.77 - 6.37	/
	Measurement value 2017-01-24	14.20	6.29	21

Body				
Frequency (MHz)	Description	SAR(W/kg)		Temp
		1g	10g	°C
835	Recommended result ±5% window	2.47 2.35 - 2.59	1.64 1.55 - 1.71	/
	Measurement value 2017-01-16	2.47	1.59	21
1750	Recommended result ±5% window	9.22 8.76 - 9.68	4.95 4.70 - 5.20	/
	Measurement value 2017-01-22	9.30	4.99	21
1900	Recommended result ±5% window	10.20 9.69 - 10.71	5.47 5.20 - 5.74	/
	Measurement value 2017-01-18	10.3	5.34	21
2450	Recommended result ±5% window	13.1 11.79 - 14.41	6.11 5.50 - 6.72	/
	Measurement value 2017-01-24	12.5	5.76	21
2600	Recommended result ±5% window	13.2 12.54 - 13.86	5.87 5.58 - 6.16	/
	Measurement value 2017-01-24	13.8	6.01	21

Note:

1. the graph results see follow.
2. Recommended Values used derive from the calibration certificate and 250 mW is used as feeding power to the calibrated dipole.

System Performance Check at 835 MHz Head

DUT: Dipole 835 MHz; Type: D835V2; Serial: 4d134

Date:2017-01-16

Communication System: CW; Frequency: 835 MHz;Duty Cycle: 1:1

Medium parameters used (interpolated): $f = 835$ MHz; $\sigma = 0.92$ S/m; $\epsilon_r = 41.62$; $\rho = 1000$ kg/m³

Phantom section: Flat Section

DASY5 Configuration:

- Probe: ES3DV3 - SN3292; ConvF(6.53, 6.53, 6.53); Calibrated: 02/09/2016;
- Sensor-Surface: 4mm (Mechanical Surface Detection)
- Electronics: DAE4 Sn1315; Calibrated: 26/07/2016
- Phantom: SAM 1; Type: SAM;
- Measurement SW: DASY52, Version 52.8 (2); SEMCAD X Version 14.6.6 (6824)

Area Scan (61x91x1):Measurement grid: dx=15.00 mm, dy=15.00 mm

Maximum value of SAR (interpolated) = 2.834 mW/g

Zoom Scan (5x5x7)/Cube 0: Measurement grid: dx=5mm, dy=5mm, dz=5mm

Reference Value = 49.865 V/m; Power Drift = -0.01 dB

Peak SAR (extrapolated) = 3.286 W/kg

SAR(1 g) = 2.34 mW/g; SAR(10 g) = 1.52 mW/g

Maximum value of SAR (measured) = 2.825 mW/g

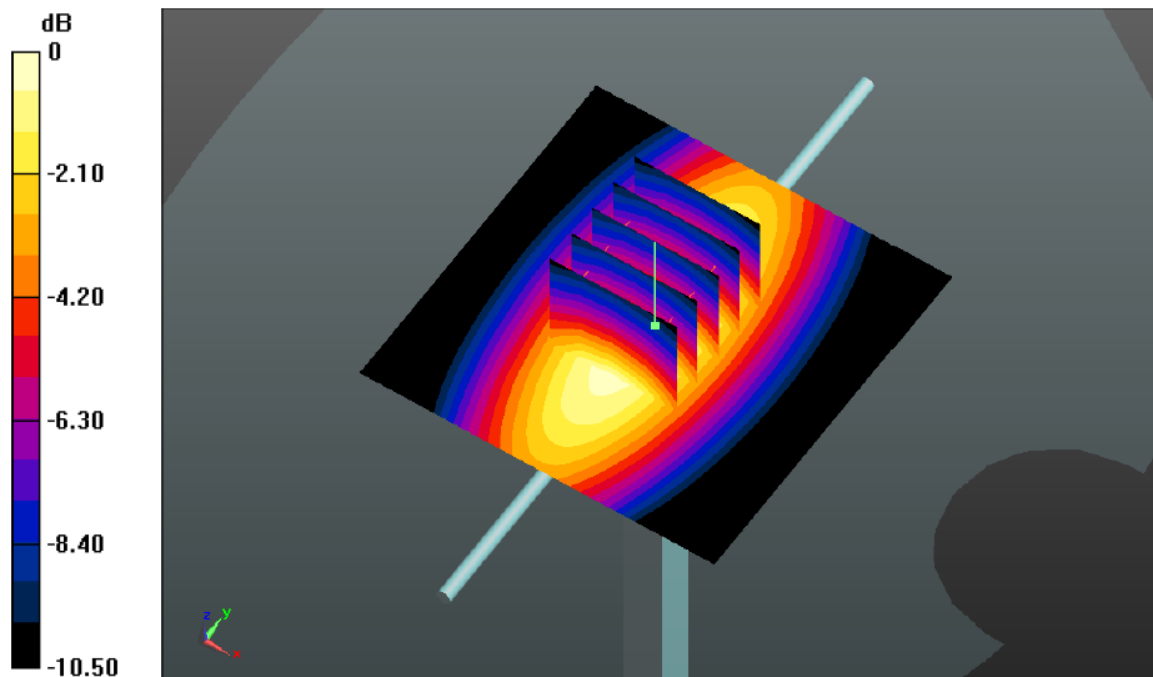

System Performance Check 835MHz Head 250mW

System Performance Check at 835 MHz Body

DUT: Dipole 835 MHz; Type: D835V2; Serial: 4d134

Date:2017-01-16

Communication System: CW; Frequency: 835 MHz;Duty Cycle: 1:1

Medium parameters used (interpolated): $f = 835$ MHz; $\sigma = 0.96$ S/m; $\epsilon_r = 55.15$; $\rho = 1000$ kg/m³

Phantom section: Flat Section

DASY5 Configuration:

- Probe: ES3DV3 - SN3292; ConvF(6.27, 6.27, 6.27); Calibrated: 02/09/2016;
- Sensor-Surface: 4mm (Mechanical Surface Detection)
- Electronics: DAE4 Sn1315; Calibrated: 26/07/2016
- Phantom: SAM 1; Type: SAM;
- Measurement SW: DASY52, Version 52.8 (2); SEMCAD X Version 14.6.6 (6824)

Area Scan (61x91x1):Measurement grid: dx=15.00 mm, dy=15.00 mm

Maximum value of SAR (interpolated) = 2.888 mW/g

Zoom Scan (5x5x7)/Cube 0: Measurement grid: dx=8mm, dy=8mm, dz=5mm

Reference Value = 50.236 V/m; Power Drift = -0.02 dB

Peak SAR (extrapolated) = 3.339 W/kg

SAR(1 g) = 2.47 mW/g; SAR(10 g) = 1.59 mW/g

Maximum value of SAR (measured) = 2.871 mW/g

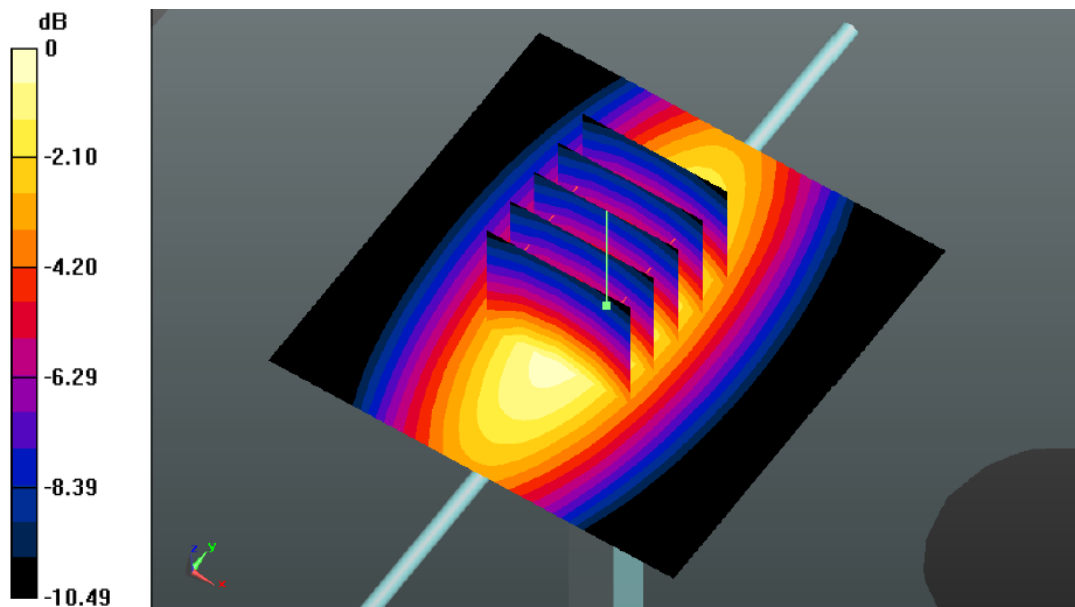

System Performance Check 835MHz Body 250mW

System Performance Check at 1750 MHz Head

DUT: Dipole 1750 MHz; Type: D1750V2; Serial: D1750V2

Date:2017-01-18

Communication System: CW; Frequency: 1750 MHz;Duty Cycle: 1:1

Medium parameters used (interpolated): $f = 1750$ MHz; $\sigma = 1.41$ S/m; $\epsilon_r = 40.73$; $\rho = 1000$ kg/m³

Phantom section: Flat Section

DASY5 Configuration:

Probe: ES3DV3 - SN3292; ConvF(5.54,5.54,5.54); Calibrated: 02/09/2016;

Sensor-Surface: 3mm (Mechanical Surface Detection)

Electronics: DAE4 Sn1315; Calibrated: 26/07/2016

Phantom: SAM 1; Type: SAM;

Measurement SW: DASY52, Version 52.8 (1); SEMCAD X Version 14.6.5 (6469)

Area Scan (61x91x1): Measurement grid: dx=15.00 mm, dy=15.00 mm

Maximum value of SAR (interpolated) = 12.6 W/kg

Zoom Scan (7x7x5)/Cube 0: Measurement grid: dx=5mm, dy=5mm, dz=5mm

Reference Value = 99.561 V/m; Power Drift = -0.03 dB

Peak SAR (extrapolated) = 16.828 mW/g

SAR(1 g) = 9.62 mW/g; SAR(10 g) = 4.98 mW/g

Maximum value of SAR (measured) = 13.0 W/kg

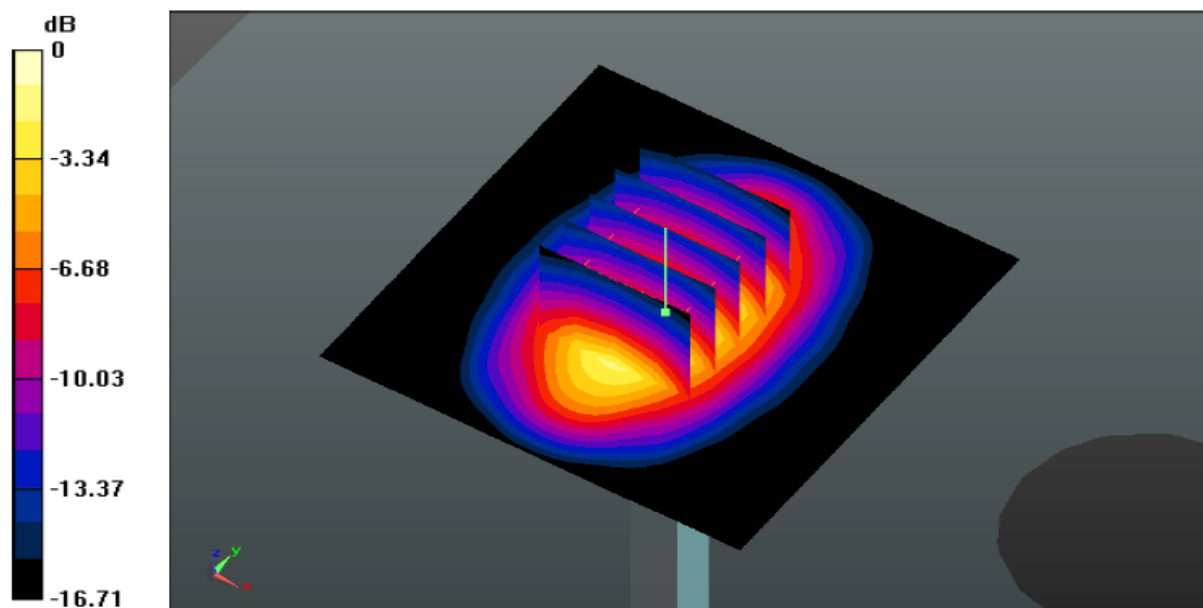

System Performance Check 1750MHz 250mW

System Performance Check at 1750 MHz Body

DUT: Dipole 1750 MHz; Type: D1750V2; Serial: D1750V2

Date:2017-01-22

Communication System: CW; Frequency: 1750 MHz;Duty Cycle: 1:1

Medium parameters used (interpolated): $f = 1750$ MHz; $\sigma = 1.44$ S/m; $\epsilon_r = 53.52$; $\rho = 1000$ kg/m³

Phantom section: Flat Section

DASY5 Configuration:

Probe: ES3DV3 - SN3292; ConvF(5.28,5.28,5.28); Calibrated: 02/09/2016;

Sensor-Surface: 3mm (Mechanical Surface Detection)

Electronics: DAE4 Sn1315; Calibrated: 26/07/2016

Phantom: SAM 1; Type: SAM;

Measurement SW: DASY52, Version 52.8 (1); SEMCAD X Version 14.6.5 (6469)

AreaScan(61x61x1):Measurementgrid:dx=15mm,dy=15mm

MaximumvalueofSAR(interpolated)=13.354mW/g

ZoomScan(5x5x7)/Cube0:Measurementgrid:dx=8mm,dy=8mm,dz=5mm

ReferenceValue=87.582V/m;PowerDrift=-0.06dB

Peak SAR (extrapolated) = 16.752 W/kg

SAR(1 g) = 9.30 mW/g; SAR(10 g) = 4.99 mW/g

Maximum value of SAR (measured) = 13.273 mW/g

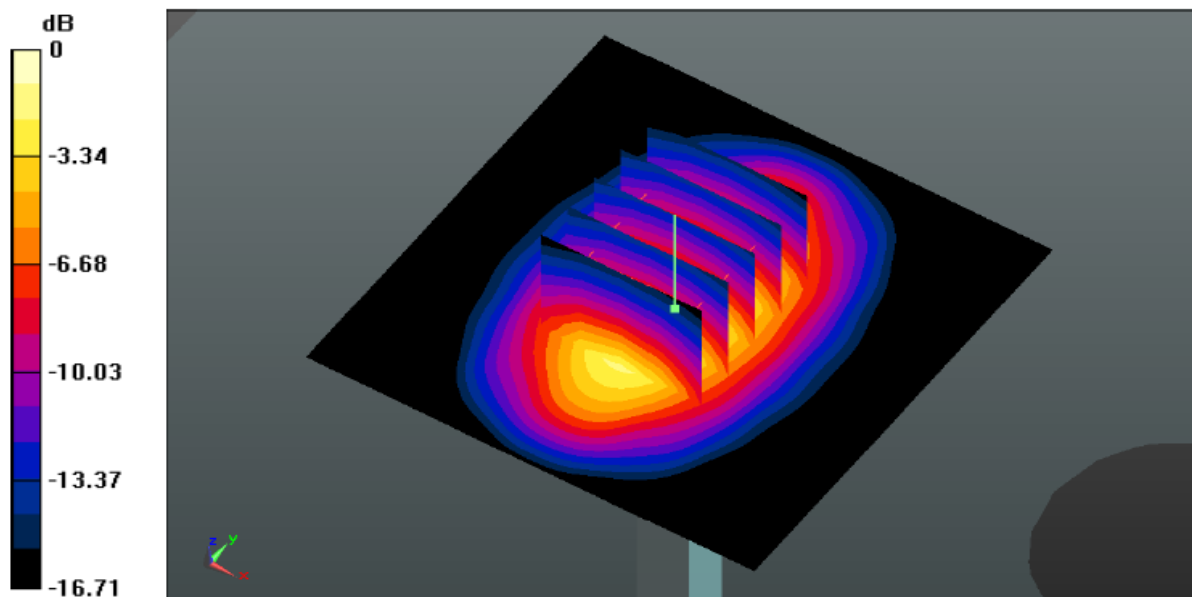

System Performance Check 1750MHz 250mW

System Performance Check at 1900 MHz Head

DUT: Dipole 1900 MHz; Type: D1900V2; Serial: 5d150

Date:2017-01-22

Communication System: CW; Frequency: 1900 MHz;Duty Cycle: 1:1

Medium parameters used (interpolated): $f = 1900$ MHz; $\sigma = 1.42$ S/m; $\epsilon_r = 40.05$; $\rho = 1000$ kg/m³

Phantom section: Flat Section

DASY5 Configuration:

Probe: ES3DV3 - SN3292; ConvF(5.26,5.26,5.26); Calibrated: 02/09/2016;

Sensor-Surface: 3mm (Mechanical Surface Detection)

Electronics: DAE4 Sn1315; Calibrated: 26/07/2016

Phantom: SAM 1; Type: SAM;

Measurement SW: DASY52, Version 52.8 (1); SEMCAD X Version 14.6.5 (6469)

Area Scan (61x91x1):Measurement grid: dx=15.00 mm, dy=15.00 mm

Maximum value of SAR (interpolated) = 10.61 W/kg

Zoom Scan (5x5x7)/Cube 0: Measurement grid: dx=5mm, dy=5mm, dz=5mm

Reference Value = 94.79 V/m; Power Drift = -0.06 dB

Peak SAR (extrapolated) = 12.34 W/kg

SAR(1 g) = 9.72 W/kg; SAR(10 g) = 5.16 W/kg

Maximum value of SAR (measured) = 12.44 W/kg

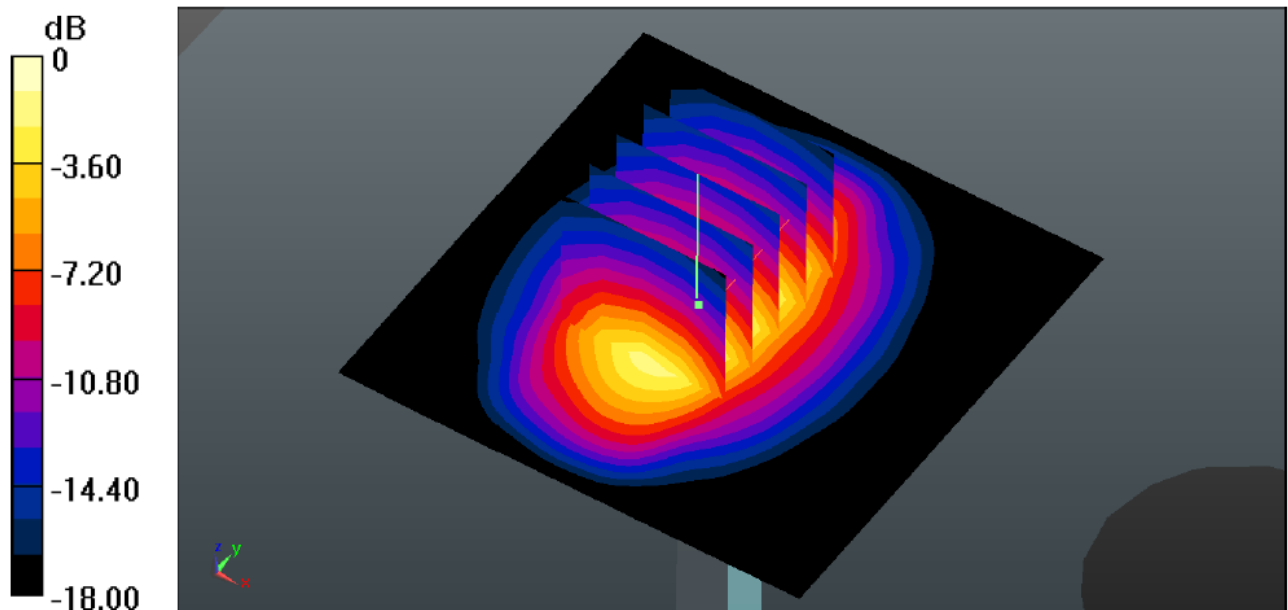

System Performance Check 1900MHz Head 250mW

System Performance Check at 1900 MHz Body

DUT: Dipole 1900 MHz; Type: D1900V2; Serial: 5d150

Date:2017-01-18

Communication System: CW; Frequency: 1900 MHz;Duty Cycle: 1:1

Medium parameters used (interpolated): $f = 1900$ MHz; $\sigma = 1.53$ S/m; $\epsilon_r = 53.12$; $\rho = 1000$ kg/m³

Phantom section: Flat Section

DASY5 Configuration:

Probe: ES3DV3 - SN3292; ConvF(5.05,5.05,5.05); Calibrated: 02/09/2016;

Sensor-Surface: 3mm (Mechanical Surface Detection)

Electronics: DAE4 Sn1315; Calibrated: 26/07/2016

Phantom: SAM 1; Type: SAM;

Measurement SW: DASY52, Version 52.8 (1); SEMCAD X Version 14.6.5 (6469)

Area Scan (61x91x1):Measurement grid: dx=15.00 mm, dy=15.00 mm

Maximum value of SAR (interpolated) = 15.187 mW/g

Zoom Scan (5x5x7)/Cube 0: Measurement grid: dx=8mm, dy=8mm, dz=5mm

Reference Value = 87.679 V/m; Power Drift = -0.14 dB

Peak SAR (extrapolated) = 19.027 W/kg

SAR(1 g) = 10.3 mW/g; SAR(10 g) = 5.34 mW/g

Maximum value of SAR (measured) = 15.09 mW/g

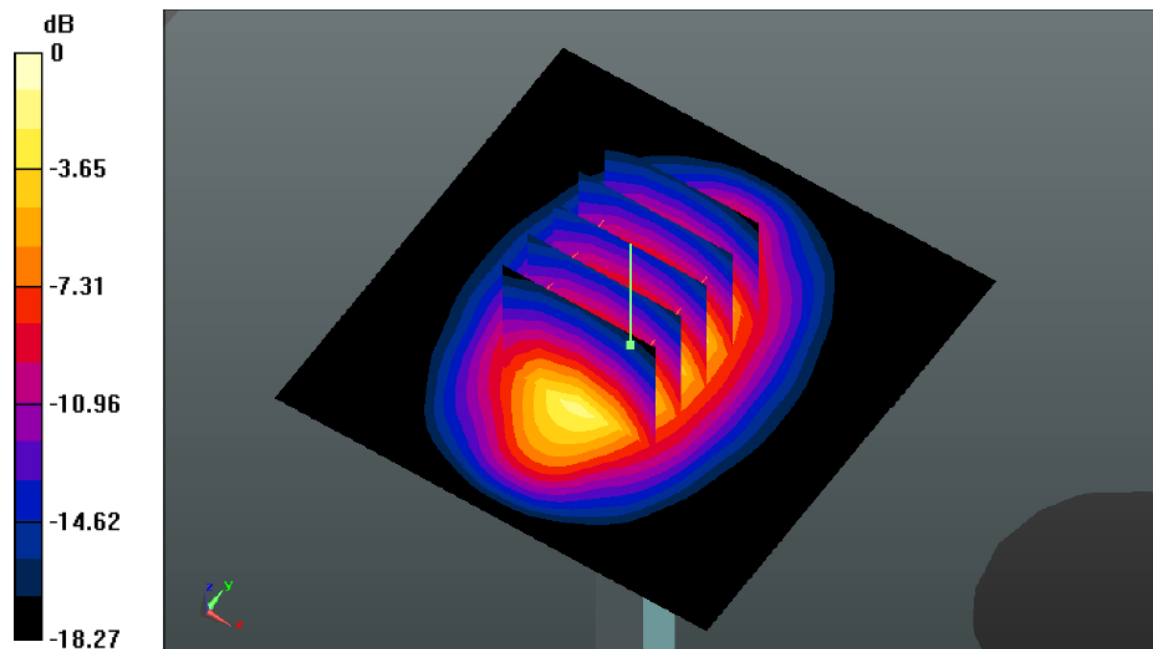

System Performance Check 1900MHz Body250mW

System Performance Check at 2450 MHz Head

DUT: Dipole 2450 MHz; Type: D2450V2; Serial: 884
Date:2017-01-24

Communication System: CW; Frequency: 2450 MHz;Duty Cycle: 1:1

Medium parameters used (interpolated): $f = 2450$ MHz; $\sigma = 1.79$ S/m; $\epsilon_r = 39.11$; $\rho = 1000$ kg/m³

Phantom section: Flat Section

DASY5 Configuration:

Probe: ES3DV3 - SN3292; ConvF(4.97,4.97,4.97); Calibrated: 02/09/2016;

Sensor-Surface: 3mm (Mechanical Surface Detection)

Electronics: DAE4 Sn1315; Calibrated: 26/07/2016

Phantom: SAM 1; Type: SAM;

Measurement SW: DASY52, Version 52.8 (1); SEMCAD X Version 14.6.5 (6469)

Area Scan (61x91x1):Measurement grid: dx=10.00 mm, dy=10.00 mm

Maximum value of SAR (interpolated) = 19.313 mW/g

Zoom Scan (7x7x7)/Cube 0: Measurement grid: dx=5mm, dy=5mm, dz=5mm

Reference Value = 84.314 V/m; Power Drift = 0.02 dB

Peak SAR (extrapolated) = 25.703 W/kg

SAR(1 g) = 12.4 mW/g; SAR(10 g) = 5.8 mW/g

Maximum value of SAR (measured) = 18.871 mW/g

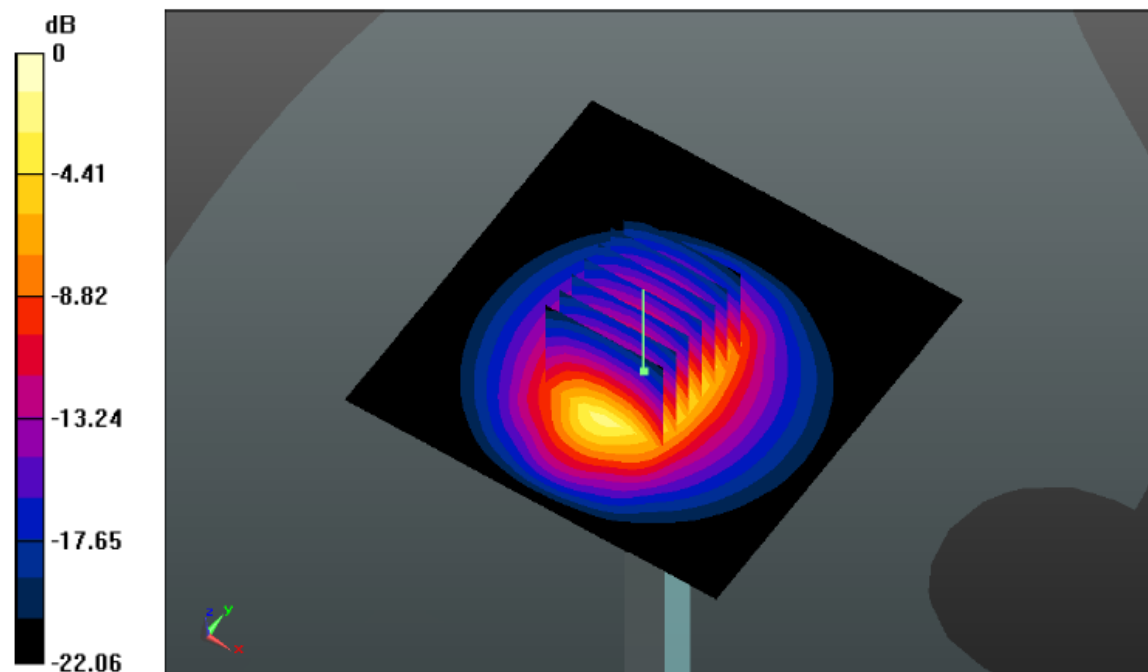

System Performance Check 2450MHz Head250mW

System Performance Check at 2450 MHz Body

Date:2017-01-24

DUT: Dipole 2450 MHz; Type: D2450V2; Serial: 884

Communication System: CW; Frequency: 2450 MHz;Duty Cycle: 1:1

Medium parameters used (interpolated): $f = 2450$ MHz; $\sigma = 1.94$ S/m; $\epsilon_r = 52.52$; $\rho = 1000$ kg/m³

Phantom section: Flat Section

DASY5 Configuration:

Probe: ES3DV3 - SN3292; ConvF(4.70,4.70,4.70); Calibrated: 02/09/2016;

Sensor-Surface: 3mm (Mechanical Surface Detection)

Electronics: DAE4 Sn1315; Calibrated: 26/07/2016

Phantom: SAM 1; Type: SAM;

Measurement SW: DASY52, Version 52.8 (1); SEMCAD X Version 14.6.5 (6469)

Area Scan (61x91x1):Measurement grid: dx=10.00 mm, dy=10.00 mm

Maximum value of SAR (interpolated) = 19.266 mW/g

Zoom Scan (7x7x7)/Cube 0: Measurement grid: dx=5mm, dy=5mm, dz=5mm

Reference Value = 84.170 V/m; Power Drift = 0.03 dB

Peak SAR (extrapolated) = 26.174 W/kg

SAR(1 g) = 12.5 mW/g; SAR(10 g) = 5.76 mW/g

Maximum value of SAR (measured) = 19.27mW/g

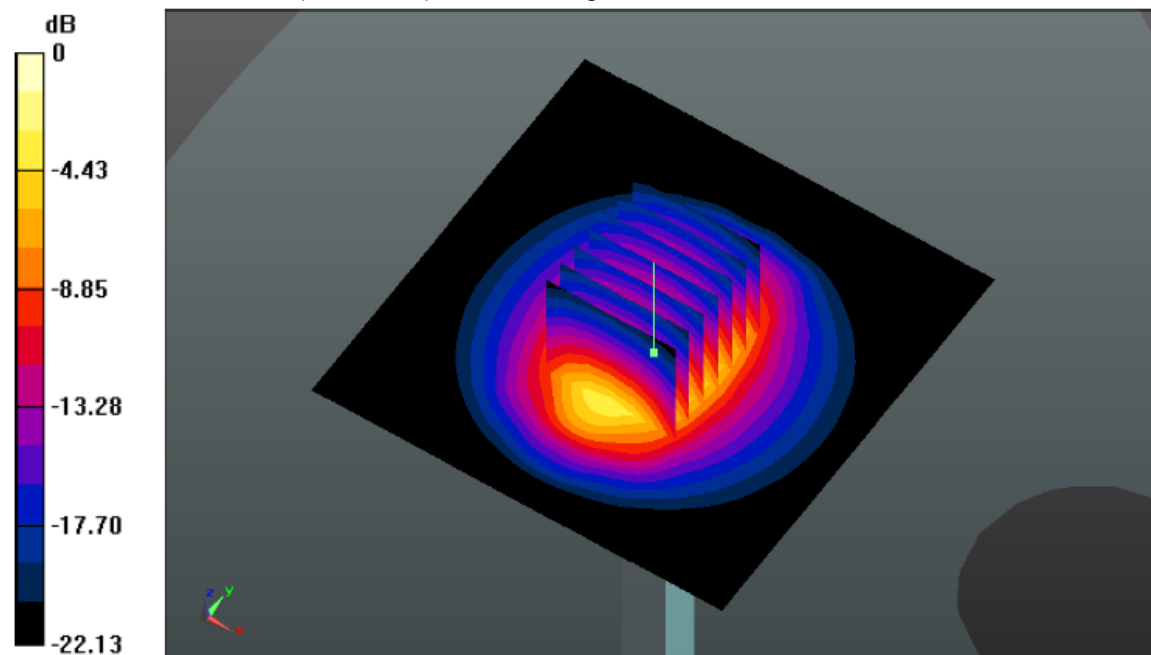

System Performance Check 2450MHz Body250mW

System Performance Check at 2600 MHz Head

DUT: Dipole 2600 MHz; Type: D2600V2; Serial: 1120

Date:2017-01-24

Communication System: CW; Frequency: 2600 MHz;Duty Cycle: 1:1

Medium parameters used (interpolated): $f = 2600$ MHz; $\sigma = 1.93$ S/m; $\epsilon_r = 38.83$; $\rho = 1000$ kg/m³

Phantom section: Flat Section

DASY5 Configuration:

Probe: ES3DV3 - SN3292; ConvF(4.77,4.77,4.77); Calibrated: 02/09/2016;

Sensor-Surface: 3mm (Mechanical Surface Detection)

Electronics: DAE4 Sn1315; Calibrated: 26/07/2016

Phantom: SAM 1; Type: SAM;

Measurement SW: DASY52, Version 52.8 (1); SEMCAD X Version 14.6.5 (6469)

Area Scan (61x91x1):Measurement grid: dx=10.00 mm, dy=10.00 mm

Maximum value of SAR (interpolated) = 22.8 mW/g

Zoom Scan (7x7x7)/Cube 0: Measurement grid: dx=5mm, dy=5mm, dz=5mm

Reference Value = 110.2 V/m; Power Drift = 0.09 dB

Peak SAR (extrapolated) = 33.1 W/kg

SAR(1 g) = 14.2 W/kg; SAR(10 g) = 6.29 W/kg

Maximum value of SAR (measured) = 25.6 W/kg

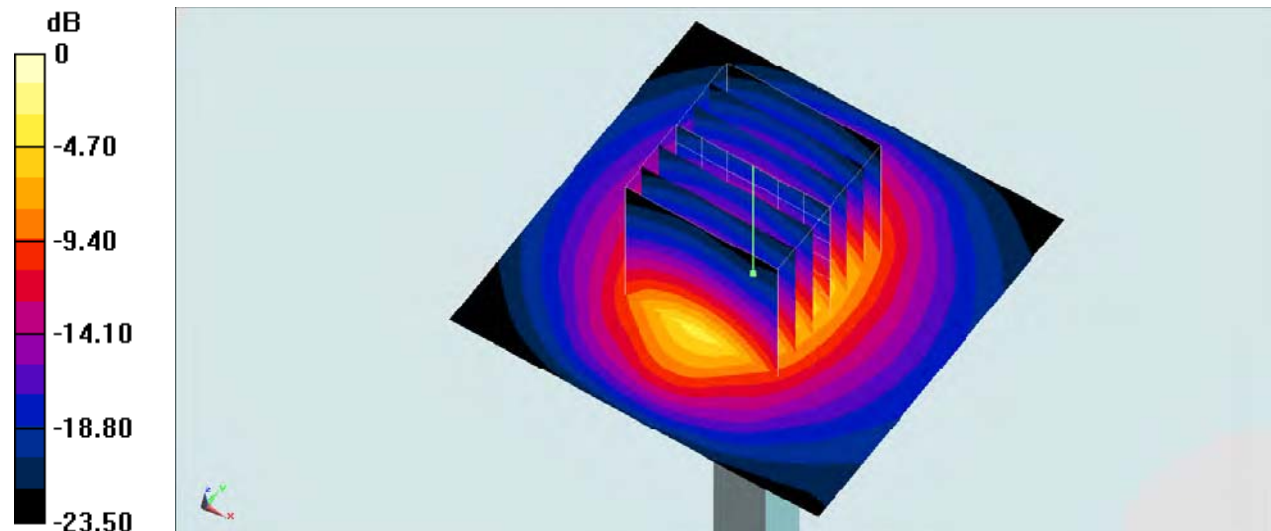

System Performance Check 2600MHz Head250mW

System Performance Check at 2600 MHz Body

Date:2017-01-24

DUT: Dipole 2600 MHz; Type: D2600V2; Serial: 1120

Communication System: CW; Frequency: 2600 MHz;Duty Cycle: 1:1

Medium parameters used (interpolated): $f = 2600$ MHz; $\sigma = 2.14$ S/m; $\epsilon_r = 51.12$; $\rho = 1000$ kg/m³

Phantom section: Flat Section

DASY5 Configuration:

Probe: ES3DV3 - SN3292; ConvF(4.52,4.52,4.52); Calibrated: 02/09/2016;

Sensor-Surface: 3mm (Mechanical Surface Detection)

Electronics: DAE4 Sn1315; Calibrated: 26/07/2016

Phantom: SAM 1; Type: SAM;

Measurement SW: DASY52, Version 52.8 (1); SEMCAD X Version 14.6.5 (6469)

Area Scan (61x91x1):Measurement grid: dx=10.00 mm, dy=10.00 mm

Maximum value of SAR (interpolated) = 24.6 mW/g

Zoom Scan (7x7x7)/Cube 0: Measurement grid: dx=5mm, dy=5mm, dz=5mm

Reference Value = 108.4 V/m; Power Drift = -0.02 dB

Peak SAR (extrapolated) = 30.0 W/kg

SAR(1 g) = 13.8 W/kg; SAR(10 g) = 6.01 W/kg

Maximum value of SAR (measured) = 23.8 W/kg

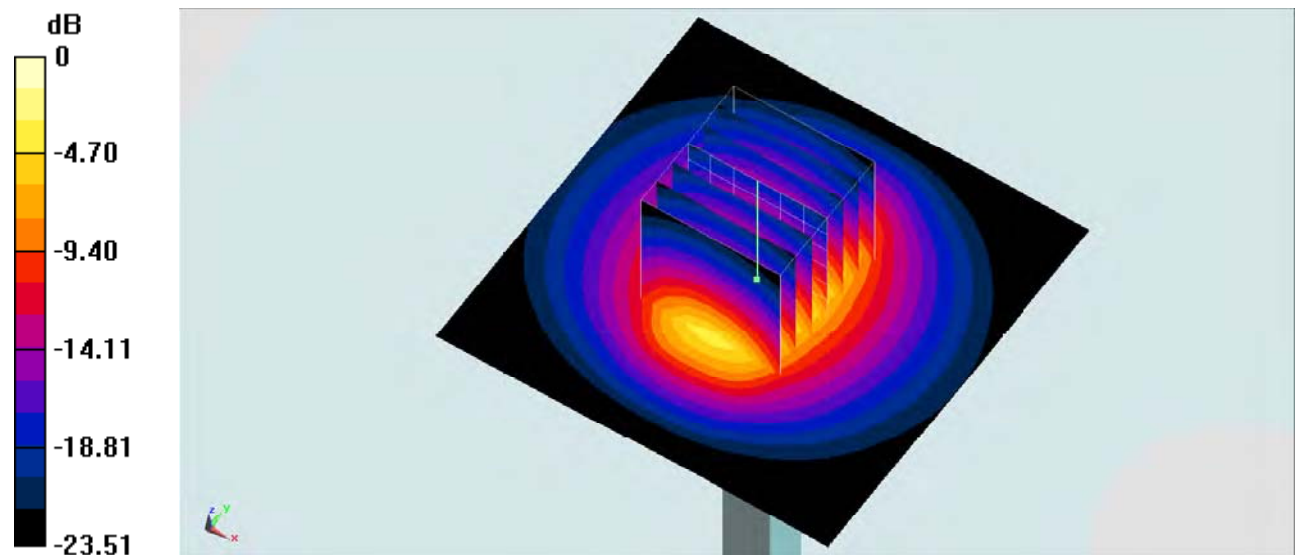

System Performance Check 2600MHz Body250mW

10. SAR Exposure Limits

SAR assessments have been made in line with the requirements of ANSI/IEEE C95.1-1992

Type Exposure	Limit (W/kg)	
	General Population / Uncontrolled Exposure Environment	Occupational / Controlled Exposure Environment
Spatial Average SAR (whole body)	0.08	0.4
Spatial Peak SAR (1g cube tissue for head and trunk)	1.60	8.0
Spatial Peak SAR (10g for limb)	4.0	20.0

Population/Uncontrolled Environments: are defined as locations where there is the exposure of individual who have no knowledge or control of their exposure.

Occupational/Controlled Environments: are defined as locations where there is exposure that may be incurred by people who are aware of the potential for exposure (i.e. as a result of employment or occupation).

11. Conducted Power Measurement Results

GSM Conducted Power

1. Per KDB 447498 D01, the maximum output power channel is used for SAR testing and further SAR test reduction
2. Per KDB 941225 D01, considering the possibility of e.g. 3rd party VoIP operation for Head and Body-worn SAR test reduction for GSM and GPRS modes is determined by the source-base time-averaged output power including tune-up tolerance. The mode with highest specified time-averaged output power should be tested for SAR compliance in the applicable exposure conditions. For modes with the same specified maximum output power and tolerance, the higher number time-slot configuration should be tested. Therefore, the EUT was set in GPRS (4Tx slots) for GSM850 and GPRS (4Tx slots) for PCS1900.
3. Per KDB941225 D01, for hotspot SAR test reduction for GPRS modes is determined by the source-based time-averaged output power including tune-up tolerance, For modes with the same specified maximum output power and tolerance, the higher number time-slot configuration should be tested. Therefore, the EUT was set in GPRS (4Tx slots) for GSM850 and GPRS (4Tx slots) for PCS1900.

Mode: GSM850		Conducted Power (dBm)			Division Factors	Averager Power (dBm)		
		CH128	CH190	CH251		CH128	CH190	CH251
		824.2MHz	836.6MHz	848.8MHz		824.2MHz	836.6MHz	848.8MHz
GSM		32.02	31.76	31.79	-9.03	22.99	22.73	22.76
GPRS (GMSK)	1TXslot	31.99	31.73	31.77	-9.03	22.96	22.70	22.74
	2TXslots	29.49	29.32	29.35	-6.02	23.47	23.30	23.33
	3TXslots	27.82	27.62	27.63	-4.26	23.56	23.36	23.37
	4TXslots	26.61	26.40	26.41	-3.01	23.60	23.39	23.40
Mode: PCS1900		Conducted Power (dBm)			Division Factors	Averager Power (dBm)		
		CH512	CH661	CH810		CH512	CH661	CH810
		1850.2MHz	1880.0MHz	1909.8MHz		1850.2MHz	1880.0MHz	1909.8MHz
GSM		29.44	29.15	28.96	-9.03	20.41	20.12	19.93
GPRS (GMSK)	1TXslot	29.41	29.12	28.95	-9.03	20.38	20.09	19.92
	2TXslots	27.11	26.91	26.73	-6.02	21.09	20.89	20.71
	3TXslots	25.57	25.35	25.17	-4.26	21.31	21.09	20.91
	4TXslots	24.47	24.23	24.06	-3.01	21.46	21.22	21.05

Note:

1) Division Factors

To average the power, the division factor is as follows:

1TX-slot = 1 transmit time slot out of 8 time slots=> conducted power divided by (8/1) => -9.03dB

2TX-slots = 2 transmit time slots out of 8 time slots=> conducted power divided by (8/2) => -6.02dB

3TX-slots = 3 transmit time slots out of 8 time slots=> conducted power divided by (8/3) => -4.26dB

4TX-slots = 4 transmit time slots out of 8 time slots=> conducted power divided by (8/4) => -3.01dB

WCDMA Conducted Power

1. The following tests were conducted according to the test requirements outlines in 3GPP TS34.121 specification.
2. The procedures in KDB 941225 D01 are applied for 3GPP Rel. 6 HSPA to configure the device in the required sub-test mode to determine SAR test exclusion

A summary of these settings are illustrated below:

HSDPA Setup Configuration:

- a) The EUT was connected to base station RS CMU200 referred to the setup configuration
- b) The RF path losses were compensated into the measurements
- c) A call was established between EUT and base station with following setting:
 - i. Set Gain Factors (β_c and β_d) and parameters were set according to each specific sub-test in the following table, C10.1.4, Quoted from the TS 34.121
 - ii. Set RMC 12.2Kbps + HSDPA mode
 - iii. Set Cell Power=-86dBm
 - iv. Set HS-DSCH Configuration Type to FRC (H-set 1, QPSK)
 - v. Select HSDPA uplink parameters
 - vi. Set Delta ACK, Delta NACK and Delta CQI=8
 - vii. Set Ack-Nack repetition Factor to 3
 - viii. Set CQI Feedback Cycle (K) to 4ms
 - ix. Set CQI repetition factor to 2
 - x. Power ctrl mode= all up bits
- d) The transmitter maximum output power was recorded.

Table C.10.1.4: β values for transmitter characteristics tests with HS-DPCCH

Sub-test	β_c	β_d	β_d (SF)	β_c/β_d	β_{HS} (Note 1, Note 2)	CM (dB) (Note 3)	MPR (dB) (Note 3)
1	2/15	15/15	64	2/15	4/15	0.0	0.0
2	12/15 (Note 4)	15/15 (Note 4)	64	12/15 (Note 4)	24/15	1.0	0.0
3	15/15	8/15	64	15/8	30/15	1.5	0.5
4	15/15	4/15	64	15/4	30/15	1.5	0.5

Note 1: Δ_{ACK} , Δ_{NACK} and $\Delta_{CQI} = 30/15$ with $\beta_{HS} = 30/15 * \beta_c$.

Note 2: For the HS-DPCCH power mask requirement test in clause 5.2C, 5.7A, and the Error Vector Magnitude (EVM) with HS-DPCCH test in clause 5.13.1A, and HSDPA EVM with phase discontinuity in clause 5.13.1AA, Δ_{ACK} and $\Delta_{NACK} = 30/15$ with $\beta_{HS} = 30/15 * \beta_c$, and $\Delta_{CQI} = 24/15$ with $\beta_{HS} = 24/15 * \beta_c$.

Note 3: CM = 1 for $\beta_c/\beta_d = 12/15$, $\beta_{HS}/\beta_c = 24/15$. For all other combinations of DPDCH, DPCCH and HS-DPCCH the MPR is based on the relative CM difference. This is applicable for only UEs that support HSDPA in release 6 and later releases.

Note 4: For subtest 2 the β_c/β_d ratio of 12/15 for the TFC during the measurement period (TF1, TF0) is achieved by setting the signalled gain factors for the reference TFC (TF1, TF1) to $\beta_c = 11/15$ and $\beta_d = 15/15$.

Setup Configuration

HSUPA Setup Configuration:

- a) The EUT was connected to base station RS CMU200 referred to the setup configuration
- b) The RF path losses were compensated into the measurements
- c) A call was established between EUT and base station with following setting:
 - i. Call configs = 5.2b, 5.9b, 5.10b, and 5.13.2B with QPSK
 - ii. Set Gain Factors (β_c and β_d) and parameters (AG index) were set according to each specific sub-test in the following table, C11.1.3, Quoted from the TS 34.121
 - iii. Set Cell Power=-86dBm
 - iv. Set channel type= 12.2Kbps + HSPA mode
 - v. Set UE Target power
 - vi. Set Ctrl mode=Alternating bits
 - vii. Set and observe the E-TFCI
 - viii. Confirm that E-TFCI is equal the target E-TFCI of 75 for Sub-test 1, and other subtest's E-TFCI
- d) The transmitter maximum output power was recorded.

Table C.11.1.3: β values for transmitter characteristics tests with HS-DPCCH and E-DCH

Sub-test	β_c	β_d	β_d (SF)	β_c/β_d	β_{HS} (Note 1)	β_{EC}	β_{ed} (Note 5) (Note 6)	β_{ed} (SF)	β_{ed} (Codes)	CM (dB) (Note 2)	MPR (dB) (Note 2)	AG Index (Note 6)	E-TFCI
1	11/15 (Note 3)	15/15 (Note 3)	64	11/15 (Note 3)	22/15	209/25	1309/225	4	1	1.0	0.0	20	75
2	6/15	15/15	64	6/15	12/15	12/15	94/75	4	1	3.0	2.0	12	67
3	15/15	9/15	64	15/9	30/15	30/15	$\beta_{ed1}: 47/15$ $\beta_{ed2}: 47/15$	4 4	2	2.0	1.0	15	92
4	2/15	15/15	64	2/15	4/15	2/15	56/75	4	1	3.0	2.0	17	71
5	15/15 (Note 4)	15/15 (Note 4)	64	15/15 (Note 4)	30/15	24/15	134/15	4	1	1.0	0.0	21	81

Note 1: $\Delta_{ACK}, \Delta_{NACK}$ and $\Delta_{CQI} = 30/15$ with $\beta_{HS} = 30/15 * \beta_c$.

Note 2: CM = 1 for $\beta_c/\beta_d = 12/15$, $\beta_{HS}/\beta_c = 24/15$. For all other combinations of DPDCH, DPCCH, HS-DPCCH, E-DPDCH and E-DPCCH the MPR is based on the relative CM difference.

Note 3: For subtest 1 the β_c/β_d ratio of 11/15 for the TFC during the measurement period (TF1, TF0) is achieved by setting the signalled gain factors for the reference TFC (TF1, TF0) to $\beta_c = 10/15$ and $\beta_d = 15/15$.

Note 4: For subtest 5 the β_c/β_d ratio of 15/15 for the TFC during the measurement period (TF1, TF0) is achieved by setting the signalled gain factors for the reference TFC (TF1, TF0) to $\beta_c = 14/15$ and $\beta_d = 15/15$.

Note 5: In case of testing by UE using E-DPDCH Physical Layer category 1, Sub-test 3 is omitted according to TS25.306 Table 5.1g.

Note 6: β_{ed} can not be set directly, it is set by Absolute Grant Value.

Setup Configuration**General Note:**

1. Per KDB 941225 D01, SAR for Head / Hotspot / Body-worn Exposure is measured using a 12.2Kbps RMC with TPC bit configured to all 1s
2. Per KDB 941225 D01 RMC12.2Kbps setting is used to evaluate SAR. If the maximum output power and Tune-up tolerance specified for production units in HSDPA/HSUPA is $\leq 1/4$ dB higher than RMC 12.2Kbps or when the highest reported SAR of the RMC12.2Kbps is scaled by the ratio of specified maximum output power and tune-up tolerance of HSDPA / HSUPA to RMC 12.2Kbps and the adjusted SAR is ≤ 1.2 W/kg, SAR measurement is not required for HSDPA / HSUPA.

Mode		WCDMA Band V			WCDMA Band II		
		Conducted Power (dBm)			Conducted Power (dBm)		
		CH4132	CH4183	CH4233	CH9262	CH9400	CH9538
		826.4	836.6	846.6	1852.4	1880.0	1907.6
AMR 12.2K		21.51	21.43	21.36	21.95	21.71	21.82
RMC 12.2K		21.53	21.47	21.37	21.97	21.74	21.83
HSDPA	Subtest-1	19.78	19.70	19.64	20.18	19.96	20.06
	Subtest-2	19.61	19.54	19.48	20.02	19.80	19.90
	Subtest-3	19.62	19.56	19.47	20.02	19.81	19.89
	Subtest-4	19.36	19.29	19.22	19.76	19.54	19.64
HSUPA	Subtest-1	19.25	19.18	19.12	19.65	19.43	19.53
	Subtest-2	19.10	19.03	18.97	19.49	19.28	19.38
	Subtest-3	19.01	18.94	18.88	19.40	19.19	19.29
	Subtest-4	18.96	18.89	18.83	19.35	19.14	19.23
	Subtest-5	18.91	18.84	18.78	19.30	19.09	19.18

LTE Conducted Power

General Note:

1. CMW500 base station simulator was used to setup the connection with EUT; the frequency band, channel, bandwidth, RB allocation configuration, modulation type are set in the base station simulator to configure EUT transmitting at maximum power and at different configurations which are requested to be reported to FCC, for conducted power measurement and SAR testing.
2. Per KDB 941225 D05v02r03, when a properly configured base station simulator is used for the SAR and power measurements, spectrum plots for each RB allocation and offset configuration is not required.
3. Per KDB 941225 D05v02r03, start with the largest channel bandwidth and measure SAR for QPSK with 1 RB allocation, using the RB offset and required test channel combination with the highest maximum output power for RB offsets at the upper edge, middle and lower edge of each required test channel.
4. Per KDB 941225 D05v02r03, 50% RB allocation for QPSK SAR testing follows 1RB QPSK allocation procedure.
5. Per KDB 941225 D05v02r03, for QPSK with 100% RB allocation, SAR is not required when the highest maximum output power for 100 % RB allocation is less than the highest maximum output power in 50% and 1 RB allocations and the highest reported SAR for 1 RB and 50% RB allocation are ≤ 0.8 W/kg. Otherwise, SAR is measured for the highest output power channel; and if the reported SAR is > 1.45 W/kg, the remaining required test channels must also be tested.
6. Per KDB 941225 D05v02r03, 16QAM output power for each RB allocation configuration is $>$ not $\frac{1}{2}$ dB higher than the same configuration in QPSK and the reported SAR for the QPSK configuration is ≤ 1.45 W/kg; Per KDB 941225 D05v02r03, 16QAM SAR testing is not required.
7. Per KDB 941225 D05v02r03, smaller bandwidth output power for each RB allocation configuration is $>$ not $\frac{1}{2}$ dB higher than the same configuration in the largest supported bandwidth, and the reported SAR for the largest supported bandwidth is ≤ 1.45 W/kg; Per KDB 941225 D05v02r03, smaller bandwidth SAR testing is not required.

LTE-FDD Band 2				Actual output Power (dBm)		
Band-width	RAllocation	ROffset	Modulation	Low	Middle	High
1.4 MHz				1850.7MHz	1880MHz	1909.3MHz
	1RB	High	QPSK	20.86	20.93	20.81
			16QAM	19.99	20.05	19.94
		Middle	QPSK	20.85	20.92	20.78
			16QAM	20.00	20.07	19.95
		Low	QPSK	20.87	20.89	20.78
			16QAM	20.02	20.07	19.96
	3RB	High	QPSK	20.74	20.82	20.68
			16QAM	19.76	19.81	19.69
		Middle	QPSK	20.75	20.80	20.69
			16QAM	19.78	19.84	19.70
		Low	QPSK	20.74	20.83	20.71
			16QAM	19.76	19.83	19.71
	6RB	/	QPSK	19.91	19.99	19.84
16QAM			18.85	18.92	18.80	
3 MHz				1851.5MHz	1880MHz	1908.5MHz
	1RB	High	QPSK	20.84	20.90	20.79
			16QAM	20.03	20.08	19.97
		Middle	QPSK	20.82	20.90	20.77
			16QAM	20.04	20.11	19.98
		Low	QPSK	20.84	20.91	20.79
			16QAM	20.02	20.08	19.96
	8RB	High	QPSK	20.19	20.25	20.12
			16QAM	19.14	19.20	19.09
		Middle	QPSK	20.14	20.18	20.09
			16QAM	19.13	19.20	19.07
		Low	QPSK	20.15	20.21	20.10
			16QAM	19.15	19.20	19.11
	15RB	/	QPSK	20.11	20.19	20.07
16QAM			19.12	19.21	19.05	
5 MHz				1852.5MHz	1880MHz	1907.5MHz
	1RB	High	QPSK	20.82	20.88	20.77
			16QAM	20.02	20.08	19.97
		Middle	QPSK	20.84	20.91	20.79
			16QAM	20.04	20.11	19.97
		Low	QPSK	20.83	20.88	20.76
			16QAM	20.02	20.08	19.97
	12RB	High	QPSK	20.20	20.28	20.12
			16QAM	19.19	19.29	19.14
		Middle	QPSK	20.20	20.27	20.15
			16QAM	19.20	19.27	19.13
		Low	QPSK	20.19	20.25	20.14
			16QAM	19.22	19.28	19.17
	25RB	/	QPSK	20.17	20.24	20.12
16QAM			19.16	19.22	19.10	

10 MHz	1RB	High	QPSK	20.83	20.89	20.77
			16QAM	20.01	20.07	19.96
		Middle	QPSK	20.84	20.91	20.78
			16QAM	20.03	20.10	19.96
		Low	QPSK	20.84	20.91	20.78
			16QAM	20.03	20.08	19.97
	25RB	High	QPSK	20.16	20.24	20.12
			16QAM	19.19	19.26	19.14
		Middle	QPSK	20.16	20.24	20.12
			16QAM	19.23	19.28	19.16
		Low	QPSK	20.15	20.22	20.10
			16QAM	19.21	19.27	19.16
	50RB	/	QPSK	20.18	20.24	20.11
			16QAM	19.17	19.23	19.10
15 MHz				1857.5MHz	1880MHz	1902.5MHz
	1RB	High	QPSK	20.86	20.92	20.81
			16QAM	20.02	20.08	19.97
		Middle	QPSK	20.83	20.92	20.77
			16QAM	20.03	20.11	19.97
		Low	QPSK	20.85	20.91	20.80
			16QAM	20.04	20.10	19.99
	36RB	High	QPSK	20.18	20.25	20.13
			16QAM	19.19	19.24	19.13
		Middle	QPSK	20.16	20.24	20.09
			16QAM	19.21	19.27	19.14
		Low	QPSK	20.19	20.27	20.15
			16QAM	19.17	19.24	19.12
	75RB	/	QPSK	20.09	20.16	20.04
16QAM			19.12	19.20	19.07	
20 MHz				1860MHz	1880MHz	1900MHz
	1RB	High	QPSK	20.82	20.91	20.87
			16QAM	20.02	20.10	20.08
		Middle	QPSK	20.85	20.92	20.90
			16QAM	20.05	20.10	20.07
		Low	QPSK	20.87	20.93	20.92
			16QAM	20.05	20.11	20.10
	50RB	High	QPSK	20.19	20.28	20.15
			16QAM	19.17	19.26	19.22
		Middle	QPSK	20.18	20.25	20.23
			16QAM	19.23	19.30	19.28
		Low	QPSK	20.19	20.25	20.24
			16QAM	19.24	19.30	19.29
	100RB	/	QPSK	20.12	20.21	20.15
16QAM			19.11	19.20	19.14	

LTE-FDD Band 4				Actual output Power (dBm)		
Band-width	RAllocation	ROffset	Modulation	Low	Middle	High
1.4 MHz				1710.7MHz	1732.5MHz	1754.3MHz
	1RB	High	QPSK	22.35	22.42	22.34
			16QAM	21.48	21.54	21.47
		Middle	QPSK	22.34	22.41	22.31
			16QAM	21.49	21.56	21.48
		Low	QPSK	22.36	22.38	22.31
			16QAM	21.51	21.56	21.49
	3RB	High	QPSK	22.23	22.31	22.21
			16QAM	21.25	21.30	21.22
		Middle	QPSK	22.24	22.29	22.22
			16QAM	21.27	21.33	21.23
		Low	QPSK	22.23	22.32	22.24
			16QAM	21.25	21.32	21.24
	6RB	/	QPSK	21.40	21.48	21.37
16QAM			20.34	20.41	20.33	
3 MHz				1711.5MHz	1732.5MHz	1753.5MHz
	1RB	High	QPSK	22.33	22.39	22.32
			16QAM	21.52	21.57	21.50
		Middle	QPSK	22.31	22.39	22.30
			16QAM	21.53	21.60	21.51
		Low	QPSK	22.33	22.40	22.32
			16QAM	21.51	21.57	21.49
	8RB	High	QPSK	21.68	21.74	21.65
			16QAM	20.63	20.69	20.62
		Middle	QPSK	21.63	21.67	21.62
			16QAM	20.62	20.69	20.60
		Low	QPSK	21.64	21.70	21.63
			16QAM	20.64	20.69	20.64
	15RB	/	QPSK	21.60	21.68	21.60
16QAM			20.61	20.70	20.58	
5 MHz				1712.5MHz	1732.5MHz	1752.5MHz
	1RB	High	QPSK	22.31	22.37	22.30
			16QAM	21.51	21.57	21.50
		Middle	QPSK	22.33	22.40	22.32
			16QAM	21.53	21.60	21.50
		Low	QPSK	22.32	22.37	22.29
			16QAM	21.51	21.57	21.50
	12RB	High	QPSK	21.69	21.77	21.65
			16QAM	20.68	20.78	20.67
		Middle	QPSK	21.69	21.76	21.68
			16QAM	20.69	20.76	20.66
		Low	QPSK	21.68	21.74	21.67
			16QAM	20.71	20.77	20.70
	25RB	/	QPSK	21.66	21.73	21.65
16QAM			20.65	20.71	20.63	

				1715MHz	1732.5MHz	1750MHz	
10 MHz	1RB	High	QPSK	22.32	22.38	22.30	
			16QAM	21.50	21.56	21.49	
		Middle	QPSK	22.33	22.40	22.31	
			16QAM	21.52	21.59	21.49	
		Low	QPSK	22.33	22.40	22.31	
			16QAM	21.52	21.57	21.50	
	25RB	High	QPSK	21.65	21.73	21.65	
			16QAM	20.68	20.75	20.67	
		Middle	QPSK	21.65	21.73	21.65	
			16QAM	20.72	20.77	20.69	
		Low	QPSK	21.64	21.71	21.63	
			16QAM	20.70	20.76	20.69	
	50RB	/	QPSK	21.67	21.73	21.64	
			16QAM	20.66	20.72	20.63	
15 MHz				1717.5MHz	1732.5MHz	1747.5MHz	
	1RB	High	QPSK	22.35	22.41	22.34	
			16QAM	21.51	21.57	21.50	
		Middle	QPSK	22.32	22.41	22.30	
			16QAM	21.52	21.60	21.50	
		Low	QPSK	22.34	22.40	22.33	
			16QAM	21.53	21.59	21.52	
	36RB	High	QPSK	21.67	21.74	21.66	
			16QAM	20.68	20.73	20.66	
		Middle	QPSK	21.65	21.73	21.62	
			16QAM	20.70	20.76	20.67	
		Low	QPSK	21.68	21.76	21.68	
			16QAM	20.66	20.73	20.65	
	75RB	/	QPSK	21.58	21.65	21.57	
			16QAM	20.61	20.69	20.60	
	20 MHz				1720MHz	1732.5MHz	1745MHz
		1RB	High	QPSK	22.31	22.40	22.30
				16QAM	21.51	21.59	21.51
Middle			QPSK	22.34	22.41	22.33	
			16QAM	21.54	21.59	21.50	
Low			QPSK	22.36	22.42	22.35	
			16QAM	21.54	21.60	21.53	
50RB		High	QPSK	21.68	21.77	21.58	
			16QAM	20.66	20.75	20.65	
		Middle	QPSK	21.67	21.74	21.66	
			16QAM	20.72	20.79	20.71	
		Low	QPSK	21.68	21.74	21.67	
			16QAM	20.73	20.79	20.72	
100RB		/	QPSK	21.61	21.70	21.58	
	16QAM		20.60	20.69	20.57		

LTE-FDD Band 7				Actual output Power (dBm)		
Band-width	RAllocation	RBoffset	Modulation	Low	Middle	High
5 MHz				2502.5MHz	2535MHz	2567.5MHz
	1RB	High	QPSK	21.08	21.15	21.09
			16QAM	20.27	20.31	20.25
		Middle	QPSK	21.10	21.15	21.08
			16QAM	20.32	20.37	20.32
		Low	QPSK	21.10	21.10	21.10
			16QAM	20.31	20.33	20.32
	12RB	High	QPSK	20.24	20.26	20.20
			16QAM	19.25	19.30	19.24
		Middle	QPSK	20.27	20.31	20.27
			16QAM	19.26	19.32	19.24
		Low	QPSK	20.27	20.28	20.20
			16QAM	19.34	19.35	19.22
	25RB			QPSK	20.26	20.34
		16QAM	19.31	19.35	19.27	
10 MHz				2505MHz	2535MHz	2565MHz
	1RB	High	QPSK	21.14	21.16	21.07
			16QAM	20.31	20.35	20.29
		Middle	QPSK	21.14	21.12	21.04
			16QAM	20.35	20.36	20.29
		Low	QPSK	21.09	21.09	21.05
			16QAM	20.32	20.34	20.30
	25RB	High	QPSK	20.22	20.26	20.23
			16QAM	19.24	19.25	19.21
		Middle	QPSK	20.29	20.29	20.23
			16QAM	19.30	19.31	19.28
		Low	QPSK	20.28	20.32	20.19
			16QAM	19.24	19.27	19.25
	50RB			QPSK	20.28	20.28
		16QAM	19.26	19.29	19.24	
15 MHz				2507.5MHz	2535MHz	2562.5MHz
	1RB	High	QPSK	21.09	21.14	21.07
			16QAM	20.31	20.34	20.30
		Middle	QPSK	21.07	21.17	21.09
			16QAM	20.33	20.37	20.32
		Low	QPSK	21.12	21.14	21.07
			16QAM	20.30	20.34	20.32
	36RB	High	QPSK	20.20	20.29	20.22
			16QAM	19.25	19.29	19.22
		Middle	QPSK	20.24	20.30	20.24
			16QAM	19.26	19.31	19.23
		Low	QPSK	20.25	20.25	20.22
			16QAM	19.32	19.34	19.21
	75RB			QPSK	20.26	20.32
		16QAM	19.29	19.31	19.23	

				2510MHz	2535MHz	2560MHz
20 MHz	1RB	High	QPSK	21.10	21.18	21.10
			16QAM	20.34	20.36	20.30
		Middle	QPSK	21.12	21.20	21.15
			16QAM	20.33	20.39	20.33
		Low	QPSK	21.13	21.18	21.12
			16QAM	20.31	20.34	20.29
	50RB	High	QPSK	20.32	20.37	20.22
			16QAM	19.26	19.32	19.23
		Middle	QPSK	20.26	20.31	20.26
			16QAM	19.28	19.32	19.25
		Low	QPSK	20.24	20.27	20.28
			16QAM	19.25	19.32	19.25
	100RB		QPSK	20.29	20.35	20.28
			16QAM	19.28	19.34	19.37

WLAN Conducted Power

For 2.4GHz WLAN SAR testing, highest average RF output power channel for the lowest data rate for 802.11b were for SAR evaluation. 802.11g/n were not investigated since the average putput powers over all channels and data rates were not more than 0.25dB higher than the tested channel in the lowest data rate of 802.11b mode.

WIFI					
Mode	Channel	Frequency (MHz)	Conducted Peak Power (dBm)	Conducted Average Power (dBm)	Data rate
802.11b	01	2412	14.45	12.33	1 Mbps
	06	2437	13.25	11.31	1 Mbps
	11	2462	12.47	10.63	1 Mbps
802.11g	01	2412	11.85	9.28	6 Mbps
	06	2437	11.89	9.29	6 Mbps
	11	2462	12.13	9.49	6 Mbps
802.11n(H20)	01	2412	12.17	9.28	6.5 Mbps
	06	2437	11.96	9.10	6.5 Mbps
	11	2462	12.39	9.43	6.5 Mbps
802.11n(H40)	3	2422	11.89	9.07	13.5 Mbps
	6	2437	12.06	9.18	13.5 Mbps
	9	2452	11.62	8.85	13.5 Mbps

*Note:*The output power was test all data rate and recorded worst case at recorded data rate.

Bluetooth Conducted Power

Bluetooth			
Mode	Channel	Frequency (MHz)	Conducted power (dBm)
GFSK	0	2402	7.06
	39	2441	7.32
	78	2480	7.25
$\pi/4$ QPSK	0	2402	8.03
	39	2441	8.28
	78	2480	8.22
8DPSK	0	2402	8.32
	39	2441	8.56
	78	2480	8.52
BLE	0	2402	-2.02
	19	2440	-1.65
	39	2480	-1.89

Per KDB 447498 D01, the 1-g and 10-g SAR test exclusion thresholds for 100MHz to 6GHz at test separation distances ≥ 50 mm are determined by:

$$[(\text{max. Power of channel, including tune-up tolerance, mW}) / (\text{min. test separation distance, mm})] * [\sqrt{f(\text{GHz})}] \leq 3.0 \text{ for 1-g SAR}$$

Band/Mode	F(GHz)	Position	SAR test exclusion threshold (mW)	RF output power		SAR test exclusion
				dBm	mW	
Bluetooth	2.45	Head	9.6	9	7.94	Yes
		Body	19.2	9	7.94	Yes
WiFi	2.45	Head	9.6	12.5	17.78	No
		Body	19.2	12.5	17.78	No

Per KDB 447498 D01, when the minimum test separation distance is <5mm, a distance of 5mm is applied to determine SAR test exclusion.

The test exclusion threshold is ≤ 3 , SAR testing is not required.

12. Maximum Tune-up Limit

Mode	Burst Average Power (dBm)	
	GSM850	PCS1900
GSM (GMSK, 1Tx Slot)	32.50	30.00
GPRS (GMSK, 1Tx Slot)	32.50	30.00
GPRS (GMSK, 2Tx Slot)	30.00	28.00
GPRS (GMSK, 3Tx Slot)	28.00	26.00
GPRS (GMSK, 4Tx Slot)	27.00	25.00

Mode	Burst Average Power (dBm)	
	WCDMA Band V	WCDMA Band II
AMR 12.2Kbps	22.00	22.00
RMC 12.2Kbps	22.00	22.00
HSDPA Subtest-1	20.00	20.50
HSDPA Subtest-2	20.00	20.50
HSDPA Subtest-3	20.00	20.50
HSDPA Subtest-4	20.00	20.00
HSUPA Subtest-1	19.50	20.00
HSUPA Subtest-2	19.50	20.00
HSUPA Subtest-3	19.50	20.00
HSUPA Subtest-4	19.50	20.00
HSUPA Subtest-5	19.50	20.00

LTE

LTE Band 2			
Channel	Channel 19100	Channel 18900	Channel 18700
Tune-up(dB)	21.5	21.5	21.5
LTE Band 4			
Channel	Channel 20300	Channel 20175	Channel 20050
Tune-up(dB)	23	23	23
LTE Band 7			
Channel	Channel 21350	Channel 21100	Channel 20850
Tune-up(dB)	21.5	21.5	21.5

LTE MPR will follow up 3GPP settings as below:

Modulation	Channel bandwidth / Transmission bandwidth (NRB)						MPR (dB)
	1.4MHz	3.0MHz	5MHz	10MHz	15MHz	20MHz	
QPSK	≤ 5	≤ 4	≤ 8	≤ 12	≤ 16	≤ 18	0
QPSK	> 5	> 4	> 8	> 12	> 16	> 18	1
16 QAM	≤ 5	≤ 4	≤ 8	≤ 12	≤ 16	≤ 18	1
16 QAM	> 5	> 4	> 8	> 12	> 16	> 18	2

WLAN

Mode	Peak Power (dBm)	Burst Average Power (dBm)
802.11b	14.50	12.50
802.11g	12.50	10.00
802.11n(HT20)	12.50	10.00
802.11n(HT40)	12.50	10.00

Bluetooth

Mode	Channel	Frequency (MHz)	Conducted power (dBm)
GFSK	0	2402	8.00
	39	2441	8.00
	78	2480	8.00
π/4QPSK	0	2402	9.00
	39	2441	9.00
	78	2480	9.00
8DPSK	0	2402	9.00
	39	2441	9.00
	78	2480	9.00
BLE	0	2402	-1.50
	19	2440	-1.50
	39	2480	-1.50

13. Antenna Location

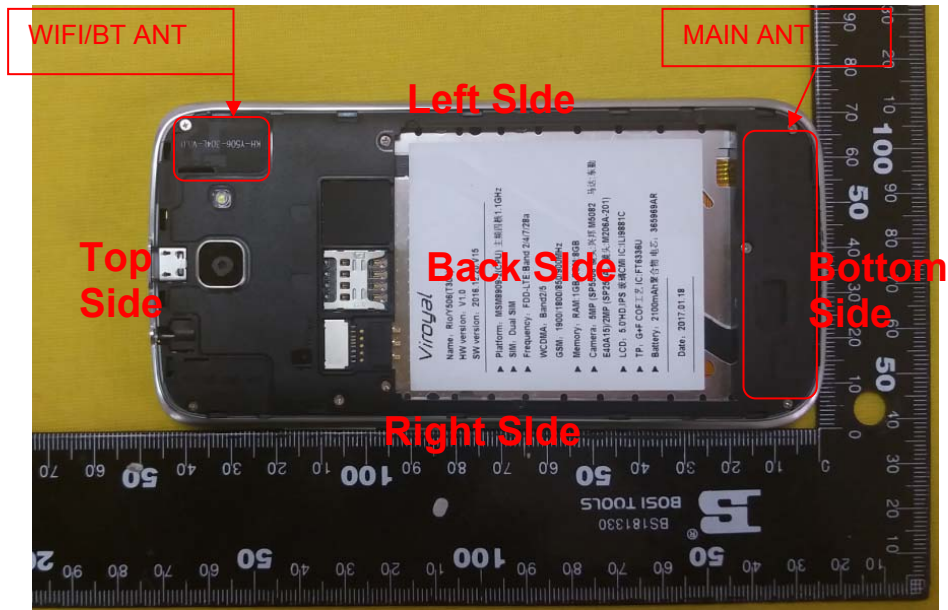

Positions for SAR tests; Hotspot mode						
Antenna	Back	Front	Top side	Bottom side	Right side	Left side
WWAN	Yes	Yes	No	Yes	Yes	Yes
WIFI / BT	Yes	Yes	Yes	No	No	Yes

General note:

Referring to KDB941225 D06, when the overall device length and width are >9cm*5cm, the test distance is 10mm. SAR must be measured for all sides and surfaces with a transmitting antenna located within 25mm from that surface or edge.

14. SAR Measurement Results

Head SAR

GSM850										
Mode	Test Position	Frequency		Conducted Power (dBm)	Tune up limit (dBm)	Tune up scaling factor	Power Drift(dB)	Measured SAR(1g) (W/kg)	Report SAR(1g) (W/kg)	Test Plot
		CH	MHz							
GPRS (4Tx slot)	Left-Cheek	128	824.2	26.61	27.00	1.09	-	-	-	-
		190	836.6	26.40	27.00	1.15	0.01	0.210	0.24	H1
		251	848.8	26.41	27.00	1.15	-	-	-	-
	Left-Tilt	128	824.2	26.61	27.00	1.09	-	-	-	-
		190	836.6	26.40	27.00	1.15	-0.01	0.161	0.18	-
		251	848.8	26.41	27.00	1.15	-	-	-	-
	Right-Cheek	128	824.2	26.61	27.00	1.09	-	-	-	-
		190	836.6	26.40	27.00	1.15	0.00	0.198	0.23	-
		251	848.8	26.41	27.00	1.15	-	-	-	-
	Right-Tilt	128	824.2	26.61	27.00	1.09	-	-	-	-
		190	836.6	26.40	27.00	1.15	0.01	0.158	0.18	-
		251	848.8	26.41	27.00	1.15	-	-	-	-

PCS1900										
Mode	Test Position	Frequency		Conducted Power (dBm)	Tune up limit (dBm)	Tune up scaling factor	Power Drift(dB)	Measured SAR(1g) (W/kg)	Report SAR(1g) (W/kg)	Test Plot
		CH	MHz							
GPRS (4Tx slot)	Left-Cheek	512	1850.2	24.47	25.00	1.13	-	-	-	-
		661	1880.0	24.23	25.00	1.19	0.17	0.062	0.07	H2
		810	1909.8	24.06	25.00	1.24	-	-	-	-
	Left-Tilt	512	1850.2	24.47	25.00	1.13	-	-	-	-
		661	1880.0	24.23	25.00	1.19	0.12	0.046	0.06	-
		810	1909.8	24.06	25.00	1.24	-	-	-	-
	Right-Cheek	512	1850.2	24.47	25.00	1.13	-	-	-	-
		661	1880.0	24.23	25.00	1.19	-0.09	0.057	0.07	-
		810	1909.8	24.06	25.00	1.24	-	-	-	-
	Right-Tilt	512	1850.2	24.47	25.00	1.13	-	-	-	-
		661	1880.0	24.23	25.00	1.19	-0.11	0.043	0.05	-
		810	1909.8	24.06	25.00	1.24	-	-	-	-

Note:

Per KDB865664 D01v01r04, Repeated measurement is not required when the original highest measured SAR is < 0.80 W/kg

WCDMA Band V										
Mode	Test Position	Frequency		Conducted Power (dBm)	Tune up limit (dBm)	Tune up scaling factor	Power Drift(dB)	Measured SAR(1g) (W/kg)	Report SAR(1g) (W/kg)	Test Plot
		CH	MHz							
RMC 12.2K bps	Left-Cheek	4132	826.4	21.53	22.00	1.11	-	-	-	-
		4183	836.6	21.47	22.00	1.13	-0.15	0.059	0.07	H3
		4233	846.6	21.37	22.00	1.16	-	-	-	-
	Left-Tilt	4132	826.4	21.53	22.00	1.11	-	-	-	-
		4183	836.6	21.47	22.00	1.13	-0.13	0.049	0.05	-
		4233	846.6	21.37	22.00	1.16	-	-	-	-
	Right-Cheek	4132	826.4	21.53	22.00	1.11	-	-	-	-
		4183	836.6	21.47	22.00	1.13	-0.20	0.056	0.06	-
		4233	846.6	21.37	22.00	1.16	-	-	-	-
	Right-Tilt	4132	826.4	21.53	22.00	1.11	-	-	-	-
		4183	836.6	21.47	22.00	1.13	0.06	0.045	0.05	-
		4233	846.6	21.37	22.00	1.16	-	-	-	-

WCDMA Band II										
Mode	Test Position	Frequency		Conducted Power (dBm)	Tune up limit (dBm)	Tune up scaling factor	Power Drift(dB)	Measured SAR(1g) (W/kg)	Report SAR(1g) (W/kg)	Test Plot
		CH	MHz							
RMC 12.2K bps	Left-Cheek	9262	1852.4	21.97	22.00	1.01	-	-	-	-
		9400	1880.0	21.74	22.00	1.06	0.19	0.172	0.18	H4
		9538	1907.6	21.83	22.00	1.04	-	-	-	-
	Left-Tilt	9262	1852.4	21.97	22.00	1.01	-	-	-	-
		9400	1880.0	21.74	22.00	1.06	0.11	0.138	0.15	-
		9538	1907.6	21.83	22.00	1.04	-	-	-	-
	Right-Cheek	9262	1852.4	21.97	22.00	1.01	-	-	-	-
		9400	1880.0	21.74	22.00	1.06	-0.33	0.164	0.17	-
		9538	1907.6	21.83	22.00	1.04	-	-	-	-
	Right-Tilt	9262	1852.4	21.97	22.00	1.01	-	-	-	-
		9400	1880.0	21.74	22.00	1.06	-0.10	0.125	0.13	-
		9538	1907.6	21.83	22.00	1.04	-	-	-	-

Note:

Per KDB865664 D01v01r04, Repeated measurement is not required when the original highest measured SAR is < 0.80 W/kg

LTE Band II										
Mode	Test Position	Frequency		Conducted Power (dBm)	Tune up limit (dBm)	Tune up scaling factor	Power Drift(dB)	Measured SAR(1g) (W/kg)	Report SAR(1g) (W/kg)	Test Plot
		CH	MHz							
20M_1 RB	Left-Cheek	18700	1860.0	20.82	21.50	1.17	-	-	-	-
		18900	1880.0	20.91	21.50	1.15	0.11	0.114	0.13	H5
		19100	1900.0	20.87	21.50	1.16	-	-	-	-
	Left-Tilt	18700	1860.0	20.82	21.50	1.17	-	-	-	-
		18900	1880.0	20.91	21.50	1.15	-0.12	0.087	0.10	-
		19100	1900.0	20.87	21.50	1.16	-	-	-	-
	Right-Cheek	18700	1860.0	20.82	21.50	1.17	-	-	-	-
		18900	1880.0	20.91	21.50	1.15	-0.05	0.107	0.12	-
		19100	1900.0	20.87	21.50	1.16	-	-	-	-
	Right-Tilt	18700	1860.0	20.82	21.50	1.17	-	-	-	-
		18900	1880.0	20.91	21.50	1.15	0.06	0.086	0.10	-
		19100	1900.0	20.87	21.50	1.16	-	-	-	-
20M_5 ORB	Left-Cheek	18700	1860.0	20.19	20.50	1.07	-	-	-	-
		18900	1880.0	20.28	20.50	1.05	-0.11	0.096	0.10	-
		19100	1900.0	20.15	20.50	1.08	-	-	-	-
	Left-Tilt	18700	1860.0	20.19	20.50	1.07	-	-	-	-
		18900	1880.0	20.28	20.50	1.05	0.12	0.073	0.08	-
		19100	1900.0	20.15	20.50	1.08	-	-	-	-
	Right-Cheek	18700	1860.0	20.19	20.50	1.07	-	-	-	-
		18900	1880.0	20.28	20.50	1.05	0.05	0.091	0.10	-
		19100	1900.0	20.15	20.50	1.08	-	-	-	-
	Right-Tilt	18700	1860.0	20.19	20.50	1.07	-	-	-	-
		18900	1880.0	20.28	20.50	1.05	-0.06	0.072	0.08	-
		19100	1900.0	20.15	20.50	1.08	-	-	-	-

Note:

1. Per KDB865664 D01v01r04, Repeated measurement is not required when the original highest measured SAR is < 0.80 W/kg
2. Per KDB 941225 D05v02r03, for QPSK with 100% RB allocation, SAR is not required when the highest maximum output power for 100 % RB allocation is less than the highest maximum output power in 50% and 1 RB allocations and the highest reported SAR for 1 RB and 50% RB allocation are ≤ 0.8 W/kg. Otherwise, SAR is measured for the highest output power channel; and if the reported SAR is > 1.45 W/kg, the remaining required test channels must also be tested.

LTE Band IV										
Mode	Test Position	Frequency		Conducted Power (dBm)	Tune up limit (dBm)	Tune up scaling factor	Power Drift(dB)	Measured SAR(1g) (W/kg)	Report SAR(1g) (W/kg)	Test Plot
		CH	MHz							
20M_1 RB	Left-Cheek	20050	1720	22.31	23.00	1.17	-	-	-	-
		20175	1732.5	22.40	23.00	1.15	0.03	0.283	0.32	H6
		20300	1745	22.30	23.00	1.17	-	-	-	-
	Left-Tilt	20050	1720	22.31	23.00	1.17	-	-	-	-
		20175	1732.5	22.40	23.00	1.15	0.02	0.210	0.24	-
		20300	1745	22.30	23.00	1.17	-	-	-	-
	Right-Cheek	20050	1720	22.31	23.00	1.17	-	-	-	-
		20175	1732.5	22.40	23.00	1.15	-0.02	0.260	0.30	-
		20300	1745	22.30	23.00	1.17	-	-	-	-
	Right-Tilt	20050	1720	22.31	23.00	1.17	-	-	-	-
		20175	1732.5	22.40	23.00	1.15	-0.02	0.198	0.23	-
		20300	1745	22.30	23.00	1.17	-	-	-	-
20M_5 ORB	Left-Cheek	20050	1720	21.68	22.00	1.08	-	-	-	-
		20175	1732.5	21.77	22.00	1.05	-0.13	0.228	0.24	-
		20300	1745	21.58	22.00	1.10	-	-	-	-
	Left-Tilt	20050	1720	21.68	22.00	1.08	-	-	-	-
		20175	1732.5	21.77	22.00	1.05	-0.09	0.170	0.18	-
		20300	1745	21.58	22.00	1.10	-	-	-	-
	Right-Cheek	20050	1720	21.68	22.00	1.08	-	-	-	-
		20175	1732.5	21.77	22.00	1.05	0.07	0.209	0.22	-
		20300	1745	21.58	22.00	1.10	-	-	-	-
	Right-Tilt	20050	1720	21.68	22.00	1.08	-	-	-	-
		20175	1732.5	21.77	22.00	1.05	0.08	0.160	0.17	-
		20300	1745	21.58	22.00	1.10	-	-	-	-

Note:

1. Per KDB865664 D01v01r04, Repeated measurement is not required when the original highest measured SAR is < 0.80 W/kg
2. Per KDB 941225 D05v02r03, for QPSK with 100% RB allocation, SAR is not required when the highest maximum output power for 100 % RB allocation is less than the highest maximum output power in 50% and 1 RB allocations and the highest reported SAR for 1 RB and 50% RB allocation are ≤ 0.8 W/kg. Otherwise, SAR is measured for the highest output power channel; and if the reported SAR is > 1.45 W/kg, the remaining required test channels must also be tested.

LTE Band VII										
Mode	Test Position	Frequency		Conducted Power (dBm)	Tune up limit (dBm)	Tune up scaling factor	Power Drift(dB)	Measured SAR(1g) (W/kg)	Report SAR(1g) (W/kg)	Test Plot
		CH	MHz							
20M_1 RB	Left-Cheek	20850	2510	21.10	21.50	1.10	-	-	-	-
		21100	2535	21.18	21.50	1.08	0.19	0.164	0.18	H7
		21350	2560	21.10	21.50	1.10	-	-	-	-
	Left-Tilt	20850	2510	21.10	21.50	1.10	-	-	-	-
		21100	2535	21.18	21.50	1.08	0.16	0.135	0.15	-
		21350	2560	21.10	21.50	1.10	-	-	-	-
	Right-Cheek	20850	2510	21.10	21.50	1.10	-	-	-	-
		21100	2535	21.18	21.50	1.08	0.26	0.155	0.17	-
		21350	2560	21.10	21.50	1.10	-	-	-	-
	Right-Tilt	20850	2510	21.10	21.50	1.10	-	-	-	-
		21100	2535	21.18	21.50	1.08	-0.08	0.126	0.14	-
		21350	2560	21.10	21.50	1.10	-	-	-	-
20M_5 ORB	Left-Cheek	20850	2510	20.32	20.50	1.04	-	-	-	-
		21100	2535	20.37	20.50	1.03	-0.11	0.147	0.15	-
		21350	2560	20.22	20.50	1.07	-	-	-	-
	Left-Tilt	20850	2510	20.32	20.50	1.04	-	-	-	-
		21100	2535	20.37	20.50	1.03	-0.09	0.121	0.12	-
		21350	2560	20.22	20.50	1.07	-	-	-	-
	Right-Cheek	20850	2510	20.32	20.50	1.04	-	-	-	-
		21100	2535	20.37	20.50	1.03	-0.15	0.139	0.14	-
		21350	2560	20.22	20.50	1.07	-	-	-	-
	Right-Tilt	20850	2510	20.32	20.50	1.04	-	-	-	-
		21100	2535	20.37	20.50	1.03	0.05	0.112	0.12	-
		21350	2560	20.22	20.50	1.07	-	-	-	-

Note:

1. Per KDB865664 D01v01r04, Repeated measurement is not required when the original highest measured SAR is < 0.80 W/kg
2. Per KDB 941225 D05v02r03, for QPSK with 100% RB allocation, SAR is not required when the highest maximum output power for 100 % RB allocation is less than the highest maximum output power in 50% and 1 RB allocations and the highest reported SAR for 1 RB and 50% RB allocation are ≤ 0.8 W/kg. Otherwise, SAR is measured for the highest output power channel; and if the reported SAR is > 1.45 W/kg, the remaining required test channels must also be tested.

WLAN										
Mode	Test Position	Frequency		Conducted Power (dBm)	Tune up limit (dBm)	Tune up scaling factor	Power Drift(dB)	Measured SAR(1g) (W/kg)	Report SAR(1g) (W/kg)	Test Plot
		CH	MHz							
802.11b 1Mbps	Left-Cheek	01	2412	12.33	12.50	1.04	-0.05	0.126	0.13	H8
		06	2437	11.31	12.50	1.32	-	-	-	-
		11	2462	10.63	12.50	1.54	-	-	-	-
	Left-Tilt	01	2412	12.33	12.50	1.04	0.07	0.107	0.11	-
		06	2437	11.31	12.50	1.32	-	-	-	-
		11	2462	10.63	12.50	1.54	-	-	-	-
	Right-Cheek	01	2412	12.33	12.50	1.04	0.03	0.115	0.12	-
		06	2437	11.31	12.50	1.32	-	-	-	-
		11	2462	10.63	12.50	1.54	-	-	-	-
	Right-Tilt	01	2412	12.33	12.50	1.04	-0.04	0.100	0.10	-
		06	2437	11.31	12.50	1.32	-	-	-	-
		11	2462	10.63	12.50	1.54	-	-	-	-

Note:

- According to the above table, the initial test position for head is “LeftCheek”, and its reported SAR is ≤ 0.4W/kg. Thus further SAR measurement is not required for the other (remaining) test positions. Because the reported SAR of the highest measured maximum output power channel for the exposureconfiguration is ≤ 0.8W/kg, no further SAR testing is required for 802.11b DSSS in that exposureconfiguration.
- When SAR measurement is required for 2.4 GHz 802.11g/n OFDM configurations, the measurement and test reduction procedures for OFDM are applied. SAR is not required for the following 2.4 GHz OFDM conditions.
 - When KDB Publication 447498 D01 SAR test exclusion applies to the OFDM configuration.
 - When the highest *reported* SAR for DSSS is adjusted by the ratio of OFDM to DSSS specified maximum output power and the adjusted SAR is ≤ 1.2 W/kg, the 802.11g/n is not required.

WLAN- Scaled Reported SAR							
Mode	Test Position	Frequency		Actual duty factor	maximum duty factor	Reported SAR (1g)(W/kg)	Scaled reported SAR (1g)(W/kg)
		CH	MHz				
802.11b 1Mbps	Left-Cheek	01	2412	92.73%	100%	0.13	0.14
	Left-Tilt	01	2412	92.73%	100%	0.11	0.12
	Right-Cheek	01	2412	92.73%	100%	0.12	0.13
	Right-Tilt	01	2412	92.73%	100%	0.10	0.11

Note:

- According to the KDB248227 D01, The reported SAR must be scaled to 100% transmission duty factor to determine compliance at the maximum tune-up tolerance limit. A maximum transmission duty factor of 92.73% is achievable for WLAN in this project.

Body SAR

GSM850										
Mode	Test Position	Frequency		Conducted Power (dBm)	Tune up limit (dBm)	Tune up scaling factor	Power Drift(dB)	Measured SAR(1g) (W/kg)	Report SAR(1g) (W/kg)	Test Plot
		CH	MHz							
GPRS (4Tx slot)	Front	128	824.2	26.61	27.00	1.09	-	-	-	-
		190	836.6	26.40	27.00	1.15	0.01	0.402	0.46	-
		251	848.8	26.41	27.00	1.15	-	-	-	-
	Back	128	824.2	26.61	27.00	1.09	-	-	-	-
		190	836.6	26.40	27.00	1.15	0.00	0.609	0.70	B1
		251	848.8	26.41	27.00	1.15	-	-	-	-

PCS1900										
Mode	Test Position	Frequency		Conducted Power (dBm)	Tune up limit (dBm)	Tune up scaling factor	Power Drift(dB)	Measured SAR(1g) (W/kg)	Report SAR(1g) (W/kg)	Test Plot
		CH	MHz							
GPRS (4Tx slot)	Front	512	1850.2	24.47	25.00	1.13	-	-	-	-
		661	1880.0	24.23	25.00	1.19	-0.02	0.245	0.29	-
		810	1909.8	24.06	25.00	1.24	-	-	-	-
	Back	512	1850.2	24.47	25.00	1.13	-	-	-	-
		661	1880.0	24.23	25.00	1.19	0.03	0.376	0.45	B2
		810	1909.8	24.06	25.00	1.24	-	-	-	-

WCDMA Band V										
Mode	Test Position	Frequency		Conducted Power (dBm)	Tune up limit (dBm)	Tune up scaling factor	Power Drift(dB)	Measured SAR(1g) (W/kg)	Report SAR(1g) (W/kg)	Test Plot
		CH	MHz							
RMC 12.2Kbps	Front	4132	826.4	21.53	22.00	1.11	-	-	-	-
		4183	836.6	21.47	22.00	1.13	-0.05	0.154	0.17	-
		4233	846.6	21.37	22.00	1.16	-	-	-	-
	Back	4132	826.4	21.53	22.00	1.11	-	-	-	-
		4183	836.6	21.47	22.00	1.13	0.12	0.217	0.25	B3
		4233	846.6	21.37	22.00	1.16	-	-	-	-

WCDMA Band II										
Mode	Test Position	Frequency		Conducted Power (dBm)	Tune up limit (dBm)	Tune up scaling factor	Power Drift(dB)	Measured SAR(1g) (W/kg)	Report SAR(1g) (W/kg)	Test Plot
		CH	MHz							
RMC 12.2Kbps	Front	9262	1852.4	21.97	22.00	1.01	-	-	-	-
		9400	1880.0	21.74	22.00	1.06	0.06	0.545	0.58	-
		9538	1907.6	21.83	22.00	1.04	-	-	-	-
	Back	9262	1852.4	21.97	22.00	1.01	0.06	0.754	0.76	-
		9400	1880.0	21.74	22.00	1.06	0.15	0.794	0.84	B4
		9538	1907.6	21.83	22.00	1.04	0.12	0.763	0.79	-

LTEBand II										
Mode	Test Position	Frequency		Conducted Power (dBm)	Tune up limit (dBm)	Tune up scaling factor	Power Drift(dB)	Measured SAR(1g) (W/kg)	Report SAR(1g) (W/kg)	Test Plot
		CH	MHz							
20M_1RB	Front	18700	1860.0	20.82	21.50	1.17	-	-	-	-
		18900	1880.0	20.91	21.50	1.15	-0.08	0.486	0.50	-
		19100	1900.0	20.87	21.50	1.16	-	-	-	-
	Back	18700	1860.0	20.82	21.50	1.17	0.11	0.713	0.83	-
		18900	1880.0	20.91	21.50	1.15	0.17	0.737	0.85	B5
		19100	1900.0	20.87	21.50	1.16	0.06	0.706	0.82	-
20M_50RB	Front	18700	1860.0	20.19	20.50	1.07	-	-	-	-
		18900	1880.0	20.28	20.50	1.05	0.03	0.340	0.36	-
		19100	1900.0	20.15	20.50	1.08	-	-	-	-
	Back	18700	1860.0	20.19	20.50	1.07	-	-	-	-
		18900	1880.0	20.28	20.50	1.05	-0.06	0.515	0.54	-
		19100	1900.0	20.15	20.50	1.08	-	-	-	-
20M_100RB	Back	18900	1880.0	20.21	20.50	1.07	-0.02	0.496	0.53	-

LTEBand IV										
Mode	Test Position	Frequency		Conducted Power (dBm)	Tune up limit (dBm)	Tune up scaling factor	Power Drift(dB)	Measured SAR(1g) (W/kg)	Report SAR(1g) (W/kg)	Test Plot
		CH	MHz							
20M_1RB	Front	20050	1720	22.31	23.00	1.17	-	-	-	-
		20175	1732.5	22.40	23.00	1.15	-0.08	0.251	0.29	-
		20300	1745	22.30	23.00	1.17	-	-	-	-
	Back	20050	1720	22.31	23.00	1.17	-	-	-	-
		20175	1732.5	22.40	23.00	1.15	0.11	0.385	0.44	B6
		20300	1745	22.30	23.00	1.17	-	-	-	-
20M_50RB	Front	20050	1720	21.68	22.00	1.08	-	-	-	-
		20175	1732.5	21.77	22.00	1.05	0.08	0.151	0.16	-
		20300	1745	21.58	22.00	1.10	-	-	-	-
	Back	20050	1720	21.68	22.00	1.08	-	-	-	-
		20175	1732.5	21.77	22.00	1.05	-0.10	0.232	0.24	-
		20300	1745	21.58	22.00	1.10	-	-	-	-

LTEBand VII										
Mode	Test Position	Frequency		Conducted Power (dBm)	Tune up limit (dBm)	Tune up scaling factor	Power Drift(dB)	Measured SAR(1g) (W/kg)	Report SAR(1g) (W/kg)	Test Plot
		CH	MHz							
20M_1RB	Front	20850	2510	21.10	21.50	1.10	-	-	-	-
		21100	2535	21.18	21.50	1.08	0.01	0.383	0.41	-
		21350	2560	21.10	21.50	1.10	-	-	-	-
	Back	20850	2510	21.10	21.50	1.10	-	-	-	-
		21100	2535	21.18	21.50	1.08	-0.03	0.538	0.58	B7
		21350	2560	21.10	21.50	1.10	-	-	-	-
20M_50RB	Front	20850	2510	20.32	20.50	1.04	-	-	-	-
		21100	2535	20.37	20.50	1.03	0.01	0.289	0.30	-
		21350	2560	20.22	20.50	1.07	-	-	-	-
	Back	20850	2510	20.32	20.50	1.04	-	-	-	-
		21100	2535	20.37	20.50	1.03	-0.03	0.406	0.42	-
		21350	2560	20.22	20.50	1.07	-	-	-	-

Note:

- Per KDB865664 D01v01r04, Repeated measurement is not required when the original highest measured SAR is < 0.80 W/kg
- Per KDB 941225 D05v02r03, for QPSK with 100% RB allocation, SAR is not required when the highest maximum output power for 100 % RB allocation is less than the highest maximum output power in 50% and 1 RB allocations and the highest reported SAR for 1 RB and 50% RB allocation are ≤ 0.8 W/kg. Otherwise, SAR is measured for the highest output power channel; and if the reported SAR is > 1.45 W/kg, the remaining required test channels must also be tested.

WLAN										
Mode	Test Position	Frequency		Conducted Power (dBm)	Tune up limit (dBm)	Tune up scaling factor	Power Drift(dB)	Measured SAR(1g) (W/kg)	Report SAR(1g) (W/kg)	Test Plot
		CH	MHz							
802.11b 1Mbps	Front	1	2412	12.33	12.50	1.04	-0.18	0.049	0.06	-
		6	2437	11.31	12.50	1.32	-	-	-	-
		11	2462	10.63	12.50	1.54	-	-	-	-
	Back	1	2412	12.33	12.50	1.04	0.12	0.079	0.10	B8
		6	2437	11.31	12.50	1.32	-	-	-	-
		11	2462	10.63	12.50	1.54	-	-	-	-

Note:

- According to the above table, the initial test position for body is “Back”, and its reported SAR is ≤ 0.4W/kg. Thus further SAR measurement is not required for the other (remaining) test positions. Because the reported SAR of the highest measured maximum output power channel for the exposure configuration is ≤ 0.8W/kg, no further SAR testing is required for 802.11b DSSS in that exposure configuration.

WLAN- Scaled Reported SAR							
Mode	Test Position	Frequency		Actual duty factor	maximum duty factor	Reported SAR (1g)(W/kg)	Scaled reported SAR (1g)(W/kg)
		CH	MHz				
802.11b 1Mbps	Front	1	2412	92.73%	100%	0.06	0.06
	Back	1	2412	92.73%	100%	0.10	0.11

Note:

- According to the KDB248227 D01, The reported SAR must be scaled to 100% transmission duty factor to determine compliance at the maximum tune-up tolerance limit. A maximum transmission duty factor of 92.73% is achievable for WLAN in this project.

Hotspot SAR

Positions for SAR tests; Hotspot mode						
Antenna	Back	Front	Top side	Bottom side	Right side	Left side
WWAN	Yes	Yes	No	Yes	Yes	Yes
WIFI / BT	Yes	Yes	Yes	No	No	Yes

General note:

Referring to KDB941225 D06, when the overall device length and width are >9cm*5cm, the test distance is 10mm. SAR must be measured for all sides and surfaces with a transmitting antenna located within 25mm from that surface or edge.

GSM850										
Mode	Test Position	Frequency		Conducted Power (dBm)	Tune up limit (dBm)	Tune up scaling factor	Power Drift(dB)	Measured SAR(1g) (W/kg)	Report SAR(1g) (W/kg)	Test Plot
		CH	MHz							
GPRS (4Tx slot)	Front	128	824.2	26.61	27.00	1.09	-	-	-	-
		190	836.6	26.40	27.00	1.15	0.01	0.402	0.46	-
		251	848.8	26.41	27.00	1.15	-	-	-	-
	Back	128	824.2	26.61	27.00	1.09	-	-	-	-
		190	836.6	26.40	27.00	1.15	0.00	0.609	0.70	B1
		251	848.8	26.41	27.00	1.15	-	-	-	-
	Left	190	836.6	26.40	27.00	1.15	0.06	0.268	0.31	-
	Right	190	836.6	26.40	27.00	1.15	0.10	0.194	0.22	-
	Top	190	836.6	26.40	27.00	1.15	-	-	-	-
Bottom	190	836.6	26.40	27.00	1.15	0.02	0.347	0.40	-	

PCS1900										
Mode	Test Position	Frequency		Conducted Power (dBm)	Tune up limit (dBm)	Tune up scaling factor	Power Drift(dB)	Measured SAR(1g) (W/kg)	Report SAR(1g) (W/kg)	Test Plot
		CH	MHz							
GPRS (4Tx slot)	Front	512	1850.2	24.47	25.00	1.13	-	-	-	-
		661	1880.0	24.23	25.00	1.19	-0.02	0.245	0.29	-
		810	1909.8	24.06	25.00	1.24	-	-	-	-
	Back	512	1850.2	24.47	25.00	1.13	-	-	-	-
		661	1880.0	24.23	25.00	1.19	0.03	0.376	0.45	B2
		810	1909.8	24.06	25.00	1.24	-	-	-	-
	Left	661	1880.0	24.23	25.00	1.19	-0.01	0.164	0.20	-
	Right	661	1880.0	24.23	25.00	1.19	-0.01	0.125	0.15	-
	Top	661	1880.0	24.23	25.00	1.19	-	-	-	-
Bottom	661	1880.0	24.23	25.00	1.19	0.03	0.214	0.26	-	

WCDMA Band V										
Mode	Test Position	Frequency		Conducted Power (dBm)	Tune up limit (dBm)	Tune up scaling factor	Power Drift(dB)	Measured SAR(1g) (W/kg)	Report SAR(1g) (W/kg)	Test Plot
		CH	MHz							
RMC 12.2Kbps	Front	4132	826.4	21.53	22.00	1.11	-	-	-	-
		4183	836.6	21.47	22.00	1.13	-0.05	0.154	0.17	-
		4233	846.6	21.37	22.00	1.16	-	-	-	-
	Back	4132	826.4	21.53	22.00	1.11	-	-	-	-
		4183	836.6	21.47	22.00	1.13	0.12	0.217	0.25	B3
		4233	846.6	21.37	22.00	1.16	-	-	-	-
	Left	4183	836.6	21.47	22.00	1.13	0.21	0.103	0.12	-
	Right	4183	836.6	21.47	22.00	1.13	-0.13	0.096	0.11	-
	Top	4183	836.6	21.47	22.00	1.13	-	-	-	-
Bottom	4183	836.6	21.47	22.00	1.13	-0.04	0.124	0.14	-	

WCDMA Band II										
Mode	Test Position	Frequency		Conducted Power (dBm)	Tune up limit (dBm)	Tune up scaling factor	Power Drift(dB)	Measured SAR(1g) (W/kg)	Report SAR(1g) (W/kg)	Test Plot
		CH	MHz							
RMC 12.2Kbps	Front	9262	1852.4	21.97	22.00	1.01	-	-	-	-
		9400	1880.0	21.74	22.00	1.06	0.06	0.545	0.58	-
		9538	1907.6	21.83	22.00	1.04	-	-	-	-
	Back	9262	1852.4	21.97	22.00	1.01	0.06	0.754	0.76	-
		9400	1880.0	21.74	22.00	1.06	0.15	0.794	0.84	B4
		9538	1907.6	21.83	22.00	1.04	0.12	0.763	0.79	-
	Left	9400	1880.0	21.74	22.00	1.06	-0.11	0.376	0.40	-
	Right	9400	1880.0	21.74	22.00	1.06	0.19	0.428	0.45	-
	Top	9400	1880.0	21.74	22.00	1.06	-	-	-	-
Bottom	9400	1880.0	21.74	22.00	1.06	0.08	0.410	0.44	-	

LTE Band II										
Mode	Test Position	Frequency		Conducted Power (dBm)	Tune up limit (dBm)	Tune up scaling factor	Power Drift(dB)	Measured SAR(1g) (W/kg)	Report SAR(1g) (W/kg)	Test Plot
		CH	MHz							
20M_1RB	Front	18700	1860.0	20.82	21.50	1.17	-	-	-	-
		18900	1880.0	20.91	21.50	1.15	-0.08	0.486	0.50	-
		19100	1900.0	20.87	21.50	1.16	-	-	-	-
	Back	18700	1860.0	20.82	21.50	1.17	0.11	0.713	0.83	-
		18900	1880.0	20.91	21.50	1.15	0.17	0.737	0.85	B5
		19100	1900.0	20.87	21.50	1.16	0.06	0.706	0.82	-
	Left	18900	1880.0	20.91	21.50	1.15	-0.10	0.324	0.37	-
	Right	18900	1880.0	20.91	21.50	1.15	0.06	0.235	0.27	-
	Top	18900	1880.0	20.91	21.50	1.15	-	-	-	-
Bottom	18900	1880.0	20.91	21.50	1.15	0.23	0.420	0.48	-	
20M_50RB	Front	18700	1860.0	20.19	20.50	1.07	-	-	-	-
		18900	1880.0	20.28	20.50	1.05	0.03	0.340	0.36	-
		19100	1900.0	20.15	20.50	1.08	-	-	-	-
	Back	18700	1860.0	20.19	20.50	1.07	-	-	-	-
		18900	1880.0	20.28	20.50	1.05	-0.06	0.515	0.54	-
		19100	1900.0	20.15	20.50	1.08	-	-	-	-
	Left	18900	1880.0	20.28	20.50	1.05	0.04	0.227	0.24	-
	Right	18900	1880.0	20.28	20.50	1.05	-0.02	0.164	0.17	-
	Top	18900	1880.0	20.28	20.50	1.05	-	-	-	-
Bottom	18900	1880.0	20.28	20.50	1.05	-0.09	0.294	0.31	-	
20M_100RB	Back	18900	1880.0	20.21	20.50	1.07	-0.02	0.496	0.53	-

LTE Band IV										
Mode	Test Position	Frequency		Conducted Power (dBm)	Tune up limit (dBm)	Tune up scaling factor	Power Drift(dB)	Measured SAR(1g) (W/kg)	Report SAR(1g) (W/kg)	Test Plot
		CH	MHz							
20M_1RB	Front	20050	1720	22.31	23.00	1.17	-	-	-	-
		20175	1732.5	22.40	23.00	1.15	-0.08	0.251	0.29	-
		20300	1745	22.30	23.00	1.17	-	-	-	-
	Back	20050	1720	22.31	23.00	1.17	-	-	-	-
		20175	1732.5	22.40	23.00	1.15	0.11	0.385	0.44	B6
		20300	1745	22.30	23.00	1.17	-	-	-	-
	Left	20175	1732.5	22.40	23.00	1.15	-0.05	0.168	0.19	-
	Right	20175	1732.5	22.40	23.00	1.15	-0.03	0.128	0.15	-
	Top	20175	1732.5	22.40	23.00	1.15	-	-	-	-
Bottom	20175	1732.5	22.40	23.00	1.15	0.11	0.219	0.25	-	
20M_50RB	Front	20050	1720	21.68	22.00	1.08	-	-	-	-
		20175	1732.5	21.77	22.00	1.05	0.08	0.151	0.16	-
		20300	1745	21.58	22.00	1.10	-	-	-	-
	Back	20050	1720	21.68	22.00	1.08	-	-	-	-
		20175	1732.5	21.77	22.00	1.05	-0.10	0.232	0.24	-
	Left	20300	1745	21.58	22.00	1.10	-	-	-	-
Left	20175	1732.5	21.77	22.00	1.05	0.05	0.101	0.11	-	

	Right	20175	1732.5	21.77	22.00	1.05	0.03	0.077	0.08	-
	Top	20175	1732.5	21.77	22.00	1.05	-	-	-	-
	Bottom	20175	1732.5	21.77	22.00	1.05	-0.11	0.132	0.14	-

LTE Band VII										
Mode	Test Position	Frequency		Conducted Power (dBm)	Tune up limit (dBm)	Tune up scaling factor	Power Drift(dB)	Measured SAR(1g) (W/kg)	Report SAR(1g) (W/kg)	Test Plot
		CH	MHz							
20M_1RB	Front	20850	2510	21.10	21.50	1.10	-	-	-	-
		21100	2535	21.18	21.50	1.08	0.01	0.383	0.41	-
		21350	2560	21.10	21.50	1.10	-	-	-	-
	Back	20850	2510	21.10	21.50	1.10	-	-	-	-
		21100	2535	21.18	21.50	1.08	-0.03	0.538	0.58	B7
		21350	2560	21.10	21.50	1.10	-	-	-	-
	Left	21100	2535	21.18	21.50	1.08	-0.05	0.255	0.27	-
	Right	21100	2535	21.18	21.50	1.08	0.03	0.237	0.26	-
	Top	21100	2535	21.18	21.50	1.08	-	-	-	-
Bottom	21100	2535	21.18	21.50	1.08	0.01	0.307	0.33	-	
20M_50RB	Front	20850	2510	20.32	20.50	1.04	-	-	-	-
		21100	2535	20.37	20.50	1.03	0.01	0.289	0.30	-
		21350	2560	20.22	20.50	1.07	-	-	-	-
	Back	20850	2510	20.32	20.50	1.04	-	-	-	-
		21100	2535	20.37	20.50	1.03	-0.03	0.406	0.42	-
		21350	2560	20.22	20.50	1.07	-	-	-	-
	Left	21100	2535	20.37	20.50	1.03	-0.05	0.192	0.20	-
	Right	21100	2535	20.37	20.50	1.03	0.03	0.179	0.18	-
	Top	21100	2535	20.37	20.50	1.03	-	-	-	-
Bottom	21100	2535	20.37	20.50	1.03	0.01	0.231	0.24	-	

Note:

1. Per KDB865664 D01v01r04, Repeated measurement is not required when the original highest measured SAR is < 0.80 W/kg
2. Per KDB 941225 D05v02r03, for QPSK with 100% RB allocation, SAR is not required when the highest maximum output power for 100 % RB allocation is less than the highest maximum output power in 50% and 1 RB allocations and the highest reported SAR for 1 RB and 50% RB allocation are ≤ 0.8 W/kg. Otherwise, SAR is measured for the highest output power channel; and if the reported SAR is > 1.45 W/kg, the remaining required test channels must also be tested.

WLAN										
Mode	Test Position	Frequency		Conducted Power (dBm)	Tune up limit (dBm)	Tune up scaling factor	Power Drift(dB)	Measured SAR(1g) (W/kg)	Report SAR(1g) (W/kg)	Test Plot
		CH	MHz							
802.11b 1Mbps	Front	1	2412	12.33	12.50	1.04	-0.18	0.049	0.06	-
		6	2437	11.31	12.50	1.32	-	-	-	-
		11	2462	10.63	12.50	1.54	-	-	-	-
	Back	1	2412	12.33	12.50	1.04	0.12	0.079	0.10	B8
		6	2437	11.31	12.50	1.32	-	-	-	-
		11	2462	10.63	12.50	1.54	-	-	-	-
	Left	1	2412	12.33	12.50	1.04	0.09	0.037	0.04	-
	Right	1	2412	12.33	12.50	1.04	-	-	-	-
	Top	1	2412	12.33	12.50	1.04	0.16	0.041	0.04	-
Bottom	1	2412	12.33	12.50	1.04	-	-	-	-	

Note:

1. According to the above table, the initial test position for body is “Back”, and its reported SAR is ≤ 0.4W/kg. Thus further SAR measurement is not required for the other (remaining) test positions. Because the reported SAR of the highest measured maximum output power channel for the exposure configuration is ≤ 0.8W/kg, no further SAR testing is required for 802.11b DSSS in that exposure configuration.
2. When SAR measurement is required for 2.4 GHz 802.11g/n OFDM configurations, the measurement and test reduction procedures for OFDM are applied. SAR is not required for the following 2.4 GHz OFDM conditions.
 - a) When KDB Publication 447498 D01 SAR test exclusion applies to the OFDM configuration.
 - b) When the highest *reported* SAR for DSSS is adjusted by the ratio of OFDM to DSSS specified maximum output power and the adjusted SAR is ≤ 1.2 W/kg. the 802.11g/n is not required

WLAN- Scaled Reported SAR							
Mode	Test Position	Frequency		Actual duty factor	maximum duty factor	Reported SAR (1g)(W/kg)	Scaled reported SAR (1g)(W/kg)
		CH	MHz				
802.11b 1Mbps	Front	1	2412	92.73%	100%	0.06	0.06
	Back	1	2412	92.73%	100%	0.10	0.11
	Left	1	2412	92.73%	100%	0.04	0.04
	Top	1	2412	92.73%	100%	0.04	0.04

Note:

2. According to the KDB248227 D01, The reported SAR must be scaled to 100% transmission duty factor to determine compliance at the maximum tune-up tolerance limit. A maximum transmission duty factor of 92.73% is achievable for WLAN in this project.

SAR Test Data Plots

Test mode: GSM850-GPRS 4TS Test Position: Left Head Cheek Test Plot: H1

Date:2017-01-16

Communication System: Customer System; Frequency:836.6 MHz;Duty Cycle:1:2

Medium parameters used (interpolated): $f=836.6$ MHz; $\sigma=0.91$ S/m; $\epsilon_r=41.48$; $\rho=1000$ kg/m³

Phantom section: Left Section

DASY5 Configuration:

- Probe: ES3DV3 - SN3292; ConvF(6.53, 6.53, 6.53);
- Sensor-Surface: 4mm (Mechanical Surface Detection)
- Electronics: DAE4 Sn1315; Calibrated: 2016/7/26
- Phantom: SAM 1; Type: SAM;
- Measurement SW: DASY52, Version 52.8 (2); SEMCAD X Version 14.6.6 (6824)

Area Scan (61x101x1): Interpolated grid: $dx=1.500$ mm, $dy=1.500$ mm

Maximum value of SAR (interpolated) = 0.222 W/kg

Zoom Scan (7x7x7)/Cube 0: Measurement grid: $dx=5$ mm, $dy=5$ mm, $dz=5$ mm

Reference Value = 6.172 V/m; Power Drift = 0.01 dB

Peak SAR (extrapolated) = 0.247 mW/g

SAR(1 g) = 0.210 mW/g; SAR(10 g) = 0.177 mW/g

Maximum value of SAR (measured) = 0.215 W/kg

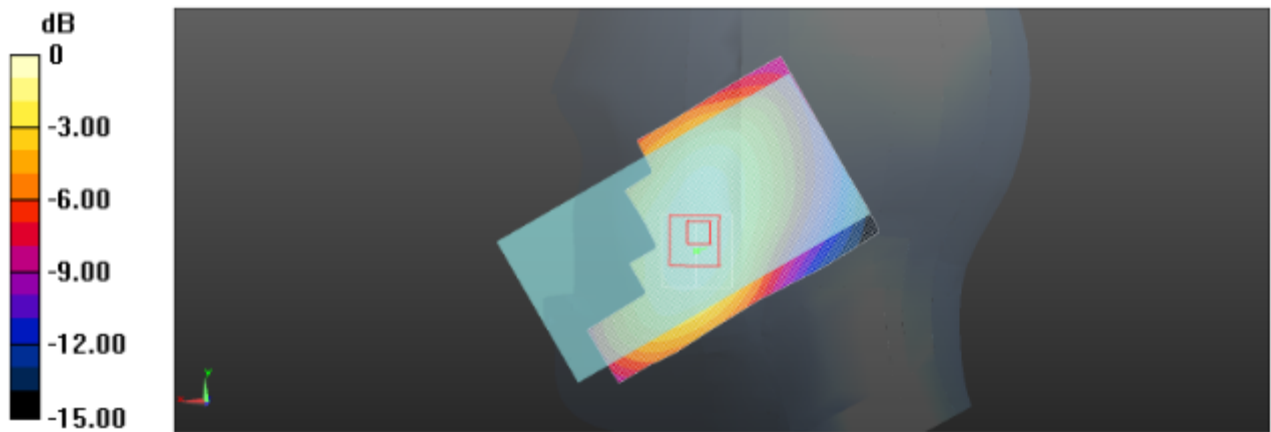

Left Head Cheek (GSM850 GPRS 4TS Middle Channel)

Test mode: PCS1900 GPRS 4TS Test Position: Left Head Cheek Test Plot: H2

Date:2017-01-22

Communication System: Customer System; Frequency: 1880.0 MHz;Duty Cycle: 1:2

Medium parameters used (interpolated): $f = 1880.0$ MHz; $\sigma = 1.41$ mho/m; $\epsilon = 40.01$; $\rho = 1000$ kg/m³

Phantom section: Left Section

DASY5 Configuration:

- Probe: ES3DV3 - SN3292; ConvF(5.26,5.26,5.26); Calibrated: 02/09/2016;
- Sensor-Surface: 4mm (Mechanical Surface Detection)
- Electronics: DAE4 Sn1315; Calibrated: 2016/7/26
- Phantom: SAM 1; Type: SAM;
- Measurement SW: DASY52, Version 52.8 (2); SEMCAD X Version 14.6.6 (6824)

Area Scan (61x111x1): Interpolated grid: $dx=1.500$ mm, $dy=1.500$ mm

Maximum value of SAR (interpolated) = 0.0686 W/kg

Zoom Scan (7x7x7)/Cube 0: Measurement grid: $dx=5$ mm, $dy=5$ mm, $dz=5$ mm

Reference Value = 2.853 V/m; Power Drift = 0.17 dB

Peak SAR (extrapolated) = 0.103 mW/g

SAR(1 g) = 0.062 mW/g; SAR(10 g) = 0.036 mW/g

Maximum value of SAR (measured) = 0.0681 W/kg

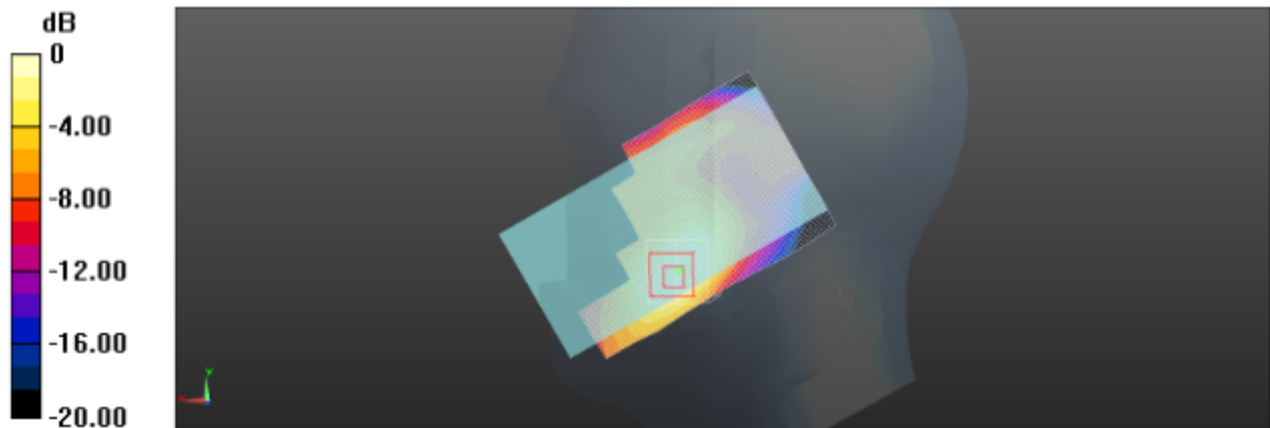

Left Head (PCS1900 Middle Channel)

Test mode: WCDMA Band V Test Position: Left Head Cheek Test Plot: H3

Date:2017-01-16

Communication System: Customer System; Frequency: 836.6 MHz;Duty Cycle:1:1

Medium parameters used (interpolated): $f=836.6$ MHz; $\sigma=0.91$ S/m; $\epsilon_r=41.48$; $\rho=1000$ kg/m³

Phantom section: Left Head Section:

DASY5 Configuration:

- Probe: ES3DV3 - SN3292; ConvF(6.53, 6.53, 6.53); Calibrated: 02/09/2016;
- Sensor-Surface: 4mm (Mechanical Surface Detection)
- Electronics: DAE4 Sn1315; Calibrated: 26/07/2016
- Phantom: SAM 1; Type: SAM;
- Measurement SW: DASY52, Version 52.8 (2); SEMCAD X Version 14.6.6 (6824)

Area Scan (51x101x1): Interpolated grid: $dx=1.500$ mm, $dy=1.500$ mm

Maximum value of SAR (interpolated) =0.0630 W/kg

Zoom Scan (7x7x7)/Cube 0: Measurement grid: $dx=5$ mm, $dy=5$ mm, $dz=5$ mm

Reference Value = 6.226 V/m; Power Drift = 0.07 dB

Reference Value = 2.562 V/m; Power Drift = -0.15 dB

Peak SAR (extrapolated) = 0.070 mW/g

SAR(1 g) = 0.059 mW/g; SAR(10 g) = 0.050 mW/g

Maximum value of SAR (measured) = 0.0611 W/kg

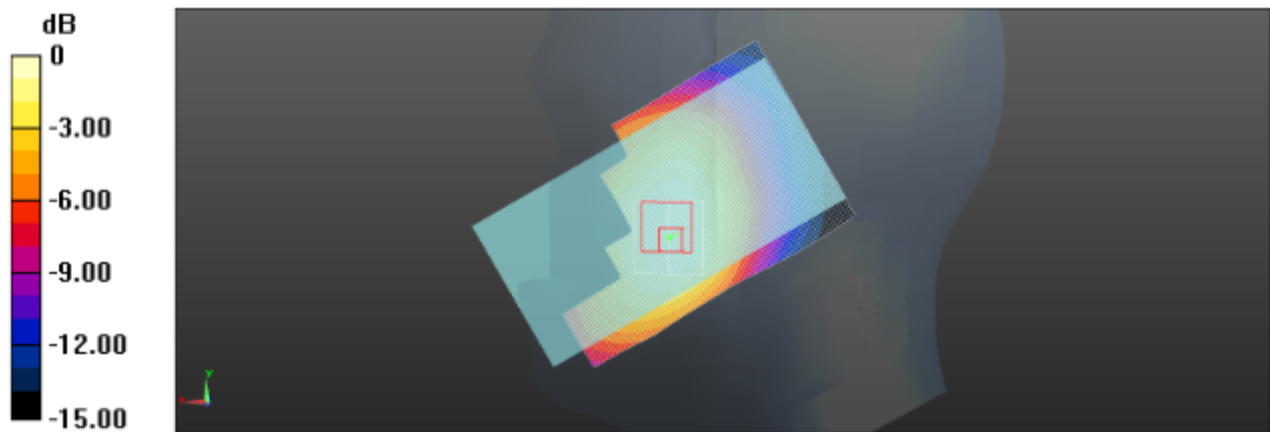

Left Head Cheek (WCDMA Band V Middle Channel)

Test mode: WCDMA Band II Test Position: Left Head Cheek Test Plot: H4

Date:2017-01-22

Communication System: Customer System; Frequency: 1880.0 MHz;Duty Cycle:1:1

Medium parameters used (interpolated): $f=1880.0$ MHz; $\sigma = 1.41$ mho/m; $\epsilon = 40.01$; $\rho=1000$ kg/m³

Phantom section: Left Head Section:

DASY5 Configuration:

- Probe: ES3DV3 - SN3292; ConvF(5.26,5.26,5.26); Calibrated: 02/09/2016;
- Sensor-Surface: 4mm (Mechanical Surface Detection)
- Electronics: DAE4 Sn1315; Calibrated: 26/07/2016
- Phantom: SAM 1; Type: SAM;
- Measurement SW: DASY52, Version 52.8 (2); SEMCAD X Version 14.6.6 (6824)

Area Scan (51x101x1): Interpolated grid: dx=1.500 mm, dy=1.500 mm

Maximum value of SAR (interpolated) =0.186 W/kg

Zoom Scan (7x7x7)/Cube 0: Measurement grid: dx=5mm, dy=5mm, dz=5mm

Reference Value = 4.034 V/m; Power Drift = 0.19 dB

Peak SAR (extrapolated) = 0.277 mW/g

SAR(1 g) = 0.172 mW/g; SAR(10 g) = 0.101 mW/g

Maximum value of SAR (measured) = 0.187 W/kg

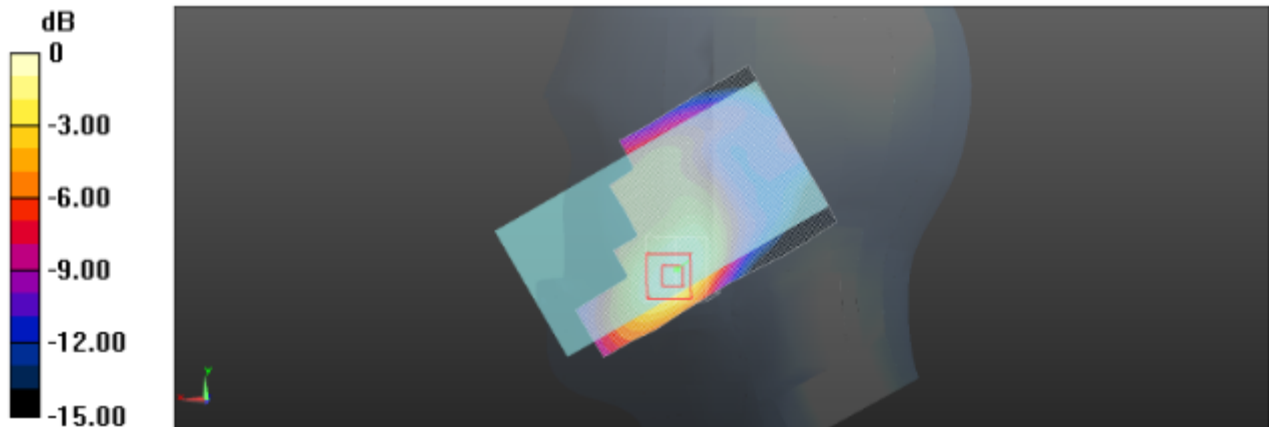

Left Head Cheek (WCDMA Band II Middle Channel)

Test mode: LTE Band II

Test Position: Left Head Cheek

Test Plot: H5

Date:2017-01-22

Communication System: Customer System; Frequency: 1880.0 MHz;Duty Cycle:1:1

Medium parameters used (interpolated): $f=1880.0$ MHz; $\sigma = 1.41$ mho/m; $\epsilon = 40.01$; $\rho=1000$ kg/m³

Phantom section: Left Head Section:

DASY5 Configuration:

- Probe: ES3DV3 - SN3292; ConvF(5.26,5.26,5.26); Calibrated: 02/09/2016;
- Sensor-Surface: 4mm (Mechanical Surface Detection)
- Electronics: DAE4 Sn1315; Calibrated: 26/07/2016
- Phantom: SAM 1; Type: SAM;
- Measurement SW: DASY52, Version 52.8 (2); SEMCAD X Version 14.6.6 (6824)

Area Scan (51x101x1): Interpolated grid: dx=1.500 mm, dy=1.500 mm

Maximum value of SAR (interpolated) = 0.126 W/kg

Zoom Scan (6x6x7)/Cube 0: Measurement grid: dx=8mm, dy=8mm, dz=5mm

Reference Value = 3.837 V/m; Power Drift = 0.11 dB

Peak SAR (extrapolated) = 0.187 mW/g

SAR(1 g) = 0.114 mW/g; SAR(10 g) = 0.066 mW/g

Maximum value of SAR (measured) = 0.125 W/kg

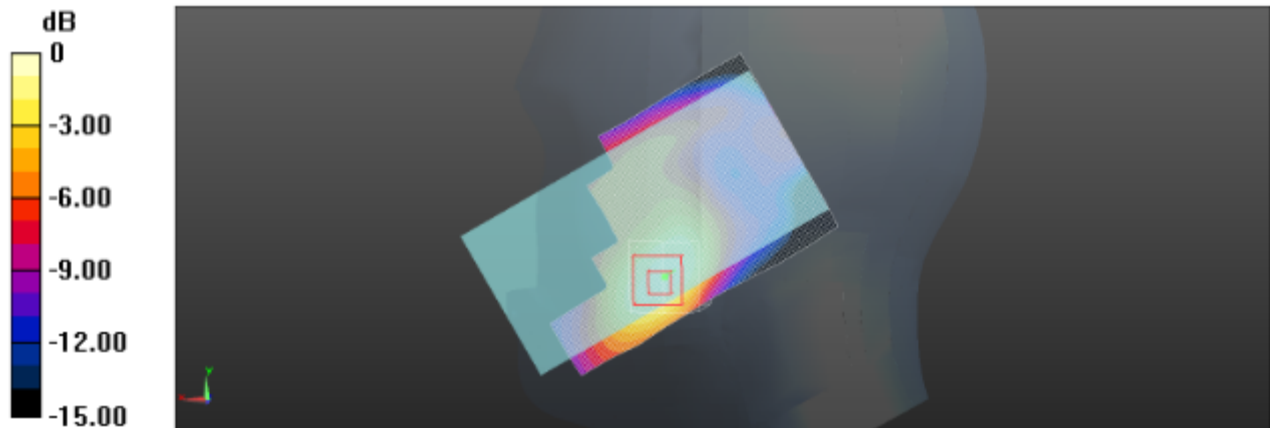

Left Head Cheek (LTE Band II Middle Channel)

Test mode: LTE Band IV

Test Position: Left Head Cheek

Test Plot: H6

Date:2017-01-18

Communication System: Generic LTE; Frequency: 1732.5 MHz;Duty Cycle: 1:1

Medium parameters used (interpolated): $f = 1732.5$ MHz; $\sigma = 1.363$ mho/m; $\epsilon_r = 40.136$; $\rho = 1000$ kg/m³

Phantom section: Left Head Section:

DASY5 Configuration:

Probe: ES3DV3 - SN3292; ConvF(5.54,5.54,5.54); Calibrated: 02/09/2016;

•Sensor-Surface: 4mm (Mechanical Surface Detection)

•Electronics: DAE4 Sn1315; Calibrated: 26/07/2016

•Phantom: SAM 1; Type: SAM;

•Measurement SW: DASY52, Version 52.8 (2); SEMCAD X Version 14.6.6 (6824)

Area Scan (51x101x1): Interpolated grid: $dx=1.500$ mm, $dy=1.500$ mm

Maximum value of SAR (interpolated) =0.319 W/kg

Zoom Scan (7x7x7)/Cube 0: Measurement grid: $dx=5$ mm, $dy=5$ mm, $dz=5$ mm

Reference Value = 6.127 V/m; Power Drift = 0.03 dB

Peak SAR (extrapolated) = 0.446 mW/g

SAR(1 g) = 0.283 mW/g; SAR(10 g) = 0.173 mW/g

Maximum value of SAR (measured) = 0.310 W/kg

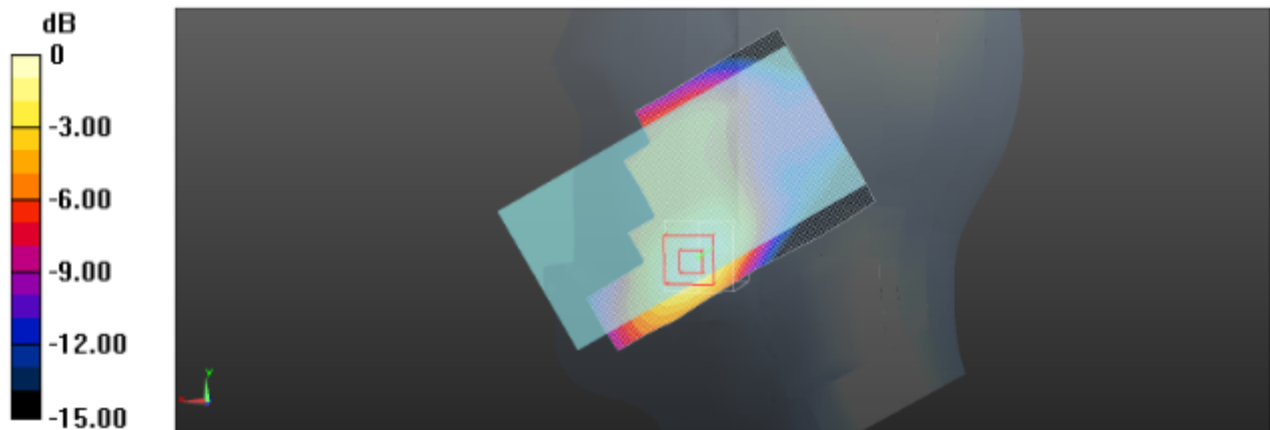

Left Head Cheek (LTE Band IV Middle Channel)

Test mode: LTE Band VII

Test Position: Left Head Cheek

Test Plot: H7

Date:2017-01-24

Communication System: Customer System; Frequency: 2535.0 MHz;Duty Cycle:1:1

Medium parameters used (interpolated): $f = 2535.0$ MHz; $\sigma = 1.91$ mho/m; $\epsilon = 39.01$; $\rho = 1000$ kg/m³

Phantom section: Left Head Section:

DASY5 Configuration:

- Probe: ES3DV3 - SN3292; ConvF(4.77, 4.77, 4.77); Calibrated: 02/09/2016;
- Sensor-Surface: 4mm (Mechanical Surface Detection)
- Electronics: DAE4 Sn1315; Calibrated: 26/07/2016
- Phantom: SAM 1; Type: SAM;
- Measurement SW: DASY52, Version 52.8 (2); SEMCAD X Version 14.6.6 (6824)

Area Scan (51x101x1): Interpolated grid: dx=1.500 mm, dy=1.500 mm

Maximum value of SAR (interpolated) =0.182 W/kg

Zoom Scan (7x7x7)/Cube 0: Measurement grid: dx=5mm, dy=5mm, dz=5mm

Reference Value = 2.386 V/m; Power Drift = 0.19 dB

Peak SAR (extrapolated) = 0.354 mW/g

SAR(1 g) = 0.164 mW/g; SAR(10 g) = 0.080 mW/g

Maximum value of SAR (measured) = 0.180 W/kg

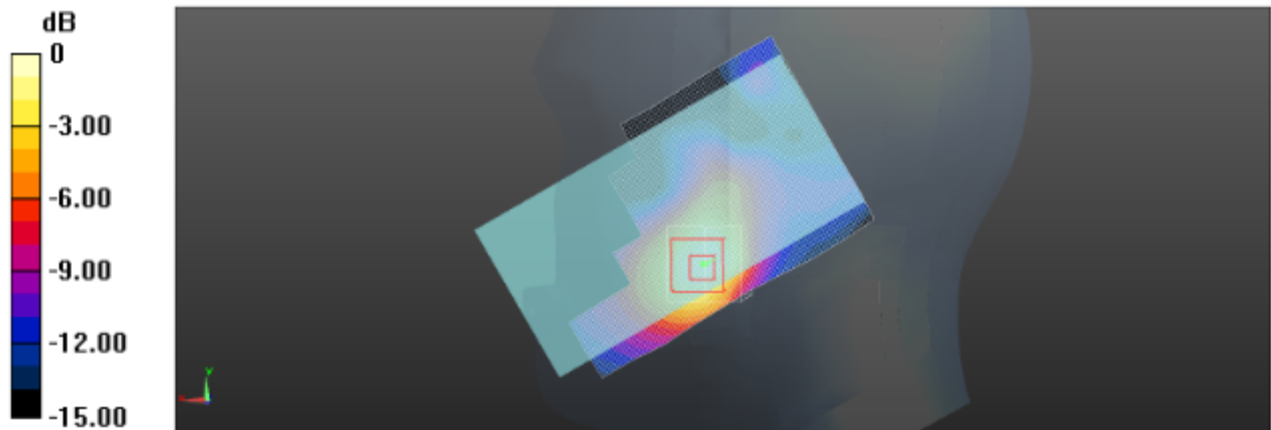

Left Head Cheek (LTE Band VII Middle Channel)

Test mode: WLAN 802.11b

Test Position: Left Head Cheek

Test Plot: H8

Date:2017-01-24

Communication System: Customer System; Frequency: 2437.0 MHz;Duty Cycle:1:1

Medium parameters used (interpolated): $f=2437.0$ MHz; $\sigma=1.78$ S/m; $\epsilon_r=39.00$; $\rho=1000$ kg/m³

Phantom section: Left Head Section:

DASY5 Configuration:

- Probe: ES3DV3 - SN3292; ConvF(4.97,4.97,4.97); Calibrated: 02/09/2016;
- Sensor-Surface: 4mm (Mechanical Surface Detection)
- Electronics: DAE4 Sn1315; Calibrated: 26/07/2016
- Phantom: SAM 1; Type: SAM;
- Measurement SW: DASY52, Version 52.8 (2); SEMCAD X Version 14.6.6 (6824)

Area Scan (61x121x1): Interpolated grid: dx=1.500 mm, dy=1.500 mm

Maximum value of SAR (interpolated) = 0.173 W/kg

Zoom Scan (7x7x7)/Cube 0: Measurement grid: dx=5mm, dy=5mm, dz=5mm

Reference Value =4.147 V/m; Power Drift =-0.05 dB

Peak SAR (extrapolated) = 0.242 mW/g

SAR(1 g) = 0.126 mW/g; SAR(10 g) = 0.071 mW/g

Maximum value of SAR (measured) = 0.166 W/kg

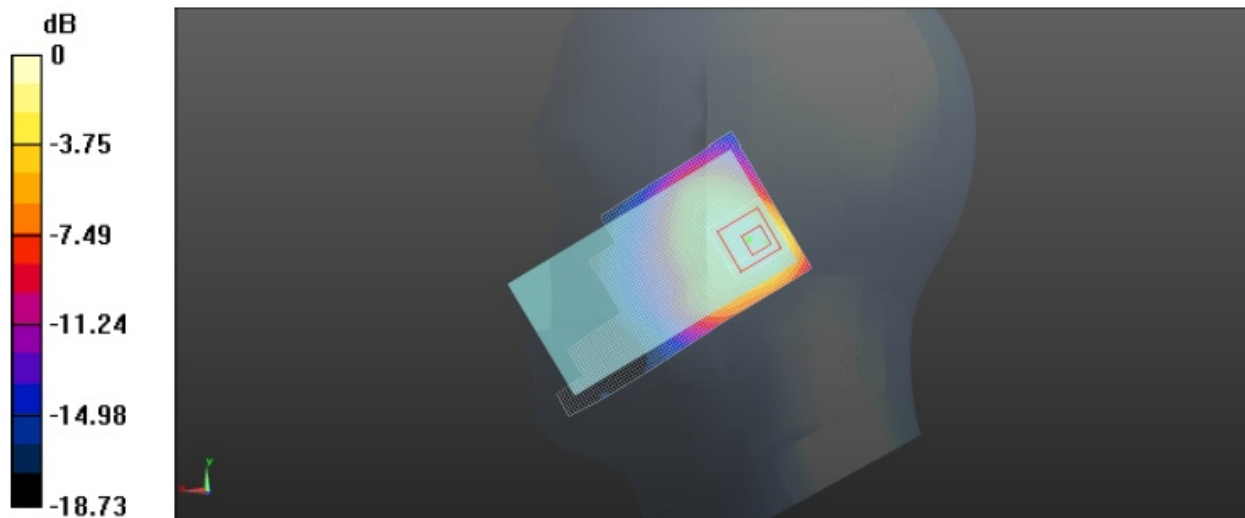

Left Head Cheek (WLAN middle Channel)

Test mode: GSM850 GPRS 4TS Test Position: Body- worn Rear Side Test Plot: B1

Date:2017-01-16

Communication System: Customer System; Frequency:836.6 MHz;Duty Cycle:1:2

Medium parameters used (interpolated): $f=836.6$ MHz; $\sigma=0.97$ S/m; $\epsilon_r=55.10$; $\rho=1000$ kg/m³

Phantom section: Flat Section:

DASY 5 Configuration:

- Probe: ES3DV3 - SN3292; ConvF(6.27, 6.27, 6.27); Calibrated: 02/09/2016;
- Sensor-Surface: 4mm (Mechanical Surface Detection)
- Electronics: DAE4 Sn1315; Calibrated: 26/07/2016
- Phantom: SAM 1; Type: SAM;
- Measurement SW: DASY52, Version 52.8 (2); SEMCAD X Version 14.6.6 (6824)

Area Scan (51x101x1): Interpolated grid: dx=1.500 mm, dy=1.500 mm

Maximum value of SAR (interpolated) =0.683 W/kg

Zoom Scan (7x7x7)/Cube 0: Measurement grid: dx=5mm, dy=5mm, dz=5mm

Reference Value = 26.130 V/m; Power Drift = 0.00 dB

Peak SAR (extrapolated) = 1.049 mW/g

SAR(1 g) = 0.609 mW/g; SAR(10 g) = 0.361 mW/g

Maximum value of SAR (measured) = 0.703 W/kg

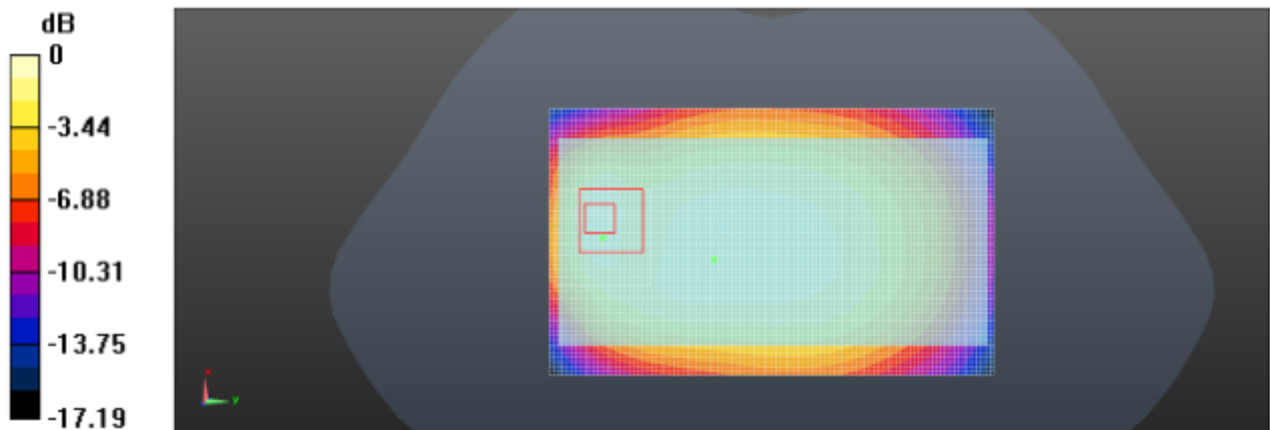

Body- worn Rear Side (GSM850 GPRS 4TS Middle Channel)

Test mode: PCS1900 GPRS 4TS Test Position: Body- worn Rear Side Test Plot: B2

Date:2017-01-18

Communication System: Customer System; Frequency: 1880.0 MHz;Duty Cycle: 1:2

Medium parameters used (interpolated): $f = 1880.0$ MHz; $\sigma = 1.51$ mho/m; $\epsilon = 53.21$; $\rho = 1000$ kg/m³

Phantom section: Flat Section

DASY5 Configuration:

- Probe: ES3DV3 - SN3292; ConvF(5.05,5.05,5.05); Calibrated: 02/09/2016;
- Sensor-Surface: 4mm (Mechanical Surface Detection)
- Electronics: DAE4 Sn1315; Calibrated: 26/07/2016
- Phantom: SAM 1; Type: SAM;
- Measurement SW: DASY52, Version 52.8 (2); SEMCAD X Version 14.6.6 (6824)

Area Scan (51x101x1): Interpolated grid: dx=1.500 mm, dy=1.500 mm

Maximum value of SAR (interpolated) =0.412 W/kg

Zoom Scan (7x7x7)/Cube 0: Measurement grid: dx=5mm, dy=5mm, dz=5mm

Reference Value = 6.657 V/m; Power Drift = 0.03 dB

Peak SAR (extrapolated) = 0.685 mW/g

SAR(1 g) = 0.376 mW/g; SAR(10 g) = 0.191 mW/g

Maximum value of SAR (measured) = 0.419 W/kg

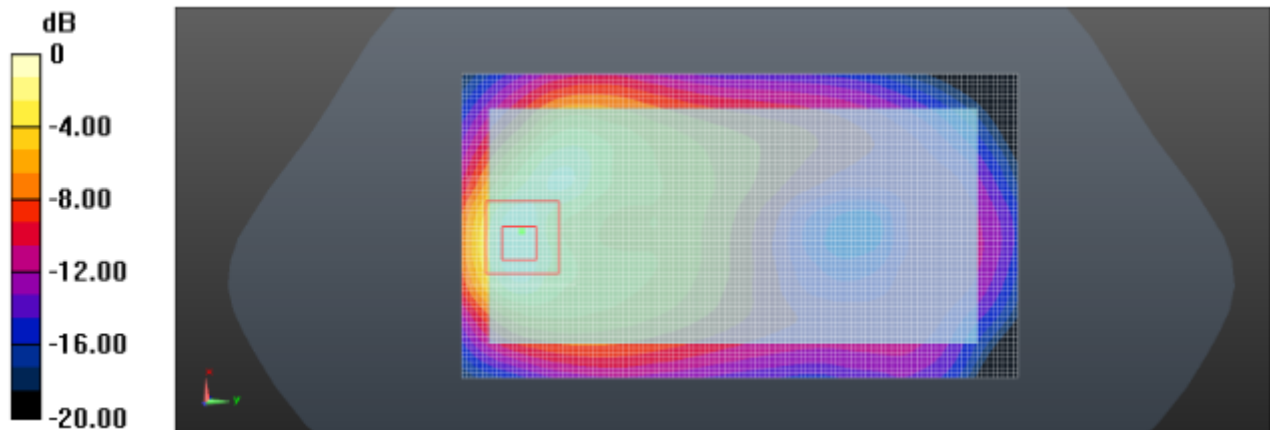

Body- worn Rear Side (PCS1900 GPRS 4TS Middle Channel)

Test mode: WCDMA Band V

Test Position: Body- worn Rear Side

Test Plot: B3

Date:2017-01-16

Communication System: Customer System; Frequency: 836.6 MHz;Duty Cycle:1:1

Medium parameters used (interpolated): $f=836.6$ MHz; $\sigma=0.97$ S/m; $\epsilon_r=55.10$; $\rho=1000$ kg/m³

Phantom section: Flat Section

DASY5 Configuration:

- Probe: ES3DV3 - SN3292; ConvF(6.27, 6.27, 6.27); Calibrated: 02/09/2016;
- Sensor-Surface: 4mm (Mechanical Surface Detection)
- Electronics: DAE4 Sn1315; Calibrated: 26/07/2016
- Phantom: SAM 1; Type: SAM;
- Measurement SW: DASY52, Version 52.8 (2); SEMCAD X Version 14.6.6 (6824)

Area Scan (51x101x1): Interpolated grid: $dx=1.500$ mm, $dy=1.500$ mm

Maximum value of SAR (interpolated) =0.229 W/kg

Zoom Scan (7x7x7)/Cube 0: Measurement grid: $dx=5$ mm, $dy=5$ mm, $dz=5$ mm

Reference Value = 12.587 V/m; Power Drift = 0.12 dB

Peak SAR (extrapolated) = 0.377 mW/g

SAR(1 g) = 0.217 mW/g; SAR(10 g) = 0.127 mW/g

Maximum value of SAR (measured) = 0.229 W/kg

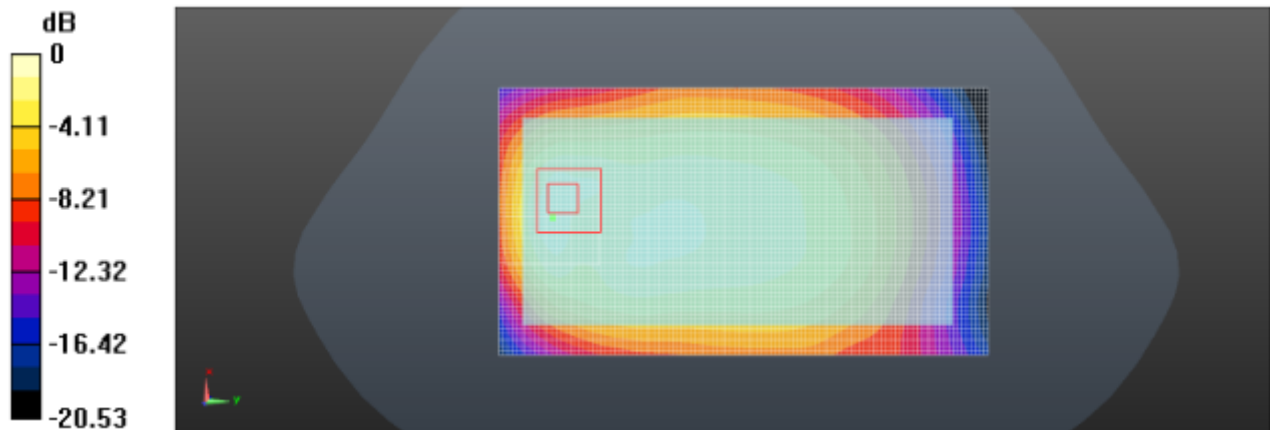

Body- worn Rear Side (WCDMA Band V Middle Channel)

Test mode: WCDMA Band II Test Position: Body- worn Rear Side Test Plot: B4

Date:2017-01-18

Communication System: Customer System; Frequency: 1880.0 MHz;Duty Cycle:1:1

Medium parameters used (interpolated): $f=1880.0$ MHz; $\sigma=1.51$ S/m; $\epsilon_r=53.21$; $\rho=1000$ kg/m³

Phantom section: Flat Section

DASY5 Configuration:

- Probe: ES3DV3 - SN3292; ConvF(5.05,5.05,5.05); Calibrated: 02/09/2016;
- Sensor-Surface: 4mm (Mechanical Surface Detection)
- Electronics: DAE4 Sn1315; Calibrated: 26/07/2016
- Phantom: SAM 1; Type: SAM;
- Measurement SW: DASY52, Version 52.8 (2); SEMCAD X Version 14.6.6 (6824)

Area Scan (51x101x1): Interpolated grid: $dx=1.500$ mm, $dy=1.500$ mm

Maximum value of SAR (interpolated) =0.861 W/kg

Zoom Scan (7x7x7)/Cube 0: Measurement grid: $dx=5$ mm, $dy=5$ mm, $dz=5$ mm

Reference Value = 8.862 V/m; Power Drift = 0.15 dB

Peak SAR (extrapolated) = 1.389 mW/g

SAR(1 g) = 0.794 mW/g; SAR(10 g) = 0.413 mW/g

Maximum value of SAR (measured) = 0.890 W/kg

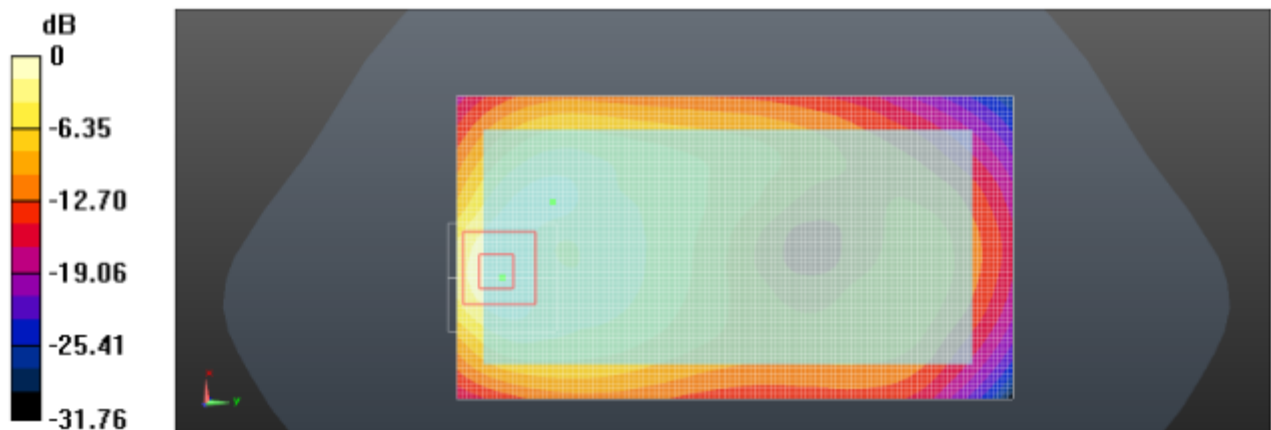

Body- worn Rear Side (WCDMA Band II Middle Channel)

Test mode: LTE Band II

Test Position: Body- worn Rear Side

Test Plot: B5

Date:2017-01-18

Communication System: Customer System; Frequency: 1880.0 MHz;Duty Cycle:1:1

Medium parameters used (interpolated): $f=1880.0$ MHz; $\sigma=1.51$ S/m; $\epsilon_r=53.21$; $\rho=1000$ kg/m³

Phantom section: Flat Section

DASY5 Configuration:

- Probe: ES3DV3 - SN3292; ConvF(5.05,5.05,5.05); Calibrated: 02/09/2016;
- Sensor-Surface: 4mm (Mechanical Surface Detection)
- Electronics: DAE4 Sn1315; Calibrated: 26/07/2016
- Phantom: SAM 1; Type: SAM;
- Measurement SW: DASY52, Version 52.8 (2); SEMCAD X Version 14.6.6 (6824)

Area Scan (51x101x1): Interpolated grid: $dx=1.500$ mm, $dy=1.500$ mm

Maximum value of SAR (interpolated) = 0.800W/kg

Zoom Scan (7x7x7)/Cube 0: Measurement grid: $dx=5$ mm, $dy=5$ mm, $dz=5$ mm

Reference Value = 7.626 V/m; Power Drift = 0.17 dB

Peak SAR (extrapolated) = 1.365 mW/g

SAR(1 g) = 0.737 mW/g; SAR(10 g) = 0.365 mW/g

Maximum value of SAR (measured) = 0.809 W/kg

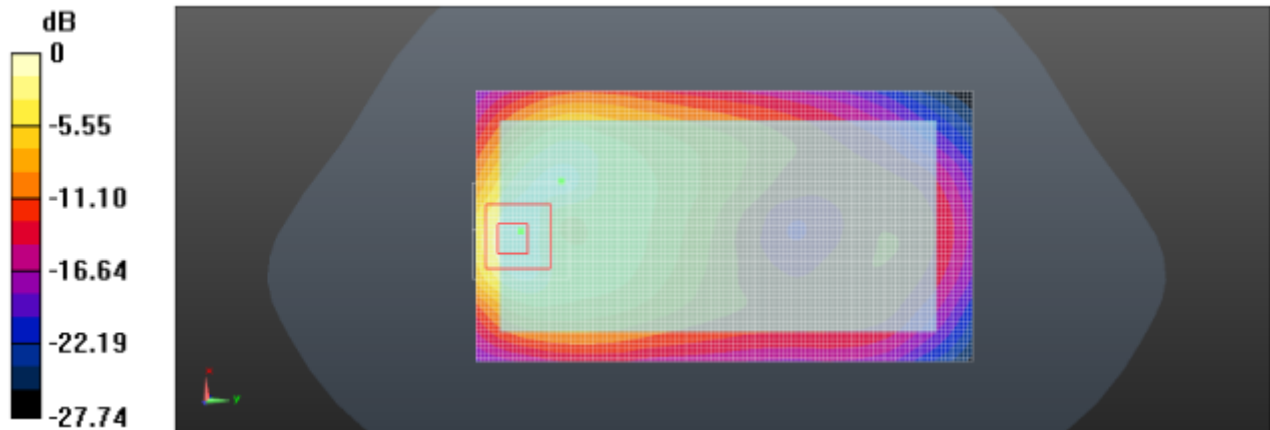

Body- worn Rear Side (LTE Band II Middle Channel)

Test mode: LTE Band IV

Test Position: Body- worn Rear Side

Test Plot: B6

Date:2017-01-22

Communication System: Generic LTE; Frequency: 1732.5 MHz;Duty Cycle: 1:1 Medium parameters used (interpolated): $f = 1732.5$ MHz; $\sigma = 1.459$ mho/m; $\epsilon_r = 53.239$; $\rho = 1000$ kg/m³

Phantom section: Flat Section

DASY5 Configuration:

- Probe: ES3DV3 - SN3292; ConvF(5.28,5.28,5.28); Calibrated: 02/09/2016;
- Sensor-Surface: 4mm (Mechanical Surface Detection)
- Electronics: DAE4 Sn1315; Calibrated: 26/07/2016
- Phantom: SAM 1; Type: SAM;
- Measurement SW: DASY52, Version 52.8 (2); SEMCAD X Version 14.6.6 (6824)

Area Scan (51x101x1): Interpolated grid: $dx=1.500$ mm, $dy=1.500$ mm

Maximum value of SAR (interpolated) =0.423 W/kg

Zoom Scan (7x7x7)/Cube 0: Measurement grid: $dx=5$ mm, $dy=5$ mm, $dz=5$ mm

Reference Value = 8.095 V/m; Power Drift = 0.11 dB

Peak SAR (extrapolated) = 0.697 mW/g

SAR(1 g) = 0.385 mW/g; SAR(10 g) = 0.231 mW/g

Maximum value of SAR (measured) = 0.429 W/kg

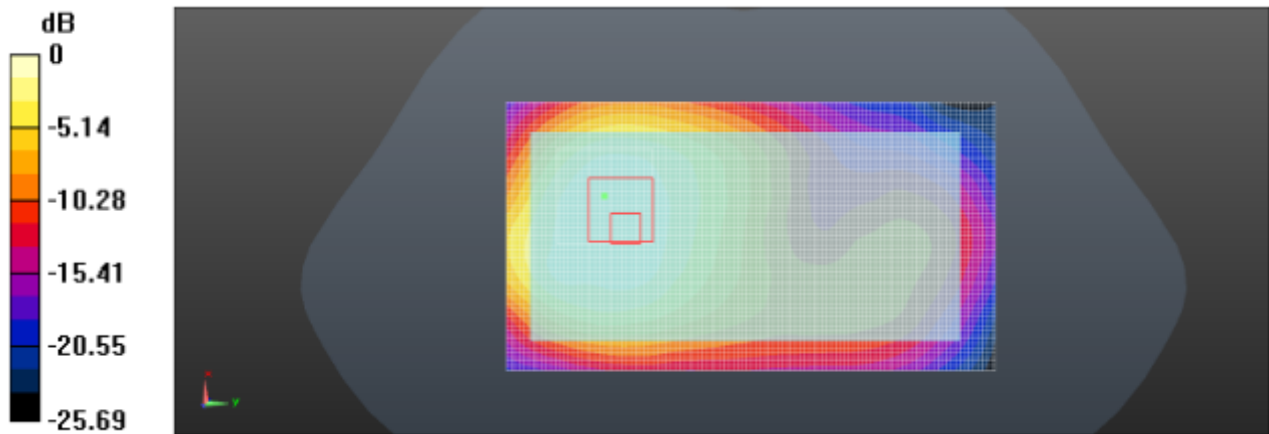

Body- worn Rear Side (LTE Band IV Middle Channel)

Test mode: LTE Band VII

Test Position: Body- worn Rear Side

Test Plot: B7

Date:2017-01-24

Communication System: Generic LTE; Frequency: 2535 MHz;Duty Cycle: 1:1

Medium parameters used: $f = 2535$ MHz; $\sigma = 1.99$ mho/m; $\epsilon_r = 52.49$; $\rho = 1000$ kg/m³

Phantom section: Flat Section

DASY5 Configuration:

- Probe: ES3DV3 - SN3292; ConvF(4.52,4.52,4.52); Calibrated: 02/09/2016;
- Sensor-Surface: 4mm (Mechanical Surface Detection)
- Electronics: DAE4 Sn1315; Calibrated: 26/07/2016
- Phantom: SAM 1; Type: SAM;
- Measurement SW: DASY52, Version 52.8 (2); SEMCAD X Version 14.6.6 (6824)

Area Scan (51x101x1): Interpolated grid: dx=1.500 mm, dy=1.500 mm

Maximum value of SAR (interpolated) =0.613 W/kg

Zoom Scan (7x7x7)/Cube 0: Measurement grid: dx=5mm, dy=5mm, dz=5mm

Reference Value = 7.362 V/m; Power Drift = -0.03 dB

Peak SAR (extrapolated) = 1.609 mW/g

SAR(1 g) = 0.538 mW/g; SAR(10 g) = 0.227 mW/g

Maximum value of SAR (measured) = 0.627 W/kg

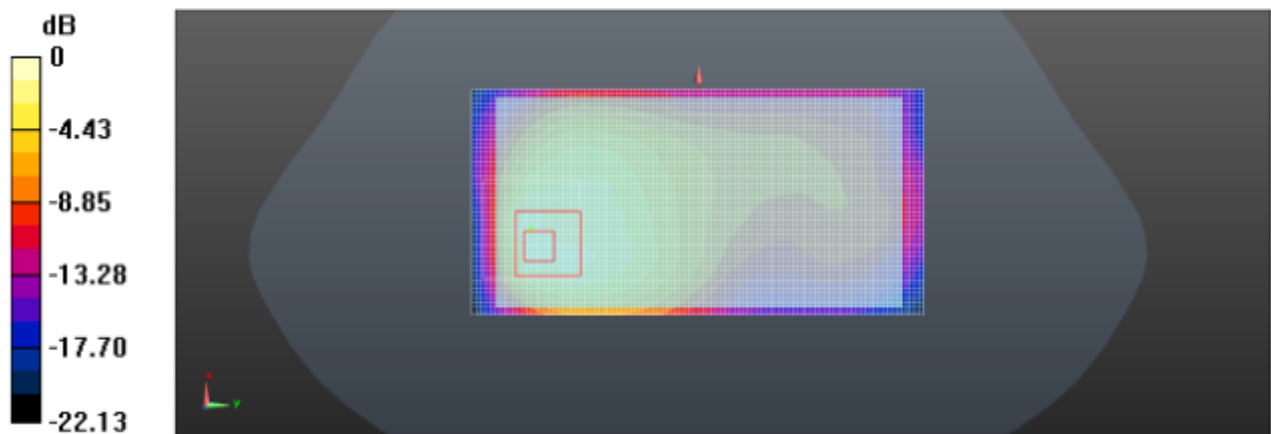

Body- worn Rear Side (LTE Band VII Middle Channel)

Test mode: WLAN 802.11b

Test Position: Body- worn Rear Side

Test Plot: B8

Date:2017-01-24

Communication System: Customer System; Frequency: 2437.0 MHz;Duty Cycle:1:1

Medium parameters used (interpolated): $f= 2437.0$ MHz; $\sigma=1.93$ S/m; $\epsilon_r=52.65$; $\rho=1000$ kg/m³

Phantom section : Flat Section

DASY5 Configuration:

- Probe: ES3DV3 - SN3292; ConvF(4.70,4.70,4.70); Calibrated: 02/09/2016;
- Sensor-Surface: 4mm (Mechanical Surface Detection)
- Electronics: DAE4 Sn1315; Calibrated: 26/07/2016
- Phantom: SAM 1; Type: SAM;
- Measurement SW: DASY52, Version 52.8 (2); SEMCAD X Version 14.6.6 (6824)

Area Scan (51x101x1): Interpolated grid: $dx=1.500$ mm, $dy=1.500$ mm

Maximum value of SAR (interpolated) = 0.112W/kg

Zoom Scan (7x7x7)/Cube 0: Measurement grid: $dx=5$ mm, $dy=5$ mm, $dz=5$ mm

Reference Value = 5.142 V/m; Power Drift = 0.12 dB

Peak SAR (extrapolated) = 0.214 mW/g

SAR(1 g) = 0.079 mW/g; SAR(10 g) = 0.043 mW/g

Maximum value of SAR (measured) = 0.116 W/kg

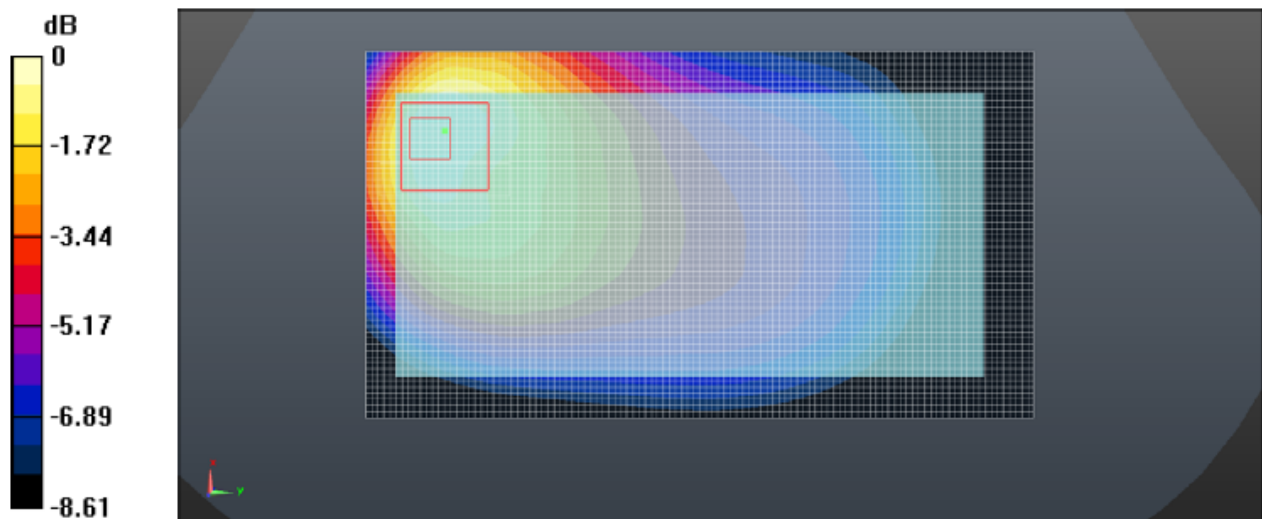

Body- worn Rear side (WLAN 802.11b Middle Channel)

15. Simultaneous Transmission analysis

No.	Simultaneous Transmission Configurations	Head	Body-worn	Hotspot	Note
1	GSM(voice) + Bluetooth (data)	Yes	Yes		
2	GSM(voice) + WIFI (data)	Yes	Yes		
3	WCDMA(voice) + Bluetooth (data)	Yes	Yes		
4	WCDMA(voice) + WIFI (data)	Yes	Yes		
5	GPRS (data) + Bluetooth (data)	Yes	Yes	NA	
6	GPRS (data) + WIFI (data)	Yes	Yes	Yes	
7	WCDMA (data) + Bluetooth (data)	Yes	Yes	NA	
8	WCDMA (data) + WIFI (data)	Yes	Yes	Yes	
9	LTE + Bluetooth (data)	Yes	Yes	NA	
10	LTE + WIFI (data)	Yes	Yes	Yes	

General note:

1. WLAN and Bluetooth share the same antenna, and cannot transmit simultaneously.
2. EUT will choose either GSM or WCDMA LTE according to the network signal condition; therefore, they will not operate simultaneously at any moment.
3. The reported SAR summation is calculated based on the same configuration and test position
4. For simultaneous transmission analysis, Bluetooth SAR is estimated per KDB 447498 D01 based on the formula below
 - a) $[(\text{max. Power of channel, including tune-up tolerance, mW}) / (\text{min. test separation distance, mm})] * [\sqrt{f(\text{GHz})}/x] \text{W/kg}$ for test separation distances $\leq 50\text{mm}$; when $x=7.5$ for 1-g SAR, and $x=18.75$ for 10-g SAR.
 - b) When the minimum separation distance is $<5\text{mm}$, the distance is used 5mm to determine SAR test exclusion
 - c) 0.4 W/kg for 1-g SAR and 1.0W/kg for 10-g SAR, when the test separation distances is $>50\text{mm}$.

Bluetooth Max power	Exposure position	Head	Hotspot	Body worn
	Test separation	0mm	10mm	10mm
9.0 dBm	Estimated SAR (W/kg)	0.33 W/kg	0.17 W/kg	0.17 W/kg

Maximum reported SAR value for Head

WWAN PCE +WIFI DTS					
WWAN Band		Exposure Position	Max SAR (W/kg)		Summed SAR (W/kg)
			WWAN PCS	WIFI DTS	
GSM	GSM850	Left Cheek	0.24	0.14	0.38
		Left Tilted	0.18	0.12	0.30
		Right Cheek	0.23	0.13	0.36
		Right Tilted	0.18	0.11	0.29
	PCS1900	Left Cheek	0.07	0.14	0.21
		Left Tilted	0.06	0.12	0.18
		Right Cheek	0.07	0.13	0.20
		Right Tilted	0.05	0.11	0.16
WCDMA	Band V	Left Cheek	0.07	0.14	0.21
		Left Tilted	0.05	0.12	0.17
		Right Cheek	0.06	0.13	0.19
		Right Tilted	0.05	0.11	0.16
	Band II	Left Cheek	0.18	0.14	0.32
		Left Tilted	0.15	0.12	0.27
		Right Cheek	0.17	0.13	0.30
		Right Tilted	0.13	0.11	0.24
LTE	Band II	Left Cheek	0.13	0.14	0.27
		Left Tilted	0.10	0.12	0.22
		Right Cheek	0.12	0.13	0.25
		Right Tilted	0.10	0.11	0.21
	Band IV	Left Cheek	0.32	0.14	0.46
		Left Tilted	0.24	0.12	0.36
		Right Cheek	0.30	0.13	0.43
		Right Tilted	0.23	0.11	0.34
	Band VII	Left Cheek	0.18	0.14	0.32
		Left Tilted	0.15	0.12	0.27
		Right Cheek	0.17	0.13	0.30
		Right Tilted	0.14	0.11	0.25

WWAN PCE + Bluetooth DSS					
WWAN Band		Exposure Position	Max SAR (W/kg)		Summed SAR (W/kg)
			WWAN PCS	BT DTS	
GSM	GSM850	Left Cheek	0.24	0.33	0.57
		Left Tilted	0.18	0.33	0.52
		Right Cheek	0.23	0.33	0.56
		Right Tilted	0.18	0.33	0.51
	PCS1900	Left Cheek	0.07	0.33	0.41
		Left Tilted	0.06	0.33	0.39
		Right Cheek	0.07	0.33	0.40
		Right Tilted	0.05	0.33	0.38
WCDMA	Band V	Left Cheek	0.07	0.33	0.40
		Left Tilted	0.05	0.33	0.39
		Right Cheek	0.06	0.33	0.39
		Right Tilted	0.05	0.33	0.38
	Band II	Left Cheek	0.18	0.33	0.51
		Left Tilted	0.15	0.33	0.48
		Right Cheek	0.17	0.33	0.51
		Right Tilted	0.13	0.33	0.46
LTE	Band II	Left Cheek	0.13	0.33	0.46
		Left Tilted	0.10	0.33	0.43
		Right Cheek	0.12	0.33	0.45
		Right Tilted	0.10	0.33	0.43
	Band IV	Left Cheek	0.32	0.33	0.65
		Left Tilted	0.24	0.33	0.57
		Right Cheek	0.30	0.33	0.63
		Right Tilted	0.23	0.33	0.56
	Band VII	Left Cheek	0.18	0.33	0.51
		Left Tilted	0.15	0.33	0.48
		Right Cheek	0.17	0.33	0.50
		Right Tilted	0.14	0.33	0.47

Maximum reported SAR value for Body

WWAN PCE + WIFI DTS					
WWAN Band		Exposure Position	Max SAR (W/kg)		Summed SAR (W/kg)
			WWAN PCS	WIFI DTS	
GSM	GSM850	Front	0.46	0.06	0.52
		Back	0.70	0.11	0.81
	PCS1900	Front	0.29	0.06	0.35
		Back	0.45	0.11	0.56
WCDMA	Band V	Front	0.17	0.06	0.23
		Back	0.25	0.11	0.36
	Band II	Front	0.58	0.06	0.64
		Back	0.84	0.11	0.95
LTE	Band II	Front	0.56	0.06	0.62
		Back	0.85	0.11	0.96
	Band IV	Front	0.29	0.06	0.35
		Back	0.44	0.11	0.55
	Band VII	Front	0.41	0.06	0.47
		Back	0.58	0.11	0.69

WWAN PCE + Bluetooth DSS					
WWAN Band		Exposure Position	Max SAR (W/kg)		Summed SAR (W/kg)
			WWAN PCS	Bluetooth DTS	
GSM	GSM850	Front	0.46	0.17	0.63
		Back	0.70	0.17	0.86
	PCS1900	Front	0.29	0.17	0.46
		Back	0.45	0.17	0.61
WCDMA	Band V	Front	0.17	0.17	0.34
		Back	0.25	0.17	0.41
	Band II	Front	0.58	0.17	0.74
		Back	0.84	0.17	1.01
LTE	Band II	Front	0.56	0.17	0.73
		Back	0.85	0.17	1.02
	Band IV	Front	0.29	0.17	0.45
		Back	0.44	0.17	0.61
	Band VII	Front	0.41	0.17	0.58
		Back	0.58	0.17	0.74

Maximum reported SAR value for Hotspot mode

WWAN PCE + WLAN DTS					
WWAN Band		Exposure Position	Max SAR (W/kg)		Summed SAR (W/kg)
			WWAN PCS	WLAN DTS	
GSM	GSM850	Front	0.46	0.06	0.52
		Back	0.70	0.11	0.81
		Left side	0.31	0.04	0.35
		Right side	0.22	-	0.22
		Top side	-	0.04	0.04
		Bottom side	0.40	-	0.4
	PCS1900	Front	0.29	0.06	0.35
		Back	0.45	0.11	0.56
		Left side	0.20	0.04	0.24
		Right side	0.15	-	0.15
		Top side	-	0.04	0.04
		Bottom side	0.26	-	0.26
WCDMA	Band V	Front	0.17	0.06	0.23
		Back	0.25	0.11	0.36
		Left side	0.12	0.04	0.16
		Right side	0.11	-	0.11
		Top side	-	0.04	0.04
		Bottom side	0.14	-	0.14
	Band II	Front	0.58	0.06	0.64
		Back	0.84	0.11	0.95
		Left side	0.40	0.04	0.44
		Right side	0.45	-	0.45
		Top side	-	0.04	0.04
		Bottom side	0.44	-	0.44
LTE	B2	Front	0.56	0.06	0.62
		Back	0.85	0.11	0.96
		Left side	0.37	0.04	0.41
		Right side	0.27	-	0.27
		Top side	-	0.04	0.04
		Bottom side	0.48	-	0.48

	B4	Front	0.29	0.06	0.35
		Back	0.44	0.11	0.55
		Left side	0.19	0.04	0.23
		Right side	0.15	-	0.15
		Top side	-	0.04	0.04
		Bottom side	0.25	-	0.25
	B7	Front	0.41	0.06	0.47
		Back	0.58	0.11	0.69
		Left side	0.27	0.04	0.31
		Right side	0.26	-	0.26
		Top side	-	0.04	0.04
		Bottom side	0.33	-	0.33

16. TestSetup Photos

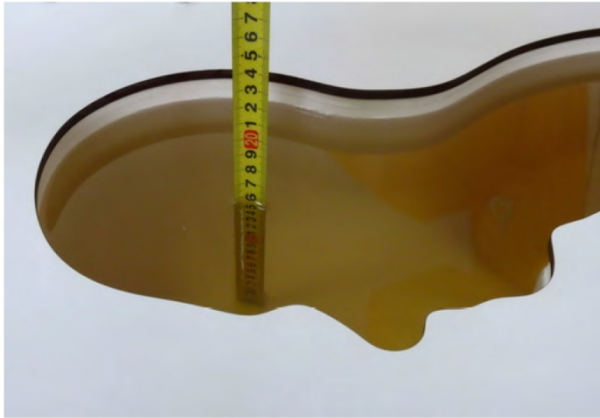

Liquid depth in the head phantom (835MHz)



Liquid depth in the body phantom (835MHz)



Liquid depth in the head phantom (1750MHz)

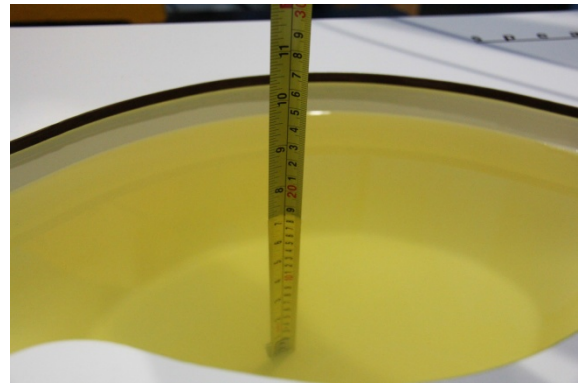

Liquid depth in the body phantom (1750MHz)



Liquid depth in the head phantom (1900MHz)



Liquid depth in the body phantom (1900MHz)

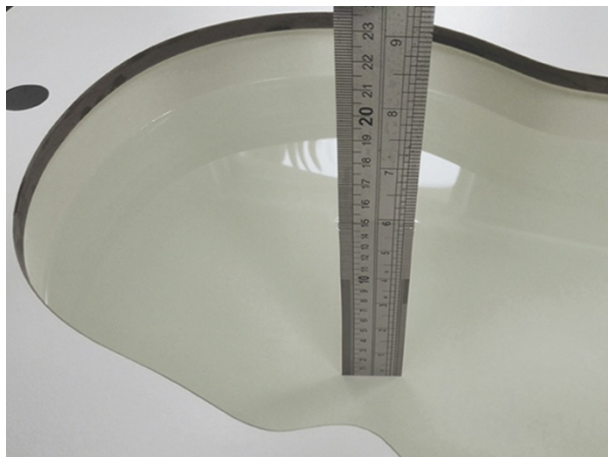

Liquid depth in the head phantom (2450MHz)



Liquid depth in the body phantom (2450MHz)

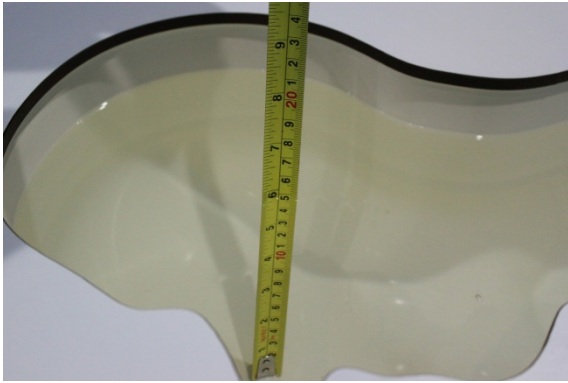

Liquid depth in the head phantom (2600MHz)

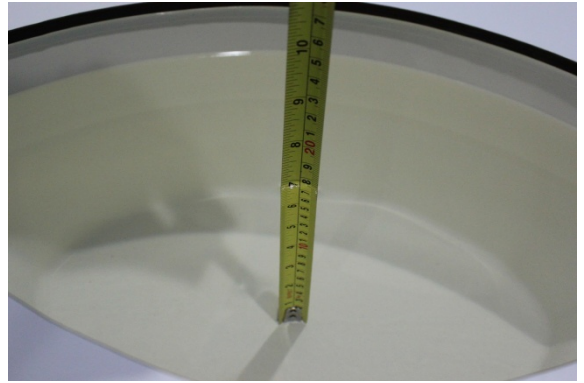

Liquid depth in the body phantom (2600MHz)



Left Head Touch

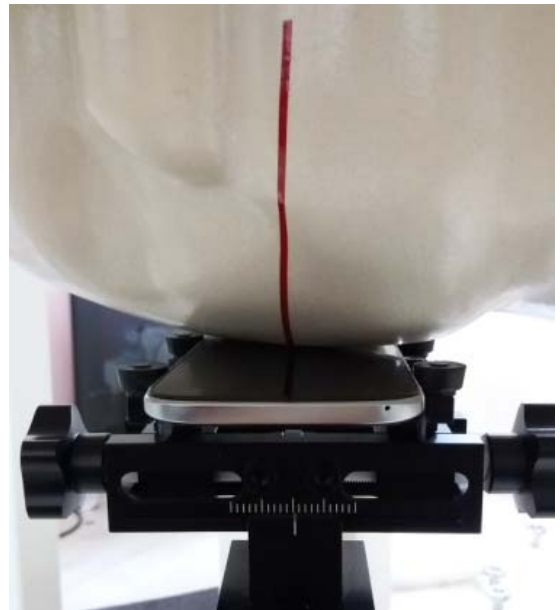

Right Head Touch



Left Head Tilt (15°)



Right Head Tilt (15°)

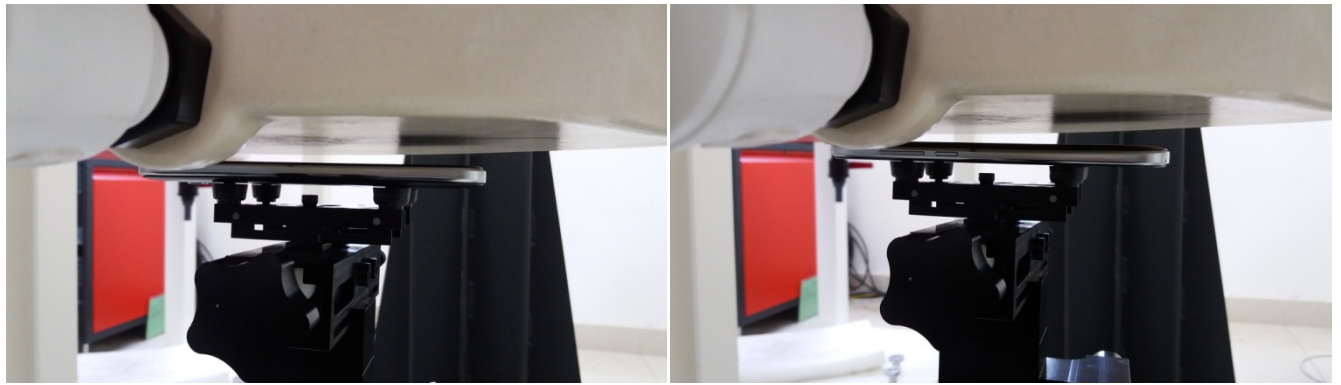

Body-worn Front Side (10mm)

Body-wornRear Side (10mm)

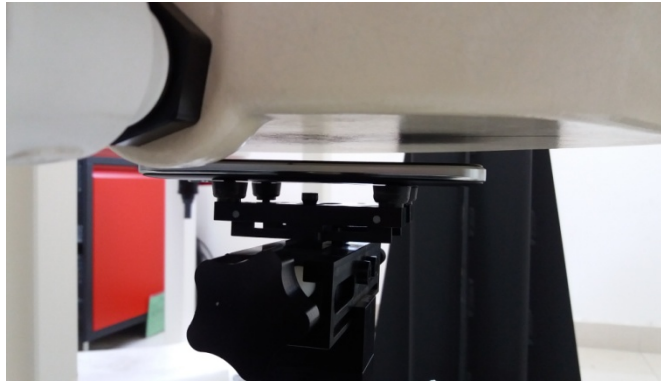

Front Side (10mm)

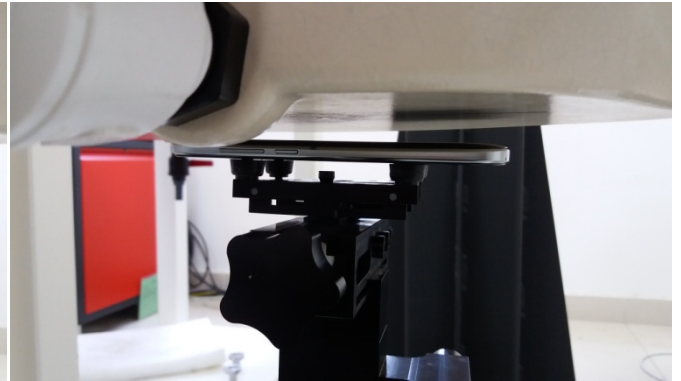

Rear Side (10mm)



Left Side (10mm)



Right Side (10mm)

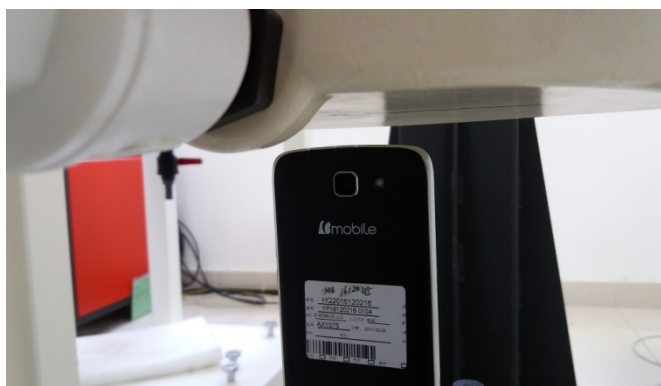

Top Side (10mm)



Bottom Side (10mm)

17. External and Internal Photos of the EUT

Please reference to the report No.: TRE1612021401

-----End of Report-----