



TEST REPORT

Report Reference No...... : **TRE1609000803** R/C.....: 14828

FCC ID..... : **ZSW-30-028**

Applicant's name..... : **b mobile HK Limited**

Address..... : Flat 18; 14/F Block 1; Golden Industrial Building;16-26 Kwai Tak Street; Kwai Chung; New Territories; Hong Kong.

Manufacturer..... : b mobile HK Limited

Address..... : Flat 18; 14/F Block 1; Golden Industrial Building;16-26 Kwai Tak Street; Kwai Chung; New Territories; Hong Kong.

Test item description : **Mobile Phone**

Trade Mark : Bmobile

Model/Type reference..... : AX820

Listed Model(s)..... : -

Standard : **FCC CFR Title 47 Part 15 Subpart C Section 15.247**

Date of receipt of test sample..... : Sep.02 ,2016

Date of testing..... : Sep.03 ,2016 ~ Sep.28, 2016

Date of issue..... : Sep.29, 2016

Result..... : **PASS**

Compiled by
(position+printedname+signature).... : File administrators Candy Liu

Candy Liu

Supervised by
(position+printedname+signature).... : Project Engineer Lion Cai

Lion Cai

Approved by
(position+printedname+signature).... : RF Manager Hans Hu

Hans Hu

Testing Laboratory Name : **Shenzhen Huatongwei International Inspection Co., Ltd**

Address..... : 1/F, Bldg 3, Hongfa Hi-tech Industrial Park, Genyu Road, Tianliao, Gongming, Shenzhen, China

Shenzhen Huatongwei International Inspection Co., Ltd. All rights reserved.

This publication may be reproduced in whole or in part for non-commercial purposes as long as the Shenzhen Huatongwei International Inspection Co., Ltd is acknowledged as copyright owner and source of the material. Shenzhen Huatongwei International Inspection Co., Ltd takes no responsibility for and will not assume liability for damages resulting from the reader's interpretation of the reproduced material due to its placement and context.

Contents

1.	<u>TEST STANDARDS AND TEST DESCRIPTION</u>	3
1.1.	Test Standards	3
1.2.	Test Description	3
2.	<u>SUMMARY</u>	4
2.1.	Client Information	4
2.2.	Product Description	4
2.3.	Operation state	5
2.4.	EUT configuration	5
2.5.	Modifications	5
3.	<u>TEST ENVIRONMENT</u>	6
3.1.	Address of the test laboratory	6
3.2.	Test Facility	6
3.3.	Environmental conditions	7
3.4.	Statement of the measurement uncertainty	7
3.5.	Equipments Used during the Test	8
4.	<u>TEST CONDITIONS AND RESULTS</u>	9
4.1.	Antenna requirement	9
4.2.	Conducted Emission (AC Main)	10
4.3.	Conducted Peak Output Power	13
4.4.	20dB Emission Bandwidth	16
4.5.	Carrier Frequencies Separation	19
4.6.	Hopping Channel Number	21
4.7.	Dwell Time	23
4.8.	Pseudorandom Frequency Hopping Sequence	26
4.9.	Restricted band (radiated)	27
4.10.	Bandedge and Spurious Emission (conducted)	29
4.11.	Spurious Emission (radiated)	36
5.	<u>TEST SETUP PHOTOS OF THE EUT</u>	41
6.	<u>EXTERNAL AND INTERNAL PHOTOS OF THE EUT</u>	42

1. TEST STANDARDS AND TEST DESCRIPTION

1.1. Test Standards

The tests were performed according to following standards:

[FCC Rules Part 15.247](#): Frequency Hopping, Direct Spread Spectrum and Hybrid Systems that are in operation within the bands of 902-928 MHz, 2400-2483.5 MHz, and 5725-5850 MHz.

[ANSI C63.10-2013](#): American National Standard for Testing Unlicensed Wireless Devices

1.2. Test Description

ReportSection	Test Item	Section in CFR 47	Result
4.1	Antenna Requirement	15.203/15.247 (c)	Pass
4.2	AC Power Line Conducted Emission	15.207	Pass
4.3	Conducted Peak Output Power	15.247 (b)(1)	Pass
4.4	20dB Occupied Bandwidth	15.247 (a)(1)	Pass
4.5	Carrier Frequencies Separation	15.247 (a)(1)	Pass
4.6	Hopping Channel Number	15.247 (a)(1)	Pass
4.7	Dwell Time	15.247 (a)(1)	Pass
4.8	Pseudorandom Frequency Hopping Sequence	15.247(b)(4)&TCB Exclusion List (7 July 2002)	Pass
4.9	Restricted band	15.247(d)/15.205	Pass
4.10/4.11	Radiated Emission	15.247(d)/15.209	Pass

Remark: The measurement uncertainty is not included in the test result.

2. SUMMARY

2.1. Client Information

Applicant:	b mobile HK Limited
Address:	Flat 18; 14/F Block 1; Golden Industrial Building;16-26 Kwai Tak Street; Kwai Chung; New Territories; Hong Kong.
Manufacturer:	b mobile HK Limited
Address:	Flat 18; 14/F Block 1; Golden Industrial Building;16-26 Kwai Tak Street; Kwai Chung; New Territories; Hong Kong.

2.2. Product Description

Name of EUT	Mobile Phone
Trade Mark:	Bmobile
Model No.:	AX820
Listed Model(s):	-
IMEI 1:	862893009047858
IMEI 2:	862893009047866
Power supply:	DC 3.8V From internal battery
Adapter information:	Input:AC 100-240V 50/60Hz 0.2A Output: 5Vd.c., 1.0A
Bluetooth	
Version:	Supported BT2.1+ EDR
Modulation:	GFSK, $\pi/4$ DQPSK, 8DPSK
Operation frequency:	2402MHz~2480MHz
Channel number:	79
Channel separation:	1MHz
Antenna type:	Internal Antenna
Antenna gain:	-4.0dBi

2.3. Operation state

◆ Test frequency list

According to section 15.31(m), regards to the operating frequency range over 10 MHz, must select three channel which were tested. the Lowest frequency, the middle frequency, and the highest frequency of channel were selected to perform the test, please see the above gray bottom.

Channel	Frequency (MHz)
0	2402
1	2403
⋮	⋮
39	2441
⋮	⋮
77	2479
78	2480

◆ Test mode

For RF test items:

the engineering test program was provided and enabled to make EUT continuous transmit/receive.

For AC power line conducted emissions:

the EUT was set to connect with the Bluetooth under large package sizes transmission.

2.4. EUT configuration

The following peripheral devices and interface cables were connected during the measurement:

● - supplied by the manufacturer

○ - supplied by the lab

	Length (m) :	1.1m
	Shield :	not
	Detachable :	b mobile HK Limited
	Manufacturer :	-
	Model No. :	

2.5. Modifications

No modifications were implemented to meet testing criteria.

3. TEST ENVIRONMENT

3.1. Address of the test laboratory

Laboratory: Shenzhen Huatongwei International Inspection Co., Ltd.

Address: 1/F, Bldg 3, Hongfa Hi-tech Industrial Park, Genyu Road, Tianliao, Gongming, Shenzhen, China

Phone: 86-755-26748019 Fax: 86-755-26748089

3.2. Test Facility

The test facility is recognized, certified, or accredited by the following organizations:

CNAS-Lab Code: L1225

Shenzhen Huatongwei International Inspection Co., Ltd. has been assessed and proved to be in compliance with CNAS-CL01 Accreditation Criteria for Testing and Calibration Laboratories (identical to ISO/IEC17025: 2005 General Requirements) for the Competence of Testing and Calibration Laboratories, Date of Registration: February 28, 2015. Valid time is until February 27, 2018.

A2LA-Lab Cert. No. 3902.01

Shenzhen Huatongwei International Inspection Co., Ltd. EMC Laboratory has been accredited by A2LA for technical competence in the field of electrical testing, and proved to be in compliance with ISO/IEC 17025: 2005 General Requirements for the Competence of Testing and Calibration Laboratories and any additional program requirements in the identified field of testing. Valid time is until December 31, 2016.

FCC-Registration No.: 317478

Shenzhen Huatongwei International Inspection Co., Ltd. EMC Laboratory has been registered and fully described in a report filed with the FCC (Federal Communications Commission). The acceptance letter from the FCC is maintained in our files. Registration 317478, Renewal date Jul. 18, 2014, valid time is until Jul. 18, 2017.

IC-Registration No.: 5377A&5377B

The 3m Alternate Test Site of Shenzhen Huatongwei International Inspection Co., Ltd. has been registered by Certification and Engineering Bureau of Industry Canada for the performance of radiated measurements with Registration No. 5377A on Dec. 31, 2013, valid time is until Dec. 31, 2016.

Two 3m Alternate Test Site of Shenzhen Huatongwei International Inspection Co., Ltd. has been registered by Certification and Engineering Bureau of Industry Canada for the performance of radiated measurements with Registration No. 5377B on Dec.03, 2014, valid time is until Dec.03, 2017.

ACA

Shenzhen Huatongwei International Inspection Co., Ltd. EMC Laboratory can also perform testing for the Australian C-Tick mark as a result of our A2LA accreditation.

VCCI

The 3m Semi-

anechoic chamber (12.2m×7.95m×6.7m) of Shenzhen Huatongwei International Inspection Co., Ltd.

has been registered in accordance with the Regulations for Voluntary Control Measures with Registration No.: R-2484. Date of Registration: Dec. 20, 2012. Valid time is until Dec. 29, 2015.

Radiated disturbance above 1GHz measurement of Shenzhen Huatongwei International Inspection Co., Ltd. has been registered in accordance with the Regulations for Voluntary Control Measures with Registration No.: G-292. Date of Registration: Dec. 24, 2013. Valid time is until Dec. 23, 2016.

Main Ports Conducted Interference Measurement of Shenzhen Huatongwei International Inspection Co., Ltd. has been registered in accordance with the Regulations for Voluntary Control Measures with Registration No.: C-2726. Date of Registration: Dec. 20, 2012. Valid time is until Dec. 19, 2015.

Telecommunication Ports Conducted Interference Measurement of Shenzhen Huatongwei International Inspection Co., Ltd. has been registered in accordance with the Regulations for Voluntary Control Measures with Registration No.: T-1837. Date of Registration: May 07, 2013. Valid time is until May 06, 2016.

DNV

Shenzhen Huatongwei International Inspection Co., Ltd. has been found to comply with the requirements of DNV towards subcontractor of EMC and safety testing services in conjunction with the EMC and Low voltage Directives and in the voluntary field. The acceptance is based on a formal quality Audit and follow-ups according to relevant parts of ISO/IEC Guide 17025 (2005), in accordance with the requirements of the DNV Laboratory Quality Manual towards subcontractors. Valid time is until Aug. 24, 2016.

3.3. Environmental conditions

During the measurement the environmental conditions were within the listed ranges:

Temperature:	15~35°C
Relative Humidity:	30~60 %
Air Pressure:	950~1050mba

3.4. Statement of the measurement uncertainty

The data and results referenced in this document are true and accurate. The reader is cautioned that there may be errors within the calibration limits of the equipment and facilities. The measurement uncertainty was calculated for all measurements listed in this test report according to TR-100028-01 "Electromagnetic compatibility and Radio spectrum Matters (ERM); Uncertainties in the measurement of mobile radio equipment characteristics; Part 1" and TR-100028-02 "Electromagnetic compatibility and Radio spectrum Matters (ERM); Uncertainties in the measurement of mobile radio equipment characteristics; Part 2" and is documented in the Shenzhen Huatongwei International Inspection Co., Ltd quality system according to DIN EN ISO/IEC 17025. Furthermore, component and process variability of devices similar to that tested may result in additional deviation. The manufacturer has the sole responsibility of continued compliance of the device.

Hereafter the best measurement capability for Shenzhen Huatongwei laboratory is reported:

Test Items	Measurement Uncertainty	Notes
Transmitter power conducted	0.57 dB	(1)
Transmitter power Radiated	2.20 dB	(1)
Conducted spurious emission 9KHz-40 GHz	1.60 dB	(1)
Radiated spurious emission 9KHz-40 GHz	2.20 dB	(1)
Conducted Emission 9KHz-30MHz	3.39 dB	(1)
Radiated Emission 30~1000MHz	4.24 dB	(1)
Radiated Emission 1~18GHz	5.16 dB	(1)
Radiated Emission 18-40GHz	5.54 dB	(1)
Occupied Bandwidth	-----	(1)

(1) This uncertainty represents an expanded uncertainty expressed at approximately the 95% confidence level using a coverage factor of $k=1.96$.

3.5. Equipments Used during the Test

Conducted Emission (AC Main)					
Item	Test Equipment	Manufacturer	Model No.	Serial No.	Last Cal
1	Artificial Mains	Rohde&Schwarz	ESH2-Z5	100028	2015/11/02
2	EMI Test Receiver	Rohde&Schwarz	ESCI3	100038	2015/11/02
3	Pulse Limiter	Rohde&Schwarz	ESHSZ2	100044	2015/11/02
4	EMI Test Software	Rohde&Schwarz	ES-K1 V1.71	N/A	N/A

Radiated Emission					
Item	Test Equipment	Manufacturer	Model No.	Serial No.	Last Cal
1	Ultra-Broadband Antenna	ShwarzBeck	VULB9163	538	2015/11/02
2	EMI TEST RECEIVER	Rohde&Schwarz	ESI 26	100009	2015/11/02
3	EMI TEST Software	Audix	E3	N/A	N/A
4	TURNTABLE	ETS	2088	2149	N/A
5	ANTENNA MAST	ETS	2075	2346	N/A
6	EMI TEST Software	Rohde&Schwarz	ESK1	N/A	N/A
7	HORNANTENNA	ShwarzBeck	9120D	1011	2015/11/02
8	Amplifer	Sonoma	310N	E009-13	2015/11/02
9	JS amplifier	Rohde&Schwarz	JS4-00101800-28-5A	F201504	2015/11/02
10	High pass filter	Compliance Direction systems	BSU-6	34202	2015/11/02
11	HORNANTENNA	ShwarzBeck	9120D	1012	2015/11/02
12	Amplifer	Compliance Direction systems	PAP1-4060	120	2015/11/02
13	Loop Antenna	Rohde&Schwarz	HFH2-Z2	100020	2015/11/02
14	TURNTABLE	MATURO	TT2.0	----	N/A
15	ANTENNA MAST	MATURO	TAM-4.0-P	----	N/A
16	Horn Antenna	SCHWARZBECK	BBHA9170	25841	2015/11/02
17	ULTRA-BROADBAND ANTENNA	Rohde&Schwarz	HL562	100015	2015/11/02

Maximum Peak Output Power / Power Spectral Density / 6dB Bandwidth / Band Edge Compliance of RF Emission / Spurious RF Conducted Emission					
Item	Test Equipment	Manufacturer	Model No.	Serial No.	Last Cal
1	Spectrum Analyzer	Rohde&Schwarz	FSP	1164.4391.40	2015/11/02

The Cal.Interval was one year

4. TEST CONDITIONS AND RESULTS

4.1. Antenna requirement

Requirement

FCC CFR Title 47 Part 15 Subpart C Section 15.203:

An intentional radiator shall be designed to ensure that no antenna other than that furnished by the responsible party shall be used with the device. The use of a permanently attached antenna or of an antenna that uses a unique coupling to the intentional radiator, the manufacturer may design the unit so that a broken antenna can be replaced by the user, but the use of a standard antenna jack or electrical connector is prohibited.

FCC CFR Title 47 Part 15 Subpart C Section 15.247(c) (1)(i):

(i) Systems operating in the 2400-2483.5 MHz band that is used exclusively for fixed. Point-to-point operations may employ transmitting antennas with directional gain greater than 6dBi provided the maximum conducted output power of the intentional radiator is reduced by 1 dB for every 3 dB that the directional gain of the antenna exceeds 6dBi.

Test Result:

The antenna is integral antenna, the best case gain of the antenna is -4.0dBi



4.2. Conducted Emission (AC Main)

LIMIT

FCC CFR Title 47 Part 15 Subpart C Section 15.207

Frequency range (MHz)	Limit (dBuV)	
	Quasi-peak	Average
0.15-0.5	66 to 56*	56 to 46*
0.5-5	56	46
5-30	60	50

* Decreases with the logarithm of the frequency.

TEST CONFIGURATION

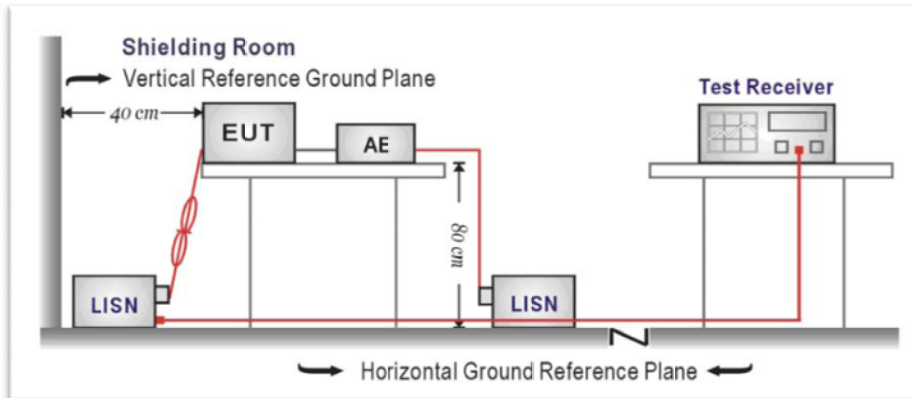

TEST PROCEDURE

1. The EUT was setup and tested according to ANSI C63.10:2013 for compliance to FCC 47CFR 15.247 requirements.
2. The EUT was placed on a platform of nominal size, 1 m by 1.5 m, raised 80 cm above the conducting ground plane. The vertical conducting plane was located 40 cm to the rear of the EUT. All other surfaces of EUT were at least 80 cm from any other grounded conducting surface.
3. The EUT and simulators are connected to the main power through a line impedance stabilization network (LISN). The LISN provides a 50 ohm /50uH coupling impedance for the measuring equipment.
4. The peripheral devices are also connected to the main power through a LISN. (Please refer to the block diagram of the test setup and photographs)
5. Each current-carrying conductor of the EUT power cord, except the ground (safety) conductor, was individually connected through a LISN to the input power source.
6. The excess length of the power cord between the EUT and the LISN receptacle were folded back and forth at the center of the lead to form a bundle not exceeding 40 cm in length.
7. Conducted emissions were investigated over the frequency range from 0.15MHz to 30MHz using a receiver bandwidth of 9 kHz.

TEST RESULTS

Test mode:AC 120V	BT	Polarization	L
-------------------	----	--------------	---

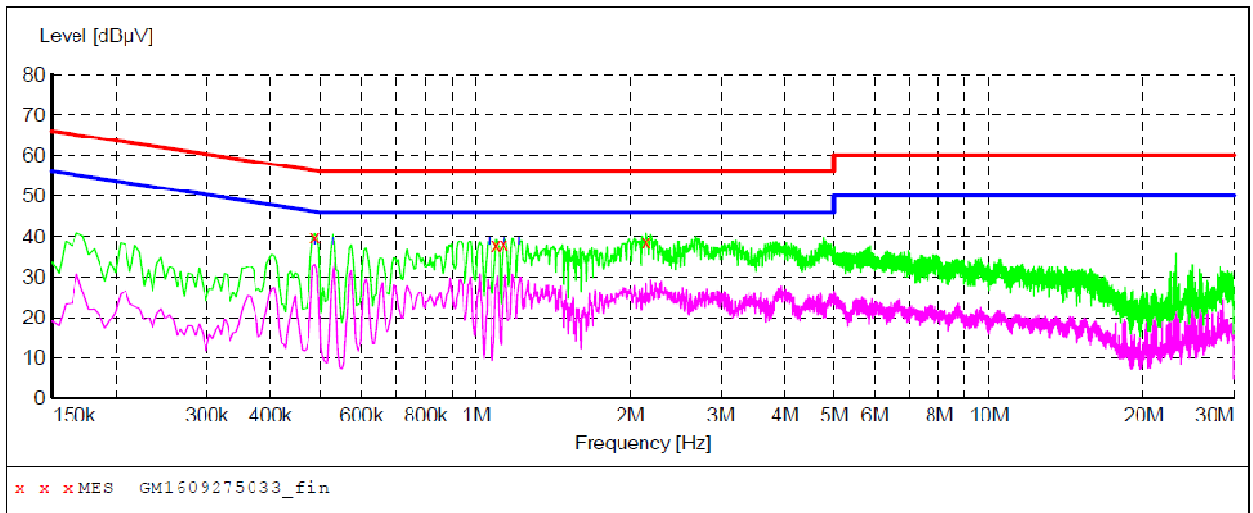

MEASUREMENT RESULT: "GM1609275033_fin"

9/27/2016 3:35PM

Frequency MHz	Level dBµV	Transd dB	Limit dBµV	Margin dB	Detector	Line	PE
0.487500	39.90	10.2	56	16.3	QP	L1	GND
1.095000	37.80	10.3	56	18.2	QP	L1	GND
1.135500	38.00	10.3	56	18.0	QP	L1	GND
2.148000	38.60	10.3	56	17.4	QP	L1	GND

MEASUREMENT RESULT: "GM1609275033_fin2"

9/27/2016 3:35PM

Frequency MHz	Level dBµV	Transd dB	Limit dBµV	Margin dB	Detector	Line	PE
0.487500	38.60	10.2	46	7.6	AV	L1	GND
0.528000	38.60	10.2	46	7.4	AV	L1	GND
1.059000	38.60	10.3	46	7.4	AV	L1	GND
1.135500	38.60	10.3	46	7.4	AV	L1	GND
1.221000	38.60	10.3	46	7.4	AV	L1	GND

Test mode: AC 120V	BT	Polarization	N
--------------------	----	--------------	---

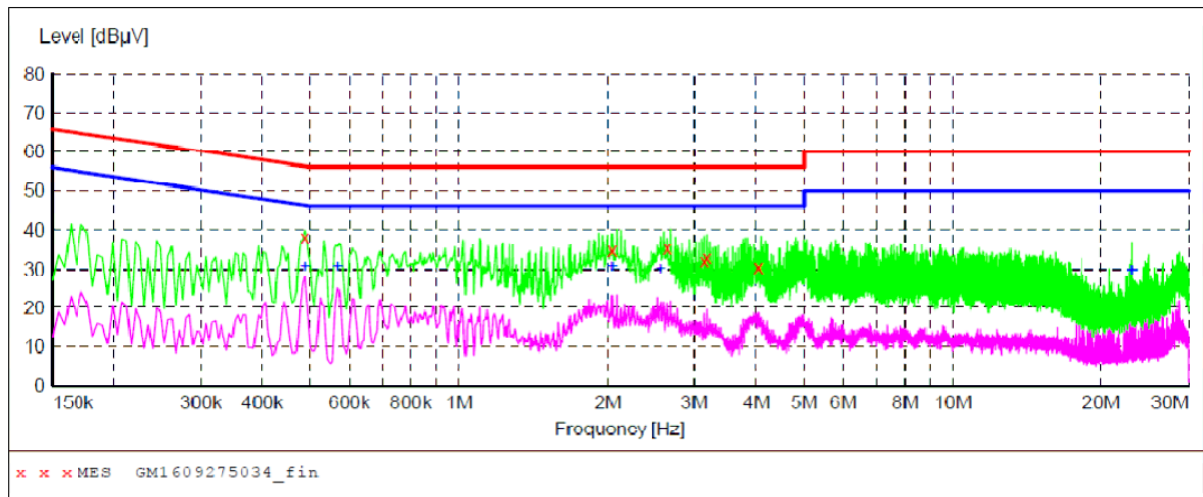

MEASUREMENT RESULT: "GM1609275034_fin"

9/27/2016 3:38PM

Frequency MHz	Level dBµV	Transd dB	Limit dBµV	Margin dB	Detector	Line	PE
0.487500	38.10	10.2	56	18.1	QP	N	GND
2.040000	34.70	10.3	56	21.3	QP	N	GND
2.652000	35.40	10.3	56	20.6	QP	N	GND
3.142500	32.00	10.4	56	24.0	QP	N	GND
3.183000	32.90	10.4	56	23.1	QP	N	GND
4.038000	30.40	10.4	56	25.6	QP	N	GND

MEASUREMENT RESULT: "GM1609275034_fin2"

9/27/2016 3:38PM

Frequency MHz	Level dBµV	Transd dB	Limit dBµV	Margin dB	Detector	Line	PE
0.487500	30.50	10.2	46	15.7	AV	N	GND
0.568500	30.60	10.2	46	15.4	AV	N	GND
2.040000	30.50	10.3	46	15.5	AV	N	GND
2.566500	29.80	10.3	46	16.2	AV	N	GND
23.068500	29.70	10.8	50	20.3	AV	N	GND
23.127000	29.70	10.8	50	20.3	AV	N	GND

Remark: Transd=Cable lose+ PULSE LIMITER factor+ ARTIFICIAL MAINS factor; Margin= Limit -Level

4.3. Conducted Peak Output Power

LIMIT

FCC CFR Title 47 Part 15 Subpart C Section 15.247 (b)(3): **30dBm**

TEST CONFIGURATION

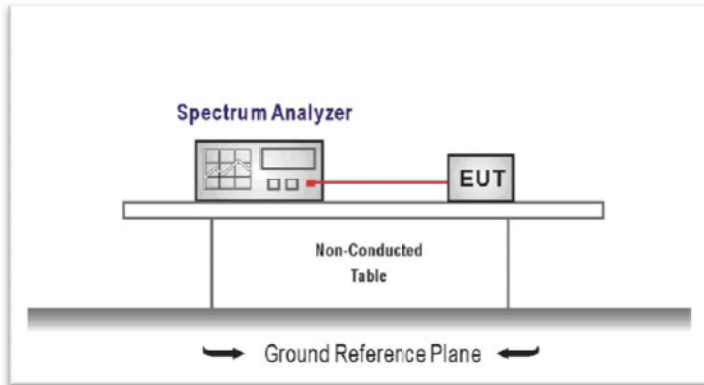

TEST PROCEDURE

Remove the antenna from the EUT and then connect a low loss RF cable from the antenna port to the spectrum.

TEST RESULTS

Modulation type	Channel	Output power (dBm)	Limit (dBm)	Result
GFSK	00	2.31	30.00	Pass
	39	2.37		
	78	2.23		
π/4DQPSK	00	2.72	21.00	Pass
	39	4.09		
	78	4.68		
8DPSK	00	3.09	21.00	Pass
	39	4.50		
	78	4.98		

Test plot as follows:

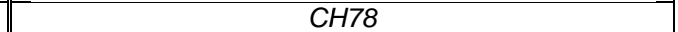
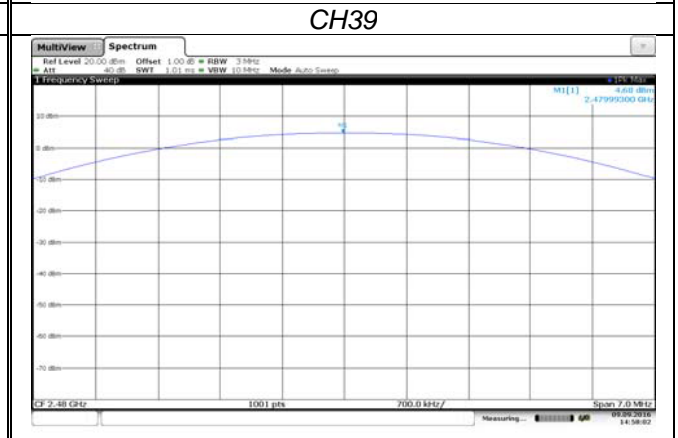
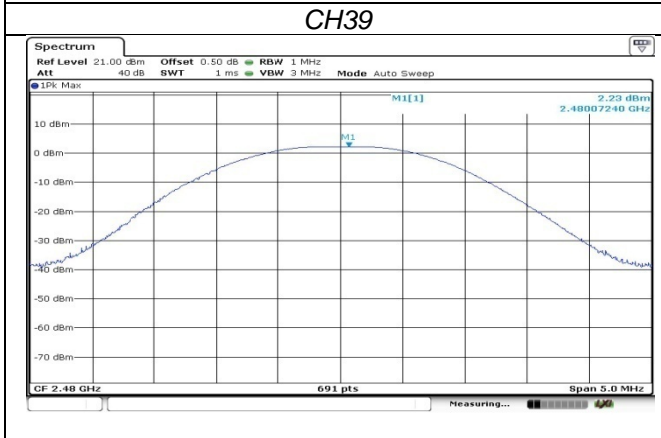
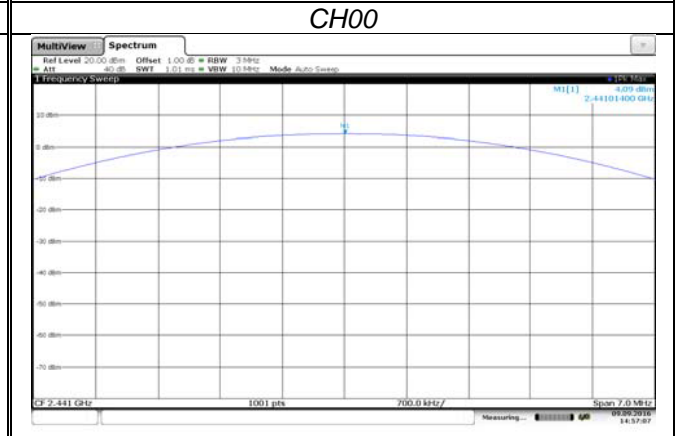
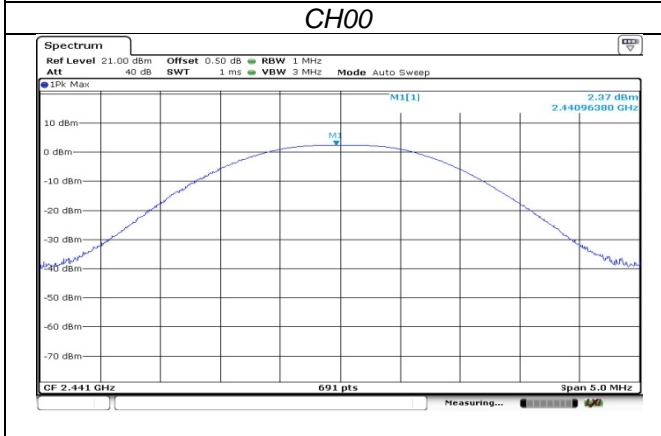
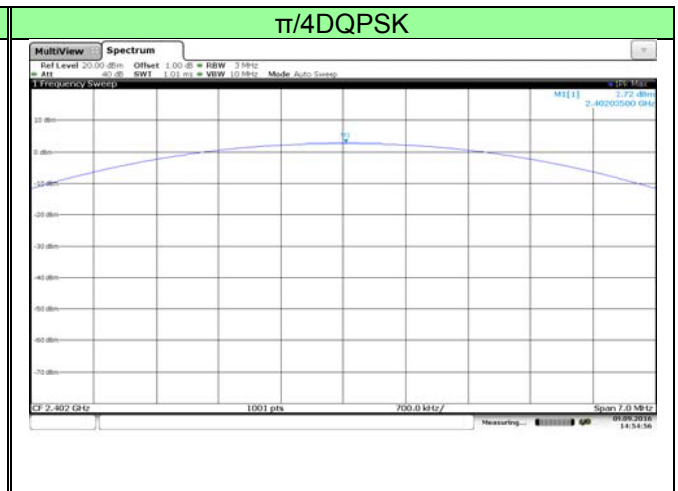
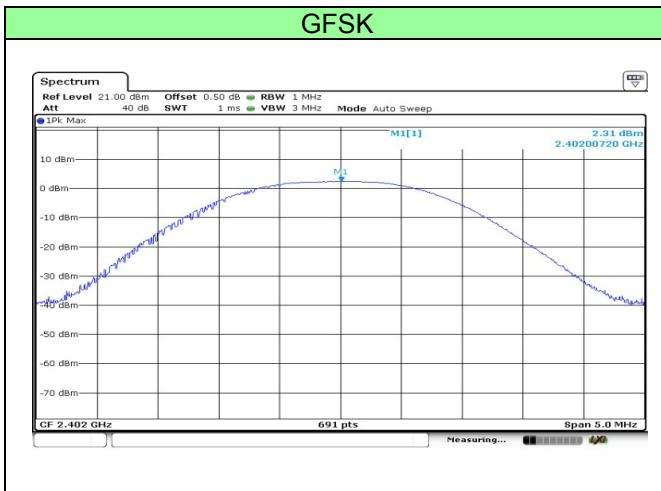

8DPSK

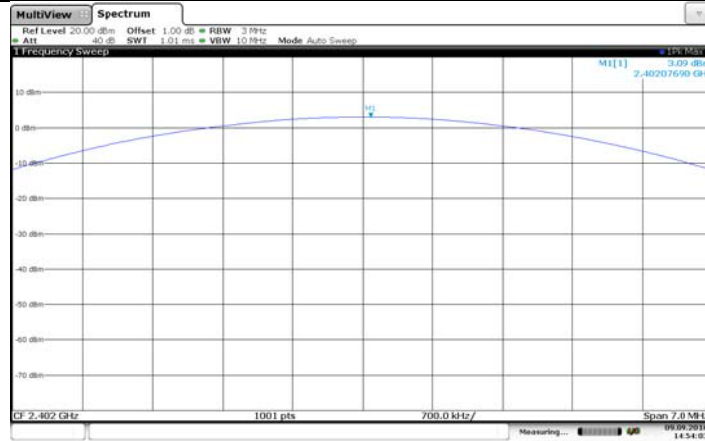

CH00

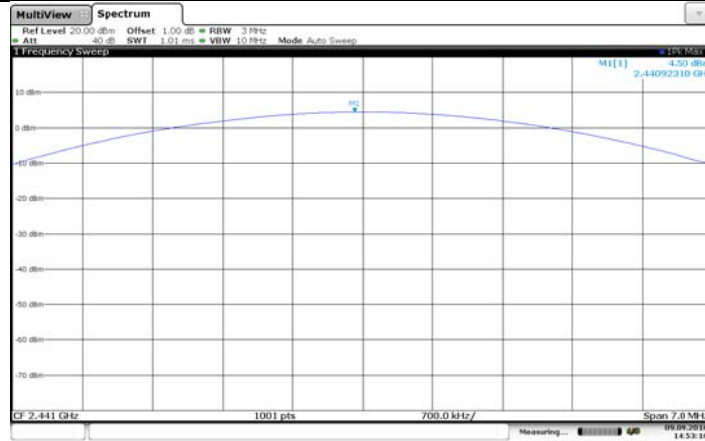

CH39

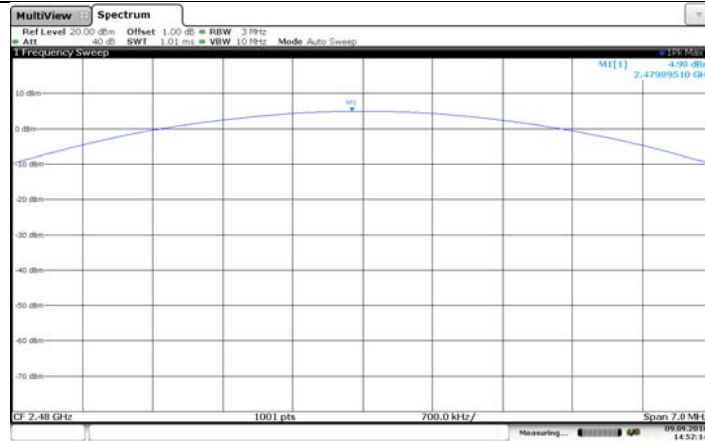

CH78

4.4. 20dB Emission Bandwidth

LIMIT

N/A

TEST CONFIGURATION

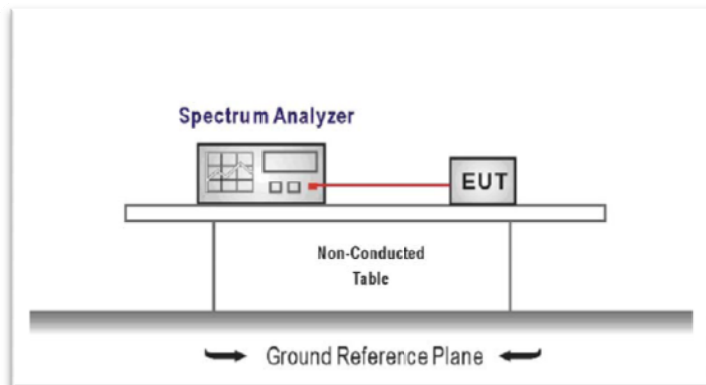

TEST PROCEDURE

1. The transmitter output was connected to the spectrum analyzer through an attenuator.
2. The bandwidth of the fundamental frequency was measured by spectrum analyzer with $RBW \geq 1\%$ of the 20 dB bandwidth and $VBW \geq RBW$.
3. The 20dB bandwidth is defined as the total spectrum the power of which is higher than peak power minus 20dB.

TEST RESULTS

Modulation type	Channel	20dB Bandwidth (MHz)	Limit (MHz)	Result
GFSK	00	0.960	/	Pass
	39	0.955		
	78	0.959		
$\pi/4$ DQPSK	00	1.331	/	Pass
	39	1.327		
	78	1.328		
8DPSK	00	1.303	/	Pass
	39	1.308		
	78	1.305		

Test plot as follows:

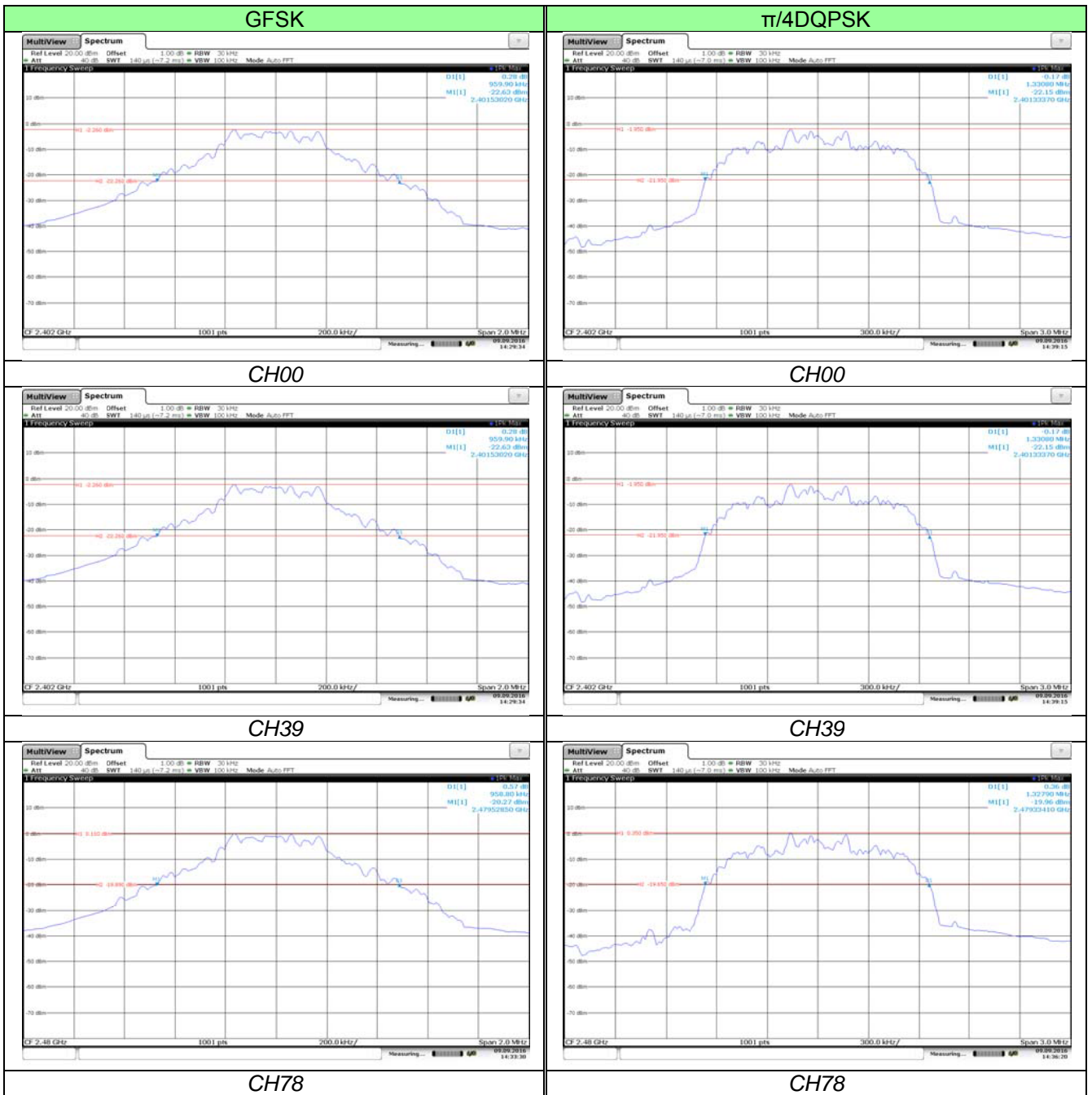

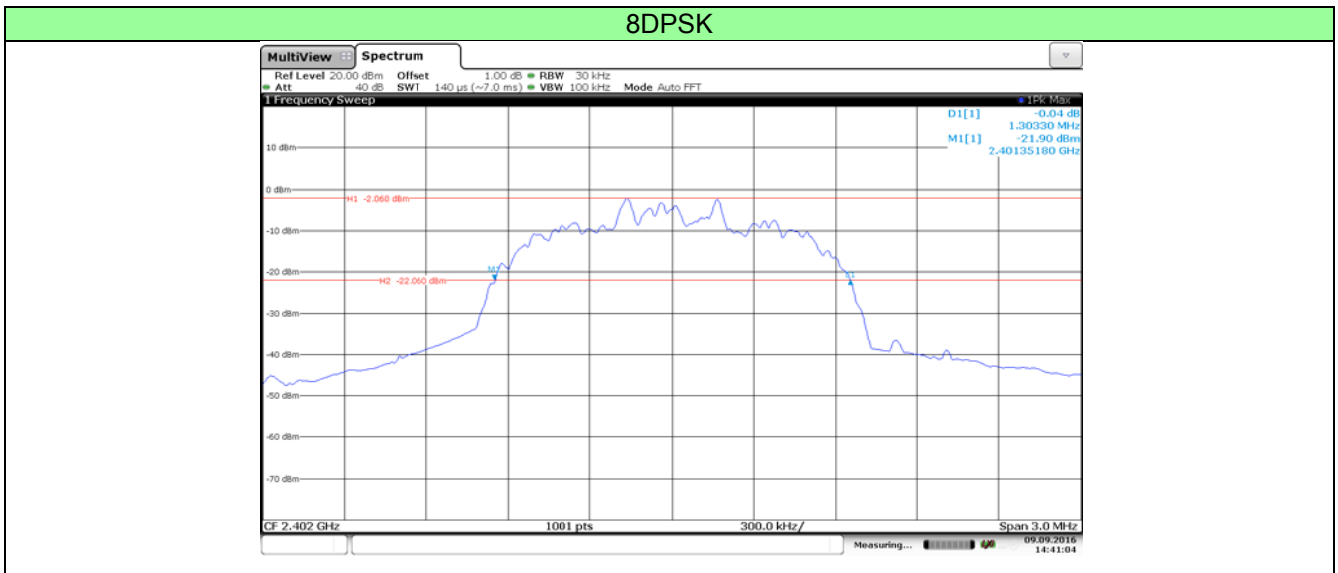

CH00

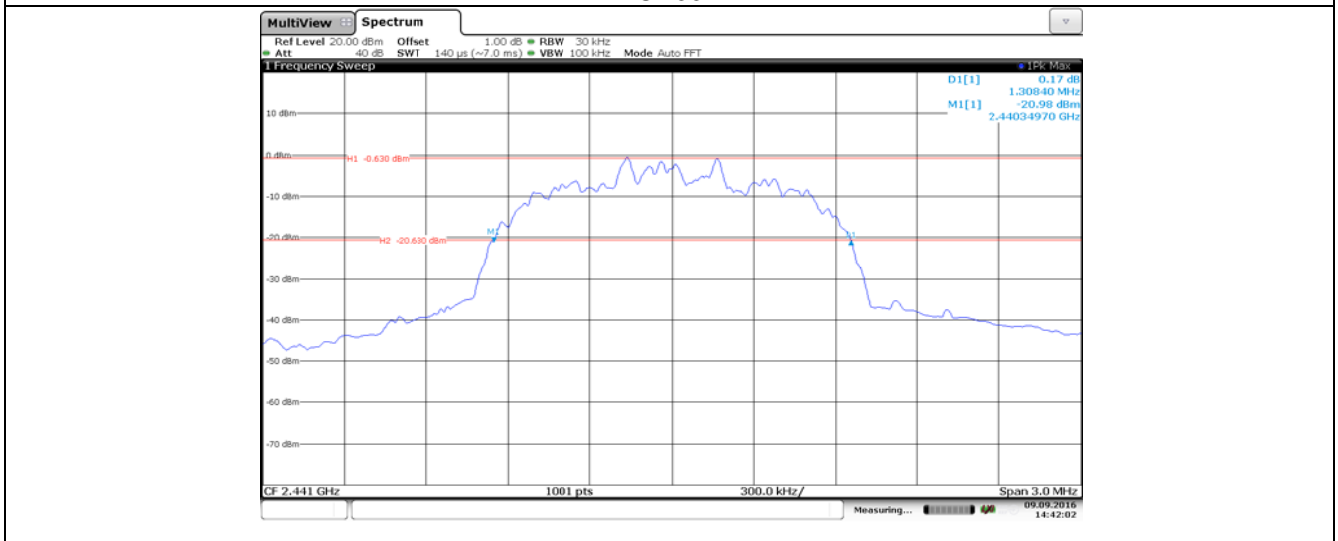

CH39

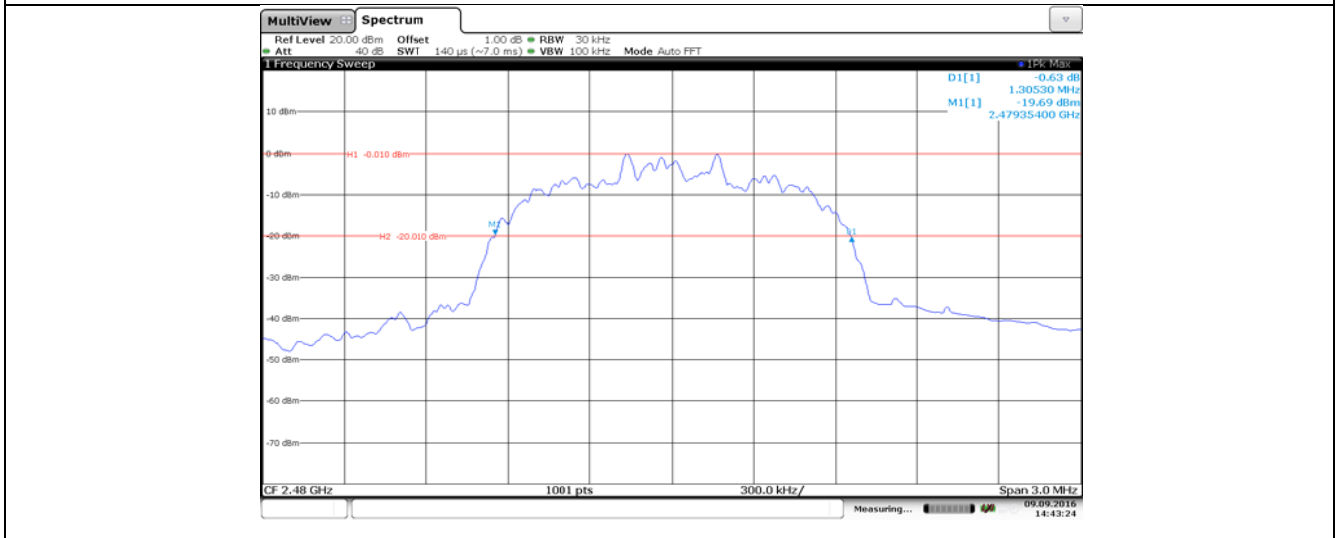

CH78

4.5. Carrier Frequencies Separation

LIMIT

FCC CFR Title 47 Part 15 Subpart C Section 15.247 (a)(1):
 frequency hopping systems shall have hopping channel carrier frequencies separated by minimum of 25KHz or the $\frac{2}{3} \times 20\text{dB}$ bandwidth of the hopping channel, whichever is greater.

TEST CONFIGURATION

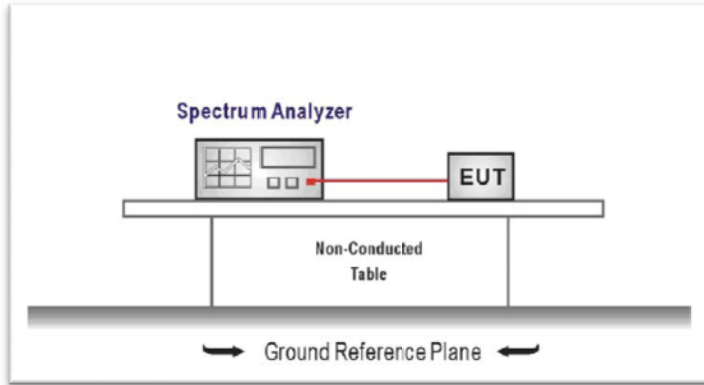

TEST PROCEDURE

1. The transmitter output was connected to the spectrum analyzer through an attenuator.
2. The bandwidth of the fundamental frequency was measured by spectrum analyzer with RBW=30 KHz and VBW=100KHz.

TEST RESULTS

Modulation type	Channel	Carrier Frequencies Separation (MHz)	Limit (MHz)	Result
GFSK	39	1.001	0.960	Pass
$\pi/4$ DQPSK	39	1.000	0.884	Pass
8DPSK	39	1.009	0.870	Pass

Test plot as follows:

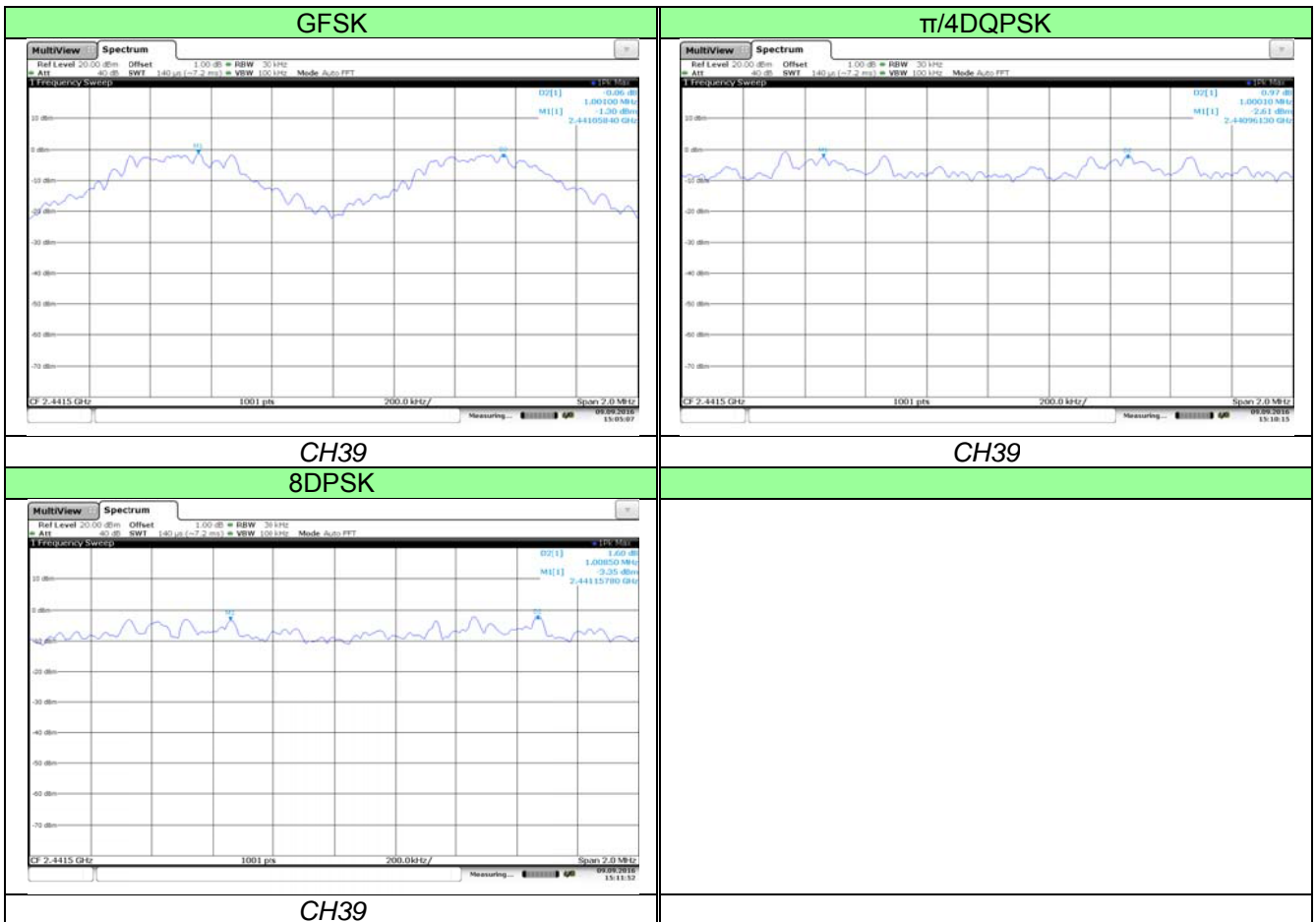

4.6. Hopping Channel Number

LIMIT

FCC CFR Title 47 Part 15 Subpart C Section 15.247 (a)(1):
 Frequency hopping systems in the 2400–2483.5 MHz band shall use at least **15** channels.

TEST CONFIGURATION

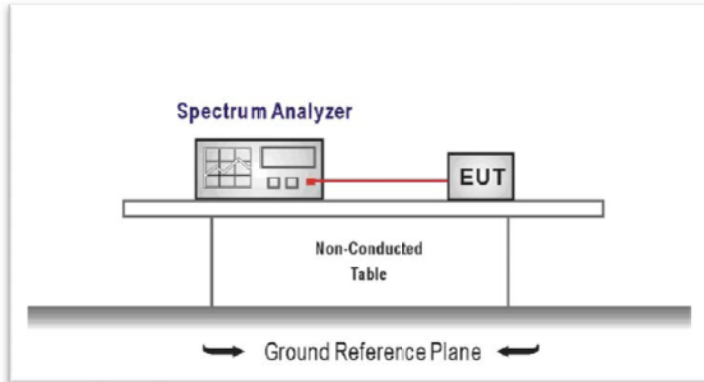

TEST PROCEDURE

1. The transmitter output was connected to the spectrum analyzer through an attenuator.
2. The bandwidth of the fundamental frequency was measured by spectrum analyzer with RBW=1MHz and VBW=3MHz.

TEST RESULTS

Modulation type	Channel number	Limit (MHz)	Result
GFSK	79	15	Pass
$\pi/4$ DQPSK	79		
8DPSK	79		

Test plot as follows:

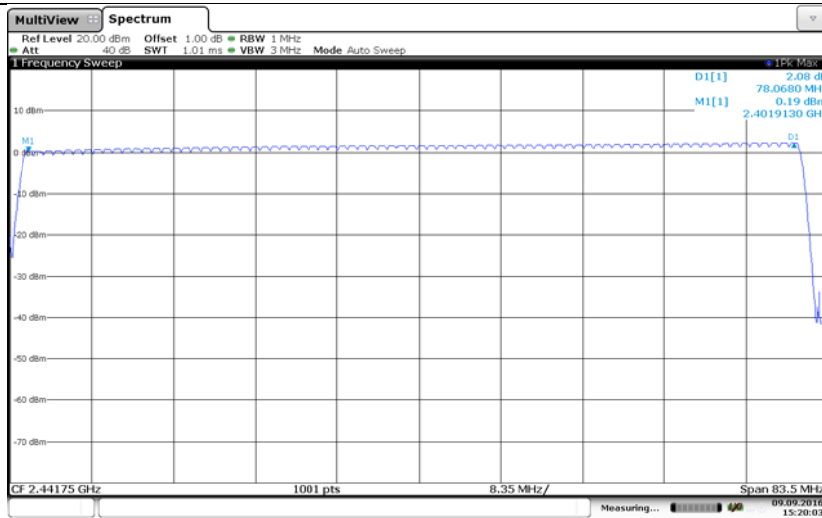

GFSK

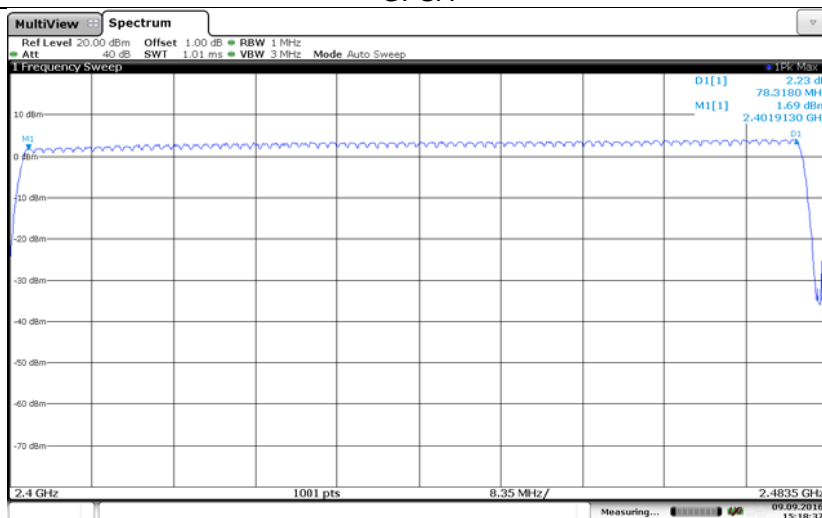

$\pi/4$ DQPSK

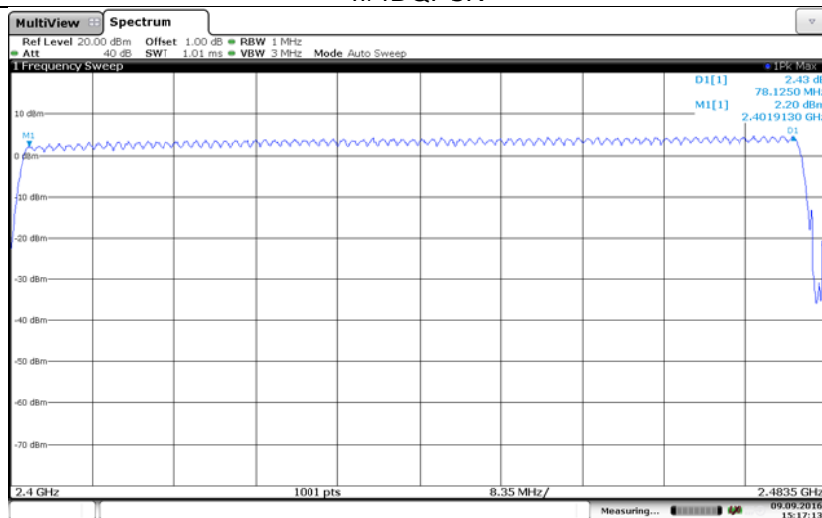

8DPSK

4.7. Dwell Time

LIMIT

FCC CFR Title 47 Part 15 Subpart C Section 15.247 (a)(1):

The average time of occupancy on any channel shall not be greater than 0.4 seconds within a pe-riod of 0.4 seconds multiplied by the number of hopping channels employed.

TEST CONFIGURATION

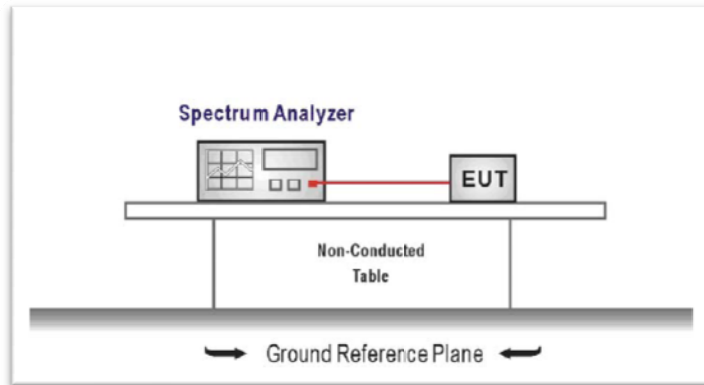

TEST PROCEDURE

1. The transmitter output was connected to the spectrum analyzer through an attenuator.
2. Set center frequency of spectrum analyzer=operating frequency with RBW=1MHz and VBW=1MHz,Span=0Hz.

TEST RESULTS

Modulation type	Channel	Dwell time (Second)	Limit (Second)	Result
GFSK	DH1	0.130	0.40	Pass
	DH3	0.258		
	DH5	0.310		
π/4DQPSK	2-DH1	0.129	0.40	Pass
	2-DH3	0.268		
	2-DH5	0.311		
8DPSK	3-DH1	0.123	0.40	Pass
	3-DH3	0.258		
	3-DH5	0.311		

Note:

1. We have tested all mode at high,middle and low channel,and recoreded worst case at middle channel.
2. Dwell time=Pulse time (ms) × (1600 ÷ 2 ÷ 79) ×31.6 Second for DH1, 2-DH1, 3-DH1
 Dwell time=Pulse time (ms) × (1600 ÷ 4 ÷ 79) ×31.6 Second for DH3, 2-DH3, 3-DH3
 Dwell time=Pulse time (ms) × (1600 ÷ 6 ÷ 79) ×31.6 Second for DH5, 2-DH5, 3-DH5

Test plot as follows:

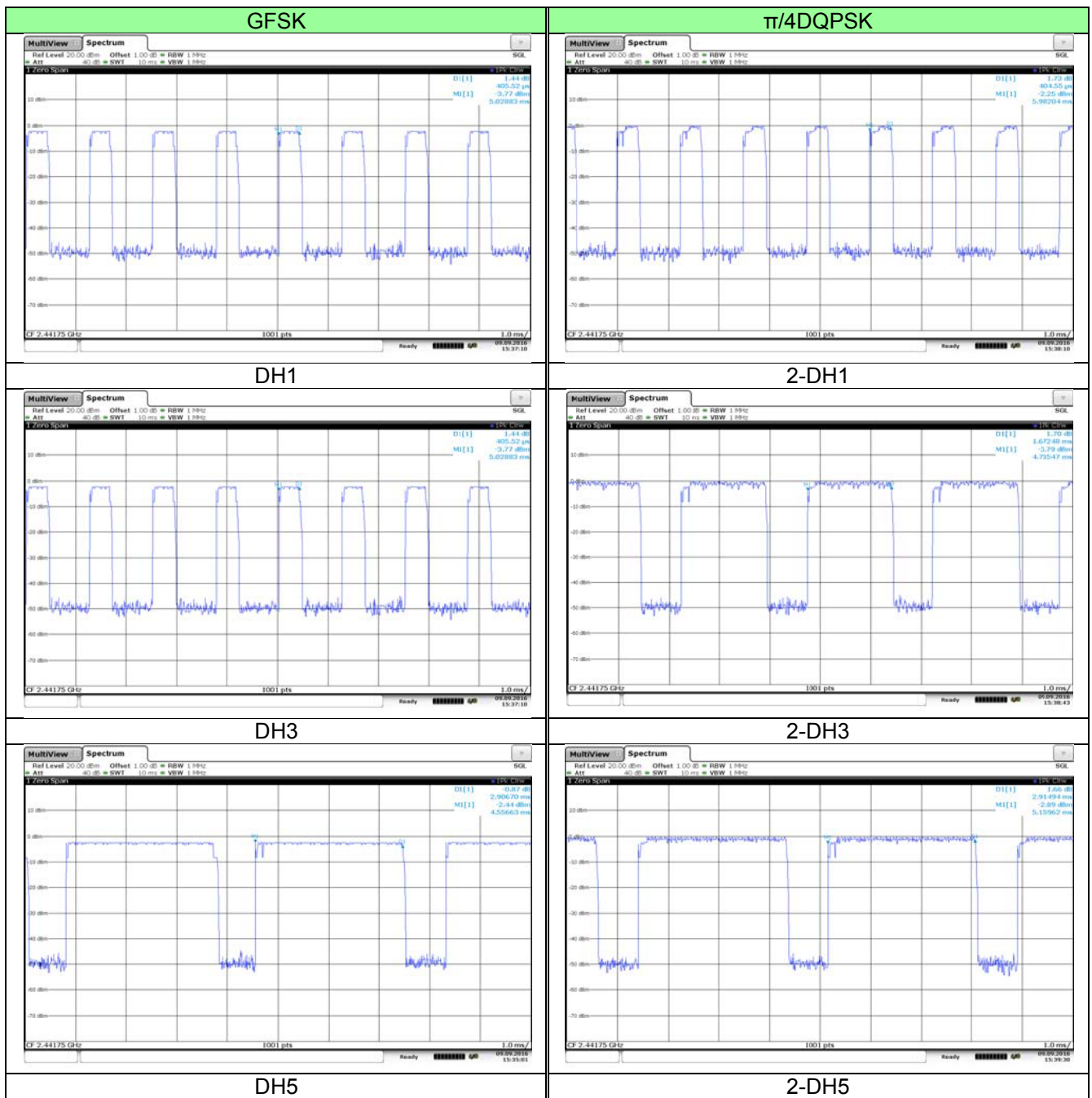

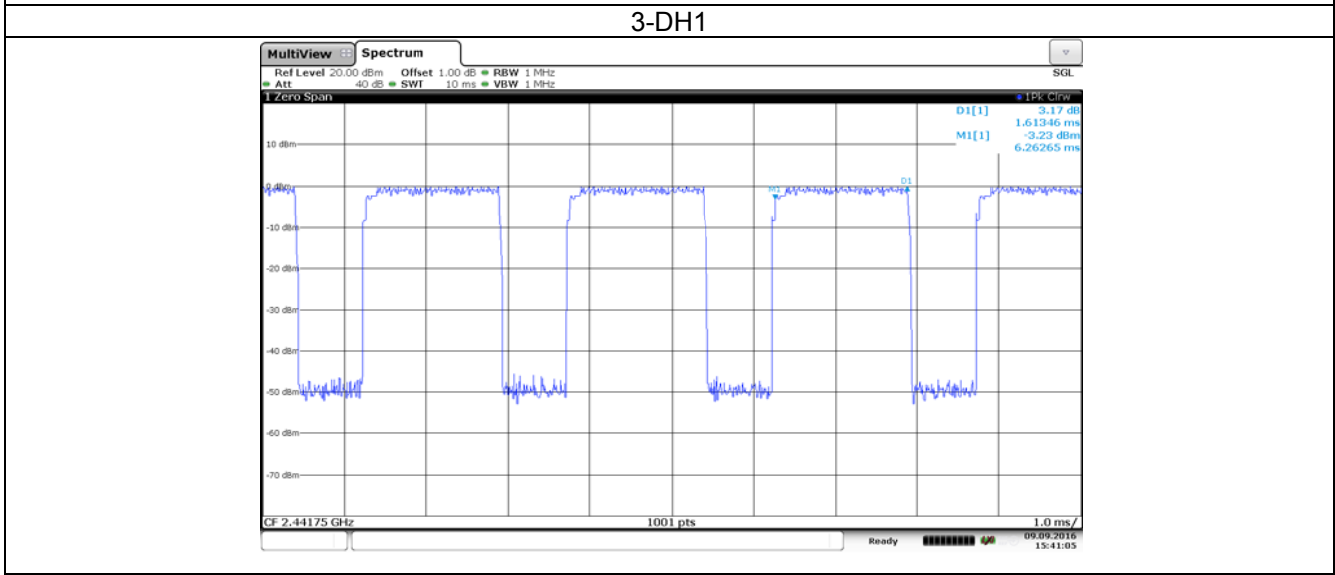
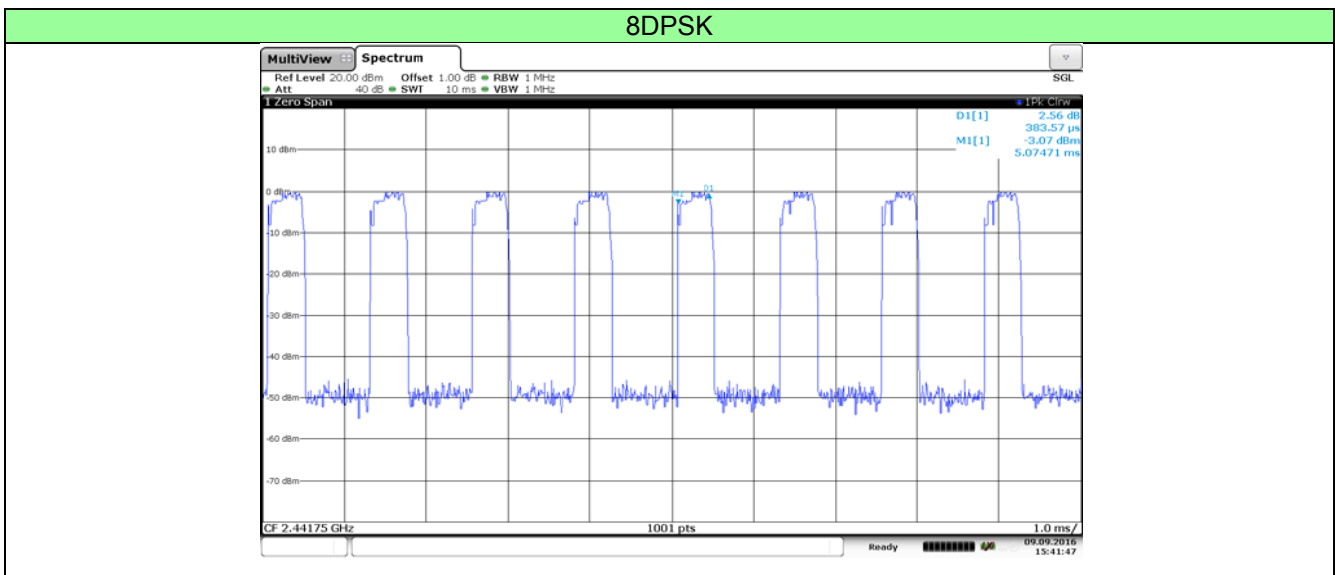

3-DH5

4.8. Pseudorandom Frequency Hopping Sequence

LIMIT

FCC CFR Title 47 Part 15 Subpart C Section 15.247 (a)(1):

Frequency hopping systems shall have hopping channel carrier frequencies separated by a minimum of 25 kHz or the 20 dB bandwidth of the hopping channel, whichever is greater. Alternatively, frequency hopping systems operating in the 2400–2483.5 MHz band may have hopping channel carrier frequencies that are separated by 25 kHz or two-thirds of the 20 dB bandwidth of the hopping channel, whichever is greater, provided the systems operate with an output power no greater than 125 mW. The system shall hop to channel frequencies that are selected at the system hopping rate from a pseudo randomly ordered list of hopping frequencies. Each frequency must be used equally on the average by each transmitter. The system receivers shall have input bandwidths that match the hopping channel bandwidths of their corresponding transmitters and shall shift frequencies in synchronization with the transmitted signals.

TEST RESULTS

The pseudorandom frequency hopping sequence may be generated in a nine-stage shift register whose 5th and 9th stage outputs are added in a modulo-two addition stage. And the result is fed back to the input of the first stage. The sequence begins with the first one of 9 consecutive ones, for example: the shift register is initialized with nine ones.

- Number of shift register stages:9
- Length of pseudo-random sequence:2⁹-1=511 bits
- Longest sequence of zeros:8(non-inverted signal)

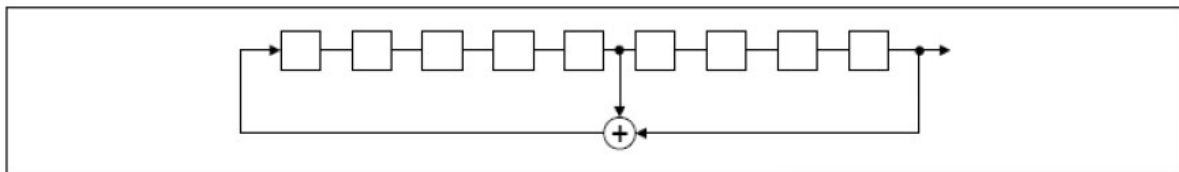

Linear Feedback Shift Register for Generation of the PRBS sequence

An example of pseudorandom frequency hopping sequence as follows:

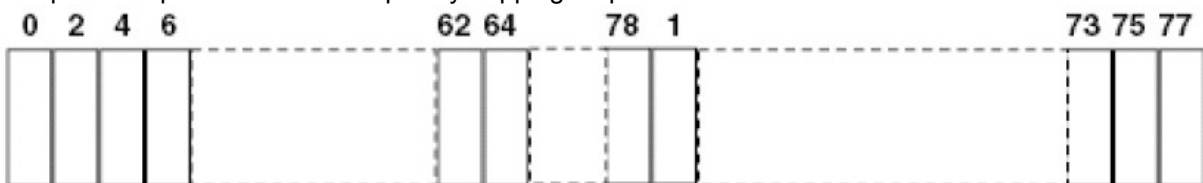

Each frequency used equally on the average by each transmitter. The system receiver has input bandwidths that match the hopping channel bandwidths of their corresponding transmitter and shifts frequencies in synchronization with the transmitted signals.

4.9. Restricted band (radiated)

LIMIT

FCC CFR Title 47 Part 15 Subpart C Section 15.209

Frequency	Limit (dBuV/m @3m)	Value
Above 1GHz	54.00	Average
	74.00	Peak

TEST CONFIGURATION

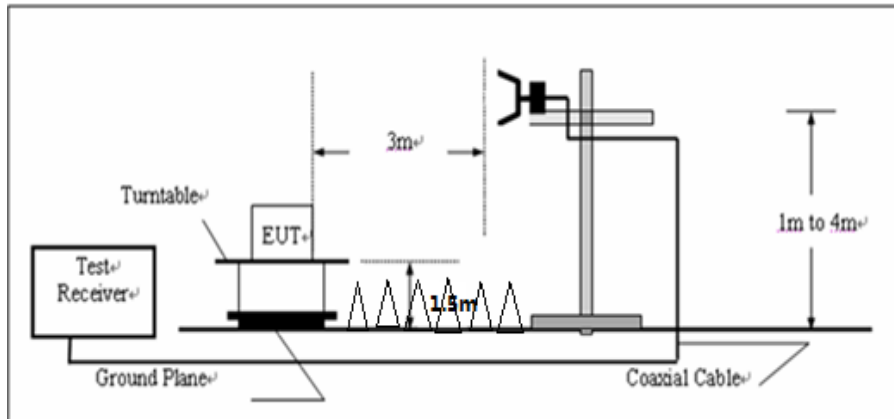

TEST PROCEDURE

1. The EUT was setup and tested according to ANSI C63.10:2013 for compliance to FCC 47CFR 15.247 requirements.
2. The EUT is placed on a turn table which is 1.5 meter above ground. The turn table is rotated 360 degrees to determine the position of the maximum emission level.
3. The EUT was positioned such that the distance from antenna to the EUT was 3 meters.
4. The antenna is scanned from 1 meter to 4 meters to find out the maximum emission level. This is repeated for both horizontal and vertical polarization of the antenna. In order to find the maximum emission, all of the interface cables were manipulated according to ANSI C63.10:2013 on radiated measurement.
5. The receiver set as follow:
 RBW=1MHz, VBW=3MHz for Peak value
 RBW=1MHz, VBW=10Hz for Average value.
6. The frequency range from 2310MHz to 2483.5MHz harmonic is checked.

TEST RESULTS

CH00									
Frequency (MHz)	Read Level (dBuV)	Antenna Factor (dB/m)	Cable Loss (dB)	Preamp Factor (dB)	Level (dBuV/m)	Limit Line (dBuV/m)	Margin Limit (dB)	Polarization	Test value
2389.02	44.63	27.53	6.81	37.24	41.73	74	-32.27	Vertical	Peak
2389.35	44.62	27.53	6.81	37.24	41.72	74	-32.28	Horizontal	
2386.47	38.15	27.53	6.81	37.24	35.25	54	-18.75	Vertical	Average
2386.29	38.74	27.53	6.81	37.24	35.84	54	-18.16	Horizontal	

CH78									
Frequency (MHz)	Read Level (dBuV)	Antenna Factor (dB/m)	Cable Loss (dB)	Preamp Factor (dB)	Level (dBuV/m)	Limit Line (dBuV/m)	Margin Limit (dB)	Polarization	Test value
2485.68	51.85	27.85	6.96	37.92	48.74	74	-25.26	Vertical	Peak
2482.75	52.96	27.85	6.96	37.92	49.85	74	-24.15	Horizontal	
2482.97	44.76	27.85	6.96	37.92	41.65	54	-12.35	Vertical	Average
2482.36	44.58	27.85	6.96	37.92	41.47	54	-12.53	Horizontal	

Note: 1. Level = Read + Antenna Factor + Cable Loss - Preamp Factor

2. Have pre-scan all modulation mode, found the GFSK modulation which it was worst case, so only the worst case's data on the test report.

4.10. Bandedge and Spurious Emission (conducted)

LIMIT

FCC CFR Title 47 Part 15 Subpart C Section 15.247 (d):

In any 100 kHz bandwidth outside the frequency band in which the spread spectrum intentional radiator is operating, the radio frequency power that is produced by the intentional radiator shall be at least 20 dB below that in the 100 kHz bandwidth within the band that contains the highest level of the desired power, based on either an RF conducted or a radiated measurement.

TEST CONFIGURATION

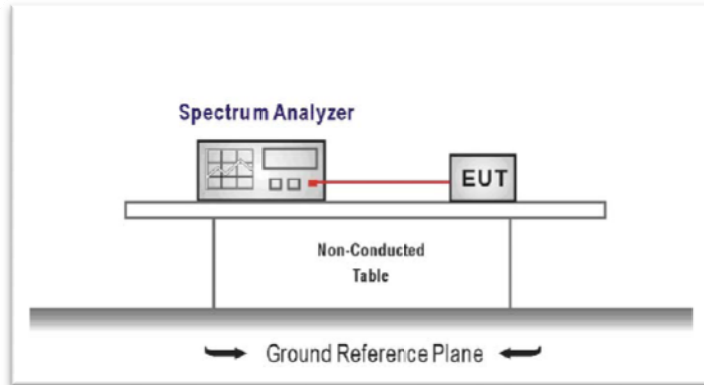

TEST PROCEDURE

1. The transmitter output was connected to the spectrum analyzer through an attenuator.
2. Conducted spurious emission the bandwidth of the fundamental frequency was measured by spectrum analyzer with RBW=100 KHz and VBW=300KHz.
3. Below -20dB of the highest emission level in operating band.

TEST RESULTS

Test plot as follows:

GFSK

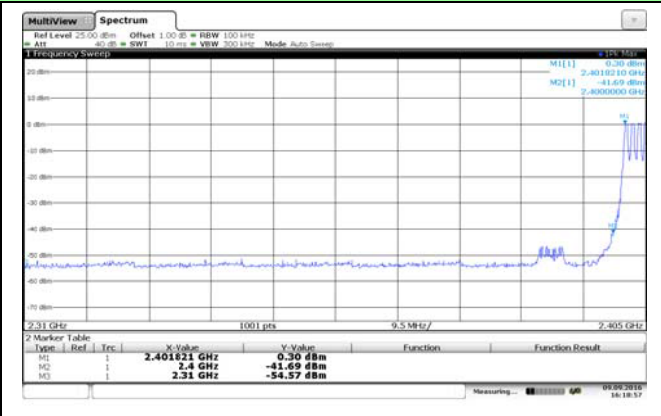
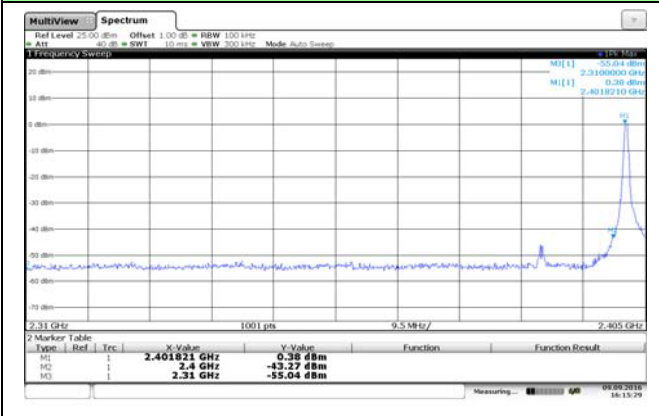

Bandedge- no hopping mode (CH00)

Bandedge- hopping mode (CH00)

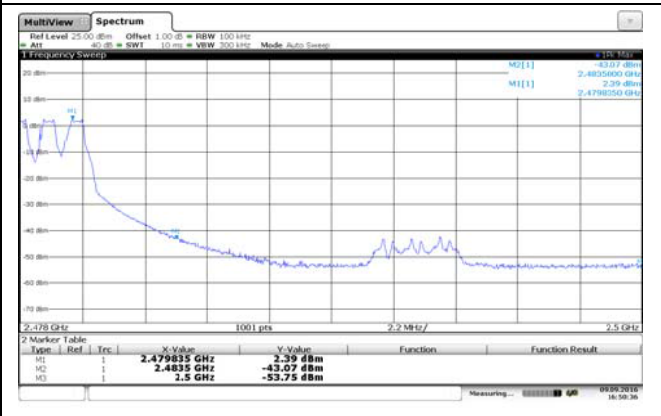
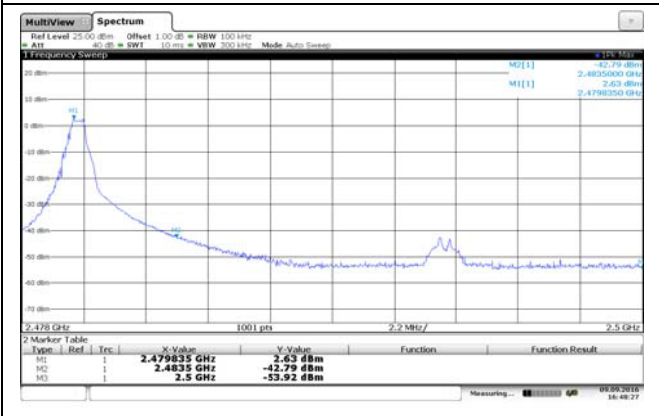

Bandedge- no hopping mode (CH78)

Bandedge- hopping mode (CH78)

GFSK Tx Spurious Emission

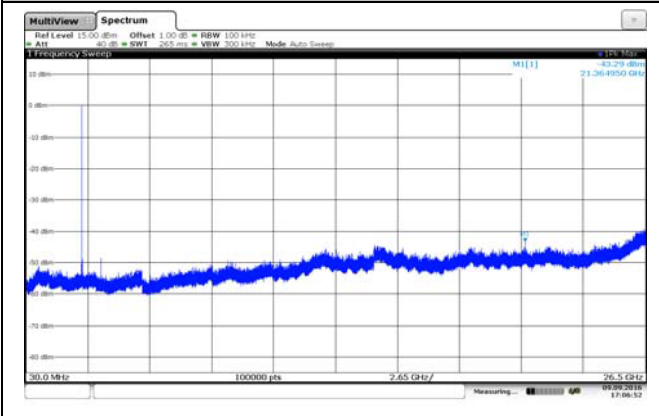

CH00

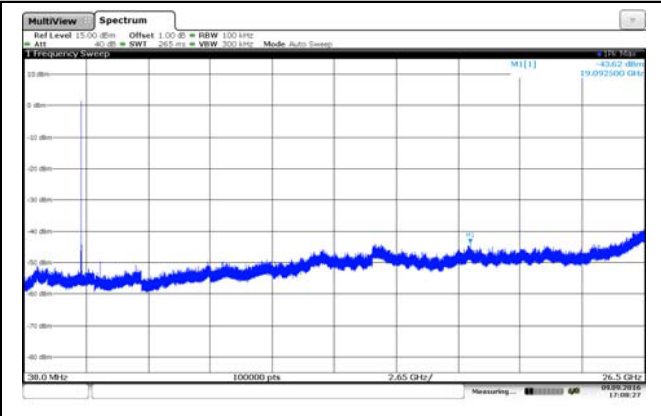

CH39

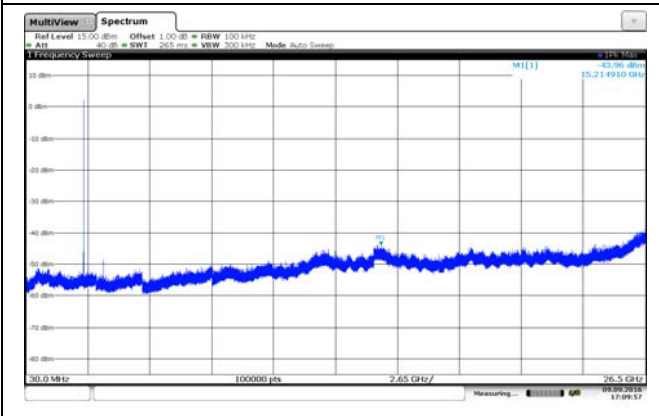

CH78

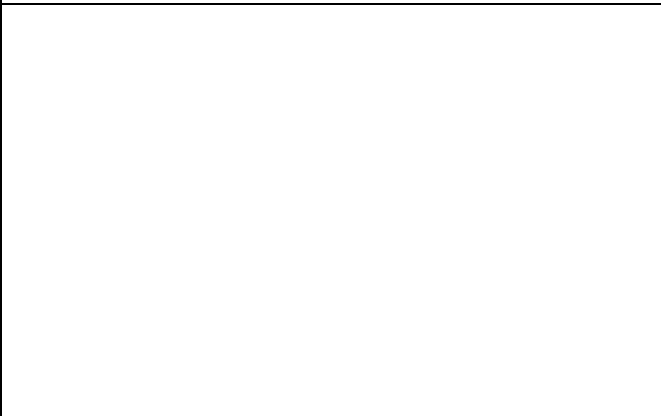

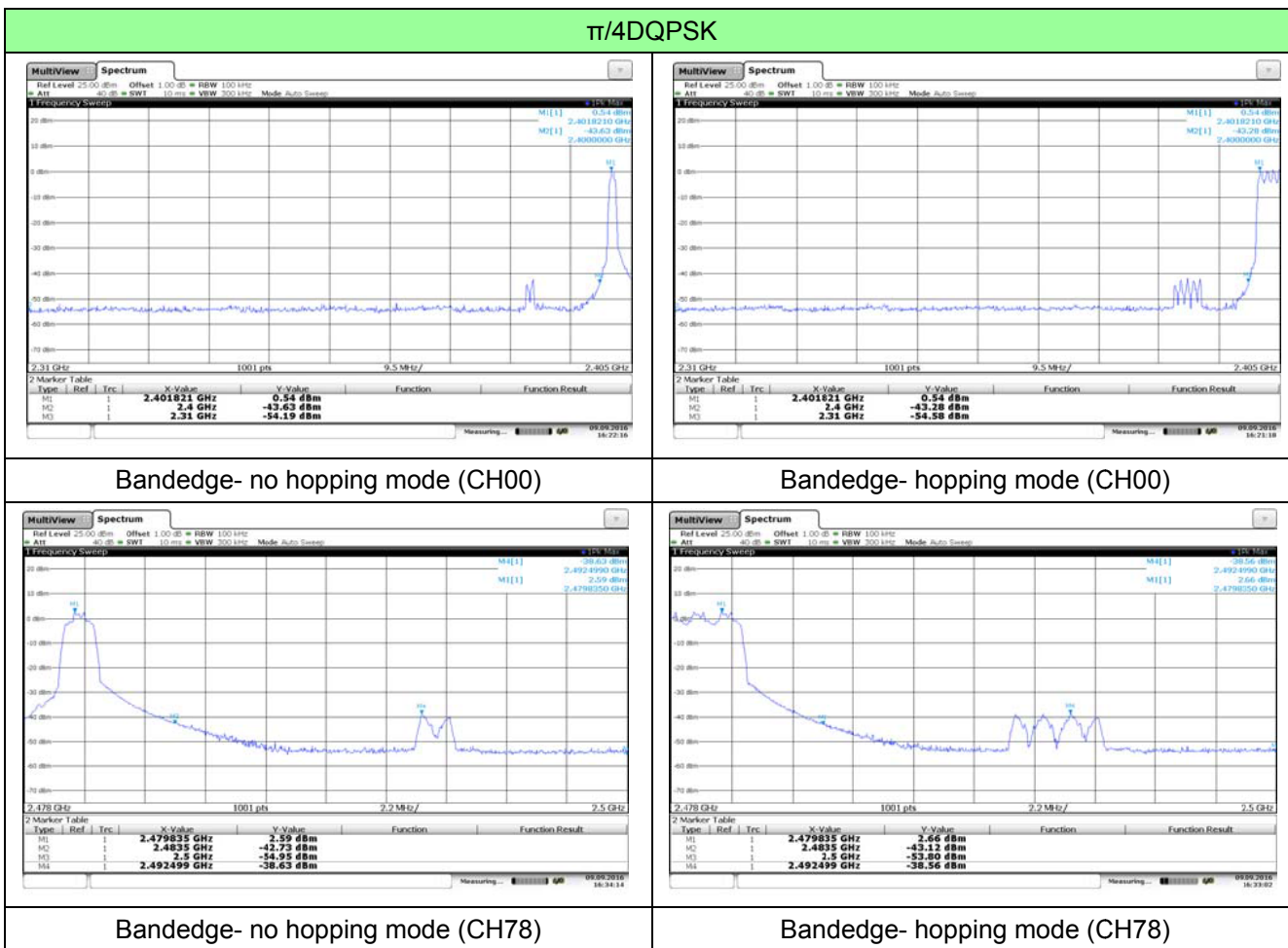

$\pi/4$ DQPSK Tx Spurious Emission

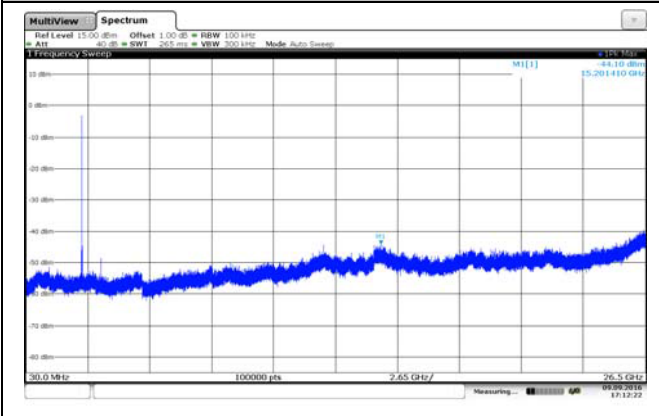

CH00

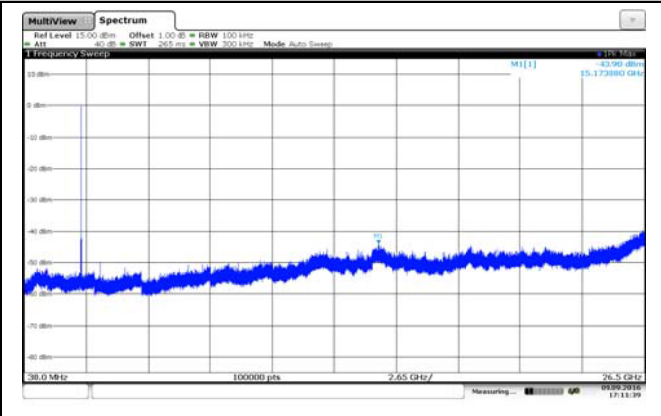

CH39

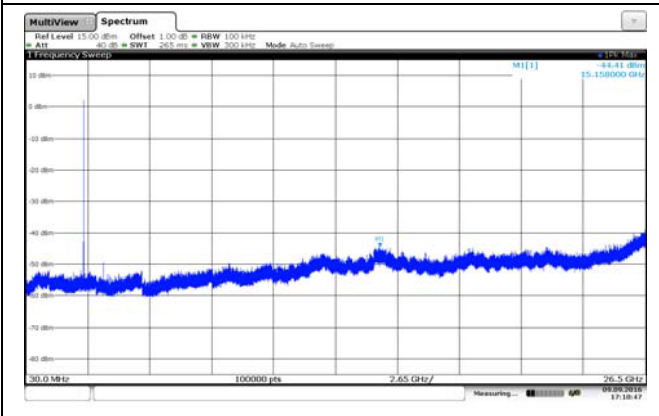

CH78

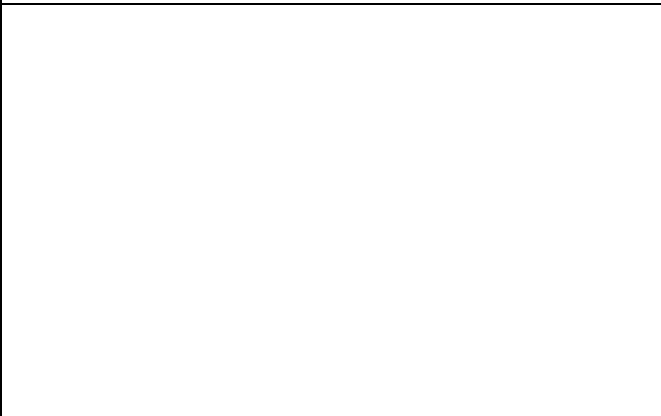

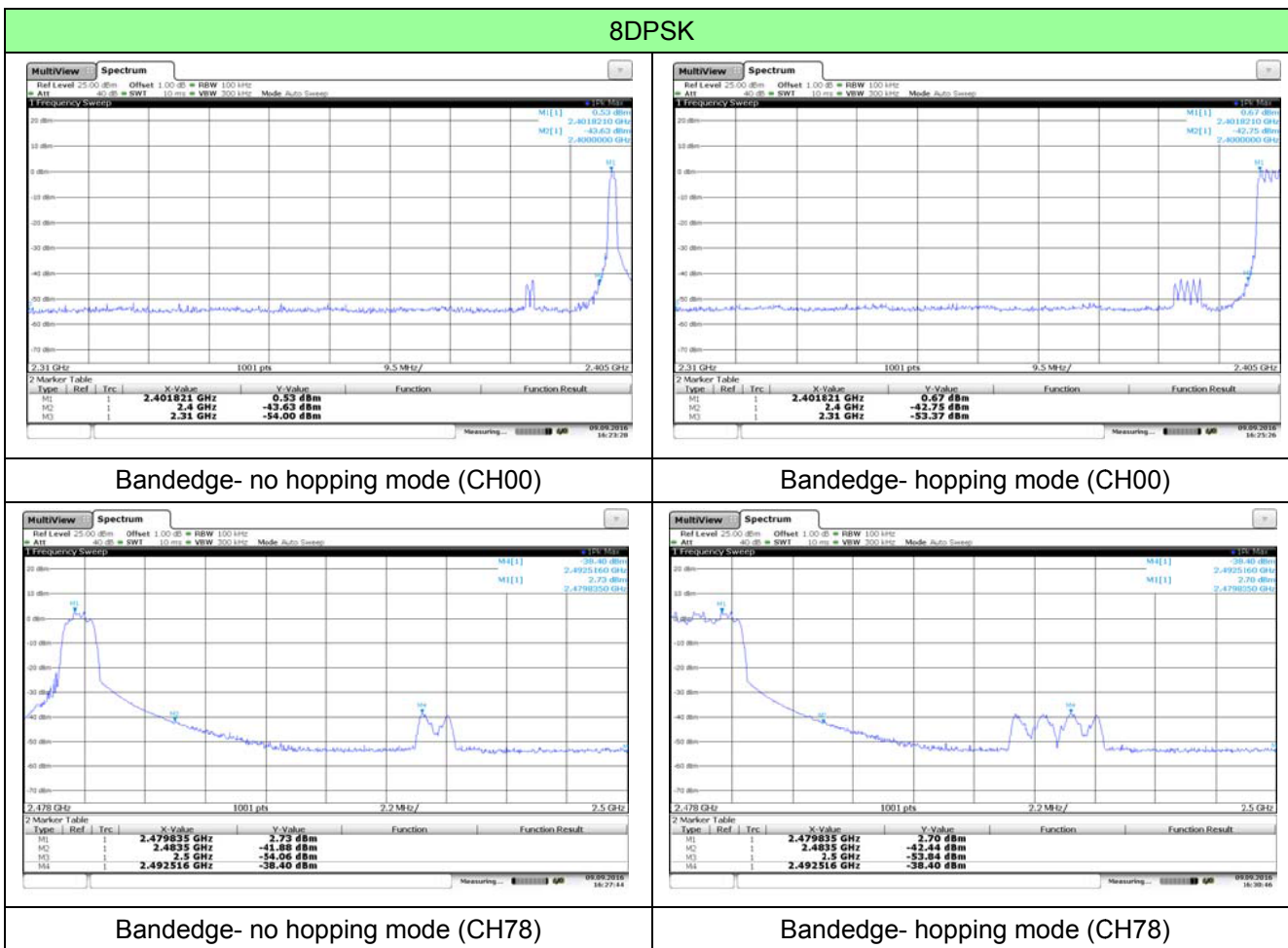

8DPSK Tx Spurious Emission

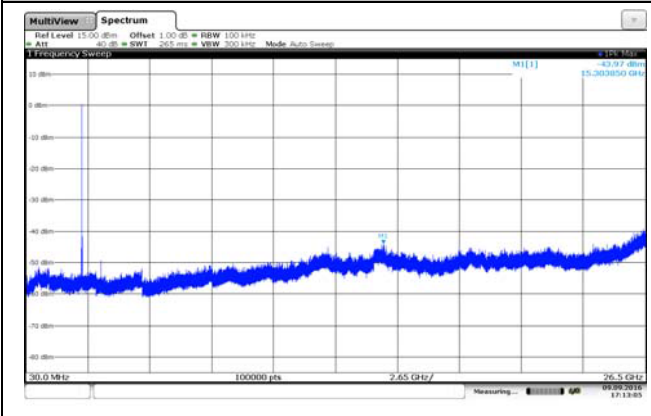

CH00

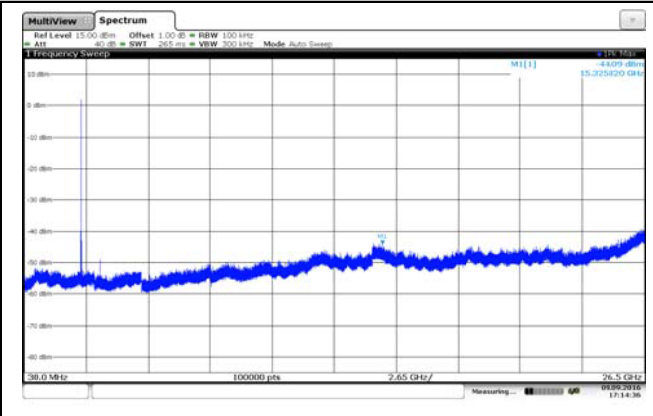

CH39

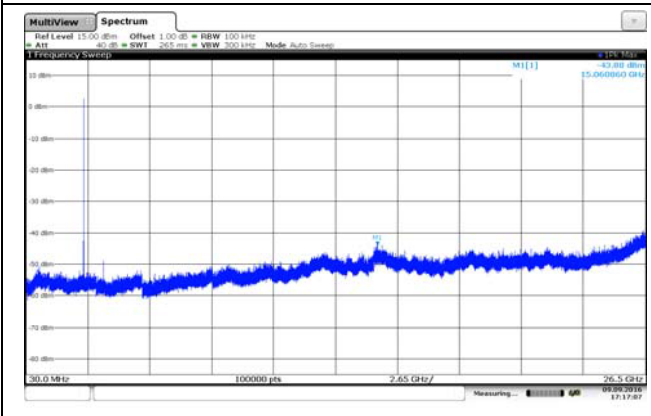

CH78

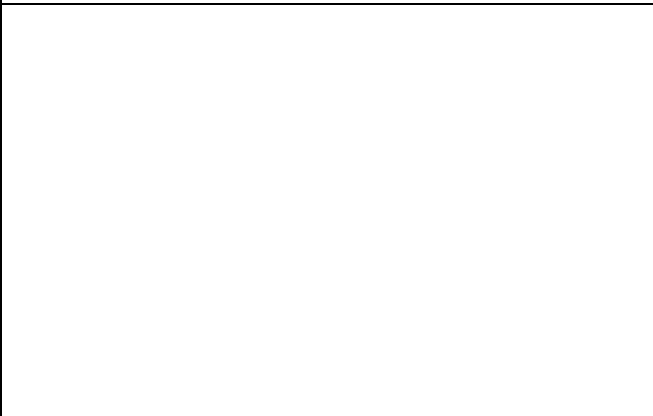

4.11. Spurious Emission (radiated)

LIMIT

FCC CFR Title 47 Part 15 Subpart C Section 15.209

Frequency	Limit (dBuV/m @3m)	Value
30MHz-88MHz	40.00	Quasi-peak
88MHz-216MHz	43.50	Quasi-peak
216MHz-960MHz	46.00	Quasi-peak
960MHz-1GHz	54.00	Quasi-peak
Above 1GHz	54.00	Average
	74.00	Peak

TEST CONFIGURATION

- ◆ Below 30MHz

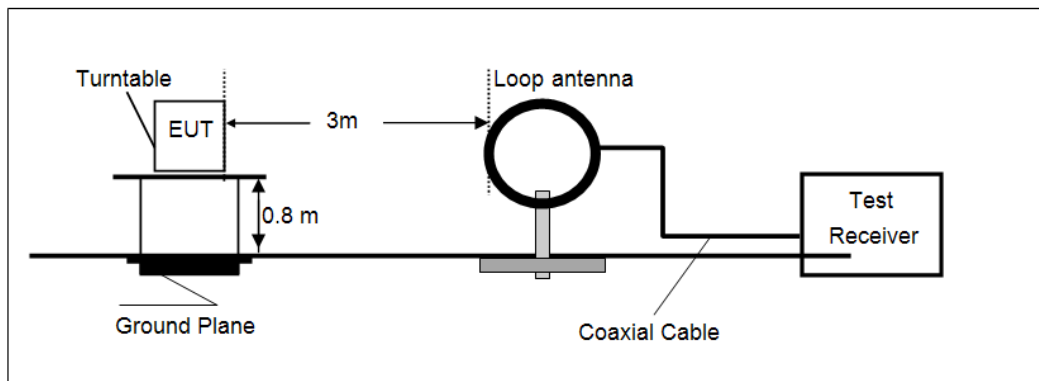

- ◆ 30MHz~1000MHz

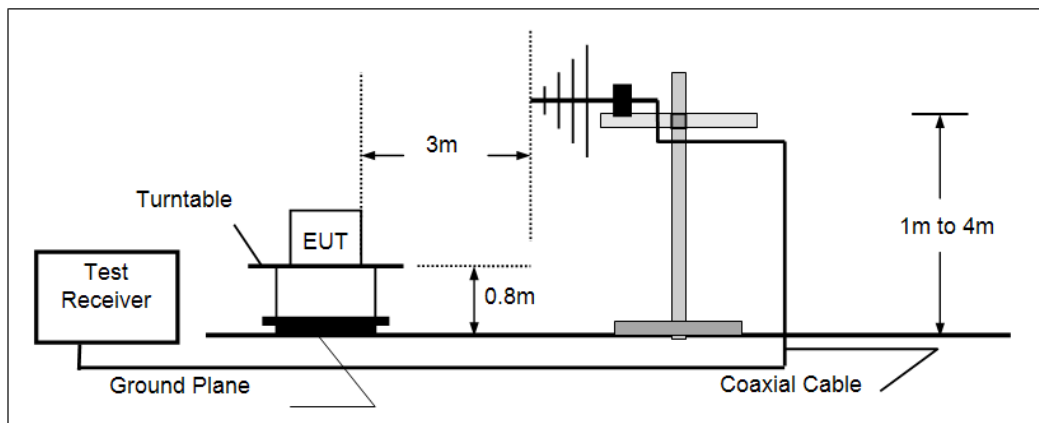

- ◆ Above 1GHz

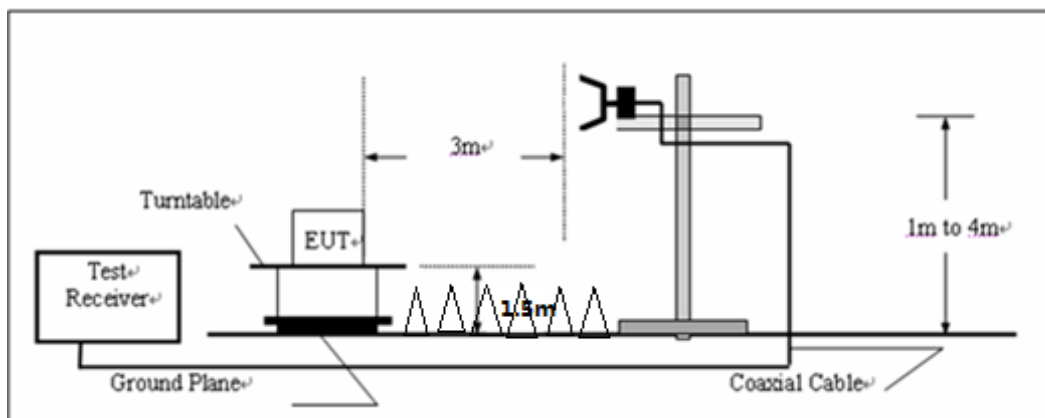

TEST PROCEDURE

1. The EUT was placed on the top of a rotating table 0.8 meter above ground for below 1GHz, and 1.5m for above 1GHz at a 3 meter camber. The table was rotated 360 degrees to determine the position of the highest radiation.
2. The EUT was set 3 meters away from the interference-receiving antenna, which was mounted on the top of a variable-height antenna tower.
3. The antenna height is varied from one meter to four meters above the ground to determine the maximum value of the field strength. Both horizontal and vertical polarizations of the antenna are set to make the measurement.
4. For each suspected emission, the EUT was arranged to its worst case and then the antenna was tuned to heights from 1 meter to 4 meters and the rotating table was turned from 0 degrees to 360 degrees to find the maximum reading.
5. Use the following spectrum analyzer settings
 - a) Span shall wide enough to fully capture the emission being measured;
 - b) Below 1GHz, RBW=120KHz, VBW=300KHz, Sweep=auto, Detector function=peak, Trace=max hold;
If the emission level of the EUT measured by the peak detector is 3 dB lower than the applicable limit, the peak emission level will be reported. Otherwise, the emission measurement will be repeated using the quasi-peak detector and reported.
 - c) Above 1GHz, RBW=1MHz, VBW=3MHz for Peak value
RBW=1MHz, VBW=10Hz for Average value.

TEST RESULTS

Noted:

Have pre-scan all modulation mode, found the GFSK modulation which it was worst case, so only the worst case's data on the test report.

Measurement data:

■ 9kHz ~ 30MHz

The low frequency, which started from 9 kHz to 30MHz, was pre-scanned and the result which was 20dB lower than the limit line per 15.31(o) was not reported.

■ 30MHz ~ 1GHz

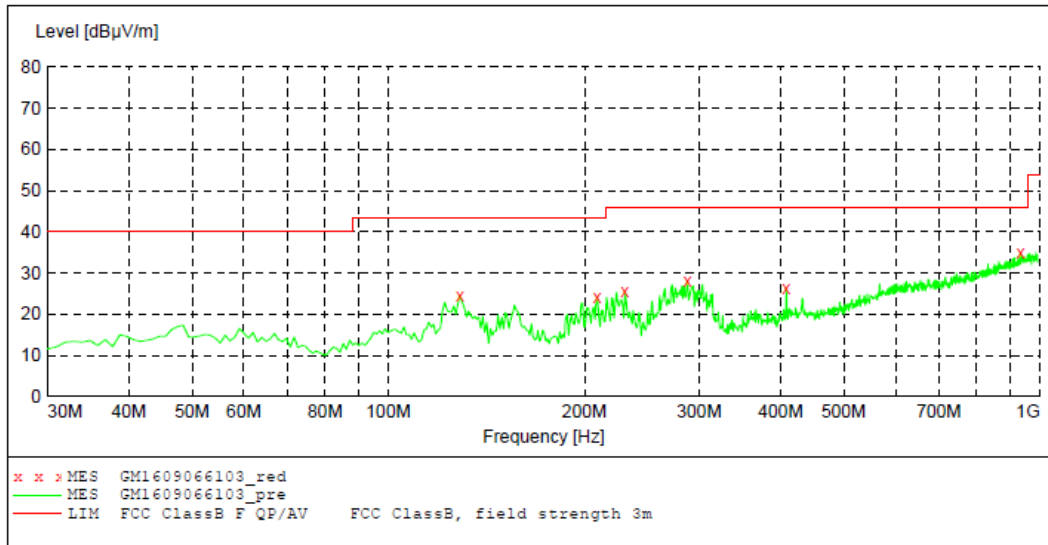

MEASUREMENT RESULT: "GM1609066103_red"

9/6/2016 7:52PM

Frequency MHz	Level dBµV/m	Transd dB	Limit dBµV/m	Margin dB	Det.	Height cm	Azimuth deg	Polarization
128.940000	24.50	-17.0	43.5	19.0	QP	300.0	330.00	HORIZONTAL
209.450000	24.10	-14.0	43.5	19.4	QP	300.0	122.00	HORIZONTAL
230.790000	25.50	-14.8	46.0	20.5	QP	100.0	121.00	HORIZONTAL
288.020000	28.00	-14.1	46.0	18.0	QP	100.0	274.00	HORIZONTAL
408.300000	26.30	-10.5	46.0	19.7	QP	100.0	176.00	HORIZONTAL
934.040000	34.80	3.4	46.0	11.2	QP	100.0	274.00	HORIZONTAL

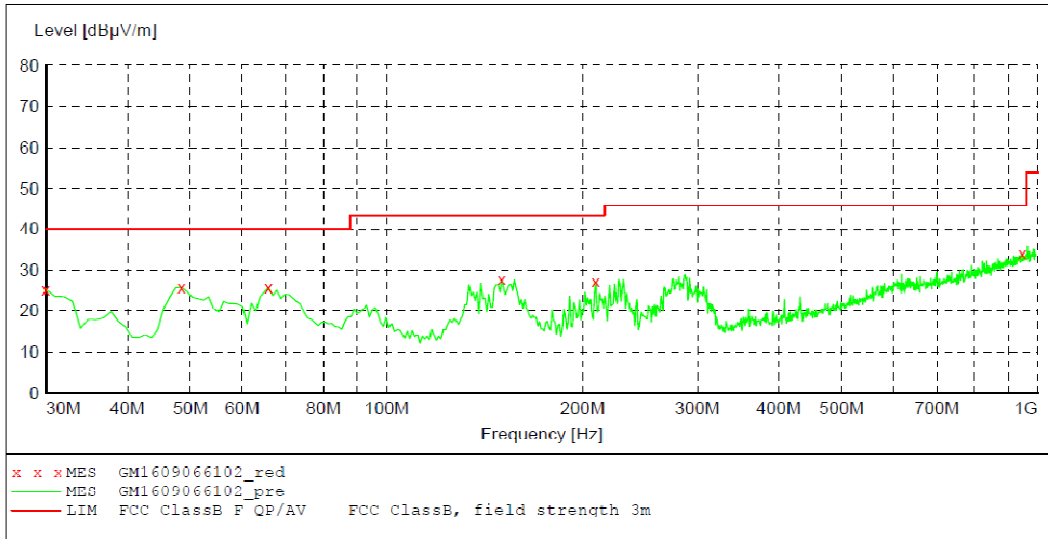

MEASUREMENT RESULT: "GM1609066102_red"

9/6/2016 7:49PM

Frequency MHz	Level dBµV/m	Transd dB	Limit dBµV/m	Margin dB	Det.	Height cm	Azimuth deg	Polarization
30.000000	25.20	-16.8	40.0	14.8	QP	100.0	6.00	VERTICAL
48.430000	25.70	-14.4	40.0	14.3	QP	100.0	76.00	VERTICAL
65.890000	25.70	-16.1	40.0	14.3	QP	100.0	22.00	VERTICAL
150.280000	27.60	-17.8	43.5	15.9	QP	100.0	148.00	VERTICAL
209.450000	27.20	-14.0	43.5	16.3	QP	100.0	63.00	VERTICAL
946.650000	33.90	3.6	46.0	12.1	QP	100.0	6.00	VERTICAL

Remark:Transd=Cable lose+ Antenna factor- Pre-amplifier;Margin=Limit -Level

■ Above 1GHz

CH00 for GFSK									
Frequency (MHz)	Read Level (dBuV)	Antenna Factor (dB/m)	Cable Loss (dB)	Preamp Factor (dB)	Level (dBuV/m)	Limit Line (dBuV/m)	Margin Limit (dB)	Polarization	Test value
4804.00	49.99	31.28	5.66	35.29	51.64	74.00	-22.36	Vertical	Peak
7206.00	34.81	36.22	6.87	35.15	42.75	74.00	-31.25	Vertical	
9608.00	34.76	37.85	8.80	35.55	45.86	74.00	-28.14	Vertical	
11264.26	*							Vertical	
4804.00	50.69	31.28	5.66	35.29	52.34	74.00	-21.66	Horizontal	
7206.00	33.71	36.22	6.87	35.15	41.65	74.00	-32.35	Horizontal	
9608.00	34.98	37.85	8.80	35.55	46.08	74.00	-27.92	Horizontal	
11264.26	*							Horizontal	
4804.00	41.93	31.28	5.66	35.29	43.58	54.00	-10.42	Vertical	Average
7206.00	28.53	36.22	6.87	35.15	36.47	54.00	-17.53	Vertical	
9608.00	29.15	37.85	8.80	35.55	40.25	54.00	-13.75	Vertical	
11264.26	*							Vertical	
4804.00	42.19	31.28	5.66	35.29	43.84	54.00	-10.16	Horizontal	
7206.00	28.64	36.22	6.87	35.15	36.58	54.00	-17.42	Horizontal	
9608.00	29.24	37.85	8.80	35.55	40.34	54.00	-13.66	Horizontal	
11264.26	*							Horizontal	

CH39 for GFSK									
Frequency (MHz)	Read Level (dBuV)	Antenna Factor (dB/m)	Cable Loss (dB)	Preamp Factor (dB)	Level (dBuV/m)	Limit Line (dBuV/m)	Margin Limit (dB)	Polarization	Test value
4882.00	51.16	30.88	5.70	35.27	52.47	74.00	-21.53	Vertical	Peak
7323.00	34.75	35.82	6.91	35.13	42.35	74.00	-31.65	Vertical	
9764.00	35.32	37.45	8.84	35.53	46.08	74.00	-27.92	Vertical	
12247.62	*							Vertical	
4882.00	52.14	30.88	5.70	35.27	53.45	74.00	-20.55	Horizontal	
7323.00	33.85	35.82	6.91	35.13	41.45	74.00	-32.55	Horizontal	
9764.00	36.09	37.45	8.84	35.53	46.85	74.00	-27.15	Horizontal	
12247.62	*							Horizontal	
4882.00	42.53	30.88	5.70	35.27	43.84	54.00	-10.16	Vertical	Average
7323.00	29.15	35.82	6.91	35.13	36.75	54.00	-17.25	Vertical	
9764.00	29.90	37.45	8.84	35.53	40.66	54.00	-13.34	Vertical	
12247.62	*							Vertical	
4882.00	42.94	30.88	5.70	35.27	44.25	54.00	-9.75	Horizontal	
7323.00	29.14	35.82	6.91	35.13	36.74	54.00	-17.26	Horizontal	
9764.00	29.76	37.45	8.84	35.53	40.52	54.00	-13.48	Horizontal	
12247.62	*							Horizontal	

Remark:

1. Final Level = Receiver Read level + Antenna Factor + Cable Loss – Pre-amplifier Factor
2. “*”, means this data is the too weak instrument of signal is unable to test.
3. The emission levels of other frequencies are very lower than the limit and not show in test report.

CH78 for GFSK									
Frequency (MHz)	Read Level (dBuV)	Antenna Factor (dB/m)	Cable Loss (dB)	Preamp Factor (dB)	Level (dBuV/m)	Limit Line (dBuV/m)	Margin Limit (dB)	Polarization	Test value
4960.00	52.46	30.98	5.73	35.32	53.85	74.00	-20.15	Vertical	Peak
7440.00	35.18	35.92	6.94	35.18	42.86	74.00	-31.14	Vertical	
9920.00	35.10	37.55	8.87	35.58	45.94	74.00	-28.06	Vertical	
13214.26	*							Vertical	
4960.00	52.49	30.98	5.73	35.32	53.88	74.00	-20.12	Horizontal	
7440.00	33.97	35.92	6.94	35.18	41.65	74.00	-32.35	Horizontal	
9920.00	35.54	37.55	8.87	35.58	46.38	74.00	-27.62	Horizontal	
13214.26	*							Horizontal	
4960.00	43.13	30.98	5.73	35.32	44.52	54.00	-9.48	Vertical	Average
7440.00	29.16	35.92	6.94	35.18	36.84	54.00	-17.16	Vertical	
9920.00	29.41	37.55	8.87	35.58	40.25	54.00	-13.75	Vertical	
13214.26	*							Vertical	
4960.00	43.48	30.98	5.73	35.32	44.87	54.00	-9.13	Horizontal	
7440.00	29.30	35.92	6.94	35.18	36.98	54.00	-17.02	Horizontal	
9920.00	30.02	37.55	8.87	35.58	40.86	54.00	-13.14	Horizontal	
13214.26	*							Horizontal	

Remark:

1. Final Level = Receiver Read level + Antenna Factor + Cable Loss – Pre-amplifier Factor
2. “*”, means this data is too weak instrument of signal is unable to test.
3. The emission levels of other frequencies are very lower than the limit and not show in test report.

5. Test Setup Photos of the EUT

Radiated Emission

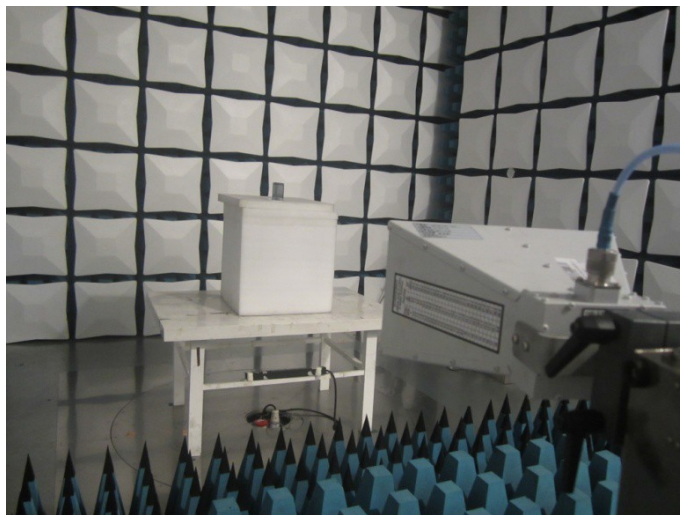
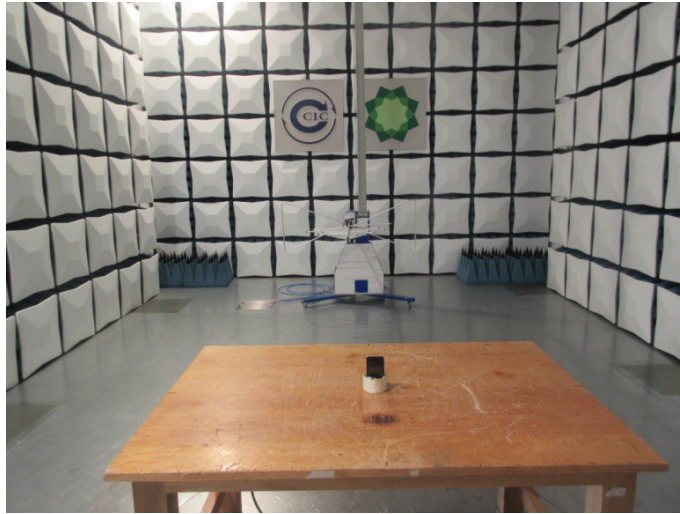

Conducted Emission (AC Mains)



6. External and Internal Photos of the EUT

Reference to Test Report TRE1609000801

.....End of Report.....