

RF TEST REPORT



Report No.: 15050057-FCC-R1

Supersede Report No.: N/A

Applicant	b mobile HK Limited	
Product Name	Mobile phone	
Model No.	AX605	
Serial No.	N/A	
Test Standard	FCC Part 22(H):2014 ;FCC Part 24(E):2014; ANSI/TIA603 D: 2010	
Test Date	December 12 to December 31, 2015	
Issue Date	December 31, 2015	
Test Result	<input checked="" type="checkbox"/> Pass <input type="checkbox"/> Fail	
Equipment complied with the specification	<input checked="" type="checkbox"/>	
Equipment did not comply with the specification	<input type="checkbox"/>	
<i>Winnie Zhang</i>	<i>David Huang</i>	
Winnie Zhang Test Engineer	David Huang Checked By	
This test report may be reproduced in full only Test result presented in this test report is applicable to the tested sample only		

Issued by:

SIEMIC (SHENZHEN-CHINA) LABORATORIES

Zone A, Floor 1, Building 2 Wan Ye Long Technology Park

South Side of Zhoushi Road, Bao' an District, Shenzhen, Guangdong China 518108

Phone: +86 0755 2601 4629801 Email: China@siemic.com.cn

Laboratories Introduction

SIEMIC, headquartered in the heart of Silicon Valley, with superior facilities in US and Asia, is one of the leading independent testing and certification facilities providing customers with one-stop shop services for Compliance Testing and Global Certifications.



In addition to testing and certification, SIEMIC provides initial design reviews and compliance management throughout a project. Our extensive experience with China, Asia Pacific, North America, European, and International compliance requirements, assures the fastest, most cost effective way to attain regulatory compliance for the global markets.

Accreditations for Conformity Assessment

Country/Region	Scope
USA	EMC, RF/Wireless, SAR, Telecom
Canada	EMC, RF/Wireless, SAR, Telecom
Taiwan	EMC, RF, Telecom, SAR, Safety
Hong Kong	RF/Wireless, SAR, Telecom
Australia	EMC, RF, Telecom, SAR, Safety
Korea	EMI, EMS, RF, SAR, Telecom, Safety
Japan	EMI, RF/Wireless, SAR, Telecom
Singapore	EMC, RF, SAR, Telecom
Europe	EMC, RF, SAR, Telecom, Safety

Test Report	15050057-FCC-R1
Page	3 of 53

This page has been left blank intentionally.

CONTENTS

1. REPORT REVISION HISTORY	5
2. CUSTOMER INFORMATION	5
3. TEST SITE INFORMATION.....	5
4. EQUIPMENT UNDER TEST (EUT) INFORMATION.....	6
5. TEST SUMMARY	8
6. MEASUREMENTS, EXAMINATION AND DERIVED RESULTS	9
6.1 RF EXPOSURE (SAR).....	9
6.2 RF OUTPUT POWER.....	10
6.3 PEAK-AVERAGE RATIO.....	18
6.4 OCCUPIED BANDWIDTH.....	20
6.5 SPURIOUS EMISSIONS AT ANTENNA TERMINALS	24
6.6 SPURIOUS RADIATED EMISSIONS.....	29
6.7 BAND EDGE.....	35
6.8 FREQUENCY STABILITY	39
ANNEX A. TEST INSTRUMENT.....	43
ANNEX B. EUT AND TEST SETUP PHOTOGRAPHS.....	44
ANNEX C. TEST SETUP AND SUPPORTING EQUIPMENT.....	49
ANNEX C.II. EUT OPERATING CONKITIONS.....	51
ANNEX D. USER MANUAL / BLOCK DIAGRAM / SCHEMATICS / PARTLIST.....	52
ANNEX E. DECLARATION OF SIMILARITY.....	53

1. Report Revision History

Report No.	Report Version	Description	Issue Date
15050057-FCC-R1	NONE	Original	December 31, 2015

2. Customer information

Applicant Name	b mobile HK Limited
Applicant Add	Flat 18; 14/F Block 1; Golden Industrial Building;16-26 Kwai Tak Street; Kwai Chung;New Territories; Hong Kong
Manufacturer	b mobile HK Limited
Manufacturer Add	Flat 18; 14/F Block 1; Golden Industrial Building;16-26 Kwai Tak Street; Kwai Chung;New Territories; Hong Kong

3. Test site information

Lab performing tests	SIEMIC (Shenzhen-China) LABORATORIES
Lab Address	Zone A, Floor 1, Building 2 Wan Ye Long Technology Park South Side of Zhoushi Road, Bao' an District, Shenzhen, Guangdong China 518108
FCC Test Site No.	718246
IC Test Site No.	4842E-1
Test Software	Radiated Emission Program-To Shenzhen v2.0

4. Equipment under Test (EUT) Information

Description of EUT:	Mobile phone
Main Model:	AX605
Serial Model:	N/A
Date EUT received:	December 11, 2015
Test Date(s):	December 12 to December 31, 2015
Equipment Category :	PCE
Antenna Gain:	GSM850: -1dBi PCS1900: 0dBi UMTS-FDD Band V: 0dBi UMTS-FDD Band II: 0dBi Bluetooth: 0.5dBi WIFI: 0.5dBi GPS: -2dBi
Type of Modulation:	GSM / GPRS: GMSK EGPRS: GMSK, 8PSK UMTS-FDD: QPSK, 16QAM 802.11b/g/n: DSSS, OFDM Bluetooth: GFSK, π /4DQPSK, 8DPSK GPS: BPSK GSM850 TX: 824.2 ~ 848.8 MHz; RX: 869.2 ~ 893.8 MHz PCS1900 TX: 1850.2 ~ 1909.8 MHz; RX: 1930.2 ~ 1989.8 MHz UMTS-FDD Band V TX: 826.4 ~ 846.6 MHz; RX: 871.4 ~ 891.6 MHz UMTS-FDD Band II TX: 1852.4 ~ 1907.6 MHz; RX: 1932.4 ~ 1987.6 MHz
RF Operating Frequency (ies):	WIFI: 802.11b/g/n(20M): 2412-2472 MHz WIFI: 802.11n(40M): 2422-2462 MHz Bluetooth: 2402-2480 MHz GPS RX: 1575.42 MHz

	GSM850: 33.43dBm
Maximum Conducted	PCS1900: 31.24 dBm
AV Power to Antenna:	UMTS-FDD Band V : 23.81 dBm
	UMTS-FDD Band II : 23.34 dBm
ERP/EIRP:	GSM850: 30.02 dBm / ERP
	PCS1900: 30.77 dBm / EIRP
	UMTS-FDD Band V : 21.54 dBm / ERP
	UMTS-FDD Band II : 23.31 dBm / EIRP
Number of Channels:	GSM 850: 124CH
	PCS1900: 299CH
	UMTS-FDD Band V : 102CH
	UMTS-FDD Band II : 277CH
	WIFI :802.11b/g/n(20M): 13CH
	WIFI :802.11n(40M): 9CH
	Bluetooth: 79CH
	GPS:1CH
Port:	Power Port, Earphone Port, USB Port
Input Power:	Battery:
	Model:A3506
	Standard Voltage:DC3.7V
	Rated Capacity:1300mAh,4.81Wh
	Adapter:
	Model:N/A
	Input: AC100-240V; 50/60Hz; 0.15A
	Output: DC 5.0V,500mA
Trade Name :	Bmobile
GPRS/EGPRS Multi-slot class	8/10/12
FCC ID:	ZSW-30-022

5. Test Summary

The product was tested in accordance with the following specifications.

All testing has been performed according to below product classification:

FCC Rules	Description of Test	Result
§ 1.1307; § 2.1093	RF Exposure (SAR)	Compliance
§2.1046; § 22.913(a); § 24.232(c); § 27.50(c.10) ; § 27.50(d.4)	RF Output Power	Compliance
§ 24.232 (d) ; § 27.50(d)	Peak-Average Ratio	Compliance
§ 2.1049; § 22.905; § 22.917; § 24.238; § 27.53(a.5)	99% & -26 dB Occupied Bandwidth	Compliance
§ 2.1051; § 22.917(a); § 24.238(a); § 27.53(h)	Spurious Emissions at Antenna Terminal	Compliance
§ 2.1053; § 22.917(a); § 24.238(a); § 27.53(h)	Field Strength of Spurious Radiation	Compliance
§ 22.917(a); § 24.238(a); § 27.53(h)	Out of band emission, Band Edge	Compliance
§ 2.1055; § 22.355; § 24.235; § 27.5(h); § 27.54	Frequency stability vs. temperature Frequency stability vs. voltage	Compliance

Note: Testing was performed by configuring EUT to maximum output power status, the declared output power class for different

Measurement Uncertainty

Emissions		
Test Item	Description	Uncertainty
Band Edge and Radiated Spurious Emissions	Confidence level of approximately 95% (in the case where distributions are normal), with a coverage factor of 2 (for EUTs < 0.5m X 0.5m X 0.5m)	+5.6dB/-4.5dB
-	-	-

6. MEASUREMENTS, EXAMINATION AND DERIVED RESULTS

6.1 RF Exposure (SAR)

Test Result: Pass

The EUT is a portable device, thus requires SAR evaluation;

Please refer to RF Exposure Evaluation Report: 15050057-FCC-H.

6.2 RF Output Power

Temperature	22°C
Relative Humidity	58%
Atmospheric Pressure	1025mbar
Test date :	December 25, 2015
Tested By :	Winnie Zhang

Requirement(s):

Spec	Item	Requirement	Applicable
§22.913 (a)	a)	ERP:38.45dBm	<input checked="" type="checkbox"/>
§24.232 (c)	b)	EIRP:33dBm	<input checked="" type="checkbox"/>
§27.50 (c)	c)	EIRP: 30dBm	<input checked="" type="checkbox"/>

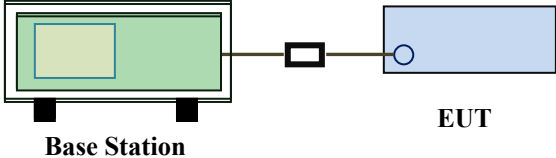
Test Setup	 <p style="text-align: center;">Base Station EUT</p>
------------	--

Test Procedure	<p>For Conducted Power:</p> <ul style="list-style-type: none"> - The transmitter output port was connected to base station. - Set EUT at maximum power through base station. - Select lowest, middle, and highest channels for each band and different test mode. <p>For ERP/EIRP:</p> <ul style="list-style-type: none"> - The transmitter was placed on a wooden turntable, and it was transmitting into a non-radiating load which was also placed on the turntable. - The measurement antenna was placed at a distance of 3 meters from the EUT. During the tests, the antenna height and polarization as well as EUT azimuth were varied in order to identify the maximum level of emissions from the EUT. The test was performed by placing the EUT on 3-orthogonal axis. - The frequency range up to tenth harmonic of the fundamental frequency was investigated. - Remove the EUT and replace it with substitution antenna. A signal
----------------	--

Test Report	15050057-FCC-R1
Page	11 of 53

	<p>generator was connected to the substitution antenna by a non-radiating cable. The absolute levels of the spurious emissions were measured by the substitution.</p> <ul style="list-style-type: none"> - Spurious emissions in dB = 10 log (TX power in Watts/0.001) – the absolute level - Spurious attenuation limit in dB = 43 + 10 Log10 (power out in Watts).
Remark	
Result	<input checked="" type="checkbox"/> Pass <input type="checkbox"/> Fail

Test Data Yes N/A

Test Plot Yes (See below) N/A

Conducted Power

GSM Mode:

Burst Average Power (dBm);								
Band	GSM850				PCS1900			
Channel	128	190	251	Tune up Power tolerant	512	661	810	Tune up Power tolerant
Frequency (MHz)	824.2	836.6	848.8	/	1850.2	1880	1909.8	/
GSM Voice (1 uplink),GMSK	33.41	33.43	33.39	33±1	31.03	31.02	31.24	31±1
GPRS Multi-Slot Class 8 (1 uplink),GMSK	33.29	33.32	33.31	33±1	31.01	31.00	31.23	31±1
GPRS Multi-Slot Class 10 (2 uplink) GMSK	32.54	32.53	32.52	32±1	29.97	30.01	30.46	30±1
GPRS Multi-Slot Class 12 (4 uplink) GMSK	29.58	29.57	29.53	29±1	27.09	27.25	27.73	27±1
EGPRS Multi-Slot Class 8 (1 uplink) GMSK MCS1	33.28	33.31	33.29	33±1	30.99	30.97	31.19	31±1
EGPRS Multi-Slot Class 10 (2 uplink) GMSK MCS1	32.53	32.51	32.49	32±1	29.98	29.96	30.45	30±1
EGPRS Multi-Slot Class 12 (4 uplink) GMSK MCS1	29.43	29.47	29.39	29±1	27.03	27.16	27.69	27±1
EGPRS Multi-Slot Class 8 (1 uplink) 8PSK MCS5	26.25	26.27	25.94	26±1	26.47	26.54	26.71	26±1
EGPRS Multi-Slot Class 10 (2 uplink) 8PSK MCS5	25.16	24.89	24.8	24±1	25.39	25.43	25.65	25±1
EGPRS Multi-Slot Class 12 (4 uplink) 8PSK MCS5	24.93	24.13	24.07	24±1	23.47	23.51	23.49	23±1

Test Report	15050057-FCC-R1
Page	13 of 53

Remark :

GPRS, CS1 coding scheme.

EGPRS, MCS1 coding scheme.

EGPRS, MCS5 coding scheme.

Multi-Slot Class 8 , Support Max 4 downlink, 1 uplink , 5 working link

Multi-Slot Class 10 , Support Max 4 downlink, 2 uplink , 5 working link

Multi-Slot Class 12 , Support Max 4 downlink, 4 uplink , 5 working link

Note: Since GSM mode has higher power, so the test items below were not performed to GPRS and EGPRS mode.

UMTS Mode:

UMTS-FDD Band V

Band/ Time Slot configuration	Channel	Frequency	Average power (dBm)	Tune up Power tolerant
RMC 12.2kbps	4132	826.4	23.69	23±1
	4175	835	23.81	23±1
	4233	846.6	23.66	23±1
HSDPA Subtest1	4132	826.4	22.46	22±1
	4175	835	22.58	22±1
	4233	846.6	22.45	22±1
HSDPA Subtest2	4132	826.4	22.43	22±1
	4175	835	22.45	22±1
	4233	846.6	22.46	22±1
HSDPA Subtest3	4132	826.4	22.35	22±1
	4175	835	22.48	22±1
	4233	846.6	22.46	22±1
HSDPA Subtest4	4132	826.4	22.57	22±1
	4175	835	22.48	22±1
	4233	846.6	22.41	22±1
HSUPA Subtest1	4132	826.4	22.46	22±1
	4175	835	22.49	22±1
	4233	846.6	22.42	22±1
HSUPA Subtest2	4132	826.4	22.45	22±1
	4175	835	22.49	22±1
	4233	846.6	22.42	22±1
HSUPA Subtest3	4132	826.4	22.48	22±1
	4175	835	22.53	22±1
	4233	846.6	22.47	22±1
HSUPA Subtest4	4132	826.4	22.45	22±1
	4175	835	22.55	22±1
	4233	846.6	22.45	22±1
HSUPA Subtest5	4132	826.4	22.43	22±1
	4175	835	22.59	22±1
	4233	846.6	22.48	22±1

UMTS-FDD Band II

Band/ Time Slot configuration	Channel	Frequency	Average power (dBm)	Tune up Power tolerant
RMC 12.2kbps	9262	1852.4	23.21	23±1
	9400	1880	23.34	23±1
	9538	1907.6	23.23	23±1
HSDPA Subtest1	9262	1852.4	22.43	22±1
	9400	1880	22.53	22±1
	9538	1907.6	22.46	22±1
HSDPA Subtest2	9262	1852.4	22.56	22±1
	9400	1880	22.51	22±1
	9538	1907.6	22.48	22±1
HSDPA Subtest3	9262	1852.4	22.54	22±1
	9400	1880	22.43	22±1
	9538	1907.6	22.47	22±1
HSDPA Subtest4	9262	1852.4	22.46	22±1
	9400	1880	22.49	22±1
	9538	1907.6	22.43	22±1
HSUPA Subtest1	9262	1852.4	22.54	22±1
	9400	1880	22.44	22±1
	9538	1907.6	22.46	22±1
HSUPA Subtest2	9262	1852.4	22.43	22±1
	9400	1880	22.48	22±1
	9538	1907.6	22.49	22±1
HSUPA Subtest3	9262	1852.4	22.46	22±1
	9400	1880	22.53	22±1
	9538	1907.6	22.46	22±1
HSUPA Subtest4	9262	1852.4	22.55	22±1
	9400	1880	22.43	22±1
	9538	1907.6	22.42	22±1
HSUPA Subtest5	9262	1852.4	22.41	22±1
	9400	1880	22.51	22±1
	9538	1907.6	22.42	22±1

ERP & EIRP

ERP for Cellular Band (Part 22H)

Frequency (MHz)	Substituted level (dBm)	Antenna Polarization	Antenna Gain correction (dBi)	Cable Loss (dB)	Absolute Level (dBm)	Limit (dBm)
824.2	23.68	V	6.8	0.53	29.95	38.45
824.2	22.13	H	6.8	0.53	28.40	38.45
836.6	23.61	V	6.8	0.53	29.88	38.45
836.6	22.05	H	6.8	0.53	28.32	38.45
848.8	23.65	V	6.9	0.53	30.02	38.45
848.8	22.09	H	6.9	0.53	28.46	38.45

EIRP for PCS Band (Part 24E)

Frequency (MHz)	Substituted level (dBm)	Antenna Polarization	Antenna Gain correction (dBi)	Cable Loss (dB)	Absolute Level (dBm)	Limit (dBm)
1850.2	23.74	V	7.88	0.85	30.77	33
1850.2	22.18	H	7.88	0.85	29.21	33
1880	23.67	V	7.88	0.85	30.70	33
1880	22.11	H	7.88	0.85	29.14	33
1909.8	23.62	V	7.86	0.85	30.63	33
1909.8	22.04	H	7.86	0.85	29.05	33

ERP for UMTS-FDD Band V (Part 22H)

Frequency (MHz)	Substituted level (dBm)	Antenna Polarization	Antenna Gain correction (dBi)	Cable Loss (dB)	Absolute Level (dBm)	Limit (dBm)
826.4	15.18	V	6.8	0.53	21.45	38.45
826.4	13.55	H	6.8	0.53	19.82	38.45
835	15.23	V	6.8	0.53	21.50	38.45
835	13.61	H	6.8	0.53	19.88	38.45
846.6	15.17	V	6.9	0.53	21.54	38.45
846.6	13.52	H	6.9	0.53	19.89	38.45

EIRP for UMTS-FDD Band II (Part 24E)

Frequency (MHz)	Substituted level (dBm)	Antenna Polarization	Antenna Gain correction (dBi)	Cable Loss (dB)	Absolute Level (dBm)	Limit (dBm)
1852.4	16.21	V	7.88	0.85	23.24	33
1852.4	14.76	H	7.88	0.85	21.79	33
1880	16.28	V	7.88	0.85	23.31	33
1880	14.82	H	7.88	0.85	21.85	33
1907.6	16.17	V	7.86	0.85	23.18	33
1907.6	14.71	H	7.86	0.85	21.72	33

6.3 Peak-Average Ratio

Temperature	22°C
Relative Humidity	58%
Atmospheric Pressure	1025mbar
Test date :	December 25, 2015
Tested By :	Winnie Zhang

Requirement(s):

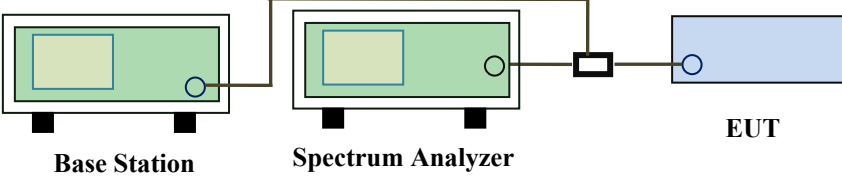
Spec	Item	Requirement	Applicable
§24.232(d) § 27.50(d)	a)	The peak-to-average ratio (PAR) of the transmission may not exceed 13 dB.	<input checked="" type="checkbox"/>
Test Setup	 <p>The diagram shows a Base Station (green box) connected to a Spectrum Analyzer (green box), which is then connected to an EUT (blue box). The Spectrum Analyzer is connected to the EUT via a small black box, likely a coupler or antenna.</p>		
Test Procedure	<p>According with KDB 971168</p> <ol style="list-style-type: none"> 1. The signal analyzer' s CCDF measurement profile is enabled 2. Frequency = carrier center frequency 3. Measurement BW > Emission bandwidth of signal 4. The signal analyzer was set to collect one million samples to generate the CCDF curve 5. The measurement interval was set depending on the type of signal analyzed. For continuous signals (>98% duty cycle), the measurement interval was set to 1ms. For burst transmissions, the spectrum analyzer is set to use an internal " RF Burst" trigger that is synced with an incoming pulse and the measurement interval is set to less than the duration of the " on time" of one burst to ensure that energy is only captured during a time in which the transmitter is operating at maximum power 		
Remark			
Result	<input checked="" type="checkbox"/> Pass <input type="checkbox"/> Fail		

Test Data Yes N/A

Test Plot Yes (See below) N/A

GSM 1900 PK-AV POWER(PART 24E)

Frequency (MHz)	Conducted power(dBm)		Peak-Average Ratio(PAR)
	Peak	Average	
1850.2	31.03	30.53	0.5
1880	31.02	30.62	0.4
1909.8	31.24	30.57	0.67

UMTS-FDD BandII PK-AV POWER(PART 24E)

Frequency (MHz)	Conducted power(dBm)		Peak-Average Ratio(PAR)
	Peak	Average	
1852.4	26.51	23.21	3.3
1880	26.68	23.34	3.34
1907.6	26.49	23.23	3.26

6.4 Occupied Bandwidth

Temperature	25°C
Relative Humidity	57%
Atmospheric Pressure	1024mbar
Test date :	December 24, 2015
Tested By :	Winnie Zhang

Requirement(s):

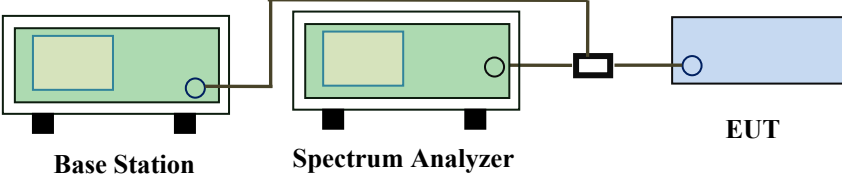
Spec	Item	Requirement	Applicable
§2.1049, §22.917, §22.905 §24.238 §27.53(a)	a)	99% Occupied Bandwidth(kHz)	<input checked="" type="checkbox"/>
	b)	26 dB Bandwidth(kHz)	<input checked="" type="checkbox"/>
Test Setup	 <p style="text-align: center;">Base Station Spectrum Analyzer EUT</p>		
Test Procedure	<ul style="list-style-type: none"> - The EUT was connected to Spectrum Analyzer and Base Station via power divider. - The 99% and 26 dB occupied bandwidth (BW) of the middle channel for the highest RF powers. 		
Remark			
Result	<input checked="" type="checkbox"/> Pass <input type="checkbox"/> Fail		

Test Data Yes N/A

Test Plot Yes (See below) N/A

Cellular Band (Part 22H) result

Channel	Frequency (MHz)	99% Occupied Bandwidth (kHz)	26 dB Bandwidth (kHz)
128	824.2	297.86	391.1
190	836.6	298.05	392.6
251	848.8	300.64	396.8

PCS Band (Part 24E) result

Channel	Frequency (MHz)	99% Occupied Bandwidth (kHz)	26 dB Bandwidth (kHz)
512	1850.2	281.65	354.3
661	1880.0	284.33	363.8
810	1909.8	282.59	387.8

UMTS-FDD Band V (Part 22H)

Channel	Frequency (MHz)	99% Occupied Bandwidth (MHz)	26 dB Bandwidth (MHz)
4132	826.4	4.3846	6.883
4175	835.0	4.4269	6.966
4233	846.6	4.3975	6.890

UMTS-FDD Band II (Part 24E)

Channel	Frequency (MHz)	99% Occupied Bandwidth (MHz)	26 dB Bandwidth (MHz)
9262	1852.4	4.3618	4.865
9400	1880.0	4.3359	4.861
9538	1907.6	4.3290	4.803

Test Plots

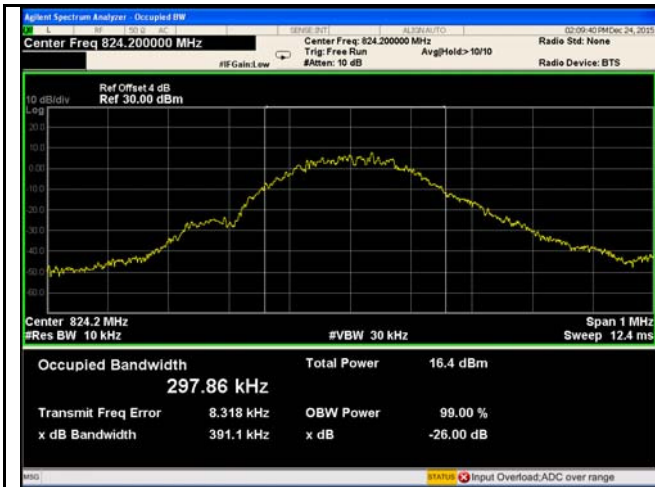

GSM 850 BW - Low CH 824.2MHz

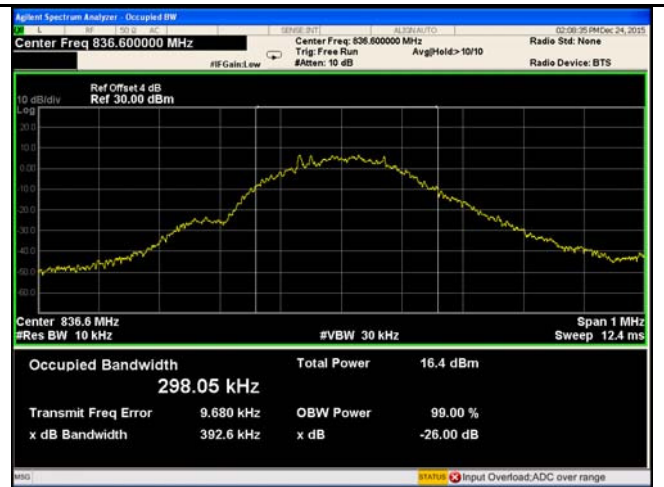

GSM 850 BW - Mid CH 836.6MHz



GSM 850 BW - High CH 848.8MHz



PCS 1900 BW - Low CH 1850.2MHz

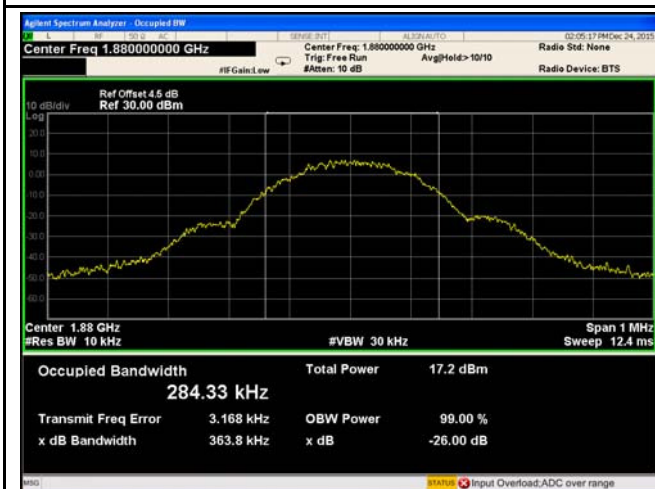

PCS 1900 BW - Mid CH 1880MHz



PCS 1900 BW - High CH 1909.8MHz

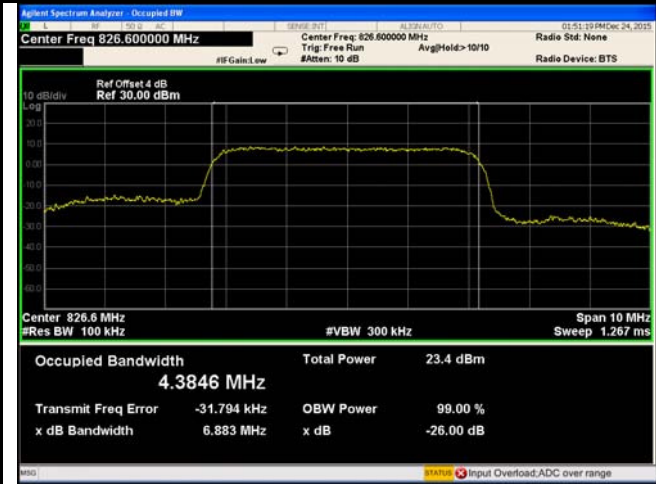

Band V BW - Low CH 826.6 MHz

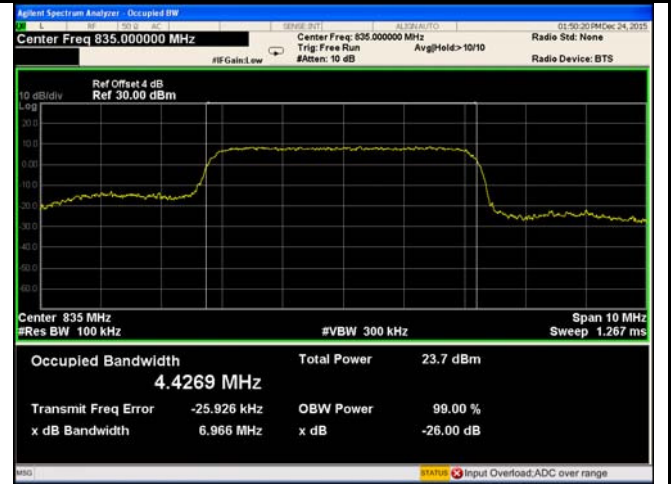

Band V BW - Mid CH 835.0 MHz

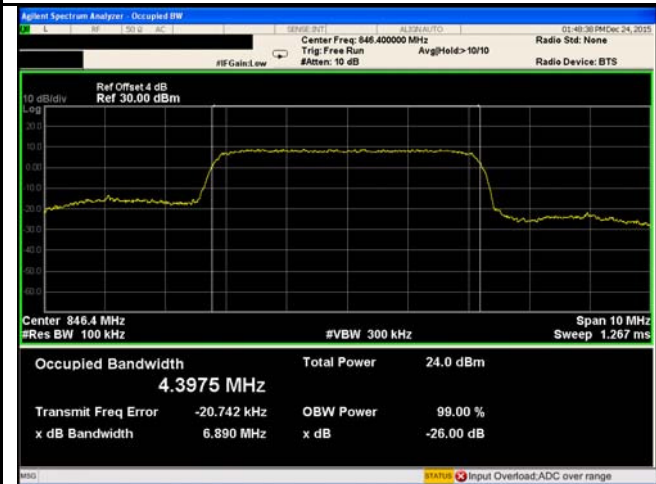

Band V BW - High CH 846.4 MHz

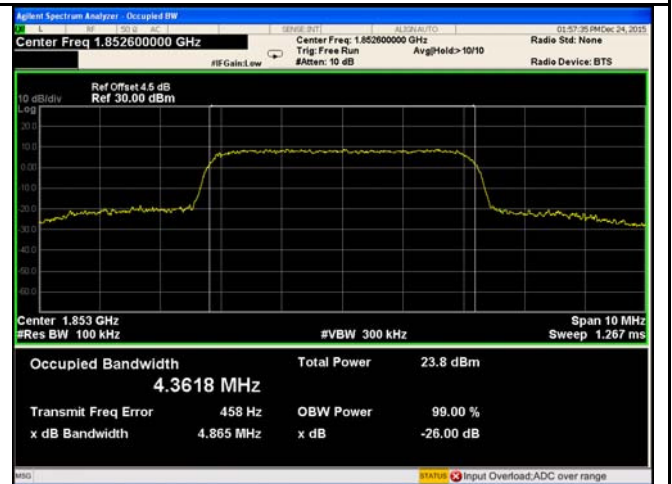

Band II BW - Low CH 1852.4 MHz

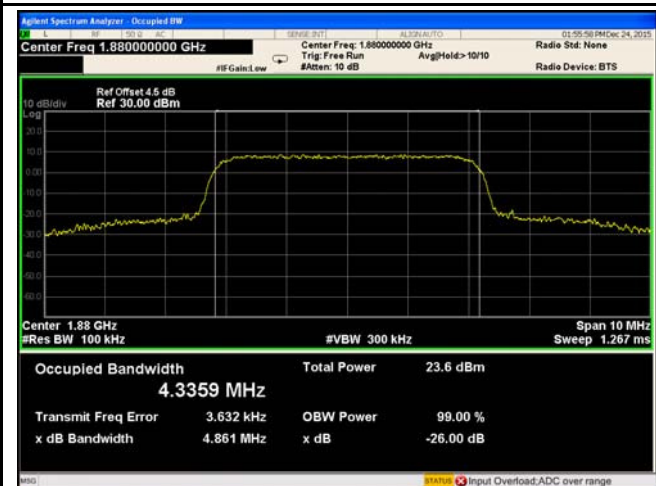

Band II BW - Mid CH 1880 MHz

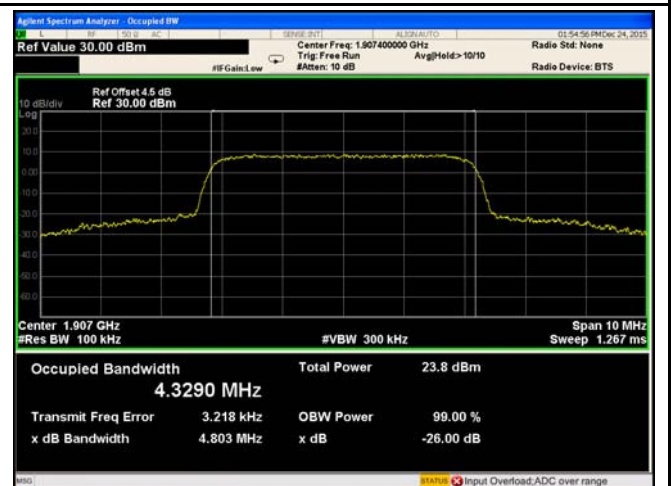

Band II BW - High CH 1907.6 MHz

6.5 Spurious Emissions at Antenna Terminals

Temperature	25°C
Relative Humidity	57%
Atmospheric Pressure	1024mbar
Test date :	December 24, 2015
Tested By :	Winnie Zhang

Requirement(s):

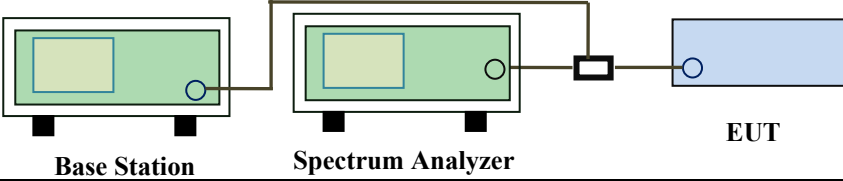
Spec	Item	Requirement	Applicable
§2.1051, §22.917(a)& §24.238(a) § 27.53(h)	a)	The power of any emission outside of the authorized operating frequency ranges must be lower than the transmitter power (P) by a factor of at least $43 + 10 \log (P)$ dB	<input checked="" type="checkbox"/>
Test Setup	 <p>The diagram shows a Base Station (green box) connected to a Spectrum Analyzer (green box) and an EUT (blue box) through a power divider (black box). The Base Station and Spectrum Analyzer are connected to the power divider, which then splits the signal to the EUT.</p>		
Test Procedure	<ul style="list-style-type: none"> - The EUT was connected to Spectrum Analyzer and Base Station via power divider. - The Band Edges of low and high channels for the highest RF powers were measured. - Setting RBW as roughly BW/100. 		
Remark			
Result	<input checked="" type="checkbox"/> Pass <input type="checkbox"/> Fail		

Test Data Yes N/A
 Test Plot Yes (See below) N/A

Test Plots

Cellular Band (Part 22H) result

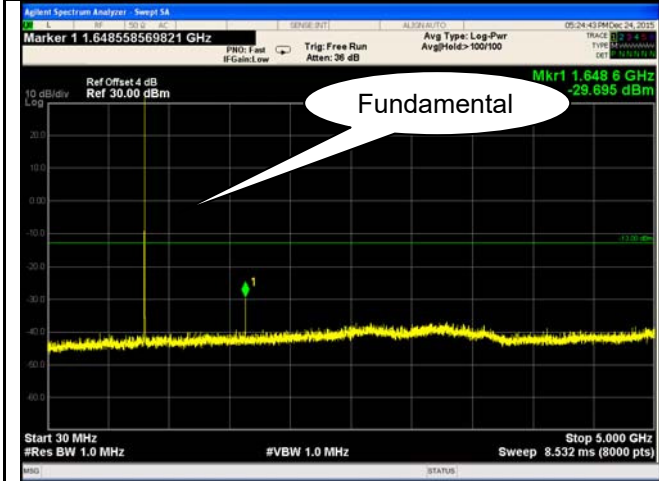

GSM 850 - Low Channel-1

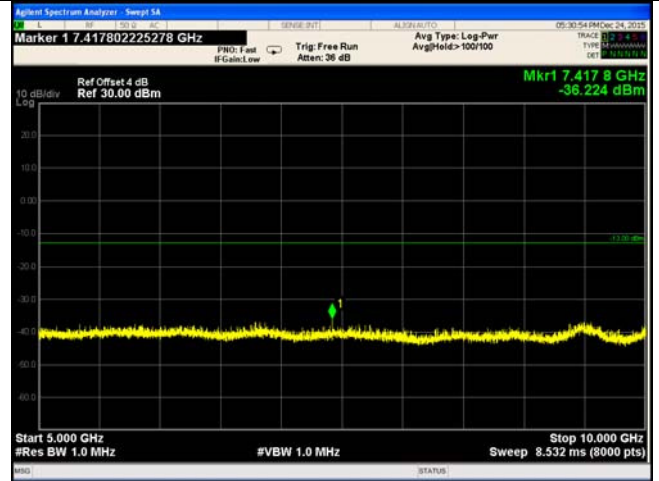

GSM 850 - Low Channel-2

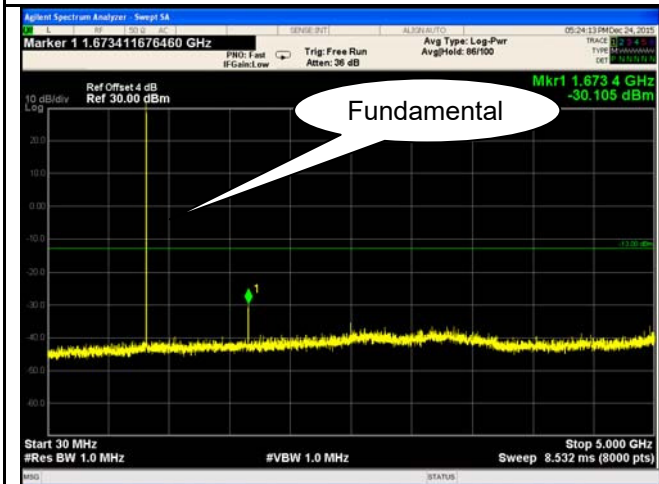

GSM 850 Middle Channel-1

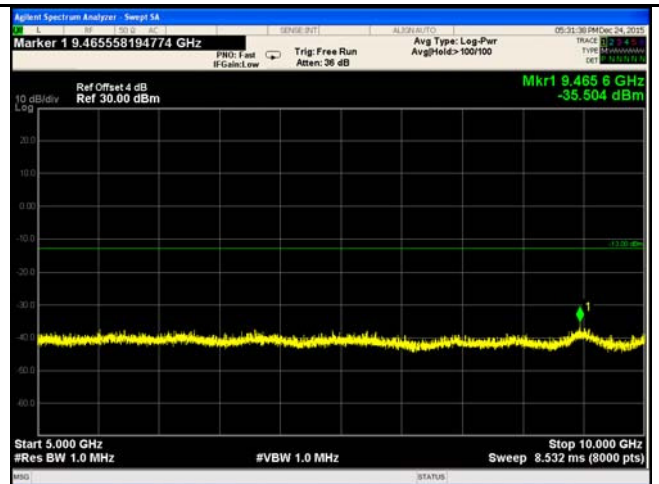

GSM 850 Middle Channel-2

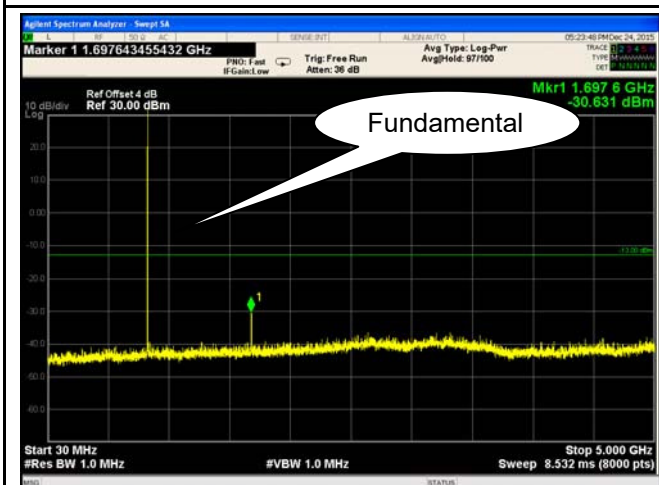

GSM 850 - High Channel-1

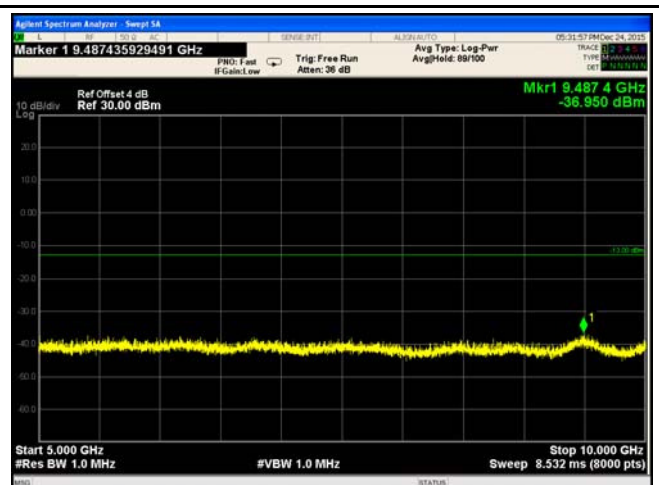

GSM 850 - High Channel-2

PCS Band (Part24E) result

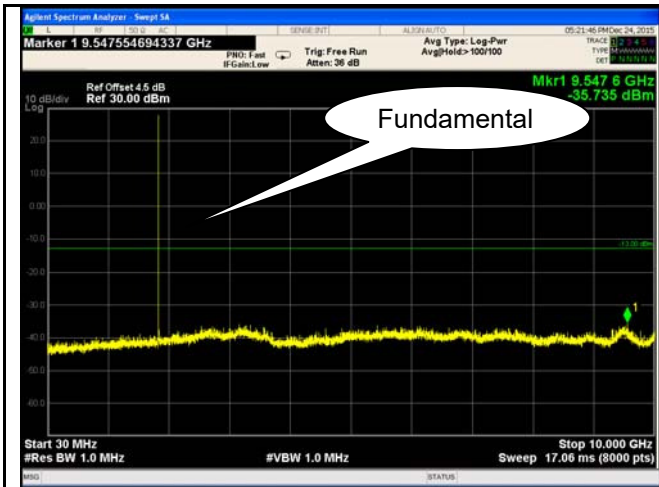

PCS1900 - Low Channel-1

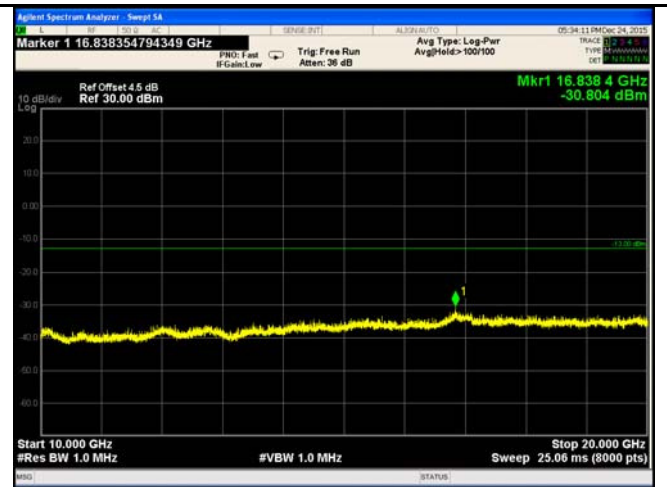

PCS 1900 - Low Channel-2

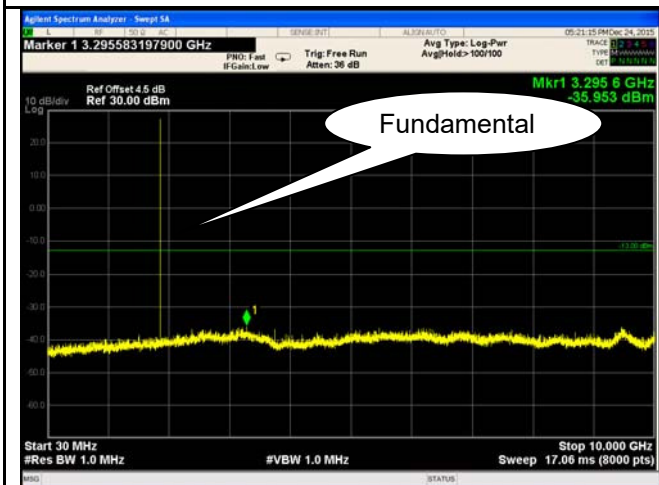

PCS1900 - Middle Channel-1

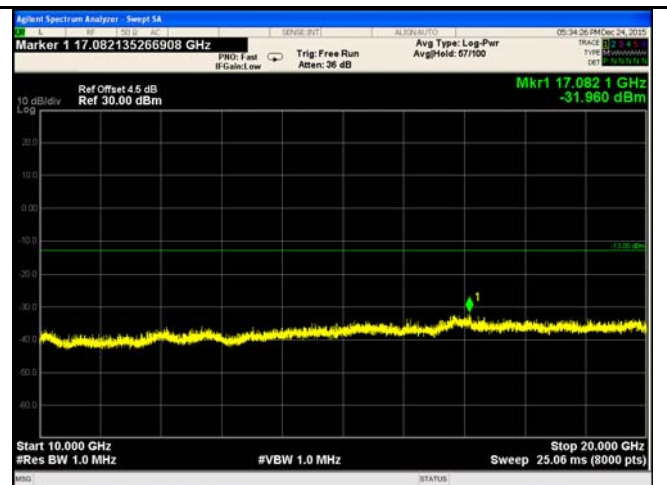

PCS 1900 - Middle Channel-2

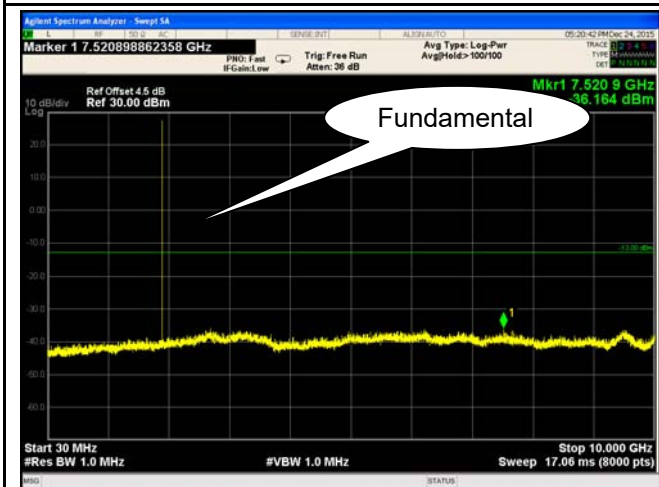

PCS1900 - High Channel-1

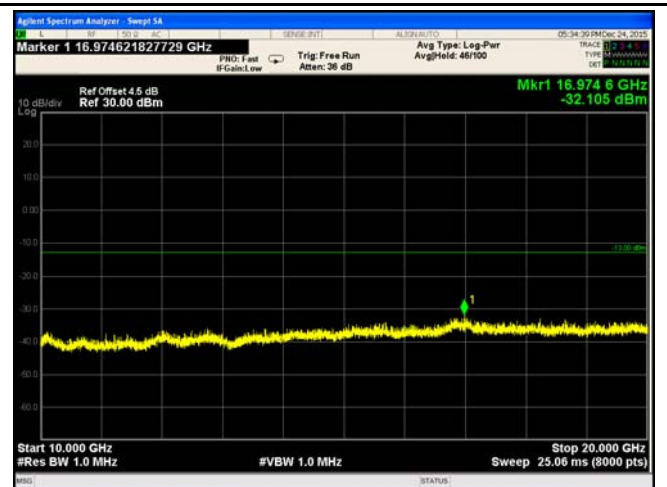

PCS 1900 - High Channel-2

UMTS-FDD Band V (Part 22H)

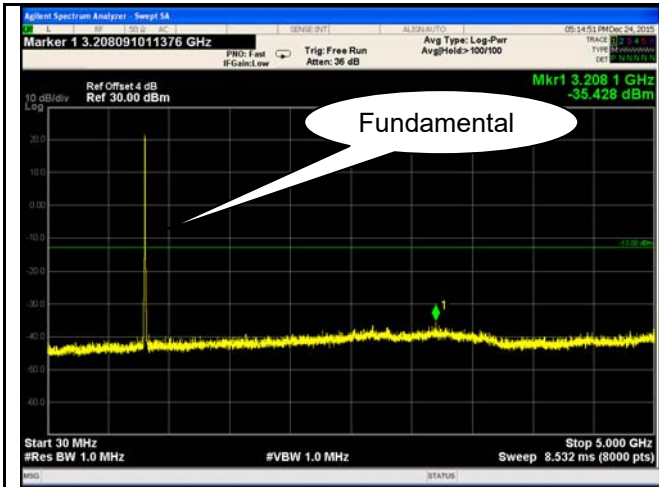

Band V - Low Channel-1

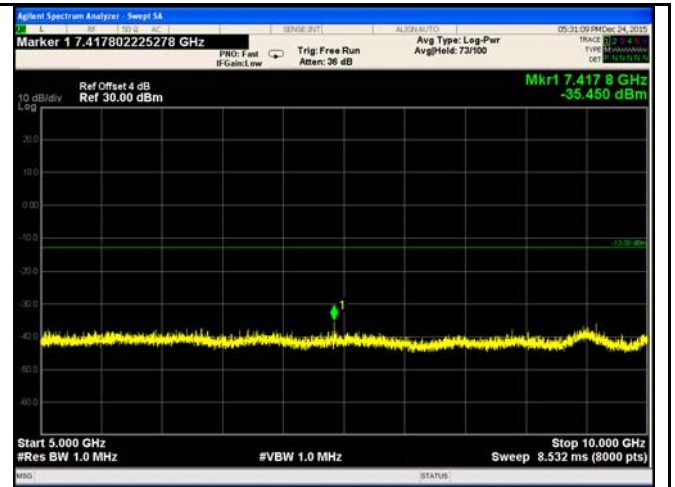

Band V - Low Channel-2

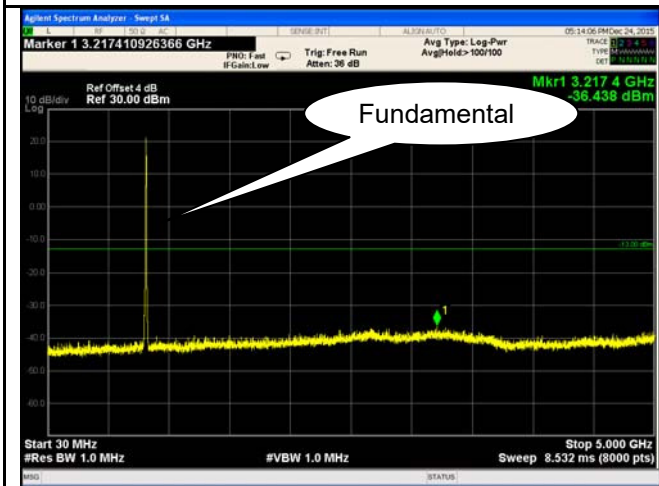

Band V - Middle Channel-1

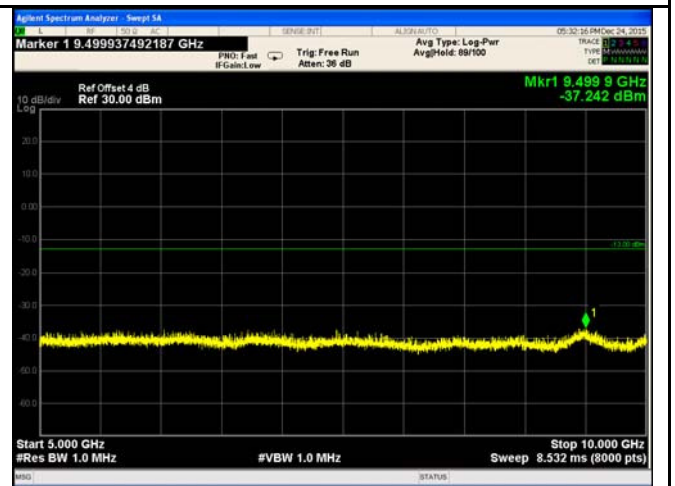

Band V - Middle Channel-2

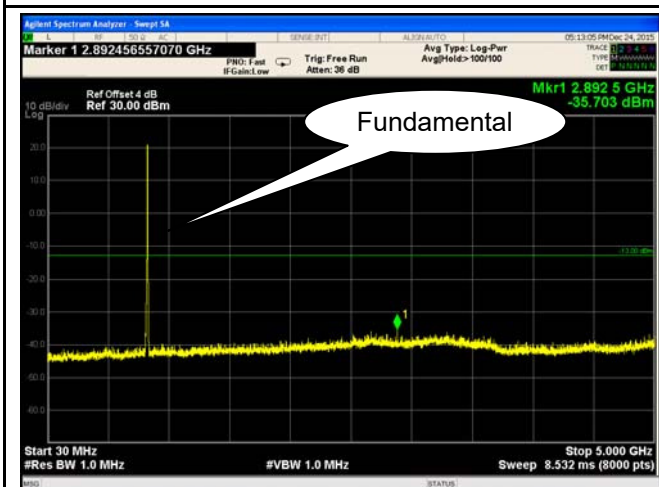

Band V - High Channel-1

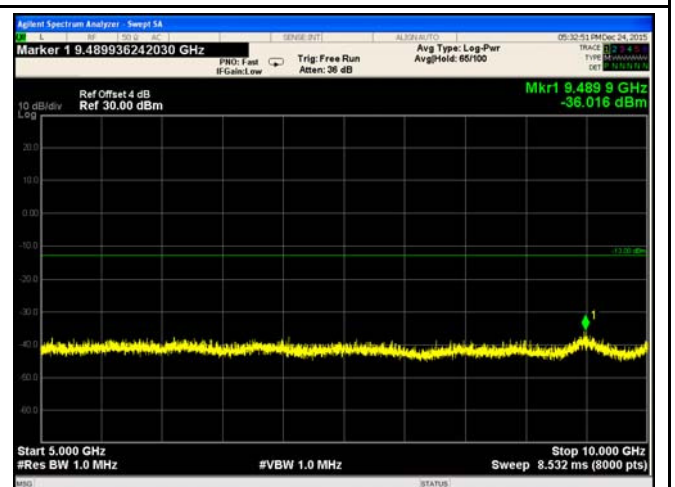

Band V - High Channel-2

UMTS-FDD Band II (Part 24E)

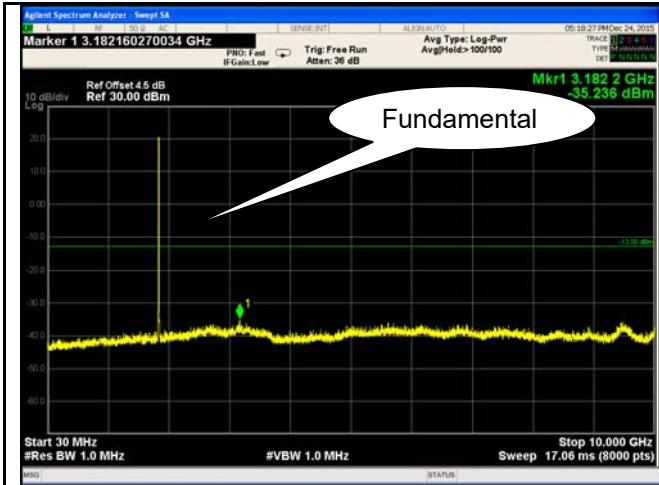

Band II - Low Channel-1

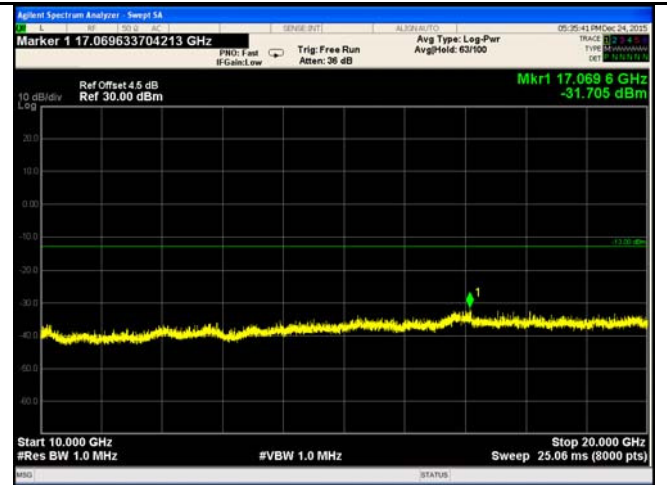

Band II - Low Channel-2

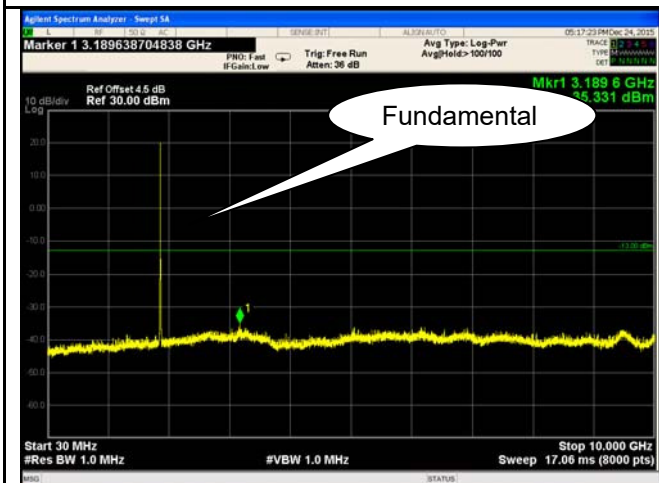

Band II - Middle Channel-1

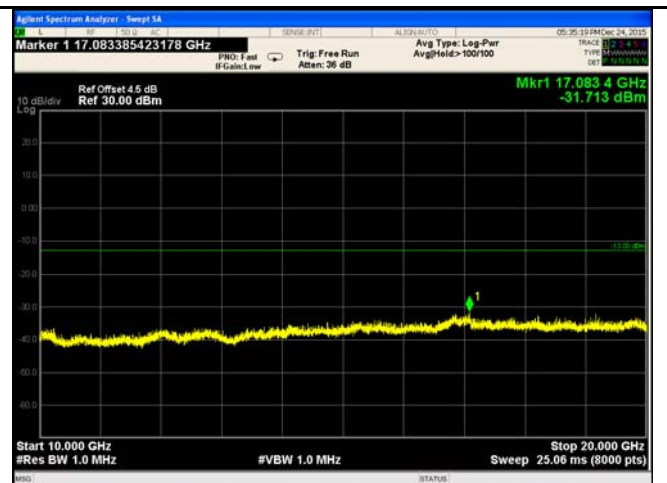

Band II - Middle Channel-2

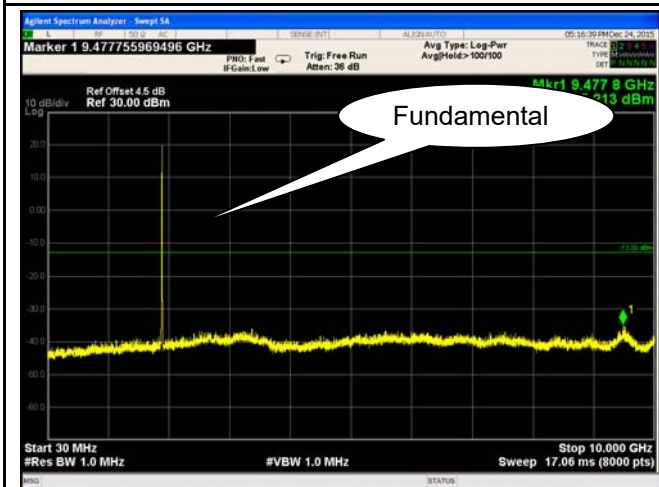

Band II - High Channel-1

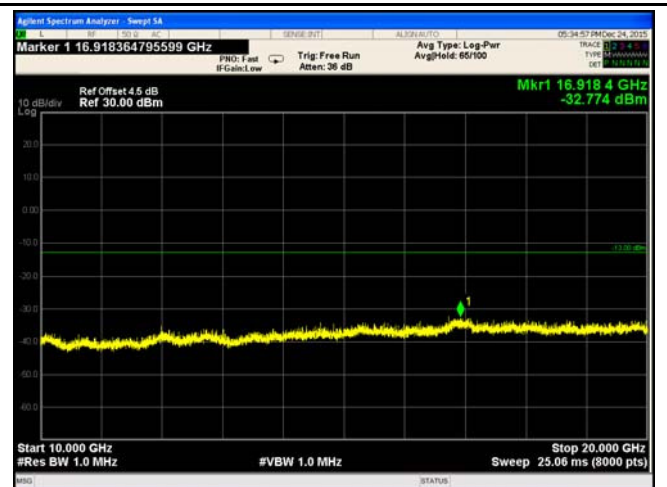

Band II - High Channel-2

6.6 Spurious Radiated Emissions

Temperature	25°C
Relative Humidity	57%
Atmospheric Pressure	1024mbar
Test date :	December 24, 2015
Tested By :	Winnie Zhang

Requirement(s):

Spec	Item	Requirement	Applicable
§2.1053, §22.917 & §24.238 § 27.53(h)	a)	The power of any emission outside of the authorized operating frequency ranges must be attenuated below the transmitter power (P) by a factor of at least $43 + 10 \log (P)$ dB. The spectrum is scanned from 30 MHz up to a frequency including its 10th harmonic.	<input checked="" type="checkbox"/>

Test setup	
------------	--

Test Procedure	<ol style="list-style-type: none"> The transmitter was placed on a wooden turntable, and it was transmitting into a non-radiating load which was also placed on the turntable. The measurement antenna was placed at a distance of 3 meters from the EUT. During the tests, the antenna height and polarization as well as EUT azimuth were varied in order to identify the maximum level of emissions from the EUT. The test was performed by placing the EUT on 3-orthogonal axis. Remove the EUT and replace it with substitution antenna. A signal generator was connected to the substitution antenna by a non-radiating cable. The absolute levels of the spurious emissions were measured by the substitution. <p>Sample Calculation:</p> <p>EUT Field Strength = Raw Amplitude (dBμV/m) – Amplifier Gain (dB) + Antenna Factor (dB) + Cable Loss (dB) + Filter Attenuation (dB, if used)</p>
----------------	--

Test Report	15050057-FCC-R1
Page	30 of 53

Remark	
Result	<input checked="" type="checkbox"/> Pass <input type="checkbox"/> Fail

Test Data Yes N/A

Test Plot Yes (See below) N/A

Cellular Band (Part 22H) result

Low channel

Frequency (MHz)	Substituted level (dBm)	Polarity (H/V)	Antenna Gain Correction (dB)	Cable Loss (dB)	Corrected Reading (dBm)	Limit (dBm)	Margin (dB)
1648.4	-45.19	V	7.95	0.78	-38.02	-13	-25.02
1648.4	-45.35	H	7.95	0.78	-38.18	-13	-25.18
318.5	-50.83	V	6.5	0.3	-44.63	-13	-31.63
671.8	-51.24	H	6.9	0.44	-44.78	-13	-31.78

Middle channel

Frequency (MHz)	Substituted level (dBm)	Polarity (H/V)	Antenna Gain Correction (dB)	Cable Loss (dB)	Corrected Reading (dBm)	Limit (dBm)	Margin (dB)
1673.2	-45.14	V	7.95	0.78	-37.97	-13	-24.97
1673.2	-45.29	H	7.95	0.78	-38.12	-13	-25.12
318.3	-50.77	V	6.5	0.3	-44.57	-13	-31.57
671.1	-51.16	H	6.9	0.44	-44.7	-13	-31.7

High channel

Frequency (MHz)	Substituted level (dBm)	Polarity (H/V)	Antenna Gain Correction (dB)	Cable Loss (dB)	Corrected Reading (dBm)	Limit (dBm)	Margin (dB)
1697.6	-45.21	V	7.95	0.78	-38.04	-13	-25.04
1697.6	-45.17	H	7.95	0.78	-38.00	-13	-25.00
318.4	-50.64	V	6.5	0.30	-44.44	-13	-31.44
671.5	-51.23	H	6.9	0.44	-44.77	-13	-31.77

Note:

- 1, The testing has been conformed to $10 \times 848.8 \text{MHz} = 8,488 \text{MHz}$
- 2, All other emissions more than 30 dB below the limit

PCS Band (Part24E) result

Low channel

Frequency (MHz)	Substituted level (dBm)	Polarity (H/V)	Antenna Gain Correction (dB)	Cable Loss (dB)	Corrected Reading (dBm)	Limit (dBm)	Margin (dB)
3700.4	-46.21	V	10.25	2.73	-38.69	-13	-25.69
3700.4	-46.85	H	10.25	2.73	-39.33	-13	-26.33
319.2	-51.29	V	6.5	0.3	-45.09	-13	-32.09
670.5	-52.16	H	6.9	0.44	-45.70	-13	-32.70

Middle channel

Frequency (MHz)	Substituted level (dBm)	Polarity (H/V)	Antenna Gain Correction (dB)	Cable Loss (dB)	Corrected Reading (dBm)	Limit (dBm)	Margin (dB)
3760	-46.18	V	10.25	2.73	-38.66	-13	-25.66
3760	-46.72	H	10.25	2.73	-39.20	-13	-26.20
319.6	-51.24	V	6.5	0.3	-45.04	-13	-32.04
670.1	-52.09	H	6.9	0.44	-45.63	-13	-32.63

High channel

Frequency (MHz)	Substituted level (dBm)	Polarity (H/V)	Antenna Gain Correction (dB)	Cable Loss (dB)	Corrected Reading (dBm)	Limit (dBm)	Margin (dB)
3819.6	-46.27	V	10.36	2.73	-38.64	-13	-25.64
3819.6	-46.61	H	10.36	2.73	-38.98	-13	-25.98
319.5	-51.33	V	6.5	0.30	-45.13	-13	-32.13
670.9	-52.18	H	6.9	0.44	-45.72	-13	-32.72

Note:

- 1, The testing has been conformed to $10 \times 1909.8 \text{ MHz} = 19,098 \text{ MHz}$
- 2, All other emissions more than 30 dB below the limit

UMTS-FDD Band V (Part 22H)

Low channel

Frequency (MHz)	Substituted level (dBm)	Polarity (H/V)	Antenna Gain Correction (dB)	Cable Loss (dB)	Corrected Reading (dBm)	Limit (dBm)	Margin (dB)
1652.8	-44.63	V	7.95	0.78	-37.46	-13	-24.46
1652.8	-44.91	H	7.95	0.78	-37.74	-13	-24.74
318.4	-51.27	V	6.5	0.30	-45.07	-13	-32.07
671.7	-51.85	H	6.9	0.44	-45.39	-13	-32.39

Middle channel

Frequency (MHz)	Substituted level (dBm)	Polarity (H/V)	Antenna Gain Correction (dB)	Cable Loss (dB)	Corrected Reading (dBm)	Limit (dBm)	Margin (dB)
1670	-44.55	V	7.95	0.78	-37.38	-13	-24.38
1670	-44.89	H	7.95	0.78	-37.72	-13	-24.72
318.3	-51.23	V	6.5	0.30	-45.03	-13	-32.03
671.8	-51.75	H	6.9	0.44	-45.29	-13	-32.29

High channel

Frequency (MHz)	Substituted level (dBm)	Polarity (H/V)	Antenna Gain Correction (dB)	Cable Loss (dB)	Corrected Reading (dBm)	Limit (dBm)	Margin (dB)
1693.2	-44.48	V	7.95	0.78	-37.31	-13	-24.31
1693.2	-44.75	H	7.95	0.78	-37.58	-13	-24.58
318.9	-51.19	V	6.5	0.30	-44.99	-13	-31.99
671.2	-51.63	H	6.9	0.44	-45.17	-13	-32.17

Note:

- 1, The testing has been conformed to $10 \times 1907.6 \text{ MHz} = 19,076 \text{ MHz}$
- 2, All other emissions more than 30 dB below the limit

UMTS-FDD Band II (Part 24E)

Low channel

Frequency (MHz)	Substituted level (dBm)	Polarity (H/V)	Antenna Gain Correction (dB)	Cable Loss (dB)	Corrected Reading (dBm)	Limit (dBm)	Margin (dB)
3704.8	-46.59	V	10.25	2.73	-39.07	-13	-26.07
3704.8	-47.23	H	10.25	2.73	-39.71	-13	-26.71
319.1	-51.45	V	6.5	0.30	-45.25	-13	-32.25
670.3	-51.96	H	6.9	0.44	-45.5	-13	-32.50

Middle channel

Frequency (MHz)	Substituted level (dBm)	Polarity (H/V)	Antenna Gain Correction (dB)	Cable Loss (dB)	Corrected Reading (dBm)	Limit (dBm)	Margin (dB)
3760	-46.53	V	10.25	2.73	-39.01	-13	-26.01
3760	-47.18	H	10.25	2.73	-39.66	-13	-26.66
319.5	-51.34	V	6.5	0.30	-45.14	-13	-32.14
670.8	-51.87	H	6.9	0.44	-45.41	-13	-32.41

High channel

Frequency (MHz)	Substituted level (dBm)	Polarity (H/V)	Antenna Gain Correction (dB)	Cable Loss (dB)	Corrected Reading (dBm)	Limit (dBm)	Margin (dB)
3815.2	-46.47	V	10.36	2.73	-38.84	-13	-25.84
3815.2	-47.22	H	10.36	2.73	-39.59	-13	-26.59
319.6	-51.28	V	6.5	0.30	-45.08	-13	-32.08
670.1	-51.75	H	6.9	0.44	-45.29	-13	-32.29

Note:

- 1, The testing has been conformed to $10 \times 846.6 \text{ MHz} = 8,466 \text{ MHz}$
- 2, All other emissions more than 30 dB below the limit

6.7 Band Edge

Temperature	25°C
Relative Humidity	57%
Atmospheric Pressure	1024mbar
Test date :	December 24, 2015
Tested By :	Winnie Zhang

Requirement(s):

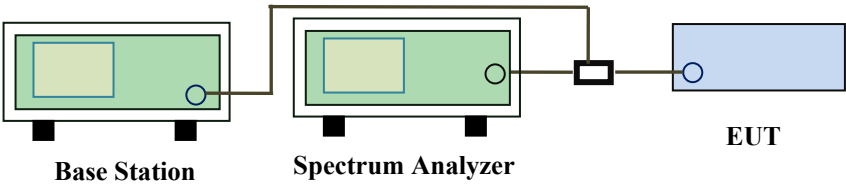
Spec	Item	Requirement	Applicable
§22.917(a) §24.238(a) § 27.53(h)	a)	The power of any emission outside of the authorized operating frequency ranges must be lower than the transmitter power (P) by a factor of at least $43 + 10 \log (P)$ dB.	<input checked="" type="checkbox"/>
Test setup	 <p>The diagram shows a Base Station (green box) connected to a Spectrum Analyzer (green box) and an EUT (blue box) via a power divider (black box). The Base Station and Spectrum Analyzer are connected to each other, and the Spectrum Analyzer is connected to the power divider, which then splits the signal to the EUT.</p>		
Procedure	<ul style="list-style-type: none"> - The EUT was connected to Spectrum Analyzer and Base Station via power divider. - The Band Edges of low and high channels for the highest RF powers were measured. Setting RBW as roughly BW/100. 		
Remark			
Result	<input checked="" type="checkbox"/> Pass <input type="checkbox"/> Fail		

Test Data Yes N/A

Test Plot Yes (See below) N/A

Cellular Band (Part 22H) result

Frequency (MHz)	Emission (dBm)	Limit (dBm)
823.996	-15.317	-13
849.004	-16.194	-13

PCS Band (Part24E) result

Frequency (MHz)	Emission (dBm)	Limit (dBm)
1849.980	-16.154	-13
1910.021	-15.392	-13

UMTS-FDD Band V (Part 22H)

Frequency (MHz)	Emission (dBm)	Limit (dBm)
822.83	-23.323	-13
850.10	-23.125	-13

UMTS-FDD Band II (Part 24E)

Frequency (MHz)	Emission (dBm)	Limit (dBm)
1849.75	-24.390	-13
1910.81	-24.172	-13

Test Plots

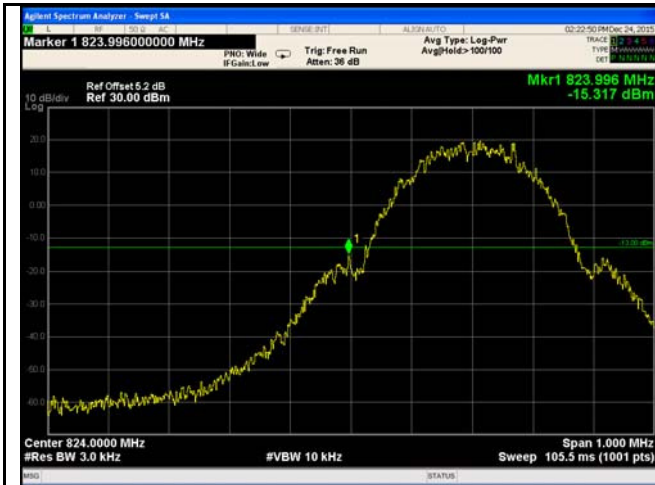

Cellular Band - Low Channel

Note: Offset=Cable loss (4.0) + 10log
(3.91/3)=4.0+2.2=6.2 dB

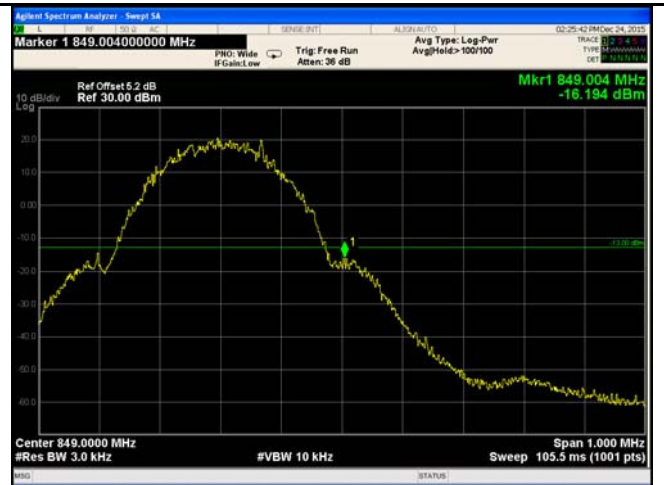

Cellular Band - High Channel

Note: Offset=Cable loss (4.0) + 10log
(3.97/3)=4.0+2.2=6.2 dB

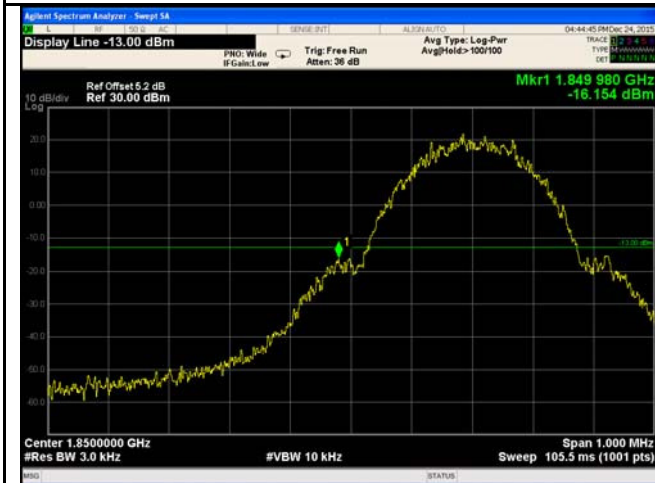

PCS Band - Low Channel

Note: Offset=Cable loss (4.5) + 10log
(3.54/3)=4.5+1.7=6.2 dB



PCS Band - High Channel

Note: Offset=Cable loss (4.5) + 10log
(3.88/3)=4.5+2.0=6.5 dB



UMTS-FDD Band V - Low Channel

Note: Offset=Cable loss (4.0) + 10log
(68.83/30)=4.0+3.5=7.5 dB



UMTS-FDD Band V - High Channel

Note: Offset=Cable loss (4.0) + 10log
(68.90/30)=4.0+3.5=7.5 dB

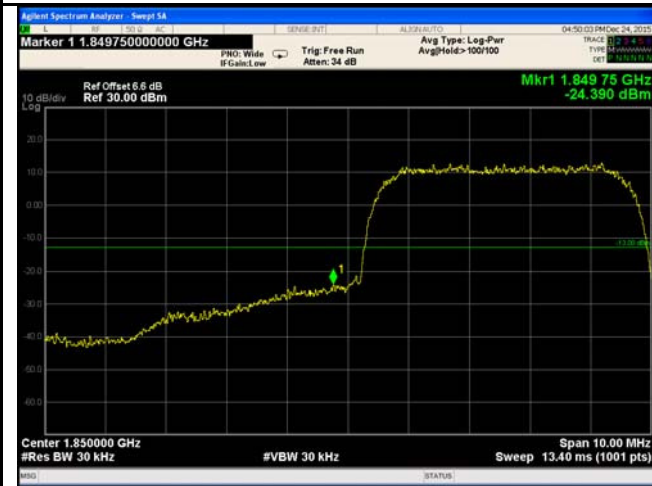

UMTS-FDD Band II - Low Channel

Note: Offset=Cable loss (4.5) + 10log
(48.65/30)=4.5+2.0=6.5 dB



UMTS-FDD Band II - High Channel

Note: Offset=Cable loss (4.5) + 10log
(48.03/30)=4.5+2.0=6.5 dB

6.8 Frequency Stability

Temperature	22°C
Relative Humidity	58%
Atmospheric Pressure	1025mbar
Test date :	December 25, 2015
Tested By :	Winnie Zhang

Requirement(s):

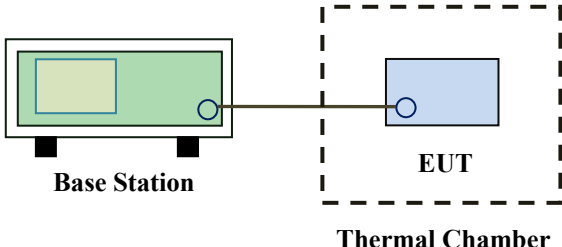
Spec	Item	Requirement	Applicable																																
§2.1055, §22.355 & §24.235 § 27.5(h); § 27.54	a)	According to §22.355, the carrier frequency of each transmitter in the Public Mobile Services must be maintained within the tolerances given in Table below: Frequency Tolerance for Transmitters in the Public Mobile Services	<input checked="" type="checkbox"/>																																
		<table border="1"> <thead> <tr> <th>Frequency Range (MHz)</th> <th>Base, fixed (ppm)</th> <th>Mobile ≤ 3 watts (ppm)</th> <th>Mobile ≤ 3 watts (ppm)</th> </tr> </thead> <tbody> <tr> <td>25 to 50</td> <td>20.0</td> <td>20.0</td> <td>50.0</td> </tr> <tr> <td>50 to 450</td> <td>5.0</td> <td>5.0</td> <td>50.0</td> </tr> <tr> <td>45 to 512</td> <td>2.5</td> <td>5.0</td> <td>.0</td> </tr> <tr> <td>821 to 896</td> <td>1.5</td> <td>2.5</td> <td>2.5</td> </tr> <tr> <td>928 to 29.</td> <td>5.0</td> <td>N/A</td> <td>N/A</td> </tr> <tr> <td>929 to 960.</td> <td>1.5</td> <td>N/A</td> <td>N/A</td> </tr> <tr> <td>2110 to 2220</td> <td>10.0</td> <td>N/A</td> <td>N/A</td> </tr> </tbody> </table>		Frequency Range (MHz)	Base, fixed (ppm)	Mobile ≤ 3 watts (ppm)	Mobile ≤ 3 watts (ppm)	25 to 50	20.0	20.0	50.0	50 to 450	5.0	5.0	50.0	45 to 512	2.5	5.0	.0	821 to 896	1.5	2.5	2.5	928 to 29.	5.0	N/A	N/A	929 to 960.	1.5	N/A	N/A	2110 to 2220	10.0	N/A	N/A
		Frequency Range (MHz)		Base, fixed (ppm)	Mobile ≤ 3 watts (ppm)	Mobile ≤ 3 watts (ppm)																													
		25 to 50		20.0	20.0	50.0																													
		50 to 450		5.0	5.0	50.0																													
		45 to 512		2.5	5.0	.0																													
		821 to 896		1.5	2.5	2.5																													
		928 to 29.		5.0	N/A	N/A																													
929 to 960.	1.5	N/A	N/A																																
2110 to 2220	10.0	N/A	N/A																																
According to §24.235, the frequency stability shall be sufficient to ensure that the fundamental emissions stay within the authorized frequency block.																																			
<div style="text-align: center;">  <p>The diagram illustrates the test setup. On the left, a green rectangular box represents the 'Base Station'. A line connects it to a blue rectangular box labeled 'EUT' (Equipment Under Test), which is enclosed within a dashed-line box representing the 'Thermal Chamber'.</p> </div>																																			
Test setup																																			

Test Report	15050057-FCC-R1
Page	40 of 53

Procedure	A communication link was established between EUT and base station. The frequency error was monitored and measured by base station under variation of ambient temperature and variation of primary supply voltage. Limit: The frequency stability of the transmitter shall be maintained within $\pm 0.00025\%$ ($\pm 2.5\text{ppm}$) of the center frequency.
Remark	
Result	<input checked="" type="checkbox"/> Pass <input type="checkbox"/> Fail

Test Data Yes N/A

Test Plot Yes (See below) N/A

Cellular Band (Part 22H) result

Middle Channel, $f_0 = 836.6$ MHz				
Temperature (°C)	Power Supplied (V _{DC})	Frequency Error (Hz)	Frequency Error (ppm)	Limit (ppm)
-10	3.7	22	0.0263	2.5
0		23	0.0275	2.5
10		25	0.0299	2.5
20		24	0.0287	2.5
30		16	0.0191	2.5
40		14	0.0167	2.5
50		14	0.0167	2.5
55		27	0.0323	2.5
25	4.2	17	0.0203	2.5
	3.5	22	0.0263	2.5

PCS Band (Part 24E) result

Middle Channel, $f_0 = 1880$ MHz				
Temperature (°C)	Power Supplied (V _{DC})	Frequency Error (Hz)	Frequency Error (ppm)	Limit (ppm)
-10	3.7	22	0.0117	2.5
0		23	0.0122	2.5
10		15	0.0080	2.5
20		14	0.0074	2.5
30		20	0.0106	2.5
40		19	0.0101	2.5
50		24	0.0128	2.5
55		24	0.0128	2.5
25	4.2	20	0.0106	2.5
	3.5	22	0.0117	2.5

UMTS-FDD Band V (Part 22H)

Middle Channel, $f_0 = 835$ MHz				
Temperature (°C)	Power Supplied (V _{DC})	Frequency Error (Hz)	Frequency Error (ppm)	Limit (ppm)
-10	3.7	20	0.0240	2.5
0		17	0.0204	2.5
10		16	0.0192	2.5
20		15	0.0180	2.5
30		11	0.0132	2.5
40		12	0.0144	2.5
50		16	0.0192	2.5
55		16	0.0192	2.5
25	4.2	17	0.0204	2.5
	3.5	20	0.0240	2.5

UMTS-FDD Band II (Part 24E)

Middle Channel, $f_0 = 1880$ MHz				
Temperature (°C)	Power Supplied (V _{DC})	Frequency Error (Hz)	Frequency Error (ppm)	Limit (ppm)
-10	3.7	17	0.0090	2.5
0		15	0.0080	2.5
10		11	0.0059	2.5
20		9	0.0048	2.5
30		11	0.0059	2.5
40		10	0.0053	2.5
50		13	0.0069	2.5
55		12	0.0064	2.5
25	4.2	11	0.0059	2.5
	3.5	12	0.0064	2.5

Annex A. TEST INSTRUMENT

Instrument	Model	Serial #	Cal Date	Cal Due	In use
RF Conducted Test					
Agilent ESA-E SERIES SPECTRUM ANALYZER	E4407B	MY45108319	09/17/2015	09/16/2016	<input checked="" type="checkbox"/>
Power Splitter	1#	1#	09/01/2015	08/31/2016	<input checked="" type="checkbox"/>
Universal Radio Communication Tester	CMU200	121393	09/25/2015	09/24/2016	<input checked="" type="checkbox"/>
Temperature/Humidity Chamber	UHL-270	001	10/09/2015	10/08/2016	<input checked="" type="checkbox"/>
DC Power Supply	E3640A	MY40004013	09/17/2015	09/16/2016	<input checked="" type="checkbox"/>
Radiated Emissions					
EMI test receiver	ESL6	100262	09/17/2015	09/16/2016	<input checked="" type="checkbox"/>
OPT 010 AMPLIFIER (0.1-1300MHz)	8447E	2727A02430	09/01/2015	08/31/2016	<input checked="" type="checkbox"/>
Microwave Preamplifier (1 ~ 26.5GHz)	8449B	3008A02402	03/25/2015	03/24/2016	<input checked="" type="checkbox"/>
Bilog Antenna (30MHz~6GHz)	JB6	A110712	09/21/2015	09/20/2016	<input checked="" type="checkbox"/>
Bilog Antenna (30MHz~2GHz)	JB1	A112017	09/21/2015	09/20/2016	<input checked="" type="checkbox"/>
Double Ridge Horn Antenna (1 ~18GHz)	AH-118	71259	09/24/2015	09/23/2016	<input checked="" type="checkbox"/>
Double Ridge Horn Antenna (1 ~18GHz)	AH-118	71283	09/24/2015	09/23/2016	<input checked="" type="checkbox"/>
SYNTHESIZED SIGNAL GENERATOR	8665B	3744A01293	09/17/2015	09/16/2016	<input checked="" type="checkbox"/>
Tunable Notch Filter	3NF-800/1000-S	AA4	09/01/2015	08/31/2016	<input checked="" type="checkbox"/>
Tunable Notch Filter	3NF-1000/2000-S	AM 4	09/01/2015	08/31/2016	<input checked="" type="checkbox"/>

Annex B. EUT And Test Setup Photographs

Annex B.i. Photograph: EUT External Photo

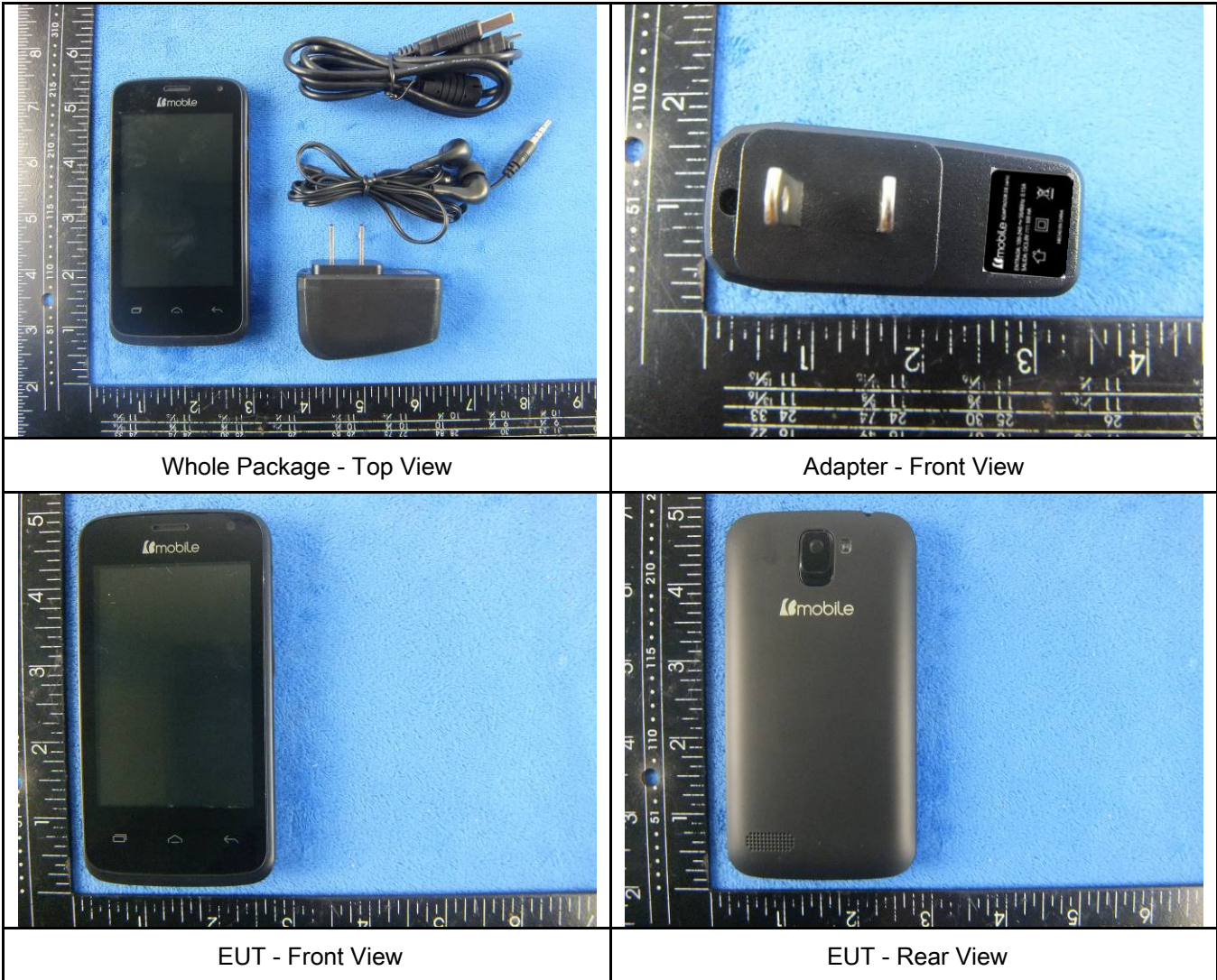



EUT - Top View



EUT - Bottom View



EUT - Left View



EUT - Right View

Annex B.ii. Photograph: EUT Internal Photo



Cover Off - Top View 1



Cover Off - Top View 2



Battery - Front View



Battery - Rear View

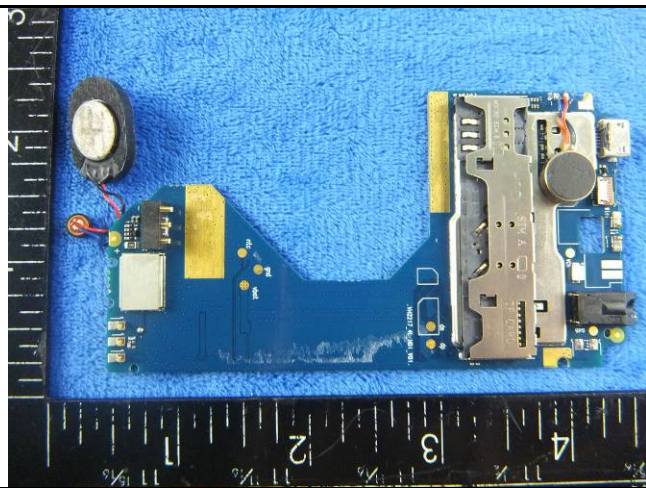

Mainbard with Shielding - Front View

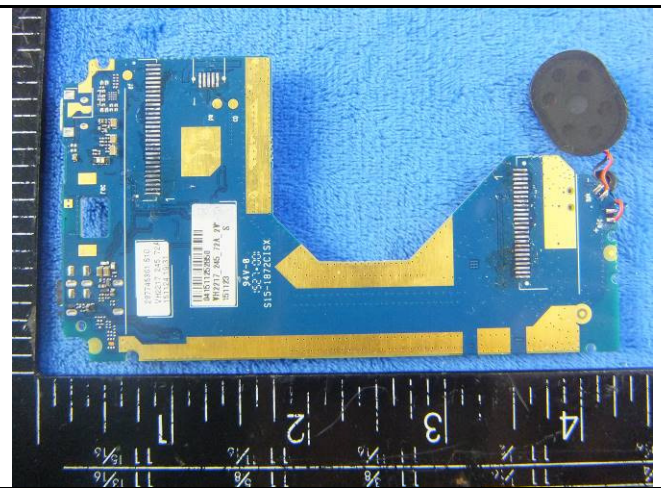

Mainbard with Shielding - Rear View

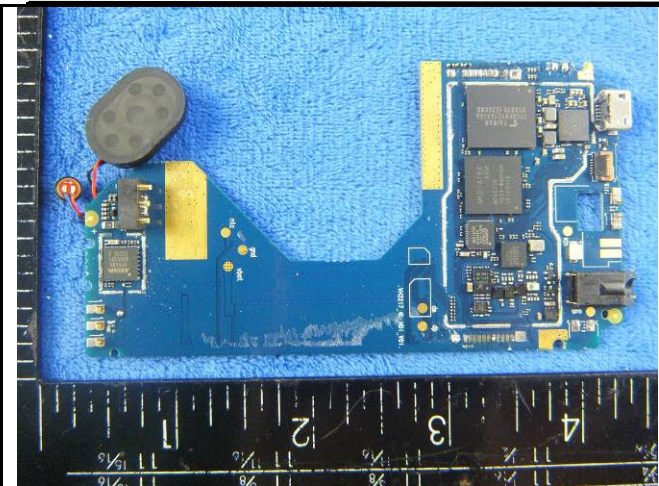

Mainboard without shielding - Front View

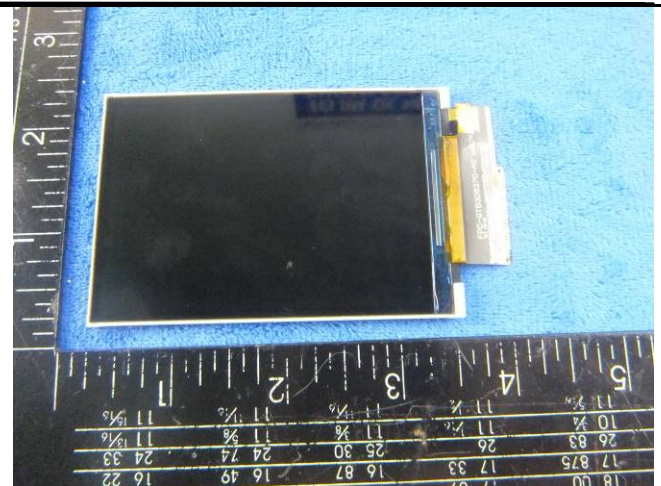

LCD - Front View

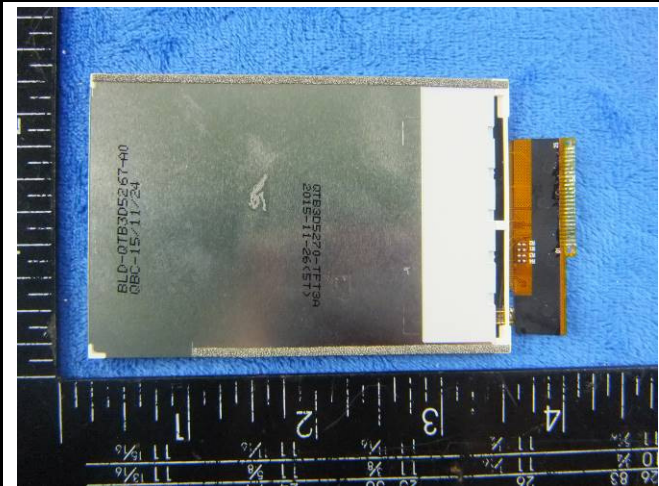

LCD - Rear View



GSM/PCS/UMTS-FDD - Antenna View



GPS - Antenna View



WIFI/BT - Antenna View

Annex B.iii. Photograph: Test Setup Photo

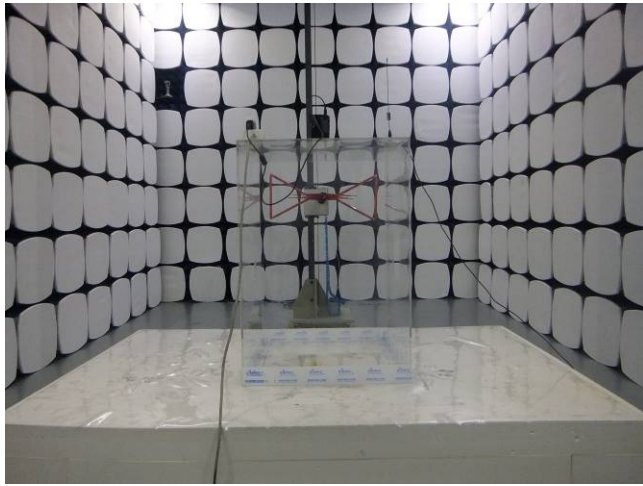

Radiated Spurious Emissions Test Setup Below 1GHz

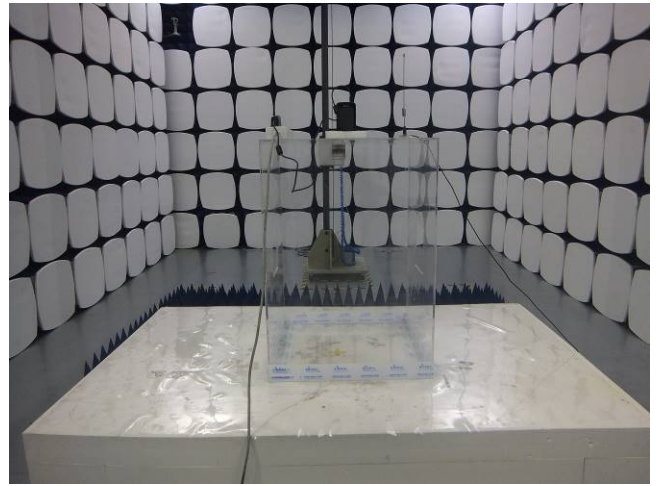

Radiated Spurious Emissions Test Setup Above
1GHz

Annex C. TEST SETUP AND SUPPORTING EQUIPMENT

Annex C.ii. TEST SET UP BLOCK

Block Configuration Diagram for Radiated Emissions

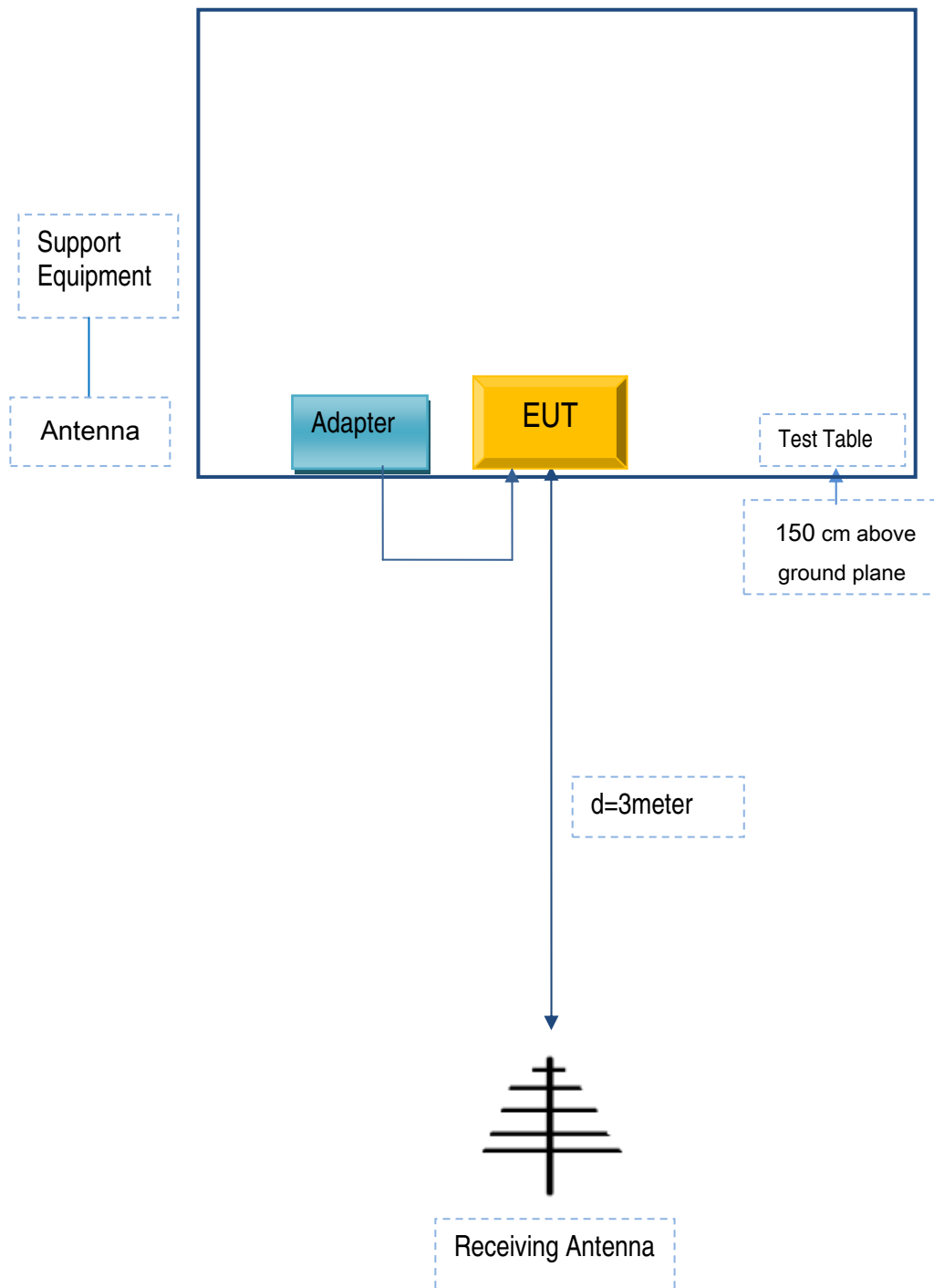

Annex C. ii. SUPPORTING EQUIPMENT DESCRIPTION

The following is a description of supporting equipment and details of cables used with the EUT.

Manufacturer	Equipment Description	Model	Serial No
b mobile HK Limited	Adapter	N/A	CX12503647

Supporting Cable:

Cable type	Shield Type	Ferrite Core	Length	Serial No
USB Cable	Un-shielding	No	0.8m	KH130452136

Test Report	15050057-FCC-R1
Page	51 of 53

Annex C.ii. EUT OPERATING CONKITIONS

N/A

Test Report	15050057-FCC-R1
Page	52 of 53

Annex D. User Manual / Block Diagram / Schematics / Partlist

Please see attachment

Test Report	15050057-FCC-R1
Page	53 of 53

Annex E. DECLARATION OF SIMILARITY

N/A