

# RF TEST REPORT



Report No.: 15050044-FCC-R1

Supersede Report No.: N/A

Applicant	b mobile HK Limited	
Product Name	Mobile phone	
Model No.	AX1055	
Serial No.	AX1050,AX1065	
Test Standard	FCC Part 22(H):2014 ;FCC Part 24(E):2014; ANSI/TIAC603 D: 2010	
Test Date	October 28 to November 17, 2015	
Issue Date	November 17, 2015	
Test Result	<input checked="" type="checkbox"/> Pass <input type="checkbox"/> Fail	
Equipment complied with the specification	<input checked="" type="checkbox"/>	
Equipment did not comply with the specification	<input type="checkbox"/>	
<i>Winnie Zhang</i>	<i>David Huang</i>	
Winnie Zhang Test Engineer	David Huang Checked By	
This test report may be reproduced in full only Test result presented in this test report is applicable to the tested sample only		

Issued by:

**SIEMIC (SHENZHEN-CHINA) LABORATORIES**

Zone A, Floor 1, Building 2 Wan Ye Long Technology Park

South Side of Zhoushi Road, Bao' an District, Shenzhen, Guangdong China 518108

Phone: +86 0755 2601 4629801 Email: [China@siemic.com.cn](mailto:China@siemic.com.cn)

## Laboratories Introduction

SIEMIC, headquartered in the heart of Silicon Valley, with superior facilities in US and Asia, is one of the leading independent testing and certification facilities providing customers with one-stop shop services for Compliance Testing and Global Certifications.



In addition to testing and certification, SIEMIC provides initial design reviews and compliance management throughout a project. Our extensive experience with China, Asia Pacific, North America, European, and International compliance requirements, assures the fastest, most cost effective way to attain regulatory compliance for the global markets.

### Accreditations for Conformity Assessment

Country/Region	Scope
USA	EMC, RF/Wireless, SAR, Telecom
Canada	EMC, RF/Wireless, SAR, Telecom
Taiwan	EMC, RF, Telecom, SAR, Safety
Hong Kong	RF/Wireless, SAR, Telecom
Australia	EMC, RF, Telecom, SAR, Safety
Korea	EMI, EMS, RF, SAR, Telecom, Safety
Japan	EMI, RF/Wireless, SAR, Telecom
Singapore	EMC, RF, SAR, Telecom
Europe	EMC, RF, SAR, Telecom, Safety

Test Report	15050044-FCC-R1
Page	3 of 56

This page has been left blank intentionally.

## CONTENTS

1. REPORT REVISION HISTORY .....	5
2. CUSTOMER INFORMATION .....	5
3. TEST SITE INFORMATION.....	5
4. EQUIPMENT UNDER TEST (EUT) INFORMATION .....	6
5. TEST SUMMARY .....	9
6. MEASUREMENTS, EXAMINATION AND DERIVED RESULTS .....	10
6.1 RF EXPOSURE (SAR).....	10
6.2 RF OUTPUT POWER.....	11
6.3 PEAK-AVERAGE RATIO.....	19
6.4 MODULATION CHARACTERISTIC.....	21
6.5 OCCUPIED BANDWIDTH.....	22
6.6 SPURIOUS EMISSIONS AT ANTENNA TERMINALS.....	26
6.7 SPURIOUS RADIATED EMISSIONS.....	31
6.8 BAND EDGE.....	37
6.9 FREQUENCY STABILITY .....	41
ANNEX A. TEST INSTRUMENT.....	45
ANNEX B. EUT AND TEST SETUP PHOTOGRAPHS.....	46
ANNEX C. TEST SETUP AND SUPPORTING EQUIPMENT.....	52
ANNEX C.II. EUT OPERATING CONKITIONS.....	54
ANNEX D. USER MANUAL / BLOCK DIAGRAM / SCHEMATICS / PARTLIST .....	55
ANNEX E. DECLARATION OF SIMILARITY.....	56

## 1. Report Revision History

Report No.	Report Version	Description	Issue Date
15050044-FCC-R1	NONE	Original	November 17, 2015

## 2. Customer information

Applicant Name	b mobile HK Limited
Applicant Add	Flat 18; 14/F Block 1; Golden Industrial Building;16-26 Kwai Tak Street; Kwai Chung;New Territories; Hong Kong
Manufacturer	b mobile HK Limited
Manufacturer Add	Flat 18; 14/F Block 1; Golden Industrial Building;16-26 Kwai Tak Street; Kwai Chung;New Territories; Hong Kong

## 3. Test site information

Lab performing tests	SIEMIC (Shenzhen-China) LABORATORIES
Lab Address	Zone A, Floor 1, Building 2 Wan Ye Long Technology Park South Side of Zhoushi Road, Bao' an District, Shenzhen, Guangdong China 518108
FCC Test Site No.	718246
IC Test Site No.	4842E-1
Test Software	Radiated Emission Program-To Shenzhen v2.0

## 4. Equipment under Test (EUT) Information

Description of EUT:	Mobile phone
Main Model:	AX1055
Serial Model:	AX1050,AX1065
Date EUT received:	October 27, 2015
Test Date(s):	October 28 to November 17, 2015
Equipment Category :	PCE
Antenna Gain:	<p>GSM850: 1 dBi  PCS1900: 1.8 dBi  UMTS-FDD Band V: 1.8 dBi  UMTS-FDD Band II: 1.8 dBi  Bluetooth: -0.8dBi  BLE: 3.3dBi  WIFI: -0.55 dBi  LTE Band 2: -1.6 dBi  LTE Band 4:-1.7 dBi  LTE Band 5: -3.1 dBi  LTE Band 7: -1.2 dBi  GPS:-0.65dBi</p>
Type of Modulation:	<p>GSM / GPRS: GMSK  EGPRS: GMSK, 8PSK  UMTS-FDD: QPSK, 16QAM  802.11b/g/n: DSSS, OFDM  Bluetooth: GFSK, <math>\pi</math> /4DQPSK, 8DPSK  BLE: GFSK  LTE Band: QPSK, 16QAM  GPS:BPSK</p>

	<p>GSM850 TX: 824.2 ~ 848.8 MHz; RX: 869.2 ~ 893.8 MHz</p> <p>PCS1900 TX: 1850.2 ~ 1909.8 MHz; RX: 1930.2 ~ 1989.8 MHz</p> <p>UMTS-FDD Band V TX: 826.4 ~ 846.6 MHz; RX: 871.4 ~ 891.6 MHz</p> <p>UMTS-FDD Band II TX: 1852.4 ~ 1907.6 MHz; RX: 1932.4 ~ 1987.6 MHz</p> <p>WiFi: 802.11b/g/n(20M): 2412-2472 MHz</p>
RF Operating Frequency (ies):	<p>WiFi: 802.11n(40M): 2422-2462 MHz</p> <p>Bluetooth &amp; BLE: 2402-2480 MHz</p> <p>LTE Band 2 TX: 1852.5 ~ 1907.5 MHz; RX : 1932.5 ~ 1987.5 MHz</p> <p>LTE Band 4 TX: 1712.5 ~ 1752.5 MHz; RX : 2112.5 ~ 2152.5 MHz</p> <p>LTE Band 5 TX: 826.5 ~ 846.5 MHz; RX : 871.5 ~ 891.5 MHz</p> <p>LTE Band 7 TX: 2502.5 ~ 2567.5 MHz; RX : 2622.5 ~ 2687.5 MHz</p> <p>GPS RX: 1575.42 MHz</p>
Maximum Conducted AV Power to Antenna:	<p>GSM850: 32.83 dBm</p> <p>PCS1900: 31.18 dBm</p> <p>UMTS-FDD Band V : 22.26 dBm</p> <p>UMTS-FDD Band II : 23.53 dBm</p>
ERP/EIRP:	<p>GSM850: 31.76 dBm / ERP</p> <p>PCS1900: 30.54 dBm / EIRP</p> <p>UMTS-FDD Band V : 21.89 dBm / ERP</p> <p>UMTS-FDD Band II : 23.85 dBm / EIRP</p>
Number of Channels:	<p>GSM 850: 124CH</p> <p>PCS1900: 299CH</p> <p>UMTS-FDD Band V : 102CH</p> <p>UMTS-FDD Band II : 277CH</p> <p>WiFi : 802.11b/g/n(20M): 13CH</p> <p>WiFi : 802.11n(40M): 9CH</p> <p>Bluetooth: 79CH</p> <p>BLE: 40CH</p> <p>GPS: 1CH</p>
Port:	Power Port, Earphone Port, USB Port

Test Report	15050044-FCC-R1
Page	8 of 56

---

Input Power: Battery:  
Model:A5007  
Standard Voltage:DC3.7V  
Rated Capacity:2200mAh,8.14Wh  
Adapter:  
Model:N/A  
Input: AC100-240V; 50/60Hz; 0.15A  
Output: DC 5.0V,1A

Trade Name : Bmobile

GPRS/EGPRS Multi-slot class 8/10/12

FCC ID: ZSW-30-020



## 5. Test Summary

The product was tested in accordance with the following specifications.

All testing has been performed according to below product classification:

FCC Rules	Description of Test	Result
§ 1.1307; § 2.1093	RF Exposure (SAR)	Compliance
§2.1046; § 22.913(a); § 24.232(c); § 27.50(c.10) ; § 27.50(d.4)	RF Output Power	Compliance
§ 24.232 (d) ; § 27.50(d)	Peak-Average Ratio	Compliance
§ 2.1047	Modulation Characteristics	N/A
§ 2.1049; § 22.905; § 22.917; § 24.238; § 27.53(a.5)	99% & -26 dB Occupied Bandwidth	Compliance
§ 2.1051; § 22.917(a); § 24.238(a); § 27.53(h)	Spurious Emissions at Antenna Terminal	Compliance
§ 2.1053; § 22.917(a); § 24.238(a); § 27.53(h)	Field Strength of Spurious Radiation	Compliance
§ 22.917(a); § 24.238(a); § 27.53(h)	Out of band emission, Band Edge	Compliance
§ 2.1055; § 22.355; § 24.235; § 27.5(h); § 27.54	Frequency stability vs. temperature Frequency stability vs. voltage	Compliance

Note: Testing was performed by configuring EUT to maximum output power status, the declared output power class for different

### Measurement Uncertainty

Emissions		
Test Item	Description	Uncertainty
Band Edge and Radiated Spurious Emissions	Confidence level of approximately 95% (in the case where distributions are normal), with a coverage factor of 2 (for EUTs < 0.5m X 0.5m X 0.5m)	+5.6dB/-4.5dB
-	-	-

## 6. MEASUREMENTS, EXAMINATION AND DERIVED RESULTS

### 6.1 RF Exposure (SAR)

Test Result: Pass

The EUT is a portable device, thus requires SAR evaluation;

Please refer to RF Exposure Evaluation Report: 15050044-FCC-H.

## 6.2 RF Output Power

Temperature	23°C
Relative Humidity	54%
Atmospheric Pressure	1030mbar
Test date :	October 30, 2015
Tested By :	Winnie Zhang

### Requirement(s):

Spec	Item	Requirement	Applicable
§22.913 (a)	a)	ERP:38.45dBm	<input checked="" type="checkbox"/>
§24.232 (c)	b)	EIRP:33dBm	<input checked="" type="checkbox"/>
§27.50 (c)	c)	EIRP: 30dBm	<input checked="" type="checkbox"/>

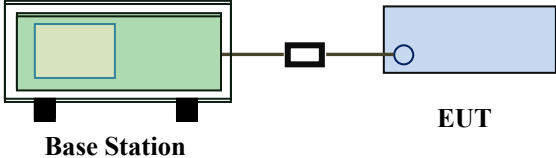
Test Setup	 <p style="text-align: center;">Base Station                      EUT</p>
------------	--

Test Procedure	<p>For Conducted Power:</p> <ul style="list-style-type: none"> <li>- The transmitter output port was connected to base station.</li> <li>- Set EUT at maximum power through base station.</li> <li>- Select lowest, middle, and highest channels for each band and different test mode.</li> </ul> <p>For ERP/EIRP:</p> <ul style="list-style-type: none"> <li>- The transmitter was placed on a wooden turntable, and it was transmitting into a non-radiating load which was also placed on the turntable.</li> <li>- The measurement antenna was placed at a distance of 3 meters from the EUT. During the tests, the antenna height and polarization as well as EUT azimuth were varied in order to identify the maximum level of emissions from the EUT. The test was performed by placing the EUT on 3-orthogonal axis.</li> <li>- The frequency range up to tenth harmonic of the fundamental frequency was investigated.</li> <li>- Remove the EUT and replace it with substitution antenna. A signal</li> </ul>
----------------	--

Test Report	15050044-FCC-R1
Page	12 of 56

	<p>generator was connected to the substitution antenna by a non-radiating cable. The absolute levels of the spurious emissions were measured by the substitution.</p> <ul style="list-style-type: none"> <li>- Spurious emissions in dB = 10 log (TX power in Watts/0.001) – the absolute level</li> <li>- Spurious attenuation limit in dB = 43 + 10 Log10 (power out in Watts).</li> </ul>
Remark	
Result	<input checked="" type="checkbox"/> Pass <input type="checkbox"/> Fail

Test Data     Yes       N/A

Test Plot     Yes (See below)       N/A

## Conducted Power

### GSM Mode:

Burst Average Power (dBm);								
Band	GSM850				PCS1900			
Channel	128	190	251	Tune up Power tolerant	512	661	810	Tune up Power tolerant
Frequency (MHz)	824.2	836.6	848.8	/	1850.2	1880	1909.8	/
GSM Voice (1 uplink),GMSK	<b>32.83</b>	32.77	32.67	32±1	<b>30.89</b>	30.73	30.57	30±1
GPRS Multi-Slot Class 8 (1 uplink),GMSK	32.82	32.75	32.65	32±1	30.87	30.71	30.56	30±1
GPRS Multi-Slot Class 10 (2 uplink) GMSK	31.89	32.82	31.75	32±1	29.95	29.83	29.67	29±1
GPRS Multi-Slot Class 12 (4 uplink) GMSK	29.14	29.17	29.09	29±1	27.13	27.01	26.84	27±1
EGPRS Multi-Slot Class 8 (1 uplink) GMSK MCS1	32.81	32.72	32.63	32±1	30.78	30.64	30.5	30±1
EGPRS Multi-Slot Class 10 (2 uplink) GMSK MCS1	31.83	31.78	31.69	31±1	29.98	29.84	29.66	29±1
EGPRS Multi-Slot Class 12 (4 uplink) GMSK MCS1	29.18	29.19	29.1	29±1	27.15	27.02	26.84	27±1
EGPRS Multi-Slot Class 8 (1 uplink) 8PSK MCS5	27.11	27.06	27.14	27±1	27.95	27.93	27.62	27±1
EGPRS Multi-Slot Class 10 (2 uplink) 8PSK MCS5	26.13	26.11	26.07	26±1	26.56	26.54	26.24	26±1
EGPRS Multi-Slot Class 12 (4 uplink) 8PSK MCS5	22.76	22.73	22.68	22±1	23.25	23.17	22.75	23±1

Test Report	15050044-FCC-R1
Page	14 of 56

Remark :

GPRS, CS1 coding scheme.

EGPRS, MCS1 coding scheme.

EGPRS, MCS5 coding scheme.

Multi-Slot Class 8 , Support Max 4 downlink, 1 uplink , 5 working link

Multi-Slot Class 10 , Support Max 4 downlink, 2 uplink , 5 working link

Multi-Slot Class 12 , Support Max 4 downlink, 4 uplink , 5 working link

**Note: Since GSM mode has higher power, so the test items below were not performed to GPRS and EGPRS mode.**

## UMTS Mode:

### UMTS-FDD Band V

Band/ Time Slot configuration	Channel	Frequency	Average power (dBm)	Tune up Power tolerant
RMC 12.2kbps	4132	826.4	22.18	22±1
	4175	835	22.08	22±1
	4233	846.6	<b>22.26</b>	22±1
HSDPA Subtest1	4132	826.4	20.38	21.3±1
	4175	835	20.37	21.3±1
	4233	846.6	20.46	21.3±1
HSDPA Subtest2	4132	826.4	20.36	21.3±1
	4175	835	20.33	21.3±1
	4233	846.6	20.43	21.3±1
HSDPA Subtest3	4132	826.4	20.38	21.3±1
	4175	835	20.39	21.3±1
	4233	846.6	20.35	21.3±1
HSDPA Subtest4	4132	826.4	20.31	21.3±1
	4175	835	20.34	21.3±1
	4233	846.6	20.43	21.3±1
HSUPA Subtest1	4132	826.4	20.37	21.3±1
	4175	835	20.38	21.3±1
	4233	846.6	20.44	21.3±1
HSUPA Subtest2	4132	826.4	20.36	21.3±1
	4175	835	20.39	21.3±1
	4233	846.6	20.47	21.3±1
HSUPA Subtest3	4132	826.4	20.35	21.3±1
	4175	835	20.34	21.3±1
	4233	846.6	20.33	21.3±1
HSUPA Subtest4	4132	826.4	20.36	21.3±1
	4175	835	20.37	21.3±1
	4233	846.6	20.35	21.3±1
HSUPA Subtest5	4132	826.4	20.34	21.3±1
	4175	835	20.35	21.3±1
	4233	846.6	20.46	21.3±1

## UMTS-FDD Band II

Band/ Time Slot configuration	Channel	Frequency	Average power (dBm)	Tune up Power tolerant
RMC 12.2kbps	9262	1852.4	23.45	23±1
	9400	1880	23.51	23±1
	9538	1907.6	<b>23.53</b>	23±1
HSDPA Subtest1	9262	1852.4	21.44	21.3±1
	9400	1880	21.52	21.3±1
	9538	1907.6	21.63	21.3±1
HSDPA Subtest2	9262	1852.4	21.36	21.3±1
	9400	1880	21.42	21.3±1
	9538	1907.6	21.61	21.3±1
HSDPA Subtest3	9262	1852.4	21.51	21.3±1
	9400	1880	21.62	21.3±1
	9538	1907.6	21.48	21.3±1
HSDPA Subtest4	9262	1852.4	21.43	21.3±1
	9400	1880	21.53	21.3±1
	9538	1907.6	21.43	21.3±1
HSUPA Subtest1	9262	1852.4	21.57	21.3±1
	9400	1880	21.39	21.3±1
	9538	1907.6	21.47	21.3±1
HSUPA Subtest2	9262	1852.4	21.38	21.3±1
	9400	1880	21.64	21.3±1
	9538	1907.6	21.32	21.3±1
HSUPA Subtest3	9262	1852.4	21.52	21.3±1
	9400	1880	21.36	21.3±1
	9538	1907.6	21.61	21.3±1
HSUPA Subtest4	9262	1852.4	21.51	21.3±1
	9400	1880	21.56	21.3±1
	9538	1907.6	21.49	21.3±1
HSUPA Subtest5	9262	1852.4	21.42	21.3±1
	9400	1880	21.37	21.3±1
	9538	1907.6	21.64	21.3±1



## ERP & EIRP

### ERP for Cellular Band (Part 22H)

Frequency (MHz)	Substituted level (dBm)	Antenna Polarization	Antenna Gain correction (dBi)	Cable Loss (dB)	Absolute Level (dBm)	Limit (dBm)
824.2	25.49	V	6.8	0.53	<b>31.76</b>	38.45
824.2	24.74	H	6.8	0.53	31.01	38.45
836.6	25.41	V	6.8	0.53	31.68	38.45
836.6	24.73	H	6.8	0.53	31.00	38.45
848.8	25.38	V	6.9	0.53	31.75	38.45
848.8	24.62	H	6.9	0.53	30.99	38.45

### EIRP for PCS Band (Part 24E)

Frequency (MHz)	Substituted level (dBm)	Antenna Polarization	Antenna Gain correction (dBi)	Cable Loss (dB)	Absolute Level (dBm)	Limit (dBm)
1850.2	24.15	V	7.88	0.85	<b>31.18</b>	33
1850.2	23.51	H	7.88	0.85	30.54	33
1880	24.09	V	7.88	0.85	31.12	33
1880	23.47	H	7.88	0.85	30.50	33
1909.8	24.02	V	7.86	0.85	31.03	33
1909.8	23.44	H	7.86	0.85	30.45	33

### ERP for UMTS-FDD Band V (Part 22H)

Frequency (MHz)	Substituted level (dBm)	Antenna Polarization	Antenna Gain correction (dBi)	Cable Loss (dB)	Absolute Level (dBm)	Limit (dBm)
826.4	15.62	V	6.8	0.53	<b>21.89</b>	38.45
826.4	14.87	H	6.8	0.53	21.14	38.45
835	15.56	V	6.8	0.53	21.83	38.45
835	14.81	H	6.8	0.53	21.08	38.45
846.6	15.49	V	6.9	0.53	21.86	38.45
846.6	14.73	H	6.9	0.53	21.10	38.45

### EIRP for UMTS-FDD Band II (Part 24E)

Frequency (MHz)	Substituted level (dBm)	Antenna Polarization	Antenna Gain correction (dBi)	Cable Loss (dB)	Absolute Level (dBm)	Limit (dBm)
1852.4	16.82	V	7.88	0.85	<b>23.85</b>	33
1852.4	16.18	H	7.88	0.85	23.21	33
1880	16.75	V	7.88	0.85	23.78	33
1880	16.09	H	7.88	0.85	23.12	33
1907.6	16.71	V	7.86	0.85	23.72	33
1907.6	15.97	H	7.86	0.85	22.98	33

### 6.3 Peak-Average Ratio

Temperature	23°C
Relative Humidity	52%
Atmospheric Pressure	1010mbar
Test date :	November 10, 2015
Tested By :	Winnie Zhang

Requirement(s):

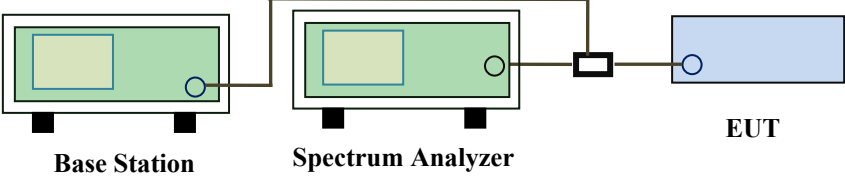
Spec	Item	Requirement	Applicable
§24.232(d) § 27.50(d)	a)	The peak-to-average ratio (PAR) of the transmission may not exceed 13 dB.	<input checked="" type="checkbox"/>
Test Setup	 <p style="text-align: center;">Base Station      Spectrum Analyzer      EUT</p>		
Test Procedure	<p><b>According with KDB 971168</b></p> <ol style="list-style-type: none"> <li>1. The signal analyzer' s CCDF measurement profile is enabled</li> <li>2. Frequency = carrier center frequency</li> <li>3. Measurement BW &gt; Emission bandwidth of signal</li> <li>4. The signal analyzer was set to collect one million samples to generate the CCDF curve</li> <li>5. The measurement interval was set depending on the type of signal analyzed. For continuous signals (&gt;98% duty cycle), the measurement interval was set to 1ms. For burst transmissions, the spectrum analyzer is set to use an internal " RF Burst" trigger that is synced with an incoming pulse and the measurement interval is set to less than the duration of the " on time" of one burst to ensure that energy is only captured during a time in which the transmitter is operating at maximum power</li> </ol>		
Remark			
Result	<input checked="" type="checkbox"/> Pass <input type="checkbox"/> Fail		

Test Data     Yes       N/A

Test Plot     Yes (See below)       N/A

**GSM 1900 PK-AV POWER(PART 24E)**

Frequency (MHz)	Conducted power(dBm)		Peak-Average Ratio(PAR)
	Peak	Average	
1850.2	31.21	30.89	0.32
1880	31.12	30.73	0.39
1909.8	30.84	30.57	0.27

**UMTS-FDD BandII PK-AV POWER(PART 24E)**

Frequency (MHz)	Conducted power(dBm)		Peak-Average Ratio(PAR)
	Peak	Average	
1852.4	26.64	23.45	3.19
1880	26.67	23.51	3.16
1907.6	26.62	23.53	3.09

Test Report	15050044-FCC-R1
Page	21 of 56

---

## 6.4 Modulation Characteristic

According to FCC § 2.1047(d), Part 22H, Part24E there is no specific requirement for digital modulation, therefore modulation characteristic is not presented.

## 6.5 Occupied Bandwidth

Temperature	23°C
Relative Humidity	54%
Atmospheric Pressure	1030mbar
Test date :	October 30, 2015
Tested By :	Winnie Zhang

### Requirement(s):

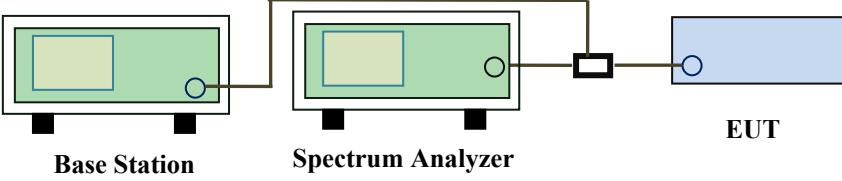
Spec	Item	Requirement	Applicable
§2.1049, §22.917, §22.905 §24.238 §27.53(a)	a)	99% Occupied Bandwidth(kHz)	<input checked="" type="checkbox"/>
	b)	26 dB Bandwidth(kHz)	<input checked="" type="checkbox"/>
Test Setup	 <p style="text-align: center;">Base Station      Spectrum Analyzer      EUT</p>		
Test Procedure	<ul style="list-style-type: none"> <li>- The EUT was connected to Spectrum Analyzer and Base Station via power divider.</li> <li>- The 99% and 26 dB occupied bandwidth (BW) of the middle channel for the highest RF powers.</li> </ul>		
Remark			
Result	<input checked="" type="checkbox"/> Pass <input type="checkbox"/> Fail		

Test Data     Yes       N/A

Test Plot     Yes (See below)       N/A

### Cellular Band (Part 22H) result

Channel	Frequency (MHz)	99% Occupied Bandwidth (kHz)	26 dB Bandwidth (kHz)
128	824.2	247.1228	313.178
190	836.6	250.399	318.525
251	848.8	248.200	320.038

### PCS Band (Part 24E) result

Channel	Frequency (MHz)	99% Occupied Bandwidth (kHz)	26 dB Bandwidth (kHz)
512	1850.2	249.2090	326.113
661	1880.0	245.6800	313.743
810	1909.8	247.3137	321.869

### UMTS-FDD Band V (Part 22H)

Channel	Frequency (MHz)	99% Occupied Bandwidth (MHz)	26 dB Bandwidth (MHz)
4132	826.4	4.2221	4.901
4175	835.0	4.1743	4.858
4233	846.6	4.2008	4.862

### UMTS-FDD Band II (Part 24E)

Channel	Frequency (MHz)	99% Occupied Bandwidth (MHz)	26 dB Bandwidth (MHz)
9262	1852.4	4.1969	4.900
9400	1880.0	4.2039	4.869
9538	1907.6	4.2184	4.878

### Test Plots

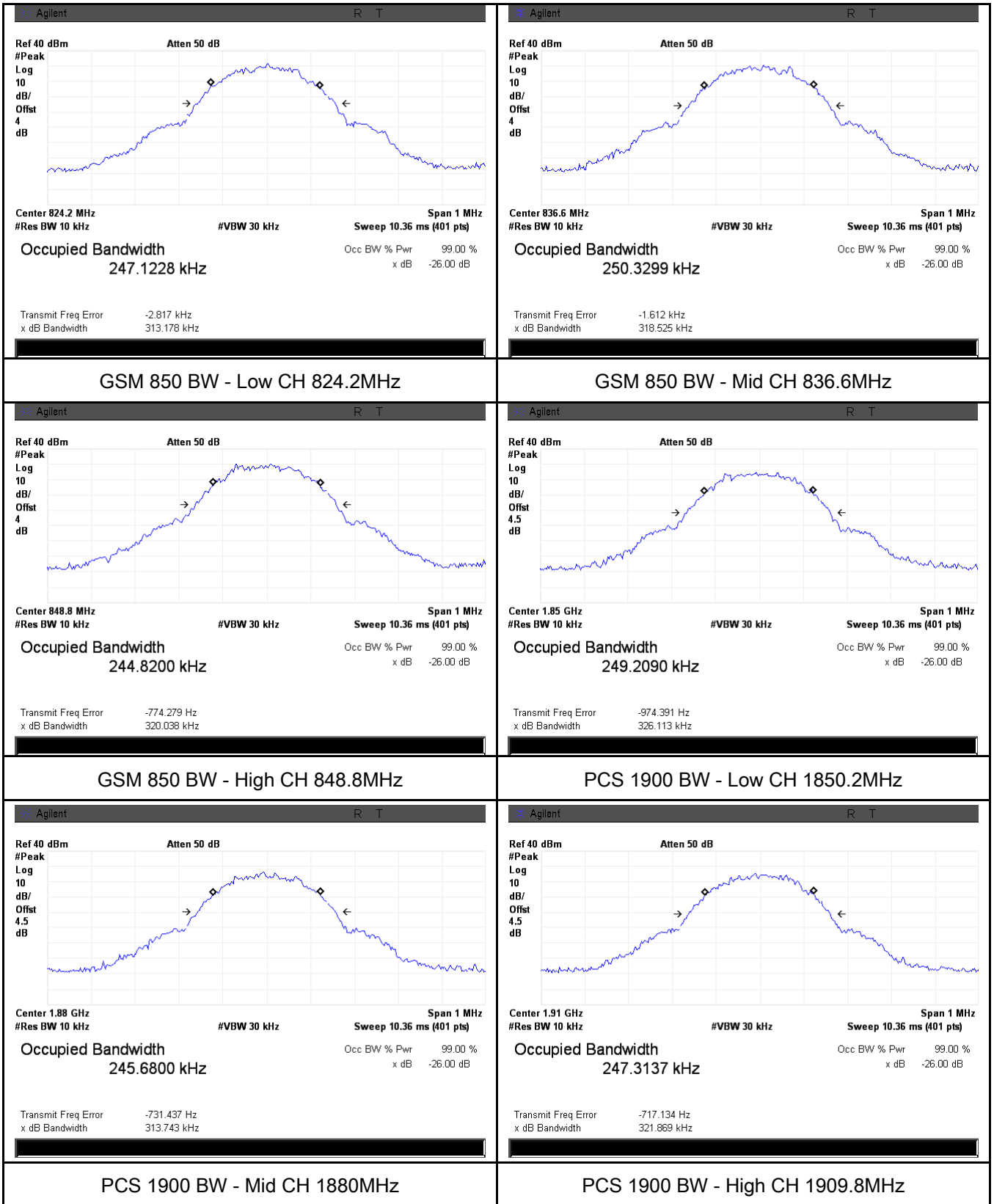



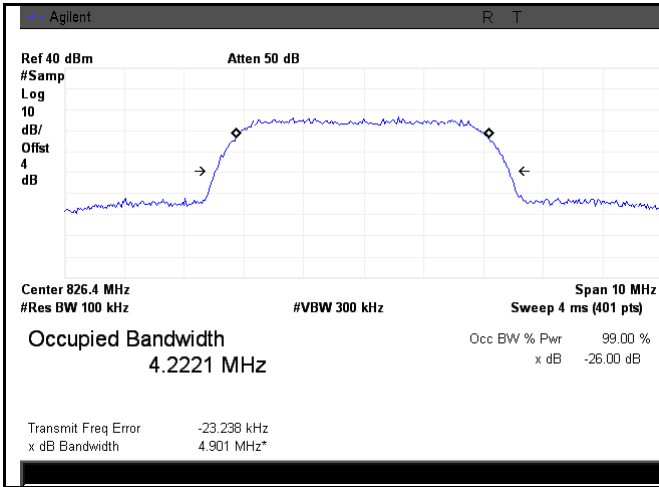

Band V BW - Low CH 826.6 MHz

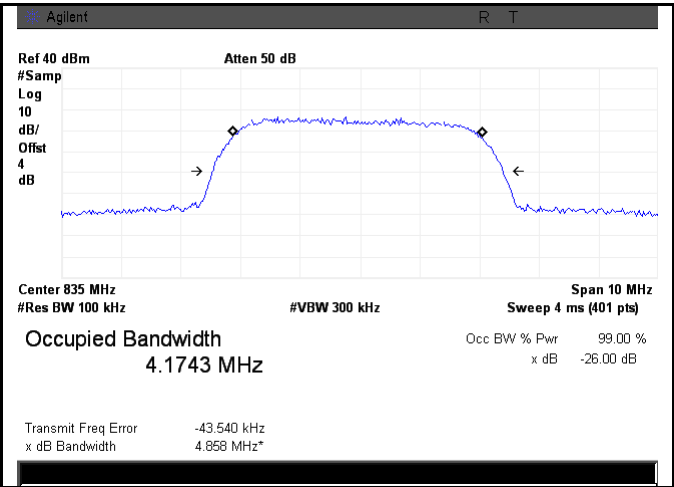

Band V BW - Mid CH 835.0 MHz

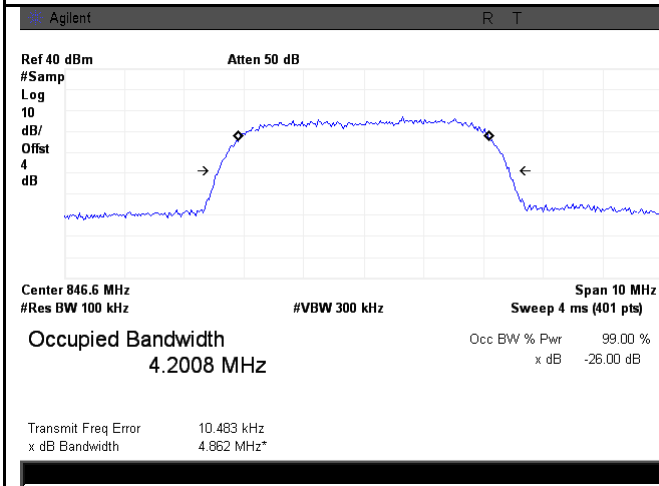

Band V BW - High CH 846.4 MHz

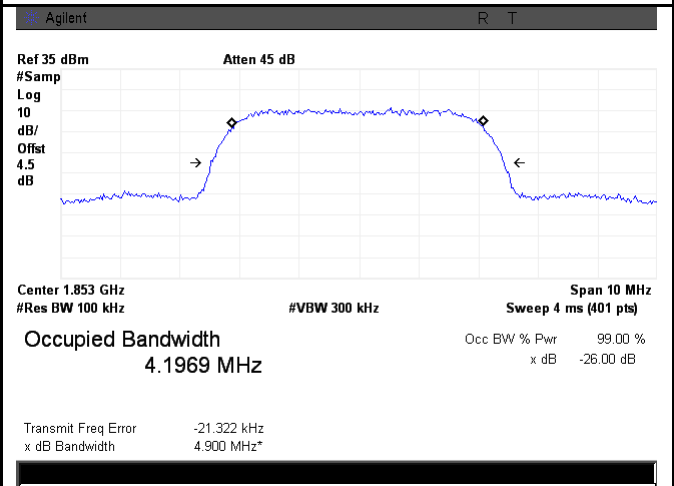

Band II BW - Low CH 1852.4MHz

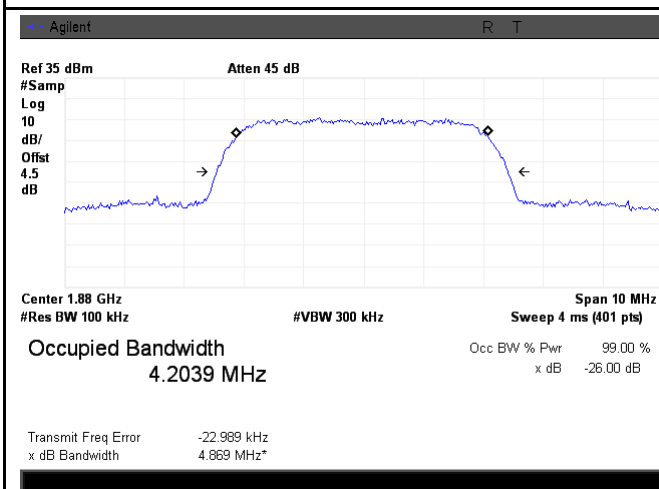

Band II BW - Mid CH 1880MHz

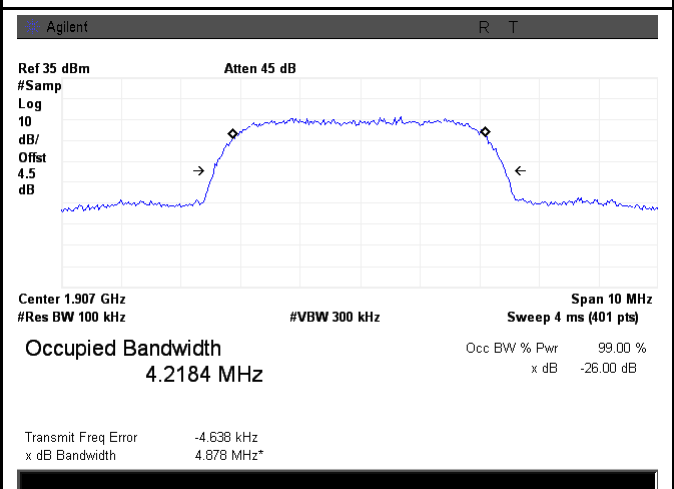

Band II BW - High CH 1907.6MHz

## 6.6 Spurious Emissions at Antenna Terminals

Temperature	23°C
Relative Humidity	54%
Atmospheric Pressure	1030mbar
Test date :	October 30, 2015
Tested By :	Winnie Zhang

### Requirement(s):

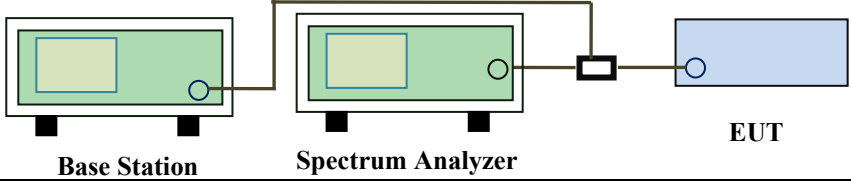
Spec	Item	Requirement	Applicable
§2.1051, §22.917(a)& §24.238(a) § 27.53(h)	a)	The power of any emission outside of the authorized operating frequency ranges must be lower than the transmitter power (P) by a factor of at least $43 + 10 \log (P)$ dB	<input checked="" type="checkbox"/>
Test Setup	 <p>The diagram illustrates the test setup. On the left is a green box labeled 'Base Station'. In the middle is a green box labeled 'Spectrum Analyzer'. On the right is a blue box labeled 'EUT'. A power divider is connected between the Spectrum Analyzer and the EUT. The Base Station is connected to the Spectrum Analyzer.</p>		
Test Procedure	<ul style="list-style-type: none"> <li>- The EUT was connected to Spectrum Analyzer and Base Station via power divider.</li> <li>- The Band Edges of low and high channels for the highest RF powers were measured.</li> <li>- Setting RBW as roughly BW/100.</li> </ul>		
Remark			
Result	<input checked="" type="checkbox"/> Pass <input type="checkbox"/> Fail		

Test Data     Yes       N/A  
 Test Plot     Yes (See below)       N/A

**Test Plots**

**Cellular Band (Part 22H) result**

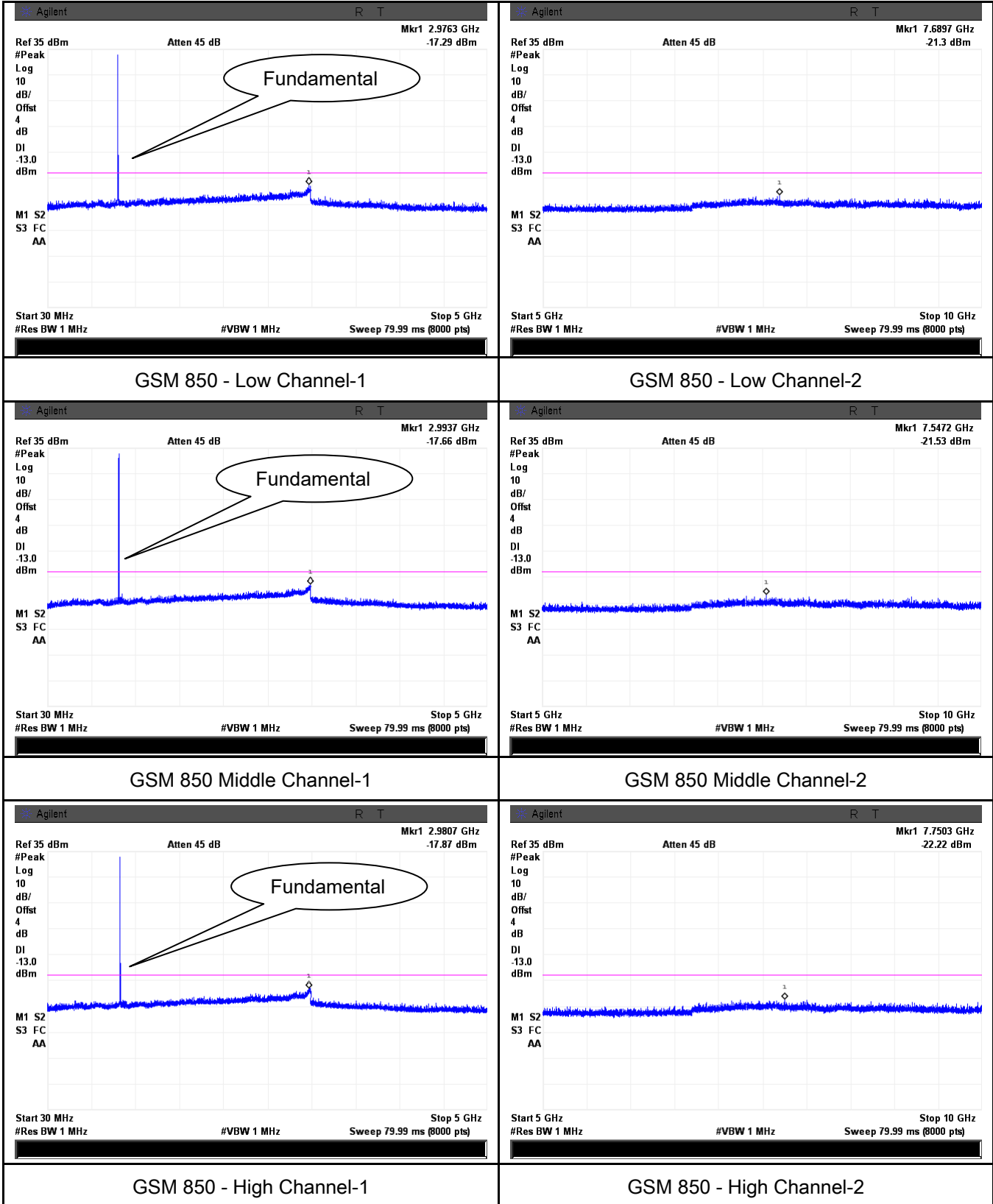

### PCS Band (Part24E) result

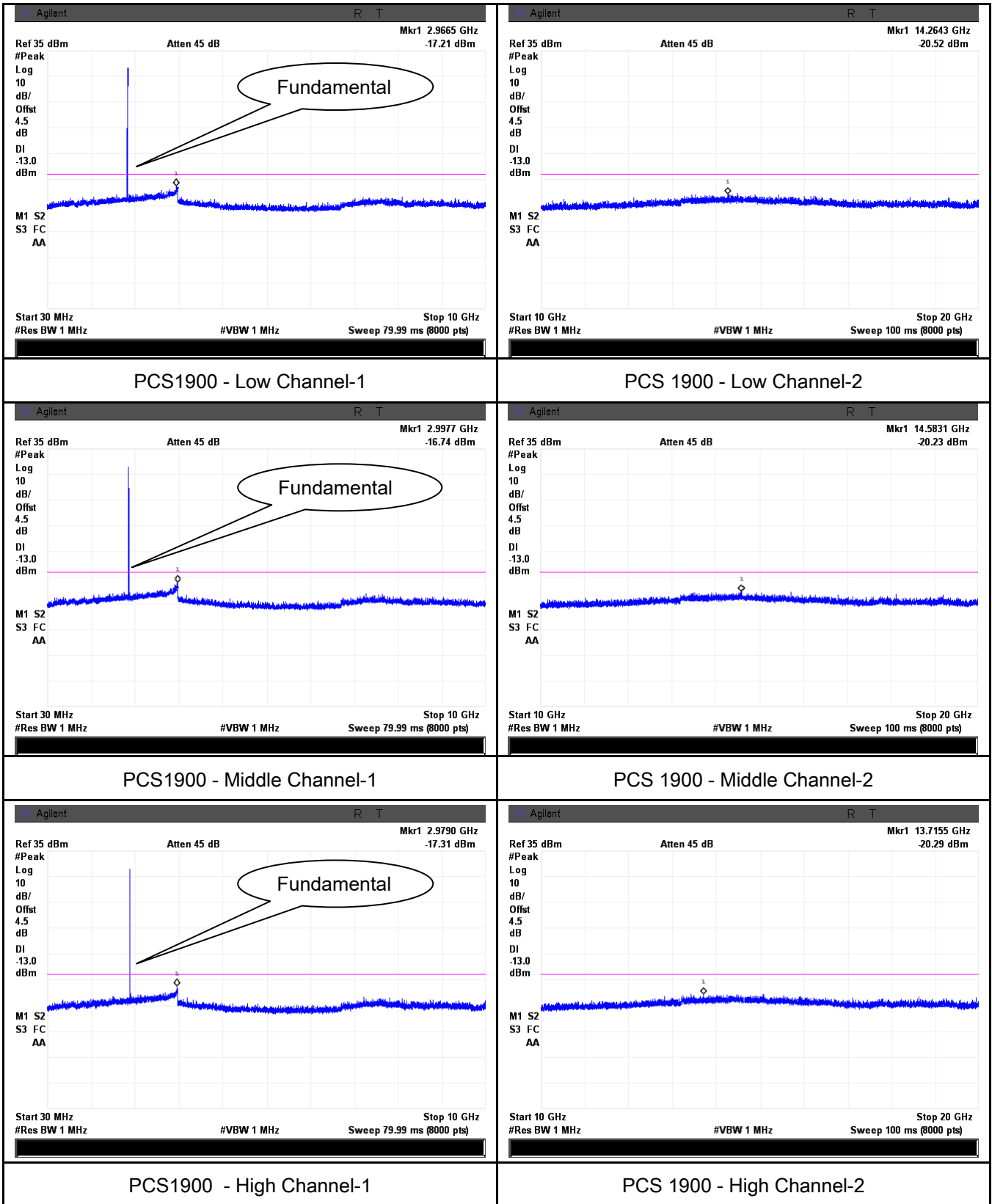

**UMTS-FDD Band V (Part 22H)**

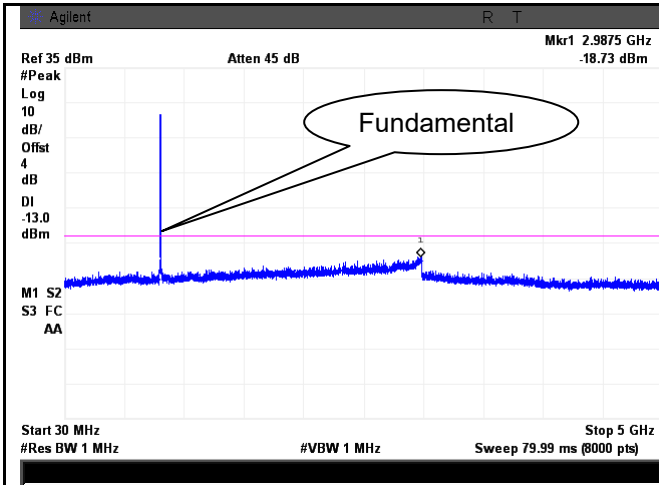

**Band V - Low Channel-1**

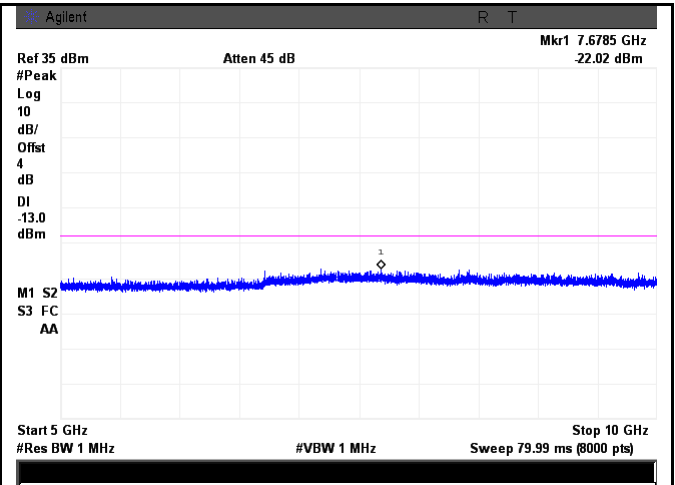

**Band V - Low Channel-2**

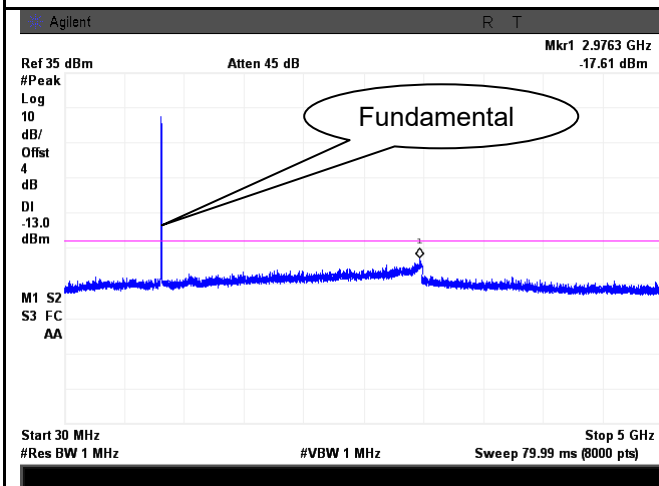

**Band V - Middle Channel-1**

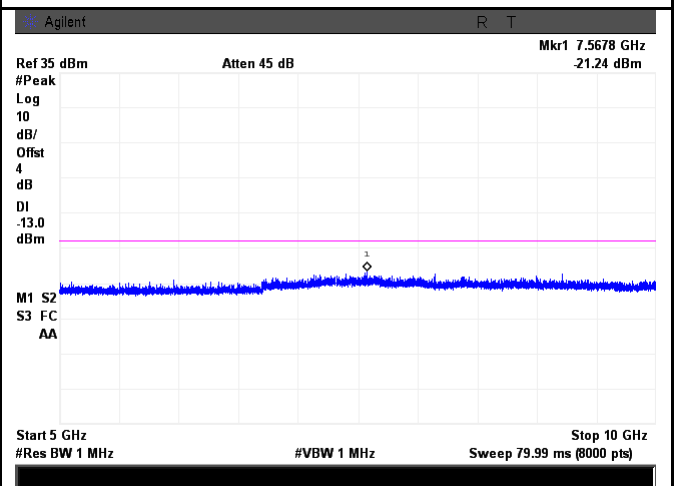

**Band V - Middle Channel-2**

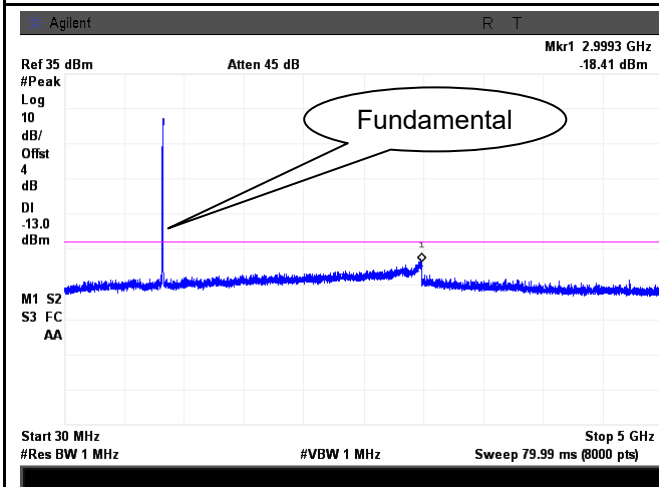

**Band V - High Channel-1**

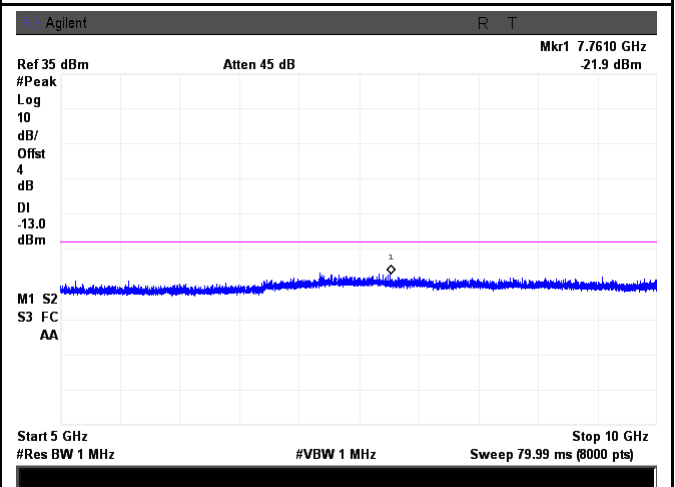

**Band V - High Channel-2**

### UMTS-FDD Band II (Part 24E)

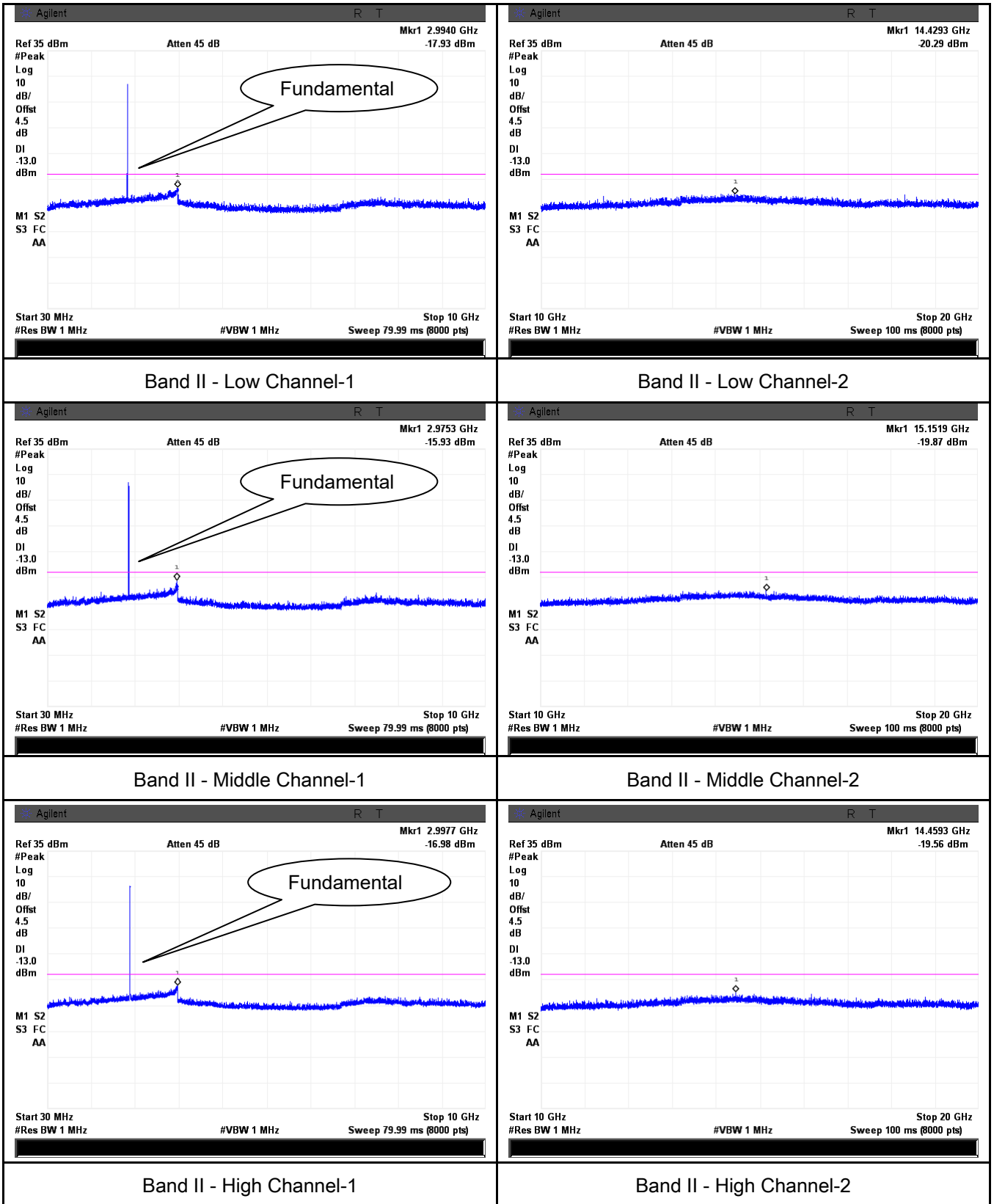

## 6.7 Spurious Radiated Emissions

Temperature	23°C
Relative Humidity	52%
Atmospheric Pressure	1010mbar
Test date :	November 10, 2015
Tested By :	Winnie Zhang

### Requirement(s):

Spec	Item	Requirement	Applicable
§2.1053, §22.917 & §24.238 § 27.53(h)	a)	The power of any emission outside of the authorized operating frequency ranges must be attenuated below the transmitter power (P) by a factor of at least $43 + 10 \log (P)$ dB. The spectrum is scanned from 30 MHz up to a frequency including its 10th harmonic.	<input checked="" type="checkbox"/>

Test setup	
------------	--

Test Procedure	<ol style="list-style-type: none"> <li>The transmitter was placed on a wooden turntable, and it was transmitting into a non-radiating load which was also placed on the turntable.</li> <li>The measurement antenna was placed at a distance of 3 meters from the EUT. During the tests, the antenna height and polarization as well as EUT azimuth were varied in order to identify the maximum level of emissions from the EUT. The test was performed by placing the EUT on 3-orthogonal axis.</li> <li>Remove the EUT and replace it with substitution antenna. A signal generator was connected to the substitution antenna by a non-radiating cable. The absolute levels of the spurious emissions were measured by the substitution.</li> </ol> <p>Sample Calculation:</p> <p>EUT Field Strength = Raw Amplitude (dB<math>\mu</math>V/m) – Amplifier Gain (dB) + Antenna Factor (dB) + Cable Loss (dB) + Filter Attenuation (dB, if used)</p>
----------------	--

Remark	
Result	<input checked="" type="checkbox"/> Pass <input type="checkbox"/> Fail

Test Data  Yes  N/A

Test Plot  Yes (See below)  N/A

### Cellular Band (Part 22H) result

#### Low channel

Frequency (MHz)	Substituted level (dBm)	Polarity (H/V)	Antenna Gain Correction (dB)	Cable Loss (dB)	Corrected Reading (dBm)	Limit (dBm)	Margin (dB)
1648.4	-42.18	V	7.95	0.78	-35.01	-13	-22.01
1648.4	-42.93	H	7.95	0.78	-35.76	-13	-22.76
305.9	-51.27	V	6.2	0.25	-45.32	-13	-32.32
648.2	-51.72	H	6.6	0.39	-45.51	-13	-32.51

#### Middle channel

Frequency (MHz)	Substituted level (dBm)	Polarity (H/V)	Antenna Gain Correction (dB)	Cable Loss (dB)	Corrected Reading (dBm)	Limit (dBm)	Margin (dB)
1673.2	-42.21	V	7.95	0.78	-35.04	-13	-22.04
1673.2	-42.89	H	7.95	0.78	-35.72	-13	-22.72
305.3	-51.33	V	6.2	0.25	-45.38	-13	-32.38
648.5	-51.78	H	6.6	0.39	-45.57	-13	-32.57

#### High channel

Frequency (MHz)	Substituted level (dBm)	Polarity (H/V)	Antenna Gain Correction (dB)	Cable Loss (dB)	Corrected Reading (dBm)	Limit (dBm)	Margin (dB)
1697.6	-42.18	V	7.95	0.78	-35.01	-13	-22.01
1697.6	-42.95	H	7.95	0.78	-35.78	-13	-22.78
305.7	-51.27	V	6.2	0.25	-45.32	-13	-32.32



Test Report	15050044-FCC-R1
Page	33 of 56

1697.6	-42.18	V	7.95	0.78	-35.01	-13	-22.01
--------	--------	---	------	------	--------	-----	--------

## PCS Band (Part24E) result

### Low channel

Frequency (MHz)	Substituted level (dBm)	Polarity (H/V)	Antenna Gain Correction (dB)	Cable Loss (dB)	Corrected Reading (dBm)	Limit (dBm)	Margin (dB)
3700.4	-48.27	V	10.25	2.73	-40.75	-13	-27.75
3700.4	-48.81	H	10.25	2.73	-41.29	-13	-28.29
306.7	-52.75	V	6.2	0.25	-46.80	-13	-33.80
649.2	-53.12	H	6.6	0.39	-46.91	-13	-33.91

### Middle channel

Frequency (MHz)	Substituted level (dBm)	Polarity (H/V)	Antenna Gain Correction (dB)	Cable Loss (dB)	Corrected Reading (dBm)	Limit (dBm)	Margin (dB)
3760	-48.22	V	10.25	2.73	-40.70	-13	-27.70
3760	-48.76	H	10.25	2.73	-41.24	-13	-28.24
306.3	-52.71	V	6.2	0.25	-46.76	-13	-33.76
649.5	-53.19	H	6.6	0.39	-46.98	-13	-33.98

### High channel

Frequency (MHz)	Substituted level (dBm)	Polarity (H/V)	Antenna Gain Correction (dB)	Cable Loss (dB)	Corrected Reading (dBm)	Limit (dBm)	Margin (dB)
3819.6	-48.27	V	10.36	2.73	-40.64	-13	-27.64
3819.6	-48.84	H	10.36	2.73	-41.21	-13	-28.21
306.8	-52.79	V	6.2	0.25	-46.84	-13	-33.84
649.1	-53.25	H	6.6	0.39	-47.04	-13	-34.04

### UMTS-FDD Band V (Part 22H)

#### Low channel

Frequency (MHz)	Substituted level (dBm)	Polarity (H/V)	Antenna Gain Correction (dB)	Cable Loss (dB)	Corrected Reading (dBm)	Limit (dBm)	Margin (dB)
1652.8	-45.61	V	7.95	0.78	-38.44	-13	-25.44
1652.8	-46.27	H	7.95	0.78	-39.10	-13	-26.10
305.2	-52.33	V	6.2	0.25	-46.38	-13	-33.38
648.3	-52.98	H	6.6	0.39	-46.77	-13	-33.77

#### Middle channel

Frequency (MHz)	Substituted level (dBm)	Polarity (H/V)	Antenna Gain Correction (dB)	Cable Loss (dB)	Corrected Reading (dBm)	Limit (dBm)	Margin (dB)
1670	-45.59	V	7.95	0.78	-38.42	-13	-25.42
1670	-46.22	H	7.95	0.78	-39.05	-13	-26.05
305.7	-52.38	V	6.2	0.25	-46.43	-13	-33.43
648.9	-52.91	H	6.6	0.39	-46.70	-13	-33.70

#### High channel

Frequency (MHz)	Substituted level (dBm)	Polarity (H/V)	Antenna Gain Correction (dB)	Cable Loss (dB)	Corrected Reading (dBm)	Limit (dBm)	Margin (dB)
1693.2	-45.64	V	7.95	0.78	-38.47	-13	-25.47
1693.2	-46.28	H	7.95	0.78	-39.11	-13	-26.11
305.3	-52.41	V	6.2	0.25	-46.46	-13	-33.46
648.7	-52.95	H	6.6	0.39	-46.74	-13	-33.74

### UMTS-FDD Band II (Part 24E)

#### Low channel

Frequency (MHz)	Substituted level (dBm)	Polarity (H/V)	Antenna Gain Correction (dB)	Cable Loss (dB)	Corrected Reading (dBm)	Limit (dBm)	Margin (dB)
3704.8	-47.93	V	10.25	2.73	-40.41	-13	-27.41
3704.8	-48.58	H	10.25	2.73	-41.06	-13	-28.06
306.4	-53.41	V	6.2	0.25	-47.46	-13	-34.46
649.3	-53.98	H	6.6	0.39	-47.77	-13	-34.77

#### Middle channel

Frequency (MHz)	Substituted level (dBm)	Polarity (H/V)	Antenna Gain Correction (dB)	Cable Loss (dB)	Corrected Reading (dBm)	Limit (dBm)	Margin (dB)
3760	-47.86	V	10.25	2.73	-40.34	-13	-27.34
3760	-48.62	H	10.25	2.73	-41.10	-13	-28.1
306.7	-53.35	V	6.2	0.25	-47.40	-13	-34.4
649.5	-53.91	H	6.6	0.39	-47.70	-13	-34.7

#### High channel

Frequency (MHz)	Substituted level (dBm)	Polarity (H/V)	Antenna Gain Correction (dB)	Cable Loss (dB)	Corrected Reading (dBm)	Limit (dBm)	Margin (dB)
3815.2	-47.82	V	10.36	2.73	-40.19	-13	-27.19
3815.2	-48.53	H	10.36	2.73	-40.90	-13	-27.90
306.8	-53.27	V	6.2	0.25	-47.32	-13	-34.32
649.1	-53.88	H	6.6	0.39	-47.67	-13	-34.67

## 6.8 Band Edge

Temperature	23°C
Relative Humidity	54%
Atmospheric Pressure	1030mbar
Test date :	October 30, 2015
Tested By :	Winnie Zhang

### Requirement(s):

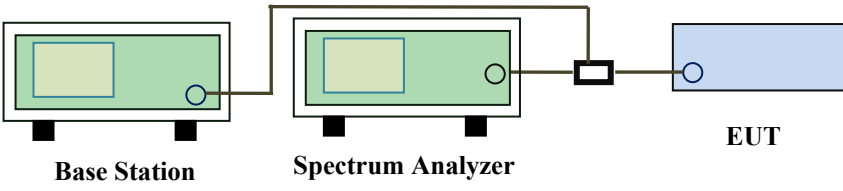
Spec	Item	Requirement	Applicable
§22.917(a) §24.238(a) § 27.53(h)	a)	The power of any emission outside of the authorized operating frequency ranges must be lower than the transmitter power (P) by a factor of at least $43 + 10 \log (P)$ dB.	<input checked="" type="checkbox"/>
Test setup	 <p>The diagram shows a Base Station (green box) connected to a Spectrum Analyzer (green box) and an EUT (blue box) via a power divider (black box). The Base Station and Spectrum Analyzer are connected to the power divider, which then splits the signal to the Spectrum Analyzer and the EUT.</p>		
Procedure	<ul style="list-style-type: none"> <li>- The EUT was connected to Spectrum Analyzer and Base Station via power divider.</li> <li>- The Band Edges of low and high channels for the highest RF powers were measured. Setting RBW as roughly BW/100.</li> </ul>		
Remark			
Result	<input checked="" type="checkbox"/> Pass <input type="checkbox"/> Fail		

Test Data  Yes       N/A

Test Plot  Yes (See below)       N/A

### Cellular Band (Part 22H) result

Frequency (MHz)	Emission (dBm)	Limit (dBm)
823.9950	-14.15	-13
849.0175	-13.64	-13

### PCS Band (Part24E) result

Frequency (MHz)	Emission (dBm)	Limit (dBm)
1849.9950	-15.40	-13
1910.0175	-16.58	-13

### UMTS-FDD Band V (Part 22H)

Frequency (MHz)	Emission (dBm)	Limit (dBm)
823.9000	-26.94	-13
849.2000	-26.87	-13

### UMTS-FDD Band IV (Part 27)

Frequency (MHz)	Emission (dBm)	Limit (dBm)
1849.8500	-26.49	-13
1910.0500	-26.21	-13

**Test Plots**

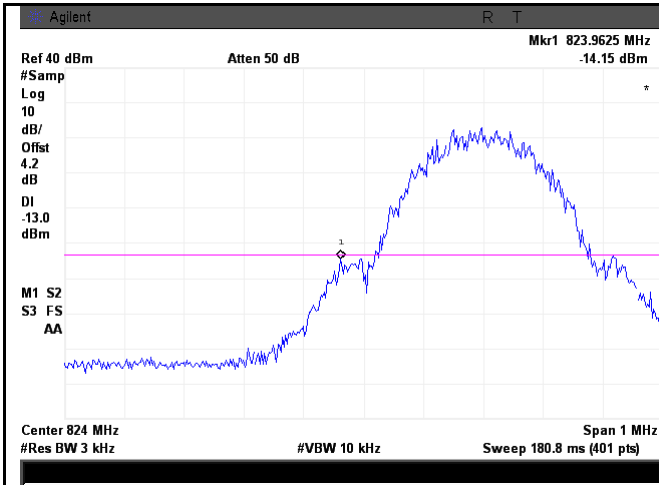

Cellular Band - Low Channel

Note: Offset=Cable loss (4.0) + 10log  
(3.13/3)=4.0+0.2=4.2dB

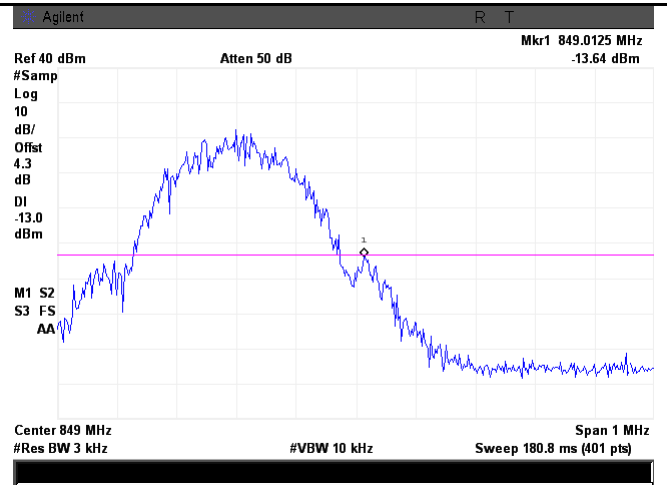

Cellular Band - High Channel

Note: Offset=Cable loss (4.0) + 10log  
(3.20/3)=4.0+0.3=4.3dB

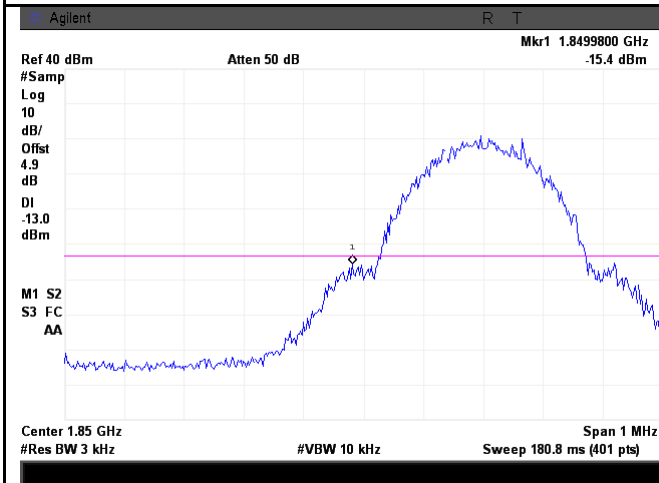

PCS Band - Low Channel

Note: Offset=Cable loss (4.5) + 10log  
(3.26/3)=4.5+0.4=4.9dB

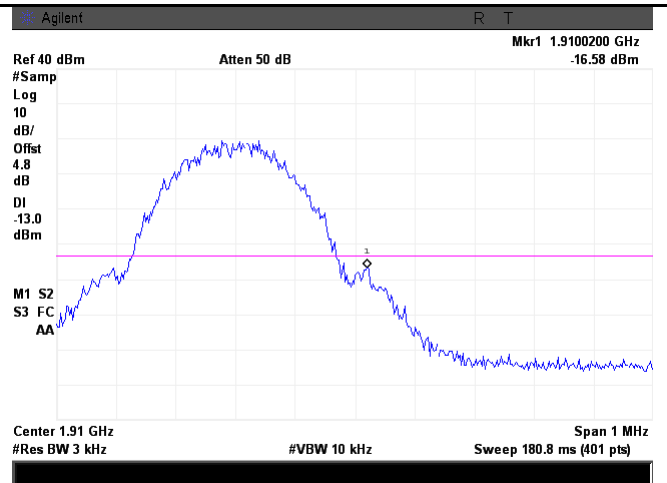

PCS Band - High Channel

Note: Offset=Cable loss (4.5) + 10log  
(3.21/3)=4.5+0.3=4.8dB

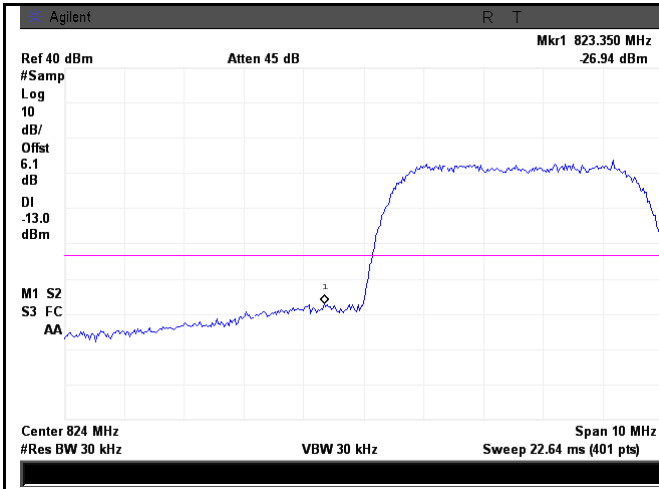

UMTS-FDD Band V - Low Channel

Note: Offset=Cable loss (4.0) + 10log  
(49.01/30)=4.0+2.1=6.1 dB

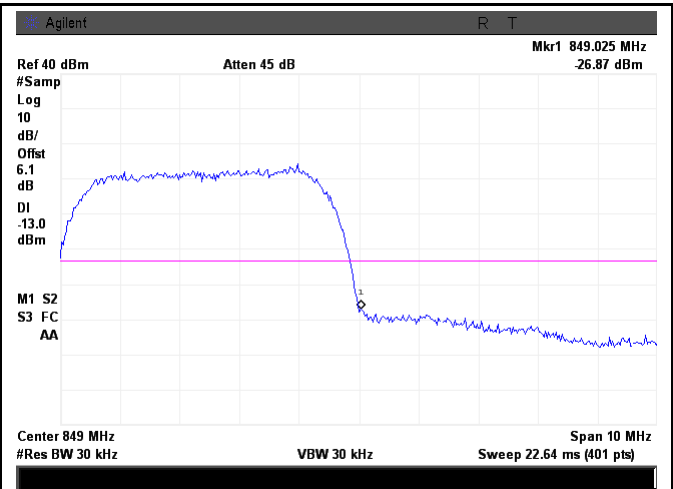

UMTS-FDD Band V - High Channel

Note: Offset=Cable loss (4.0) + 10log  
(48.62/30)=4.0+2.1=6.1 dB

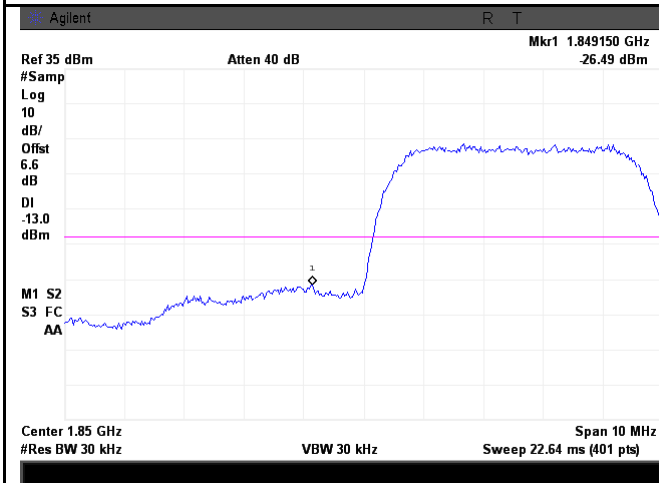

UMTS-FDD Band II - Low Channel

Note: Offset=Cable loss (4.5) + 10log  
(49.00/30)=4.5+2.1=6.1 dB

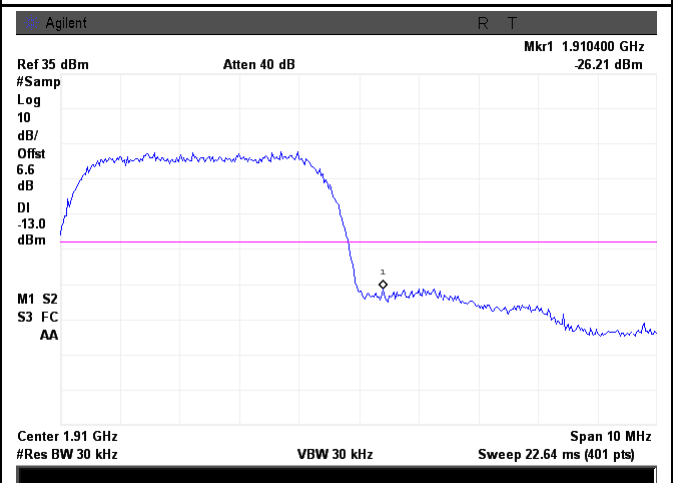

UMTS-FDD Band II - High Channel

Note: Offset=Cable loss (4.5) + 10log  
(48.78/30)=4.5+2.1=6.1 dB



## 6.9 Frequency Stability

Temperature	23°C
Relative Humidity	52%
Atmospheric Pressure	1010mbar
Test date :	November 10, 2015
Tested By :	Winnie Zhang

### Requirement(s):

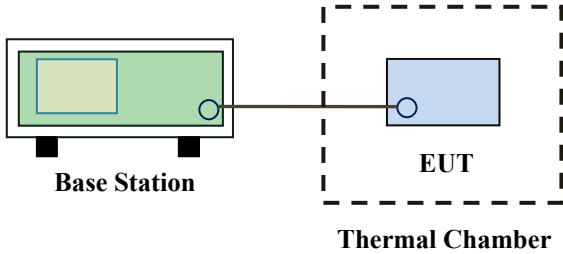
Spec	Item	Requirement	Applicable																																
§2.1055, §22.355 & §24.235 § 27.5(h); § 27.54	a)	According to §22.355, the carrier frequency of each transmitter in the Public Mobile Services must be maintained within the tolerances given in Table below:  Frequency Tolerance for Transmitters in the Public Mobile Services	<input checked="" type="checkbox"/>																																
		<table border="1"> <thead> <tr> <th>Frequency Range (MHz)</th> <th>Base, fixed (ppm)</th> <th>Mobile ≤ 3 watts (ppm)</th> <th>Mobile ≤ 3 watts (ppm)</th> </tr> </thead> <tbody> <tr> <td>25 to 50</td> <td>20.0</td> <td>20.0</td> <td>50.0</td> </tr> <tr> <td>50 to 450</td> <td>5.0</td> <td>5.0</td> <td>50.0</td> </tr> <tr> <td>45 to 512</td> <td>2.5</td> <td>5.0</td> <td>.0</td> </tr> <tr> <td>821 to 896</td> <td>1.5</td> <td>2.5</td> <td>2.5</td> </tr> <tr> <td>928 to 29.</td> <td>5.0</td> <td>N/A</td> <td>N/A</td> </tr> <tr> <td>929 to 960.</td> <td>1.5</td> <td>N/A</td> <td>N/A</td> </tr> <tr> <td>2110 to 2220</td> <td>10.0</td> <td>N/A</td> <td>N/A</td> </tr> </tbody> </table>		Frequency Range (MHz)	Base, fixed (ppm)	Mobile ≤ 3 watts (ppm)	Mobile ≤ 3 watts (ppm)	25 to 50	20.0	20.0	50.0	50 to 450	5.0	5.0	50.0	45 to 512	2.5	5.0	.0	821 to 896	1.5	2.5	2.5	928 to 29.	5.0	N/A	N/A	929 to 960.	1.5	N/A	N/A	2110 to 2220	10.0	N/A	N/A
		Frequency Range (MHz)		Base, fixed (ppm)	Mobile ≤ 3 watts (ppm)	Mobile ≤ 3 watts (ppm)																													
		25 to 50		20.0	20.0	50.0																													
		50 to 450		5.0	5.0	50.0																													
		45 to 512		2.5	5.0	.0																													
		821 to 896		1.5	2.5	2.5																													
		928 to 29.		5.0	N/A	N/A																													
929 to 960.	1.5	N/A	N/A																																
2110 to 2220	10.0	N/A	N/A																																
According to §24.235, the frequency stability shall be sufficient to ensure that the fundamental emissions stay within the authorized frequency block.																																			
 <p style="text-align: center;"> <span>Base Station</span> <span style="margin-left: 150px;">EUT</span>  <span style="margin-left: 150px;">Thermal Chamber</span> </p>																																			

Test Report	15050044-FCC-R1
Page	42 of 56

Procedure	A communication link was established between EUT and base station. The frequency error was monitored and measured by base station under variation of ambient temperature and variation of primary supply voltage.  Limit: The frequency stability of the transmitter shall be maintained within $\pm 0.00025\%$ ( $\pm 2.5\text{ppm}$ ) of the center frequency.
Remark	
Result	<input checked="" type="checkbox"/> Pass <input type="checkbox"/> Fail

Test Data     Yes                       N/A

Test Plot     Yes (See below)             N/A

### Cellular Band (Part 22H) result

Middle Channel, $f_0 = 836.6$ MHz				
Temperature (°C)	Power Supplied (V <sub>DC</sub> )	Frequency Error (Hz)	Frequency Error (ppm)	Limit (ppm)
-10	3.7	19	0.0227	2.5
0		18	0.0215	2.5
10		14	0.0167	2.5
20		16	0.0191	2.5
30		15	0.0179	2.5
40		20	0.0239	2.5
50		23	0.0275	2.5
55		29	0.0347	2.5
25		4.2	23	0.0275
	3.5	25	0.0299	2.5

### PCS Band (Part 24E) result

Middle Channel, $f_0 = 1880$ MHz				
Temperature (°C)	Power Supplied (V <sub>DC</sub> )	Frequency Error (Hz)	Frequency Error (ppm)	Limit (ppm)
-10	3.7	29	0.0154	2.5
0		23	0.0122	2.5
10		27	0.0144	2.5
20		18	0.0096	2.5
30		15	0.0080	2.5
40		12	0.0064	2.5
50		20	0.0106	2.5
55		15	0.0080	2.5
25		4.2	22	0.0117
	3.5	25	0.0133	2.5

### UMTS-FDD Band V (Part 22H)

Middle Channel, $f_0 = 835$ MHz				
Temperature (°C)	Power Supplied (V <sub>DC</sub> )	Frequency Error (Hz)	Frequency Error (ppm)	Limit (ppm)
-10	3.7	16	0.0192	2.5
0		14	0.0168	2.5
10		17	0.0204	2.5
20		13	0.0156	2.5
30		12	0.0144	2.5
40		18	0.0216	2.5
50		11	0.0132	2.5
55		20	0.0240	2.5
25	4.2	18	0.0216	2.5
	3.5	20	0.0240	2.5

### UMTS-FDD Band II (Part 24E)

Middle Channel, $f_0 = 1880$ MHz				
Temperature (°C)	Power Supplied (V <sub>DC</sub> )	Frequency Error (Hz)	Frequency Error (ppm)	Limit (ppm)
-10	3.7	12	0.0064	2.5
0		10	0.0053	2.5
10		9	0.0048	2.5
20		7	0.0037	2.5
30		5	0.0027	2.5
40		8	0.0043	2.5
50		11	0.0059	2.5
55		17	0.0090	2.5
25	4.2	8	0.0043	2.5
	3.5	11	0.0059	2.5

## Annex A. TEST INSTRUMENT

Instrument	Model	Serial #	Cal Date	Cal Due	In use
<b>RF Conducted Test</b>					
Agilent ESA-E SERIES SPECTRUM ANALYZER	E4407B	MY45108319	09/17/2015	09/16/2016	<input checked="" type="checkbox"/>
Power Splitter	1#	1#	09/01/2015	08/31/2016	<input checked="" type="checkbox"/>
Universal Radio Communication Tester	CMU200	121393	09/25/2015	09/24/2016	<input checked="" type="checkbox"/>
Temperature/Humidity Chamber	UHL-270	001	10/09/2015	10/08/2016	<input checked="" type="checkbox"/>
DC Power Supply	E3640A	MY40004013	09/17/2015	09/16/2016	<input checked="" type="checkbox"/>
<b>Radiated Emissions</b>					
EMI test receiver	ESL6	100262	09/17/2015	09/16/2016	<input checked="" type="checkbox"/>
OPT 010 AMPLIFIER (0.1-1300MHz)	8447E	2727A02430	09/01/2015	08/31/2016	<input checked="" type="checkbox"/>
Microwave Preamplifier (1 ~ 26.5GHz)	8449B	3008A02402	03/25/2015	03/24/2016	<input checked="" type="checkbox"/>
Bilog Antenna (30MHz~6GHz)	JB6	A110712	09/21/2015	09/20/2016	<input checked="" type="checkbox"/>
Bilog Antenna (30MHz~2GHz)	JB1	A112017	09/21/2015	09/20/2016	<input checked="" type="checkbox"/>
Double Ridge Horn Antenna (1 ~18GHz)	AH-118	71259	09/24/2015	09/23/2016	<input checked="" type="checkbox"/>
Double Ridge Horn Antenna (1 ~18GHz)	AH-118	71283	09/24/2015	09/23/2016	<input checked="" type="checkbox"/>
SYNTHESIZED SIGNAL GENERATOR	8665B	3744A01293	09/17/2015	09/16/2016	<input checked="" type="checkbox"/>
Tunable Notch Filter	3NF-800/1000-S	AA4	09/01/2015	08/31/2016	<input checked="" type="checkbox"/>
Tunable Notch Filter	3NF-1000/2000-S	AM 4	09/01/2015	08/31/2016	<input checked="" type="checkbox"/>

**Annex B. EUT And Test Setup Photographs**

**Annex B.i. Photograph: EUT External Photo**

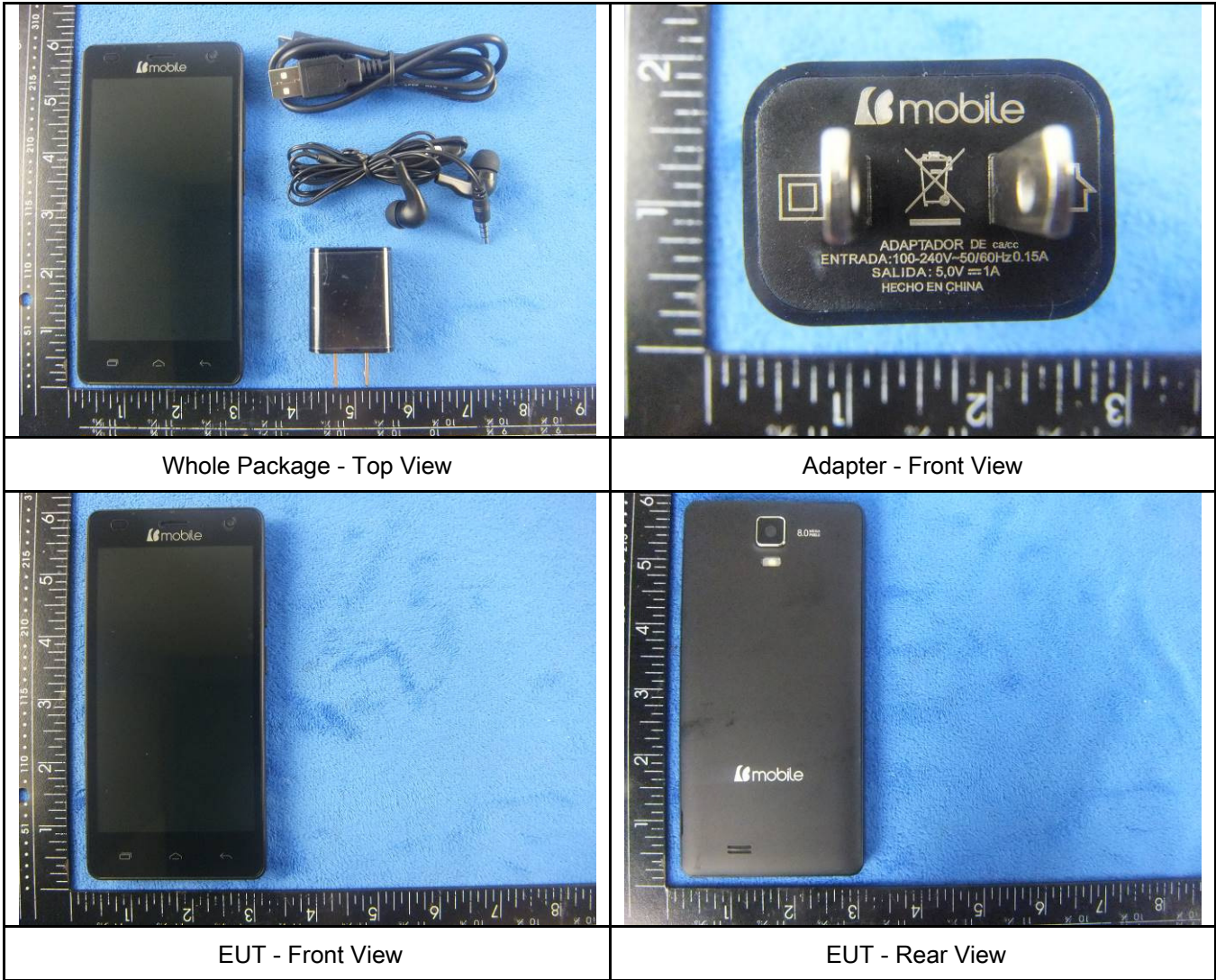

Whole Package - Top View

Adapter - Front View

EUT - Front View

EUT - Rear View



EUT - Top View



EUT - Bottom View

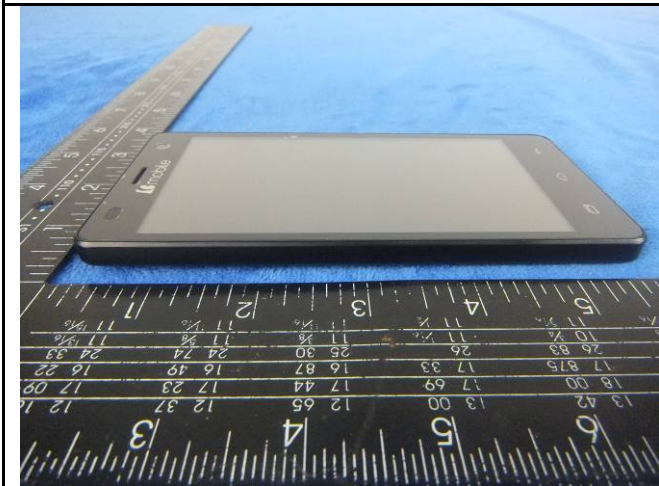

EUT - Left View

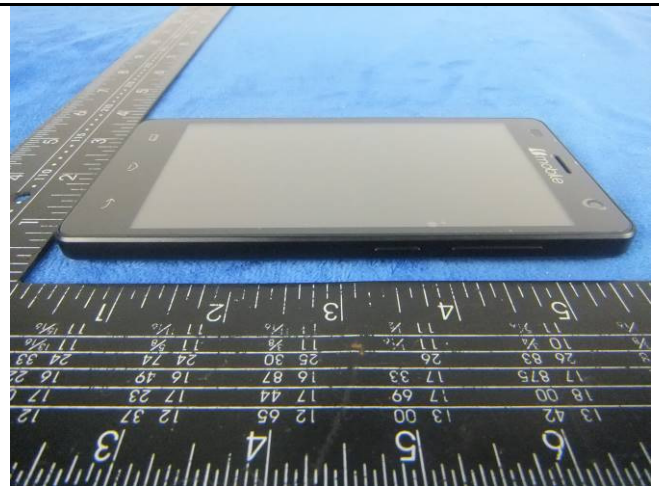

EUT - Right View

**Annex B.ii. Photograph: EUT Internal Photo**



Cover Off - Top View 1



Cover Off - Top View 2



Battery - Top View



Battery - Bottom View

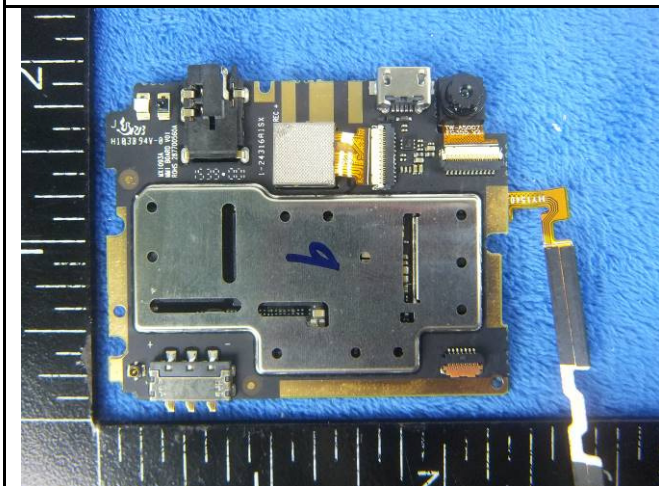

Mainboard with Shielding - Front View



Mainboard with Shielding - Rear View



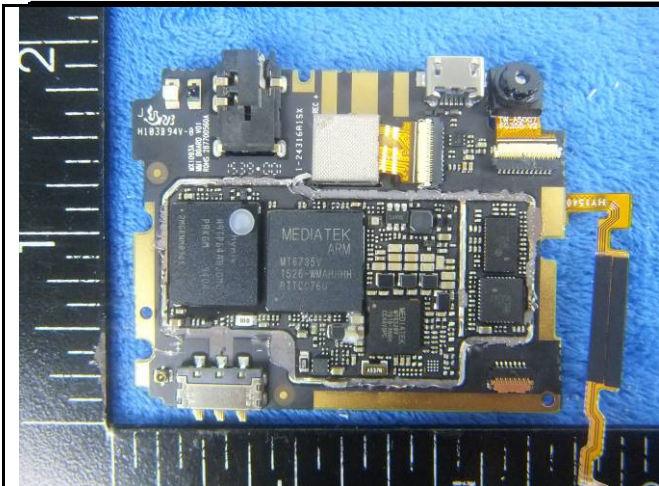

Mainboard without shielding - Front View

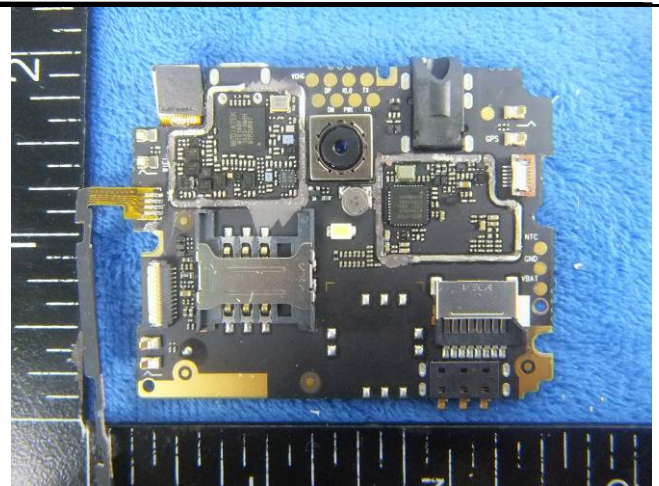

Mainboard without Shielding - Rear View

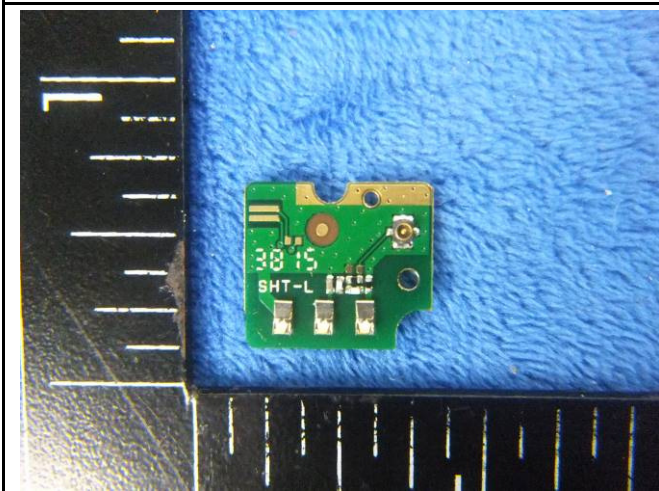

Small Board-Front View

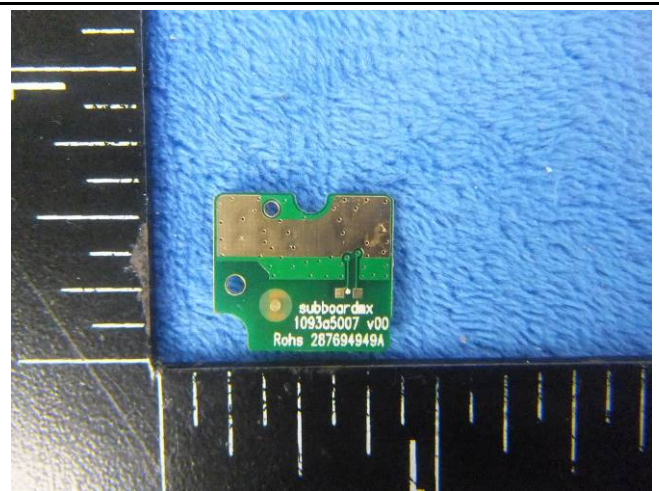

Small Board-Rear View



LCD - Front View

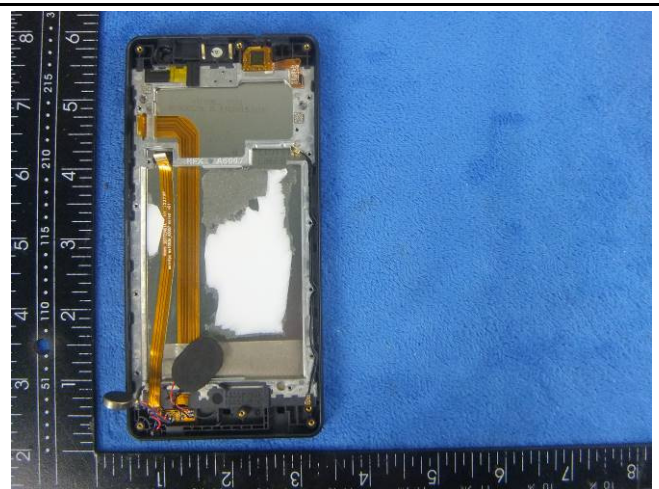

LCD - Rear View



GSM/PCS/UMTS-FDD Antenna View



WIFI/BT/BLE - Antenna View



GPS - Antenna View



LTE- Antenna View

**Annex B.iii. Photograph: Test Setup Photo**

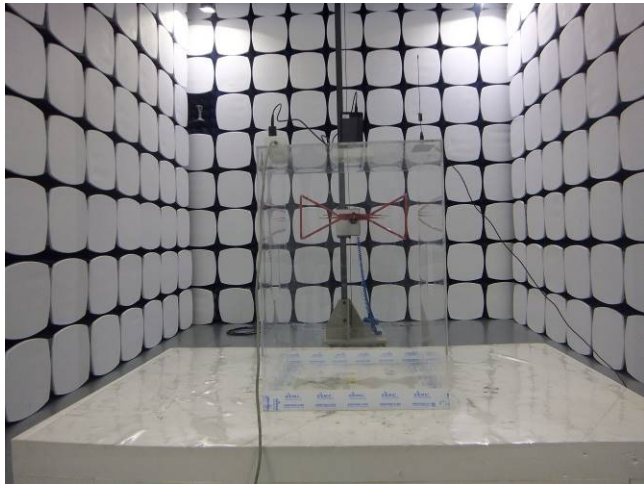

Radiated Spurious Emissions Test Setup Below 1GHz

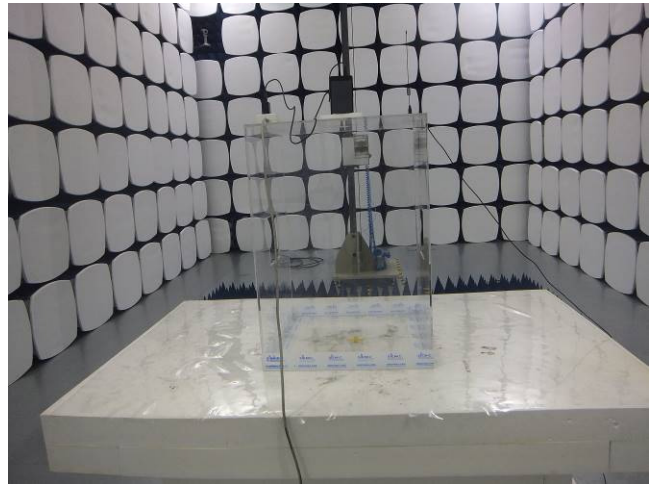

Radiated Spurious Emissions Test Setup Above  
1GHz

## Annex C. TEST SETUP AND SUPPORTING EQUIPMENT

### Annex C.ii. TEST SET UP BLOCK

#### Block Configuration Diagram for Radiated Emissions

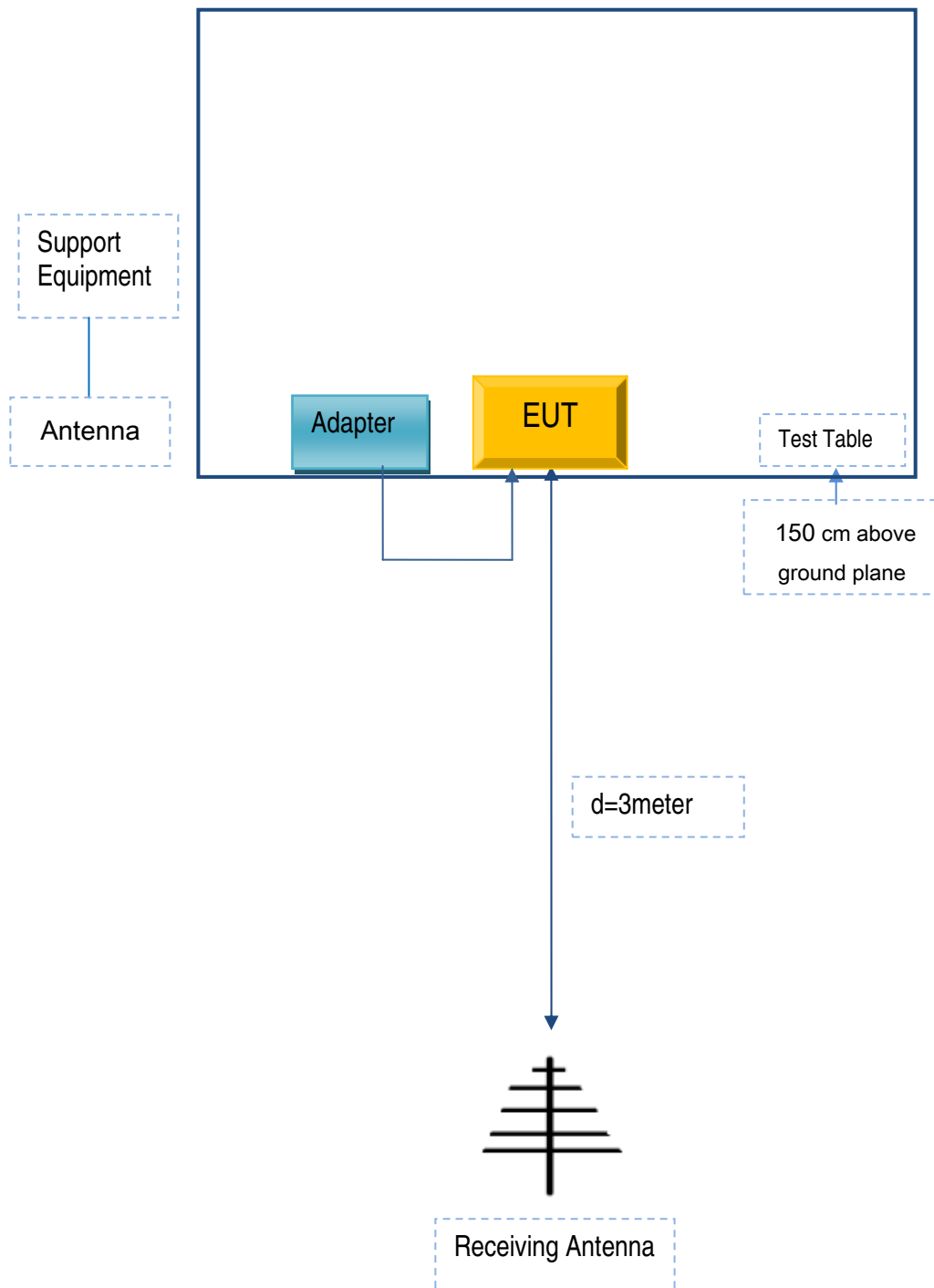

### Annex C. ii. SUPPORTING EQUIPMENT DESCRIPTION

The following is a description of supporting equipment and details of cables used with the EUT.

Manufacturer	Equipment Description	Model	Calibration Date	Calibration Due Date
N/A	N/A	N/A	N/A	N/A

Test Report	15050044-FCC-R1
Page	54 of 56

## Annex C.ii. EUT OPERATING CONKITIONS

N/A

Test Report	15050044-FCC-R1
Page	55 of 56

**Annex D. User Manual / Block Diagram / Schematics / Partlist**

**Please see attachment**

## Annex E. DECLARATION OF SIMILARITY

b Mobile HK Limited

To SIEMIC Inc  
775 Montague Expressway  
Milpitas, CA 95035.

### Statement

We, b Mobile HK Limited apply a multiple-listing certification for the below models.

Product Name: Mobile phone

Model number: AX1050/AX1065/AX1055

FCC ID: ZSW-30-020

We hereby state that these models are identical in interior structure, electrical circuits and components, and just model name is different for the marketing requirement.

Your assistance on this matter is highly appreciated.

*For and on behalf of*  
**b mobile HK Limited**

Sincerely,.....  
*Authorized Signature(s)*  
Name: KA SHING LAM  
Title: Director  
Signature: