

SAR EVALUATION REPORT

For

b mobile HK Limited

Flat 18;14/F Block 1;Golden Industrial Building;16-26 Kwai Tak Street;
Kwai Chung;New Territories; Hong Kong,China

FCC ID: ZSW-30-007

Report Type: Original Report	Product Type: Mobile Phone
Test Engineer: Terry XiaHou	<i>Terry XiaHou</i>
Report Number: RSZ150323006-20	
Report Date: 2015-04-13	
Reviewed By: SAR Engineer	<i>Bell Hu</i>
Prepared By: Bay Area Compliance Laboratories Corp. (Shenzhen) 6/F, the 3rd Phase of WanLi Industrial Building, ShiHua Road, FuTian Free Trade Zone Shenzhen, Guangdong, China Tel: +86-755-33320018 Fax: +86-755-33320008 www.baclcorp.com.cn	

Attestation of Test Results		
EUT Information	Company Name	b mobile HK Limited
	EUT Description	Mobile Phone
	FCC ID	ZSW-30-007
	Model Number	Main test model: AX1060 Adding test model: AX1050
	Test Date	2015-04-10
Frequency	Max. SAR Level(s) Reported	Limit(W/Kg)
GSM 850	0.295 W/kg 1g Head SAR 0.563 W/kg 1g Body SAR	1.6
PCS 1900	0.381 W/kg 1g Head SAR 0.909 W/kg 1g Body SAR	
WCDMA850	0.111 W/kg 1g Head SAR 0.220 W/kg 1g Body SAR	
WCDMA1700	0.144 W/kg 1g Head SAR 0.313 W/kg 1g Body SAR	
WCDMA 1900	0.316 W/kg 1g Head SAR 0.723 W/kg 1g Body SAR	
LTE Band 2	0.273 W/kg 1g Head SAR 0.665 W/kg 1g Body SAR	
LTE Band 4	0.170 W/kg 1g Head SAR 0.378 W/kg 1g Body SAR	
LTE Band 5	0.139 W/kg 1g Head SAR 0.260 W/kg 1g Body SAR	
LTE Band 7	0.183 W/kg 1g Head SAR 0.393 W/kg 1g Body SAR	
LTE Band 17	0.206 W/kg 1g Head SAR 0.342 W/kg 1g Body SAR	
Simultaneous	0.781 W/kg 1g Head SAR 1.109 W/kg 1g Body SAR	
Applicable Standards	ANSI / IEEE C95.1 : 2005 IEEE Standard for Safety Levels with Respect to Human Exposure to Radio Frequency Electromagnetic Fields,3 kHz to 300 GHz.	
	ANSI / IEEE C95.3 : 2002 IEEE Recommended Practice for Measurements and Computations of Radio Frequency Electromagnetic Fields With Respect to Human Exposure to SuchFields,100 kHz—300 GHz.	
	IEEE1528:2013 IEEE Recommended Practice for Determining the Peak Spatial-Average Specific Absorption Rate (SAR) in the Human Head from Wireless Communications Devices: Measurement Techniques	

KDB procedures

- KDB 447498 D01 General RF Exposure Guidance v05r02.
- KDB 648474 D04 Handset SAR v01r02.
- KDB 865664 D01 SAR measurement 100 MHz to 6 GHz v01r03
- KDB 865664 D02 RF Exposure Reporting v01r01
- KDB 941225 D01 3G SAR Procedures v03
- KDB 941225 D05 SAR for LTE Devices v02r03
- KDB 941225 D06 Hotspot Mode v02

Note: This wireless device has been shown to be capable of compliance for localized specific absorption rate (SAR) for General Population/Uncontrolled Exposure limits specified in ANSI/IEEE Standards and has been tested in accordance with the measurement procedures specified in IEEE 1528-2013 and RF exposure KDB procedures.

The results and statements contained in this report pertain only to the device(s) evaluated.

TABLE OF CONTENTS

DOCUMENT REVISION HISTORY	6
EUT DESCRIPTION	7
TECHNICAL SPECIFICATION	7
REFERENCE, STANDARDS, AND GUIDELINES	9
SAR LIMITS	10
FACILITIES.....	11
DESCRIPTION OF TEST SYSTEM	12
EQUIPMENT LIST AND CALIBRATION	19
EQUIPMENTS LIST & CALIBRATION INFORMATION	19
SAR MEASUREMENT SYSTEM VERIFICATION	20
LIQUID VERIFICATION	20
SYSTEM ACCURACY VERIFICATION	27
SAR SYSTEM VALIDATION DATA	28
EUT TEST STRATEGY AND METHODOLOGY	48
TEST POSITIONS FOR DEVICE OPERATING NEXT TO A PERSON’S EAR.....	48
CHEEK/TOUCH POSITION	49
EAR/TILT POSITION	49
TEST POSITIONS FOR BODY-WORN AND OTHER CONFIGURATIONS	50
SAR EVALUATION PROCEDURE.....	51
TEST METHODOLOGY	51
CONDUCTED OUTPUT POWER MEASUREMENT	52
PROVISION APPLICABLE	52
TEST PROCEDURE	52
MAXIMUM OUTPUT POWER AMONG PRODUCTION UNITS	52
TEST RESULTS:	53
SAR MEASUREMENT RESULTS.....	67
SAR TEST DATA.....	67
SAR SIMULTANEOUS TRANSMISSION DESCRIPTION	79
SAR PLOTS (SUMMARY OF THE HIGHEST SAR VALUES)	86
APPENDIX A MEASUREMENT UNCERTAINTY	106
APPENDIX B – PROBE CALIBRATION CERTIFICATES.....	107
APPENDIX C DIPOLE CALIBRATION CERTIFICATES	117
APPENDIX D EUT TEST POSITION PHOTOS	162
LIQUID DEPTH 15CM.....	162
BODY-WORN BACK SETUP PHOTO (10MM)	162
BODY-WORN LEFT SETUP PHOTO (10MM)	163
BODY-WORN RIGHT SETUP PHOTO (10MM)	163
BODY-WORN BOTTOM SETUP PHOTO (10MM)	164
LEFT HEAD TOUCH SETUP PHOTO	164
LEFT HEAD TILT SETUP PHOTO	165
RIGHT HEAD TOUCH SETUP PHOTO	165
RIGHT HEAD TILT SETUP PHOTO	166
APPENDIX E EUT PHOTOS.....	167
EUT – FRONT VIEW.....	167
EUT – BACK VIEW	167

EUT –LEFT SIDE VIEW	168
EUT – RIGHT SIDE VIEW	168
EUT – TOP VIEW	169
EUT – BOTTOM VIEW.....	169
EUT – UNCOVER VIEW.....	170
APPENDIX F INFORMATIVE REFERENCES	171
PRODUCT SIMILARITY DECLARATION LETTER.....	172

DOCUMENT REVISION HISTORY

Revision Number	Report Number	Description of Revision	Date of Revision
0	RSZ150323006-20	Original Report	2015-04-13

EUT DESCRIPTION

This report has been prepared on behalf of b mobile HK Limited and their product, FCC ID: ZSW-30-007, Model: AX1060 or the EUT (Equipment under Test) as referred to in the rest of this report.

*Note:

1. This series products model: AX1050 and AX1060, we select model: AX1060 to test, there is no electrical change has been made to the equipment, please refer to the product similarity letter.
2. The device is capable of personal hotspot mode. Wi-Fi Hotspot mode permits the device to share its cellular data connection with other 2.4 GHz Wi-Fi enabled devices (channels 1 - 13).

**All measurement and test data in this report was gathered from production sample serial number: 1503205. (Assigned by BACL, Shenzhen). The EUT supplied by the applicant was received on 2015-03-23.*

Technical Specification

Product Type	Portable
Exposure Category:	Population / Uncontrolled
Antenna Type(s):	Internal Antenna
Body-Worn Accessories:	Headset
Face-Head Accessories:	None
Multi-slot Class:	Class12
Operation Mode :	GSM Voice, EGPRS/GPRS Data, WCDMA,LTE, Wi-Fi and Bluetooth
Frequency Band:	GSM 850 : 824-849 MHz(TX) ; 869-894 MHz(RX) PCS 1900: 1850-1910 MHz(TX) ; 1930-1990 MHz(RX) WCDMA850: 824-849 MHz(TX) ; 869-894 MHz(RX) WCDMA 1700: 1710-1755 MHz(TX) ; 2110-2155 MHz(RX) WCDMA1900: 1850-1910 MHz(TX) ; 1930-1990 MHz(RX) LTE Band 2: 1850-1910MHz(TX) ; 1930-1990MHz(RX) LTE Band 4: 1710-1755MHz(TX) ; 2110-2155MHz(RX) LTE Band 5: 824-849MHz(TX) ; 869-894MHz(RX) LTE Band 7: 2500-2570MHz(TX) ; 2620-2690MHz(RX) LTE Band 17: 704-716MHz(TX) ; 734-746MHz(RX) Wi-Fi(802.11b/g/n20): 2412MHz-2472MHz Wi-Fi(802.11n40): 2422MHz-2462MHz Bluetooth3.0 : 2402MHz-2480MHz BLTE:2402MHz-2480MHz
Conducted RF Power:	GSM 850 : 32.18 dBm PCS 1900: 29.47 dBm WCDMA 850: 21.97 dBm WCDMA 1700:22.23dBm WCDMA 1900: 21.92 dBm LTE Band 2: 22.75 dBm LTE Band 4: 22.05 dBm LTE Band 5: 23.05 dBm LTE Band 7: 22.82 dBm LTE Band 17: 22.84 dBm Wi-Fi(802.11b/g/n20): 9.93 dBm

	Wi-Fi(802.11n40) : 9.48 dBm BLTE: -5.10 dBm Bluetooth:1.99 dBm
Dimensions (L*W*H):	128 mm (L) × 64 mm (W) × 10 mm (H)
Power Source:	3.7 V _{DC} Rechargeable Battery
Normal Operation:	Head and Body-worn

REFERENCE, STANDARDS, AND GUIDELINES

FCC:

The Report and Order requires routine SAR evaluation prior to equipment authorization of portable transmitter devices, including portable telephones. For consumer products, the applicable limit is 1.6 mW/g as recommended by the ANSI/IEEE standard C95.1-1992 [6] for an uncontrolled environment (Paragraph 65). According to the Supplement C of OET Bulletin 65 "Evaluating Compliance with FCC Guide-lines for Human Exposure to Radio frequency Electromagnetic Fields", released on Jun 29, 2001 by the FCC, the device should be evaluated at maximum output power (radiated from the antenna) under "worst-case" conditions for normal or intended use, incorporating normal antenna operating positions, device peak performance frequencies and positions for maximum RF energy coupling.

This report describes the methodology and results of experiments performed on wireless data terminal. The objective was to determine if there is RF radiation and if radiation is found, what is the extent of radiation with respect to safety limits. SAR (Specific Absorption Rate) is the measure of RF exposure determined by the amount of RF energy absorbed by human body (or its parts) – to determine how the RF energy couples to the body or head which is a primary health concern for body worn devices. The limit below which the exposure to RF is considered safe by regulatory bodies in North America is 1.6 mW/g average over 1 gram of tissue mass.

CE:

The order requires routine SAR evaluation prior to equipment authorization of portable transmitter devices, including portable telephones. For consumer products, the applicable limit is 2 mW/g as recommended by EN62209-1 for an uncontrolled environment. According to the Standard, the device should be evaluated at maximum output power (radiated from the antenna) under "worst-case" conditions for normal or intended use, incorporating normal antenna operating positions, device peak performance frequencies and positions for maximum RF energy coupling.

This report describes the methodology and results of experiments performed on wireless data terminal. The objective was to determine if there is RF radiation and if radiation is found, what is the extent of radiation with respect to safety limits. SAR (Specific Absorption Rate) is the measure of RF exposure determined by the amount of RF energy absorbed by human body (or its parts) – to determine how the RF energy couples to the body or head which is a primary health concern for body worn devices. The limit below which the exposure to RF is considered safe by regulatory bodies in Europe is 2 mW/g average over 10 gram of tissue mass.

The test configurations were laid out on a specially designed test fixture to ensure the reproducibility of measurements. Each configuration was scanned for SAR. Analysis of each scan was carried out to characterize the above effects in the device.

SAR Limits

FCC Limit (1g Tissue)

EXPOSURE LIMITS	SAR (W/kg)	
	(General Population / Uncontrolled Exposure Environment)	(Occupational / Controlled Exposure Environment)
Spatial Average (averaged over the whole body)	0.08	0.4
Spatial Peak (averaged over any 1 g of tissue)	1.60	8.0
Spatial Peak (hands/wrists/feet/ankles averaged over 10 g)	4.0	20.0

CE Limit (10g Tissue)

EXPOSURE LIMITS	SAR (W/kg)	
	(General Population / Uncontrolled Exposure Environment)	(Occupational / Controlled Exposure Environment)
Spatial Average (averaged over the whole body)	0.08	0.4
Spatial Peak (averaged over any 10 g of tissue)	2.0	10
Spatial Peak (hands/wrists/feet/ankles averaged over 10 g)	4.0	20.0

Population/Uncontrolled Environments are defined as locations where there is the exposure of individual who have no knowledge or control of their exposure.

Occupational/Controlled Environments are defined as locations where there is exposure that may be incurred by people who are aware of the potential for exposure (i.e. as a result of employment or occupation).

General Population/Uncontrolled environments Spatial Peak limit 1.6W/kg (FCC) & 2 W/kg (CE) applied to the EUT.

FACILITIES

The test site used by Bay Area Compliance Laboratories Corp. (Shenzhen) to collect data is located at 6/F, the 3rd Phase of WanLi Industrial Building, Shi Hua Road, Fu Tian Free Trade Zone, Shenzhen, Guangdong, P.R. of China

DESCRIPTION OF TEST SYSTEM

These measurements were performed with ALSAS 10 Universal Integrated SAR Measurement system from APREL Laboratories.

ALSAS-10U System Description

ALSAS-10-U is fully compliant with the technical and scientific requirements of IEEE 1528, IEC 62209, CENELEC, ARIB, ACA, and the Federal Communications Commission. The system comprises of a six axes articulated robot which utilizes a dedicated controller.

ALSAS-10U uses the latest methodologies. And FDTD modeling to provide a platform which is repeatable with minimum uncertainty.

Applications

Predefined measurement procedures compliant with the guidelines of CENELEC, IEEE, IEC, FCC, etc are utilized during the assessment for the device. Automatic detection for all SAR maxima are embedded within the core architecture for the system, ensuring that peak locations used for centering the zoom scan are within a 1mm resolution and a 0.05mm repeatable position. System operation range currently available up-to 6 GHz in simulated tissue.

Area Scans

Area scans are defined prior to the measurement process being executed with a user defined variable spacing between each measurement point (integral) allowing low uncertainty measurements to be conducted. Scans defined for FCC applications utilize a 10mm² step integral, with 1mm interpolation used to locate the peak SAR area used for zoom scan assessments.

Where the system identifies multiple SAR peaks (which are within 25% of peak value) the system will provide the user with the option of assessing each peak location individually for zoom scan averaging.

Zoom Scan (Cube Scan Averaging)

The averaging zoom scan volume utilized in the ALSAS-10U software is in the shape of a cube and the side dimension of a 1 g or 10 g mass is dependent on the density of the liquid representing the simulated tissue. A density of 1000 kg/m³ is used to represent the head and body tissue density and not the phantom liquid density, in order to be consistent with the definition of the liquid dielectric properties, i.e. the side length of the 1 g cube is 10mm, with the side length of the 10 g cube 21,5mm.

When the cube intersects with the surface of the phantom, it is oriented so that 3 vertices touch the surface of the shell or the center of a face is tangent to the surface. The face of the cube closest to the surface is modified in order to conform to the tangent surface.

The zoom scan integer steps can be user defined so as to reduce uncertainty, but normal practice for typical test applications (including FCC) utilize a physical step of 5x5x8 (8mmx8mmx5mm) providing a volume of 32mm³ in the X & Y axis, and 35mm in the Z axis.



ALSAS-10U Interpolation and Extrapolation Uncertainty

The overall uncertainty for the methodology and algorithms the used during the SAR calculation was evaluated using the data from IEEE 1528 based on the example f3 algorithm:

$$f_3(x, y, z) = A \frac{a^2}{\frac{a^2}{4} + x'^2 + y'^2} \cdot \left(e^{-\frac{2z}{a}} + \frac{a^2}{2(a + 2z)^2} \right)$$

Isotropic E-Field Probe

The isotropic E-Field probe has been fully calibrated and assessed for isotropicity, and boundary effect within a controlled environment. Depending on the frequency for which the probe is calibrated the method utilized for calibration will change.

The E-Field probe utilizes a triangular sensor arrangement as detailed in the diagram below:

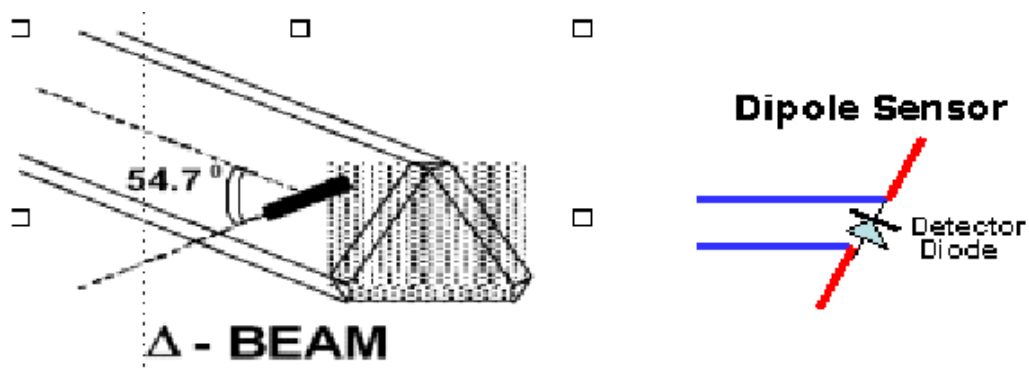

SAR is assessed with a calibrated probe which moves at a default height of 5mm from the center of the diode, which is mounted to the sensor, to the phantom surface (in the Z Axis). The 5mm offset height has been selected so as to minimize any resultant boundary effect due to the probe being in close proximity to the phantom surface.

The following algorithm is an example of the function used by the system for linearization of the output from the probe when measuring complex modulation schemes.

$$V_i = U_i + U_i^2 \cdot \frac{cf}{dcp_i}$$

Isotropic E-Field Probe Specification

Calibration Method	Frequency Dependent Below 1 GHz Calibration in air performed in a TEM Cell Above 1 GHz Calibration in air performed in waveguide
Sensitivity	0.70 $\mu\text{V}/(\text{V}/\text{m})^2$ to 0.85 $\mu\text{V}/(\text{V}/\text{m})^2$
Dynamic Range	0.0005 W/kg to 100 W/kg
Isotropic Response	Better than 0.1 dB
Diode Compression Point (DCP)	Calibration for Specific Frequency
Probe Tip Diameter	< 2.9 mm
Sensor Offset	1.56 (+/- 0.02 mm)
Probe Length	289 mm
Video Bandwidth	@ 500 Hz: 1 dB @ 1.02 kHz: 3 dB
Boundary Effect	Less than 2.1% for distance greater than 0.58 mm
Spatial Resolution	The spatial resolution uncertainty is less than 1.5% for 4.9mm diameter probe. The spatial resolution uncertainty is less than 1.0% for 2.5mm diameter probe

Boundary Detection Unit and Probe Mounting Device

ALSAS-10U incorporates a boundary detection unit with a sensitivity of 0.05mm for detecting all types of surfaces. The robust design allows for detection during probe tilt (probe normalize) exercises, and utilizes a second stage emergency stop. The signal electronics are fed directly into the robot controller for high accuracy surface detection in lateral and axial detection modes (X, Y, & Z).

The probe is mounted directly onto the Boundary Detection unit for accurate tooling and displacement calculations controlled by the robot kinematics. The probe is connect to an isolated probe interconnect where the output stage of the probe is fed directly into the amplifier stage of the Daq-Paq.

Daq-Paq (Analog to Digital Electronics)

ALSAS-10U incorporates a fully calibrated Daq-Paq (analog to digital conversion system) which has a 4 channel input stage, sent via a 2 stage auto-set amplifier module. The input signal is amplified accordingly so as to offer a dynamic range from 5 μV to 800mV. Integration of the fields measured is carried out at board level utilizing a Co-Processor which then sends the measured fields down into the main computational module in digitized form via an RS232 communications port. Probe linearity and duty cycle compensation is carried out within the main Daq-Paq module.

ADC	12 Bit
Amplifier Range	20 mV to 200 mV and 150 mV to 800 mV
Field Integration	Local Co-Processor utilizing proprietary integration algorithms
Number of Input Channels	4 in total 3 dedicated and 1 spare
Communication	Packet data via RS232

Axis Articulated Robot

ALSAS-10U utilizes a six axis articulated robot, which is controlled using a Pentium based real-time movement controller. The movement kinematics engine utilizes proprietary (Thermo CRS) interpolation and extrapolation algorithms, which allow full freedom of movement for each of the six joints within the working envelope. Utilization of joint 6 allows for full probe rotation with a tolerance better than 0.05mm around the central axis.



Robot/Controller Manufacturer	Thermo CRS
Number of Axis	Six independently controlled axis
Positioning Repeatability	0.05 mm
Controller Type	Single phase Pentium based C500C
Robot Reach	710 mm
Communication	RS232 and LAN compatible

ALSAS Universal Workstation

ALSAS Universal workstation allows for repeatability and fast adaptability. It allows users to do calibration, testing and measurements using different types of phantoms with one set up, which significantly speeds up the measurement process.

Universal Device Positioner

The universal device positioner allows complete freedom of movement of the EUT. Developed to hold a EUT in a free-space scenario any additional loading attributable to the material used in the construction of the positioner has been eliminated. Repeatability has been enhanced through the linear scales which form the design used to indicate positioning for any given test scenario in all major axes. A 15° tilt indicator is included for the of aid cheek to tilt movements for head SAR analysis. Overall uncertainty for measurements have been reduced due to the design of the Universal device positioner, which allows positioning of a device in as near to a free-space scenario as possible, and by providing the means for complete repeatability.



Phantom Types

The ALSAS-10U allows the integration of multiple phantom types. SAM Phantoms fully compliant with IEEE 1528, Universal Phantom, and Universal Flat.

APREL SAM Phantoms

The SAM phantoms developed using the IEEE SAM CAD file. They are fully compliant with the requirements for both IEEE 1528 and FCC Supplement C. Both the left and right SAM phantoms are interchangeable, transparent and include the IEEE 1528 grid with visible NF and MB lines.

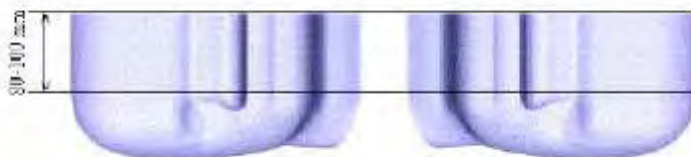

APREL Laboratories Universal Phantom

The Universal Phantom is used on the ALSAS-10U as a system validation phantom. The Universal Phantom has been fully validated both experimentally from 800MHz to 6GHz and numerically using XFDTD numerical software.

The shell thickness is 2mm overall, with a 4mm spacer located at the NF/MB intersection providing an overall thickness of 6mm in line with the requirements of IEEE-1528.

The design allows for fast and accurate measurements, of handsets, by allowing the conservative SAR to be evaluated at on frequency for both left and right head experiments in one measurement.



Tissue Dielectric Parameters for Head and Body Phantoms

The head tissue dielectric parameters recommended by the IEEE SCC-34/SC-2 in P1528 have been incorporated in the following table. These head parameters are derived from planar layer models simulating the highest expected SAR for the dielectric properties and tissue thickness variations in a human head. Other head and body tissue parameters that have not been specified in P1528 are derived from the tissue dielectric parameters computed from the 4-Cole-Cole equations described in Reference [12] and extrapolated according to the head parameters specified in P1528.

Ingredients (% by weight)	Frequency (MHz)									
	450		835		915		1900		2450	
Tissue Type	Head	Body	Head	Body	Head	Body	Head	Body	Head	Body
Water	38.56	51.16	41.45	52.4	41.05	56.0	54.9	40.4	62.7	73.2
Salt (NaCl)	3.95	1.49	1.45	1.4	1.35	0.76	0.18	0.5	0.5	0.04
Sugar	56.32	46.78	56.0	45.0	56.5	41.76	0.0	58.0	0.0	0.0
HEC	0.98	0.52	1.0	1.0	1.0	1.21	0.0	1.0	0.0	0.0
Bactericide	0.19	0.05	0.1	0.1	0.1	0.27	0.0	0.1	0.0	0.0
Triton x-100	0.0	0.0	0.0	0.0	0.0	0.0	0.0	0.0	36.8	0.0
DGBE	0.0	0.0	0.0	0.0	0.0	0.0	44.92	0.0	0.0	26.7
Dielectric Constant	43.42	58.0	42.54	56.1	42.0	56.8	39.9	54.0	39.8	52.5
Conductivity (s/m)	0.85	0.83	0.91	0.95	1.0	1.07	1.42	1.45	1.88	1.78

Recommended Tissue Dielectric Parameters for Head and Body

Frequency (MHz)	Head Tissue		Body Tissue	
	ϵ_r	σ (S/m)	ϵ_r	σ (S/m)
150	52.3	0.76	61.9	0.80
300	45.3	0.87	58.2	0.92
450	43.5	0.87	56.7	0.94
835	41.5	0.90	55.2	0.97
900	41.5	0.97	55.0	1.05
915	41.5	0.98	55.0	1.06
1450	40.5	1.20	54.0	1.30
1610	40.3	1.29	53.8	1.40
1800-2000	40.0	1.40	53.3	1.52
2450	39.2	1.80	52.7	1.95
3000	38.5	2.40	52.0	2.73
5800	35.3	5.27	48.2	6.00

EQUIPMENT LIST AND CALIBRATION

Equipments List & Calibration Information

Equipment	Model	Calibration Date	S/N
CRS F3 robot	ALS-F3	N/A	RAF0805352
CRS F3 Software	ALS-F3-SW	N/A	N/A
CRS C500C controller	ALS-C500	N/A	RCF0805379
Probe mounting device & Boundary Detection Sensor System	ALS-PMDPS-3	N/A	120-00270
Universal Work Station	ALS-UWS	N/A	100-00157
Data Acquisition Package	ALS-DAQ-PAQ-3	2014-10-14	110-00212
Miniature E-Field Probe	ALS-E-020	2014-10-14	500-00283
Dipole, 750MHz	ALS-D-750-S-2	2013-10-08	177-00505
Dipole, 835MHz	ALS-D-835-S-2	2014-10-08	180-00558
Dipole, 1750MHz	ALS-D-1750-S-2	2013-10-08	198-00304
Dipole, 1900MHz	ALS-D-1900-S-2	2014-10-09	210-00710
Dipole, 2450MHz	ALS-D-2450-S-2	2014-10-09	220-00758
Dipole Spacer	ALS-DS-U	N/A	250-00907
Device holder/Positioner	ALS-H-E-SET-2	N/A	170-00510
Left ear SAM phantom	ALS-P-SAM-L	N/A	130-00311
Right ear SAM phantom	ALS-P-SAM-R	N/A	140-00359
UniPhantom	ALS-P-UP-1	N/A	150-00413
Simulated Tissue 750 MHz Head	ALS-TS-750-H	Each Time	269-01008
Simulated Tissue 750 MHz Body	ALS-TS-750-B	Each Time	269-02107
Simulated Tissue 835 MHz Head	ALS-TS-835-H	Each Time	270-01002
Simulated Tissue 835 MHz Body	ALS-TS-835-B	Each Time	270-02101
Simulated Tissue 1750 MHz Head	ALS-TS-1750-H	Each Time	295-01103
Simulated Tissue 1750 MHz Body	ALS-TS-1750-B	Each Time	295-02102
Simulated Tissue 1900 MHz Head	ALS-TS-1900-H	Each Time	295-01103
Simulated Tissue 1900 MHz Body	ALS-TS-1900-B	Each Time	295-02102
Simulated Tissue 2450 MHz Head	ALS-TS-2450-H	Each Time	290-01108
Simulated Tissue 2450 MHz Body	ALS-TS-2450-B	Each Time	290-01109
Directional couple	DC6180A	N/A	0325849
Power Amplifier	5S1G4	N/A	71377
Dielectric probe kit	HP85070B	2014-06-13	N/A
Attenuator	3dB	2014-05-08	5402
Network analyzer	8752C	2014-06-03	3410A02356
Synthesized Sweeper	HP 8341B	2014-06-03	2624A00116
UNIVERSAL RADIO COMMUNICATION TESTER	CMU200	2013-11-23	106891
WIDEBAND RADIO COMMUNICATION TESTER	CMW500	2014-04-19	114772
EMI Test Receiver	ESCI	2014-06-13	101746

SAR MEASUREMENT SYSTEM VERIFICATION

Liquid Verification

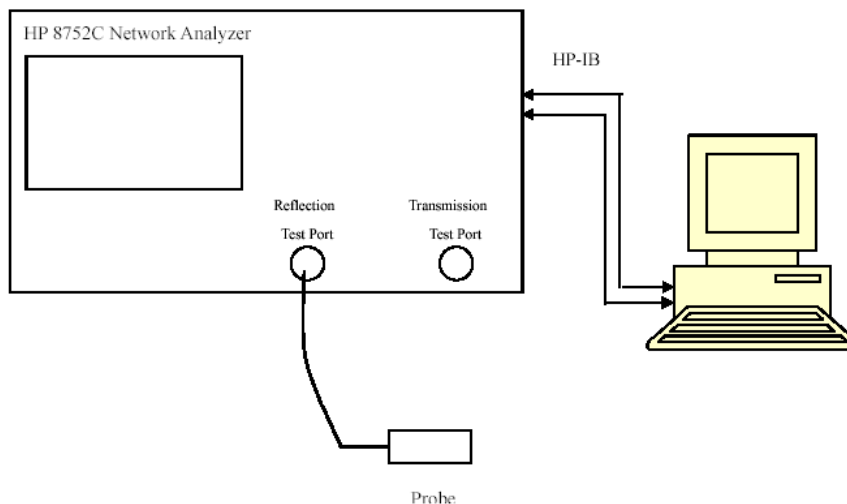

Liquid Verification Setup Block Diagram

Liquid Verification Results

Frequency	Liquid Type	Liquid Parameter		Target Value		Delta (%)		Tolerance (%)
		ϵ_r	σ (S/m)	ϵ_r	σ (S/m)	$\Delta\epsilon_r$	$\Delta\sigma$ (S/m)	
709.0	Head	42.00	0.87	41.95	0.89	0.119	-2.247	± 5
	Body	53.83	0.96	55.50	0.96	-3.009	0.000	± 5
710.0	Head	42.10	0.87	41.95	0.89	0.358	-2.247	± 5
	Body	53.80	0.95	55.50	0.96	-3.063	-1.042	± 5
711.0	Head	42.08	0.87	41.95	0.89	0.310	-2.247	± 5
	Body	53.87	0.96	55.50	0.96	-2.937	0.000	± 5
824.2	Head	41.07	0.90	41.50	0.90	-1.036	0.000	± 5
	Body	53.79	0.95	55.20	0.97	-2.554	-2.062	± 5
826.4	Head	41.00	0.91	41.50	0.90	-1.205	1.111	± 5
	Body	53.85	0.95	55.20	0.97	-2.446	-2.062	± 5
829.0	Head	41.01	0.91	41.50	0.90	-1.181	1.111	± 5
	Body	53.81	0.95	55.20	0.97	-2.518	-2.062	± 5
836.5	Head	41.04	0.91	41.50	0.90	-1.108	1.111	± 5
	Body	53.86	0.96	55.20	0.97	-2.428	-1.031	± 5
836.6	Head	41.05	0.91	41.50	0.90	-1.084	1.111	± 5
	Body	43.84	0.96	55.20	0.97	-20.580	-1.031	± 5
844.0	Head	41.03	0.91	41.50	0.90	-1.133	1.111	± 5
	Body	53.82	0.97	55.20	0.97	-2.500	0.000	± 5
846.6	Head	41.07	0.91	41.50	0.90	-1.036	1.111	± 5
	Body	53.87	0.97	55.20	0.97	-2.409	0.000	± 5
848.8	Head	41.04	0.92	41.50	0.90	-1.108	2.222	± 5
	Body	53.80	0.98	55.20	0.97	-2.536	1.031	± 5
1712.4	Head	39.27	1.36	40.08	1.37	-2.021	-0.730	± 5
	Body	51.98	1.49	53.43	1.49	-2.714	0.000	± 5

1720.0	Head	39.43	1.37	40.08	1.37	-1.622	0.000	±5
	Body	51.92	1.50	53.43	1.49	-2.826	0.671	±5
1732.4	Head	39.32	1.40	40.08	1.37	-1.896	2.190	±5
	Body	51.87	1.51	53.43	1.49	-2.920	1.342	±5
1732.5	Head	39.32	1.40	40.08	1.37	-1.896	2.190	±5
	Body	51.87	1.51	53.43	1.49	-2.920	1.342	±5
1745.0	Head	39.37	1.39	40.08	1.37	-1.771	1.460	±5
	Body	51.88	1.52	53.43	1.49	-2.901	2.013	±5
1752.6	Head	39.24	1.39	40.08	1.37	-2.096	1.460	±5
	Body	51.96	1.52	53.43	1.49	-2.751	2.013	±5
1850.2	Head	36.64	1.37	40.00	1.40	-8.400	-2.143	±5
	Body	52.05	1.49	53.30	1.52	-2.345	-1.974	±5
1852.4	Head	39.72	1.37	40.00	1.40	-0.700	-2.143	±5
	Body	51.94	1.50	53.30	1.52	-2.552	-1.316	±5
1860.0	Head	39.62	1.39	40.00	1.40	-0.950	-0.714	±5
	Body	51.98	1.50	53.30	1.52	-2.477	-1.316	±5
1880.0	Head	39.58	1.38	40.00	1.40	-1.050	-1.429	±5
	Body	51.89	1.51	53.30	1.52	-2.645	-0.658	±5
1900.0	Head	39.68	1.41	40.00	1.40	-0.800	0.714	±5
	Body	51.75	1.53	53.30	1.52	-2.908	0.658	±5
1907.6	Head	39.72	1.42	40.00	1.40	-0.700	1.429	±5
	Body	51.95	1.54	53.30	1.52	-2.533	1.316	±5
1909.8	Head	39.66	1.41	40.00	1.40	-0.850	0.714	±5
	Body	52.07	1.54	53.30	1.52	-2.308	1.316	±5
2510	Head	39.64	1.78	39.20	1.80	1.122	-1.111	±5
	Body	51.89	1.91	52.70	1.95	-1.537	-2.051	±5
2535	Head	39.57	1.80	39.20	1.80	0.944	0.000	±5
	Body	51.99	1.93	52.70	1.95	-1.347	-1.026	±5
2560	Head	39.58	1.82	39.20	1.80	0.969	1.111	±5
	Body	51.88	1.95	52.70	1.95	-1.556	0.000	±5

*Liquid Verification was performed on 2015-04-10.

Please refer to the following tables.

835 MHz Head				835 MHz Body		
Frequency (MHz)	e'	e''		Frequency (MHz)	e'	e''
701.0	42.0165	22.3807		701.0	53.8236	24.2411
702.0	42.0286	21.9244		702.0	53.8482	24.1837
703.0	42.0822	21.8986		703.0	53.7983	24.2578
704.0	42.1033	22.0129		704.0	53.7829	24.2257
705.0	42.0186	22.2209		705.0	53.7816	24.1913
706.0	42.0881	22.1179		706.0	53.8153	24.1912
707.0	42.0990	22.0305		707.0	53.8400	24.2991
708.0	42.0698	22.2189		708.0	53.7854	24.2802
709.0	41.9986	22.0540		709.0	53.8287	24.2352
710.0	42.0993	21.9806		710.0	53.8012	24.1682
711.0	42.0811	22.0612		711.0	53.8729	24.2234
712.0	42.0493	22.2796		712.0	53.8708	24.1715
713.0	42.1031	22.0886		713.0	53.7727	24.1611
714.0	42.0319	21.9366		714.0	53.8511	24.2340
715.0	42.0272	22.3291		715.0	53.8273	24.1946
716.0	42.0178	22.1042		716.0	53.8684	24.1440
717.0	42.0040	21.8924		717.0	53.8357	24.2143
718.0	42.0628	21.9351		718.0	53.8239	24.2448
719.0	42.0485	22.0554		719.0	53.8013	24.2185
720.0	42.0681	22.1602		720.0	53.7765	24.1644
721.0	42.0667	22.1283		721.0	53.8083	24.1848
722.0	41.9964	22.0934		722.0	53.7926	24.2581
723.0	42.1029	22.1106		723.0	53.8228	24.0062
724.0	41.9982	22.2519		724.0	53.8720	24.0363
725.0	42.0248	22.1698		725.0	53.7984	24.0875
726.0	42.0376	21.9655		726.0	53.8177	23.9964
727.0	41.9958	21.9253		727.0	53.7660	23.9185
728.0	42.0554	21.9008		728.0	53.8714	24.0749
729.0	42.0519	22.0978		729.0	53.8272	24.0965
730.0	42.0768	22.2185		730.0	53.7922	23.9910
731.0	42.0161	22.2022		731.0	53.8681	23.9747
732.0	42.0989	22.1424		732.0	53.7705	23.9099
733.0	42.0229	22.2812		733.0	53.8457	23.9941
734.0	42.0406	22.0812		734.0	53.7873	24.0625
735.0	42.0731	22.2085		735.0	53.7690	23.9906
736.0	42.0307	22.2060		736.0	53.8459	24.0418
737.0	42.1013	22.1861		737.0	53.8525	23.9534
738.0	42.0885	22.2122		738.0	53.8496	23.9215
739.0	42.0320	22.2341		739.0	53.7788	24.0502
740.0	42.0384	22.1611		740.0	53.8200	24.0154
741.0	42.0594	22.0298		741.0	53.8708	24.0538
742.0	42.0250	22.3227		742.0	53.8604	24.0582
743.0	42.0441	21.9511		743.0	53.8288	24.0068
744.0	42.0137	21.9116		744.0	53.8355	24.0358
745.0	42.0568	22.0393		745.0	53.7716	24.0445
746.0	42.1004	22.3063		746.0	53.7878	24.0714
747.0	42.0137	22.1672		747.0	53.7817	23.9209
748.0	42.0622	21.9808		748.0	53.7795	24.0505
749.0	42.0847	22.1333		749.0	53.7733	24.0496
750.0	42.0904	21.9373		750.0	53.7804	24.0060
751.0	42.0983	22.1471		751.0	53.8059	24.0091

835 MHz Head				835 MHz Body		
Frequency (MHz)	e'	e''		Frequency (MHz)	e'	e''
824.0	41.0599	19.7273		824.0	53.7717	20.6784
824.5	41.0650	19.6728		824.5	53.8425	20.6370
825.0	41.0829	19.7378		825.0	53.8653	20.7049
825.5	41.0626	19.7344		825.5	53.8384	20.6205
826.0	40.9969	19.6750		826.0	53.8617	20.6676
826.5	41.0025	19.7477		826.5	53.8379	20.6361
827.0	41.0630	19.7552		827.0	53.8467	20.6419
827.5	41.0085	19.7267		827.5	53.8246	20.6650
828.0	41.0573	19.7345		828.0	53.8266	20.6147
828.5	41.0348	19.6641		828.5	53.7980	20.7070
829.0	41.0064	19.7106		829.0	53.8080	20.6430
829.5	41.0814	19.6741		829.5	53.7870	20.6623
830.0	40.9990	19.7076		830.0	53.8220	20.6543
830.5	41.0188	19.7380		830.5	53.8482	20.6237
831.0	41.0663	19.7324		831.0	53.7955	20.6162
831.5	41.0909	19.6686		831.5	53.8732	20.6947
832.0	41.0709	19.6799		832.0	53.8479	20.6834
832.5	41.0573	19.7205		832.5	53.8446	20.6859
833.0	41.0815	19.7566		833.0	53.8660	20.6995
833.5	41.0327	19.7422		833.5	53.8338	20.6697
834.0	41.0358	19.7194		834.0	53.7687	20.7038
834.5	41.0245	19.7600		834.5	53.8213	20.6150
835.0	41.0219	19.7085		835.0	53.8675	20.6923
835.5	41.0948	19.7263		835.5	53.8239	20.6846
836.0	41.0166	19.7041		836.0	53.7721	20.7088
836.5	41.0388	19.6722		836.5	53.8634	20.6652
837.0	41.0920	19.7435		837.0	53.7967	20.6940
837.5	41.0818	19.7118		837.5	53.7906	20.6518
838.0	41.0564	19.7340		838.0	53.7724	20.6172
838.5	41.0647	19.7218		838.5	53.7851	20.6338
839.0	41.0733	19.6628		839.0	53.7690	20.6204
839.5	41.0605	19.7712		839.5	53.7752	20.7001
840.0	41.0081	19.3946		840.0	53.8700	20.6373
840.5	41.0854	19.4639		840.5	53.8666	20.7066
841.0	41.0825	19.3886		841.0	53.7891	20.6616
841.5	41.0589	19.4166		841.5	53.8217	20.6197
842.0	41.0842	19.4069		842.0	53.7753	20.6646
842.5	41.0066	19.3708		842.5	53.8584	20.6776
843.0	41.0362	19.4719		843.0	53.7881	20.6137
843.5	41.0723	19.4141		843.5	53.8494	20.7006
844.0	41.0302	19.3955		844.0	53.8222	20.6152
844.5	41.0265	19.3803		844.5	53.7769	20.6233
845.0	41.0688	19.3717		845.0	53.8388	20.6187
845.5	41.0984	19.4626		845.5	53.8193	20.6663
846.0	41.0374	19.4215		846.0	53.7943	20.7095
846.5	41.0637	19.4039		846.5	53.8707	20.7074
847.0	41.0095	19.4654		847.0	53.8277	20.6569
847.5	41.1046	19.3718		847.5	53.7923	20.6972
848.0	41.0724	19.4331		848.0	53.8065	20.6753
848.5	41.0839	19.4442		848.5	53.8257	20.6682
849.0	41.0012	19.4674		849.0	53.7756	20.6596

1750 MHz Head				1750 MHz Body		
Frequency (MHz)	e'	e''		Frequency (MHz)	e'	e''
1710.0	39.5961	14.3012		1710.0	51.9500	15.7029
1711.5	39.2621	14.5351		1711.5	51.9784	15.6535
1713.0	39.3039	14.1847		1713.0	51.9787	15.6382
1714.5	39.1846	14.2669		1714.5	51.9088	15.6463
1716.0	39.3727	14.5366		1716.0	51.9530	15.7091
1717.5	39.5495	14.3341		1717.5	51.8657	15.6283
1719.0	39.4508	14.3246		1719.0	51.8396	15.6203
1720.5	39.4082	14.2738		1720.5	51.9658	15.6917
1722.0	39.3620	14.3024		1722.0	51.9085	15.7033
1723.5	39.2850	14.1810		1723.5	51.8652	15.6971
1725.0	39.5844	14.5393		1725.0	51.9652	15.5066
1726.5	39.1219	14.1631		1726.5	51.9969	15.6789
1728.0	39.1585	14.5266		1728.0	51.9185	15.6288
1729.5	39.2943	14.2416		1729.5	51.9222	15.6944
1731.0	39.3580	14.4660		1731.0	51.9797	15.6907
1732.5	39.3200	14.5654		1732.5	51.8666	15.6601
1734.0	39.3205	14.1284		1734.0	51.8581	15.6704
1735.5	39.3090	14.3386		1735.5	51.9272	15.6499
1737.0	39.5437	14.1713		1737.0	51.9676	15.6409
1738.5	39.4885	14.1734		1738.5	51.9628	15.6455
1740.0	39.5315	14.2300		1740.0	51.8948	15.6485
1741.5	39.1671	14.2221		1741.5	51.8531	15.7106
1743.0	39.2984	14.3258		1743.0	51.8920	15.6973
1744.5	39.1282	14.4366		1744.5	51.8870	15.6883
1746.0	39.5539	14.2831		1746.0	51.8815	15.6922
1747.5	39.2591	14.2899		1747.5	51.9670	15.6788
1749.0	39.3000	14.3042		1749.0	51.9737	15.6488
1750.5	39.5224	14.5813		1750.5	51.8602	15.6523
1752.0	39.2977	14.3397		1752.0	51.9680	15.6020
1753.5	39.1782	14.2735		1753.5	51.9400	15.6944
1755.0	39.4413	14.4785		1755.0	51.8763	15.6283
1756.5	39.4124	14.1162		1756.5	51.8563	15.6913
1758.0	39.1024	14.2463		1758.0	51.8818	15.5625
1759.5	39.2624	14.4759		1759.5	51.9594	15.5808
1761.0	39.1524	14.5547		1761.0	51.9533	15.5119
1762.5	39.1503	14.4706		1762.5	51.9145	15.4034
1764.0	39.6113	14.0857		1764.0	51.9184	15.3196
1765.5	39.4819	14.0936		1765.5	51.8698	15.5876
1767.0	39.5706	14.0964		1767.0	51.9260	15.2915
1768.5	39.1484	14.3221		1768.5	51.9982	15.3534
1770.0	39.6127	14.5521		1770.0	51.8486	15.4050
1771.5	39.2200	14.1838		1771.5	51.9828	15.3603
1773.0	39.3296	14.5122		1773.0	51.8953	15.3230
1774.5	39.5451	14.1739		1774.5	51.8634	15.3633
1776.0	39.5454	14.1102		1776.0	51.9665	15.4180
1777.5	39.6331	14.4430		1777.5	51.8371	15.4062
1779.0	39.3962	14.5316		1779.0	51.8968	15.3721
1780.5	39.3498	14.4004		1780.5	51.8552	15.3856
1782.0	39.1501	14.2772		1782.0	51.9151	15.4109
1783.5	39.2340	14.0948		1783.5	51.9840	15.5371
1785.0	39.1071	14.1882		1785.0	51.9133	15.4666

1900 MHz Head				1900 MHz Body		
Frequency (MHz)	e'	e''		Frequency (MHz)	e'	e''
1850.0	39.6433	13.2788		1850.0	52.0456	14.5062
1851.2	39.5585	13.2532		1851.2	52.0427	14.5225
1852.4	39.7177	13.2726		1852.4	51.9406	14.5334
1853.6	39.6063	13.3168		1853.6	52.0970	14.4231
1854.8	39.7118	13.3956		1854.8	52.0044	14.4582
1856.0	39.6091	13.3804		1856.0	51.7369	14.5455
1857.2	39.5851	13.3979		1857.2	52.0831	14.5051
1858.4	39.6691	13.3157		1858.4	52.0884	14.4770
1859.6	39.5851	13.4302		1859.6	52.0417	14.4648
1860.8	39.6626	13.4253		1860.8	51.9546	14.4306
1862.0	39.7301	13.3112		1862.0	51.7687	14.4898
1863.2	39.6566	13.2866		1863.2	51.9836	14.5754
1864.4	39.6190	13.2587		1864.4	51.8904	14.4645
1865.6	39.5456	13.3469		1865.6	52.0456	14.4362
1866.8	39.6964	13.3715		1866.8	51.8003	14.4490
1868.0	39.7060	13.2409		1868.0	52.0869	14.5278
1869.2	39.5890	13.4310		1869.2	52.0762	14.4208
1870.4	39.6145	13.3875		1870.4	51.9732	14.5753
1871.6	39.6161	13.3049		1871.6	51.7616	14.4495
1872.8	39.5817	13.2541		1872.8	51.8043	14.5312
1874.0	39.5664	13.2494		1874.0	51.8416	14.5340
1875.2	39.6093	13.3902		1875.2	51.9911	14.4772
1876.4	39.6927	13.4164		1876.4	52.0653	14.4314
1877.6	39.6396	13.3069		1877.6	51.7544	14.4478
1878.8	39.6707	13.4328		1878.8	52.0874	14.4430
1880.0	39.5833	13.2453		1880.0	51.8902	14.4740
1881.2	39.5639	13.3365		1881.2	52.0206	14.4230
1882.4	39.6261	13.2835		1882.4	51.7840	14.4276
1883.6	39.7114	13.2709		1883.6	51.9589	14.4929
1884.8	39.6579	13.3012		1884.8	51.9010	14.4550
1886.0	39.6691	13.2927		1886.0	51.8299	14.5248
1887.2	39.7177	13.3727		1887.2	51.7879	14.4160
1888.4	39.7039	13.2758		1888.4	51.9964	14.5648
1889.6	39.6874	13.2974		1889.6	51.8096	14.5398
1890.8	39.6260	13.3101		1890.8	52.0612	14.4308
1892.0	39.6586	13.4182		1892.0	51.9446	14.5113
1893.2	39.6802	13.4004		1893.2	51.9359	14.4912
1894.4	39.5662	13.2657		1894.4	51.9416	14.4607
1895.6	39.5780	13.3406		1895.6	51.9840	14.5117
1896.8	39.6573	13.3871		1896.8	52.1003	14.4364
1898.0	39.6199	13.4018		1898.0	52.0990	14.4776
1899.2	39.7049	13.3305		1899.2	51.7469	14.5250
1900.4	39.6699	13.2618		1900.4	51.7481	14.4979
1901.6	39.7158	13.3983		1901.6	51.7451	14.4829
1902.8	39.6572	13.3983		1902.8	52.0465	14.4937
1904.0	39.7201	13.2530		1904.0	51.7548	14.5317
1905.2	39.6335	13.2897		1905.2	52.0307	14.4935
1906.4	39.6636	13.2931		1906.4	51.7927	14.4163
1907.6	39.7151	13.3619		1907.6	51.9519	14.4967
1908.8	39.7273	13.3338		1908.8	51.7914	14.5723
1910.0	39.6621	13.2545		1910.0	52.0680	14.4783

2450 MHz Head				2450 MHz Body		
Frequency (MHz)	e'	e''		Frequency (MHz)	e'	e''
2500.0	39.5526	12.7698		2500.0	51.8204	13.7671
2501.5	39.7233	12.6789		2501.5	51.8932	13.7012
2503.0	39.6763	12.7856		2503.0	52.0965	13.6762
2504.5	39.5545	12.8129		2504.5	52.0072	13.6937
2506.0	39.6094	12.7478		2506.0	51.7577	13.6876
2507.5	39.6688	12.6551		2507.5	51.9945	13.7233
2509.0	39.6198	12.6470		2509.0	51.8753	13.7542
2510.5	39.6463	12.7938		2510.5	51.8922	13.6830
2512.0	39.5771	12.7385		2512.0	51.7530	13.7734
2513.5	39.6990	12.6805		2513.5	51.7805	13.6531
2515.0	39.6451	12.7593		2515.0	51.8760	13.6223
2516.5	39.6139	12.6580		2516.5	51.7747	13.7291
2518.0	39.6204	12.7246		2518.0	51.8859	13.7118
2519.5	39.5629	12.7832		2519.5	51.8112	13.6287
2521.0	39.5887	12.8106		2521.0	51.9260	13.7595
2522.5	39.5804	12.6890		2522.5	51.8420	13.6784
2524.0	39.6868	12.6877		2524.0	51.8059	13.6174
2525.5	39.6843	12.7314		2525.5	51.9557	13.6735
2527.0	39.7276	12.6936		2527.0	52.0786	13.6331
2528.5	39.6334	12.7794		2528.5	51.8193	13.6736
2530.0	39.5883	12.7197		2530.0	52.0358	13.6566
2531.5	39.6541	12.6790		2531.5	51.8579	13.7208
2533.0	39.5831	12.6733		2533.0	51.8658	13.6122
2534.5	39.5766	12.7516		2534.5	52.0584	13.6262
2536.0	39.5707	12.7355		2536.0	51.8295	13.7493
2537.5	39.7205	12.6906		2537.5	51.9959	13.7641
2539.0	39.6067	12.6781		2539.0	51.9493	13.6860
2540.5	39.5608	12.6851		2540.5	51.8590	13.6236
2542.0	39.7017	12.8149		2542.0	51.7932	13.7396
2543.5	39.5445	12.7809		2543.5	52.0572	13.7058
2545.0	39.7099	12.6964		2545.0	52.0316	13.7227
2546.5	39.5704	12.7202		2546.5	51.7752	13.7008
2548.0	39.6441	12.6438		2548.0	51.8387	13.6222
2549.5	39.6228	12.7412		2549.5	51.8964	13.7477
2551.0	39.6059	12.8321		2551.0	51.9030	13.7470
2552.5	39.6084	12.7654		2552.5	51.8616	13.7786
2554.0	39.5476	12.8095		2554.0	51.8831	13.7618
2555.5	39.7273	12.7905		2555.5	51.9261	13.6818
2557.0	39.6143	12.7673		2557.0	52.0148	13.6233
2558.5	39.6173	12.8344		2558.5	51.7926	13.7630
2560.0	39.5817	12.7817		2560.0	51.8849	13.7301
2561.5	39.7094	12.6718		2561.5	52.0948	13.7319
2563.0	39.6609	12.6795		2563.0	51.8948	13.6596
2564.5	39.5947	12.6720		2564.5	52.0018	13.6871
2566.0	39.5726	12.7667		2566.0	52.0861	13.6774
2567.5	39.5842	12.7286		2567.5	51.9829	13.6807
2569.0	39.6739	12.7068		2569.0	51.9057	13.7353
2570.5	39.7335	12.6685		2570.5	51.7897	13.6929
2572.0	39.6321	12.8306		2572.0	51.9853	13.6323
2573.5	39.5539	12.6407		2573.5	51.8268	13.6165
2575.0	39.7141	12.6502		2575.0	51.7808	13.7735
2500.0	39.5526	12.7698		2500.0	51.8204	13.7671

System Accuracy Verification

Prior to the assessment, the system validation kit was used to test whether the system was operating within its specifications of $\pm 10\%$. The validation results are tabulated below. And also the corresponding SAR plot is attached as well in the SAR plots files.

System Verification Setup Block Diagram

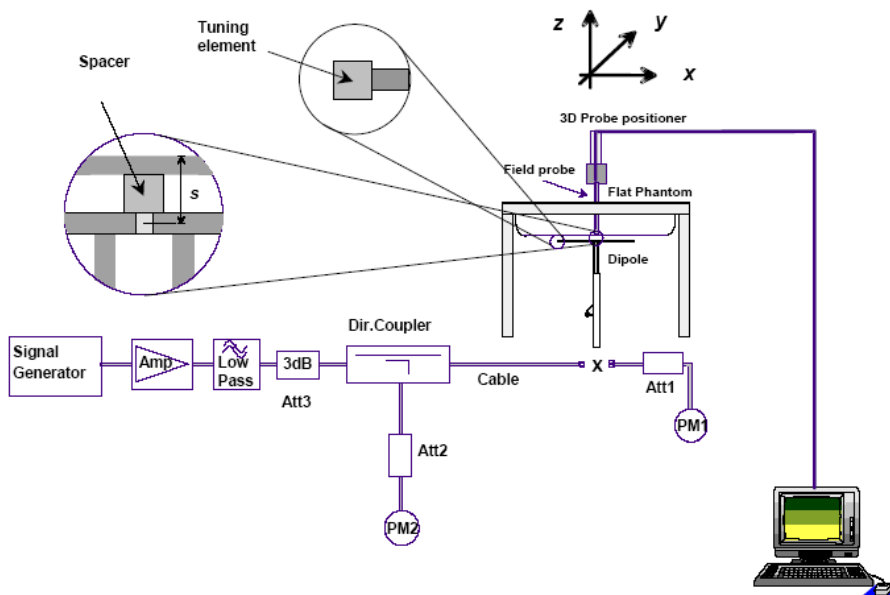

Probe and dipole antenna List and Detail

Manufacturer	Description	Model	Serial Number	Calibration Date	Calibration Due Date
APREL	Probe	ALS-E-020	500-00283	2014-10-14	2015-10-13
APREL	Dipole antenna(750MHz)	ALS-D-750-S-2	177-00505	2013-10-08	2016-10-07
APREL	Dipole antenna(835MHz)	ALS-D-835-S-2	180-00558	2014-10-08	2017-10-07
APREL	Dipole antenna(1750MHz)	ALS-D-1750-S-2	198-00304	2013-10-08	2016-10-07
APREL	Dipole antenna(1900MHz)	ALS-D-1900-S-2	210-00710	2014-10-09	2017-10-08
APREL	Dipole antenna(2450MHz)	ALS-D-2450-S-2	220-00758	2014-10-09	2017-10-08

System Accuracy Check Results:

Date	Frequency Band	Liquid Type	Measured SAR (W/Kg)		Target Value (W/Kg)	Delta (%)	Tolerance (%)
2015-04-10	750	Head	1g	8.635	8.500	1.588	± 10
		Body	1g	8.596	8.540	0.656	± 10
	835	Head	1g	9.745	9.773	-0.287	± 10
		Body	1g	9.849	9.736	1.161	± 10
	1750	Head	1g	36.398	37.020	-1.680	± 10
		Body	1g	36.224	36.650	-1.162	± 10
	1900	Head	1g	39.125	39.481	-0.902	± 10
		Body	1g	39.559	39.715	-0.393	± 10
2450	Head	1g	53.628	54.916	-2.345	± 10	
	Body	1g	56.213	52.418	7.240	± 10	

*All SAR values are normalized to 1 Watt forward power.

SAR SYSTEM VALIDATION DATA**Test Laboratory: Bay Area Compliance Lab Corp. (Shenzhen)****System Performance Check 750 MHz Head Liquid****Dipole 750 MHz; Type: ALS-D-750-S-2; S/N: 177-00505**

Product Data

Device Name : Dipole 750 MHz
Serial No. : 177-00505
Type : Dipole
Model : ALS-D-750-S-2
Frequency Band : 750
Max. Transmit Pwr : 1 W
Drift Time : 3 min(s)
Power Drift-Start : 8.102 W/kg
Power Drift-Finish : 8.035 W/kg
Power Drift (%) : -1.358

Phantom Data

Name : APREL-Uni
Type : Uni-Phantom
Serial No. : System Default
Location : Center
Description : Default
Phantom Data

Tissue Data

Type : Head
Serial No. : 269-01008
Frequency : 750.0 MHz
Last Calib. Date : 10-Apr-2015
Temperature : 20.00 °C
Ambient Temp. : 21.00 °C
Humidity : 56.00 RH%
Epsilon : 42.09 F/m
Sigma : 0.91 S/m
Density : 1000.00 kg/cu. m

Probe Data

Name : E-Field
Model : E-020
Type : E-Field Triangle
Serial No. : 500-00283
Last Calib. Date : 14-Oct-2014
Frequency Band : 750
Duty Cycle Factor : 1
Conversion Factor : 6.0
Probe Sensitivity : 1.20 1.20 1.20 $\mu\text{V}/(\text{V}/\text{m})^2$
Compression Point : 95.00 mV
Offset : 1.56 mm

Measurement Data

Crest Factor : 1
Scan Type : Complete
Tissue Temp. : 21.00 °C
Ambient Temp. : 21.00 °C
Area Scan : 7x9x1 : Measurement x=10mm, y=10mm, z=4mm
Zoom Scan : 7x7x7 : Measurement x=5mm, y=5mm, z=5mm

1 gram SAR value : 8.635 W/kg
10 gram SAR value : 5.687 W/kg
Area Scan Peak SAR : 9.236 W/kg
Zoom Scan Peak SAR : 14.294 W/kg

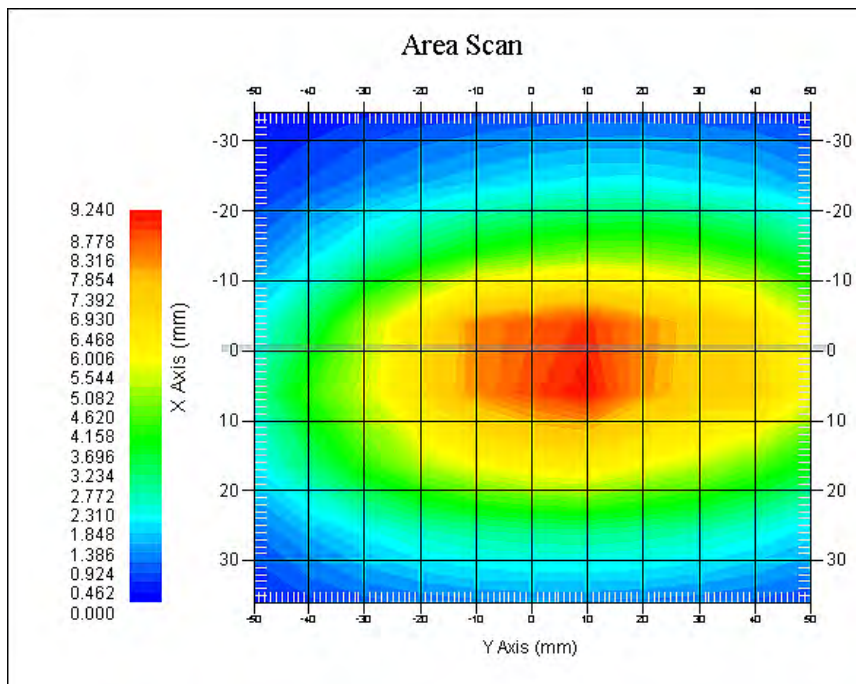

750 MHz System Validation with Head Tissue

Test Laboratory: Bay Area Compliance Lab Corp. (Shenzhen)**System Performance Check 750 MHz Body Liquid****Dipole 750 MHz; Type: ALS-D-750-S-2; S/N: 177-00505**

Product Data

Device Name : Dipole 750 MHz
Serial No. : 177-00505
Type : Dipole
Model : ALS-D-750-S-2
Frequency Band : 750
Max. Transmit Pwr : 1 W
Drift Time : 3 min(s)
Power Drift-Start : 8.203 W/kg
Power Drift-Finish : 8.269 W/kg
Power Drift (%) : 0.794

Phantom Data

Name : APREL-Uni
Type : Uni-Phantom
Serial No. : System Default
Location : Center
Description : Default
Phantom Data

Tissue Data

Type : Body
Serial No. : 269-02107
Frequency : 750.0 MHz
Last Calib. Date : 10-Apr-2015
Temperature : 20.00 °C
Ambient Temp. : 21.00 °C
Humidity : 56.00 RH%
Epsilon : 53.78 F/m
Sigma : 0.99 S/m
Density : 1000.00 kg/cu. m

Probe Data

Name : E-Field
Model : E-020
Type : E-Field Triangle
Serial No. : 500-00283
Last Calib. Date : 14-Oct-2014
Frequency Band : 750
Duty Cycle Factor : 1
Conversion Factor : 5.5
Probe Sensitivity : 1.20 1.20 1.20 $\mu\text{V}/(\text{V}/\text{m})^2$
Compression Point : 95.00 mV
Offset : 1.56 mm

Measurement Data

Crest Factor : 1
Scan Type : Complete
Tissue Temp. : 21.00 °C
Ambient Temp. : 21.00 °C
Area Scan : 7x9x1 : Measurement x=10mm, y=10mm, z=4mm
Zoom Scan : 7x7x7 : Measurement x=5mm, y=5mm, z=5mm

1 gram SAR value : 8.596 W/kg
10 gram SAR value : 5.998 W/kg
Area Scan Peak SAR : 8.877 W/kg
Zoom Scan Peak SAR : 13.884 W/kg

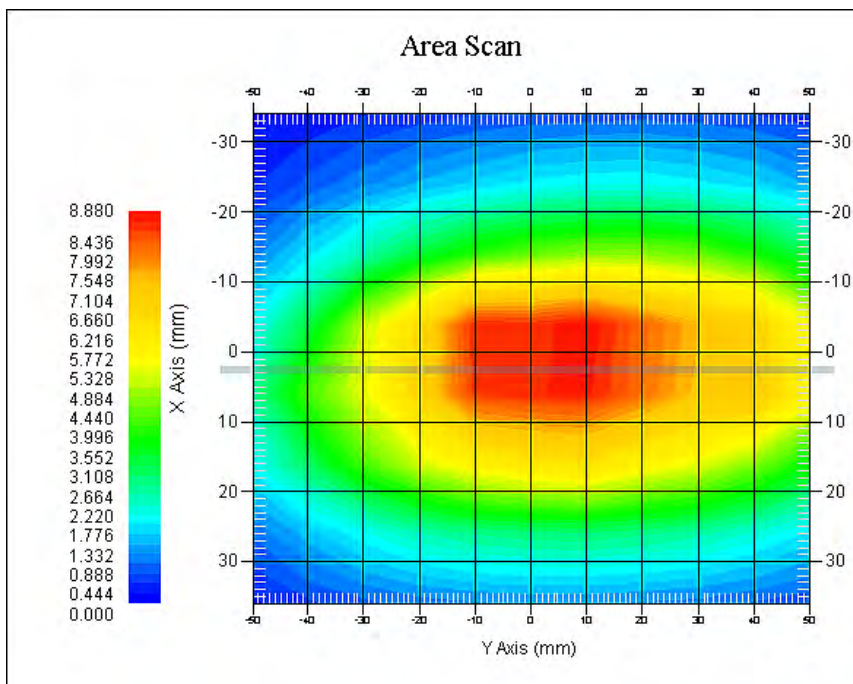

750 MHz System Validation with Body Tissue

Test Laboratory: Bay Area Compliance Lab Corp. (Shenzhen)**System Performance Check 835 MHz Head Liquid****Dipole 835 MHz; Type: ALS-D-835-S-2; S/N: 180-00558**

Product Data

Device Name : Dipole 835 MHz
Serial No. : 180-00558
Type : Dipole
Model : ALS-D-835-S-2
Frequency Band : 835
Max. Transmit Pwr : 1 W
Drift Time : 3 min(s)
Power Drift-Start : 10.528 W/kg
Power Drift-Finish : 10.400W/kg
Power Drift (%) : -1.274

Phantom Data

Name : APREL-Uni
Type : Uni-Phantom
Serial No. : System Default
Location : Center
Description : Default
Phantom Data

Tissue Data

Type : Head
Serial No. : 270-01002
Frequency : 835.0 MHz
Last Calib. Date : 10-Apr-2015
Temperature : 20.00 °C
Ambient Temp. : 21.00 °C
Humidity : 56.00 RH%
Epsilon : 41.02 F/m
Sigma : 0.91 S/m
Density : 1000.00 kg/cu. m

Probe Data

Name : E-Field
Model : E-020
Type : E-Field Triangle
Serial No. : 500-00283
Last Calib. Date : 14-Oct-2014
Frequency Band : 835
Duty Cycle Factor : 1
Conversion Factor : 5.9
Probe Sensitivity : 1.20 1.20 1.20 $\mu\text{V}/(\text{V}/\text{m})^2$
Compression Point : 95.00 mV
Offset : 1.56 mm

Measurement Data

Crest Factor : 1
Scan Type : Complete
Tissue Temp. : 21.00 °C
Ambient Temp. : 21.00 °C
Area Scan : 7x9x1 : Measurement x=10mm, y=10mm, z=4mm
Zoom Scan : 7x7x7 : Measurement x=5mm, y=5mm, z=5mm

1 gram SAR value : 9.745 W/kg
10 gram SAR value : 6.326 W/kg
Area Scan Peak SAR : 9.955 W/kg
Zoom Scan Peak SAR : 16.728 W/kg

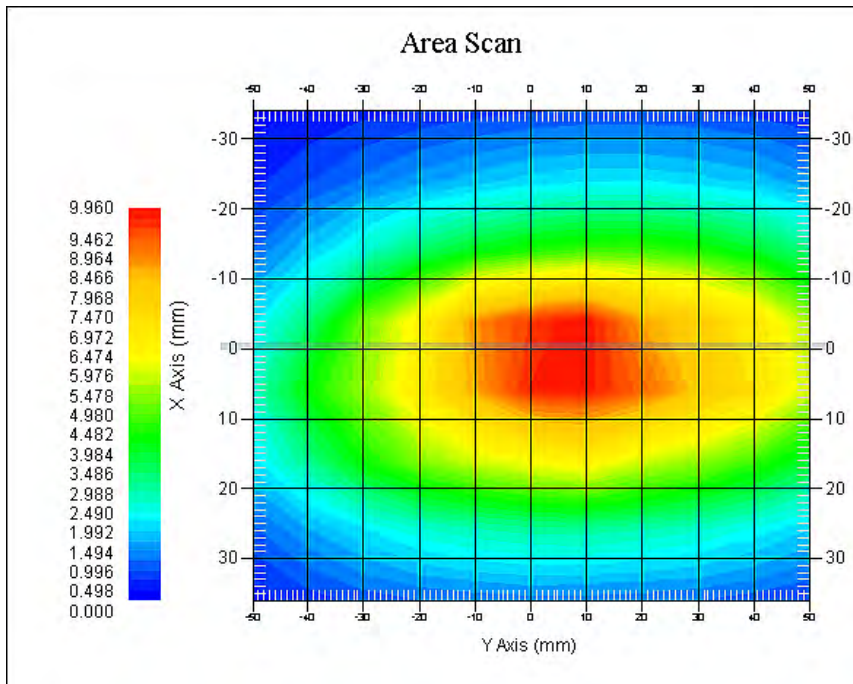

835 MHz System Validation with Head Tissue

Test Laboratory: Bay Area Compliance Lab Corp. (Shenzhen)**System Performance Check 835 MHz Body Liquid****Dipole 835 MHz; Type: ALS-D-835-S-2; S/N: 180-00558**

Product Data

Device Name : Dipole 835 MHz
Serial No. : 180-00558
Type : Dipole
Model : ALS-D-835-S-2
Frequency Band : 835
Max. Transmit Pwr : 1 W
Drift Time : 3 min(s)
Power Drift-Start : 9.526 W/kg
Power Drift-Finish : 9.402 W/kg
Power Drift (%) : -1.241

Phantom Data

Name : APREL-Uni
Type : Uni-Phantom
Serial No. : System Default
Location : Center
Description : Default
Phantom Data

Tissue Data

Type : Body
Serial No. : 270-02101
Frequency : 835.0 MHz
Last Calib. Date : 10-Apr-2015
Temperature : 20.00 °C
Ambient Temp. : 21.00 °C
Humidity : 56.00 RH%
Epsilon : 53.87 F/m
Sigma : 0.96 S/m
Density : 1000.00 kg/cu. m

Probe Data

Name : E-Field
Model : E-020
Type : E-Field Triangle
Serial No. : 500-00283
Last Calib. Date : 14-Oct-2014
Frequency Band : 835
Duty Cycle Factor : 1
Conversion Factor : 5.9
Probe Sensitivity : 1.20 1.20 1.20 $\mu\text{V}/(\text{V}/\text{m})^2$
Compression Point : 95.00 mV
Offset : 1.56 mm

Measurement Data

Crest Factor : 1
Scan Type : Complete
Tissue Temp. : 21.00 °C
Ambient Temp. : 21.00 °C
Area Scan : 7x9x1 : Measurement x=10mm, y=10mm, z=4mm
Zoom Scan : 7x7x7 : Measurement x=5mm, y=5mm, z=5mm

1 gram SAR value : 9.849 W/kg
10 gram SAR value : 6.197 W/kg
Area Scan Peak SAR : 10.039 W/kg
Zoom Scan Peak SAR : 16.228 W/kg

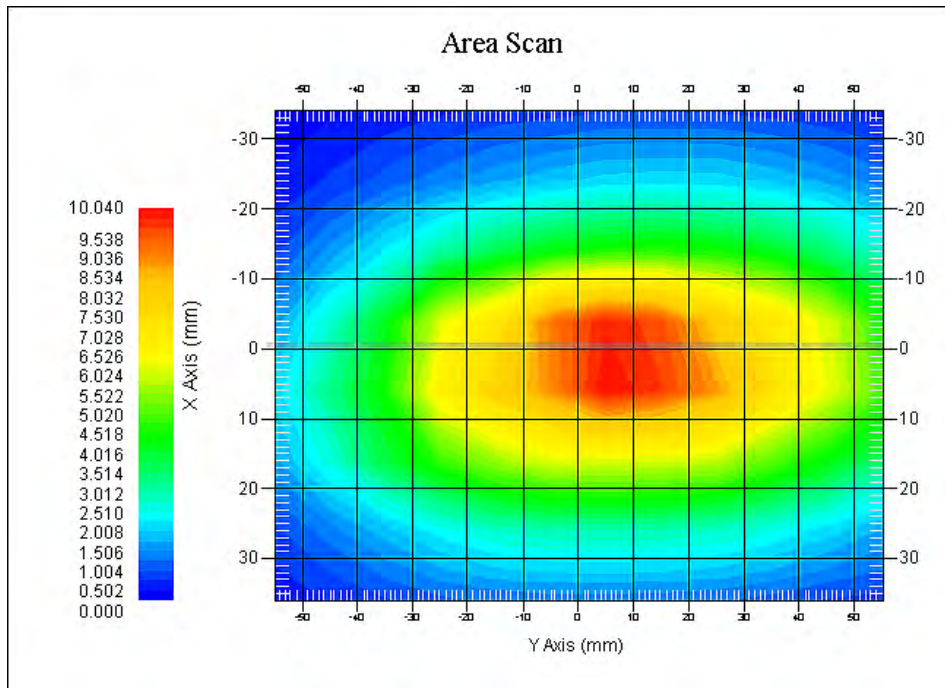

835 MHz System Validation with Body Tissue

Test Laboratory: Bay Area Compliance Lab Corp. (Shenzhen)**System Performance Check 1750 MHz Head Liquid****Dipole 1750 MHz; Type: ALS-D-1750-S-2; S/N: 198-00304**

Product Data

Device Name : Dipole 1750MHz
Serial No. : 198-00304
Type : Dipole
Model : ALS-D-1750-S-2
Frequency Band : 1700
Max. Transmit Pwr : 1 W
Drift Time : 3 min(s)
Power Drift-Start : 34.639 W/kg
Power Drift-Finish : 34.002 W/kg
Power Drift (%) : -1.749

Phantom Data

Name : APREL-Uni
Type : Uni-Phantom
Serial No. : System Default
Location : Center
Description : Default

Tissue Data

Type : Head
Serial No. : 295-01101
Frequency : 1750.00 MHz
Last Calib. Date : 10-Apr-2015
Temperature : 20.00 °C
Ambient Temp. : 21.00 °C
Humidity : 56.00 RH%
Epsilon : 39.41 F/m
Sigma : 1.39 S/m
Density : 1000.00 kg/cu. M

Probe Data

Name : E-Field
Model : E-020
Type : E-Field Triangle
Serial No. : 500-00283
Last Calib. Date : 14-Oct-2014
Frequency Band : 1750
Duty Cycle Factor : 1
Conversion Factor : 5.4
Probe Sensitivity : 1.20 1.20 1.20 $\mu\text{V}/(\text{V}/\text{m})^2$
Compression Point : 95.00 mV
Offset : 1.56 mm

Measurement Data

Crest Factor : 1
Scan Type : Complete
Tissue Temp. : 20.00 °C
Ambient Temp. : 20.00 °C
Area Scan : 7x9x1 : Measurement x=10mm, y=10mm, z=4mm
Zoom Scan : 7x7x7 : Measurement x=5mm, y=5mm, z=5mm

1 gram SAR value : 36.398 W/kg
10 gram SAR value : 19.778 W/kg
Area Scan Peak SAR : 38.394 W/kg
Zoom Scan Peak SAR : 61.035 W/kg

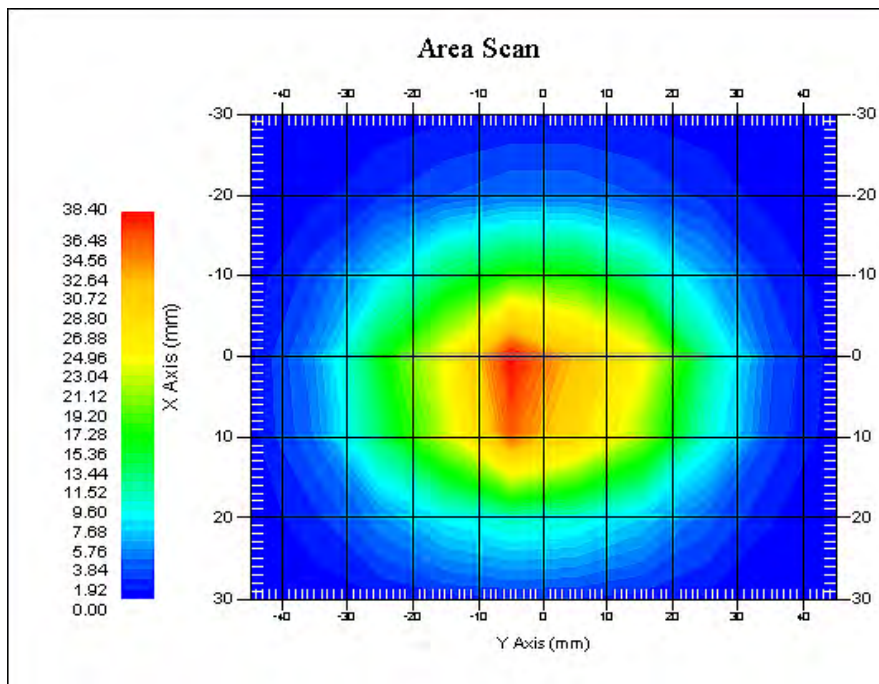

1750 MHz System Validation with Head Tissue

Test Laboratory: Bay Area Compliance Lab Corp. (Shenzhen)**System Performance Check 1750 MHz Body Liquid****Dipole 1750 MHz; Type: ALS-D-1750-S-2; S/N: 198-00304**

Product Data

Device Name : Dipole 1750MHz
Serial No. : 198-00304
Type : Dipole
Model : ALS-D-1750-S-2
Frequency Band : 1700
Max. Transmit Pwr : 1 W
Drift Time : 3 min(s)
Power Drift-Start : 35.112 W/kg
Power Drift-Finish : 35.695 W/kg
Power Drift (%) : 1.883

Phantom Data

Name : APREL-Uni
Type : Uni-Phantom
Serial No. : System Default
Location : Center
Description : Default

Tissue Data

Type : Body
Serial No. : 295-02105
Frequency : 1750.00 MHz
Last Calib. Date : 10-Apr-2015
Temperature : 20.00 °C
Ambient Temp. : 21.00 °C
Humidity : 56.00 RH%
Epsilon : 51.91 F/m
Sigma : 1.52 S/m
Density : 1000.00 kg/cu. m

Probe Data

Name : E-Field
Model : E-020
Type : E-Field Triangle
Serial No. : 500-00283
Last Calib. Date : 14-Oct-2014
Frequency Band : 1750
Duty Cycle Factor : 1
Conversion Factor : 5.3
Probe Sensitivity : 1.20 1.20 1.20 $\mu\text{V}/(\text{V}/\text{m})^2$
Compression Point : 95.00 mV
Offset : 1.56 mm

Measurement Data

Crest Factor : 1
Scan Type : Complete
Tissue Temp. : 20.00 °C
Ambient Temp. : 21.00 °C
Area Scan : 7x9x1 : Measurement x=10mm, y=10mm, z=4mm
Zoom Scan : 7x7x7 : Measurement x=5mm, y=5mm, z=5mm

1 gram SAR value : 36.224 W/kg
10 gram SAR value : 19.063 W/kg
Area Scan Peak SAR : 37.677 W/kg
Zoom Scan Peak SAR : 62.065 W/kg

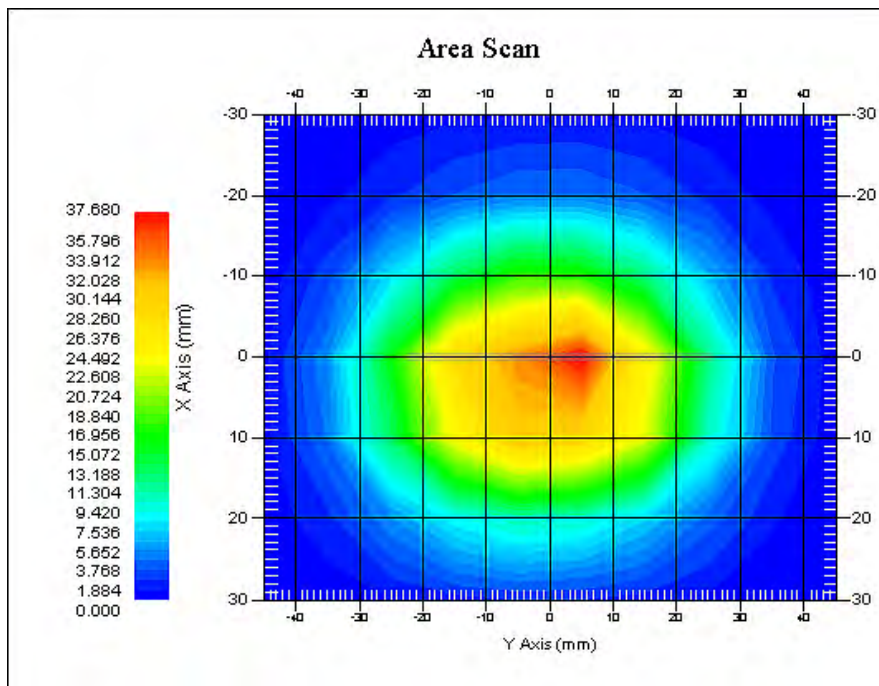

1750 MHz System Validation with Body Tissue

Test Laboratory: Bay Area Compliance Lab Corp. (Shenzhen)**System Performance Check 1900 MHz Head Liquid****Dipole 1900 MHz; Type: ALS-D-1900-S-2; S/N: 210-00710**

Product Data

Device Name : Dipole 1900MHz
Serial No. : 210-00710
Type : Dipole
Model : ALS-D-1900-S-2
Frequency Band : 1900
Max. Transmit Pwr : 1 W
Drift Time : 3 min(s)
Power Drift-Start : 37.032 W/kg
Power Drift-Finish : 37.052 W/kg
Power Drift (%) : 0.639

Phantom Data

Name : APREL-Uni
Type : Uni-Phantom
Serial No. : System Default
Location : Center
Description : Default

Tissue Data

Type : Head
Serial No. : 295-01103
Frequency : 1900.00 MHz
Last Calib. Date : 10-Apr-2015
Temperature : 20.00 °C
Ambient Temp. : 21.00 °C
Humidity : 56.00 RH%
Epsilon : 39.68 F/m
Sigma : 1.41 S/m
Density : 1000.00 kg/cu. M

Probe Data

Name : E-Field
Model : E-020
Type : E-Field Triangle
Serial No. : 500-00283
Last Calib. Date : 14-Oct-2014
Frequency Band : 1900
Duty Cycle Factor : 1
Conversion Factor : 4.8
Probe Sensitivity : 1.20 1.20 1.20 $\mu\text{V}/(\text{V}/\text{m})^2$
Compression Point : 95.00 mV
Offset : 1.56 mm

Measurement Data

Crest Factor : 1
Scan Type : Complete
Tissue Temp. : 20.00 °C
Ambient Temp. : 20.00 °C
Area Scan : 7x9x1 : Measurement x=10mm, y=10mm, z=4mm
Zoom Scan : 7x7x7 : Measurement x=5mm, y=5mm, z=5mm

1 gram SAR value : 39.125 W/kg
10 gram SAR value : 20.002 W/kg
Area Scan Peak SAR : 39.157 W/kg
Zoom Scan Peak SAR : 68.054 W/kg

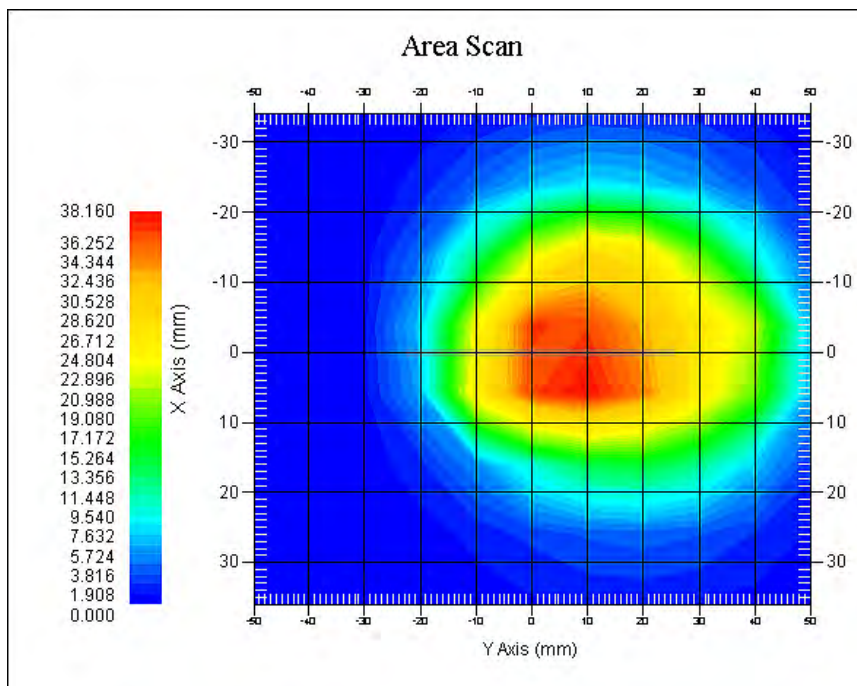

1900 MHz System Validation with Head Tissue

Test Laboratory: Bay Area Compliance Lab Corp. (Shenzhen)**System Performance Check 1900 MHz Body Liquid****Dipole 1900 MHz; Type: ALS-D-1900-S-2; S/N: 210-00710**

Product Data

Device Name : Dipole 1900MHz
Serial No. : 210-00710
Type : Dipole
Model : ALS-D-1900-S-2
Frequency Band : 1900
Max. Transmit Pwr : 1 W
Drift Time : 3 min(s)
Power Drift-Start : 38.003 W/kg
Power Drift-Finish : 38.196 W/kg
Power Drift (%) : 0.508

Phantom Data

Name : APREL-Uni
Type : Uni-Phantom
Serial No. : System Default
Location : Center
Description : Default

Tissue Data

Type : Body
Serial No. : 295-02102
Frequency : 1900.00 MHz
Last Calib. Date : 10-Apr-2015
Temperature : 20.00 °C
Ambient Temp. : 21.00 °C
Humidity : 56.00 RH%
Epsilon : 51.75 F/m
Sigma : 1.53 S/m
Density : 1000.00 kg/cu. m

Probe Data

Name : E-Field
Model : E-020
Type : E-Field Triangle
Serial No. : 500-00283
Last Calib. Date : 14-Oct-2014
Frequency Band : 1900
Duty Cycle Factor : 1
Conversion Factor : 4.5
Probe Sensitivity : 1.20 1.20 1.20 $\mu\text{V}/(\text{V}/\text{m})^2$
Compression Point : 95.00 mV
Offset : 1.56 mm

Measurement Data

Crest Factor : 1
Scan Type : Complete
Tissue Temp. : 20.00 °C
Ambient Temp. : 21.00 °C
Area Scan : 7x9x1 : Measurement x=10mm, y=10mm, z=4mm
Zoom Scan : 7x7x7 : Measurement x=5mm, y=5mm, z=5mm

1 gram SAR value : 39.559 W/kg
10 gram SAR value : 20.529 W/kg
Area Scan Peak SAR : 40.155 W/kg
Zoom Scan Peak SAR : 72.037 W/kg

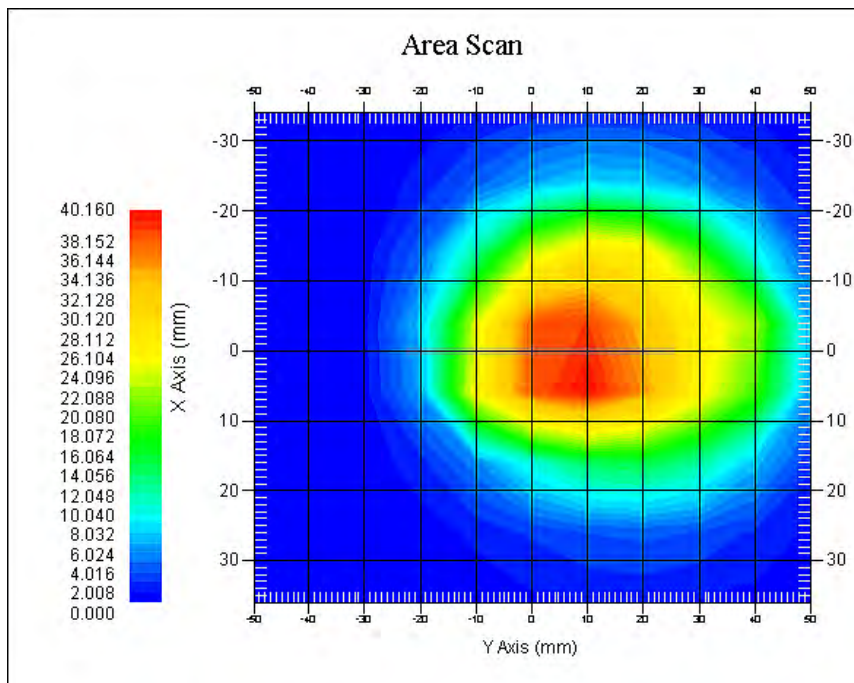

1900 MHz System Validation with Body Tissue

Test Laboratory: Bay Area Compliance Lab Corp. (Shenzhen)**System Performance Check 2450 MHz Head Liquid****Dipole 2450 MHz; Type: ALS-D-2450-S-2; S/N: 220-00758**

Product Data

Device Name : Dipole 2450MHz
Serial No. : 220-00758
Type : Dipole
Model : ALS-D-2450-S-2
Frequency Band : 2450 MHz
Max. Transmit Pwr : 1 W
Drift Time : 3 min(s)
Power Drift-Start : 50.124 W/kg
Power Drift-Finish : 50.658 W/kg
Power Drift (%) : 1.095

Phantom Data

Name : APREL-Uni
Type : Uni-Phantom
Serial No. : System Default
Location : Center
Description : Default

Tissue Data

Type : Head
Serial No. : 290-01109
Frequency : 2450.0 MHz
Last Calib. Date : 10-Apr-2015
Temperature : 20.00 °C
Ambient Temp. : 21.00 °C
Humidity : 50.00 RH%
Epsilon : 39.61 F/m
Sigma : 1.80 S/m
Density : 1000.00 kg/cu. M

Probe Data

Name : E-Field
Model : E-020
Type : E-Field Triangle
Serial No. : 500-00283
Last Calib. Date : 14-Oct-2014
Frequency Band : 2450 MHz
Duty Cycle Factor : 1
Conversion Factor : 4.3
Probe Sensitivity : 1.20 1.20 1.20 $\mu\text{V}/(\text{V}/\text{m})^2$
Compression Point : 95.00 mV
Offset : 1.56 mm

Measurement Data

Crest Factor : 1
Scan Type : Complete
Tissue Temp. : 20.00 °C
Ambient Temp. : 20.00 °C
Area Scan : 7x9x1 : Measurement x=10mm, y=10mm, z=4mm
Zoom Scan : 7x7x7 : Measurement x=5mm, y=5mm, z=5mm

1 gram SAR value : 53.628 W/kg
10 gram SAR value : 23.149 W/kg
Area Scan Peak SAR : 55.076 W/kg
Zoom Scan Peak SAR : 94.017 W/kg

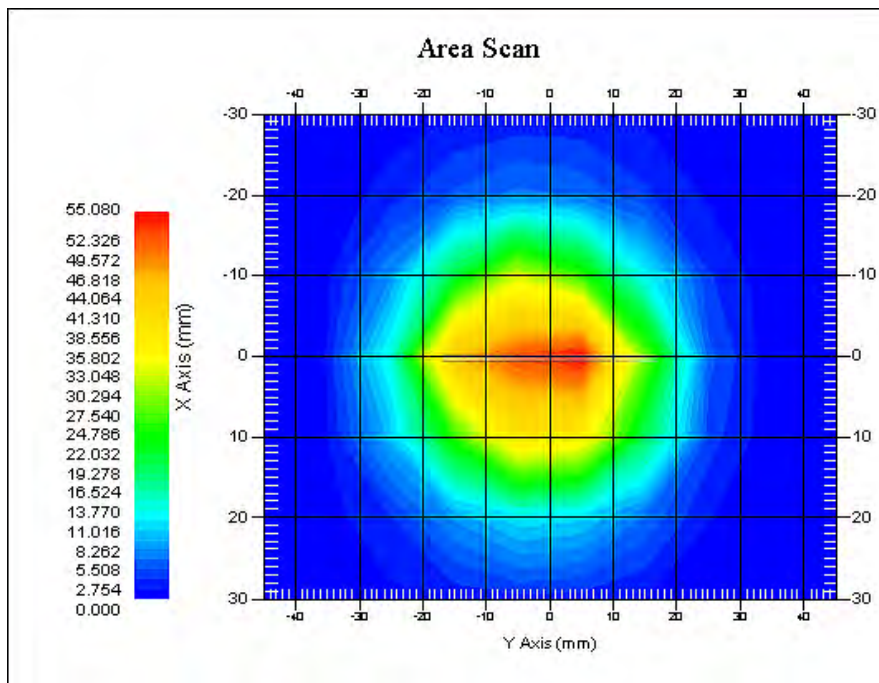

2450 MHz System Validation with Head Tissue

Test Laboratory: Bay Area Compliance Lab Corp. (Shenzhen)**System Performance Check 2450 MHz Body Liquid****Dipole 2450 MHz; Type: ALS-D-2450-S-2; S/N: 220-00758**

Product Data

Device Name : Dipole 2450MHz
Serial No. : 220-00758
Type : Dipole
Model : ALS-D-2450-S-2
Frequency Band : 2450 MHz
Max. Transmit Pwr : 1 W
Drift Time : 3 min(s)
Power Drift-Start : 51.325 W/kg
Power Drift-Finish : 52.339 W/kg
Power Drift (%) : 2.312

Phantom Data

Name : APREL-Uni
Type : Uni-Phantom
Serial No. : System Default
Location : Center
Description : Default

Tissue Data

Type : BODY
Serial No. : 290-01109
Frequency : 2450.0 MHz
Last Calib. Date : 10-Apr-2015
Temperature : 20.00 °C
Ambient Temp. : 21.00 °C
Humidity : 50.00 RH%
Epsilon : 51.74 F/m
Sigma : 1.90 S/m
Density : 1000.00 kg/cu. M

Probe Data

Name : E-Field
Model : E-020
Type : E-Field Triangle
Serial No. : 500-00283
Last Calib. Date : 14-Oct-2014
Frequency Band : 2450 MHz
Duty Cycle Factor : 1
Conversion Factor : 4.3
Probe Sensitivity : 1.20 1.20 1.20 $\mu\text{V}/(\text{V}/\text{m})^2$
Compression Point : 95.00 mV
Offset : 1.56 mm

Measurement Data

Crest Factor : 1
Scan Type : Complete
Tissue Temp. : 20.00 °C
Ambient Temp. : 20.00 °C
Area Scan : 8x9x1 : Measurement x=10mm, y=10mm, z=4mm
Zoom Scan : 7x7x7 : Measurement x=5mm, y=5mm, z=5mm

1 gram SAR value : 56.213 W/kg
10 gram SAR value : 24.964 W/kg
Area Scan Peak SAR : 58.089 W/kg
Zoom Scan Peak SAR : 90.347 W/kg

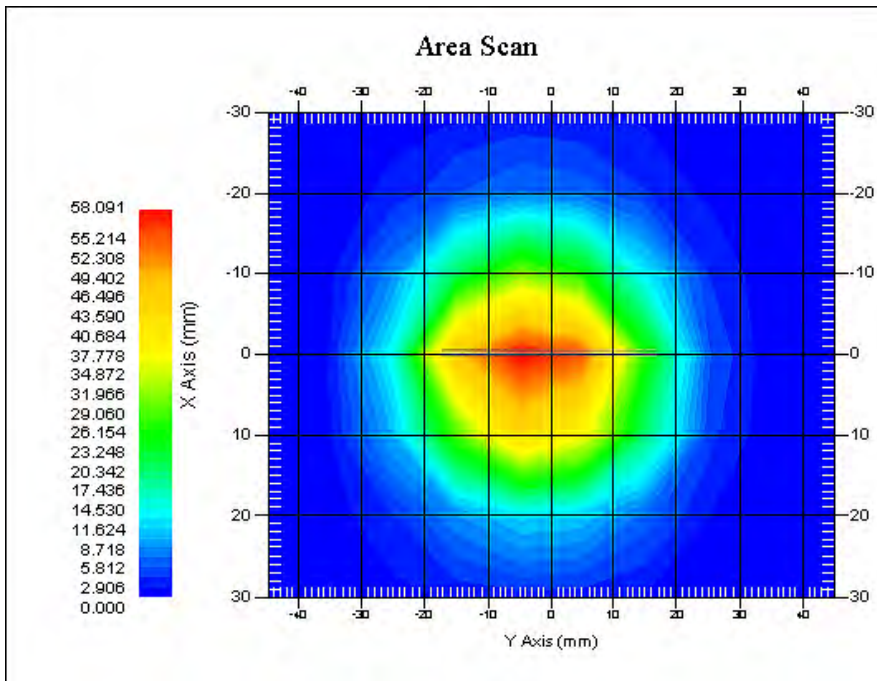

2450 MHz System Validation with Body Tissue

EUT TEST STRATEGY AND METHODOLOGY

Test Positions for Device Operating Next to a Person’s Ear

This category includes most wireless handsets with fixed, retractable or internal antennas located toward the top half of the device, with or without a foldout, sliding or similar keypad cover. The handset should have its earpiece located within the upper ¼ of the device, either along the centerline or off-centered, as perceived by its users. This type of handset should be positioned in a normal operating position with the “test device reference point” located along the “vertical centerline” on the front of the device aligned to the “ear reference point”. The “test device reference point” should be located at the same level as the center of the earpiece region. The “vertical centerline” should bisect the front surface of the handset at its top and bottom edges. A “ear reference point” is located on the outer surface of the head phantom on each ear spacer. It is located 1.5 cm above the center of the ear canal entrance in the “phantom reference plane” defined by the three lines joining the center of each “ear reference point” (left and right) and the tip of the mouth.

A handset should be initially positioned with the earpiece region pressed against the ear spacer of a head phantom. For the SCC-34/SC-2 head phantom, the device should be positioned parallel to the “N-F” line defined along the base of the ear spacer that contains the “ear reference point”. For interim head phantoms, the device should be positioned parallel to the cheek for maximum RF energy coupling. The “test device reference point” is aligned to the “ear reference point” on the head phantom and the “vertical centerline” is aligned to the “phantom reference plane”. This is called the “initial ear position”. While maintaining these three alignments, the body of the handset is gradually adjusted to each of the following positions for evaluating SAR:

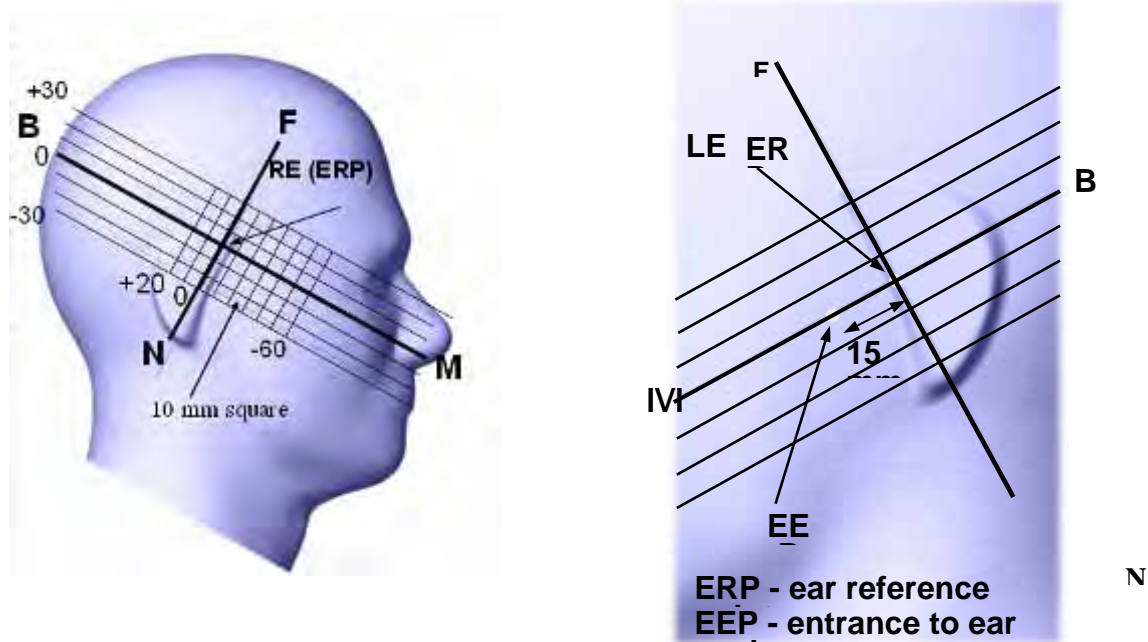

Cheek/Touch Position

The device is brought toward the mouth of the head phantom by pivoting against the “ear reference point” or along the “N-F” line for the SCC-34/SC-2 head phantom.

This test position is established:

- When any point on the display, keypad or mouthpiece portions of the handset is in contact with the phantom.
- (or) When any portion of a foldout, sliding or similar keypad cover opened to its intended self-adjusting normal use position is in contact with the cheek or mouth of the phantom.

For existing head phantoms – when the handset loses contact with the phantom at the pivoting point, rotation should continue until the device touches the cheek of the phantom or breaks its last contact from the ear spacer.

Cheek /Touch Position

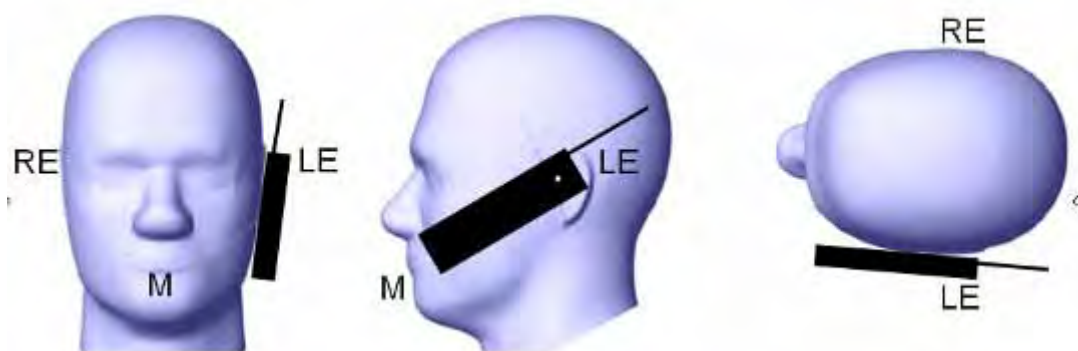

Ear/Tilt Position

With the handset aligned in the “Cheek/Touch Position”:

1) If the earpiece of the handset is not in full contact with the phantom’s ear spacer (in the “Cheek/Touch position”) and the peak SAR location for the “Cheek/Touch” position is located at the ear spacer region or corresponds to the earpiece region of the handset, the device should be returned to the “initial ear position” by rotating it away from the mouth until the earpiece is in full contact with the ear spacer.

2) (otherwise) The handset should be moved (translated) away from the cheek perpendicular to the line passes through both “ear reference points” (note: one of these ear reference points may not physically exist on a split head model) for approximate 2-3 cm. While it is in this position, the device handset is tilted away from the mouth with respect to the “test device reference point” until the inside angle between the vertical centerline on the front surface of the phone and the horizontal line passing through the ear reference point is by 15 80°. After the tilt, it is then moved (translated) back toward the head perpendicular to the line passes through both “ear reference points” until the device touches the phantom or the ear spacer. If the antenna touches the head first, the positioning process should be repeated with a tilt angle less than 15° so that the device and its antenna would touch the phantom simultaneously. This test position may require a device holder or positioner to achieve the translation and tilting with acceptable positioning repeatability.

If a device is also designed to transmit with its keypad cover closed for operating in the head position, such positions should also be considered in the SAR evaluation. The device should be tested on the left and right side of the head phantom in the “Cheek/Touch” and “Ear/Tilt” positions. When applicable, each configuration should be tested with the antenna in its fully extended and fully retracted positions. These test configurations should be tested at the high, middle and low frequency channels of each operating mode; for example, AMPS, CDMA, and TDMA. If the SAR measured at the middle channel for each test configuration (left, right, Cheek/Touch, Tilt/Ear, extended and retracted) is at least 2.0 dB lower than the SAR limit, testing at the high and low channels is optional for such test configuration(s). If the transmission band of the test device is less than 10 MHz, testing at the high and low frequency channels is optional.

Ear /Tilt 15° Position

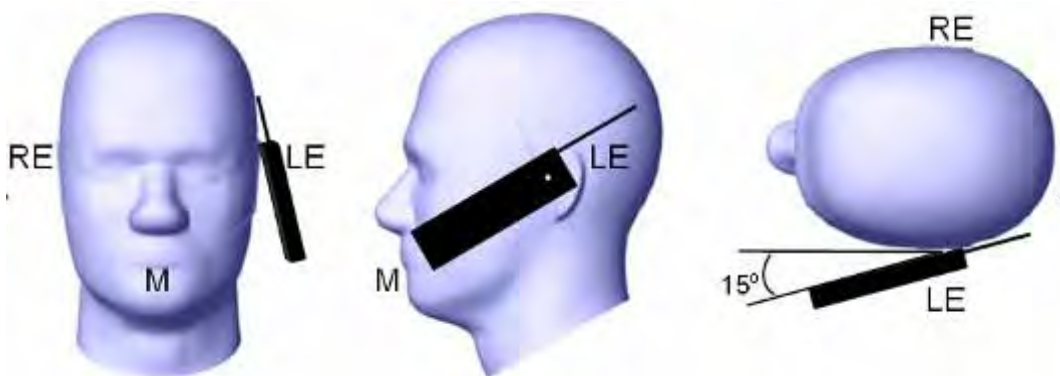

Test positions for body-worn and other configurations

Body-worn operating configurations should be tested with the belt-clips and holsters attached to the device and positioned against a flat phantom in normal use configurations. Devices with a headset output should be tested with a headset connected to the device. When multiple accessories that do not contain metallic components are supplied with the device, the device may be tested with only the accessory that dictates the closest spacing to the body. When multiple accessories that contain metallic components are supplied with the device, the device must be tested with each accessory that contains a unique metallic component. If multiple accessories share an identical metallic component (e.g., the same metallic belt-clip used with different holsters with no other metallic components), only the accessory that dictates the closest spacing to the body must be tested.

Body-worn accessories may not always be supplied or available as options for some devices that are intended to be authorized for body-worn use. A separation distance of 1.5 cm between the back of the device and a flat phantom is recommended for testing body-worn SAR compliance under such circumstances. Other separation distances may be used, but they should not exceed 2.5 cm. In these cases, the device may use body-worn accessories that provide a separation distance greater than that tested for the device provided however that the accessory contains no metallic components.

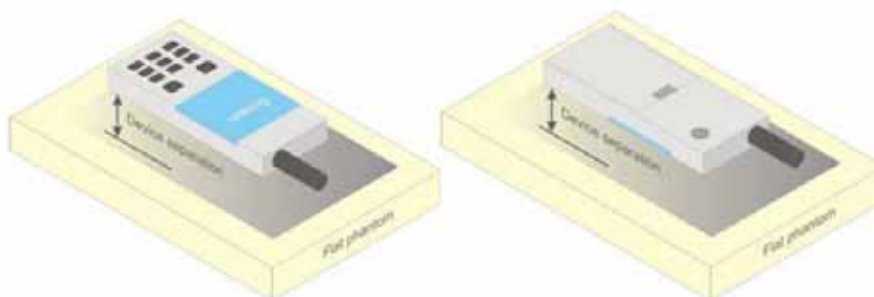

Figure 5 – Test positions for body-worn devices

SAR Evaluation Procedure

The evaluation was performed with the following procedure:

Step 1: Measurement of the SAR value at a fixed location above the ear point or central position was used as a reference value for assessing the power drop. The SAR at this point is measured at the start of the test and then again at the end of the testing.

Step 2: The SAR distribution at the exposed side of the head was measured at a distance of 4 mm from the inner surface of the shell. The area covered the entire dimension of the head or EUT and the horizontal grid spacing was 10 mm x 10 mm. Based on these data, the area of the maximum absorption was determined by spline interpolation. The first Area Scan covers the entire dimension of the EUT to ensure that the hotspot was correctly identified.

Step 3: Around this point, a volume of 35 mm x 35 mm x 35 mm was assessed by measuring 7x 7 x 7 points. On the basis of this data set, the spatial peak SAR value was evaluated under the following procedure:

- 1) The data at the surface were extrapolated, since the center of the dipoles is 1.2 mm away from the tip of the probe and the distance between the surface and the lowest measuring point is 1.3 mm. The extrapolation was based on a least square algorithm. A polynomial of the fourth order was calculated through the points in z-axes. This polynomial was then used to evaluate the points between the surface and the probe tip.
- 2) The maximum interpolated value was searched with a straightforward algorithm. Around this maximum the SAR values averaged over the spatial volumes (1 g or 10 g) were computed by the 3D-Spline interpolation algorithm. The 3D-Spline is composed of three one dimensional splines with the "Not a knot"-condition (in x, y and z-directions). The volume was integrated with the trapezoidal-algorithm. One thousand points (10 x 10 x 10) were interpolated to calculate the averages.

All neighboring volumes were evaluated until no neighboring volume with a higher average value was found.

Step 4: Re-measurement of the SAR value at the same location as in Step 1. If the value changed by more than 5%, the evaluation was repeated.

Test methodology

KDB 447498 D01 General RF Exposure Guidance v05r02.
KDB 648474 D04 Handset SAR v01r02.
KDB 865664 D01 SAR measurement 100 MHz to 6 GHz v01r03
KDB 865664 D02 RF Exposure Reporting v01r01
KDB 941225 D01 3G SAR Procedures v03
KDB 941225 D05 SAR for LTE Devices v02r03
KDB 941225 D06 Hotspot Mode v02

CONDUCTED OUTPUT POWER MEASUREMENT

Provision Applicable

The measured peak output power should be greater and within 5% than EMI measurement.

Test Procedure

The RF output of the transmitter was connected to the input of the EMI Test Receiver through sufficient attenuation.

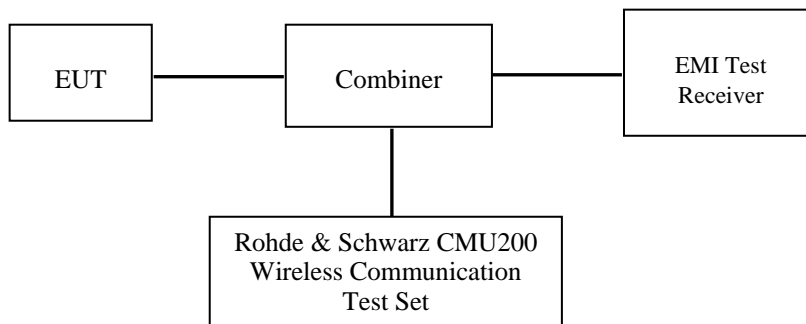

GSM&3G

Maximum Output Power among production units

Max Target Power for Production Unit (dBm)			
Mode/Band	Channel		
	Low	Middle	High
GSM 850	32.20	32.20	32.20
GPRS 1 slot	32.30	32.30	32.30
GPRS 2 slot	31.50	31.50	31.50
GPRS 3 slot	29.80	29.80	29.80
GPRS 4 slot	28.60	28.60	28.60
EGPRS 1 slot	26.20	26.20	26.20
EGPRS 2 slot	25.10	25.10	25.10
EGPRS 3 slot	23.10	23.10	23.10
EGPRS 4 slot	22.00	22.00	22.00
PCS 1900	29.50	32.20	32.20
GPRS 1 slot	29.50	29.50	29.50
GPRS 2 slot	28.90	28.90	28.90
GPRS 3 slot	27.00	27.00	27.50
GPRS 4 slot	25.80	25.80	25.80
EGPRS 1 slot	26.70	26.70	26.70
EGPRS 2 slot	24.70	24.70	24.70
EGPRS 3 slot	22.80	22.80	22.80
EGPRS 4 slot	21.60	21.60	21.60
WCDMA850	22.00	22.00	22.00
WCDMA1700	22.30	22.30	22.30
WCDMA1900	22.00	22.00	22.00
LTE Band2	23.00	23.00	23.00
LTE Band4	22.10	22.10	22.10

LTE Band5	23.10	23.10	23.10
LTE Band7	23.00	23.00	23.00
LTE Band17	23.00	23.00	23.00
Wi-Fi	10.00	10.00	10.00
Bluetooth	2.00	2.00	2.00

Test Results:

GSM:

Band	Frequency (MHz)	Conducted Output Power	
		Meas. Power (dBm)	Meas. Power (W)
GSM 850	824.2	32.14	1.637
	836.6	32.18	1.652
	848.8	32.17	1.648
PCS 1900	1850.2	29.23	0.838
	1880.0	29.14	0.820
	1909.8	29.47	0.885

GPRS:

Band	Channel No.	Frequency (MHz)	RF Output Power (dBm)			
			1 slot	2 slot	3 slots	4 slots
GSM 850	128	824.2	32.08	31.37	29.67	28.50
	190	836.6	32.14	31.41	29.70	28.55
	251	848.8	32.14	31.43	29.71	28.57
PCS 1900	512	1850.2	29.17	28.55	26.88	25.27
	661	1880.0	29.09	28.53	26.87	25.26
	810	1909.8	29.45	28.87	27.32	25.72

EGPRS:

Band	Channel No.	Frequency (MHz)	RF Output Power (dBm)			
			1 slot	2 slot	3 slots	4 slots
GSM 850	128	824.2	26.02	24.83	22.85	21.73
	190	836.6	26.19	25.05	23.06	21.88
	251	848.8	26.14	24.93	22.89	21.77
PCS 1900	512	1850.2	25.67	24.68	22.78	21.53
	661	1880.0	25.57	24.60	22.55	21.30
	810	1909.8	25.57	24.56	22.58	21.34

For SAR, the time based average power is relevant, the difference in between depends on the duty cycle of the TDMA signal.

Number of Time slot	1	2	3	4
Duty Cycle	1:8	1:4	1:2.66	1:2
Time based Ave. power compared to slotted Ave. power	-9 dB	-6 dB	-4.25 dB	-3 dB
Crest Factor	8	4	2.66	2

The time based average power for GPRS

Band	Channel No.	Frequency (MHz)	Time based average Power (dBm)			
			1 slot	2 slot	3 slots	4 slots
GSM 850	128	824.2	23.08	25.37	25.42	25.50
	190	836.6	23.14	25.41	25.45	25.55
	251	848.8	23.14	25.43	25.46	25.57
PCS 1900	512	1850.2	20.17	22.55	22.63	22.27
	661	1880.0	20.09	22.53	22.62	22.26
	810	1909.8	20.45	22.87	23.07	22.72

The time based average power for EGPRS

Band	Channel No.	Frequency (MHz)	Time based average Power (dBm)			
			1 slot	2 slot	3 slots	4 slots
GSM 850	128	824.2	17.02	18.83	18.60	18.73
	190	836.6	17.19	19.05	18.81	18.88
	251	848.8	17.14	18.93	18.64	18.77
PCS 1900	512	1850.2	16.67	18.68	18.53	18.53
	661	1880.0	16.57	18.60	18.30	18.30
	810	1909.8	16.57	18.56	18.33	18.34

Note:

1. Rohde & Schwarz Radio Communication Tester (CMU200) was used for the measurement of GSM peak and average output power for active timeslots.
2. For GSM voice, 1 timeslot has been activated with power level 5 (850 MHz band) and 0 (1900 MHz band).
3. For GPRS, 1, 2, 3 and 4 timeslots has been activated separately with power level 3(850 MHz band) and 3(1900 MHz band).
4. For EGPRS, 1, 2, 3 and 4 timeslots has been activated separately with power level 6(850 MHz band) and 5(1900 MHz band).
5. According to KDB941225D06-SAR for GPRS and EDGE modes are not required when the source-based time-averaged output power for each data mode is lower than that in the normal GSM voice mode

WCDMA-Release 99:

The following tests were conducted according to the test requirements outlines in section 5.2 of the 3GPP TS34.121-1 specification. The EUT has a nominal maximum output power of 24dBm (+1.7/-3.7).

WCDMA General Settings	Loopback Mode	Test Mode 1
	Rel99 RMC	12.2kbps RMC
	Power Control Algorithm	Algorithm2
	β_c / β_d	8/15

WCDMA HSDPA

The following tests were conducted according to the test requirements outlines in section 5.2 of the 3GPP TS34.121-1 specification.

	Mode	HSDPA	HSDPA	HSDPA	HSDPA
	Subset	1	2	3	4
WCDMA General Settings	Loopback Mode	Test Mode 1			
	Rel99 RMC	12.2kbps RMC			
	HSDPA FRC	H-Set1			
	Power Control Algorithm	Algorithm2			
	c	2/15	12/15	15/15	15/15
	d	15/15	15/15	8/15	4/15
	d (SF)	64			
	c/ d	2/15	12/15	15/8	15/4
	hs	4/15	24/15	30/15	30/15
MPR(dB)	0	0	0.5	0.5	
HSDPA Specific Settings	D_{ACK}	8			
	D_{NAK}	8			
	D_{CQI}	8			
	Ack-Nack repetition factor	3			
	CQI Feedback	4ms			
	CQI Repetition Factor	2			
	$A_{hs} = h_s / c$	30/15			

WCDMA HSUPA

The following tests were conducted according to the test requirements outlines in section 5.2 of the 3GPP TS34.121-1 specification.

	Mode	HSUPA	HSUPA	HSUPA	HSUPA	HSUPA
	Subset	1	2	3	4	5
WCDMA General Settings	Loopback Mode	Test Mode 1				
	Rel99 RMC	12.2kbps RMC				
	HSDPA FRC	H-Set1				
	HSUPA Test	HSUPA Loopback				
	Power Control Algorithm	Algorithm2				
	c	11/15	6/15	15/15	2/15	15/15
	d	15/15	15/15	9/15	15/15	0
	ec	209/225	12/15	30/15	2/15	5/15
	c/ d	11/15	6/15	15/9	2/15	-
	hs	22/15	12/15	30/15	4/15	5/15
	CM(dB)	1.0	3.0	2.0	3.0	1.0
MPR(dB)	0	2	1	2	0	
HSDPA Specific Settings	DACK	8				
	DNAK	8				
	DCQI	8				
	Ack-Nack repetition factor	3				
	CQI Feedback	4ms				
	CQI Repetition Factor	2				
	A _{hs} = hs/ c	30/15				
HSUPA Specific Settings	DE-DPCCH	6	8	8	5	7
	DHARQ	0	0	0	0	0
	AG Index	20	12	15	17	21
	ETFCI	75	67	92	71	81
	Associated Max UL Data Rate kbps	242.1	174.9	482.8	205.8	308.9
	Reference E _{FCI} s	E-TFCI 11 E E-TFCI PO 4 E-TFCI 67 E-TFCI PO 18 E-TFCI 71 E-TFCI PO23 E-TFCI 75 E-TFCI PO26 E-TFCI 81 E-TFCI PO 27	E-TFCI 11 E-TFCI PO4 E-TFCI 92 E-TFCI PO 18	E-TFCI 11 E E-TFCI PO 4 E-TFCI 67 E-TFCI PO 18 E-TFCI 71 E-TFCI PO23 E-TFCI 75 E-TFCI PO26 E-TFCI 81 E-TFCI PO 27		

Results (12.2kbps RMC)

Band	Frequency (MHz)	Channel NO.	Conducted Output Power	
			(dBm)	(Watt)
WCDMA 850	826.4	4132	21.92	0.156
	836.6	4183	21.70	0.148
	846.6	4233	21.78	0.151
WCDMA 1700	1712.4	8562	22.15	0.164
	1732.4	8662	22.11	0.163
	1752.6	8763	22.23	0.167
WCDMA 1700	1852.4	9262	21.83	0.152
	1880.0	9400	21.97	0.157
	1907.6	9538	21.67	0.147

Results (HSDPA)

Band	Frequency (MHz)	Channel NO.	Conducted Output Power (dBm)			
			Subset 1	Subset 2	Subset 3	Subset 4
WCDMA 850	826.4	4132	20.65	20.60	20.59	20.57
	836.6	4183	20.42	20.47	20.41	20.45
	846.6	4233	20.51	20.53	20.57	20.54
WCDMA 1700	1712.4	8562	21.35	21.32	21.33	21.34
	1732.4	8662	21.07	21.08	21.05	21.09
	1752.6	8763	21.53	21.50	21.54	21.55
WCDMA 1900	1852.4	9262	20.85	20.83	20.84	20.86
	1880.0	9400	21.02	21.01	21.04	21.05
	1907.6	9538	20.53	20.56	20.57	20.54

Results (HSUPA)

Band	Frequency (MHz)	Channel NO.	Conducted Output Power (dBm)				
			Subset 1	Subset 2	Subset 3	Subset 4	Subset 5
WCDMA 850	826.4	4132	20.47	20.49	20.45	20.44	20.46
	836.6	4183	20.15	20.15	20.17	20.14	20.13
	846.6	4233	20.30	20.29	20.28	20.27	20.25
WCDMA 1700	1712.4	8562	20.89	20.87	20.88	20.86	20.83
	1732.4	8662	20.66	20.69	20.68	20.64	20.61
	1752.6	8763	21.05	21.02	21.07	21.04	21.03
WCDMA 1900	1852.4	9262	20.64	20.69	20.68	20.62	20.63
	1880.0	9400	20.74	20.76	20.71	20.72	20.75
	1907.6	9538	20.44	20.42	20.45	20.43	20.47

Note:

1. The default test configuration is to measure SAR with an established radio link between the EUT and a communication test set using a 12.2 kbps RMC (reference measurement Channel) Configured in Test Loop Model 1.

2. KDB 941225 D01-Body SAR is not required for HSDPA when the maximum average output of each RF channel with HSDPA active is less than ¼ dB higher than measured without HSDPA using 12.2kbps RMC or the maximum SAR for 12.2kbps RMC is < 75% of SAR limit.
3. KDB 941225 D01-Body SAR is not required for HSUPA when the maximum average output of each RF channel with HSUPA active is less than ¼ dB higher than measured without HSUPA using 12.2kbps RMC and the maximum SAR for 12.2kbps RMC is < 75% of SAR limit.

LTE Band 2:

BW	Modulation	Resource Block Size & Resource Block Offset	Ave Tx Power(dBm)		
			Low Channel	Mid Channel	High Channel
1.4M	QPSK	RB Size=1, RB Offset=0	22.23	22.50	22.52
		RB Size=1, RB Offset=2	22.19	22.51	22.53
		RB Size=1, RB Offset=5	22.24	22.54	22.02
		RB Size=3, RB Offset=0	22.18	22.53	22.52
		RB Size=3, RB Offset=1	22.19	22.54	22.51
		RB Size=3, RB Offset=2	22.22	22.51	22.54
	16-QAM	RB Size=6, RB Offset=0	21.19	21.51	21.53
		RB Size=1, RB Offset=0	21.43	21.66	21.68
		RB Size=1, RB Offset=2	21.18	21.63	22.63
		RB Size=1, RB Offset=5	21.42	21.65	21.22
		RB Size=3, RB Offset=0	21.43	21.34	21.23
		RB Size=3, RB Offset=1	21.44	21.45	21.20
		RB Size=3, RB Offset=2	21.45	21.65	21.24
		RB Size=6, RB Offset=0	20.38	20.65	20.58
3M	QPSK	RB Size=1, RB Offset=0	22.32	22.58	22.79
		RB Size=1, RB Offset=7	22.30	22.52	22.71
		RB Size=1, RB Offset=14	22.26	22.63	22.16
		RB Size=8, RB Offset=0	22.31	22.51	22.23
		RB Size=8, RB Offset=4	22.29	22.41	22.28
		RB Size=8, RB Offset=7	22.31	22.54	22.34
		RB Size=15, RB Offset=0	21.24	21.58	21.80
	16-QAM	RB Size=1, RB Offset=0	21.50	21.63	22.22
		RB Size=1, RB Offset=7	21.50	21.32	22.05
		RB Size=1, RB Offset=14	21.49	21.68	21.74
		RB Size=8, RB Offset=0	21.47	21.30	21.76
		RB Size=8, RB Offset=4	21.45	21.33	21.80
		RB Size=8, RB Offset=7	21.46	21.38	21.81
		RB Size=15, RB Offset=0	20.40	20.76	20.84
5M	QPSK	RB Size=1, RB Offset=0	22.07	22.29	22.19
		RB Size=1, RB Offset=12	22.28	21.67	22.25
		RB Size=1, RB Offset=24	22.22	22.34	22.23
		RB Size=12, RB Offset=0	22.26	22.31	22.35
		RB Size=12, RB Offset=6	22.21	22.20	22.12
		RB Size=12, RB Offset=11	22.24	22.23	22.35
		RB Size=25, RB Offset=0	20.91	21.14	21.80
	16-QAM	RB Size=1, RB Offset=0	21.82	21.68	22.03
		RB Size=1, RB Offset=12	21.53	21.64	22.36
		RB Size=1, RB Offset=24	21.76	21.67	21.50
		RB Size=12, RB Offset=0	21.74	21.65	21.51
		RB Size=12, RB Offset=6	21.75	21.57	21.59
		RB Size=12, RB Offset=11	21.56	21.59	21.58
		RB Size=25, RB Offset=0	20.33	20.55	20.83

10M	QPSK	RB Size=1, RB Offset=0	21.78	22.47	22.35
		RB Size=1, RB Offset=24	21.75	22.45	22.31
		RB Size=1, RB Offset=49	21.76	22.52	22.26
		RB Size=25, RB Offset=0	21.74	22.50	22.37
		RB Size=25, RB Offset=12	21.69	22.51	22.51
		RB Size=25, RB Offset=24	21.75	22.42	22.63
		RB Size=50, RB Offset=0	21.77	21.87	22.41
	16-QAM	RB Size=1, RB Offset=0	21.70	22.41	22.58
		RB Size=1, RB Offset=24	21.74	22.32	22.57
		RB Size=1, RB Offset=49	21.73	22.33	22.59
		RB Size=25, RB Offset=0	21.75	22.34	22.41
		RB Size=25, RB Offset=12	21.72	22.35	22.48
		RB Size=25, RB Offset=24	21.77	22.53	22.50
		RB Size=50, RB Offset=0	21.76	21.14	22.62
15M	QPSK	RB Size=1, RB Offset=0	22.31	21.97	22.2
		RB Size=1, RB Offset=37	22.31	21.95	22.65
		RB Size=1, RB Offset=74	22.53	21.90	21.91
		RB Size=36, RB Offset=0	22.45	21.94	22.10
		RB Size=36, RB Offset=18	22.39	21.92	22.00
		RB Size=36, RB Offset=37	22.38	21.93	22.72
		RB Size=75, RB Offset=0	22.24	21.90	22.55
	16-QAM	RB Size=1, RB Offset=0	22.20	21.87	21.93
		RB Size=1, RB Offset=37	22.21	21.88	21.97
		RB Size=1, RB Offset=74	22.37	21.92	22.58
		RB Size=36, RB Offset=0	22.10	21.9	22.61
		RB Size=36, RB Offset=18	22.03	21.87	22.17
		RB Size=36, RB Offset=37	22.09	21.86	21.93
		RB Size=75, RB Offset=0	22.08	21.85	22.43
20M	QPSK	RB Size=1, RB Offset=0	22.75	22.68	22.71
		RB Size=1, RB Offset=49	22.39	22.09	22.43
		RB Size=1, RB Offset=99	22.31	22.04	22.58
		RB Size=50, RB Offset=0	22.34	22.03	22.23
		RB Size=50, RB Offset=24	22.38	22.14	22.38
		RB Size=50, RB Offset=49	22.32	22.32	22.49
		RB Size=100, RB Offset=0	22.30	22.37	22.39
	16-QAM	RB Size=1, RB Offset=0	22.45	22.16	22.51
		RB Size=1, RB Offset=49	22.30	22.17	22.19
		RB Size=1, RB Offset=99	22.31	22.63	22.34
		RB Size=50, RB Offset=0	22.29	22.61	22.65
		RB Size=50, RB Offset=24	22.31	22.65	22.18
		RB Size=50, RB Offset=49	22.28	22.67	22.4
		RB Size=100, RB Offset=0	22.37	22.64	22.21

LTE Band 4:

BW	Modulation	Resource Block Size& Resource Block Offset	Ave Tx Power (dBm)		
			Low Channel	Mid Channel	High Channel
1.4M	QPSK	RB Size=1, RB Offset=0	21.15	21.64	21.34
		RB Size=1, RB Offset=2	20.89	21.71	21.22
		RB Size=1, RB Offset=5	21.04	21.67	21.31
		RB Size=3, RB Offset=0	20.86	21.72	21.18
		RB Size=3, RB Offset=1	20.45	21.65	21.10
		RB Size=3, RB Offset=2	20.47	21.69	21.11
		RB Size=6, RB Offset=0	20.77	21.63	21.21
	16QAM	RB Size=1, RB Offset=0	21.01	21.58	21.21
		RB Size=1, RB Offset=2	20.89	21.65	21.12
		RB Size=1, RB Offset=5	20.96	21.62	21.31
		RB Size=3, RB Offset=0	20.74	21.59	21.34
		RB Size=3, RB Offset=1	20.70	21.57	21.36
		RB Size=3, RB Offset=2	20.70	21.60	21.51
		RB Size=6, RB Offset=0	20.50	21.65	21.35
3M	QPSK	RB Size=1, RB Offset=0	20.75	21.50	21.39
		RB Size=1, RB Offset=7	20.76	21.51	21.36
		RB Size=1, RB Offset=14	20.68	21.62	21.53
		RB Size=8, RB Offset=0	20.75	21.63	21.56
		RB Size=8, RB Offset=4	20.74	21.67	21.50
		RB Size=8, RB Offset=7	20.71	21.64	21.59
		RB Size=15, RB Offset=0	20.73	21.58	21.50
	16QAM	RB Size=1, RB Offset=0	21.02	21.89	21.50
		RB Size=1, RB Offset=7	21.04	21.87	21.37
		RB Size=1, RB Offset=14	20.89	21.90	21.35
		RB Size=8, RB Offset=0	20.69	21.09	21.34
		RB Size=8, RB Offset=4	20.70	21.08	21.38
		RB Size=8, RB Offset=7	20.73	21.15	21.32
		RB Size=15, RB Offset=0	20.78	21.24	21.49
5M	QPSK	RB Size=1, RB Offset=0	20.58	21.65	21.07
		RB Size=1, RB Offset=12	20.63	21.31	21.07
		RB Size=1, RB Offset=24	20.65	22.01	21.09
		RB Size=12, RB Offset=0	20.64	21.14	21.08
		RB Size=12, RB Offset=6	20.62	21.16	21.09
		RB Size=12, RB Offset=11	20.67	21.15	21.08
		RB Size=25, RB Offset=0	20.63	21.30	20.79
	16QAM	RB Size=1, RB Offset=0	20.71	21.69	21.24
		RB Size=1, RB Offset=12	20.78	21.63	21.21
		RB Size=1, RB Offset=24	20.87	21.82	21.37
		RB Size=12, RB Offset=0	20.93	21.81	21.34
		RB Size=12, RB Offset=6	20.91	21.82	21.32
		RB Size=12, RB Offset=11	20.94	21.85	21.36
		RB Size=25, RB Offset=0	20.25	21.25	20.98

10M	QPSK	RB Size=1, RB Offset=0	20.46	21.81	20.94
		RB Size=1, RB Offset=24	20.45	21.83	20.87
		RB Size=1, RB Offset=49	20.35	21.69	20.40
		RB Size=25, RB Offset=0	20.31	21.68	20.76
		RB Size=25, RB Offset=12	20.45	21.66	20.65
		RB Size=25, RB Offset=24	20.56	22.00	20.87
		RB Size=50, RB Offset=0	20.32	21.11	20.91
	16QAM	RB Size=1, RB Offset=0	20.33	21.30	20.98
		RB Size=1, RB Offset=24	20.36	22.03	20.34
		RB Size=1, RB Offset=49	20.59	21.35	20.57
		RB Size=25, RB Offset=0	20.67	22.04	20.66
		RB Size=25, RB Offset=12	20.64	21.14	20.78
		RB Size=25, RB Offset=24	20.51	21.11	20.74
		RB Size=50, RB Offset=0	20.40	21.20	20.86
15M	QPSK	RB Size=1, RB Offset=0	20.56	21.80	21.89
		RB Size=1, RB Offset=37	20.61	21.78	21.69
		RB Size=1, RB Offset=74	20.67	21.91	21.32
		RB Size=36, RB Offset=0	20.63	21.36	21.45
		RB Size=36, RB Offset=18	20.64	21.38	21.31
		RB Size=36, RB Offset=37	20.71	21.34	21.37
		RB Size=75, RB Offset=0	20.57	21.71	21.46
	16QAM	RB Size=1, RB Offset=0	20.59	22.05	21.12
		RB Size=1, RB Offset=37	20.65	21.34	21.15
		RB Size=1, RB Offset=74	21.16	21.25	21.41
		RB Size=36, RB Offset=0	21.34	21.31	21.15
		RB Size=36, RB Offset=18	21.41	21.37	21.13
		RB Size=36, RB Offset=37	20.37	21.65	21.14
		RB Size=75, RB Offset=0	20.50	22.01	21.15
20M	QPSK	RB Size=1, RB Offset=0	21.89	21.92	22.05
		RB Size=1, RB Offset=49	20.66	21.35	21.68
		RB Size=1, RB Offset=99	21.56	21.25	20.25
		RB Size=50, RB Offset=0	21.77	21.71	21.84
		RB Size=50, RB Offset=24	20.71	21.45	21.54
		RB Size=50, RB Offset=49	20.68	21.40	21.46
		RB Size=100, RB Offset=0	20.58	22.04	21.30
	16QAM	RB Size=1, RB Offset=0	20.35	21.60	21.50
		RB Size=1, RB Offset=49	20.53	21.63	21.69
		RB Size=1, RB Offset=99	21.63	21.65	20.74
		RB Size=50, RB Offset=0	21.45	21.64	21.77
		RB Size=50, RB Offset=24	20.85	21.62	21.74
		RB Size=50, RB Offset=49	20.83	21.64	21.71
		RB Size=100, RB Offset=0	20.86	21.94	21.37

LTE Band 5:

BW	Modulation	Resource Block Size& Resource Block Offset	Ave Tx Power (dBm)		
			Low Channel	Mid Channel	High Channel
1.4M	QPSK	RB Size=1, RB Offset=0	22.58	22.64	22.53
		RB Size=1, RB Offset=2	22.44	22.70	22.95
		RB Size=1, RB Offset=5	22.39	22.59	22.25
		RB Size=3, RB Offset=0	22.61	22.56	22.90
		RB Size=3, RB Offset=1	22.28	22.58	22.84
		RB Size=3, RB Offset=2	22.31	22.63	22.92
		RB Size=6, RB Offset=0	21.24	21.55	21.70
	16QAM	RB Size=1, RB Offset=0	21.82	21.88	21.69
		RB Size=1, RB Offset=2	21.27	21.90	23.01
		RB Size=1, RB Offset=5	21.58	21.91	21.23
		RB Size=3, RB Offset=0	21.62	21.77	21.42
		RB Size=3, RB Offset=1	21.65	21.73	21.66
		RB Size=3, RB Offset=2	21.57	21.89	21.28
		RB Size=6, RB Offset=0	20.86	20.68	20.80
3M	QPSK	RB Size=1, RB Offset=0	22.33	22.87	22.17
		RB Size=1, RB Offset=7	22.71	22.85	22.15
		RB Size=1, RB Offset=14	22.62	23.01	22.34
		RB Size=8, RB Offset=0	22.49	22.90	22.27
		RB Size=8, RB Offset=4	22.50	22.58	22.33
		RB Size=8, RB Offset=7	22.67	22.62	22.58
		RB Size=15, RB Offset=0	21.43	21.99	21.91
	16QAM	RB Size=1, RB Offset=0	21.50	21.91	22.51
		RB Size=1, RB Offset=7	21.85	21.55	22.17
		RB Size=1, RB Offset=14	21.89	22.07	22.03
		RB Size=8, RB Offset=0	21.95	21.59	22.15
		RB Size=8, RB Offset=4	21.46	21.47	22.28
		RB Size=8, RB Offset=7	21.65	21.55	22.24
		RB Size=15, RB Offset=0	20.96	21.01	20.89
5M	QPSK	RB Size=1, RB Offset=0	22.45	21.67	22.16
		RB Size=1, RB Offset=12	22.59	22.13	22.87
		RB Size=1, RB Offset=24	22.46	22.68	22.31
		RB Size=12, RB Offset=0	22.72	23.03	22.56
		RB Size=12, RB Offset=6	22.24	22.81	22.44
		RB Size=12, RB Offset=11	22.25	22.70	22.95
		RB Size=25, RB Offset=0	21.29	21.58	22.07
	16QAM	RB Size=1, RB Offset=0	22.32	21.87	22.08
		RB Size=1, RB Offset=12	21.76	22.13	22.82
		RB Size=1, RB Offset=24	21.87	21.96	21.65
		RB Size=12, RB Offset=0	21.92	21.83	21.61
		RB Size=12, RB Offset=6	21.78	21.96	21.64
		RB Size=12, RB Offset=11	21.59	21.72	21.62
		RB Size=25, RB Offset=0	20.54	20.76	21.15

10M	QPSK	RB Size=1, RB Offset=0	23.05	22.82	22.94
		RB Size=1, RB Offset=24	22.10	22.69	22.74
		RB Size=1, RB Offset=49	21.93	22.84	22.41
		RB Size=25, RB Offset=0	22.95	22.81	22.61
		RB Size=25, RB Offset=12	22.02	22.83	22.60
		RB Size=25, RB Offset=24	21.81	22.49	22.76
		RB Size=50, RB Offset=0	22.10	22.00	22.86
	16QAM	RB Size=1, RB Offset=0	21.73	22.88	22.83
		RB Size=1, RB Offset=24	22.04	22.55	23.02
		RB Size=1, RB Offset=49	22.15	22.57	22.91
		RB Size=25, RB Offset=0	22.14	22.51	22.89
		RB Size=25, RB Offset=12	22.08	22.37	22.49
		RB Size=25, RB Offset=24	21.85	22.94	22.98
		RB Size=50, RB Offset=0	21.84	21.19	22.08

LTE Band 7:

BW	Modulation	Resource Block Size & Resource Block Offset	Ave Tx Power (dBm)		
			Low Channel	Mid Channel	High Channel
5M	QPSK	RB Size=1, RB Offset=0	22.46	21.77	22.01
		RB Size=1, RB Offset=12	22.33	21.83	21.95
		RB Size=1, RB Offset=24	22.32	22.71	22.50
		RB Size=12, RB Offset=0	22.45	21.86	22.54
		RB Size=12, RB Offset=6	22.27	22.14	22.23
		RB Size=12, RB Offset=11	22.32	22.14	22.04
		RB Size=25, RB Offset=0	21.14	21.15	22.07
	16QAM	RB Size=1, RB Offset=0	21.97	21.91	22.08
		RB Size=1, RB Offset=12	21.82	21.88	22.41
		RB Size=1, RB Offset=24	21.96	21.77	21.67
		RB Size=12, RB Offset=0	21.76	21.73	21.74
		RB Size=12, RB Offset=6	22.01	21.86	21.63
		RB Size=12, RB Offset=11	21.62	21.72	21.81
		RB Size=25, RB Offset=0	20.74	20.76	20.86
10M	QPSK	RB Size=1, RB Offset=0	22.22	22.45	22.11
		RB Size=1, RB Offset=24	21.85	22.35	22.14
		RB Size=1, RB Offset=49	22.50	22.76	22.15
		RB Size=25, RB Offset=0	22.35	22.31	22.25
		RB Size=25, RB Offset=12	22.57	22.29	22.39
		RB Size=25, RB Offset=24	22.50	21.30	22.46
		RB Size=50, RB Offset=0	21.92	21.38	22.35
	16QAM	RB Size=1, RB Offset=0	22.51	21.76	21.64
		RB Size=1, RB Offset=24	22.50	21.71	21.35
		RB Size=1, RB Offset=49	21.58	21.87	21.34
		RB Size=25, RB Offset=0	21.53	21.53	21.46
		RB Size=25, RB Offset=12	21.55	21.60	21.50
		RB Size=25, RB Offset=24	22.07	21.38	21.61
		RB Size=50, RB Offset=0	20.89	20.78	20.71

15M	QPSK	RB Size=1, RB Offset=0	22.54	22.03	22.47
		RB Size=1, RB Offset=37	22.61	22.16	22.76
		RB Size=1, RB Offset=74	22.58	21.96	22.09
		RB Size=36, RB Offset=0	22.63	22.38	22.21
		RB Size=36, RB Offset=18	22.41	22.06	22.11
		RB Size=36, RB Offset=37	22.46	22.16	22.79
		RB Size=75, RB Offset=0	22.42	22.03	22.65
	16QAM	RB Size=1, RB Offset=0	22.25	22.04	22.15
		RB Size=1, RB Offset=37	22.31	22.07	22.20
		RB Size=1, RB Offset=74	22.65	21.97	22.64
		RB Size=36, RB Offset=0	22.27	22.24	22.72
		RB Size=36, RB Offset=18	22.06	22.11	22.36
		RB Size=36, RB Offset=37	22.15	22.16	22.19
		RB Size=75, RB Offset=0	22.08	22.14	22.71
20M	QPSK	RB Size=1, RB Offset=0	22.78	22.69	22.82
		RB Size=1, RB Offset=49	22.61	22.17	22.43
		RB Size=1, RB Offset=99	22.31	22.11	22.79
		RB Size=50, RB Offset=0	22.53	22.17	22.66
		RB Size=50, RB Offset=24	22.58	22.40	22.19
		RB Size=50, RB Offset=49	22.54	22.39	22.53
		RB Size=100, RB Offset=0	22.45	22.47	22.02
	16QAM	RB Size=1, RB Offset=0	22.65	22.31	22.53
		RB Size=1, RB Offset=49	22.39	22.23	22.39
		RB Size=1, RB Offset=99	22.39	22.35	22.52
		RB Size=50, RB Offset=0	22.45	22.72	22.76
		RB Size=50, RB Offset=24	22.56	22.80	22.40
		RB Size=50, RB Offset=49	22.44	22.74	22.61
		RB Size=100, RB Offset=0	22.54	22.70	22.34

LTE Band 17:

BW	Modulation	Resource Block Size & Resource Block Offset	Ave Tx Power (dBm)		
			Low Channel	Mid Channel	High Channel
5M	QPSK	RB Size=1, RB Offset=0	22.66	22.53	22.69
		RB Size=1, RB Offset=12	22.63	22.51	22.62
		RB Size=1, RB Offset=24	22.64	22.59	22.71
		RB Size=12, RB Offset=0	22.60	22.56	22.65
		RB Size=12, RB Offset=6	22.58	22.50	22.58
		RB Size=12, RB Offset=11	22.59	21.59	21.57
		RB Size=25, RB Offset=0	21.60	21.53	21.60
	16QAM	RB Size=1, RB Offset=0	22.04	21.94	21.96
		RB Size=1, RB Offset=12	21.89	21.63	21.64
		RB Size=1, RB Offset=24	22.30	21.65	21.95
		RB Size=12, RB Offset=0	22.24	22.27	21.34
		RB Size=12, RB Offset=6	22.21	22.26	21.39
		RB Size=12, RB Offset=11	22.20	22.30	21.37
		RB Size=25, RB Offset=0	20.55	20.58	20.56

10M	QPSK	RB Size=1, RB Offset=0	22.84	22.80	22.79
		RB Size=1, RB Offset=24	22.53	22.46	22.63
		RB Size=1, RB Offset=49	22.64	22.60	22.62
		RB Size=25, RB Offset=0	22.52	22.54	22.60
		RB Size=25, RB Offset=12	22.51	22.57	22.54
		RB Size=25, RB Offset=24	22.54	22.59	22.58
		RB Size=50, RB Offset=0	21.63	21.60	21.68
	16QAM	RB Size=1, RB Offset=0	22.24	21.77	21.64
		RB Size=1, RB Offset=24	21.37	21.69	21.65
		RB Size=1, RB Offset=49	21.67	21.85	22.17
		RB Size=25, RB Offset=0	21.60	21.80	22.15
		RB Size=25, RB Offset=12	21.55	21.82	22.30
		RB Size=25, RB Offset=24	21.58	21.57	21.50
		RB Size=50, RB Offset=0	20.71	20.79	20.85

Note:

- SAR for LTE band exposure configurations is measured according to the procedures of KDB 941225 D05 SAR for LTE Devices v02.
- The CMW500 Wideband Radio Communication tester is used for LTE output power measurements and SAR testing. Closed loop power control is used to keep the radio transmitters the max output power during the test.
- KDB941225D05v02- SAR for higher order modulation is required only when the highest maximum output power for the configuration in the higher order modulation is > ½ dB higher than the same configuration in QPSK or when the reported SAR for the QPSK configuration is > 1.45 W/kg

Bluetooth

Mode	Channel frequency (MHz)	Conducted Output Power	
		(dBm)	(mw)
BDR(GFSK)	(Low)2402	1.99	1.581
	(Middle)2441	0.56	1.138
	(High)2480	0.13	1.030
EDR(4-DQPSK)	(Low)2402	1.12	1.294
	(Middle)2441	-0.07	0.984
	(High)2480	-0.54	0.883
EDR-8DPSK	(Low)2402	1.48	1.406
	(Middle)2441	0.14	1.033
	(High)2480	-0.35	0.923
BT4.0	(Low)2402	-5.10	0.309
	(Middle)2440	-5.82	0.262
	(High)2480	-6.62	0.218

Wi-Fi

Band	Frequency (MHz)	Conducted Output Power	
		(dBm)	(mw)
802.11b	2412	9.83	9.616
	2437	9.91	9.795
	2472	9.93	9.840
802.11g	2412	9.61	9.141
	2437	9.79	9.528
	2472	9.90	9.772
802.11n HT20	2412	9.01	7.962
	2437	9.44	8.790
	2472	9.79	9.528
802.11n HT40	2422	9.24	8.395
	2437	9.48	8.872
	2462	9.44	8.790

Note:

1. The output power was tested under data rate 1Mbps for 802.11b, 6Mbps for 802.11g, 6.5Mbps for 802.11n HT20, 13.5Mbps for 802.11n HT40.

SAR MEASUREMENT RESULTS

This page summarizes the results of the performed dosimetric evaluation.

SAR Test Data

Environmental Conditions

Temperature:	21-24
Relative Humidity:	50-53 %
ATM Pressure:	1001-1002 mbar

Testing was performed by Wilson Chen on 2015-04-10

GSM 850:

EUT Position	Frequency (MHz)	Test Mode	Power Drift (%)	Max. Meas. Power (dBm)	Max. Rated Power (dBm)	1g SAR (W/Kg)			
						Scaled Factor	Meas. SAR	Scaled SAR	Plot
Left Head Cheek	824.2	GSM	/	/	/	/	/	/	/
	836.6	GSM	0.927	32.18	32.30	1.028	0.275	0.283	/
	848.8	GSM	/	/	/	/	/	/	/
Left Head Tilt	824.2	GSM	/	/	/	/	/	/	/
	836.6	GSM	0.943	32.18	32.30	1.028	0.141	0.145	/
	848.8	GSM	/	/	/	/	/	/	/
Right Head Cheek	824.2	GSM	-1.387	32.14	32.30	1.038	0.284	0.295	1#
	836.6	GSM	-1.159	32.18	32.30	1.028	0.285	0.293	
	848.8	GSM	3.542	32.17	32.30	1.030	0.263	0.271	/
Right Head Tilt	824.2	GSM	/	/	/	/	/	/	/
	836.6	GSM	1.506	32.18	32.30	1.028	0.139	0.143	/
	848.8	GSM	/	/	/	/	/	/	/
Body-Back-Headset (10mm)	824.2	GSM	/	/	/	/	/	/	/
	836.6	GSM	-2.156	32.18	32.30	1.028	0.396	0.407	/
	848.8	GSM	/	/	/	/	/	/	/

Note:

1. When the 1-g SAR is $\leq 0.8\text{W/Kg}$, testing for other channels are optional.
2. The EUT transmit and receive through the same GSM antenna while testing SAR.
3. When SAR or MPE is not measured at the maximum power level allowed for production units, the results must be scaled to the maximum tune-up tolerance limit according to the power applied to the individual channels tested to determine compliance.

PCS Band:

EUT Position	Frequency (MHz)	Test Mode	Power Drift (%)	Max. Meas. Power (dBm)	Max. Rated Power (dBm)	1g SAR (W/Kg)			
						Scaled Factor	Meas. SAR	Scaled SAR	Plot
Left Head Cheek	1850.2	GSM	-2.514	29.23	29.50	1.064	0.358	0.381	2#
	1880.0	GSM	3.178	29.14	29.50	1.086	0.342	0.371	/
	1909.8	GSM	-1.651	29.47	29.50	1.007	0.339	0.341	/
Left Head Tilt	1850.2	GSM	/	/	/	/	/	/	/
	1880.0	GSM	4.317	29.14	29.50	1.086	0.146	0.159	/
	1909.8	GSM	/	/	/	/	/	/	/
Right Head Cheek	1850.2	GSM	/	/	/	/	/	/	/
	1880.0	GSM	-1.834	29.14	29.50	1.086	0.328	0.356	/
	1909.8	GSM	/	/	/	/	/	/	/
Right Head Tilt	1850.2	GSM	/	/	/	/	/	/	/
	1880.0	GSM	0.584	29.14	29.50	1.086	0.150	0.163	/
	1909.8	GSM	/	/	/	/	/	/	/
Body-Back-Headset (10mm)	1850.2	GSM	/	/	/	/	/	/	/
	1880.0	GSM	-2.147	29.14	29.50	1.086	0.594	0.645	/
	1909.8	GSM	/	/	/	/	/	/	/

Note:

1. When the 1-g SAR is $\leq 0.8\text{W/Kg}$, testing for other channels are optional.
2. The EUT transmit and receive through the same GSM antenna while testing SAR.
3. When SAR or MPE is not measured at the maximum power level allowed for production units, the results must be scaled to the maximum tune-up tolerance limit according to the power applied to the individual channels tested to determine compliance.

WCDMA 850

EUT Position	Frequency (MHz)	Test Mode	Power Drift (%)	Max. Meas. Power (dBm)	Max. Rated Power (dBm)	1g SAR (W/Kg)			
						Scaled Factor	Meas. SAR	Scaled SAR	Plot
Left Head Cheek	826.4	WCDMA 850	-3.588	21.92	22.00	1.019	0.109	0.111	3#
	836.6	WCDMA 850	/	/	/	/	/	/	/
	846.6	WCDMA 850	/	/	/	/	/	/	/
Left Head Tilt	826.4	WCDMA 850	-0.999	21.92	22.00	1.019	0.071	0.072	/
	836.6	WCDMA 850	/	/	/	/	/	/	/
	846.6	WCDMA 850	/	/	/	/	/	/	/
Right Head Cheek	826.4	WCDMA 850	1.812	21.92	22.00	1.019	0.104	0.106	/
	836.6	WCDMA 850	/	/	/	/	/	/	/
	846.6	WCDMA 850	/	/	/	/	/	/	/
Right Head Tilt	826.4	WCDMA 850	2.011	21.92	22.00	1.019	0.065	0.066	/
	836.6	WCDMA 850	/	/	/	/	/	/	/
	846.6	WCDMA 850	/	/	/	/	/	/	/

WCDMA1700

EUT Position	Frequency (MHz)	Test Mode	Power Drift (%)	Max. Meas. Power (dBm)	Max. Rated Power (dBm)	1g SAR (W/Kg)			
						Scaled Factor	Meas. SAR	Scaled SAR	Plot
Left Head Cheek	1712.4	WCDMA1700	/	/	/	/	/	/	/
	1732.4	WCDMA1700	/	/	/	/	/	/	/
	1752.6	WCDMA1700	0.264	22.23	22.30	1.016	0.142	0.144	4#
Left Head Tilt	1712.4	WCDMA1700	/	/	/	/	/	/	/
	1732.4	WCDMA1700	/	/	/	/	/	/	/
	1752.6	WCDMA1700	1.003	22.23	22.30	1.016	0.062	0.063	/
Right Head Cheek	1712.4	WCDMA1700	/	/	/	/	/	/	/
	1732.4	WCDMA1700	/	/	/	/	/	/	/
	1752.6	WCDMA1700	-2.218	22.23	22.30	1.016	0.135	0.137	/
Right Head Tilt	1712.4	WCDMA1700	/	/	/	/	/	/	/
	1732.4	WCDMA1700	/	/	/	/	/	/	/
	1752.6	WCDMA1700	1.716	22.23	22.30	1.016	0.058	0.059	/

WCDMA1900

EUT Position	Frequency (MHz)	Test Mode	Power Drift (%)	Max. Meas. Power (dBm)	Max. Rated Power (dBm)	1g SAR (W/Kg)			
						Scaled Factor	Meas. SAR	Scaled SAR	Plot
Left Head Cheek	1852.4	WCDMA1900	/	/	/	/	/	/	/
	1880.0	WCDMA1900	3.217	21.97	22.00	1.007	0.314	0.316	5#
	1907.6	WCDMA1900	/	/	/	/	/	/	/
Left Head Tilt	1852.4	WCDMA1900	/	/	/	/	/	/	/
	1880.0	WCDMA1900	-2.054	21.97	22.00	1.007	0.128	0.129	/
	1907.6	WCDMA1900	/	/	/	/	/	/	/
Right Head Cheek	1852.4	WCDMA1900	/	/	/	/	/	/	/
	1880.0	WCDMA1900	1.263	21.97	22.00	1.007	0.298	0.300	/
	1907.6	WCDMA1900	/	/	/	/	/	/	/
Right Head Tilt	1852.4	WCDMA1900	/	/	/	/	/	/	/
	1880.0	WCDMA1900	0.829	21.97	22.00	1.007	0.135	0.136	/
	1907.6	WCDMA1900	/	/	/	/	/	/	/

Note:

1. When the 1-g SAR is $\leq 0.8W/Kg$, testing for other channels are optional.
2. The default test configuration is to measure SAR with an established radio link between the EUT and a communication test set using a 12.2 kbps RMC (reference measurement Channel) Configured in Test Loop Model.
3. When SAR or MPE is not measured at the maximum power level allowed for production units, the results must be scaled to the maximum tune-up tolerance limit according to the power applied to the individual channels tested to determine compliance.

LTE Band 2:

EUT Position	Frequency (MHz)	Test Mode	Power Drift (%)	Max. Meas. Power (dBm)	Max. Rated Power (dBm)	1g SAR (W/Kg)			
						Scaled Factor	Meas. SAR	Scaled SAR	Plot
Left Head Cheek	1860	1RB	1.344	22.75	23.00	1.059	0.239	0.253	/
	1880	1RB	/	/	/	/	/	/	/
	1900	1RB	/	/	/	/	/	/	/
Left Head Tilt	1860	1RB	-0.173	22.75	23.00	1.059	0.102	0.108	/
	1880	1RB	/	/	/	/	/	/	/
	1900	1RB	/	/	/	/	/	/	/
Right Head Cheek	1860	1RB	-2.321	22.75	23.00	1.059	0.258	0.273	6#
	1880	1RB	/	/	/	/	/	/	/
	1900	1RB	/	/	/	/	/	/	/
	1860	50% RB	-2.533	22.34	23.00	1.164	0.214	0.249	/
Right Head Tilt	1860	1RB	1.086	22.75	23.00	1.059	0.113	0.120	/
	1880	1RB	/	/	/	/	/	/	/
	1900	1RB	/	/	/	/	/	/	/

LTE Band 4:

EUT Position	Frequency (MHz)	Test Mode	Power Drift (%)	Max. Meas. Power (dBm)	Max. Rated Power (dBm)	1g SAR (W/Kg)			
						Scaled Factor	Meas. SAR	Scaled SAR	Plot
Left Head Cheek	1720	1RB	/	/	/	/	/	/	/
	1732.5	1RB	/	/	/	/	/	/	/
	1745	1RB	2.218	22.05	22.10	1.012	0.157	0.159	
Left Head Tilt	1720	1RB	/	/	/	/	/	/	/
	1732.5	1RB	/	/	/	/	/	/	/
	1745	1RB	1.625	22.05	22.10	1.012	0.068	0.069	/
Right Head Cheek	1720	1RB	/	/	/	/	/	/	/
	1732.5	1RB	/	/	/	/	/	/	/
	1745	1RB	-1.117	22.05	22.10	1.012	0.168	0.170	7#
	1745	50% RB	0.528	21.84	22.10	1.062	0.142	0.151	/
Right Head Tilt	1720	1RB	/	/	/	/	/	/	/
	1732.5	1RB	/	/	/	/	/	/	/
	1745	1RB	-3.518	22.05	22.10	1.012	0.074	0.075	/

LTE Band 5:

EUT Position	Frequency (MHz)	Test Mode	Power Drift (%)	Max. Meas. Power (dBm)	Max. Rated Power (dBm)	1g SAR (W/Kg)			
						Scaled Factor	Meas. SAR	Scaled SAR	Plot
Left Head Cheek	829	1RB	-1.638	23.05	23.10	1.012	0.137	0.139	8#
	836.5	1RB	/	/	/	/	/	/	/
	844	1RB	/	/	/	/	/	/	/
	829	50% RB	-2.325	22.95	23.10	1.035	0.128	0.132	
Left Head Tilt	829	1RB	0.528	23.05	23.10	1.012	0.081	0.082	/
	836.5	1RB	/	/	/	/	/	/	/
	844	1RB	/	/	/	/	/	/	/
Right Head Cheek	829	1RB	-1.365	23.05	23.10	1.012	0.129	0.131	/
	836.5	1RB	/	/	/	/	/	/	/
	844	1RB	/	/	/	/	/	/	/
Right Head Tilt	829	1RB	0.928	23.05	23.10	1.012	0.075	0.076	/
	836.5	1RB	/	/	/	/	/	/	/
	844	1RB	/	/	/	/	/	/	/

LTE Band 7:

EUT Position	Frequency (MHz)	Test Mode	Power Drift (%)	Max. Meas. Power (dBm)	Max. Rated Power (dBm)	1g SAR (W/Kg)			
						Scaled Factor	Meas. SAR	Scaled SAR	Plot
Left Head Cheek	2510	1RB	/	/	/	/	/	/	/
	2535	1RB	/	/	/	/	/	/	/
	2560	1RB	2.487	22.82	23.00	1.042	0.176	0.183	9#
	2560	50% RB	1.025	22.66	23.00	1.066	0.154	0.164	
Left Head Tilt	2510	1RB	/	/	/	/	/	/	/
	2535	1RB	/	/	/	/	/	/	/
	2560	1RB	-3.025	22.82	23.00	1.042	0.069	0.072	/
Right Head Cheek	2510	1RB	/	/	/	/	/	/	/
	2535	1RB	/	/	/	/	/	/	/
	2560	1RB	1.127	22.82	23.00	1.042	0.163	0.170	/
Right Head Tilt	2510	1RB	/	/	/	/	/	/	/
	2535	1RB	/	/	/	/	/	/	/
	2560	1RB	0.629	22.82	23.00	1.042	0.071	0.074	/

LTE Band 17:

EUT Position	Frequency (MHz)	Test Mode	Power Drift (%)	Max. Meas. Power (dBm)	Max. Rated Power (dBm)	1g SAR (W/Kg)			
						Scaled Factor	Meas. SAR	Scaled SAR	Plot
Left Head Cheek	709	1RB	-0.639	22.84	23.00	1.038	0.198	0.206	10#
	710	1RB	/	/	/	/	/	/	/
	711	1RB	/	/	/	/	/	/	/
	709	50% RB	1.638	22.52	23.00	1.117	0.175	0.195	/
Left Head Tilt	709	1RB	-2.026	22.84	23.00	1.038	0.103	0.107	/
	710	1RB	/	/	/	/	/	/	/
	711	1RB	/	/	/	/	/	/	/
Right Head Cheek	709	1RB	1.528	22.84	23.00	1.038	0.180	0.187	/
	710	1RB	/	/	/	/	/	/	/
	711	1RB	/	/	/	/	/	/	/
Right Head Tilt	709	1RB	-3.655	22.84	23.00	1.038	0.096	0.100	/
	710	1RB	/	/	/	/	/	/	/
	711	1RB	/	/	/	/	/	/	/

Note:

1. When the 1-g SAR is $\leq 0.8\text{W/Kg}$, testing for other channels are optional.
2. SAR for LTE band exposure configurations is measured according to the procedures of KDB 941225 D05 SAR for LTE Devices v02.

3. KDB941225D05- SAR for higher order modulation is required only when the highest maximum output power for the configuration in the higher order modulation is > ½ dB higher than the same configuration in QPSK or when the reported SAR for the QPSK configuration is > 1.45 W/kg
4. KDB941225D05- For QPSK with 100% RB allocation, when the reported SAR measured for the Highest output power channel is <1.45 W/kg, tests for the remaining required test channels are optional.
5. KDB941225D05- For QPSK with 100% RB allocation, SAR is not required when the highest maximum output power for 100 % RB allocation is less than the highest maximum output power in 50% and 1 RB allocations and the highest reported SAR for 1 RB and 50% RB allocation are ≤ 0.8 W/kg.
6. KDB941225D05- Start with the largest channel bandwidth and measure SAR for QPSK with 1 RB allocation, using the RB offset and required test channel combination with the highest maximum output power among RB offset the upper edge, middle and lower edge of each required test channel.
7. Worst case SAR for 50% RB allocation is selected to be tested.

Mobile Hot-Spot Test Result

The DUT is capable of functioning as a Wi-Fi to Cellular Mobile hotspot. Additional SAR testing was performed according to KDB 941225 D06. Testing was performed with a separation of 1cm between the DUT and the flat phantom. The DUT was positioned for SAR tests with the front and back surfaces facing the phantom, and also with the edges facing the phantom in which the transmitting antenna is <2.5 cm from the edge. Each transmit band was utilized for SAR testing. The tested mode has been selected within each band that exhibits the highest time average output power.

Hot spot-GPRS (Frequency Band: 835)

EUT Position	Frequency (MHz)	Test Mode	Power Drift (%)	Max. Meas. Power (dBm)	Max. Rated Power (dBm)	1g SAR (W/Kg)			
						Scaled Factor	Meas. SAR	Scaled SAR	Plot
Body-Back (10mm)	824.2	GPRS	/	/	/	/	/	/	/
	836.6	GPRS	/	/	/	/	/	/	/
	848.8	GPRS	-1.879	28.57	28.60	1.007	0.559	0.563	11#
Body-Left (10mm)	824.2	GPRS	/	/	/	/	/	/	/
	836.6	GPRS	/	/	/	/	/	/	/
	848.8	GPRS	1.055	28.57	28.60	1.007	0.276	0.278	/
Body-Right (10mm)	824.2	GPRS	/	/	/	/	/	/	/
	836.6	GPRS	/	/	/	/	/	/	/
	848.8	GPRS	-3.126	28.57	28.60	1.007	0.309	0.311	/
Body-Bottom (10mm)	824.2	GPRS	/	/	/	/	/	/	/
	836.6	GPRS	/	/	/	/	/	/	/
	848.8	GPRS	0.873	28.57	28.60	1.007	0.186	0.187	/

Note:

1. When the 1-g SAR is ≤ 0.8W/Kg, testing for other channels are optional.
2. The EUT is a Capability Class B mobile phone which can be attached to both GPRS and GSM services.
3. The Multi-slot Classes of EUT is Class12 which has maximum 4 Downlink slots and 4 Uplink slots, the maximum active slots is 5, when perform the multiple slots scan, 1DL+4UL is the worst case.
4. The EUT transmit and receive through the same GSM antenna while testing SAR.
5. When SAR or MPE is not measured at the maximum power level allowed for production units, the results must be scaled to the maximum tune-up tolerance limit according to the power applied to the individual channels tested to determine compliance.

Hot spot-GPRS (Frequency Band: 1900)

EUT Position	Frequency (MHz)	Test Mode	Power Drift (%)	Max. Meas. Power (dBm)	Max. Rated Power (dBm)	1g SAR (W/Kg)			
						Scaled Factor	Meas. SAR	Scaled SAR	Plot
Body-Back (10mm)	1850.2	GPRS	0.169	26.88	27.00	1.028	0.779	0.801	/
	1880.0	GPRS	4.618	26.87	27.00	1.030	0.758	0.781	/
	1909.8	GPRS	1.901	27.32	27.50	1.042	0.872	0.909	12#
Body-Left (10mm)	1850.2	GPRS	/	/	/	/	/	/	/
	1880.0	GPRS	/	/	/	/	/	/	/
	1909.8	GPRS	3.426	27.32	27.50	1.042	0.268	0.279	/
Body-Right (10mm)	1850.2	GPRS	/	/	/	/	/	/	/
	1880.0	GPRS	/	/	/	/	/	/	/
	1909.8	GPRS	1.497	27.32	27.50	1.042	0.352	0.367	/
Body-Bottom (10mm)	1850.2	GPRS	/	/	/	/	/	/	/
	1880.0	GPRS	/	/	/	/	/	/	/
	1909.8	GPRS	4.144	27.32	27.50	1.042	0.745	0.776	/

Note:

1. When the 1-g SAR is $\leq 0.8W/Kg$, testing for other channels are optional.
2. The EUT is a Capability Class B mobile phone which can be attached to both GPRS and GSM services.
3. The Multi-slot Classes of EUT is Class12 which has maximum 4 Downlink slots and 4 Uplink slots, the maximum active slots is 5, when perform the multiple slots scan, 2DL+3UL is the worst case.
4. The EUT transmit and receive through the same GSM antenna while testing SAR.
5. When SAR or MPE is not measured at the maximum power level allowed for production units, the results must be scaled to the maximum tune-up tolerance limit according to the power applied to the individual channels tested to determine compliance.

Hot Spot-WCDMA850

EUT Position	Frequency (MHz)	Test Mode	Power Drift (%)	Max. Meas. Power (dBm)	Max. Rated Power (dBm)	1g SAR (W/Kg)			
						Scaled Factor	Meas. SAR	Scaled SAR	Plot
Body-Back (10mm)	826.4	WCDMA850	-1.189	21.92	22.00	1.019	0.216	0.220	13#
	836.6	WCDMA850	/	/	/	/	/	/	/
	846.6	WCDMA850	/	/	/	/	/	/	/
Body-Left (10mm)	826.4	WCDMA850	2.028	21.92	22.00	1.019	0.115	0.117	/
	836.6	WCDMA850	/	/	/	/	/	/	/
	846.6	WCDMA850	/	/	/	/	/	/	/
Body-Right (10mm)	826.4	WCDMA850	1.362	21.92	22.00	1.019	0.124	0.126	/
	836.6	WCDMA850	/	/	/	/	/	/	/
	846.6	WCDMA850	/	/	/	/	/	/	/
Body-Bottom (10mm)	826.4	WCDMA850	1.235	21.92	22.00	1.019	0.063	0.064	/
	836.6	WCDMA850	/	/	/	/	/	/	/
	846.6	WCDMA850	/	/	/	/	/	/	/

Hot Spot-WCDMA1700

EUT Position	Frequency (MHz)	Test Mode	Power Drift (%)	Max. Meas. Power (dBm)	Max. Rated Power (dBm)	1g SAR (W/Kg)			
						Scaled Factor	Meas. SAR	Scaled SAR	Plot
Body-Back (10mm)	1712.4	WCDMA1700	/	/	/	/	/	/	/
	1732.4	WCDMA1700	/	/	/	/	/	/	/
	1752.6	WCDMA1700	-1.239	22.23	22.30	1.016	0.308	0.313	14#
Body-Left (10mm)	1712.4	WCDMA1700	/	/	/	/	/	/	/
	1732.4	WCDMA1700	/	/	/	/	/	/	/
	1752.6	WCDMA1700	0.115	22.23	22.30	1.016	0.150	0.152	/
Body-Right (10mm)	1712.4	WCDMA1700	/	/	/	/	/	/	/
	1732.4	WCDMA1700	/	/	/	/	/	/	/
	1752.6	WCDMA1700	2.364	22.23	22.30	1.016	0.137	0.139	/
Body-Bottom (10mm)	1712.4	WCDMA1700	/	/	/	/	/	/	/
	1732.4	WCDMA1700	/	/	/	/	/	/	/
	1752.6	WCDMA1700	1.177	22.23	22.30	1.016	0.289	0.294	/

Hot Spot-WCDMA1900

EUT Position	Frequency (MHz)	Test Mode	Power Drift (%)	Max. Meas. Power (dBm)	Max. Rated Power (dBm)	1g SAR (W/Kg)			
						Scaled Factor	Meas. SAR	Scaled SAR	Plot
Body-Back (10mm)	1852.4	WCDMA1900	/	/	/	/	/	/	/
	1880.0	WCDMA1900	1.794	22.23	22.30	1.016	0.712	0.723	15#
	1907.6	WCDMA1900	/	/	/	/	/	/	/
Body-Left (10mm)	1852.4	WCDMA1900	/	/	/	/	/	/	/
	1880.0	WCDMA1900	-2.325	22.23	22.30	1.016	0.264	0.268	/
	1907.6	WCDMA1900	/	/	/	/	/	/	/
Body-Right (10mm)	1852.4	WCDMA1900	/	/	/	/	/	/	/
	1880.0	WCDMA1900	0.639	22.23	22.30	1.016	0.283	0.288	/
	1907.6	WCDMA1900	/	/	/	/	/	/	/
Body-Bottom (10mm)	1852.4	WCDMA1900	/	/	/	/	/	/	/
	1880.0	WCDMA1900	-1.221	22.23	22.30	1.016	0.675	0.686	/
	1907.6	WCDMA1900	/	/	/	/	/	/	/

Note:

1. When the 1-g SAR is $\leq 0.8\text{W/Kg}$, testing for other channels are optional.
2. The default test configuration is to measure SAR with an established radio link between the EUT and a communication test set using a 12.2 kbps RMC (reference measurement Channel) Configured in Test Loop Model.
5. When SAR or MPE is not measured at the maximum power level allowed for production units, the results must be scaled to the maximum tune-up tolerance limit according to the power applied to the individual channels tested to determine compliance.

LTE Band 2:

EUT Position	Frequency (MHz)	Test Mode	Power Drift (%)	Max. Meas. Power (dBm)	Max. Rated Power (dBm)	1g SAR (W/Kg)			
						Scaled Factor	Meas. SAR	Scaled SAR	Plot
Body-Back (10mm)	1860	1RB	-0.628	22.75	23.00	1.059	0.628	0.665	16#
	1880	1RB	/	/	/	/	/	/	/
	1900	1RB	/	/	/	/	/	/	/
	1860	50% RB	4.322	22.34	23.00	1.164	0.552	0.643	
Body-Left (10mm)	1860	1RB	1.810	22.75	23.00	1.059	0.241	0.255	
	1880	1RB	/	/	/	/	/	/	/
	1900	1RB	/	/	/	/	/	/	/
Body- Right (10mm)	1860	1RB	1.227	22.75	23.00	1.059	0.204	0.216	
	1880	1RB	/	/	/	/	/	/	/
	1900	1RB	/	/	/	/	/	/	/
Body- Bottom (10mm)	1860	1RB	-1.232	22.75	23.00	1.059	0.577	0.611	
	1880	1RB							
	1900	1RB	/	/	/	/	/	/	

LTE Band 4:

EUT Position	Frequency (MHz)	Test Mode	Power Drift (%)	Max. Meas. Power (dBm)	Max. Rated Power (dBm)	1g SAR (W/Kg)			
						Scaled Factor	Meas. SAR	Scaled SAR	Plot
Body-Back (10mm)	1720	1RB	/	/	/	/	/	/	/
	1732.5	1RB	/	/	/	/	/	/	/
	1745	1RB	1.697	22.05	22.10	1.012	0.374	0.378	17#
	1745	50% RB	-2.215	21.84	22.10	1.062	0.342	0.363	/
Body-Left (10mm)	1720	1RB	/	/	/	/	/	/	/
	1732.5	1RB	/	/	/	/	/	/	/
	1745	1RB	-0.354	22.05	22.10	1.012	0.155	0.157	/
Body- Right (10mm)	1720	1RB	/	/	/	/	/	/	/
	1732.5	1RB	/	/	/	/	/	/	/
	1745	1RB	-2.694	22.05	22.10	1.012	0.173	0.175	/
Body- Bottom (10mm)	1720	1RB	/	/	/	/	/	/	/
	1732.5	1RB	/	/	/	/	/	/	/
	1745	1RB	2.547	V22.61	22.70	1.021	0.332	0.339	/

LTE Band 5:

EUT Position	Frequency (MHz)	Test Mode	Power Drift (%)	Max. Meas. Power (dBm)	Max. Rated Power (dBm)	1g SAR (W/Kg)			
						Scaled Factor	Meas. SAR	Scaled SAR	Plot
Body-Back (10mm)	829	1RB	-2.315	23.05	23.10	1.012	0.257	0.260	18#
	836.5	1RB	/	/	/	/	/	/	/
	844	1RB	/	/	/	/	/	/	/
	829	50% RB	-1.256	22.95	23.10	1.035	0.229	0.237	/
Body-Left (10mm)	829	1RB	0.618	23.05	23.10	1.012	0.095	0.096	/
	836.5	1RB	/	/	/	/	/	/	/
	844	1RB	/	/	/	/	/	/	/
Body- Right (10mm)	829	1RB	-2.525	23.05	23.10	1.012	0.100	0.101	/
	836.5	1RB	/	/	/	/	/	/	/
	844	1RB	/	/	/	/	/	/	/
Body- Bottom (10mm)	829	1RB	-2.667	23.05	23.10	1.012	0.073	0.074	/
	836.5	1RB	/	/	/	/	/	/	/
	844	1RB	/	/	/	/	/	/	/

LTE Band 7:

EUT Position	Frequency (MHz)	Test Mode	Power Drift (%)	Max. Meas. Power (dBm)	Max. Rated Power (dBm)	1g SAR (W/Kg)			
						Scaled Factor	Meas. SAR	Scaled SAR	Plot
Body-Back (10mm)	2510	1RB	/	/	/	/	/	/	/
	2535	1RB	/	/	/	/	/	/	/
	2560	1RB	0.579	22.82	23.00	1.042	0.377	0.393	19#
	2560	50% RB	-2.284	22.66	23.00	1.066	0.346	0.369	
Body-Left (10mm)	2510	1RB	/	/	/	/	/	/	/
	2535	1RB	/	/	/	/	/	/	/
	2560	1RB	2.649	22.82	23.00	1.042	0.133	0.139	
Body- Right (10mm)	2510	1RB	/	/	/	/	/	/	/
	2535	1RB	/	/	/	/	/	/	/
	2560	1RB	1.087	22.82	23.00	1.042	0.140	0.146	
Body- Bottom (10mm)	2510	1RB	/	/	/	/	/	/	/
	2535	1RB	/	/	/	/	/	/	/
	2560	1RB	3.064	22.82	23.00	1.042	0.354	0.369	

LTE Band 17:

EUT Position	Frequency (MHz)	Test Mode	Power Drift (%)	Max. Meas. Power (dBm)	Max. Rated Power (dBm)	1g SAR (W/Kg)			
						Scaled Factor	Meas. SAR	Scaled SAR	Plot
Body-Back (10mm)	709	1RB	-2.264	22.84	23.00	1.038	0.329	0.342	20#
	710	1RB	/	/	/	/	/	/	/
	711	1RB	/	/	/	/	/	/	/
	709	50% RB	1.025	22.52	23.00	1.117	0.294	0.328	/
Body-Left (10mm)	709	1RB	-3.314	22.84	23.00	1.038	0.136	0.141	/
	710	1RB	/	/	/	/	/	/	/
	711	1RB	/	/	/	/	/	/	/
Body- Right (10mm)	709	1RB	-1.129	22.84	23.00	1.038	0.124	0.129	/
	710	1RB	/	/	/	/	/	/	/
	711	1RB	/	/	/	/	/	/	/
Body- Bottom (10mm)	709	1RB	0.637	22.84	23.00	1.038	0.068	0.071	/
	710	1RB	/	/	/	/	/	/	/
	711	1RB	/	/	/	/	/	/	/

Note:

1. When the 1-g SAR is $\leq 0.8\text{W/Kg}$, testing for other channels are optional.
2. SAR for LTE band exposure configurations is measured according to the procedures of KDB 941225 D05 SAR for LTE Devices v02.
3. KDB941225D05- SAR for higher order modulation is required only when the highest maximum output power for the configuration in the higher order modulation is $> \frac{1}{2}$ dB higher than the same configuration in QPSK or when the reported SAR for the QPSK configuration is $> 1.45\text{ W/kg}$
4. KDB941225D05- For QPSK with 100% RB allocation, when the reported SAR measured for the Highest output power channel is $< 1.45\text{ W/kg}$, tests for the remaining required test channels are optional.
5. KDB941225D05- For QPSK with 100% RB allocation, SAR is not required when the highest maximum output power for 100 % RB allocation is less than the highest maximum output power in 50% and 1 RB allocations and the highest *reported* SAR for 1 RB and 50% RB allocation are 0.8 W/kg .
6. KDB941225D05- Start with the largest channel bandwidth and measure SAR for QPSK with 1 RB allocation, using the RB offset and required test channel combination with the highest maximum output power among RB offset the upper edge, middle and lower edge of each required test channel.
7. Worst case SAR for 50% RB allocation is selected to be tested.

SAR SIMULTANEOUS TRANSMISSION DESCRIPTION

BT& Wi-Fi and LTE&GSM&3G Antennas Location:

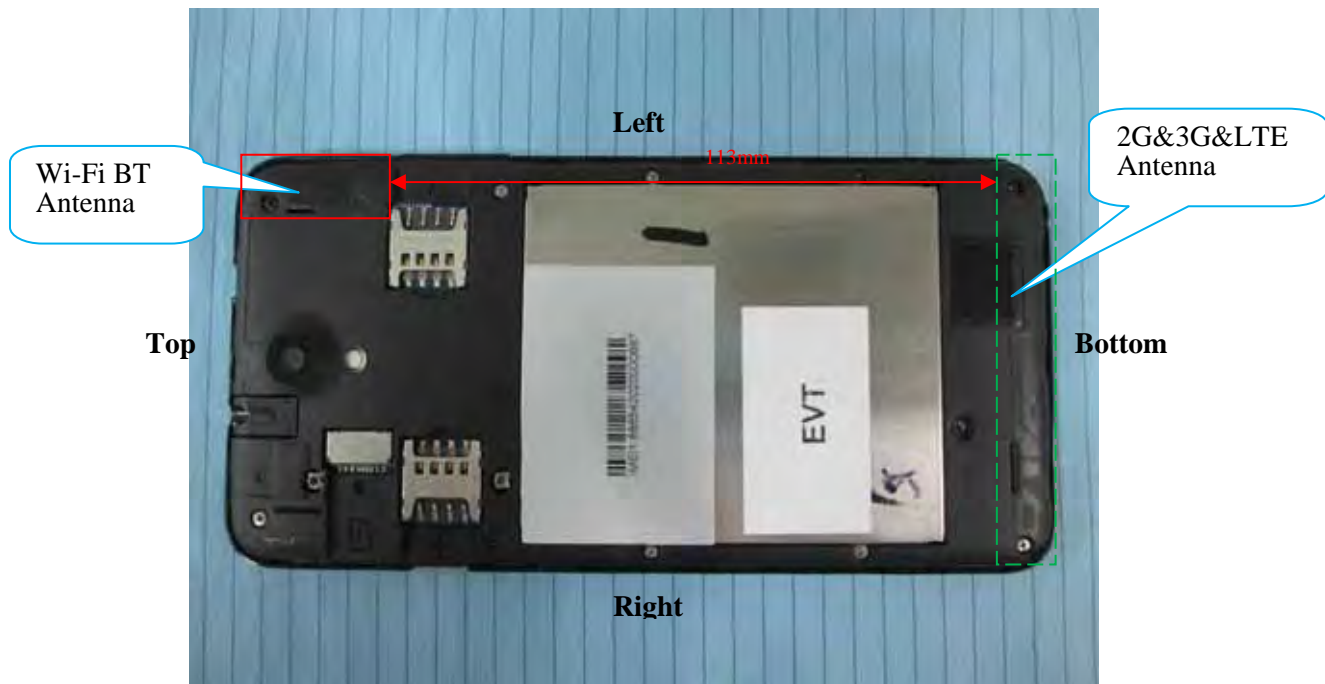

Simultaneous Transmission:

Description of Simultaneous Transmit Capabilities			Antennas Distance (mm)
Transmitter Combination	Simultaneous?	Hotspot?	
GSM + WCDMA	×	×	0
GSM + LTE	×	×	0
GSM + Bluetooth	√	×	113
GSM + Wi-Fi	√	√	113
WCDMA + LTE	×	×	0
WCDMA + Bluetooth	√	×	113
WCDMA + Wi-Fi	√	√	113
LTE+ Bluetooth	√	×	113
LTE++ Wi-Fi	√	√	113

Standalone SAR test exclusion considerations

Head Position:

Mode	Frequency (MHz)	P _{avg} (dBm)	P _{avg} (mW)	Distance (mm)	Calculated value	Threshold (1-g)	SAR Test Exclusion
GSM850	850	23.20	208.93	0	38.52	3.0	No
PCS1900	1900	20.50	112.20	0	30.93	3.0	No
WCDMA850	850	22.00	158.49	0	29.22	3.0	No
WCDMA1700	1700	22.30	169.82	0	44.28	3.0	No
WCDMA1900	1900	22.00	158.49	0	43.69	3.0	No
LTE Band 2	1900	23.00	199.53	0	55.01	3.0	No

LTE Band 4	1745	22.10	162.18	0	42.85	3.0	No
LTE Band 5	836	23.10	204.17	0	37.34	3.0	No
LTE Band 7	2560	23.00	199.53	0	63.85	3.0	No
LTE Band 17	711	23.00	199.53	0	33.65	3.0	No
Wi-Fi	2450	10.00	10.00	0	3.00	3.0	Yes
Bluetooth	2450	2.00	1.58	0	0.50	3.0	Yes

Body Position:

Mode	Frequency (MHz)	P _{avg} (dBm)	P _{avg} (Mw)	Distance (mm)	Calculated value	Threshold (1-g)	SAR Test Exclusion
GPRS850	850	25.60	363.08	10.00	33.47	3.0	No
GPRS1900	1900	23.30	213.80	10.00	29.47	3.0	No
WCDMA850	850	22.00	158.49	10.00	14.61	3.0	No
WCDMA1700	1700	22.30	169.82	10.00	22.14	3.0	No
WCDMA1900	1900	22.00	158.49	10.00	21.85	3.0	No
LTE Band 2	1900	23.00	199.53	10.00	27.50	3.0	No
LTE Band 4	1745	22.10	162.18	10.00	21.42	3.0	No
LTE Band 5	836	23.10	204.17	10.00	18.67	3.0	No
LTE Band 7	2560	23.00	199.53	10.00	31.92	3.0	No
LTE Band 17	711	23.00	199.53	10.00	16.82	3.0	No
Wi-Fi	2450	10.00	10.00	10.00	1.50	3.0	Yes
Bluetooth	2450	2.00	1.58	10.00	0.25	3.0	Yes

The 1-g and 10-g SAR test exclusion thresholds for 100 MHz to 6 GHz at *test separation distances* ≤ 50 mm are determined by:

$[(\text{max. power of channel, including tune-up tolerance, mW})/(\text{min. test separation distance, mm})] \cdot$

$[\sqrt{f(\text{GHz})}] \leq 3.0$ for 1-g SAR and ≤ 7.5 for 10-g extremity SAR, where

1. $f(\text{GHz})$ is the RF channel transmit frequency in GHz.
2. Power and distance are rounded to the nearest mW and mm before calculation.
3. The result is rounded to one decimal place for comparison.
4. When the minimum test separation distance is < 5 mm, a distance of 5 mm is applied to determine SAR test Exclusion.

Standalone SAR estimation:

Mode	Frequency (GHz)	Distance (mm)	P _{avg} (dBm)	P _{avg} (mW)	Estimated 1-g (W/kg)
BT Head	2.45	0	10.00	10.00	0.400
BT Body	2.45	10	10.00	10.00	0.200
Wi-Fi Head	2.45	0	2.00	1.58	0.067
Wi-Fi Body	2.45	10	2.00	1.58	0.034

When standalone SAR test exclusion applies to an antenna that transmits simultaneously with other antennas, the standalone SAR must be estimated according to following to determine simultaneous

transmission SAR test exclusion:

$[(\text{max. power of channel, including tune-up tolerance, mW})/(\text{min. test separation distance, mm})] \cdot [\sqrt{f(\text{GHz}/x)}] \text{ W/kg}$ for test separation distances $\leq 50 \text{ mm}$;

where $x = 7.5$ for 1-g SAR.

When the minimum test separation distance is $< 5 \text{ mm}$, a distance of 5 mm is applied to determine SAR test Exclusion

Simultaneous SAR test exclusion considerations:

GSM with BT:

Mode	Position	Reported SAR (W/kg)		ΣSAR
		GSM	BT	< 1.6W/kg
GSM850	Left Head Cheek	0.283	0.067	0.350
	Left Head Tilt	0.145	0.067	0.212
	Right Head Cheek	0.295	0.067	0.362
	Right Head Tilt	0.143	0.067	0.210
	Body-Headset-Back	0.407	0.034	0.441
PCS1900	Left Head Cheek	0.381	0.067	0.448
	Left Head Tilt	0.159	0.067	0.226
	Right Head Cheek	0.356	0.067	0.423
	Right Head Tilt	0.163	0.067	0.230
	Body-Headset-Back	0.645	0.034	0.679

WCDMA with BT:

Mode	Position	Reported SAR (W/kg)		ΣSAR
		WCDMA	BT	< 1.6W/kg
WCDMA 850	Left Head Cheek	0.111	0.067	0.178
	Left Head Tilt	0.072	0.067	0.139
	Right Head Cheek	0.106	0.067	0.173
	Right Head Tilt	0.066	0.067	0.133
WCDMA1700	Left Head Cheek	0.144	0.067	0.211
	Left Head Tilt	0.063	0.067	0.130
	Right Head Cheek	0.137	0.067	0.204
	Right Head Tilt	0.059	0.067	0.126
WCDMA1900	Left Head Cheek	0.316	0.067	0.383
	Left Head Tilt	0.129	0.067	0.196
	Right Head Cheek	0.300	0.067	0.367
	Right Head Tilt	0.136	0.067	0.203

LTE with BT:

Mode	Position	Reported SAR (W/kg)		ΣSAR
		LTE	BT	< 1.6W/kg
LTE Band2	Left Head Cheek	0.253	0.067	0.320
	Left Head Tilt	0.108	0.067	0.175
	Right Head Cheek	0.273	0.067	0.340
	Right Head Tilt	0.120	0.067	0.187
LTE Band4	Left Head Cheek	0.159	0.067	0.226
	Left Head Tilt	0.069	0.067	0.136
	Right Head Cheek	0.170	0.067	0.237
	Right Head Tilt	0.075	0.067	0.142
LTE Band5	Left Head Cheek	0.139	0.067	0.206
	Left Head Tilt	0.082	0.067	0.149
	Right Head Cheek	0.131	0.067	0.198
	Right Head Tilt	0.076	0.067	0.143
LTE Band7	Left Head Cheek	0.183	0.067	0.250
	Left Head Tilt	0.072	0.067	0.139
	Right Head Cheek	0.170	0.067	0.237
	Right Head Tilt	0.074	0.067	0.141
LTE Band17	Left Head Cheek	0.206	0.067	0.273
	Left Head Tilt	0.107	0.067	0.174
	Right Head Cheek	0.187	0.067	0.254
	Right Head Tilt	0.100	0.067	0.167

GSM with Wi-Fi:

Mode	Position	Reported SAR (W/kg)		ΣSAR
		GSM	Wi-Fi	< 1.6W/kg
GSM850	Left Head Cheek	0.283	0.400	0.683
	Left Head Tilt	0.145	0.400	0.545
	Right Head Cheek	0.295	0.400	0.695
	Right Head Tilt	0.143	0.400	0.543
	Body-Headset-Back	0.407	0.400	0.807
PCS1900	Left Head Cheek	0.381	0.400	0.781
	Left Head Tilt	0.159	0.400	0.559
	Right Head Cheek	0.356	0.400	0.756
	Right Head Tilt	0.163	0.400	0.563
	Body-Headset-Back	0.645	0.400	1.045

WCDMA with Wi-Fi:

Mode	Position	Reported SAR (W/kg)		ΣSAR
		WCDMA	Wi-Fi	< 1.6W/kg
WCDMA 850	Left Head Cheek	0.111	0.400	0.511
	Left Head Tilt	0.072	0.400	0.472
	Right Head Cheek	0.106	0.400	0.506
	Right Head Tilt	0.066	0.400	0.466
WCDMA1700	Left Head Cheek	0.144	0.400	0.544
	Left Head Tilt	0.063	0.400	0.463
	Right Head Cheek	0.137	0.400	0.537
	Right Head Tilt	0.059	0.400	0.459
WCDMA1900	Left Head Cheek	0.316	0.400	0.716
	Left Head Tilt	0.129	0.400	0.529
	Right Head Cheek	0.300	0.400	0.700
	Right Head Tilt	0.136	0.400	0.536

LTE with Wi-Fi:

Mode	Position	Reported SAR (W/kg)		ΣSAR
		LTE	Wi-Fi	< 1.6W/kg
LTE Band2	Left Head Cheek	0.253	0.400	0.653
	Left Head Tilt	0.108	0.400	0.508
	Right Head Cheek	0.273	0.400	0.673
	Right Head Tilt	0.120	0.400	0.520
LTE Band4	Left Head Cheek	0.159	0.400	0.559
	Left Head Tilt	0.069	0.400	0.469
	Right Head Cheek	0.170	0.400	0.570
	Right Head Tilt	0.075	0.400	0.475
LTE Band5	Left Head Cheek	0.139	0.400	0.539
	Left Head Tilt	0.082	0.400	0.482
	Right Head Cheek	0.131	0.400	0.531
	Right Head Tilt	0.076	0.400	0.476
LTE Band7	Left Head Cheek	0.183	0.400	0.583
	Left Head Tilt	0.072	0.400	0.472
	Right Head Cheek	0.170	0.400	0.570
	Right Head Tilt	0.074	0.400	0.474
LTE Band17	Left Head Cheek	0.206	0.400	0.606
	Left Head Tilt	0.107	0.400	0.507
	Right Head Cheek	0.187	0.400	0.587
	Right Head Tilt	0.100	0.400	0.500

Conclusion:

ΣSAR < 1.6 W/kg therefore simultaneous transmission SAR with Volume Scans is **not** required.

Evaluations for Simultaneous SAR, BT+GSM/3G/4G					
Test Position	Body-Back (1.0cm)	Body-Left (1.0cm)	Body-Right (1.0cm)	Body-Bottom (1.0cm)	Body-Top (1.0cm)
Mode	Stand Alone 1-g SAR (W/Kg)				
GPRS 850	0.563	0.278	0.311	0.187	/
GPRS 1900	0.909	0.279	0.367	0.776	/
WCDMA850	0.220	0.117	0.126	0.064	/
WCDMA1700	0.313	0.152	0.139	0.294	/
WCDMA 1900	0.723	0.268	0.288	0.686	/
LTE Band 2	0.665	0.255	0.216	0.611	/
LTE Band 4	0.378	0.157	0.175	0.339	/
LTE Band 5	0.260	0.096	0.101	0.074	/
LTE Band 7	0.393	0.139	0.146	0.369	/
LTE Band 17	0.342	0.141	0.129	0.071	/
BT	0.034	0.034	0.034	0.034	0.034
	Σ 1-g SAR(W/Kg)				
GPRS850 + BT	0.597	0.312	0.345	0.221	/
GPRS1900 + BT	0.943	0.313	0.401	0.810	/
WCDMA850 + BT	0.254	0.151	0.160	0.098	/
WCDMA1700+ BT	0.347	0.186	0.173	0.328	/
WCDMA 1900+ BT	0.757	0.302	0.322	0.720	/
LTE Band 2+ BT	0.699	0.289	0.250	0.645	/
LTE Band 4+ BT	0.412	0.191	0.209	0.373	/
LTE Band 5+ BT	0.294	0.130	0.135	0.108	/
LTE Band 7+ BT	0.427	0.173	0.180	0.403	/
LTE Band 17+ BT i	0.376	0.175	0.163	0.105	/

Evaluations for Simultaneous SAR, Mobile Hot Spot Positions					
Test Position	Body-Back (1.0cm)	Body-Left (1.0cm)	Body-Right (1.0cm)	Body-Bottom (1.0cm)	Body-Top (1.0cm)
Mode	Stand Alone 1-g SAR (W/Kg)				
GPRS 850	0.563	0.278	0.311	0.187	/
GPRS 1900	0.909	0.279	0.367	0.776	/
WCDMA850	0.220	0.117	0.126	0.064	/
WCDMA1700	0.313	0.152	0.139	0.294	/
WCDMA 1900	0.723	0.268	0.288	0.686	/
LTE Band 2	0.665	0.255	0.216	0.611	/
LTE Band 4	0.378	0.157	0.175	0.339	/
LTE Band 5	0.260	0.096	0.101	0.074	/
LTE Band 7	0.393	0.139	0.146	0.369	/
LTE Band 17	0.342	0.141	0.129	0.071	/
Wi-Fi	0.200	0.200	0.200	0.200	0.200

	∑ 1-g SAR(W/Kg)				
GPRS850 + Wi-Fi	0.763	0.478	0.511	0.387	/
GPRS1900 + Wi-Fi	1.109	0.479	0.567	0.976	/
WCDMA850 + Wi-Fi	0.420	0.317	0.326	0.264	/
WCDMA1700+ Wi-Fi	0.513	0.352	0.339	0.494	/
WCDMA 1900+ Wi-Fi	0.923	0.468	0.488	0.886	/
LTE Band 2+ Wi-Fi	0.865	0.455	0.416	0.811	/
LTE Band 4+ Wi-Fi	0.578	0.357	0.375	0.539	/
LTE Band 5+ Wi-Fi	0.460	0.296	0.301	0.274	/
LTE Band 7+ Wi-Fi	0.593	0.339	0.346	0.569	/
LTE Band 17+ Wi-Fi	0.542	0.341	0.329	0.271	/

Note:

If the sum of the 1g SAR measured for the simultaneously transmitting antennas is less than the SAR limit, SAR measurement for simultaneous transmission is not required.

SAR Plots (Summary of the Highest SAR Values)

Test Laboratory: Bay Area Compliance Lab Corp. (Shenzhen)

Right Head Cheek (824.2 MHz Low Channel)

Measurement Data

Test mode : GSM
 Crest Factor : 8
 Scan Type : Complete
 Area Scan : 11x8x1: Measurement x=10mm, y=10mm, z=4mm
 Zoom Scan : 7x7x7: Measurement x=5mm, y=5mm, z=5mm
 Power Drift-Start : 0.025 W/kg
 Power Drift-Finish : 0.025 W/kg
 Power Drift (%) : -1.387

Tissue Data

Type : Head
 Frequency : 824.2 MHz
 Epsilon : 41.07 F/m
 Sigma : 0.90 S/m
 Density : 1000.00 kg/cu. m

Probe Data

Serial No. : 500-00283
 Frequency Band : 835
 Duty Cycle Factor : 8
 Conversion Factor : 5.9
 Probe Sensitivity : 1.20 1.20 1.20 $\mu\text{V}/(\text{V/m})^2$
 Compression Point : 95.00 mV
 Offset : 1.56 mm

1 gram SAR value : 0.284 W/kg
 10 gram SAR value : 0.175 W/kg
 Area Scan Peak SAR : 0.295 W/kg
 Zoom Scan Peak SAR : 0.418 W/kg

Plot 1#

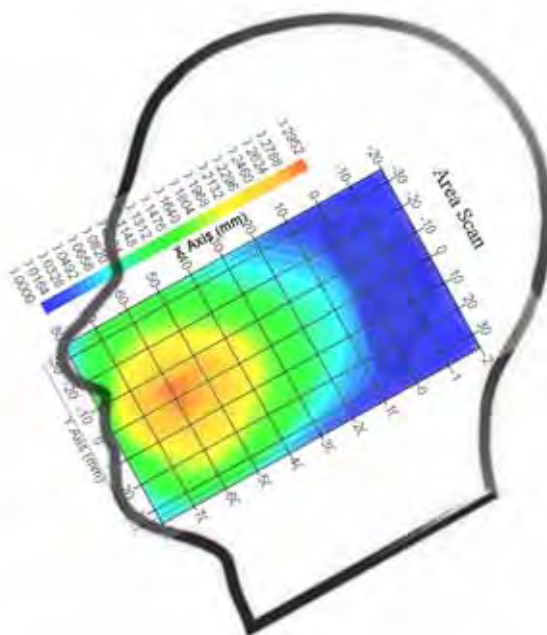

Test Laboratory: Bay Area Compliance Lab Corp. (Shenzhen)

Right Head Cheek(1850.2MHz Low Channel)

Measurement Data

Test mode : GSM
 Crest Factor : 8
 Scan Type : Complete
 Area Scan : 11x8x1 : Measurement x=10mm, y=10mm, z=4mm
 Zoom Scan : 7x7x7 : Measurement x=5mm, y=5mm, z=5mm
 Power Drift-Start : 0.002 W/kg
 Power Drift-Finish : 0.002W/kg
 Power Drift (%) : -2.514

Tissue Data

Type : Head
 Frequency : 1850.2 MHz
 Epsilon : 39.64 F/m
 Sigma : 1.37 S/m
 Density : 1000.00 kg/cu. M

Probe Data

Serial No. : 500-00283
 Frequency Band : 1900
 Duty Cycle Factor : 8
 Conversion Factor : 4.8
 Probe Sensitivity : 1.20 1.20 1.20 $\mu\text{V}/(\text{V}/\text{m})^2$
 Compression Point : 95.00 mV
 Offset : 1.56 mm

1 gram SAR value : 0.358 W/kg
 10 gram SAR value : 0.204 W/kg
 Area Scan Peak SAR : 0.396 W/kg
 Zoom Scan Peak SAR : 0.528 W/kg

Plot 2#

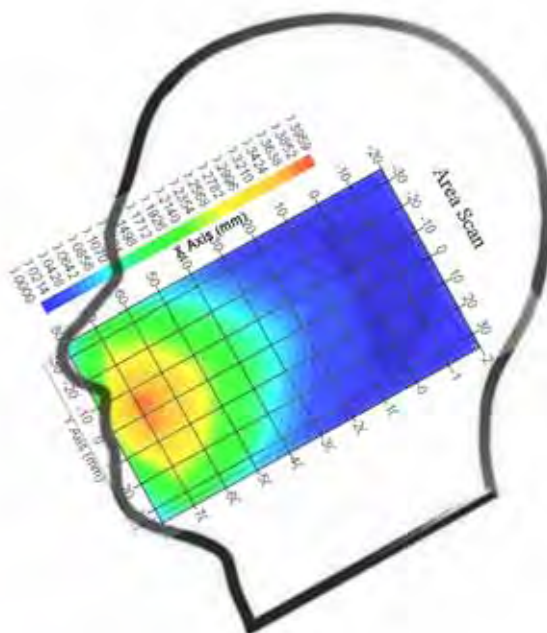

Test Laboratory: Bay Area Compliance Lab Corp. (Shenzhen)

WCDMA850; Left Head Cheek (826.4 MHz Low Channel)

Measurement Data

Test mode : WCDMA850
 Crest Factor : 1
 Scan Type : Complete
 Area Scan : 11x8x1: Measurement x=10mm, y=10mm, z=4mm
 Zoom Scan : 7x7x7: Measurement x=5mm, y=5mm, z=5mm
 Power Drift-Start : 0.015 W/kg
 Power Drift-Finish : 0.015 W/kg
 Power Drift (%) : -3.588

Tissue Data

Type : Head
 Frequency : 826.4 MHz
 Epsilon : 41.00 F/m
 Sigma : 0.91 S/m
 Density : 1000.00 kg/cu. m

Probe Data

Serial No. : 500-00283
 Frequency Band : 835
 Duty Cycle Factor : 1
 Conversion Factor : 5.9
 Probe Sensitivity : 1.20 1.20 1.20 $\mu\text{V}/(\text{V/m})^2$
 Compression Point : 95.00 mV
 Offset : 1.56 mm

1 gram SAR value : 0.109 W/kg
 10 gram SAR value : 0.070 W/kg
 Area Scan Peak SAR : 0.118 W/kg
 Zoom Scan Peak SAR : 0.186 W/kg

Plot 3#

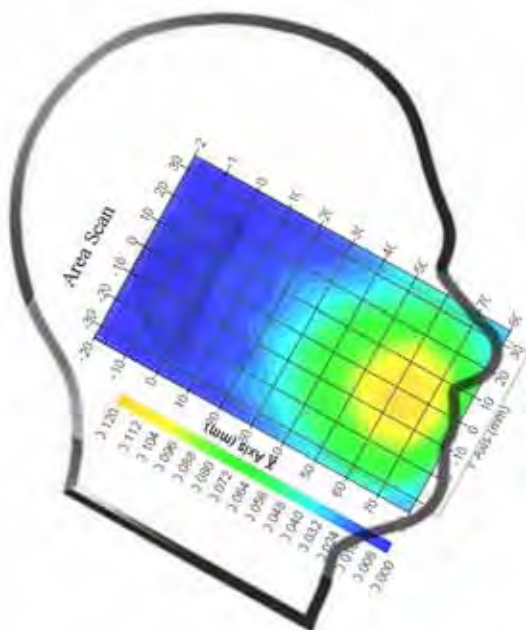

Test Laboratory: Bay Area Compliance Lab Corp. (Shenzhen)

WCDMA1700; Left Head Cheek (1752.6 MHz High Channel)

Measurement Data

Test mode : WCDMA1700
 Crest Factor : 1
 Scan Type : Complete
 Area Scan : 11x9x1: Measurement x=10mm, y=10mm, z=4mm
 Zoom Scan : 7x7x7: Measurement x=5mm, y=5mm, z=5mm
 Power Drift-Start : 0.001 W/kg
 Power Drift-Finish : 0.001 W/kg
 Power Drift (%) : 0.264

Tissue Data

Type : Head
 Frequency : 1752.6 MHz
 Epsilon : 39.24 F/m
 Sigma : 1.39 S/m
 Density : 1000.00 kg/cu. m

Probe Data

Serial No. : 500-00283
 Frequency Band : 1750
 Duty Cycle Factor : 1
 Conversion Factor : 5.4
 Probe Sensitivity : 1.20 1.20 1.20 $\mu\text{V}/(\text{V}/\text{m})^2$
 Compression Point : 95.00 mV
 Offset : 1.56 mm

1 gram SAR value : 0.142 W/kg
 10 gram SAR value : 0.082 W/kg
 Area Scan Peak SAR : 0.150 W/kg
 Zoom Scan Peak SAR : 0.239 W/kg

Plot 4#

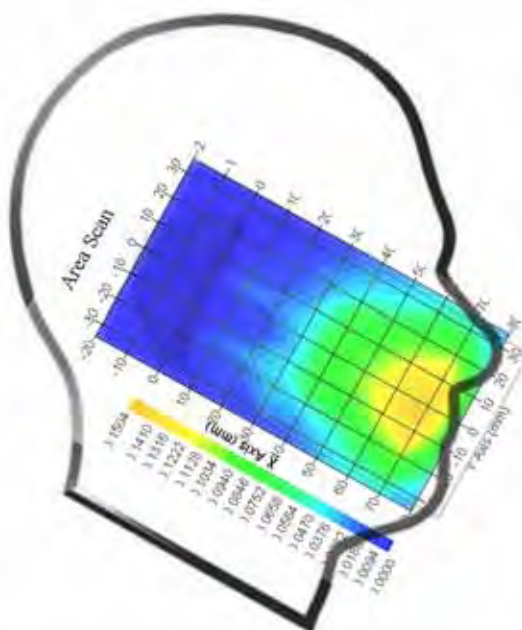

Test Laboratory: Bay Area Compliance Lab Corp. (Shenzhen)

WCDMA 1900; Left Head Cheek (1880 MHz Middle Channel)

Measurement Data

Test mode : WCDMA 1900
 Crest Factor : 1
 Scan Type : Complete
 Area Scan : 11x9x1: Measurement x=10mm, y=10mm, z=4mm
 Zoom Scan : 7x7x7: Measurement x=5mm, y=5mm, z=5mm
 Power Drift-Start : 0.003 W/kg
 Power Drift-Finish : 0.003 W/kg
 Power Drift (%) : 3.217

Tissue Data

Type : Head
 Frequency : 1880.0 MHz
 Epsilon : 39.58 F/m
 Sigma : 1.38 S/m
 Density : 1000.00 kg/cu. m

Probe Data

Serial No. : 500-00283
 Frequency Band : 1900
 Duty Cycle Factor : 1
 Conversion Factor : 4.8
 Probe Sensitivity : 1.20 1.20 1.20 $\mu\text{V}/(\text{V}/\text{m})^2$
 Compression Point : 95.00 mV
 Offset : 1.56 mm

1 gram SAR value : 0.314 W/kg
 10 gram SAR value : 0.199 W/kg
 Area Scan Peak SAR : 0.319 W/kg
 Zoom Scan Peak SAR : 0.447 W/kg

Plot 5#

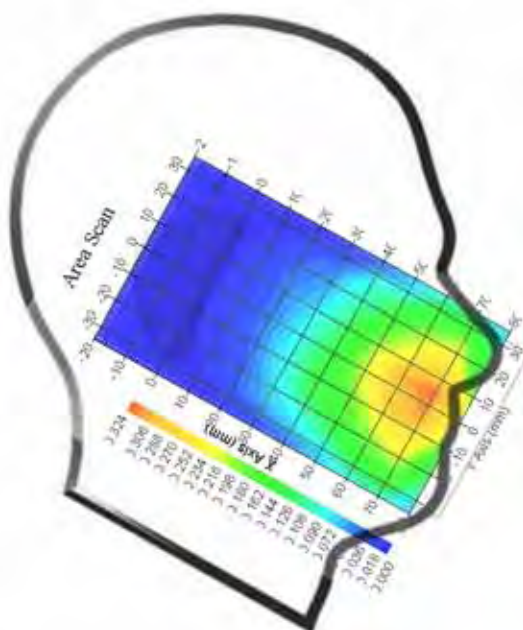

Test Laboratory: Bay Area Compliance Lab Corp. (Shenzhen)

LTE FDD Band2; Right-Head-Cheek (1860 MHz Low Channel);

Measurement Data

Test mode : RB1
 Crest Factor : 1
 Scan Type : Complete
 Area Scan : 8x11x1 : Measurement x=10mm, y=10mm, z=4mm
 Zoom Scan : 7x7x7 : Measurement x=5mm, y=5mm, z=5mm
 Power Drift-Start : 0.002 W/kg
 Power Drift-Finish : 0.002 W/kg
 Power Drift (%) : -2.321

Tissue Data

Type : Head
 Frequency : 1860 MHz
 Epsilon : 39.62 F/m
 Sigma : 1.39 S/m
 Density : 1000.00 kg/cu. m

Probe Data

Serial No. : 500-00283
 Frequency Band : 1900
 Duty Cycle Factor : 1
 Conversion Factor : 4.8
 Probe Sensitivity : 1.20 1.20 1.20 $\mu\text{V}/(\text{V}/\text{m})^2$
 Compression Point : 95.00 mV
 Offset : 1.56 mm

1 gram SAR value : 0.258 W/kg
 10 gram SAR value : 0.174 W/kg
 Area Scan Peak SAR : 0.273 W/kg
 Zoom Scan Peak SAR : 0.396 W/kg

Plot 6#

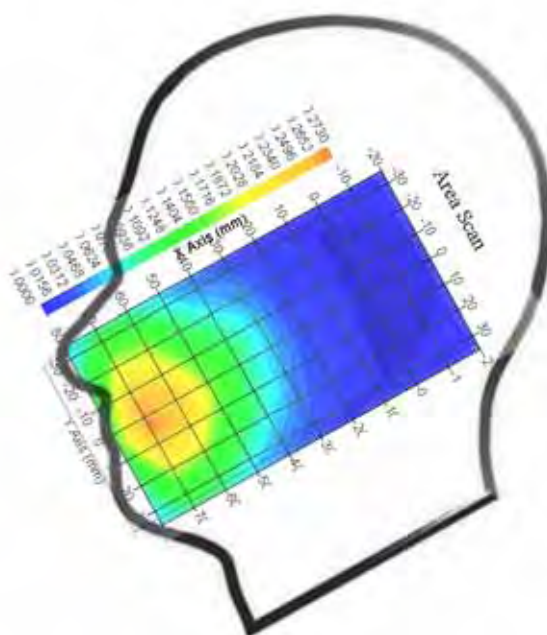

Test Laboratory: Bay Area Compliance Lab Corp. (Shenzhen)

LTE FDD Band4; Right-Head-Cheek (1745 MHz High Channel);

Measurement Data

Test mode : RB1
 Crest Factor : 1
 Scan Type : Complete
 Area Scan : 8x11x1 : Measurement x=10mm, y=10mm, z=4mm
 Zoom Scan : 7x7x7 : Measurement x=5mm, y=5mm, z=5mm
 Power Drift-Start : 0.001 W/kg
 Power Drift-Finish : 0.001 W/kg
 Power Drift (%) : -1.117

Tissue Data

Type : Head
 Frequency : 1745 MHz
 Epsilon : 39.37 F/m
 Sigma : 1.39 S/m
 Density : 1000.00 kg/cu. m

Probe Data

Serial No. : 500-00283
 Frequency Band : 1750
 Duty Cycle Factor : 1
 Conversion Factor : 5.4
 Probe Sensitivity : 1.20 1.20 1.20 $\mu\text{V}/(\text{V}/\text{m})^2$
 Compression Point : 95.00 mV
 Offset : 1.56 mm

1 gram SAR value : 0.168 W/kg
 10 gram SAR value : 0.089 W/kg
 Area Scan Peak SAR : 0.172 W/kg
 Zoom Scan Peak SAR : 0.294 W/kg

Plot 7#

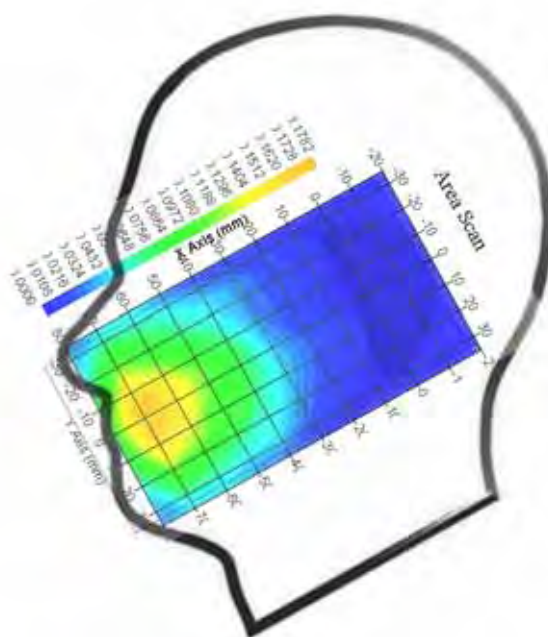

Test Laboratory: Bay Area Compliance Lab Corp. (Shenzhen)

LTE FDD Band5; Left-Head-Cheek (829 MHz Low Channel);

Measurement Data

Test mode : RB1
 Crest Factor : 1
 Scan Type : Complete
 Area Scan : 8x11x1 : Measurement x=10mm, y=10mm, z=4mm
 Zoom Scan : 7x7x7 : Measurement x=5mm, y=5mm, z=5mm
 Power Drift-Start : 0.001 W/kg
 Power Drift-Finish : 0.001 W/kg
 Power Drift (%) : -1.638

Tissue Data

Type : Head
 Frequency : 829 MHz
 Epsilon : 41.01 F/m
 Sigma : 0.91 S/m
 Density : 1000.00 kg/cu. m

Probe Data

Serial No. : 500-00283
 Frequency Band : 835
 Duty Cycle Factor : 1
 Conversion Factor : 5.9
 Probe Sensitivity : 1.20 1.20 1.20 $\mu\text{V}/(\text{V}/\text{m})^2$
 Compression Point : 95.00 mV
 Offset : 1.56 mm

1 gram SAR value : 0.137 W/kg
 10 gram SAR value : 0.072 W/kg
 Area Scan Peak SAR : 0.147 W/kg
 Zoom Scan Peak SAR : 0.205 W/kg

Plot 8#

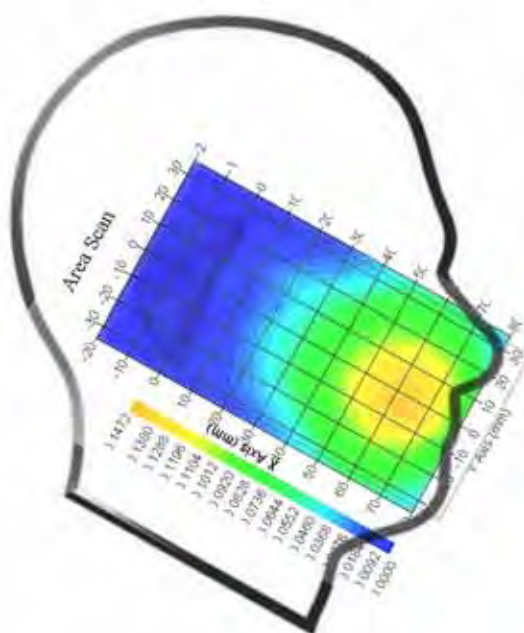

Test Laboratory: Bay Area Compliance Lab Corp. (Shenzhen)

LTE FDD Band7; Left-Head-Cheek (2560 MHz High Channel);

Measurement Data

Test mode : RB1
 Crest Factor : 1
 Scan Type : Complete
 Area Scan : 8x11x1 : Measurement x=10mm, y=10mm, z=4mm
 Zoom Scan : 7x7x7 : Measurement x=5mm, y=5mm, z=5mm
 Power Drift-Start : 0.001 W/kg
 Power Drift-Finish : 0.001 W/kg
 Power Drift (%) : 2.487

Tissue Data

Type : Head
 Frequency : 2560 MHz
 Epsilon : 39.58 F/m
 Sigma : 1.82 S/m
 Density : 1000.00 kg/cu. m

Probe Data

Serial No. : 500-00283
 Frequency Band : 2450
 Duty Cycle Factor : 1
 Conversion Factor : 4.9
 Probe Sensitivity : 1.20 1.20 1.20 $\mu\text{V}/(\text{V}/\text{m})^2$
 Compression Point : 95.00 mV
 Offset : 1.56 mm

1 gram SAR value : 0.176 W/kg
 10 gram SAR value : 0.091 W/kg
 Area Scan Peak SAR : 0.188 W/kg
 Zoom Scan Peak SAR : 0.295 W/kg

Plot 9#

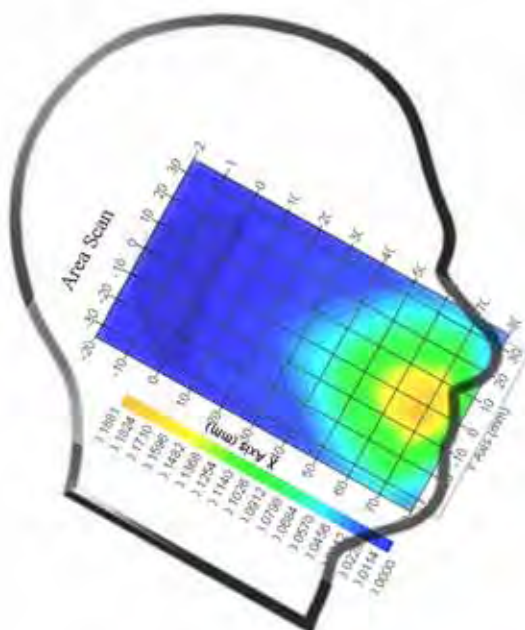

Test Laboratory: Bay Area Compliance Lab Corp. (Shenzhen)

LTE FDD Band17; Left-Head-Cheek (709 MHz Low Channel);

Measurement Data

Test mode : RB1
 Crest Factor : 1
 Scan Type : Complete
 Area Scan : 8x11x1 : Measurement x=10mm, y=10mm, z=4mm
 Zoom Scan : 7x7x7 : Measurement x=5mm, y=5mm, z=5mm
 Power Drift-Start : 0.024 W/kg
 Power Drift-Finish : 0.024 W/kg
 Power Drift (%) : -0.639

Tissue Data

Type : Head
 Frequency : 709 MHz
 Epsilon : 42.00 F/m
 Sigma : 0.87 S/m
 Density : 1000.00 kg/cu. m

Probe Data

Serial No. : 500-00283
 Frequency Band : 750
 Duty Cycle Factor : 1
 Conversion Factor : 6.0
 Probe Sensitivity : 1.20 1.20 1.20 $\mu\text{V}/(\text{V}/\text{m})^2$
 Compression Point : 95.00 mV
 Offset : 1.56 mm

1 gram SAR value : 0.198 W/kg
 10 gram SAR value : 0.132 W/kg
 Area Scan Peak SAR : 0.207 W/kg
 Zoom Scan Peak SAR : 0.374 W/kg

Plot 10#

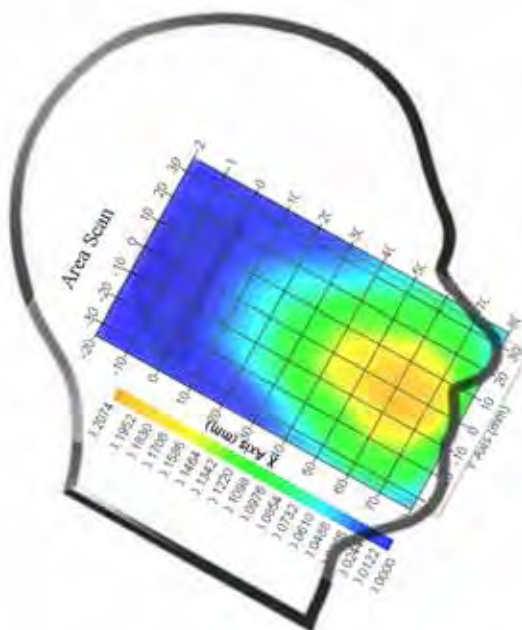

Test Laboratory: Bay Area Compliance Lab Corp. (Shenzhen)

Body-worn-Back (848.8 MHz High Channel)

Measurement Data

Test mode : GPRS
 Crest Factor : 2
 Scan Type : Complete
 Area Scan : 8x11x1 : Measurement x=10mm, y=10mm, z=4mm
 Zoom Scan : 7x7x7 : Measurement x=5mm, y=5mm, z=5mm
 Power Drift-Start : 0.477 W/kg
 Power Drift-Finish : 0.469 W/kg
 Power Drift (%) : -1.879

Tissue Data

Type : Body
 Frequency : 848.8 MHz
 Epsilon : 53.80 F/m
 Sigma : 0.98 S/m
 Density : 1000.00 kg/cu. m

Probe Data

Serial No. : 500-00283
 Frequency Band : 835
 Duty Cycle Factor : 2
 Conversion Factor : 5.9
 Probe Sensitivity : 1.20 1.20 1.20 $\mu\text{V}/(\text{V}/\text{m})^2$
 Compression Point : 95.00 mV
 Offset : 1.56 mm

1 gram SAR value : 0.559 W/kg
 10 gram SAR value : 0.418 W/kg
 Area Scan Peak SAR : 0.563 W/kg
 Zoom Scan Peak SAR : 0.874 W/kg

Plot 11#

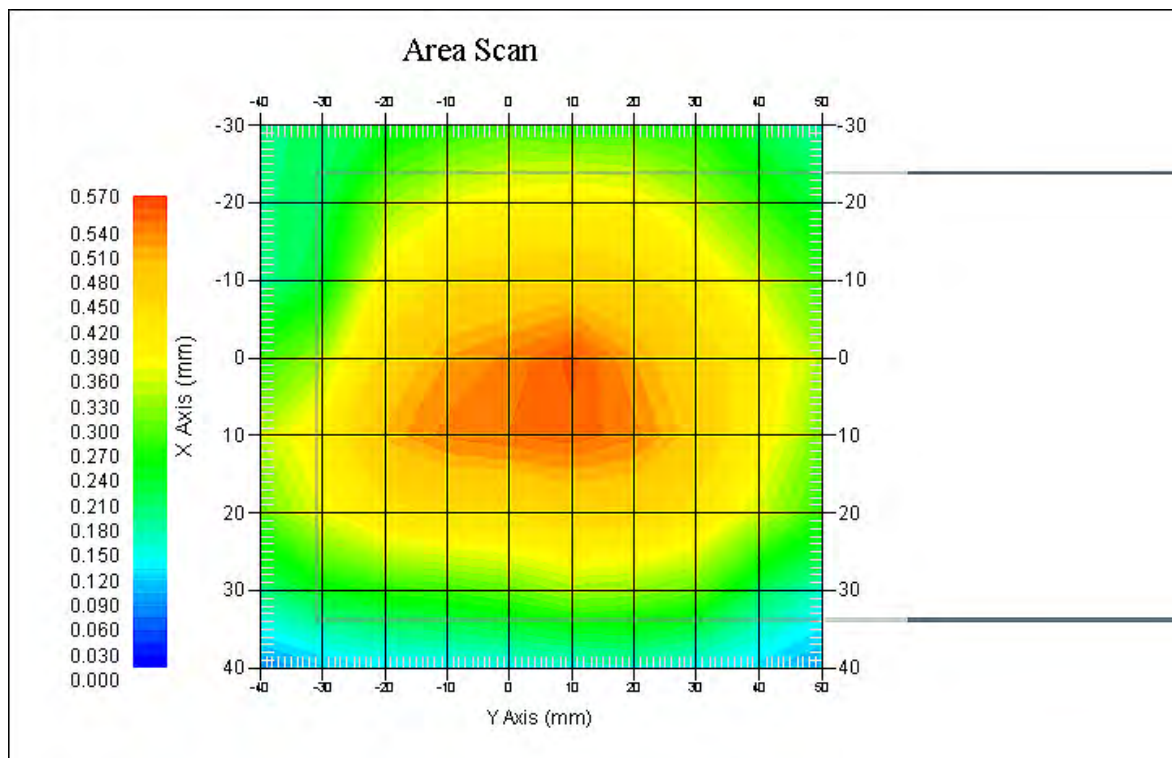

Test Laboratory: Bay Area Compliance Lab Corp. (Shenzhen)

Body-worn-Back (1909.8MHz High Channel)

Measurement Data

Test mode : GPRS
 Crest Factor : 2.67
 Scan Type : Complete
 Area Scan : 8x11x1 : Measurement x=10mm, y=10mm, z=4mm
 Zoom Scan : 7x7x7 : Measurement x=5mm, y=5mm, z=5mm
 Power Drift-Start : 0.624 W/kg
 Power Drift-Finish : 0.636 W/kg
 Power Drift (%) : 1.901

Tissue Data

Type : Body
 Frequency : 1909.8 MHz
 Epsilon : 52.07 F/m
 Sigma : 1.54 S/m
 Density : 1000.00 kg/cu. m

Probe Data

Serial No. : 500-00283
 Frequency Band : 1900
 Duty Cycle Factor : 2.67
 Conversion Factor : 4.5
 Probe Sensitivity : 1.20 1.20 1.20 $\mu\text{V}/(\text{V}/\text{m})^2$
 Compression Point : 95.00 mV
 Offset : 1.56 mm

1 gram SAR value : 0.872 W/kg
 10 gram SAR value : 0.563 W/kg
 Area Scan Peak SAR : 0.929 W/kg
 Zoom Scan Peak SAR : 1.428 W/kg

Plot 12#

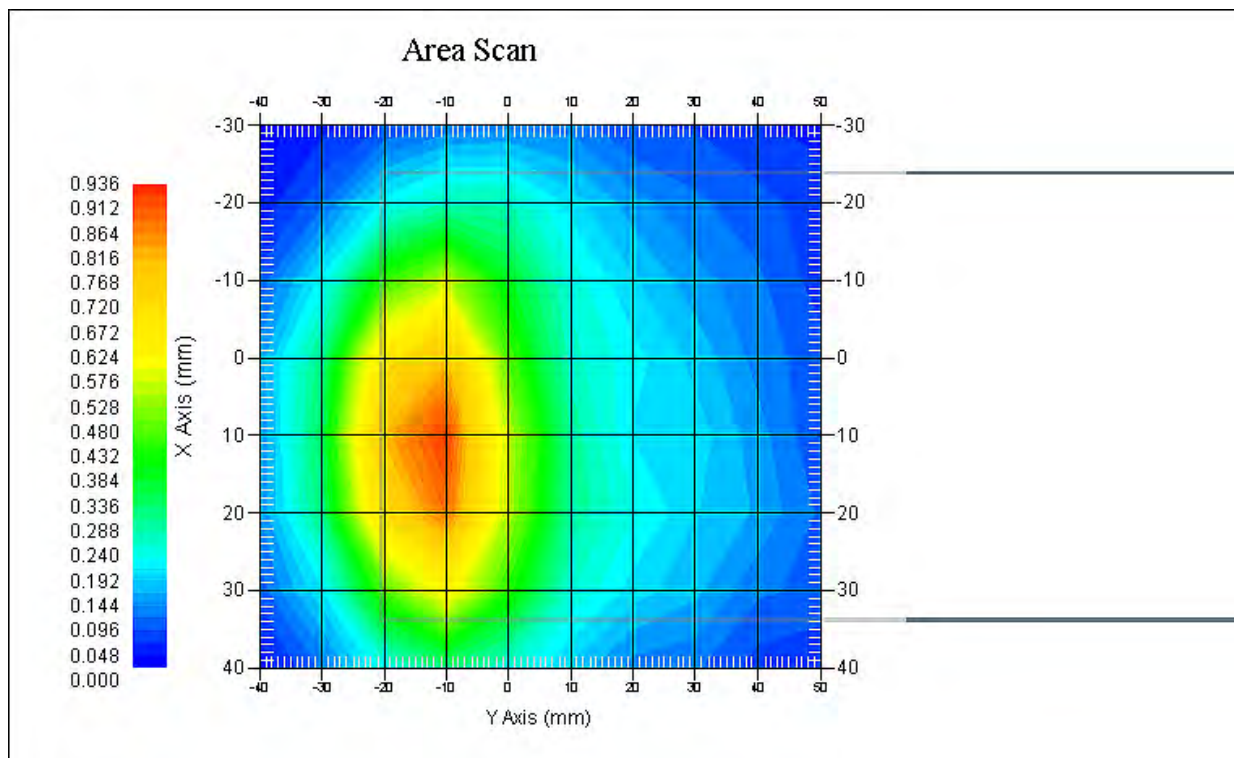

Test Laboratory: Bay Area Compliance Lab Corp. (Shenzhen)

WCDMA850; Body-Worn-Back (826.4 MHz Low Channel)

Measurement Data

Test mode : WCDMA850
 Crest Factor : 1
 Scan Type : Complete
 Area Scan : 11x8x1: Measurement x=10mm, y=10mm, z=4mm
 Zoom Scan : 7x7x7: Measurement x=5mm, y=5mm, z=5mm
 Power Drift-Start : 0.185 W/kg
 Power Drift-Finish : 0.183 W/kg
 Power Drift (%) : -1.189

Tissue Data

Type : Body
 Frequency : 826.4 MHz
 Epsilon : 53.85 F/m
 Sigma : 0.95 S/m
 Density : 1000.00 kg/cu. m

Probe Data

Serial No. : 500-00283
 Frequency Band : 835
 Duty Cycle Factor : 1
 Conversion Factor : 5.9
 Probe Sensitivity : 1.20 1.20 1.20 $\mu\text{V}/(\text{V}/\text{m})^2$
 Compression Point : 95.00 mV
 Offset : 1.56 mm

1 gram SAR value : 0.216 W/kg
 10 gram SAR value : 0.174 W/kg
 Area Scan Peak SAR : 0.221 W/kg
 Zoom Scan Peak SAR : 0.359 W/kg

Plot 13#

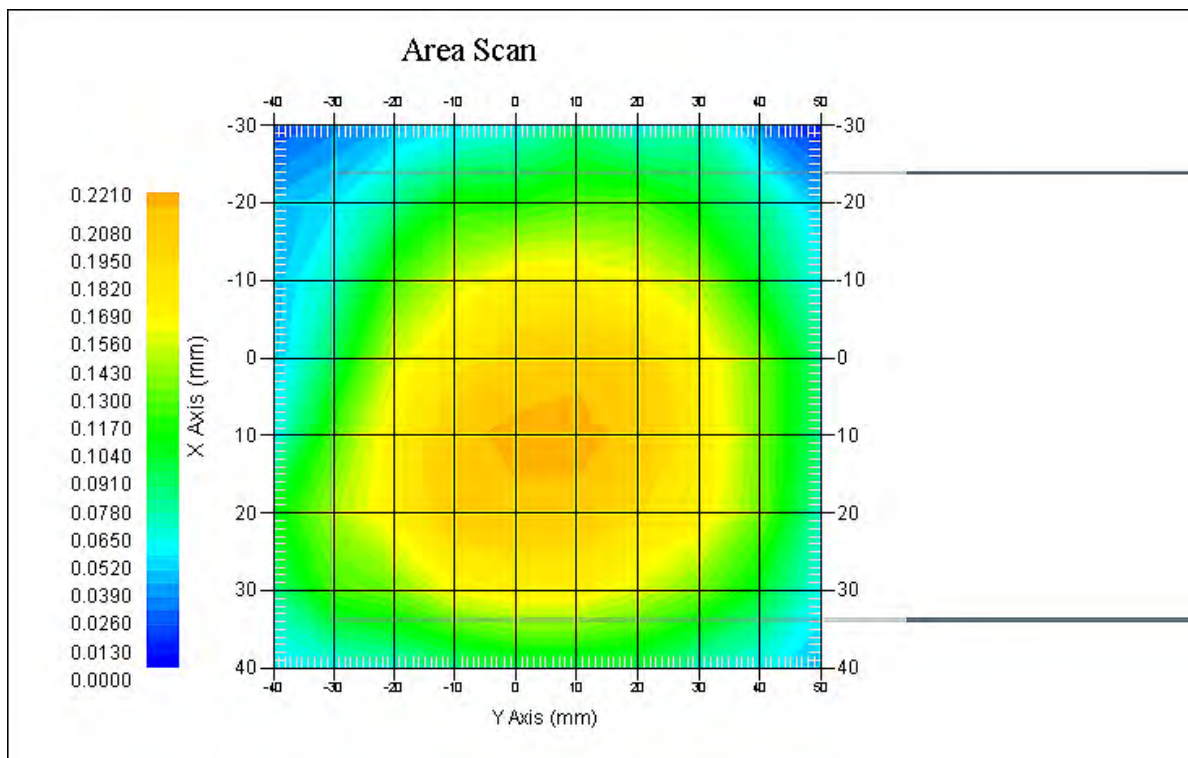

Test Laboratory: Bay Area Compliance Lab Corp. (Shenzhen)

WCDMA 1700; Body-Worn-Back (1752.6 MHz High Channel)

Measurement Data

Test mode : WCDMA 1700
 Crest Factor : 1
 Scan Type : Complete
 Area Scan : 11x9x1: Measurement x=10mm, y=10mm, z=4mm
 Zoom Scan : 7x7x7: Measurement x=5mm, y=5mm, z=5mm
 Power Drift-Start : 0.253 W/kg
 Power Drift-Finish : 0.250 W/kg
 Power Drift (%) : -1.239

Tissue Data

Type : Body
 Frequency : 1752.6 MHz
 Epsilon : 51.96 F/m
 Sigma : 1.52 S/m
 Density : 1000.00 kg/cu. m

Probe Data

Serial No. : 500-00283
 Frequency Band : 1750
 Duty Cycle Factor : 1
 Conversion Factor : 5.3
 Probe Sensitivity : 1.20 1.20 1.20 $\mu\text{V}/(\text{V}/\text{m})^2$
 Compression Point : 95.00 mV
 Offset : 1.56 mm

1 gram SAR value : 0.308 W/kg
 10 gram SAR value : 0.202 W/kg
 Area Scan Peak SAR : 0.319 W/kg
 Zoom Scan Peak SAR : 0.477 W/kg

Plot 14#

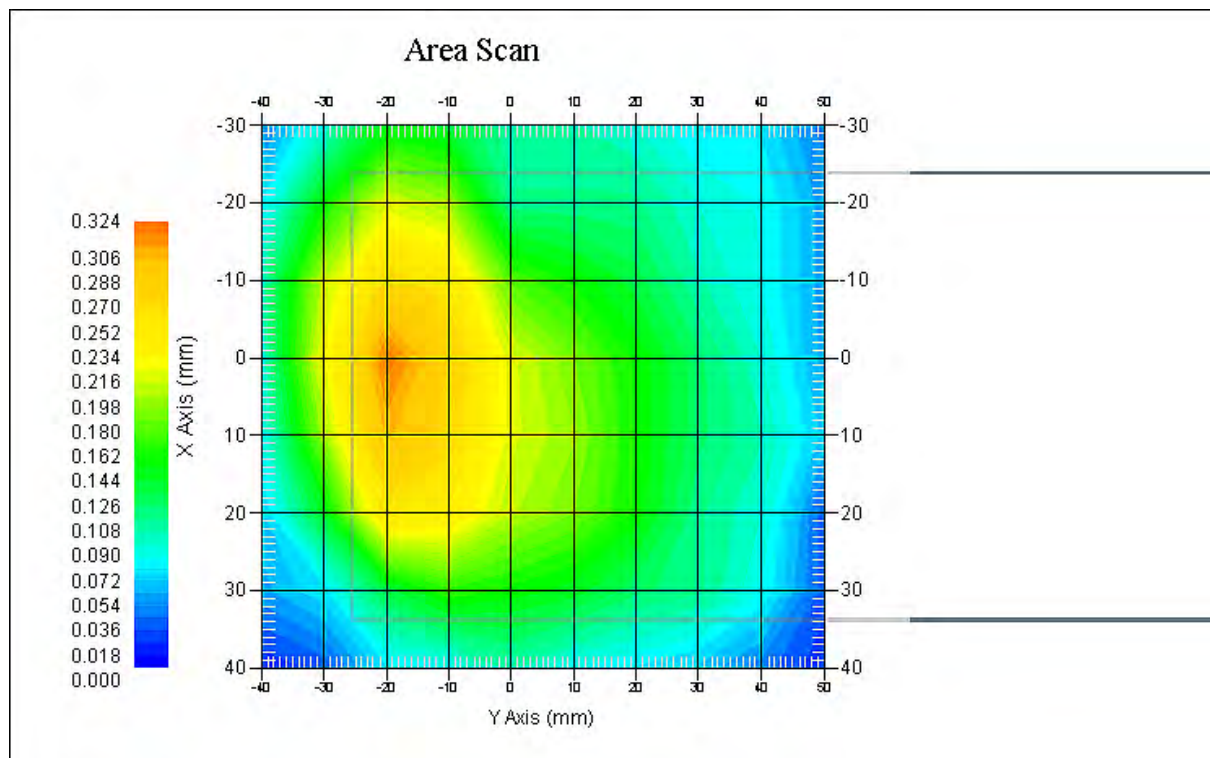

Test Laboratory: Bay Area Compliance Lab Corp. (Shenzhen)

WCDMA1900; Body-Worn-Back (1880 MHz Middle Channel)

Measurement Data

Test mode : WCDMA1900
 Crest Factor : 1
 Scan Type : Complete
 Area Scan : 11x9x1: Measurement x=10mm, y=10mm, z=4mm
 Zoom Scan : 7x7x7: Measurement x=5mm, y=5mm, z=5mm
 Power Drift-Start : 0.428 W/kg
 Power Drift-Finish : 0.435 W/kg
 Power Drift (%) : 1.794

Tissue Data

Type : Body
 Frequency : 1907.6 MHz
 Epsilon : 51.89 F/m
 Sigma : 1.51 S/m
 Density : 1000.00 kg/cu. m

Probe Data

Serial No. : 500-00283
 Frequency Band : 1900
 Duty Cycle Factor : 1
 Conversion Factor : 4.8
 Probe Sensitivity : 1.20 1.20 1.20 $\mu\text{V}/(\text{V}/\text{m})^2$
 Compression Point : 95.00 mV
 Offset : 1.56 mm

1 gram SAR value : 0.712 W/kg
 10 gram SAR value : 0.479 W/kg
 Area Scan Peak SAR : 0.755 W/kg
 Zoom Scan Peak SAR : 1.086 W/kg

Plot 15#

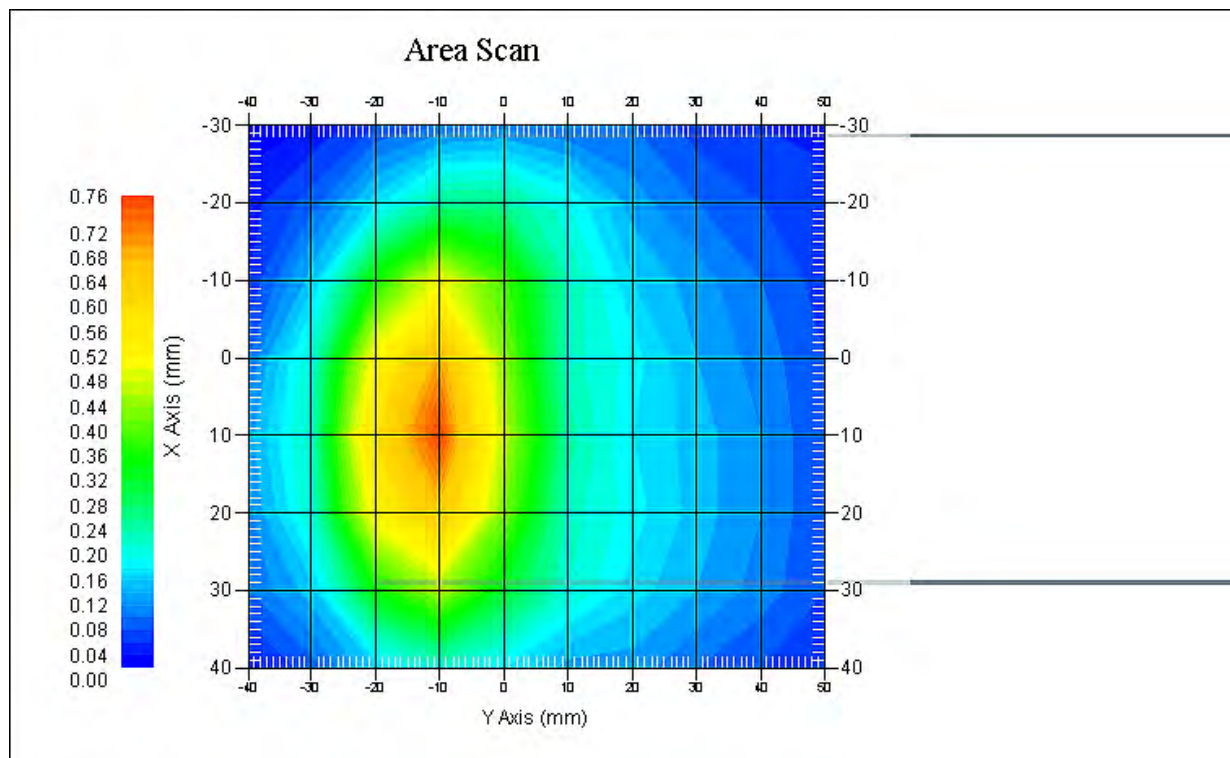

Test Laboratory: Bay Area Compliance Lab Corp. (Shenzhen)

LTE FDD Band2; Body-Worn-Back (1860 MHz Low Channel);

Measurement Data

Test mode : 1RB
 Crest Factor : 1
 Scan Type : Complete
 Area Scan : 8x11x1 : Measurement x=10mm, y=10mm, z=4mm
 Zoom Scan : 7x7x7 : Measurement x=5mm, y=5mm, z=5mm
 Power Drift-Start : 0.458 W/kg
 Power Drift-Finish : 0.450 W/kg
 Power Drift (%) : -1.829

Tissue Data

Type : Body
 Frequency : 1860 MHz
 Epsilon : 51.98 F/m
 Sigma : 1.50 S/m
 Density : 1000.00 kg/cu. m

Probe Data

Serial No. : 500-00283
 Frequency Band : 1900
 Duty Cycle Factor : 1
 Conversion Factor : 4.5
 Probe Sensitivity : 1.20 1.20 1.20 $\mu\text{V}/(\text{V}/\text{m})^2$
 Compression Point : 95.00 mV
 Offset : 1.56 mm

1 gram SAR value : 0.628 W/kg
 10 gram SAR value : 0.391 W/kg
 Area Scan Peak SAR : 0.665 W/kg
 Zoom Scan Peak SAR : 1.027 W/kg

Plot 16#

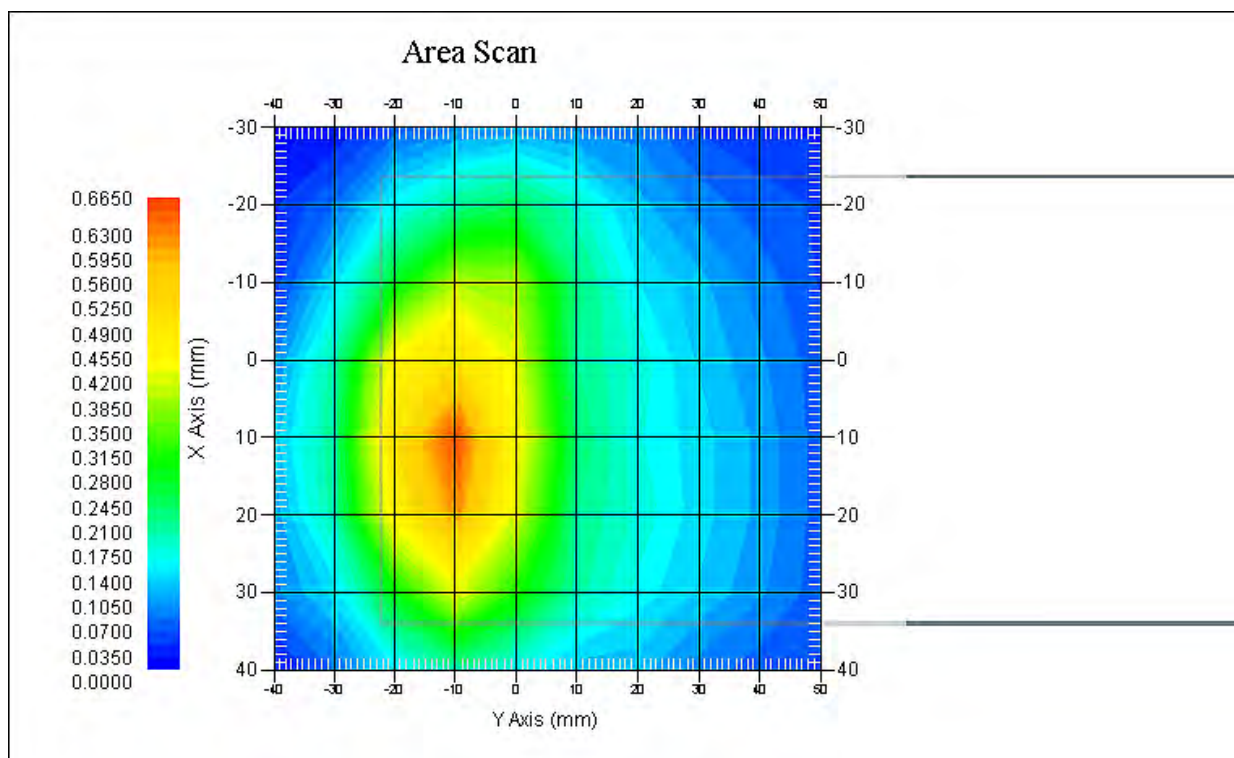

Test Laboratory: Bay Area Compliance Lab Corp. (Shenzhen)

LTE FDD Band4; Body-Worn-Back (1745 MHz High Channel);

Measurement Data

Test mode : 1RB
 Crest Factor : 1
 Scan Type : Complete
 Area Scan : 8x11x1 : Measurement x=10mm, y=10mm, z=4mm
 Zoom Scan : 7x7x7 : Measurement x=5mm, y=5mm, z=5mm
 Power Drift-Start : 0.295 W/kg
 Power Drift-Finish : 0.300 W/kg
 Power Drift (%) : 1.697

Tissue Data

Type : Body
 Frequency : 1745 MHz
 Epsilon : 51.88 F/m
 Sigma : 1.52 S/m
 Density : 1000.00 kg/cu. m

Probe Data

Serial No. : 500-00283
 Frequency Band : 1750
 Duty Cycle Factor : 1
 Conversion Factor : 5.3
 Probe Sensitivity : 1.20 1.20 1.20 $\mu\text{V}/(\text{V}/\text{m})^2$
 Compression Point : 95.00 mV
 Offset : 1.56 mm

1 gram SAR value : 0.374 W/kg
 10 gram SAR value : 0.246 W/kg
 Area Scan Peak SAR : 0.388 W/kg
 Zoom Scan Peak SAR : 0.596 W/kg

Plot 17#

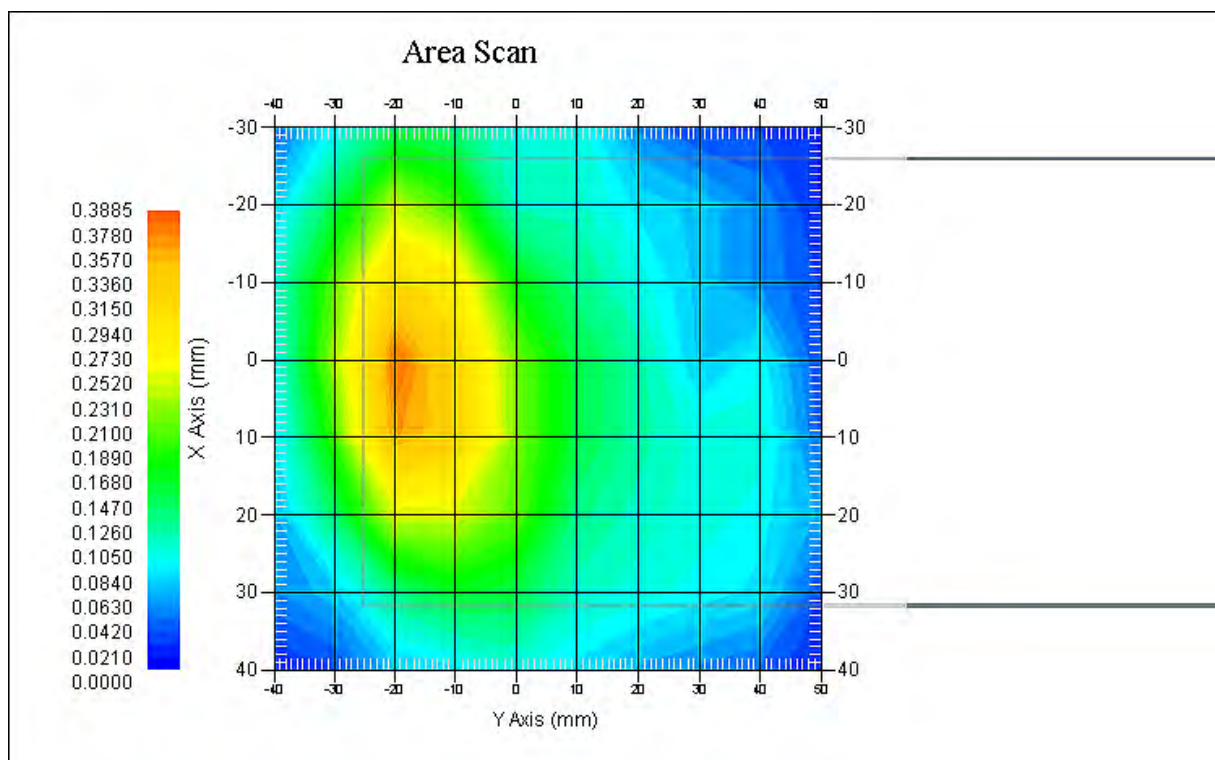

Test Laboratory: Bay Area Compliance Lab Corp. (Shenzhen)

LTE FDD Band5; Body-Worn-Back (829 MHz Low Channel);

Measurement Data

Test mode : 1RB
 Crest Factor : 1
 Scan Type : Complete
 Area Scan : 8x11x1 : Measurement x=10mm, y=10mm, z=4mm
 Zoom Scan : 7x7x7 : Measurement x=5mm, y=5mm, z=5mm
 Power Drift-Start : 0.225 W/kg
 Power Drift-Finish : 0.220 W/kg
 Power Drift (%) : -2.315

Tissue Data

Type : Body
 Frequency : 829 MHz
 Epsilon : 53.81 F/m
 Sigma : 0.95 S/m
 Density : 1000.00 kg/cu. m

Probe Data

Serial No. : 500-00283
 Frequency Band : 835
 Duty Cycle Factor : 1
 Conversion Factor : 5.9
 Probe Sensitivity : 1.20 1.20 1.20 $\mu\text{V}/(\text{V}/\text{m})^2$
 Compression Point : 95.00 mV
 Offset : 1.56 mm

1 gram SAR value : 0.257 W/kg
 10 gram SAR value : 0.196 W/kg
 Area Scan Peak SAR : 0.263 W/kg
 Zoom Scan Peak SAR : 0.400 W/kg

Plot 18#

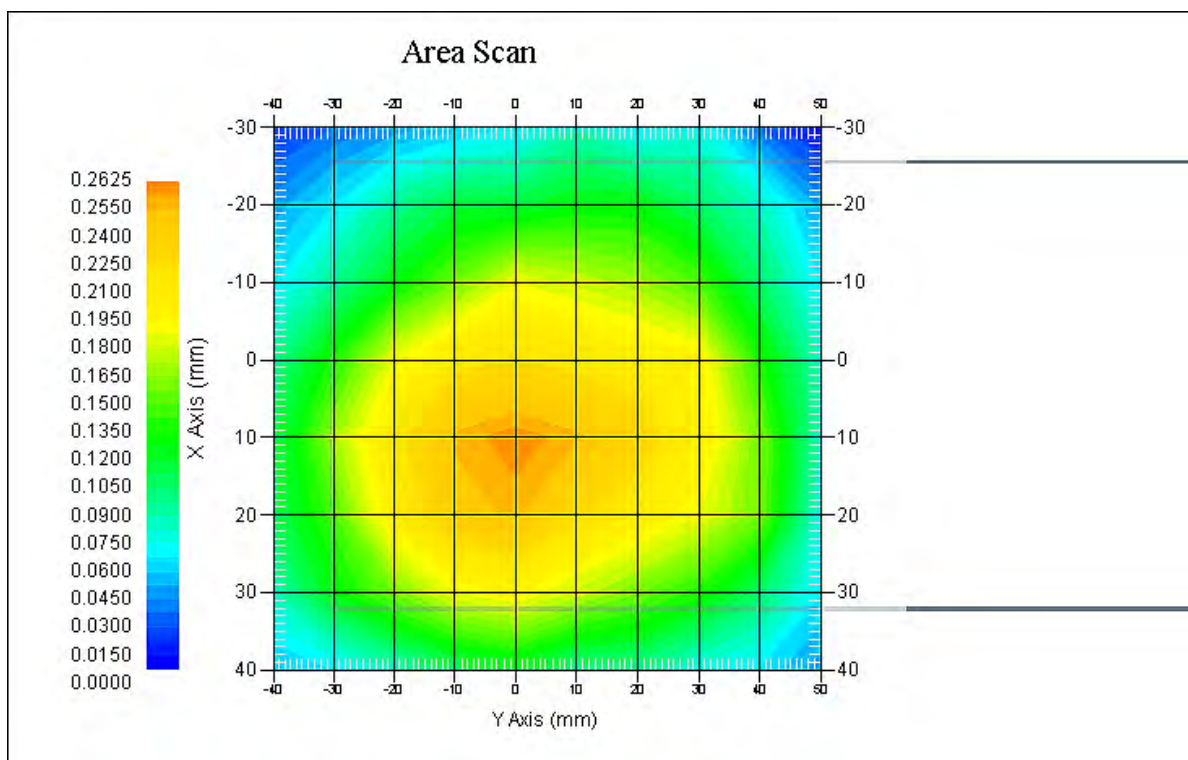

Test Laboratory: Bay Area Compliance Lab Corp. (Shenzhen)

LTE FDD Band7; Body-Worn-Back (2560 MHz High Channel);

Measurement Data

Test mode : 1RB
 Crest Factor : 1
 Scan Type : Complete
 Area Scan : 8x11x1 : Measurement x=10mm, y=10mm, z=4mm
 Zoom Scan : 7x7x7 : Measurement x=5mm, y=5mm, z=5mm
 Power Drift-Start : 0.239 W/kg
 Power Drift-Finish : 0.240 W/kg
 Power Drift (%) : 0.579

Tissue Data

Type : Body
 Frequency : 2560 MHz
 Epsilon : 51.88 F/m
 Sigma : 1.95 S/m
 Density : 1000.00 kg/cu. m

Probe Data

Serial No. : 500-00283
 Frequency Band : 2450
 Duty Cycle Factor : 1
 Conversion Factor : 4.3
 Probe Sensitivity : 1.20 1.20 1.20 $\mu\text{V}/(\text{V}/\text{m})^2$
 Compression Point : 95.00 mV
 Offset : 1.56 mm

1 gram SAR value : 0.377 W/kg
 10 gram SAR value : 0.249 W/kg
 Area Scan Peak SAR : 0.396 W/kg
 Zoom Scan Peak SAR : 0.618 W/kg

Plot 19#

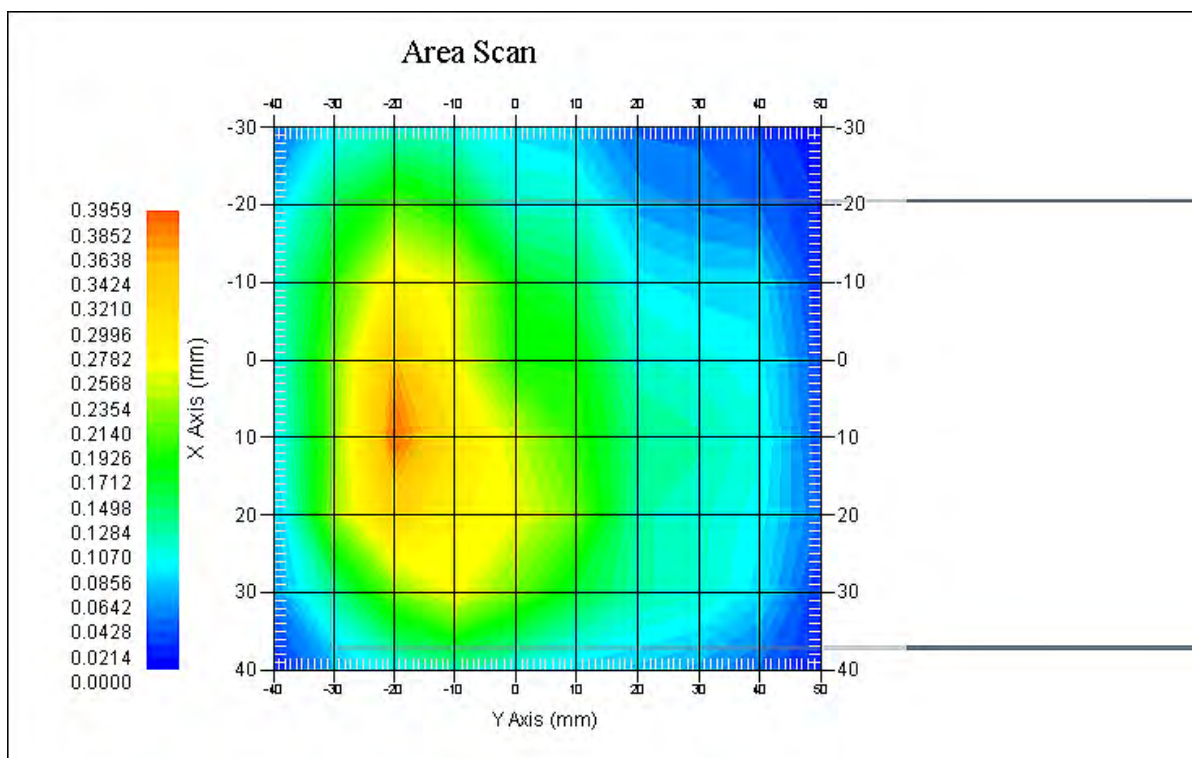

Test Laboratory: Bay Area Compliance Lab Corp. (Shenzhen)

LTE FDD Band17; Body-Worn-Back (709 MHz Low Channel);

Measurement Data

Test mode : 1RB
 Crest Factor : 1
 Scan Type : Complete
 Area Scan : 8x11x1 : Measurement x=10mm, y=10mm, z=4mm
 Zoom Scan : 7x7x7 : Measurement x=5mm, y=5mm, z=5mm
 Power Drift-Start : 0.285 W/kg
 Power Drift-Finish : 0.279 W/kg
 Power Drift (%) : -2.264

Tissue Data

Type : Body
 Frequency : 709 MHz
 Epsilon : 53.83 F/m
 Sigma : 0.96 S/m
 Density : 1000.00 kg/cu. m

Probe Data

Serial No. : 500-00283
 Frequency Band : 750
 Duty Cycle Factor : 1
 Conversion Factor : 5.5
 Probe Sensitivity : 1.20 1.20 1.20 $\mu\text{V}/(\text{V}/\text{m})^2$
 Compression Point : 95.00 mV
 Offset : 1.56 mm

1 gram SAR value : 0.329 W/kg
 10 gram SAR value : 0.235 W/kg
 Area Scan Peak SAR : 0.342 W/kg
 Zoom Scan Peak SAR : 0.495 W/kg

Plot 20#

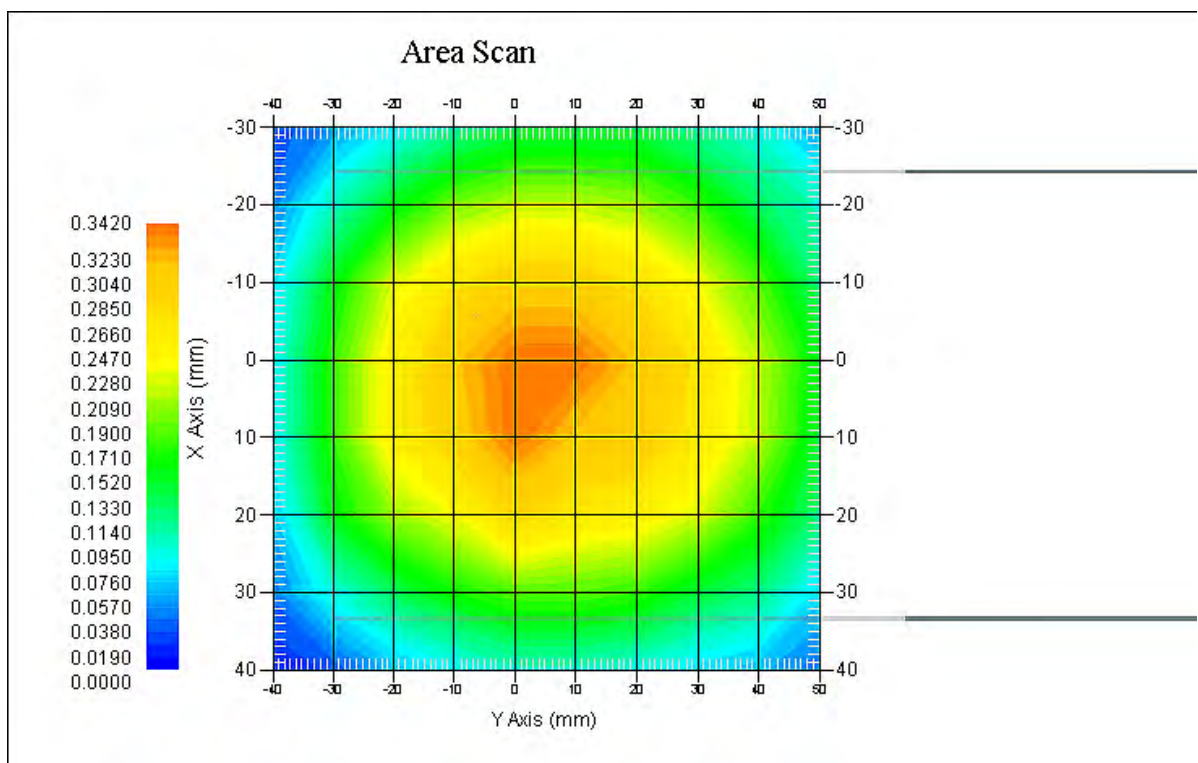

APPENDIX A MEASUREMENT UNCERTAINTY

The uncertainty budget has been determined for the measurement system and is given in the following Table.

Measurement Uncertainty for 30MHz to 6GHz

Source of Uncertainty	Tolerance Value	Probability Distribution	Divisor	c_i^1 (1-g)	c_i^1 (10-g)	Standard Uncertainty (1-g) %	Standard Uncertainty (10-g) %
Measurement System							
Probe Calibration	3.5	normal	1	1	1	3.5	3.5
Axial Isotropy	3.7	rectangular	$\sqrt{3}$	$(1-cp)^{1/2}$	$(\frac{1-cp}{2})^{1/2}$	1.5	1.5
Hemispherical Isotropy	10.9	rectangular	$\sqrt{3}$	\sqrt{cp}	\sqrt{cp}	4.4	4.4
Boundary Effect	1.0	rectangular	$\sqrt{3}$	1	1	0.6	0.6
Linearity	4.7	rectangular	$\sqrt{3}$	1	1	2.7	2.7
Detection Limit	1.0	rectangular	$\sqrt{3}$	1	1	0.6	0.6
Readout Electronics	1.0	normal	1	1	1	1.0	1.0
Response Time	0.8	rectangular	$\sqrt{3}$	1	1	0.5	0.5
Integration Time	1.7	rectangular	$\sqrt{3}$	1	1	1.0	1.0
RF Ambient Condition -Noise	0.6	rectangular	$\sqrt{3}$	1	1	0.3	0.3
RF Ambient Condition - Reflections	3.0	rectangular	$\sqrt{3}$	1	1	1.7	1.7
Probe Positioner Mech. Restrictions	0.4	rectangular	$\sqrt{3}$	1	1	0.2	0.2
Restriction							
Probe Positioning with respect to Phantom Shell	2.9	rectangular	$\sqrt{3}$	1	1	1.7	1.7
Extrapolation and Integration	3.7	rectangular	$\sqrt{3}$	1	1	2.1	2.1
Test Sample Positioning	2.3	normal	1	1	1	2.3	2.3
Device Holder Uncertainty	6.215	normal	1	1	1	6.215	6.215
Drift of Output Power	4.627	rectangular	$\sqrt{3}$	1	1	2.67	2.67
Phantom and Setup							
Phantom Uncertainty(shape & thickness tolerance)	3.4	rectangular	$\sqrt{3}$	1	1	2.0	2.0
Liquid Conductivity(target)	5.0	rectangular	$\sqrt{3}$	0.7	0.5	2.0	1.4
Liquid Conductivity(meas.)	1.938	normal	1	0.7	0.5	1.36	0.97
Liquid Permittivity(target)	5.0	rectangular	$\sqrt{3}$	0.6	0.5	1.7	1.4
Liquid Permittivity(meas.)	3.093	normal	1	0.6	0.5	1.86	1.55
Combined Uncertainty		RSS				10.78	10.55
Expanded uncertainty (coverage factor=2)		Normal(k=2)				21.56	21.10

APPENDIX B – PROBE CALIBRATION CERTIFICATES

NCL CALIBRATION LABORATORIES

Calibration File No.: PC-1598

Task No: BACL-5778

CERTIFICATE OF CALIBRATION

It is certified that the equipment identified below has been calibrated in the
NCL CALIBRATION LABORATORIES by qualified personnel following recognized
procedures and using transfer standards traceable to NRC/NIST.

Equipment: Miniature Isotropic RF Probe

Record of Calibration

Head and Body

Manufacturer: APREL Laboratories

Model No.: E-020

Serial No.: 500-00283

Calibration Procedure: D01-032-ED20-V2, D22-012-Tissue, D28-002-Dipole

Project No: BACL-5745

Calibrated: 14th October 2014.

Released on: 14th October 2014

This Calibration Certificate is incomplete unless accompanied with the Calibration Results Summary

Released By: _____



Art Brennan, Quality Manager

NCL CALIBRATION LABORATORIES

Suite 102, 303 Terry Fox Dr.
OTTAWA, ONTARIO
CANADA K2K 3J1

Division of APREL Lab.
TEL: (613) 435-8300
FAX: (613) 435-8306

NCL Calibration Laboratories

Division of APREL, Inc.

Introduction

This Calibration Report reproduces the results of the calibration performed in line with the references listed below. Calibration is performed using accepted methodologies as per the references listed below. Probes are calibrated for air, and tissue and the values reported are the results from the physical quantification of the probe through meteorological practices.

Calibration Method

Probes are calibrated using the following methods.

<1000MHz

TEM Cell for sensitivity in air

Standard phantom using temperature transfer method for sensitivity in tissue

>1000MHz

Waveguide* method to determine sensitivity in air and tissue

*Waveguide is numerically (simulation) assessed to determine the field distribution and power

The boundary effect for the probe is assessed using a standard flat phantom where the probe output is compared against a numerically simulated series of data points

References

- IEEE Standard 1528
- IEEE Recommended Practice for Determining the Peak Spatial-Average Specific Absorption Rate (SAR) in the Human Head from Wireless Communications Devices: Measurement Techniques
- EN 62209-1
- Human Exposure to RF Fields from hand-held and body-mounted wireless communication devices - Human models, instrumentation, and procedures-Part 1: Procedure to measure the Specific Absorption Rate (SAR) for hand-held mobile wireless devices
- IEC 62209-2
- Human exposure to RF fields from hand-held and body-mounted wireless devices - Human models, instrumentation, and procedures - Part 2: specific absorption rate (SAR) for wireless communication devices (30 MHz - 6 GHz)
- TP-D01-032-E020-V2 E-Field probe calibration procedure
- D22-012-Tissue dielectric tissue calibration procedure
- D28-002-Dipole procedure for validation of SAR system using a dipole
- IEEE 1309 Standard for Calibration of Electromagnetic Field Sensors and Probes, Excluding Antennas, from 9kHz to 40GHz

Page 2 of 10

This page has been reviewed for content and attested to on Page 2 of this document.

NCL Calibration Laboratories

Division of APREL, Inc.

Conditions

Probe 500-00283 was a recalibration.

Ambient Temperature of the Laboratory: 22 °C +/- 1.5°C
Temperature of the Tissue: 21 °C +/- 1.5°C
Relative Humidity: < 60%

Primary Measurement Standards

Instrument	Serial Number	Cal due date
Tektronix USB Power Meter	11C940	May 14, 2015
Signal Generator HP 83640B	3844A00689	Feb 12, 2015

Secondary Measurement Standards

Network Analyzer Anritsu 37347C	002106	Feb. 20, 2015
---------------------------------	--------	---------------

Attestation

The below named signatories have conducted the calibration and review of the data which is presented in this calibration report.

We the undersigned attest that to the best of our knowledge the calibration of this subject has been accurately conducted and that all information contained within the results pages have been reviewed for accuracy.



 Art Brennan, Quality Manager



 Dan Brooks, Test Engineer

NCL Calibration Laboratories

Division of APREL, Inc.

Probe Summary

Probe Type:	E-Field Probe E020
Serial Number:	500-00283
Frequency:	As presented on page 5
Sensor Offset:	1.56
Sensor Length:	2.5
Tip Enclosure:	Composite*
Tip Diameter:	< 2.9 mm
Tip Length:	55 mm
Total Length:	289 mm

*Resistive to recommended tissue recipes per IEEE-1528.

Sensitivity in Air

Channel X:	1.2 $\mu\text{V}/(\text{V}/\text{m})^2$
Channel Y:	1.2 $\mu\text{V}/(\text{V}/\text{m})^2$
Channel Z:	1.2 $\mu\text{V}/(\text{V}/\text{m})^2$
Diode Compression Point:	95 mV

Page 4 of 10
This page has been reviewed for content and attested to on Page 2 of this document.

NCL Calibration Laboratories

Division of APREL, Inc.

Calibration for Tissue (Head H, Body B)

Frequency	Tissue Type	Measured Epsilon	Measured Sigma	Standard Uncertainty (%)	Calibration Frequency Range (MHz)	Conversion Factor
450 H	Head	43.59	0.86	3.5	±50	5.7
450 B	Body	56.74	0.94	3.5	±50	5.8
750 H	Head	42.98	0.92	3.5	±50	6.0
750 B	Body	43.05	0.93	3.5	±50	5.5
835 H	Head	43.42	0.94	3.5	±50	5.9
835 B	Body	55.77	1.01	3.5	±50	5.9
900 H	Head	41.87	1.06	3.5	±50	6.0
900 B	Body	55.62	1.05	3.5	±50	5.9
1450 H	Head	X	X	X	X	X
1450 B	Body	X	X	X	X	X
1500 H	Head	X	X	X	X	X
1500 B	Body	X	X	X	X	X
1640 H	Head	X	X	X	X	X
1640 B	Body	X	X	X	X	X
1750 H	Head	38.23	1.38	3.5	±75	5.4
1750 B	Body	52.86	1.54	3.5	±75	5.3
1800 H	Head	X	X	X	X	X
1800 B	Body	X	X	X	X	X
1900 H	Head	40.20	1.38	3.5	±75	4.8
1900 B	Body	52.63	1.46	3.5	±75	4.5
2000 H	Head	X	X	X	X	X
2000 B	Body	X	X	X	X	X
2100 H	Head	X	X	X	X	X
2100 B	Body	X	X	X	X	X
2300 H	Head	X	X	X	X	X
2300 B	Body	X	X	X	X	X
2450 H	Head	37.26	1.84	3.5	±75	4.9
2450 B	Body	53.61	1.9	3.5	±75	4.3
3000 H	Head	X	X	X	X	X
3000 B	Body	X	X	X	X	X
3600 H	Head	37.49	3.16	3.5	±100	4.5
3600 B	Body	49.94	3.86	3.5	±100	4.0
5250 H	Head	35.51	4.78	3.5	±100	3.0
5250 B	Body	47.54	5.11	3.5	±100	2.8
5600 H	Head	36.05	5.15	3.5	±100	2.8
5600 B	Body	46.49	5.72	3.5	±100	2.2
5800 H	Head	45.99	6.01	3.5	±100	3.2
5800 B	Body	35.6	5.37	3.5	±100	2.5

NCL Calibration Laboratories

Division of APREL, Inc.

Boundary Effect:

Uncertainty resulting from the boundary effect is less than 2.1% for the distance between the tip of the probe and the tissue boundary, when less than 0.58mm.

Spatial Resolution:

The spatial resolution uncertainty is less than 1.5% for 4.9mm diameter probe.
The spatial resolution uncertainty is less than 1.0% for 2.5mm diameter probe.

DAQ-PAQ Contribution

To minimize the uncertainty calculation all tissue sensitivity values were calculated using a load impedance of 5 MΩ.

Page 6 of 10

This page has been reviewed for content and attested to on Page 2 of this document.

NCL Calibration Laboratories

Division of APREI, Inc.

Receiving Pattern Air

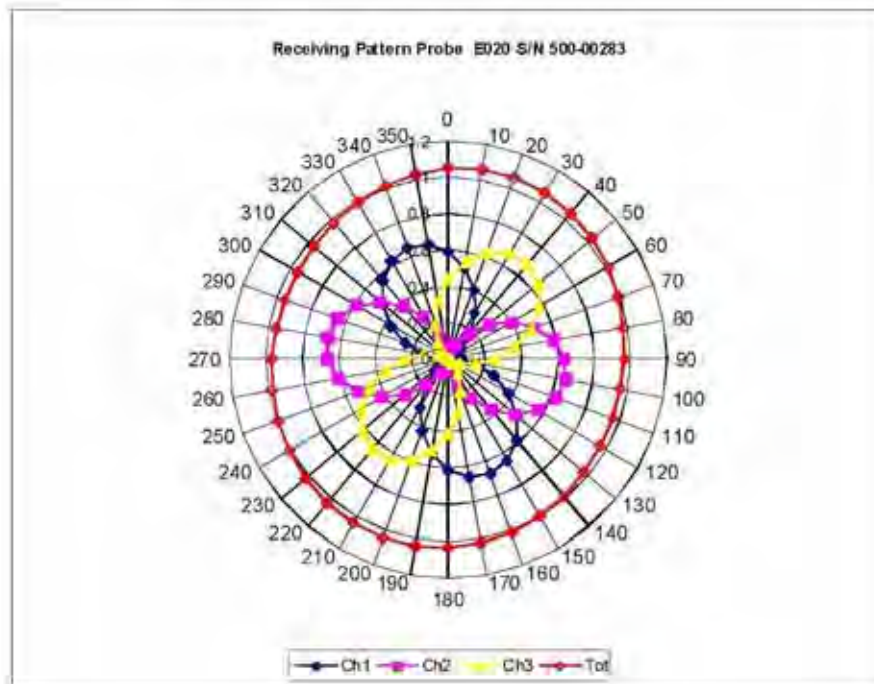

Page 7 of 10

This page has been reviewed for content and attested to on Page 2 of this document.

NCL Calibration Laboratories

Division of APREI, Inc.

Isotropy Error Air

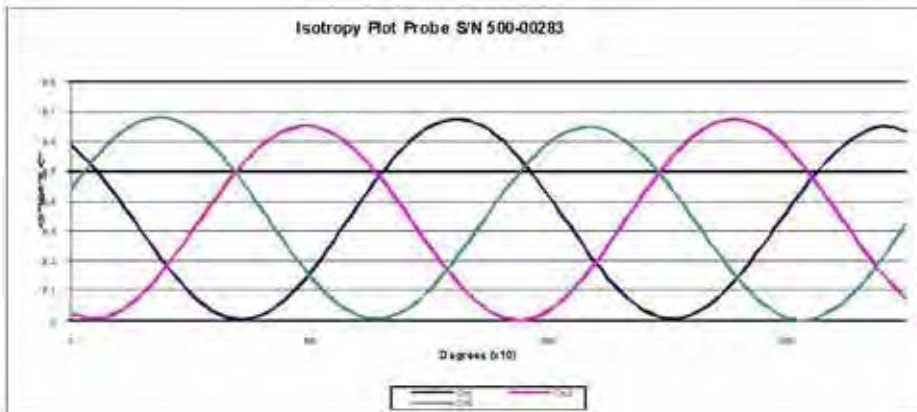
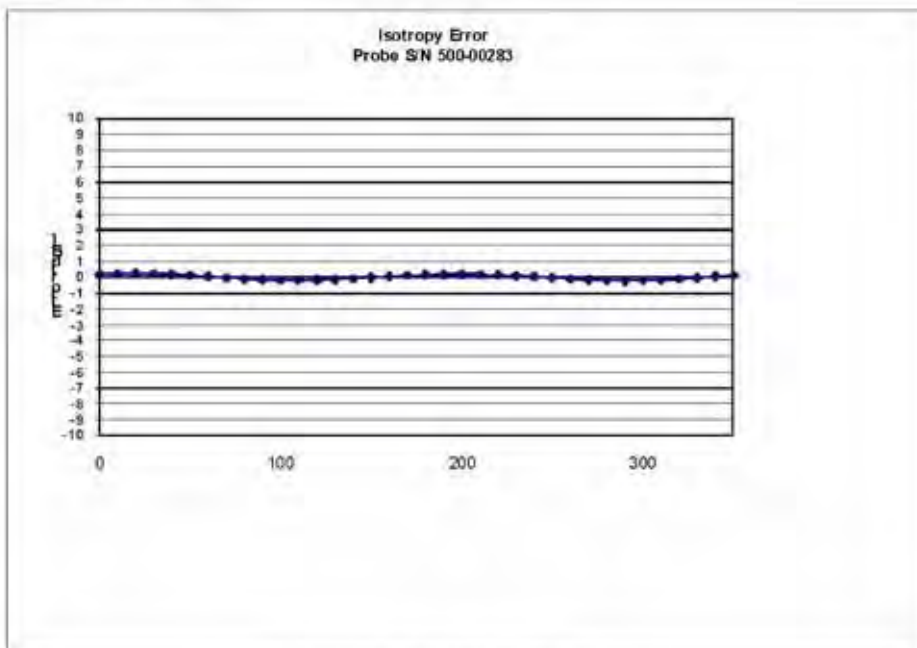

Isotropicity Tissue: 0.10 dB

Page 8 of 10
This page has been reviewed for content and attested to on Page 2 of this document.

NCL Calibration Laboratories

Division of APREI, Inc.

Dynamic Range

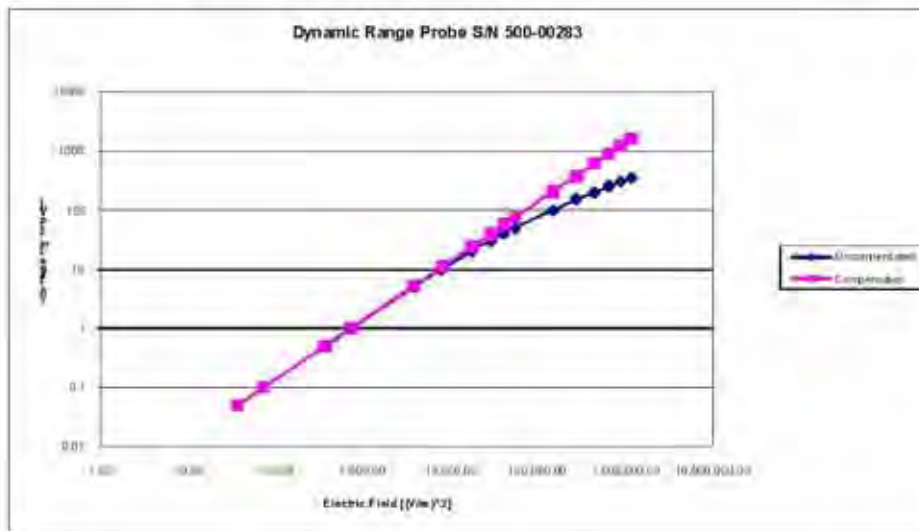

NCL Calibration Laboratories

Division of APREL, Inc.

Video Bandwidth

Probe Frequency Characteristics

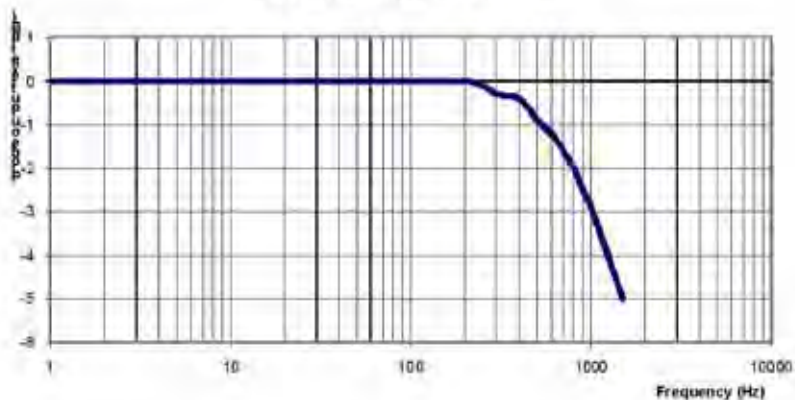

Video Bandwidth at 500 Hz 1 dB
Video Bandwidth at 1.02 KHz: 3 dB

Test Equipment

The test equipment used during Probe Calibration, manufacturer, model number and, current calibration status are listed and located on the main APREL server R:\NCL\Calibration Equipment\Instrument List May 2014.

Page 10 of 10
This page has been reviewed for content and attested to on Page 2 of this document.

APPENDIX C DIPOLE CALIBRATION CERTIFICATES

NCL CALIBRATION LABORATORIES

Calibration File No: DC-1532
Project Number: BACL-5745

CERTIFICATE OF CALIBRATION

It is certified that the equipment identified below has been calibrated in the
NCL CALIBRATION LABORATORIES by qualified personnel following recognized
procedures and using transfer standards traceable to NRC/NIST.

Validation Dipole

Manufacturer: APREL Laboratories
Part number: ALS-D-750-S-2
Frequency: 750 MHz
Serial No: 177-00505

Customer: BACL

Calibrated: 8th of October 2013
Released on: 8th of October 2013

This Calibration Certificate is Incomplete Unless Accompanied with the Calibration Results Summary

Released By: _____

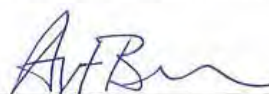

Art Brennan, Quality Manager

NCL CALIBRATION LABORATORIES

303 Terry Fox Drive, Suite 102
Kanata, Ontario
CANADA K2K 3J1

Division of APREL
TEL: (613) 435-8300
FAX: (613) 435-8308

NCL Calibration Laboratories

Division of APREL Laboratories.

Conditions

Dipole 177-00505 was a new calibration, removed from stock.

Ambient Temperature of the Laboratory: 22 °C +/- 0.5°C

Temperature of the Tissue: 21 °C +/- 0.5°C

We the undersigned attest that to the best of our knowledge the calibration of this device has been accurately conducted and that all information contained within this report has been reviewed for accuracy.

We the undersigned attest that to the best of our knowledge the calibration of this subject has been accurately conducted and that all information contained within the results pages have been reviewed for accuracy.

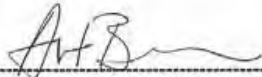

Art Brennan, Quality Manager



Dan Brooks, Test Engineer

This page has been reviewed for content and attested to by signature within this document.

NCL Calibration Laboratories

Division of APREL Laboratories.

Calibration Results Summary

The following results relate the Calibrated Dipole and should be used as a quick reference for the user.

Mechanical Dimensions

Length: 180.2 mm
Height: 97.0 mm

Electrical Calibration

Test	Result Head	Result Body
S11 R/L	-27.621 dB	-21.672 dB
SWR	1.106 U	1.201 U
Impedance	52.505 Ω	55.933 Ω

System Validation Results

Frequency	1 Gram	10 Gram
750 MHz		
Head	8.5	54.0
Body	8.54	5.42

Head

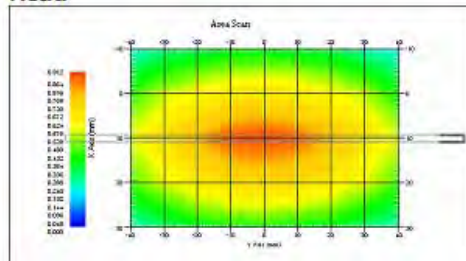

Body

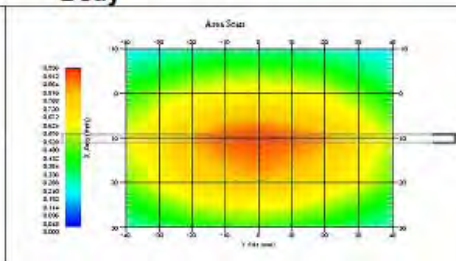

This page has been reviewed for content and attested to by signature within this document.

NCL Calibration Laboratories

Division of APREL Laboratories.

Introduction

This Calibration Report has been produced in line with the SSI Dipole Calibration Procedure SSI-TP-018-ALSAS. The results contained within this report are for Validation Dipole 177-00505. The calibration routine consisted of a three-step process. Step 1 was a mechanical verification of the dipole to ensure that it meets the mechanical specifications. Step 2 was an Electrical Calibration for the Validation Dipole, where the SWR, Impedance, and the Return loss were assessed. Step 3 involved a System Validation using the ALSAS-10U, along with APREL E-020 130 MHz to 26 GHz E-Field Probe Serial Number 2225.

References

- SSI-TP-018-ALSAS Dipole Calibration Procedure
- SSI-TP-016 Tissue Calibration Procedure
- IEEE 1528 "Recommended Practice for Determining the Peak Spatial-Average Specific Absorption Rate (SAR) in the Human Body Due to Wireless Communications Devices: Experimental Techniques"
- IEC-62209 "Human exposure to radio frequency fields from hand-held and body-mounted wireless communication devices – Human models, instrumentation, and procedures"
- Part 1: "Procedure to determine the Specific Absorption Rate (SAR) for hand-held devices used in close proximity of the ear (frequency range of 300 MHz to 3 GHz)"
- IEC-62209 "Human exposure to radio frequency fields from hand-held and body-mounted wireless communication devices – Human models, instrumentation, and procedures"
- Part 2: "Procedure to determine the Specific Absorption Rate (SAR) for hand-held devices used in close proximity of the ear (frequency range of 30 MHz to 6 GHz)"
- TP-D01-032-E020-V2 E-Field probe calibration procedure
- D22-012-Tissue dielectric tissue calibration procedure
- D28-002-Dipole procedure for validation of SAR system using a dipole
- IEEE 1309 Draft Standard for Calibration of Electromagnetic Field Sensors and Probes, Excluding Antennas, from 9kHz to 40GHz

Conditions

Dipole 177-00505 was a new calibration.

Ambient Temperature of the Laboratory: 22 °C +/- 0.5°C
Temperature of the Tissue: 20 °C +/- 0.5°C

4

This page has been reviewed for content and attested to by signature within this document.

NCL Calibration Laboratories

Division of APREL Laboratories.

Dipole Calibration Results

Mechanical Verification

APREL Length	APREL Height	Measured Length	Measured Height
180.0 mm	97.8 mm	180.2 mm	97.0 mm

Tissue Validation

Tissue 750MHz	Measured Head	Measured Body
Dielectric constant, ϵ_r	42.7	56.6
Conductivity, σ [S/m]	0.85	0.94

Dipole Calibration uncertainty

The calibration uncertainty for the dipole is made up of various parameters presented below.

Mechanical	1%
Positioning Error	1.22%
Electrical	1.7%
Tissue	2.2%
Dipole Validation	2.2%
TOTAL	8.32% (16.64% K=2)

NCL Calibration Laboratories

Division of APREL Laboratories.

Electrical Calibration

Test	Result Head	Result Body
S11 R/L	-27.621 dB	-21.672 dB
SWR	1.106 U	1.201 U
Impedance	52.505 Ω	55.933 Ω

The Following Graphs are the results as displayed on the Vector Network Analyzer.

S11 Parameter Return Loss

HEAD

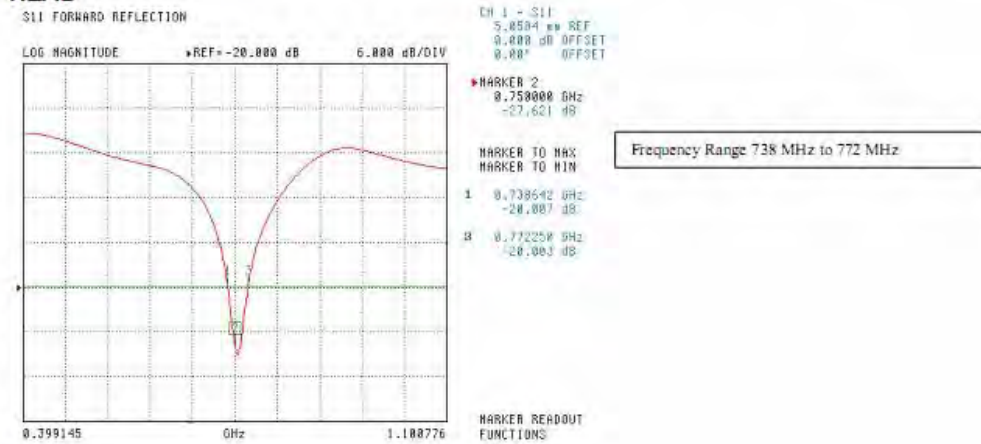

BODY

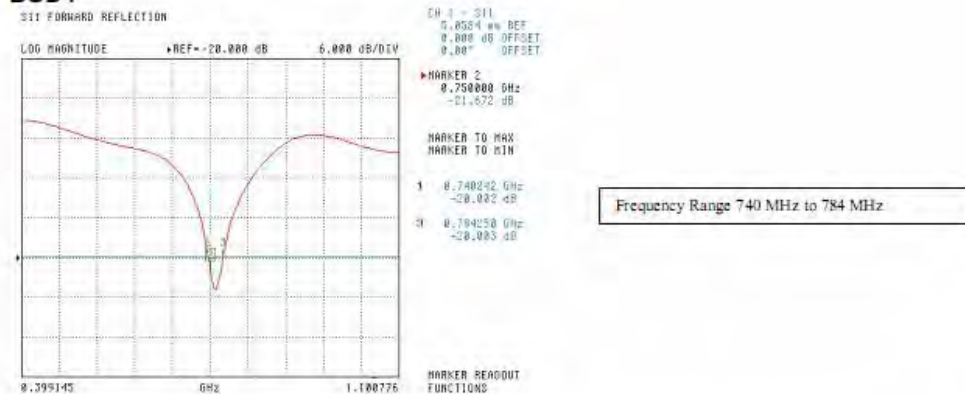

This page has been reviewed for content and attested to by signature within this document.

NCL Calibration Laboratories

Division of APREL Laboratories.

SWR

Head

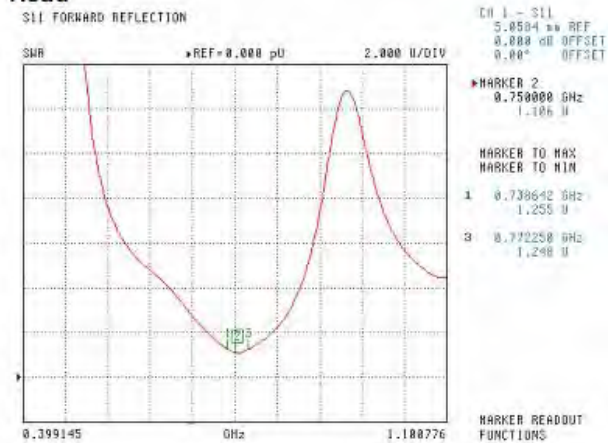

Body



This page has been reviewed for content and attested to by signature within this document.

NCL Calibration Laboratories

Division of APREL Laboratories.

Smith Chart Dipole Impedance

Head

S11 FORWARD REFLECTION
IMPEDANCE

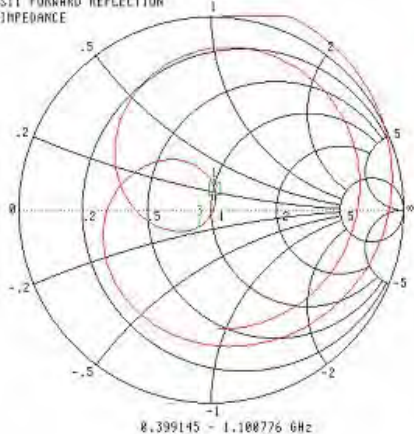

CH 1 - S11
5.0504 mW REF
0.000 dB OFFSET
0.00° OFFSET

*MARKER 2
0.750000 GHz
52.505 Ω
2.701 jΩ

MARKER TO MAX
MARKER TO MIN

1 0.738542 GHz
50.918 Ω
11.112 jΩ
0 0.772250 GHz
43.762 Ω
-8.112 jΩ

MARKER READOUT
FUNCTIONS

Body

S11 FORWARD REFLECTION
IMPEDANCE

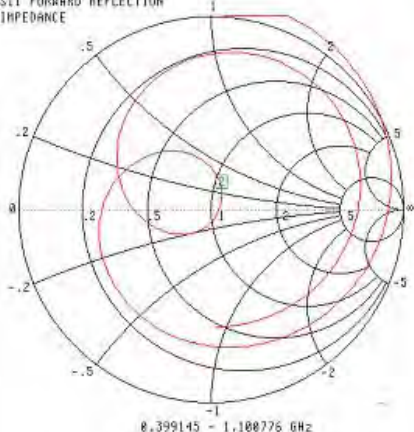

CH 1 - S11
5.0504 mW REF
0.000 dB OFFSET
0.00° OFFSET

*MARKER 2
0.750000 GHz
55.933 Ω
6.574 jΩ

MARKER TO MAX
MARKER TO MIN

MARKER READOUT
FUNCTIONS

This page has been reviewed for content and attested to by signature within this document.

NCL Calibration Laboratories

Division of APREL Laboratories.

Test Equipment

The test equipment used during Probe Calibration, manufacturer, model number and, current calibration status are listed and located on the main APREL server R:\NCL\Calibration Equipment\Instrument List May 2013.

This page has been reviewed for content and attested to by signature within this document.

9

NCL CALIBRATION LABORATORIES

Calibration File No: DC-1599
Project Number: BAC-dipole-cal-5779

CERTIFICATE OF CALIBRATION

It is certified that the equipment identified below has been calibrated in the
NCL CALIBRATION LABORATORIES by qualified personnel following recognized
procedures and using transfer standards traceable to NRC/NIST.

Validation Dipole(Head and Body)

Manufacturer: APREL Laboratories
Part number: ALS-D-835-S-2
Frequency: 835 MHz
Serial No: 180-00558

Customer: Bay Area Compliance Laboratory (China)

Calibrated: 8th October 2014
Released on: 8th October 2014

This Calibration Certificate is Incomplete Unless Accompanied with the Calibration Results Summary

Released By: _____



Art Brennan, Quality Manager

NCL CALIBRATION LABORATORIES

Suite 102, 303 Terry Fox Dr.
Kanata, ONTARIO
CANADA K2K 3J1

Division of APREL Lab
TEL: (613) 435-8300
FAX: (613) 435-8306

NCL Calibration Laboratories

Division of APREL Laboratories

Conditions

Dipole 180-00558 was received with a damaged connection for a re-calibration.

Ambient Temperature of the Laboratory: 22 °C +/- 0.5°C

Temperature of the Tissue: 21 °C +/- 0.5°C

Attestation

The below named signatories have conducted the calibration and review of the data which is presented in this calibration report.

We the undersigned attest that to the best of our knowledge the calibration of this subject has been accurately conducted and that all information contained within the results pages have been reviewed for accuracy.



 Art Brennan, Quality Manager



 Maryna Nesterova Calibration Engineer

Primary Measurement Standards

Instrument	Serial Number	Cal due date
Tektronix USB Power Meter	11C940	May 14, 2015
Network Analyzer Anritsu 37347C	002106	Feb. 20, 2015

This page has been reviewed for content and attested to by signature within this document.

NCL Calibration Laboratories

Division of APREL Laboratories.

Calibration Results Summary

The following results relate the Calibrated Dipole and should be used as a quick reference for the user.

Mechanical Dimensions

Length: 162.2 mm
Height: 89.4 mm

Electrical Specification

Tissue	Frequency	SWR:	Return Loss	Impedance
Head	835 MHz	1.066 U	-30.344 dB	49.001 Ω
Body	835 MHz	1.089 U	-28.118 dB	53.117 Ω

System Validation Results

Tissue	Frequency	1 Gram	10 Gram	Peak
Head	835 MHz	9.773	6.174	14.713
Body	835 MHz	9.736	6.297	14.513

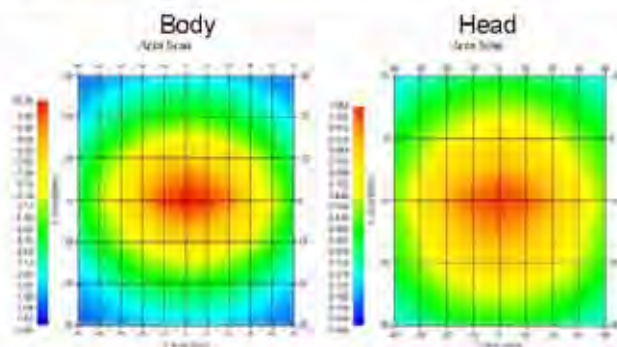

This page has been reviewed for content and attested to by signature within this document. 3

NCL Calibration Laboratories

Division of APREL Laboratories.

Introduction

This Calibration Report has been produced in line with the SSI Dipole Calibration Procedure SSI-TP-018-ALSAS. The results contained within this report are for Validation Dipole 180-00558. The calibration routine consisted of a three-step process. Step 1 was a mechanical verification of the dipole to ensure that it meets the mechanical specifications. Step 2 was an Electrical Calibration for the Validation Dipole, where the SWR, Impedance, and the Return loss were assessed. Step 3 involved a System Validation using the ALSAS-10U, along with APREL E-020 30 MHz to 6 GHz E-Field Probe Serial Number 225.

References

- IEC-62209 "Human exposure to radio frequency fields from hand-held and body-mounted wireless communication devices – Human models, instrumentation, and procedures"
- Part 2: "Procedure to determine the Specific Absorption Rate (SAR) for hand-held devices used in close proximity of the ear (frequency range of 30 MHz to 6 GHz)"
- TP-D01-032-E020-V2 E-Field probe calibration procedure
- D22-012-Tissue dielectric tissue calibration procedure
- D28-002-Dipole procedure for validation of SAR system using a dipole
- IEEE 1309 Draft Standard for Calibration of Electromagnetic Field Sensors and Probes, Excluding Antennas, from 9kHz to 40GHz

Conditions

Dipole 180-00558 was repaired prior to this calibration. The repair reliability depends upon correct usage of the dipole.

Ambient Temperature of the Laboratory: 22 °C +/- 0.5°C
Temperature of the Tissue: 20 °C +/- 0.5°C

Dipole Calibration uncertainty

The calibration uncertainty for the dipole is made up of various parameters presented below.

Mechanical	1%
Positioning Error	1.22%
Electrical	1.7%
Tissue	2.2%
Dipole Validation	2.2%
TOTAL	8.32% (16.64% K=2)

This page has been reviewed for content and attested to by signature within this document.

NCL Calibration Laboratories

Division of APREL Laboratories.

Dipole Calibration Results

Mechanical Verification

APREL Length	APREL Height	Measured Length	Measured Height
161.0 mm	89.8 mm	162.2 mm	89.4 mm

Electrical Verification

Tissue Type	Return Loss:	SWR:	Impedance:
Head	-30.344 dB	1.066 U	49.001 Ω
Body	-28.118 dB	1.089 U	53.117 Ω □

Tissue Validation

	Dielectric constant, ϵ_r	Conductivity, σ [S/m]
Head Tissue 835MHz	43.42	0.94
Body Tissue 835MHz	55.77	1.01

This page has been reviewed for content and attested to by signature within this document.

NCL Calibration Laboratories

Division of APREL Laboratories.

The Following Graphs are the results as displayed on the Vector Network Analyzer.

S11 Parameter Return Loss

Head Tissue: Frequency Range 0.817 to 0.848 GHz

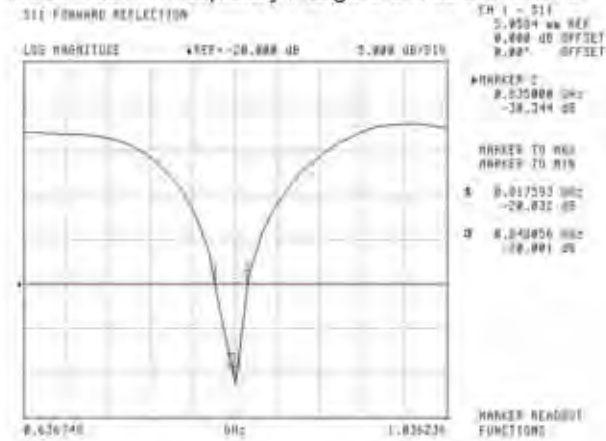

Body Tissue: Frequency Range 0.823 to 0.851 GHz

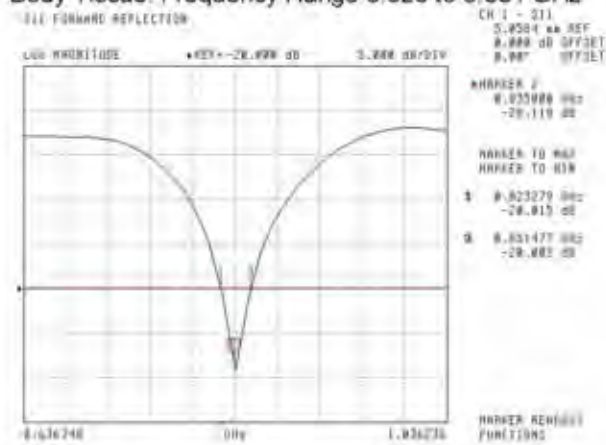

This page has been reviewed for content and attested to by signature within this document.

NCL Calibration Laboratories

Division of APREL Laboratories.

SWR
Head

311 FORWARD REFLECTION

SWR *REF=0.000 pd 2.000 U/DIV

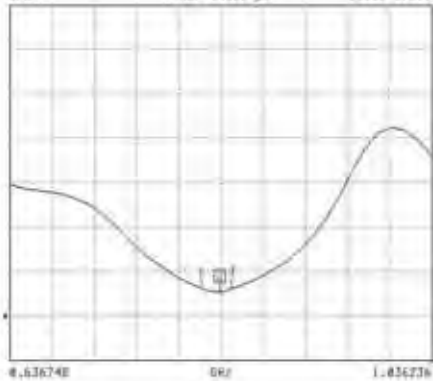

CH 1 - 311
5.0004 mV REF
0.000 dB OFFSET
0.00° OFFSET

*MARKER 2
0.835000 GHz
1.966 U

MARKER TO MAX
MARKER TO MIN

1 0.817593 GHz
1.251 U
2 0.840856 GHz
1.225 U

MARKER READOUT
FUNCTIONS

Body

311 FORWARD REFLECTION

SWR *REF=0.000 pd 2.000 U/DIV

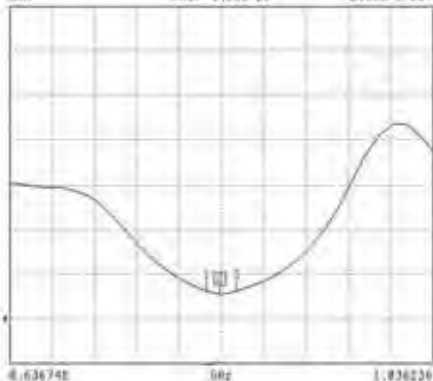

CH 1 - 311
5.0004 mV REF
0.000 dB OFFSET
0.00° OFFSET

*MARKER 2
0.835000 GHz
1.905 U

MARKER TO MAX
MARKER TO MIN

1 0.823229 GHz
1.226 U
2 0.851479 GHz
1.234 U

MARKER READOUT
FUNCTIONS

This page has been reviewed for content and attested to by signature within this document.

7

NCL Calibration Laboratories

Division of APREL Laboratories

Smith Chart Dipole Impedance

Head

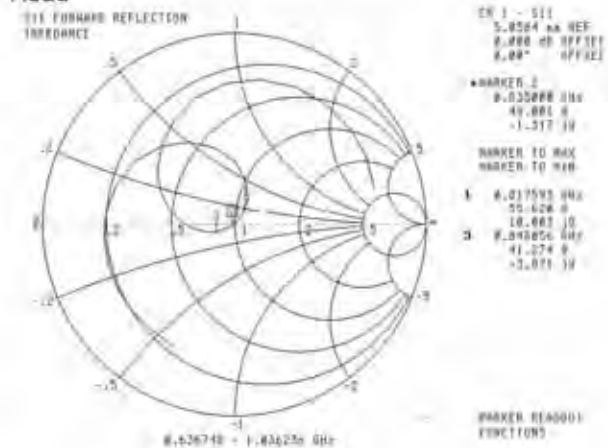

Body

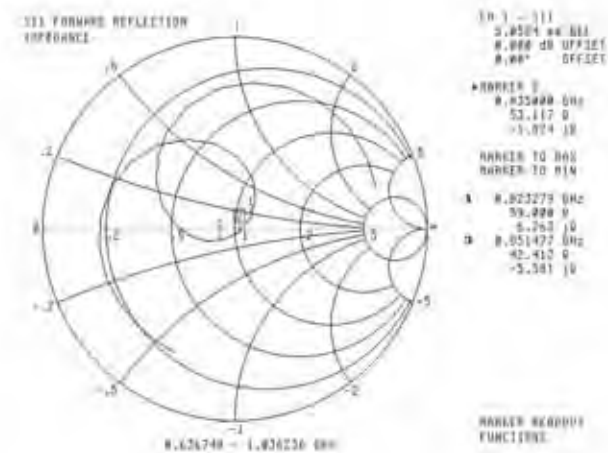

This page has been reviewed for content and attested to by signature within this document.

NCL Calibration Laboratories

Division of APREL Laboratories.

Test Equipment

The test equipment used during Probe Calibration, manufacturer, model number and, current calibration status are listed and located on the main APREL server R:\NCL\Calibration Equipment\Instrument List 2014.

This page has been reviewed for content and attested to by signature within this document.

9

NCL CALIBRATION LABORATORIES

Calibration File No: DC-1531
Project Number: BAGL-5745

CERTIFICATE OF CALIBRATION

It is certified that the equipment identified below has been calibrated in the
NCL CALIBRATION LABORATORIES by qualified personnel following recognized
procedures and using transfer standards traceable to NRC/NIST.

BAGL Head & Body Validation Dipole

Manufacturer: APREL Laboratories
Part number: ALS-D-1750-S-2
Frequency: 1750 MHz
Serial No: 196-00304

Customer: ISL

Calibrated: 8th October, 2013
Released on: 8th October, 2013

This Calibration Certificate is Incomplete Unless Accompanied with the Calibration Results Summary

Released By: _____

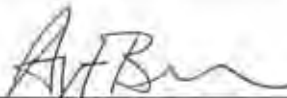

Art Brennan, Quality Manager

NCL CALIBRATION LABORATORIES

Suite 102, 803 Terry Fox Dr
OTTAWA, ONTARIO
CANADA K2K 3J1

Division of APREL Lab.
TEL: (613) 435-8300
FAX: (613) 435-8306

NCL Calibration Laboratories

Division of APREL Laboratories

Conditions

Dipole 198-00304 was an original calibration.

Ambient Temperature of the Laboratory: 22 °C +/- 0.5°C

Temperature of the Tissue: 21 °C +/- 0.5°C

We the undersigned attest that to the best of our knowledge the calibration of this subject has been accurately conducted and that all information contained within the results pages have been reviewed for accuracy.

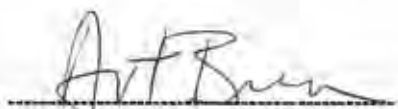

Art Brennan, Quality Manager



Constantin Teodorian, Test Engineer

This page has been reviewed for content and attested to by signature within this document.

2

NCL Calibration Laboratories

Division of APREL Laboratories

Calibration Results Summary

The following results relate the Calibrated Dipole and should be used as a quick reference for the user.

Mechanical Dimensions

Length: 75 mm
 Height: 42 mm

Electrical Calibration

Test	Result Head	Result Body
S11 R/L	-25.567	-20.548 dB
SWR	1.111U	1.207 U
Impedance	53.637Ω	55.929 Ω

System Validation Results, 1750 MHz

	1g	10g
Head	37.02	18.99
Body	36.65	18.85

Type	Epsilon	Sigma
Head	38.51	1.36
Body	51.79	1.53

Head

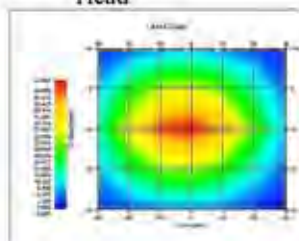

Body

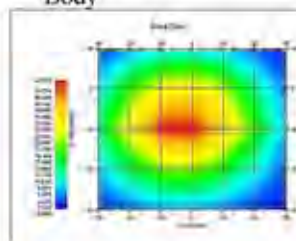

This page has been reviewed for content and attested to by signature within this document.

NCL Calibration Laboratories

Division of APREL Laboratories.

Introduction

This Calibration Report has been produced in line with the SSI Dipole Calibration Procedure SSI-TP-018-ALSAS. The results contained within this report are for Validation Dipole. The calibration routine consisted of a three-step process. Step 1 was a mechanical verification of the dipole to ensure that it meets the mechanical specifications. Step 2 was an Electrical Calibration for the Validation Dipole, where the SWR, Impedance, and the Return loss were assessed. Step 3 involved a System Validation using the ALSAS-10U, along with APREL E-030 130 MHz to 26 GHz E-Field Probe Serial Number 215.

References

- SSI-TP-018-ALSAS Dipole Calibration Procedure
- SSI-TP-016 Tissue Calibration Procedure
- IEEE 1528 "Recommended Practice for Determining the Peak Spatial-Average Specific Absorption Rate (SAR) in the Human Body Due to Wireless Communications Devices: Experimental Techniques"
- IEC-62209 "Human exposure to radio frequency fields from hand-held and body-mounted wireless communication devices – Human models, instrumentation, and procedures"
- Part 1: "Procedure to determine the Specific Absorption Rate (SAR) for hand-held devices used in close proximity of the ear (frequency range of 300 MHz to 3 GHz)"
- IEC-62209 "Human exposure to radio frequency fields from hand-held and body-mounted wireless communication devices – Human models, instrumentation, and procedures"
- Part 2 *Draft*: "Procedure to determine the Specific Absorption Rate (SAR) for hand-held devices used in close proximity of the ear (frequency range of 30 MHz to 6 GHz)"

Conditions

Ambient Temperature of the Laboratory: 22 °C +/- 0.5°C
Temperature of the Tissue: 20 °C +/- 0.5°C

This was an original calibration taken from stock.

Dipole Calibration uncertainty

The calibration uncertainty for the dipole is made up of various parameters presented below.

Mechanical	1%
Positioning Error	1.22%
Electrical	1.7%
Tissue	2.2%
Dipole Validation	2.2%
TOTAL	8.32% (16.64% K=2)

This page has been reviewed for content and attested to by signature within this document.

NCL Calibration Laboratories

Division of APREL Laboratories.

Dipole Calibration Results

Mechanical Verification

Measured Length	Measured Height
75 mm	42 mm

Tissue Validation

Frequency	Permittivity ϵ	Conductivity σ
1750 Head	38.23	1.38
1750 Body	52.86	1.54

This page has been reviewed for content and attested to by signature within this document.

5

NCL Calibration Laboratories

Division of APREL Laboratories.

SWR
Head

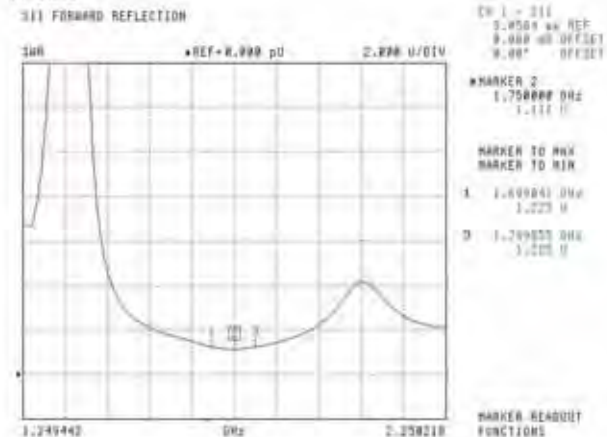

Body

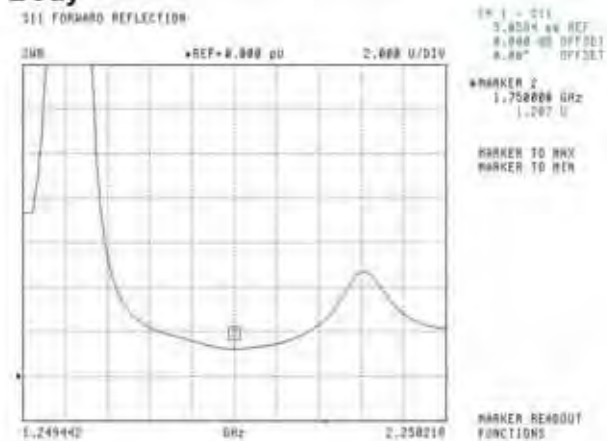

This page has been reviewed for content and attested to by signature within this document.

7

NCL Calibration Laboratories

Division of APREL Laboratories.

Smith Chart Dipole Impedance

Head

311 FORWARD REFLECTION
IMPEDANCE

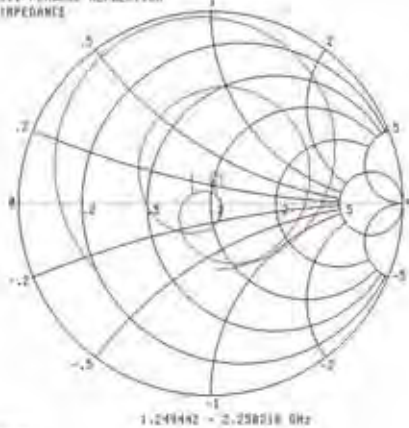

SWR 1.00000
S.W. LOSS db 0.000
R.O. LOSS db 0.000
ANGLE OF REFLECTION

*MARKER 2
1.250000 GHz
83.637 Ω
5.150 jΩ

MARKER TO HWZ
MARKER TO HWZ

- 1 1.249999 GHz
83.579 Ω
5.099 jΩ
- 2 1.250000 GHz
83.637 Ω
5.150 jΩ

MARKER READOUT
FUNCTIONS

Body

311 FORWARD REFLECTION
IMPEDANCE

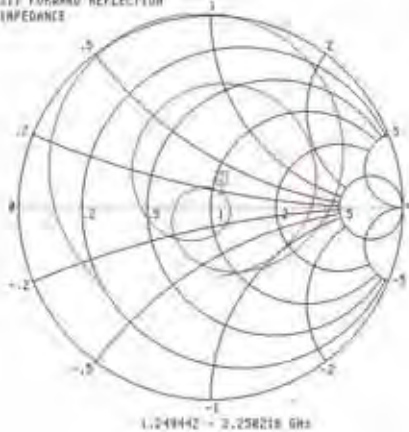

SWR 1.00000
S.W. LOSS db 0.000
R.O. LOSS db 0.000
ANGLE OF REFLECTION

*MARKER 2
1.250000 GHz
83.637 Ω
5.150 jΩ

MARKER TO HWZ
MARKER TO HWZ

MARKER READOUT
FUNCTIONS

This page has been reviewed for content and attested to by signature within this document.

NCL Calibration Laboratories

Division of APREL Laboratories.

Test Equipment

The test equipment used during Probe Calibration, manufacturer, model number and, current calibration status are listed and located on the main APREL server R:\NCL\Calibration Equipment\Instrument List May 2013

This page has been reviewed for content and attested to by signature within this document.

9

NCL CALIBRATION LABORATORIES

Calibration File No: DC-1601
Project Number: BAC-dipole -cal-5779

CERTIFICATE OF CALIBRATION

It is certified that the equipment identified below has been calibrated in the
NCL CALIBRATION LABORATORIES by qualified personnel following recognized
procedures and using transfer standards traceable to NRC/NIST.

Validation Dipole (Head & Body)

Manufacturer: APREL Laboratories

Part number: ALS-D-1900-S-2

Frequency: 1900 MHz

Serial No: 210-00710

Customer: Bay Area Compliance Laboratory (China)

Calibrated: 9th October, 2014
Released on: 9th October, 2014

This Calibration Certificate is Incomplete Unless Accompanied with the Calibration Results Summary

Released By:



Art Brennan, Quality Manager

NCL CALIBRATION LABORATORIES

Suite 102, 303 Terry Fox Dr
Kanata, ONTARIO
CANADA K2K 3J1

Division of APREL Lab
TEL: (613) 436-8300
FAX: (613)436-8308

NCL Calibration Laboratories

Division of APREL Laboratories

Conditions

Dipole 210-00710 was received in good condition and was a re-calibration.

Ambient Temperature of the Laboratory: 22 °C +/- 0.5°C

Temperature of the Tissue: 21 °C +/- 0.5°C

Attestation

The below named signatories have conducted the calibration and review of the data which is presented in this calibration report.

We the undersigned attest that to the best of our knowledge the calibration of this subject has been accurately conducted and that all information contained within the results pages have been reviewed for accuracy.



 Art Brennan, Quality Manager



 Maryna Nesterova Calibration Engineer

Primary Measurement Standards

Instrument	Serial Number	Cal due date
Tektronix USB Power Meter	11C940	May 14, 2015
Network Analyzer Anritsu 37347C	002106	Feb. 20, 2015

This page has been reviewed for content and attested to by signature within this document.

NCL Calibration Laboratories

Division of APREL Laboratories.

Calibration Results Summary

The following results relate the Calibrated Dipole and should be used as a quick reference for the user.

Mechanical Dimensions

Length: 67.1 mm
Height: 38.9 mm

Electrical Specification

Tissue	Frequency	SWR:	Return Loss	Impedance
Head	1900MHz	1.084 U	-27.92 dB	52.247 Ω
Body	1900MHz	1.128 U	-24.40 dB	52.618 Ω

System Validation Results

Tissue	Frequency	1 Gram	10 Gram	Peak
Head	1900 MHz	39.481	20.44	73.364
Body	1900 MHz	39.715	20.552	73.565

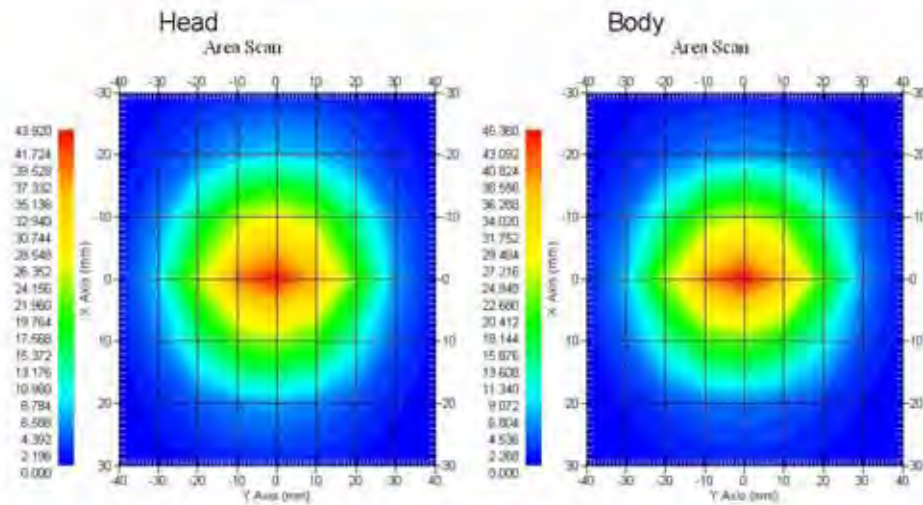

This page has been reviewed for content and attested to by signature within this document.

NCL Calibration Laboratories

Division of APREL Laboratories.

Introduction

This Calibration Report has been produced in line with the SSI Dipole Calibration Procedure SSI-TP-018-ALSAS. The results contained within this report are for Validation Dipole 210-00710. The calibration routine consisted of a three-step process. Step 1 was a mechanical verification of the dipole to ensure that it meets the mechanical specifications. Step 2 was an Electrical Calibration for the Validation Dipole, where the SWR, Impedance, and the Return loss were assessed. Step 3 involved a System Validation using the ALSAS-10U, along with APREL E-020 30 MHz to 6 GHz E-Field Probe Serial Number 225.

References

- IEC-62209 "Human exposure to radio frequency fields from hand-held and body-mounted wireless communication devices – Human models, instrumentation, and procedures"
- Part 2: "Procedure to determine the Specific Absorption Rate (SAR) for hand-held devices used in close proximity of the ear (frequency range of 30 MHz to 6 GHz)"
- TP-D01-032-E020-V2 E-Field probe calibration procedure
- D22-012-Tissue dielectric tissue calibration procedure
- D28-002-Dipole procedure for validation of SAR system using a dipole
- IEEE 1309 Draft Standard for Calibration of Electromagnetic Field Sensors and Probes, Excluding Antennas, from 9kHz to 40GHz

Conditions

Dipole 210-00710 was a recalibration.

Ambient Temperature of the Laboratory: 22 °C +/- 0.5°C
Temperature of the Tissue: 20 °C +/- 0.5°C

Dipole Calibration uncertainty

The calibration uncertainty for the dipole is made up of various parameters presented below.

Mechanical	1%
Positioning Error	1.22%
Electrical	1.7%
Tissue	2.2%
Dipole Validation	2.2%
TOTAL	8.32% (16.64% K=2)

This page has been reviewed for content and attested to by signature within this document.

NCL Calibration Laboratories

Division of APREL Laboratories.

Dipole Calibration Results

Mechanical Verification

APREL Length	APREL Height	Measured Length	Measured Height
68.0 mm	39.5 mm	67.1mm	38.9 mm

Electrical Validation

Tissue	Frequency	SWR:	Return Loss	Impedance
Head	1900MHz	1.084 U	-27.92 dB	52.247 Ω
Body	1900MHz	1.128 U	-24.40 dB	52.618 Ω

Tissue Validation

	Dielectric constant, ϵ_r	Conductivity, σ [S/m]
Head Tissue 1900MHz	40.20	1.38
Body Tissue 1900MHz	52.63	1.46

This page has been reviewed for content and attested to by signature within this document.

NCL Calibration Laboratories

Division of APREL Laboratories.

The Following Graphs are the results as displayed on the Vector Network Analyzer.

S11 Parameter Return Loss

Head: Frequency Range 1.865 to 1.937 GHz

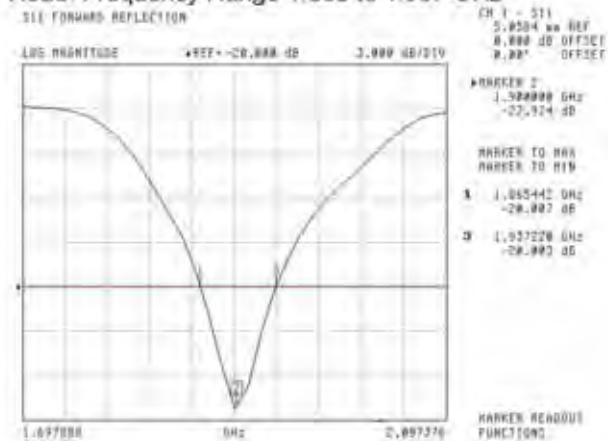

Body: Frequency Range 1.869 to 1.931 MHz

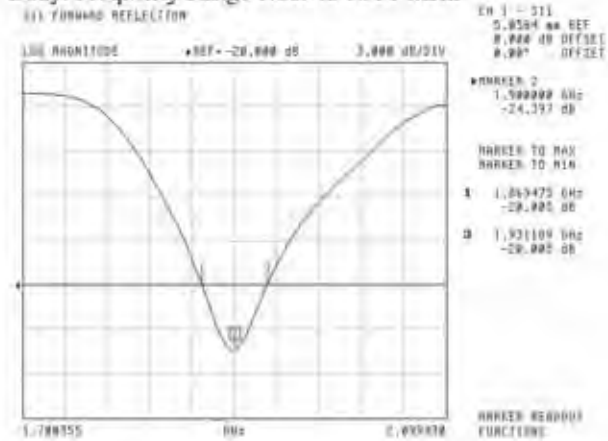

This page has been reviewed for content and attested to by signature within this document.

NCL Calibration Laboratories

Division of APREL Laboratories.

SWR

Head

311 FORWARD REFLECTION

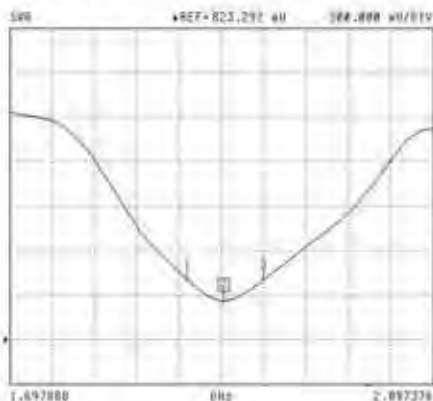

CH 1 - 311
5.8504 uV REF
0.000 dB OFFSET
0.00° OFFSET

*MARKER 2
1.908000 GHz
1.894 V

MARKER TO MAX
MARKER TO MIN

- 1 1.865442 GHz
1.226 V
- 2 1.937228 GHz
1.224 V

MARKER READOUT
FUNCTIONS

Body

311 FORWARD REFLECTION

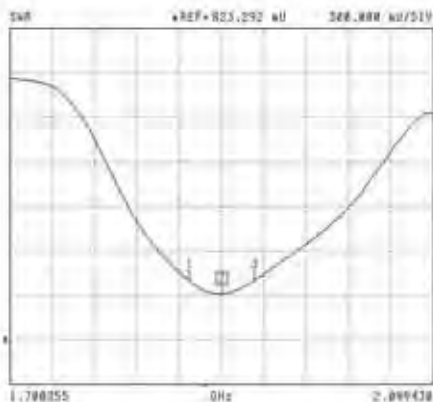

CH 1 - 311
5.8504 uV REF
0.000 dB OFFSET
0.00° OFFSET

*MARKER 2
1.908000 GHz
1.128 V

MARKER TO MAX
MARKER TO MIN

- 1 1.862470 GHz
1.223 V
- 2 1.931189 GHz
1.223 V

MARKER READOUT
FUNCTIONS

This page has been reviewed for content and attested to by signature within this document.

7

NCL Calibration Laboratories

Division of APREL Laboratories

Smith Chart Dipole Impedance

Head

111 FORWARD REFLECTION
IMPEDANCE

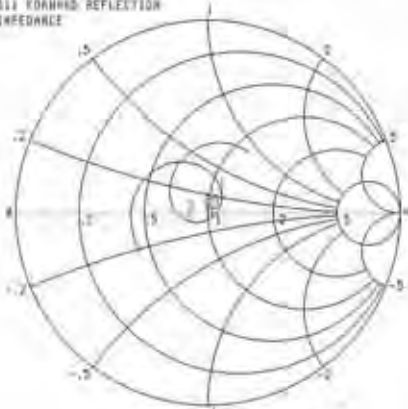

1.69789 - j2.892376 Ohms

CH 1 - 111
5.4534 kW REF
0.000 dB OFFSET
0.00° OFFSET

*MARKER 1
1.948800 GHz
57.243 Ω
-5.183 jΩ

MARKER TO MARK
MARKER TO MIN

1 1.855442 GHz
57.627 Ω
7.644 jΩ
2 1.937220 GHz
41.880 Ω
-4.273 jΩ

MARKER READOUT
FUNCTIONS

Body

111 FORWARD REFLECTION
IMPEDANCE

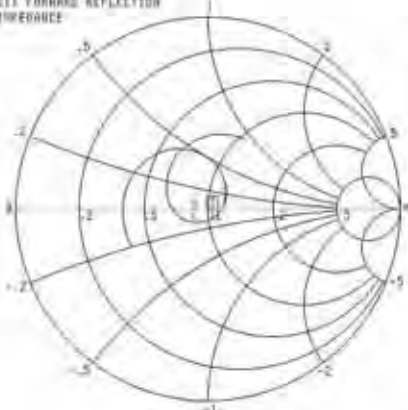

1.788305 - j2.894438 Ohms

CH 1 - 111
5.4534 kW REF
0.000 dB OFFSET
0.00° OFFSET

*MARKER 1
1.948800 GHz
52.618 Ω
-5.335 jΩ

MARKER TO MARK
MARKER TO MIN

1 1.855475 GHz
58.277 Ω
4.849 jΩ
2 1.921189 GHz
43.257 Ω
-5.479 jΩ

MARKER READOUT
FUNCTIONS

This page has been reviewed for content and attested to by signature within this document.

NCL Calibration Laboratories

Division of APREL Laboratories.

Test Equipment

The test equipment used during Probe Calibration, manufacturer, model number and, current calibration status are listed and located on the main APREL server R:\NCL\Calibration Equipment\Instrument List 2014

This page has been reviewed for content and attested to by signature within this document.

9

NCL CALIBRATION LABORATORIES

Calibration File No: DC-1602
Project Number: BAC-dipole-cal-5779

CERTIFICATE OF CALIBRATION

It is certified that the equipment identified below has been calibrated in the
NCL CALIBRATION LABORATORIES by qualified personnel following recognized
procedures and using transfer standards traceable to NRC/NIST.

Validation Dipole (Head & Body)

Manufacturer: APREL Laboratories

Part number: ALS-D-2450-S-2

Frequency: 2450 MHz

Serial No: 220-00758

Customer: Bay Area Compliance Laboratory

Calibrated: 9th October, 2014
Released on: 9th October, 2014

This Calibration Certificate is Incomplete Unless Accompanied with the Calibration Results Summary

Released By: _____



Art Brennan, Quality Manager

NCL CALIBRATION LABORATORIES

Suite 102, 303 Terry Fox Dr
Kanata, ONTARIO
CANADA K2K 3J1

Division of APREL Lab
TEL: (613) 436-8300
FAX: (613)436-8308

NCL Calibration Laboratories

Division of APREL Laboratories

Conditions

Dipole 220-00758 was received in good condition and was a re-calibration.

Ambient Temperature of the Laboratory: 22 °C +/- 0.5°C

Temperature of the Tissue: 21 °C +/- 0.5°C

Attestation

The below named signatories have conducted the calibration and review of the data which is presented in this calibration report.

We the undersigned attest that to the best of our knowledge the calibration of this subject has been accurately conducted and that all information contained within the results pages have been reviewed for accuracy.



Art Brennan, Quality Manager



Maryna Nesterova Calibration Engineer

Primary Measurement Standards

Instrument	Serial Number	Cal due date
Tektronix USB Power Meter	11C940	May 14, 2015
Network Analyzer Anritsu 37347C	002106	Feb, 20, 2015

This page has been reviewed for content and attested to by signature within this document.

NCL Calibration Laboratories

Division of APREL Laboratories.

Calibration Results Summary

The following results relate the Calibrated Dipole and should be used as a quick reference for the user.

Mechanical Dimensions

Length: 52.4 mm
Height: 30.3 mm

Electrical Specification

Tissue	Frequency	SWR:	Return Loss	Impedance
Head	2450 MHz	1.014 U	-45.184 dB	50.006Ω
Body	2450 MHz	1.070 U	-29.453 dB	50.672 Ω

System Validation Results

Tissue	Frequency	1 Gram	10 Gram	Peak
Head	2450 MHz	54.916	25.327	111.97
Body	2450 MHz	52.418	24.691	103.91

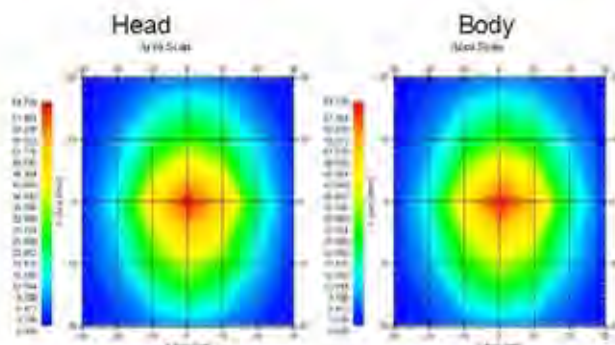

This page has been reviewed for content and attested to by signature within this document.

3

NCL Calibration Laboratories

Division of APREL Laboratories.

Introduction

This Calibration Report has been produced in line with the SSI Dipole Calibration Procedure SSI-TP-018-ALSAS. The results contained within this report are for Validation Dipole 220-00758. The calibration routine consisted of a three-step process. Step 1 was a mechanical verification of the dipole to ensure that it meets the mechanical specifications. Step 2 was an Electrical Calibration for the Validation Dipole, where the SWR, Impedance, and the Return loss were assessed. Step 3 involved a System Validation using the ALSAS-10U, along with APREL E-020 30 MHz to 6 GHz E-Field Probe Serial Number 225.

References

- SSI-TP-018-ALSAS Dipole Calibration Procedure
- SSI-TP-016 Tissue Calibration Procedure
- IEEE 1528 "Recommended Practice for Determining the Peak Spatial-Average Specific Absorption Rate (SAR) in the Human Body Due to Wireless Communications Devices: Experimental Techniques"
- IEC-62209 "Human exposure to radio frequency fields from hand-held and body-mounted wireless communication devices – Human models, instrumentation, and procedures"
- Part 1: "Procedure to determine the Specific Absorption Rate (SAR) for hand-held devices used in close proximity of the ear (frequency range of 300 MHz to 3 GHz)"
- IEC-62209 "Human exposure to radio frequency fields from hand-held and body-mounted wireless communication devices – Human models, instrumentation, and procedures"
- Part 2 *Draft*: "Procedure to determine the Specific Absorption Rate (SAR) for hand-held devices used in close proximity of the ear (frequency range of 30 MHz to 6 GHz)"

Conditions

Dipole 220-00758 was a re-calibration.

Ambient Temperature of the Laboratory: 22 °C +/- 0.5°C
Temperature of the Tissue: 20 °C +/- 0.5°C

Dipole Calibration uncertainty

The calibration uncertainty for the dipole is made up of various parameters presented below.

Mechanical	1%
Positioning Error	1.22%
Electrical	1.7%
Tissue	2.2%
Dipole Validation	2.2%
TOTAL	8.32% (16.64% K=2)

This page has been reviewed for content and attested to by signature within this document.

NCL Calibration Laboratories

Division of APREL Laboratories.

Dipole Calibration Results

Mechanical Verification

APREL Length	APREL Height	Measured Length	Measured Height
51.5 mm	30.4 mm	52.4 mm	30.3 mm

Electrical Specification

Tissue	Frequency	SWR:	Return Loss	Impedance
Head	2450 MHz	1.014 U	-45.184 dB	50.006Ω
Body	2450 MHz	1.070 U	-29.453 dB	50.672 Ω

Tissue Validation

	Dielectric constant, ϵ_r	Conductivity, σ [S/m]
Head Tissue 2450MHz	37.26	1.84
Body Tissue 2450MHz	53.61	1.90

This page has been reviewed for content and attested to by signature within this document.

NCL Calibration Laboratories

Division of APREL Laboratories.

The Following Graphs are the results as displayed on the Vector Network Analyzer.

S11 Parameter Return Loss

Head; Frequency Range 2.390 to 2.517 GHz

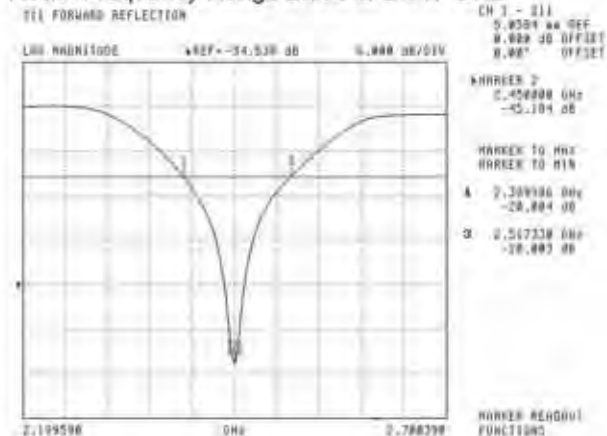

Body; Frequency Range 2.400 to 2.516 GHz

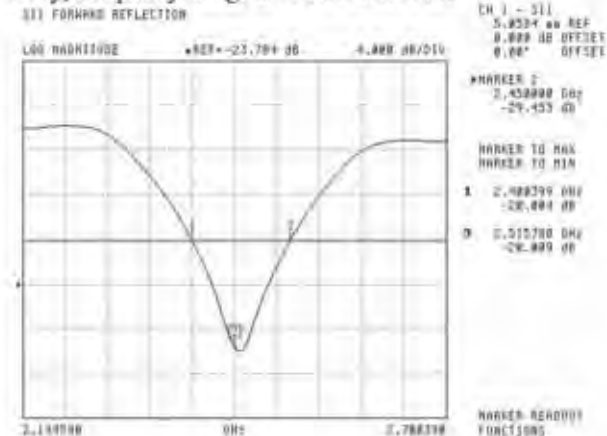

This page has been reviewed for content and attested to by signature within this document.

NCL Calibration Laboratories

Division of APREL Laboratories.

SWR

Head

SEE FORWARD REFLECTION

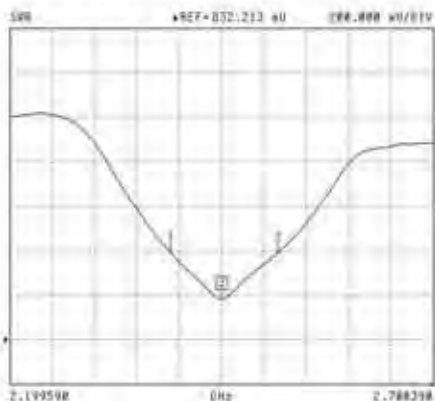

CH 1 - S11
5.0504 uV REF
0.000 dB OFFSET
0.00" OFFSET

MARKER 2
2.458000 GHz
1.814 V

MARKER TO MAX
MARKER TO MIN

1 2.359906 GHz
1.223 V
2 2.517334 GHz
1.223 V

MARKER READOUT
FUNCTIONS

Body

SEE FORWARD REFLECTION

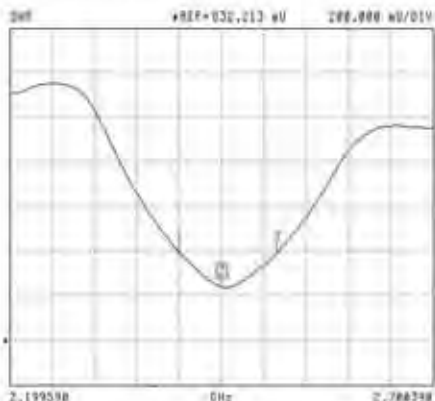

CH 1 - S11
5.0504 uV REF
0.000 dB OFFSET
0.00" OFFSET

MARKER 2
2.458000 GHz
1.878 V

MARKER TO MAX
MARKER TO MIN

1 2.488309 GHz
1.223 V
2 2.515700 GHz
1.223 V

MARKER READOUT
FUNCTIONS

This page has been reviewed for content and attested to by signature within this document.

7

NCL Calibration Laboratories

Division of APREL Laboratories

Smith Chart Dipole Impedance

Head

311 FORWARD REFLECTION
IMPEDANCE

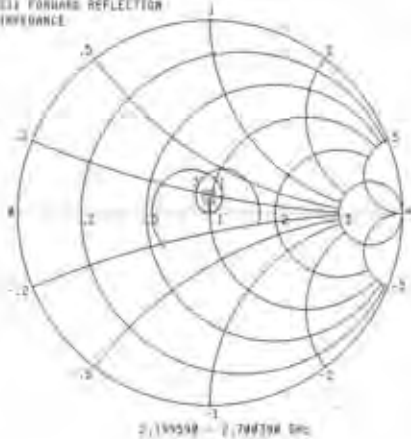

CH 1 - 311
5.8504 mV REF
8.000 dB OFFSET
8.00° OFFSET

*MARKER 1
2.450000 GHz
58.005 Ω
-108.117 jΩ

MARKER TO MARK
MARKER TO MIN

1 2.355926 GHz
58.005 Ω
0.258 jΩ
2 2.517339 GHz
42.250 Ω
0.439 jΩ

MARKER READOUT
FUNCTIONS

Body

311 FORWARD REFLECTION
IMPEDANCE

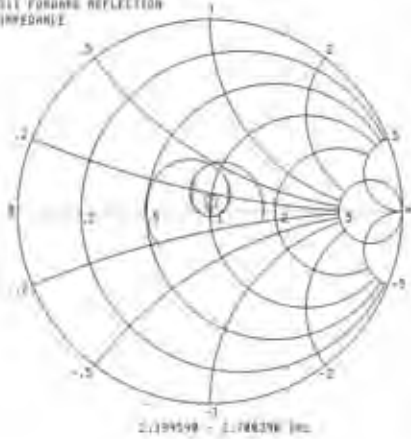

CH 1 - 311
5.8504 mV REF
8.000 dB OFFSET
8.00° OFFSET

*MARKER 1
2.450000 GHz
58.072 Ω
-0.254 jΩ

MARKER TO MARK
MARKER TO MIN

1 2.498399 GHz
68.438 Ω
2.590 jΩ
2 2.515708 GHz
41.832 Ω
3.000 jΩ

MARKER READOUT
FUNCTIONS

This page has been reviewed for content and attested to by signature within this document.

NCL Calibration Laboratories

Division of APREL Laboratories.

Test Equipment

The test equipment used during Probe Calibration, manufacturer, model number and, current calibration status are listed and located on the main APREL server R:\NCL\Calibration Equipment\Instrument List May 2014.

This page has been reviewed for content and attested to by signature within this document.

9

APPENDIX D EUT TEST POSITION PHOTOS

Liquid depth $\geq 15\text{cm}$



Body-worn Back Setup Photo (10mm)



Body-worn Left Setup Photo (10mm)

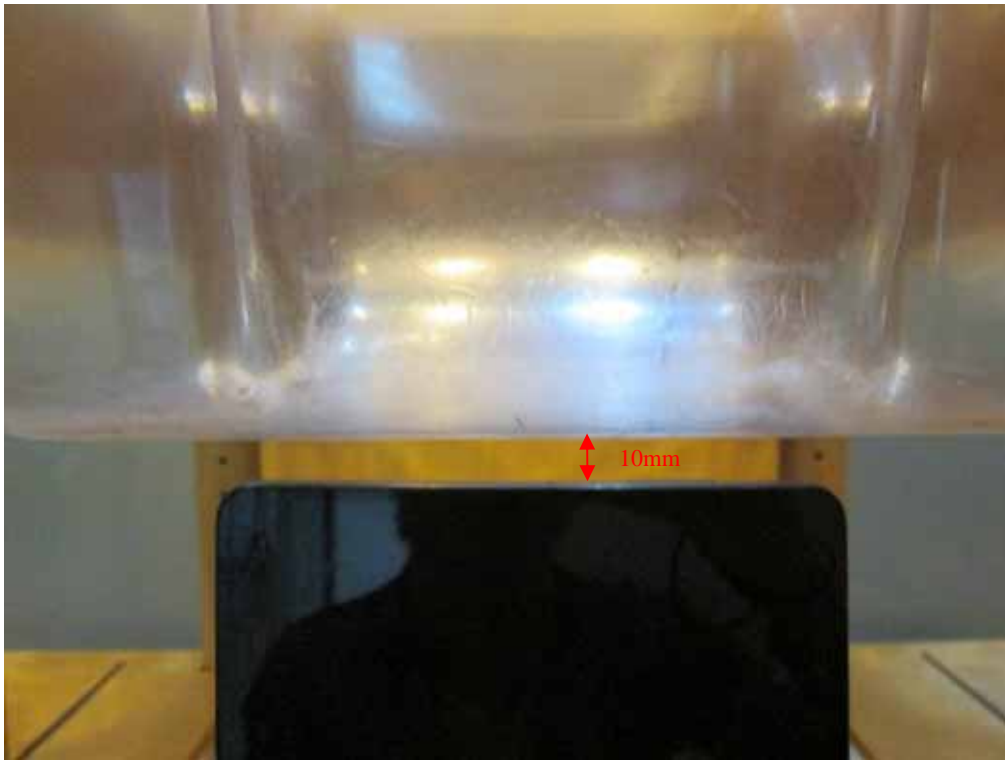

Body-worn Right Setup Photo (10mm)



Body-worn Bottom Setup Photo (10mm)



Left Head Touch Setup Photo

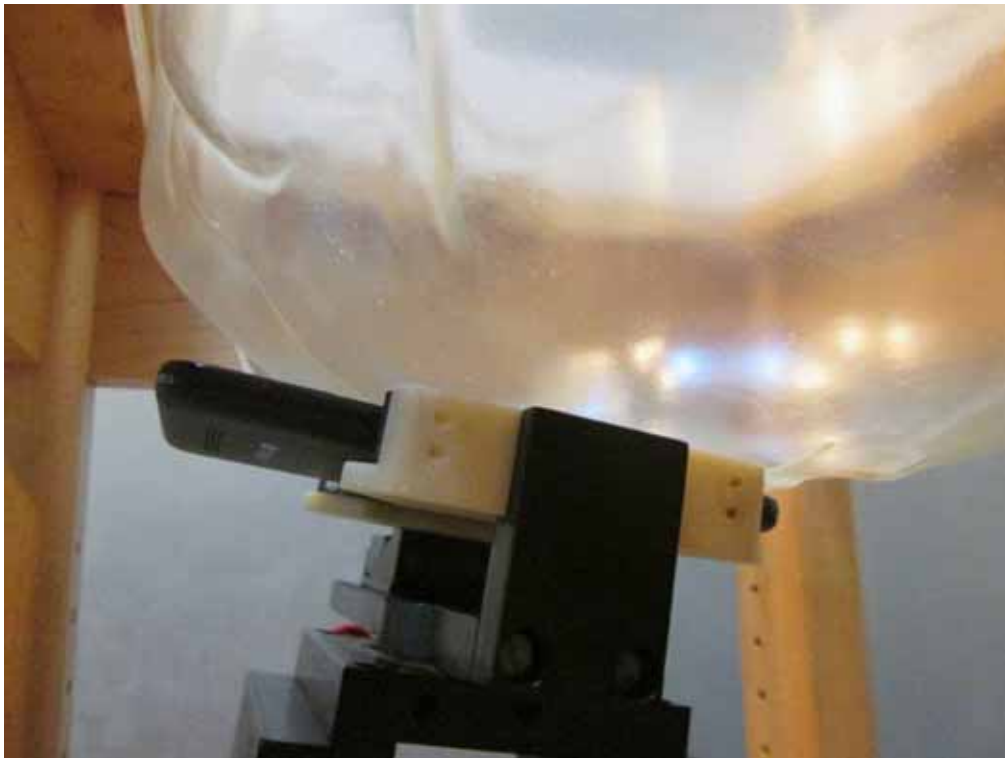

Left Head Tilt Setup Photo

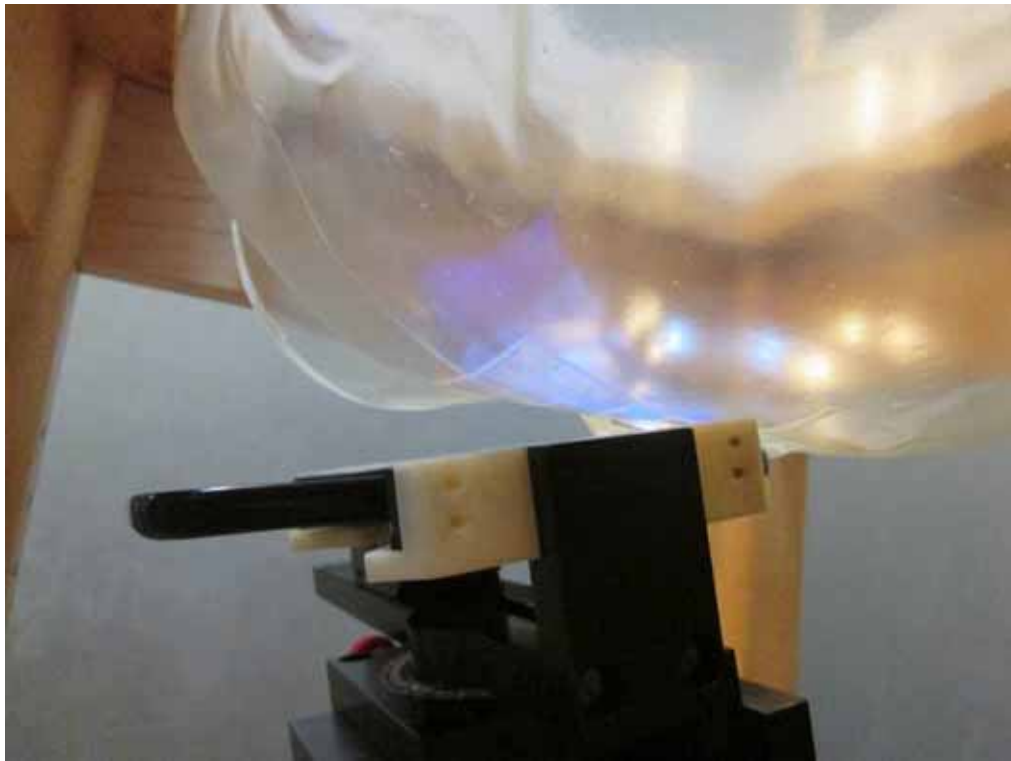

Right Head Touch Setup Photo

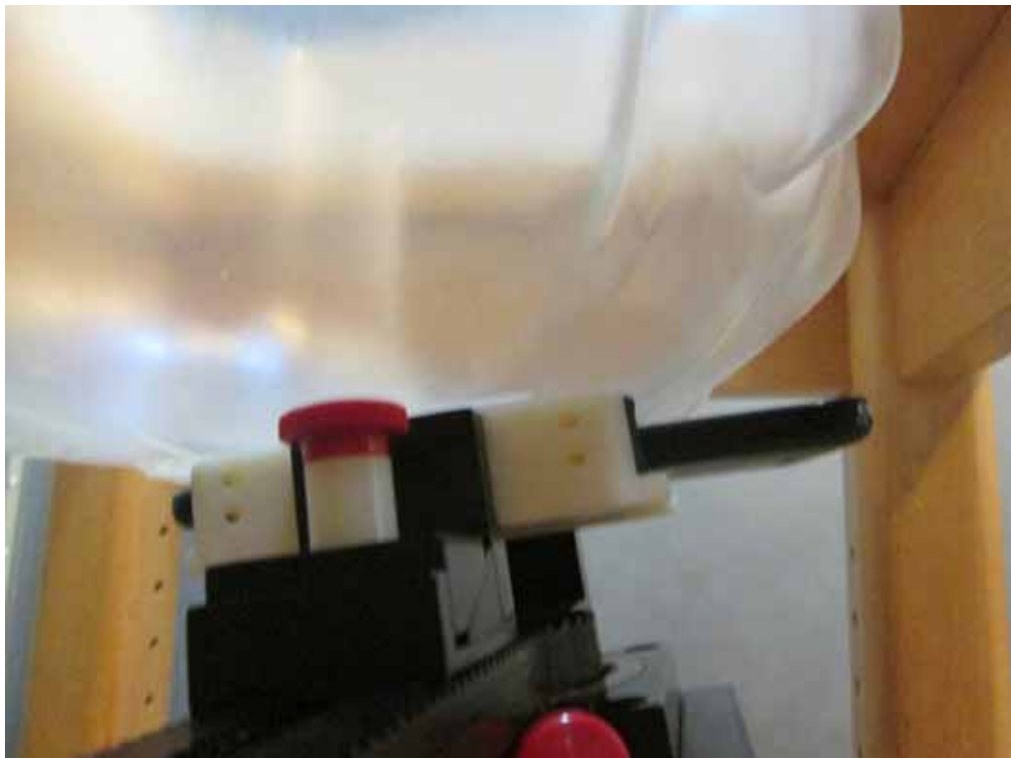

Right Head Tilt Setup Photo

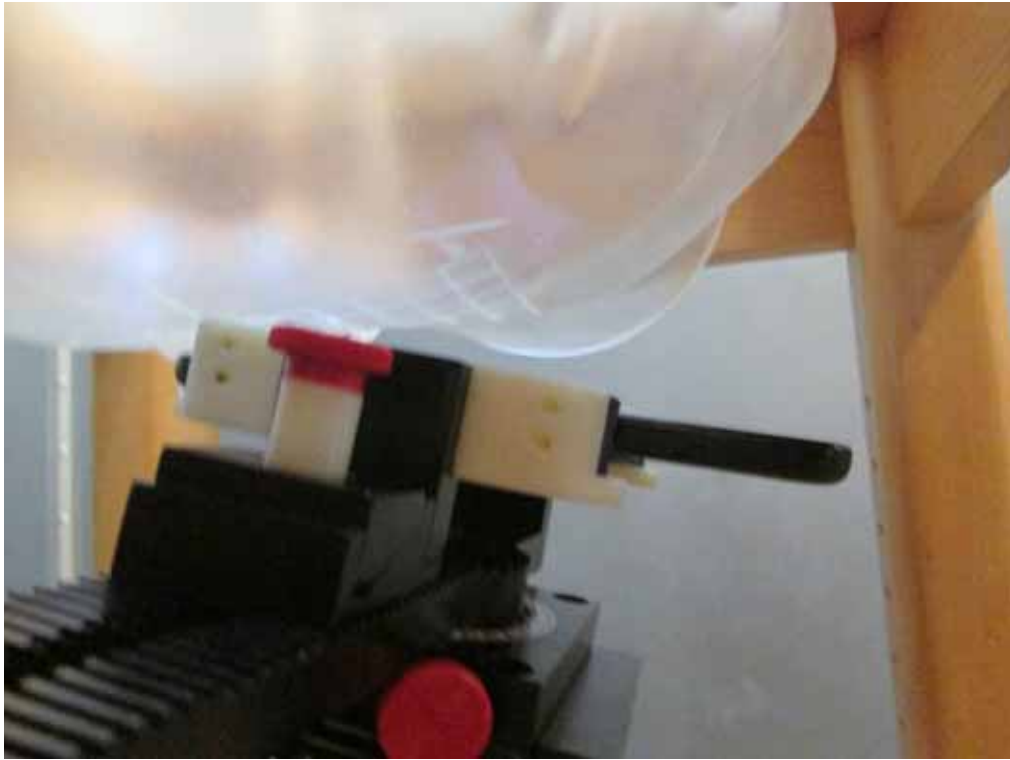

APPENDIX E EUT PHOTOS

EUT – Front View



EUT – Back View



EUT –Left Side View



EUT – Right Side View



EUT – Top View



EUT – Bottom View



EUT – Uncover View



APPENDIX F INFORMATIVE REFERENCES

- [1] Federal Communications Commission, \Report and order: Guidelines for evaluating the environmental effects of radiofrequency radiation", Tech. Rep. FCC 96-326, FCC, Washington, D.C. 20554, 1996.
- [2] David L. Means Kwok Chan, Robert F. Cleveland, \Evaluating compliance with FCC guidelines for human exposure to radiofrequency electromagnetic fields", Tech. Rep., Federal Communication Commission, Office of Engineering & Technology, Washington, DC, 1997.
- [3] Thomas Schmid, Oliver Egger, and Niels Kuster, \Automated E-field scanning system for dosimetric assessments", IEEE Transactions on Microwave Theory and Techniques, vol. 44, pp. 105-113, Jan. 1996.
- [4] Niels Kuster, Ralph Kastle, and Thomas Schmid, \Dosimetric evaluation of mobile communications equipment with known precision", IEICE Transactions on Communications, vol. E80-B, no. 5, pp. 645-652, May 1997.
- [5] CENELEC, \Considerations for evaluating of human exposure to electromagnetic fields (EMFs) from mobile telecommunication equipment (MTE) in the frequency range 30MHz - 6GHz", Tech. Rep., CENELEC, European Committee for Electrotechnical Standardization, Brussels, 1997.
- [6] ANSI, ANSI/IEEE C95.1-1992: IEEE Standard for Safety Levels with Respect to Human Exposure to Radio Frequency Electromagnetic Fields, 3 kHz to 300 GHz, The Institute of Electrical and Electronics Engineers, Inc., New York, NY 10017, 1992.
- [7] Katja Pokovic, Thomas Schmid, and Niels Kuster, \Robust setup for precise calibration of E-field probes in tissue simulating liquids at mobile communications frequencies", in ICECOM '97, Dubrovnik, October 15-17, 1997, pp. 120-24.
- [8] Katja Pokovic, Thomas Schmid, and Niels Kuster, \E-field probe with improved isotropy in brain simulating liquids", in Proceedings of the ELMAR, Zadar, Croatia, 23-25 June, 1996, pp. 172-175.
- [9] Volker Hombach, Klaus Meier, Michael Burkhardt, Eberhard Kuhn, and Niels Kuster, \The dependence of EM energy absorption upon human head modeling at 900 MHz", IEEE Transactions on Microwave Theory and Techniques, vol. 44, no. 10, pp. 1865-1873, Oct. 1996.
- [10] Klaus Meier, Ralf Kastle, Volker Hombach, Roger Tay, and Niels Kuster, \The dependence of EM energy absorption upon human head modeling at 1800 MHz", IEEE Transactions on Microwave Theory and Techniques, Oct. 1997, in press.
- [11] W. Gander, Computermathematik, Birkhaeuser, Basel, 1992.
- [12] W. H. Press, S. A. Teukolsky, W. T. Vetterling, and B. P. Flannery, Numerical Recipes in C, The Art of Scientific Computing, Second Edition, Cambridge University Press, 1992. Dosimetric Evaluation of Sample device, month 1998 9
- [13] NIS81 NAMAS, \The treatment of uncertainty in EMC measurement", Tech. Rep., NAMAS Executive, National Physical Laboratory, Teddington, Middlesex, England, 1994.
- [14] Barry N. Taylor and Christ E. Kuyatt, \Guidelines for evaluating and expressing the uncertainty of NIST measurement results", Tech. Rep., National Institute of Standards and Technology, 1994. Dosimetric Evaluation of Sample device, month 1998 10.

PRODUCT SIMILARITY DECLARATION LETTER

b mobile HK Limited
Flat 18, 14/F Block I, Golden Industrial Building, 16-26 Kwai Tak Street, Kwai Chung, New Territories, HONG
KONG, CHINA
Tel: +852 27287886 Fax: 852-27280468

5/6/2015

Product Similarity Declaration

To Whom It May Concern,

We, b mobile HK Limited hereby declare that we have a product named as Mobile Phone (Model no: AX1060) was tested by BACL, meanwhile, for our marketing purpose, we would like to list a series models (AX1050) on reports and certificate, all the models are identical schematics, except for the differences as below,

1. only difference model No.

No other changes are made to them.

We confirm that all information above is true, and we'll be responsible for all the consequences. Please contact me if you have any question.

For and on behalf of
b mobile HK Limited

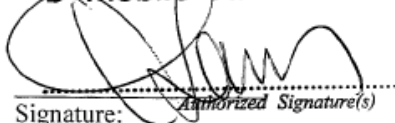
Signature: *Authorized Signature(s)*

KA SHING LAM
Director

***** END OF REPORT *****