

FCC SAR EVALUATION REPORT

In accordance with the requirements of
FCC 47 CFR Part 2(2.1093), ANSI/IEEE C95.1-1992 and
IEEE Std 1528-2013

Product Name : Mobile Phone
Brand Name : Bmobile
Model Name : C41
Family Model : N/A
Report No. : S22120507103001
FCC ID : ZSW-10-045

Prepared for

b mobile HK Limited

Flat 18; 14/F Block 1; Golden Industrial Building;16-26 Kwai Tak Street; Kwai Chung;New Territories; Hong Kong.

Prepared by

Shenzhen NTEK Testing Technology Co., Ltd.

1/F, Building E, Fenda Science Park, Sanwei Community, Xixiang Street,
Bao'an District, Shenzhen 518126 P.R.China.

Tel. 400-800-6106, 0755-2320 0050, 0755-2320 0090

Website: <http://www.ntek.org.cn>

TEST RESULT CERTIFICATION

Applicant's name : b mobile HK Limited
Address..... : Flat 18; 14/F Block 1; Golden Industrial Building;16-26 Kwai Tak Street; Kwai Chung; New Territories; Hong Kong.

Manufacturer's Name : b mobile HK Limited
Address..... : Flat 18; 14/F Block 1; Golden Industrial Building;16-26 Kwai Tak Street; Kwai Chung;New Territories; Hong Kong.

Product description

Product name : Mobile Phone
Brand Name : Bmobile
Model and/or type reference : C41
Family Model : N/A

Standards : FCC 47 CFR Part 2(2.1093)
ANSI/IEEE C95.1-1992
IEEE Std 1528-2013
Published RF exposure KDB procedures

This device described above has been tested by Shenzhen NTEK. In accordance with the measurement methods and procedures specified in IEEE Std 1528-2013 and KDB 865664 D01. Testing has shown that this device is capable of compliance with localized specific absorption rate (SAR) specified in FCC 47 CFR Part 2(2.1093) and ANSI/IEEE C95.1-1992. The test results in this report apply only to the tested sample of the stated device/equipment. Other similar device/equipment will not necessarily produce the same results due to production tolerance and measurement uncertainties.

This report shall not be reproduced except in full, without the written approval of Shenzhen NTEK, this document may be altered or revised by Shenzhen NTEK, personal only, and shall be noted in the revision of the document.

Test Sample Number..... : S221205071003

Date of Test

Date (s) of performance of tests..... : Dec. 08, 2022 ~ Dec. 16, 2022
Date of Issue : Feb. 13, 2023
Test Result..... : Pass

Prepared By (Test Engineer) : Jacob Chen (Jacob Chen)

Approved By (Lab Manager) : Alex Li (Alex Li)

※ ※ Revision History ※ ※

REV.	DESCRIPTION	ISSUED DATE	REMARK
Rev.1.0	Initial Test Report Release	Feb. 13, 2023	Jacob Chen

TABLE OF CONTENTS

1. General Information	6
1.1. RF exposure limits.....	6
1.2. Statement of Compliance	7
1.3. EUT Description	7
1.4. Test specification(s)	8
1.5. Ambient Condition.....	9
2. SAR Measurement System	10
2.1. SATIMO SAR Measurement Set-up Diagram	10
2.2. Robot	11
2.3. E-Field Probe.....	12
2.3.1. E-Field Probe Calibration	12
2.4. SAM phantoms	13
2.4.1. Technical Data	14
2.5. Device Holder	15
2.6. Test Equipment List	16
3. SAR Measurement Procedures	18
3.1. Power Reference	18
3.2. Area scan & Zoom scan.....	18
3.3. Description of interpolation/extrapolation scheme	20
3.4. Volumetric Scan	20
3.5. Power Drift	20
4. System Verification Procedure	21
4.1. Tissue Verification	21
4.1.1. Tissue Dielectric Parameter Check Results	22
4.2. System Verification Procedure	23
4.2.1. System Verification Results.....	24
5. SAR Measurement variability and uncertainty	25
5.1. SAR measurement variability.....	25
5.2. SAR measurement uncertainty	25
6. RF Exposure Positions.....	26
6.1. Ear and handset reference point	26
6.2. Definition of the cheek position	26
6.3. Definition of the tilt position	28
6.4. Body Worn Accessory	28
7. RF Output Power	29
7.1. GSM Conducted Power	29
7.2. WCDMA Conducted Power	30
7.3. LTE Conducted Power	31
7.4. Bluetooth Output Power.....	49
8. Stand-alone SAR test exclusion.....	49

- 9. SAR Results50
 - 9.1. SAR measurement Result.....50
 - 9.1.1. SAR measurement Result of GSM850.....50
 - 9.1.2. SAR measurement Result of GSM1900.....50
 - 9.1.3. SAR measurement Result of WCDMA Band 251
 - 9.1.4. SAR measurement Result of WCDMA Band 452
 - 9.1.5. SAR measurement Result of WCDMA Band 552
 - 9.1.6. SAR measurement Result of LTE Band 253
 - 9.1.7. SAR measurement Result of LTE Band 454
 - 9.1.8. SAR measurement Result of LTE Band 556
 - 9.1.9. SAR measurement Result of LTE Band 757
 - 9.1.10. SAR measurement Result of LTE Band 26A58
 - 9.1.11. SAR measurement Result of LTE Band 26B60
 - 9.1.12. SAR measurement Result of LTE Band 3862
 - 9.1.13. SAR measurement Result of LTE Band 6663
 - 9.2. Simultaneous Transmission Analysis.....65
- 10. Appendix A. Photo documentation65
- 11. Appendix B. System Check Plots66
- 12. Appendix C. Plots of High SAR Measurement.....75
- 13. Appendix D. Calibration Certificate128

1. General Information

1.1. RF exposure limits

(A).Limits for Occupational/Controlled Exposure (W/kg)

Whole-Body	Partial-Body	Hands, Wrists, Feet and Ankles
0.4	8.0	20.0

(B).Limits for General Population/Uncontrolled Exposure (W/kg)

Whole-Body	Partial-Body	Hands, Wrists, Feet and Ankles
0.08	1.6	4.0

NOTE: **Whole-Body SAR** is averaged over the entire body, **partial-body SAR** is averaged over any 1 gram of tissue defined as a tissue volume in the shape of a cube. **SAR for hands, wrists, feet and ankles** is averaged over any 10 grams of tissue defined as a tissue volume in the shape of a cube.

Occupational/Controlled Environments:

Are defined as locations where there is exposure that may be incurred by people who are aware of the potential for exposure, (i.e. as a result of employment or occupation).

General Population/Uncontrolled Environments:

Are defined as locations where there is the exposure of individuals who have no knowledge or control of their exposure.

NOTE

HEAD AND TRUNK LIMIT

1.6 W/kg

APPLIED TO THIS EUT

1.2. Statement of Compliance

The maximum results of Specific Absorption Rate (SAR) found during testing for C41 are as follows.

RF Exposure Conditions		Equipment Class -Highest Reported SAR (W/kg)			
		PCE	DTS	NII	DSS
1-g Head		1.196	N/A	N/A	N/A
1-g Body-Worn (Separation distance of 10mm)		1.088	N/A	N/A	N/A
Max Simultaneous Tx	Head	1.530	N/A	N/A	1.530
	Body-Worn	1.255	N/A	N/A	1.255

Note: The Max Simultaneous Tx is calculated based on the same configuration and test position.

This device is in compliance with Specific Absorption Rate (SAR) for general population/uncontrolled exposure limits (1.6 W/kg) specified in FCC 47 CFR Part 2(2.1093) and ANSI/IEEE C95.1-1992, and had been tested in accordance with the measurement methods and procedures specified in IEEE Std 1528-2013 & KDB 865664 D01.

1.3. EUT Description

Device Information			
Product Name	Mobile Phone		
Brand Name	Bmobile		
Model Name	C41		
Family Model	N/A		
Model Difference	N/A		
FCC ID	ZSW-10-045		
Device Phase	Identical Prototype		
Exposure Category	General population / Uncontrolled environment		
Antenna Type	FPC Antenna		
Battery Information	DC 3.8V, 1400mAh		
HW Version	C41_HW_V1.0		
SW Version	Bmobile_C41_TEM_MX_V001		
Device Operating Configurations			
Supporting Mode(s)	GSM 850/1900, WCDMA Band 2/4/5, LTE Band 2/4/5/7/26/38/66, Bluetooth		
Test Modulation	GSM(GMSK/8PSK) , WCDMA(QPSK), LTE(QPSK/16QAM), Bluetooth(GFSK, $\pi/4$ -DQPSK, 8DPSK)		
Device Class	B		
Operating Frequency Range(s)	Band	Tx (MHz)	Rx (MHz)
	GSM 850	824-849	869-894
	GSM 1900	1850-1910	1930-1990

	WCDMA Band 2	1850-1910	1930-1990
	WCDMA Band 4	1710-1755	2110-2155
	WCDMA Band 5	824-849	869-894
	LTE Band 2	1850-1910	1930-1990
	LTE Band 4	1710-1755	2110-2155
	LTE Band 5	824-849	869-894
	LTE Band 7	2500-2570	2620-2690
	LTE Band 26	814-849	859-894
	LTE Band 38	2570-2620	
	LTE Band 66	1710-1780	2110-2200
	Bluetooth	2402-2480	
GPRS Multislot Class(12)	Max Number of Timeslots in Uplink		4
	Max Number of Timeslots in Downlink		4
	Max Total Timeslot		5
EGPRS Multislot Class(12)	Max Number of Timeslots in Uplink		4
	Max Number of Timeslots in Downlink		4
	Max Total Timeslot		5
Power Class	4, tested with power level 5(GSM 850)		
	1, tested with power level 0(GSM 1900)		
	3, tested with power control "all 1"(WCDMA Band 2)		
	3, tested with power control "all 1"(WCDMA Band 4)		
	3, tested with power control "all 1"(WCDMA Band 5)		
	3, tested with power control all Max.(LTE Band 2)		
	3, tested with power control all Max.(LTE Band 4)		
	3, tested with power control all Max.(LTE Band 5)		
	3, tested with power control all Max.(LTE Band 7)		
	3, tested with power control all Max.(LTE Band 26)		
	3, tested with power control all Max.(LTE Band 38)		
3, tested with power control all Max.(LTE Band 66)			

1.4. Test specification(s)

FCC 47 CFR Part 2(2.1093)
ANSI/IEEE C95.1-1992
IEEE Std 1528-2013
KDB 865664 D01 SAR measurement 100 MHz to 6 GHz
KDB 865664 D02 RF Exposure Reporting
KDB 447498 D01 General RF Exposure Guidance
KDB 248227 D01 802.11 Wi-Fi SAR
KDB 941225 D01 3G SAR Procedures

KDB 941225 D05 SAR for LTE Devices

KDB 648474 D04 Handset SAR

1.5. Ambient Condition

Ambient temperature	20°C – 24°C
Relative Humidity	30% – 70%

2. SAR Measurement System

2.1. SATIMO SAR Measurement Set-up Diagram

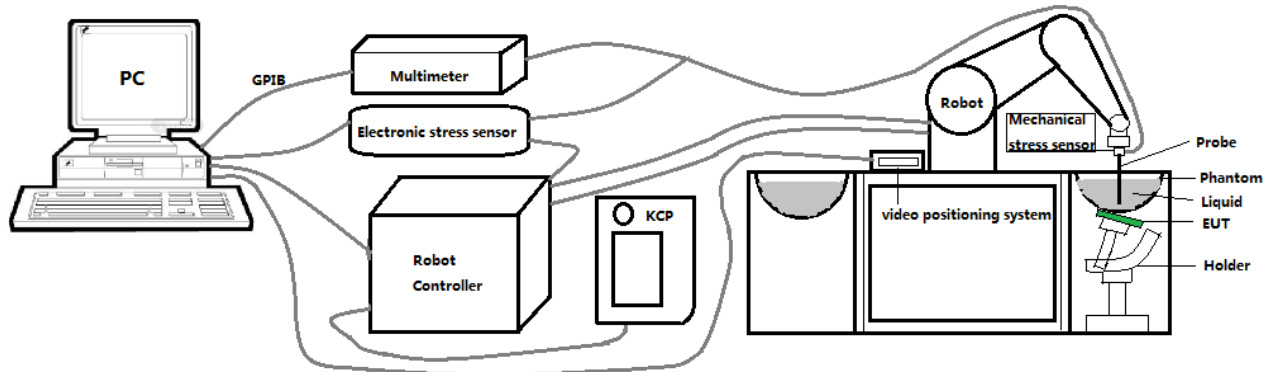

These measurements were performed with the automated near-field scanning system OPENSAR from SATIMO. The system is based on a high precision robot (working range: 901 mm), which positions the probes with a positional repeatability of better than ± 0.03 mm. The SAR measurements were conducted with dosimetric probe (manufactured by SATIMO), designed in the classical triangular configuration and optimized for dosimetric evaluation.

The first step of the field measurement is the evaluation of the voltages induced on the probe by the device under test. Probe diode detectors are nonlinear. Below the diode compression point, the output voltage is proportional to the square of the applied E-field; above the diode compression point, it is linear to the applied E-field. The compression point depends on the diode, and a calibration procedure is necessary for each sensor of the probe.

The Keithley multimeter reads the voltage of each sensor and send these three values to the PC. The corresponding E field value is calculated using the probe calibration factors, which are stored in the working directory. This evaluation includes linearization of the diode characteristics. The field calculation is done separately for each sensor. Each component of the E field is displayed on the "Dipole Area Scan Interface" and the total E field is displayed on the "3D Interface"

2.2. Robot

The SATIMO SAR system uses the high precision robots from KUKA. For the 6-axis controller system, the robot controller version (KUKA) from KUKA is used. The KUKA robot series have many features that are important for our application:



- High precision (repeatability ± 0.03 mm)
- High reliability (industrial design)
- Jerk-free straight movements
- Low ELF interference (the closed metallic construction shields against motor control fields)

2.3. E-Field Probe

This E-field detection probe is composed of three orthogonal dipoles linked to special Schottky diodes with low detection thresholds. The probe allows the measurement of electric fields in liquids such as the one defined in the IEEE and CENELEC standards.

For the measurements the Specific Dosimetric E-Field Probe SN 08/16 EPGO287 with following specifications is used



- Dynamic range: 0.01-100 W/kg
- Tip Diameter : 2.5 mm
- Distance between probe tip and sensor center: 1 mm
- Distance between sensor center and the inner phantom surface: 2 mm (repeatability better than ± 1 mm).
- Probe linearity: ± 0.08 dB
- Axial isotropy: ± 0.01 dB
- Hemispherical Isotropy: ± 0.01 dB
- Calibration range: 650MHz to 5900MHz for head & body simulating liquid.
- Lower detection limit: 8mW/kg

Angle between probe axis (evaluation axis) and surface normal line: less than 30° .

2.3.1. E-Field Probe Calibration

Each probe needs to be calibrated according to a dosimetric assessment procedure with accuracy better than $\pm 10\%$. The spherical isotropy shall be evaluated and within ± 0.25 dB. The sensitivity parameters (Norm X, Norm Y, and Norm Z), the diode compression parameter (DCP) and the conversion factor (Conv F) of the probe are tested. The calibration data can be referred to appendix D of this report.

2.4. SAM phantoms

Photo of SAM phantom SN 16/15 SAM119



The SAM phantom is used to measure the SAR relative to people exposed to electro-magnetic field radiated by Mobile Phone s.

2.4.1. Technical Data

Serial Number	Shell thickness	Filling volume	Dimensions	Positionner Material	Permittivity	Loss Tangent
SN 16/15 SAM119	2 mm ±0.2 mm	27 liters	Length:1000 mm Width:500 mm Height:200 mm	Gelcoat with fiberglass	3.4	0.02

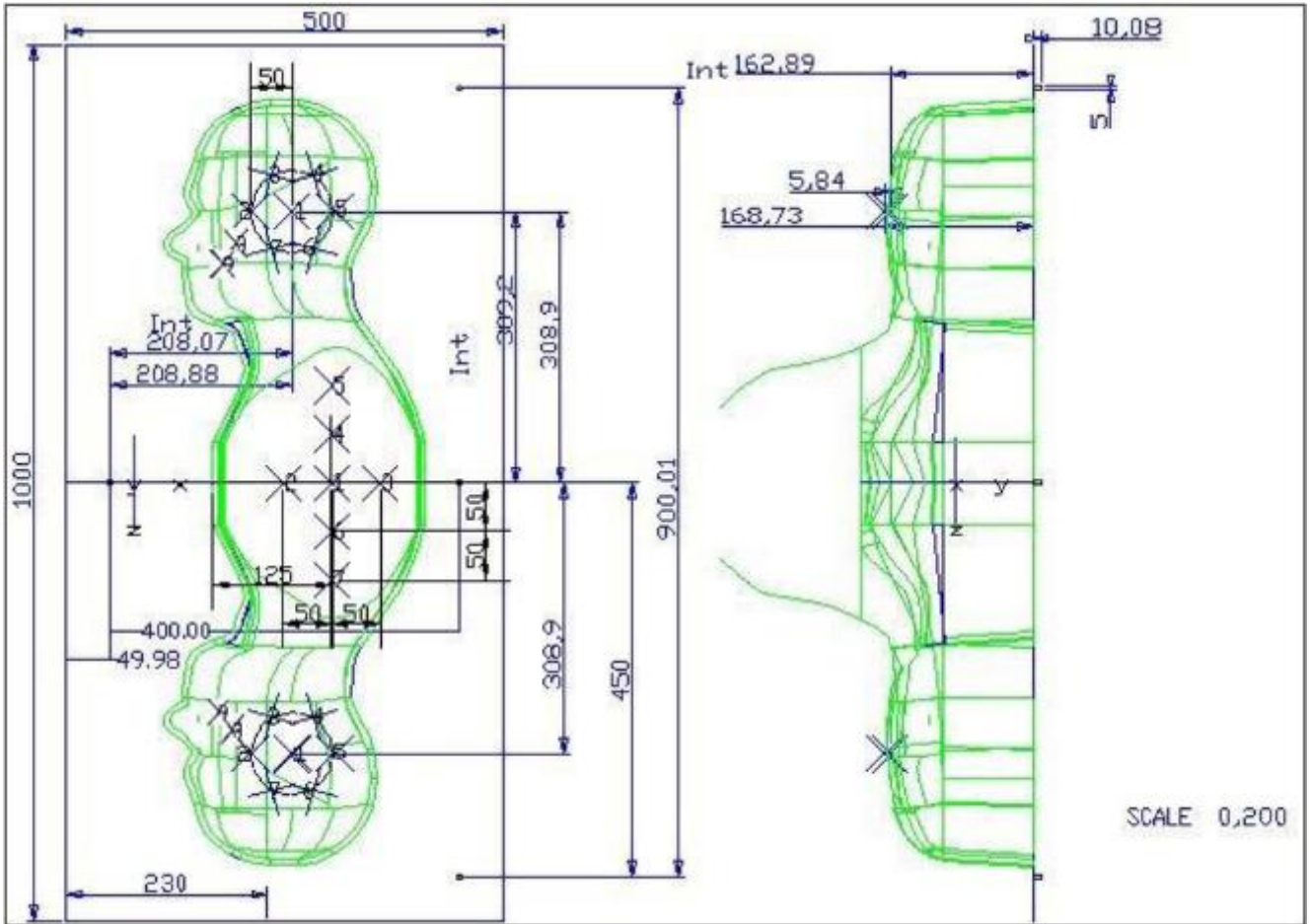

Serial Number	Left Head(mm)		Right Head(mm)		Flat Part(mm)	
	1	2	1	2	1	2
SN 16/15 SAM119	2	2.02	2	2.08	1	2.09
	3	2.05	3	2.06	2	2.06
	4	2.07	4	2.07	3	2.08
	5	2.08	5	2.08	4	2.10
	6	2.05	6	2.07	5	2.10
	7	2.05	7	2.05	6	2.07
	8	2.07	8	2.06	7	2.07
	9	2.08	9	2.06	-	-

The test, based on ultrasonic system, allows measuring the thickness with an accuracy of 10 µm.

2.5. Device Holder

The positioning system allows obtaining cheek and tilting position with a very good accuracy. In compliance with CENELEC, the tilt angle uncertainty is lower than 1 degree.

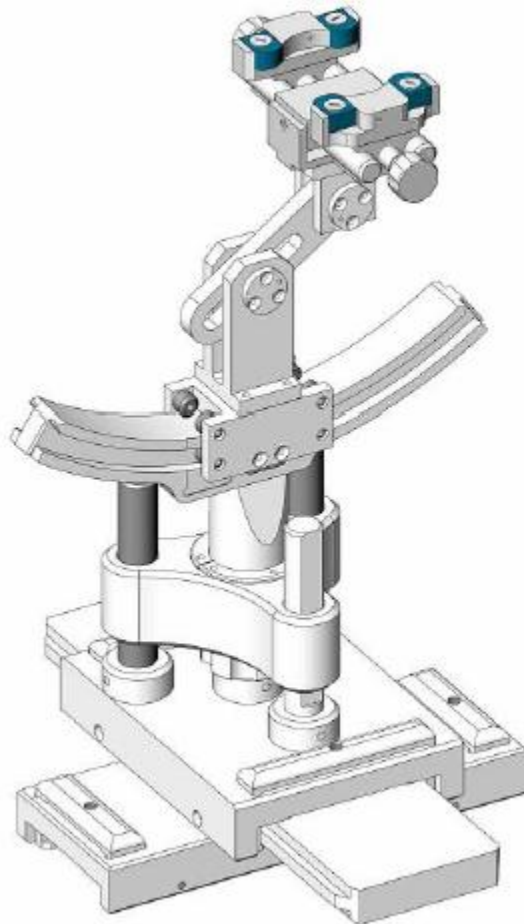

Serial Number	Holder Material	Permittivity	Loss Tangent
SN 16/15 MSH100	Delrin	3.7	0.005

2.6. Test Equipment List

This table gives a complete overview of the SAR measurement equipment.

Devices used during the test described are marked

	Manufacturer	Name of Equipment	Type/Model	Serial Number	Calibration	
					Last Cal.	Due Date
<input checked="" type="checkbox"/>	MVG	E FIELD PROBE	SSE2	SN 08/16 EPGO287	Feb. 01, 2022	Jan. 31, 2023
<input type="checkbox"/>	MVG	750 MHz Dipole	SID750	SN 03/15 DIP 0G750-355	Mar. 01, 2021	Feb. 28, 2024
<input checked="" type="checkbox"/>	MVG	835 MHz Dipole	SID835	SN 03/15 DIP 0G835-347	Mar. 01, 2021	Feb. 28, 2024
<input type="checkbox"/>	MVG	900 MHz Dipole	SID900	SN 03/15 DIP 0G900-348	Mar. 01, 2021	Feb. 28, 2024
<input checked="" type="checkbox"/>	MVG	1800 MHz Dipole	SID1800	SN 03/15 DIP 1G800-349	Mar. 01, 2021	Feb. 28, 2024
<input checked="" type="checkbox"/>	MVG	1900 MHz Dipole	SID1900	SN 03/15 DIP 1G900-350	Mar. 01, 2021	Feb. 28, 2024
<input type="checkbox"/>	MVG	2000 MHz Dipole	SID2000	SN 03/15 DIP 2G000-351	Mar. 01, 2021	Feb. 28, 2024
<input type="checkbox"/>	MVG	2300 MHz Dipole	SID2300	SN 03/16 DIP 2G300-358	Mar. 01, 2021	Feb. 28, 2024
<input type="checkbox"/>	MVG	2450 MHz Dipole	SID2450	SN 03/15 DIP 2G450-352	Mar. 01, 2021	Feb. 28, 2024
<input checked="" type="checkbox"/>	MVG	2600 MHz Dipole	SID2600	SN 03/15 DIP 2G600-356	Mar. 01, 2021	Feb. 28, 2024
<input type="checkbox"/>	MVG	5000 MHz Dipole	SWG5500	SN 13/14 WGA 33	Mar. 01, 2021	Feb. 28, 2024
<input checked="" type="checkbox"/>	MVG	Liquid measurement Kit	SCLMP	SN 21/15 OCPG 72	NCR	NCR
<input checked="" type="checkbox"/>	MVG	Power Amplifier	N.A	AMPLISAR_28/14_003	NCR	NCR
<input checked="" type="checkbox"/>	KEITHLEY	Millivoltmeter	2000	4072790	NCR	NCR
<input checked="" type="checkbox"/>	R&S	Universal radio communication tester	CMU200	117858	Jun. 17, 2022	Jun. 16, 2023
<input checked="" type="checkbox"/>	R&S	Wideband radio communication tester	CMW500	103917	Jun. 17, 2022	Jun. 16, 2023
<input checked="" type="checkbox"/>	HP	Network Analyzer	8753D	3410J01136	Jun. 17, 2022	Jun. 16, 2023

<input checked="" type="checkbox"/>	Agilent	MXG Vector Signal Generator	N5182A	MY47070317	Jun. 16, 2022	Jun. 15, 2023
<input checked="" type="checkbox"/>	Agilent	Power meter	E4419B	MY45102538	Jun. 17, 2022	Jun. 16, 2023
<input checked="" type="checkbox"/>	Agilent	Power sensor	E9301A	MY41495644	Jun. 17, 2022	Jun. 16, 2023
<input checked="" type="checkbox"/>	Agilent	Power sensor	E9301A	US39212148	Jun. 17, 2022	Jun. 16, 2023
<input checked="" type="checkbox"/>	MCLI/USA	Directional Coupler	CB11-20	0D2L51502	Jul. 17, 2020	Jul. 16, 2023

3. SAR Measurement Procedures

The measurement procedures are as follows:

<Conducted power measurement>

- (a) For WWAN power measurement, use base station simulator to configure EUT WWAN transmission in conducted connection with RF cable, at maximum power in each supported wireless interface and frequency band.
- (b) Read the WWAN RF power level from the base station simulator.
- (c) For Wi-Fi/BT power measurement, use engineering software to configure EUT Wi-Fi/BT continuously transmission, at maximum RF power in each supported wireless interface and frequency band.
- (d) Connect EUT RF port through RF cable to the power meter, and measure Wi-Fi/BT output power.

<SAR measurement>

- (a) Use base station simulator to configure EUT WWAN transmission in radiated connection, and engineering software to configure EUT Wi-Fi/BT continuously transmission, at maximum RF power, in the highest power channel.
- (b) Place the EUT in the positions as Appendix A demonstrates.
- (c) Set scan area, grid size and other setting on the OPENSAR software.
- (d) Measure SAR results for the highest power channel on each testing position.
- (e) Find out the largest SAR result on these testing positions of each band.
- (f) Measure SAR results for other channels in worst SAR testing position if the reported SAR of highest power channel is larger than 0.8 W/kg.

According to the test standard, the recommended procedure for assessing the peak spatial-average SAR value consists of the following steps:

- (a) Power reference measurement
- (b) Area scan
- (c) Zoom scan
- (d) Power drift measurement

3.1. Power Reference

The Power Reference Measurement and Power Drift Measurements are for monitoring the power drift of the device under test in the batch process. The minimum distance of probe sensors to surface determines the closest measurement point to phantom surface. This distance cannot be smaller than the distance of sensor calibration points to probe tip as defined in the probe properties.

3.2. Area scan & Zoom scan

The area scan is a 2D scan to find the hot spot location on the DUT. The zoom scan is a 3D scan

above the hot spot to calculate the 1g and 10g SAR value.

Measurement of the SAR distribution with a grid of 8 to 16 mm * 8 to 16 mm and a constant distance to the inner surface of the phantom. Since the sensors cannot directly measure at the inner phantom surface, the values between the sensors and the inner phantom surface are extrapolated. With these values the area of the maximum SAR is calculated by an interpolation scheme. Around this point, a cube of 30 * 30 * 30 mm or 32 * 32 * 32 mm is assessed by measuring 5 or 8 * 5 or 8 * 4 or 5 mm. With these data, the peak spatial-average SAR value can be calculated.

From the scanned SAR distribution, identify the position of the maximum SAR value, in addition identify the positions of any local maxima with SAR values within 2 dB of the maximum value that will not be within the zoom scan of other peaks; additional peaks shall be measured only when the primary peak is within 2 dB of the SAR compliance limit (e.g., 1 W/kg for 1,6 W/kg 1 g limit, or 1,26 W/kg for 2 W/kg, 10 g limit).

Area scan & Zoom scan scan parameters extracted from FCC KDB 865664 D01 SAR measurement 100 MHz to 6 GHz.

		≤ 3 GHz	> 3 GHz	
Maximum distance from closest measurement point (geometric center of probe sensors) to phantom surface		5 ± 1 mm	½·δ·ln(2) ± 0.5 mm	
Maximum probe angle from probe axis to phantom surface normal at the measurement location		30° ± 1°	20° ± 1°	
Maximum area scan spatial resolution: Δx _{Area} , Δy _{Area}		≤ 2 GHz: ≤ 15 mm 2 – 3 GHz: ≤ 12 mm	3 – 4 GHz: ≤ 12 mm 4 – 6 GHz: ≤ 10 mm	
		When the x or y dimension of the test device, in the measurement plane orientation, is smaller than the above, the measurement resolution must be ≤ the corresponding x or y dimension of the test device with at least one measurement point on the test device.		
Maximum zoom scan spatial resolution: Δx _{Zoom} , Δy _{Zoom}		≤ 2 GHz: ≤ 8 mm 2 – 3 GHz: ≤ 5 mm*	3 – 4 GHz: ≤ 5 mm* 4 – 6 GHz: ≤ 4 mm*	
Maximum zoom scan spatial resolution, normal to phantom surface	uniform grid: Δz _{Zoom} (n)	≤ 5 mm	3 – 4 GHz: ≤ 4 mm 4 – 5 GHz: ≤ 3 mm 5 – 6 GHz: ≤ 2 mm	
	graded grid	Δz _{Zoom} (1): between 1 st two points closest to phantom surface	≤ 4 mm	3 – 4 GHz: ≤ 3 mm 4 – 5 GHz: ≤ 2.5 mm 5 – 6 GHz: ≤ 2 mm
		Δz _{Zoom} (n>1): between subsequent points	≤ 1.5·Δz _{Zoom} (n-1)	
Minimum zoom scan volume	x, y, z	≥ 30 mm	3 – 4 GHz: ≥ 28 mm 4 – 5 GHz: ≥ 25 mm 5 – 6 GHz: ≥ 22 mm	

Note: δ is the penetration depth of a plane-wave at normal incidence to the tissue medium; see draft standard IEEE P1528-2011 for details.

* When zoom scan is required and the *reported* SAR from the *area scan based 1-g SAR estimation* procedures of KDB 447498 is ≤ 1.4 W/kg, ≤ 8 mm, ≤ 7 mm and ≤ 5 mm zoom scan resolution may be applied, respectively, for 2 GHz to 3 GHz, 3 GHz to 4 GHz and 4 GHz to 6 GHz.

3.3. Description of interpolation/extrapolation scheme

The local SAR inside the phantom is measured using small dipole sensing elements inside a probe body. The probe tip must not be in contact with the phantom surface in order to minimise measurements errors, but the highest local SAR will occur at the surface of the phantom.

An extrapolation is used to determine these highest local SAR values. The extrapolation is based on a fourth-order least-square polynomial fit of measured data. The local SAR value is then extrapolated from the liquid surface with a 1 mm step.

The measurements have to be performed over a limited time (due to the duration of the battery) so the step of measurement is high. It could vary between 5 and 8 mm. To obtain an accurate assessment of the maximum SAR averaged over 10 grams and 1 gram requires a very fine resolution in the three dimensional scanned data array.

3.4. Volumetric Scan

The volumetric scan consists of a full 3D scan over a specific area. This 3D scan is useful for multi Tx SAR measurement. Indeed, it is possible with OpenSAR to add, point by point, several volumetric scans to calculate the SAR value of the combined measurement as it is defined in the standard IEEE1528 and IEC62209.

3.5. Power Drift

All SAR testing is under the EUT installed with a full charged battery and transmit maximum output power. In OpenSAR measurement software, the power reference measurement and power drift measurement procedures are used for monitoring the power drift of EUT during SAR test. Both these procedures measure the field at a specified reference position before and after the SAR testing. The software will calculate the field difference in V/m. If the power drifts more than $\pm 5\%$, the SAR will be retested.

4. System Verification Procedure

4.1. Tissue Verification

The following tissue formulations are provided for reference only as some of the parameters have not been thoroughly verified. The composition of ingredients may be modified accordingly to achieve the desired target tissue parameters required for routine SAR evaluation.

Ingredients (% of weight)	Head Tissue									
	750	835	900	1800	1900	2000	2450	2600	5200	5800
Frequency Band (MHz)										
Water	34.40	34.40	34.40	55.36	55.36	57.87	57.87	57.87	65.53	65.53
NaCl	0.79	0.79	0.79	0.35	0.35	0.16	0.16	0.16	0.00	0.00
1,2-Propanediol	64.81	64.81	64.81	0.00	0.00	0.00	0.00	0.00	0.00	0.00
Triton X-100	0.00	0.00	0.00	30.45	30.45	19.97	19.97	19.97	24.24	24.24
DGBE	0.00	0.00	0.00	13.84	13.84	22.00	22.00	22.00	10.23	10.23

For SAR measurement of the field distribution inside the phantom, the phantom must be filled with homogeneous tissue simulating liquid to a depth of at least 15 cm. For head SAR testing, the liquid depth from the ear reference point (ERP) of the phantom to the liquid top surface is larger than 15 cm.

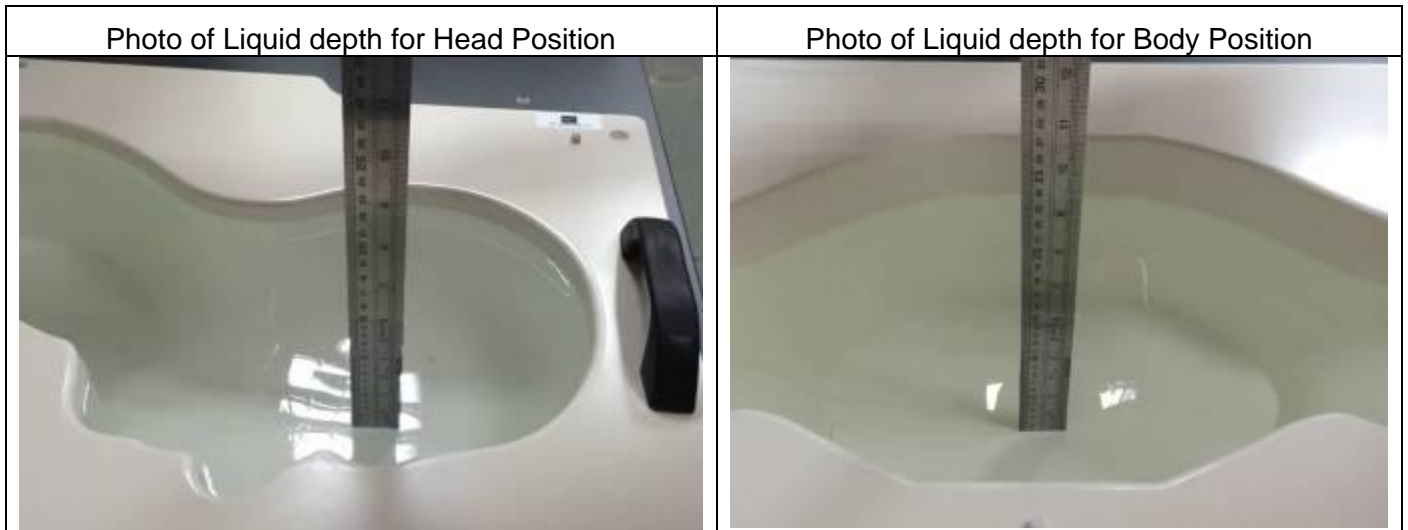

4.1.1. Tissue Dielectric Parameter Check Results

The simulating liquids should be checked at the beginning of a series of SAR measurements to determine if the dielectric parameters are within the tolerances of the specified target values. The measured conductivity and relative permittivity should be within $\pm 5\%$ of the target values.

Tissue Type	Measured Frequency (MHz)	Target Tissue		Measured Tissue		Liquid Temp.	Test Date
		$\epsilon_r (\pm 5\%)$	σ (S/m) ($\pm 5\%$)	ϵ_r	σ (S/m)		
Head 850	835	41.50 (39.43~43.58)	0.90 (0.86~0.95)	41.38	0.93	21.7 °C	Dec. 12, 2022
Head 1800	1800	40.00 (38.00~42.00)	1.40 (1.33~1.47)	39.04	1.40	21.3 °C	Dec. 16, 2022
Head 1900	1900	40.00 (38.00~42.00)	1.40 (1.33~1.47)	38.78	1.45	21.2 °C	Dec. 09, 2022
Head 2600	2600	39.01 (37.06~40.96)	1.96 (1.86~2.06)	38.08	1.98	21.8 °C	Dec. 08, 2022

NOTE: The dielectric parameters of the tissue-equivalent liquid should be measured under similar ambient conditions and within 2 °C of the conditions expected during the SAR evaluation to satisfy protocol requirements.

4.2. System Verification Procedure

The system verification is performed for verifying the accuracy of the complete measurement system and performance of the software. The dipole is connected to the signal source consisting of signal generator and amplifier via a directional coupler, N-connector cable and adaption to SMA. It is fed with a power of 100mW (below 5GHz) or 100mW (above 5GHz). To adjust this power a power meter is used. The power sensor is connected to the cable before the system verification to measure the power at this point and do adjustments at the signal generator. At the outputs of the directional coupler both return loss as well as forward power are controlled during the system verification to make sure that emitted power at the dipole is kept constant. This can also be checked by the power drift measurement after the test (result on plot).

The system verification is shown as below picture:

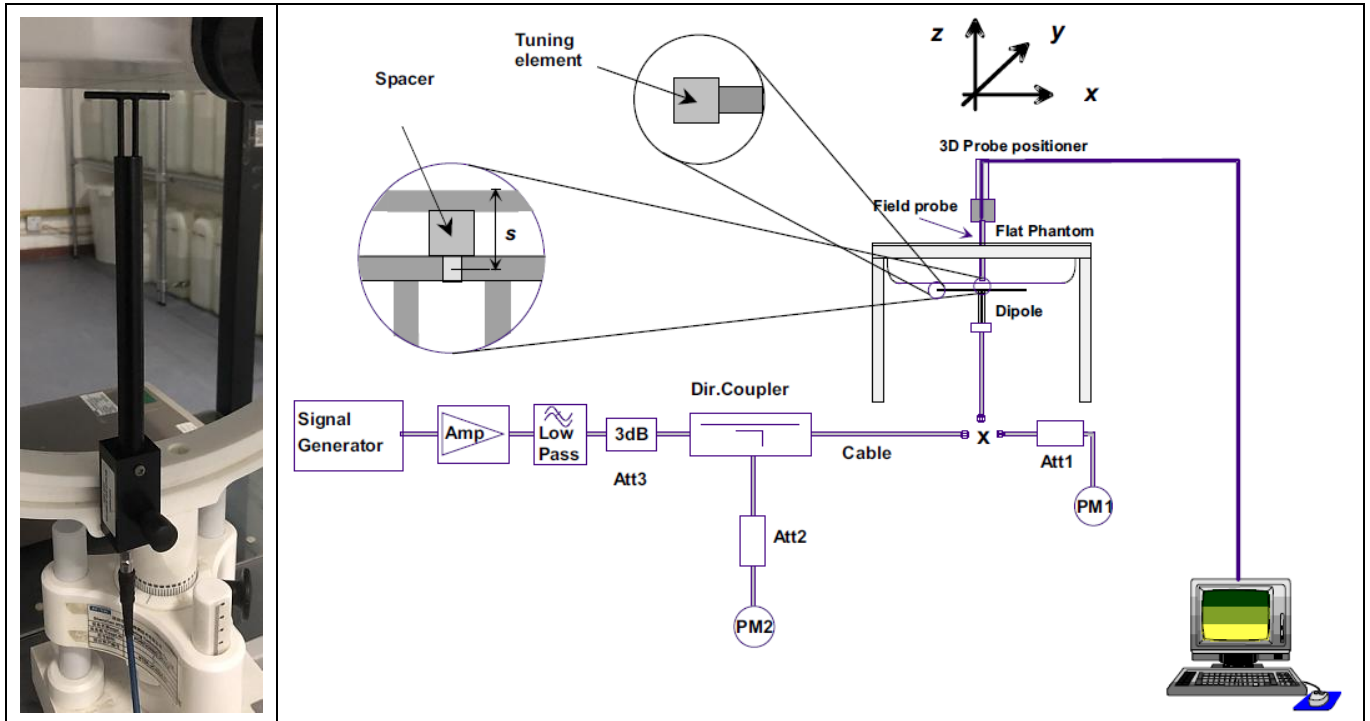

4.2.1. System Verification Results

Comparing to the original SAR value provided by SATIMO, the verification data should be within its specification of $\pm 10\%$. Below table shows the target SAR and measured SAR after normalized to 1W input power. The table below indicates the system performance verification can meet the variation criterion and the plots can be referred to Appendix B of this report.

System Verification	Target SAR (1W) ($\pm 10\%$)		Measured SAR (Normalized to 1W)		Liquid Temp.	Test Date
	1-g (W/Kg)	10-g (W/Kg)	1-g (W/Kg)	10-g (W/Kg)		
835MHz	9.84 (8.86~10.82)	6.22 (5.60~6.84)	10.06	6.64	21.7 °C	Dec. 12, 2022
1800MHz	37.96 (34.17~41.75)	19.81 (17.83~21.79)	35.88	19.53	21.3 °C	Dec. 16, 2022
1900MHz	40.37 (36.34~44.40)	20.48 (18.44~22.52)	37.27	19.91	21.2 °C	Dec. 09, 2022
2600MHz	55.83 (50.25~61.41)	24.19 (21.78~26.60)	55.91	25.21	21.8 °C	Dec. 08, 2022

5. SAR Measurement variability and uncertainty

5.1. SAR measurement variability

Per KDB865664 D01 SAR measurement 100 MHz to 6 GHz, SAR measurement variability must be assessed for each frequency band, which is determined by the SAR probe calibration point and tissue-equivalent medium used for the device measurements. The additional measurements are repeated after the completion of all measurements requiring the same head or body tissue-equivalent medium in a frequency band. The test device should be returned to ambient conditions (normal room temperature) with the battery fully charged before it is re-mounted on the device holder for the repeated measurement(s) to minimize any unexpected variations in the repeated results.

- 1) Repeated measurement is not required when the original highest measured SAR is < 0.80 W/kg; steps 2) through 4) do not apply.
- 2) When the original highest measured SAR is ≥ 0.80 W/kg, repeat that measurement once.
- 3) Perform a second repeated measurement only if the ratio of largest to smallest SAR for the original and first repeated measurements is > 1.20 or when the original or repeated measurement is ≥ 1.45 W/kg (~ 10% from the 1-g SAR limit).
- 4) Perform a third repeated measurement only if the original, first or second repeated measurement is ≥ 1.5 W/kg and the ratio of largest to smallest SAR for the original, first and second repeated measurements is > 1.20 .

5.2. SAR measurement uncertainty

Per KDB865664 D01 SAR Measurement 100 MHz to 6 GHz, when the highest measured 1-g SAR within a frequency band is < 1.5 W/kg, the extensive SAR measurement uncertainty analysis described in IEEE Std 1528-2013 is not required in SAR reports submitted for equipment approval. The equivalent ratio (1.5/1.6) is applied to extremity and occupational exposure conditions.

6. RF Exposure Positions

6.1. Ear and handset reference point

Figure 6.1.1 shows the front, back, and side views of the SAM phantom. The center-of-mouth reference point is labeled “M”, the left ear reference point (ERP) is marked “LE”, and the right ERP is marked “RE”.



Fig 6.1.1 Front, back, and side views of SAM phantom

6.2. Definition of the cheek position

1. Define two imaginary lines on the handset, the vertical centerline and the horizontal line. The vertical centerline passes through two points on the front side of the handset: the midpoint of the width w_t of the handset at the level of the acoustic output (point A in Figure 6.2.1 and Figure 6.2.2), and the midpoint of the width w_b of the bottom of the handset (point B). The horizontal line is perpendicular to the vertical centerline and passes through the center of the acoustic output (see Figure 6.2.1). The two lines intersect at point A. Note that for many handsets, point A coincides with the center of the acoustic output; however, the acoustic output may be located elsewhere on the horizontal line. Also note that the vertical centerline is not necessarily parallel to the front face of the handset (see Figure 6.2.2), especially for clamshell handsets, handsets with flip covers, and other irregularly-shaped handsets.
2. Position the handset close to the surface of the phantom such that point A is on the (virtual) extension of the line passing through points RE and LE on the phantom (see Figure 6.2.3), such that the plane defined by the vertical centerline and the horizontal line of the handset is approximately parallel to the sagittal plane of the phantom.
3. Translate the handset towards the phantom along the line passing through RE and LE until handset point A touches the pinna at the ERP
4. While maintaining the handset in this plane, rotate it around the LE-RE line until the vertical centerline is in the plane normal to the plane containing B-M and N-F lines, i.e., the Reference Plane.
5. Rotate the handset around the vertical centerline until the handset (horizontal line) is parallel to the N-F line.

6. While maintaining the vertical centerline in the Reference Plane, keeping point A on the line passing through RE and LE, and maintaining the handset contact with the pinna, rotate the handset about the N-F line until any point on the handset is in contact with a phantom point below the pinna on the cheek. See Figure 6.2.3. The actual rotation angles should be documented in the test report.

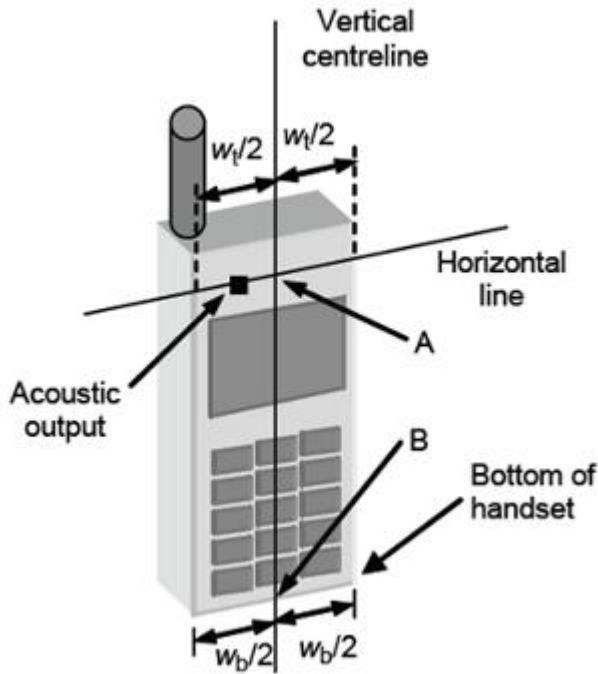

Fig 6.2.1 Handset vertical and horizontal reference lines—“fixed case”

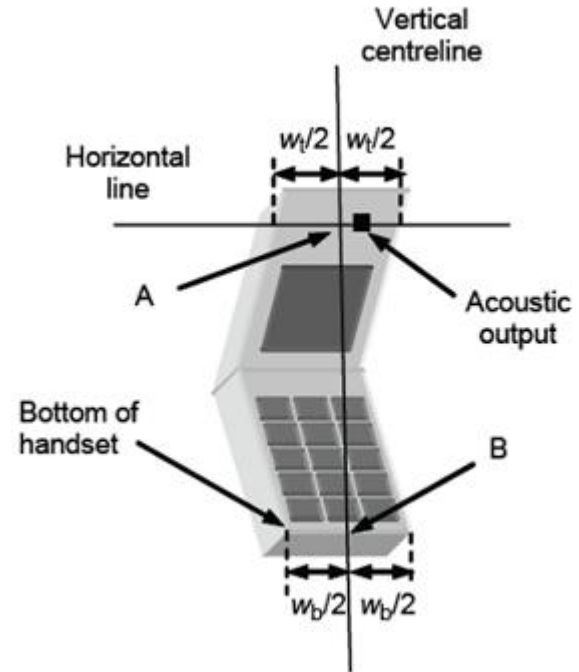

Fig 6.2.2 Handset vertical and horizontal reference lines—“clam-shell case”

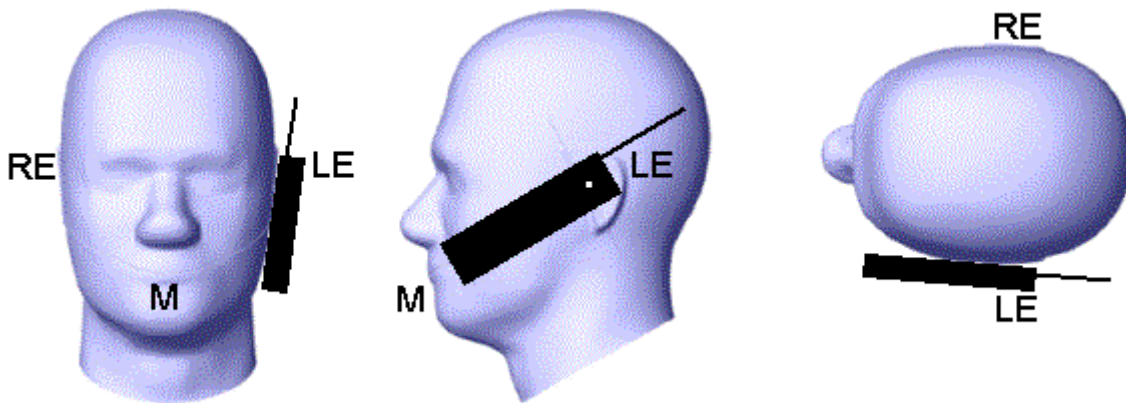

Fig 6.2.3 cheek or touch position. The reference points for the right ear (RE), left ear (LE), and mouth (M), which establish the Reference Plane for handset positioning, are indicated.

6.3. Definition of the tilt position

1. While maintaining the orientation of the handset, retract the handset parallel to the reference plane far enough away from the phantom to enable a rotation of the device by 15 degree.
2. Rotate the Handset around the horizontal line by 15 degree (see Figure 6.3.1).
3. While maintaining the orientation of the handset, move the handset towards the phantom on a line passing through RE and LE until any part of the handset touches the ear. The tilt position is obtained when the contact is on the pinna. If the contact is at any location other than the pinna, e.g., the antenna with the back of the phantom head, the angle of the handset shall be reduced. In this case, the tilt position is obtained if any part of the handset is in contact with the pinna as well as a second part of the handset is in contact with the phantom, e.g., the antenna with the back of the head.

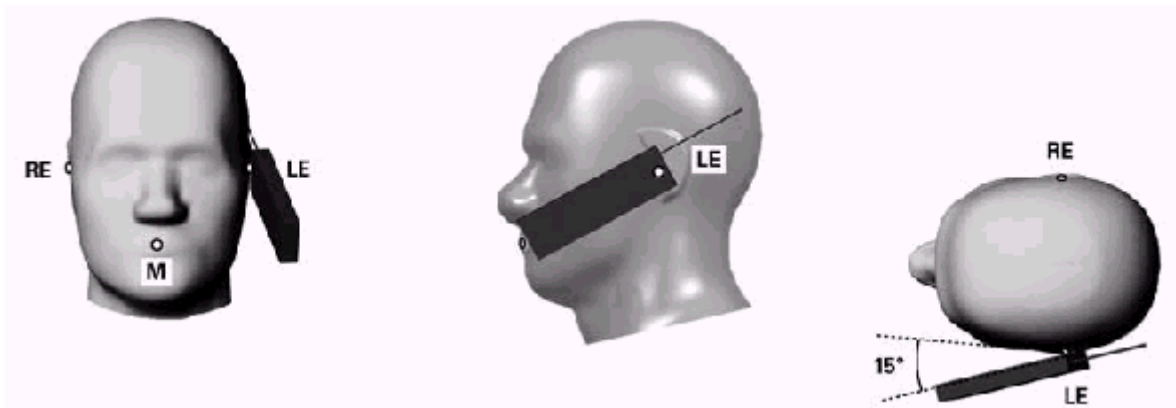

Figure 6.3.1 – Tilt position of the wireless device on the left side of SAM

6.4. Body Worn Accessory

1. Body-worn operating configurations are tested with the belt-clips and holsters attached to the device and positioned against a flat phantom in a normal use configuration (see Figure 6.4.1). Per KDB 648474 D04, body-worn accessory exposure is typically related to voice mode operations when handsets are carried in body-worn accessories. The body-worn accessory procedures in FCC KDB 447498 D01 should be used to test for body-worn accessory SAR compliance, without a headset connected to it. This enables the test results for such configuration to be compatible with that required for hotspot mode when the body-worn accessory test separation distance is greater than or equal to that required for hotspot mode, when applicable. When the reported SAR for body-worn accessory, measured without a headset connected to the handset is < 1.2 W/kg, the highest reported SAR configuration for that wireless mode and frequency band should be repeated for that body-worn accessory with a handset attached to the handset.
2. Accessories for body-worn operation configurations are divided into two categories: those that do not contain metallic components and those that do contain metallic components and those that do contain metallic components. When multiple accessories that do not contain metallic components are supplied with the device, the device is tested with only the accessory that dictates the closest

spacing to the body. Then multiple accessories that contain metallic components are test with the device with each accessory. If multiple accessories share an identical metallic component (i.e. the same metallic belt-clip used with different holsters with no other metallic components) only the accessory that dictates the closest spacing to the body is tested.

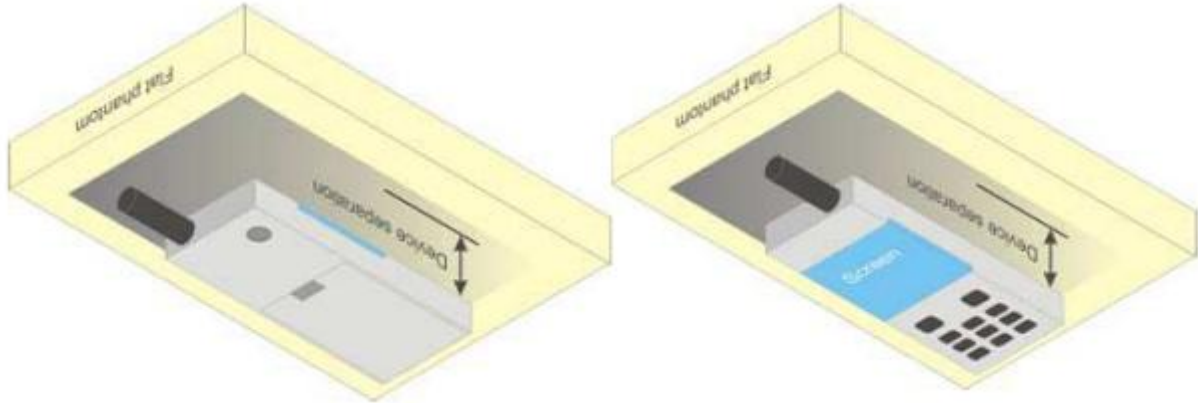

Figure 6.4.1 – Test positions for body-worn devices

7. RF Output Power

7.1. GSM Conducted Power

Band GSM850	Burst-Averaged output Power (dBm)				Frame-Averaged output Power (dBm)			
	Tune - up (dBm)	128	189	251	Tune - up (dBm)	128	189	251
Tx Channel								
Frequency (MHz)		824.2	836.4	848.8		824.2	836.4	848.8
GSM (GMSK)	34.00	33.56	33.43	33.40	24.97	24.53	24.40	24.37
GPRS(GMSK, 1 TS)	34.00	33.56	33.42	33.41	24.97	24.53	24.39	24.38
GPRS(GMSK, 2 TS)	31.50	31.39	31.31	31.11	25.48	25.37	25.29	25.09
GPRS(GMSK, 3 TS)	30.00	29.62	29.57	29.32	25.74	25.36	25.31	25.06
GPRS(GMSK, 4 TS)	28.00	27.65	27.60	27.30	24.99	24.64	24.59	24.29
EGPRS(8PSK, 1 TS)	28.00	27.64	27.33	27.14	18.97	18.61	18.30	18.11
EGPRS(8PSK, 2 TS)	27.00	26.87	26.09	26.05	20.98	20.85	20.07	20.03
EGPRS(8PSK, 3 TS)	25.00	24.57	24.62	24.03	20.74	20.31	20.36	19.77
EGPRS(8PSK, 4 TS)	22.50	22.46	22.10	22.02	19.49	19.45	19.09	19.01
Band GSM1900	Burst-Averaged output Power (dBm)				Frame-Averaged output Power (dBm)			
	Tune - up (dBm)	512	661	810	Tune - up (dBm)	512	661	810
Tx Channel								
Frequency (MHz)		1850.2	1880	1909.8		1850.2	1880	1909.8
GSM (GMSK)	31.00	30.68	30.72	30.75	21.97	21.65	21.69	21.72
GPRS(GMSK, 1 TS)	31.00	30.73	30.79	30.82	21.97	21.70	21.76	21.79

GPRS(GMSK, 2 TS)	29.00	28.69	28.74	28.75	22.98	22.67	22.72	22.73
GPRS(GMSK, 3 TS)	27.50	27.25	27.28	27.28	23.24	22.99	23.02	23.02
GPRS(GMSK, 4 TS)	25.50	25.42	25.40	25.41	22.49	22.41	22.39	22.40
EGPRS(8PSK, 1 TS)	28.00	27.84	27.86	27.83	18.97	18.81	18.83	18.80
EGPRS(8PSK, 2 TS)	27.00	26.61	26.80	26.00	20.98	20.59	20.78	19.98
EGPRS(8PSK, 3 TS)	25.00	24.11	24.60	23.89	20.74	19.85	20.34	19.63
EGPRS(8PSK, 4 TS)	22.50	22.17	22.37	21.58	19.49	19.16	19.36	18.57

Note: The frame-averaged power is linearly scaled the maximum burst averaged power over 8 time slots. The calculated method are shown as below:

Frame-averaged power = Maximum burst averaged power (1 Tx Slot) - 9.03 dB

Frame-averaged power = Maximum burst averaged power (2 Tx Slots) - 6.02 dB

Frame-averaged power = Maximum burst averaged power (3 Tx Slots) - 4.26 dB

Frame-averaged power = Maximum burst averaged power (4 Tx Slots) - 3.01 dB

7.2. WCDMA Conducted Power

WCDMA Band 2		Burst-Averaged output Power (dBm)			
Tx Channel	Tune-up (dBm)	9262	9400	9538	
Frequency (MHz)		1852.4	1880	1907.6	
RMC12.2K	24.00	23.39	23.50	23.48	
HSDPA Sub 1	23.00	22.93	22.62	22.73	
HSDPA Sub 2	23.50	23.13	22.35	22.53	
HSDPA Sub 3	23.00	22.58	22.21	22.12	
HSDPA Sub 4	22.50	22.18	21.95	22.17	
HSUPA Sub 1	23.50	23.25	22.62	22.58	
HSUPA Sub 2	23.00	22.99	22.71	22.77	
HSUPA Sub 3	23.00	22.64	22.39	22.56	
HSUPA Sub 4	23.00	22.91	22.47	22.59	
HSUPA Sub 5	23.00	22.72	22.54	22.62	
WCDMA Band 4		Burst-Averaged output Power (dBm)			
Tx Channel	Tune-up (dBm)	1312	1413	1513	
Frequency (MHz)		1712.4	1732.6	1752.6	
RMC12.2K	24.00	23.51	23.74	23.68	
HSDPA Sub 1	23.00	22.92	22.96	22.57	
HSDPA Sub 2	23.00	22.48	22.74	22.35	
HSDPA Sub 3	22.50	22.24	22.24	22.04	
HSDPA Sub 4	22.50	22.04	22.26	21.93	
HSUPA Sub 1	23.50	23.04	22.87	22.29	

HSUPA Sub 2	23.00	22.77	22.99	22.52
HSUPA Sub 3	23.00	22.38	22.51	22.31
HSUPA Sub 4	23.00	22.67	22.83	22.44
HSUPA Sub 5	23.00	22.45	22.61	22.31
WCDMA Band 5	Burst-Averaged output Power (dBm)			
Tx Channel	Tune-up (dBm)	4132	4182	4233
Frequency (MHz)		826.4	836.4	846.6
RMC12.2K	23.00	22.89	22.83	22.97
HSDPA Sub 1	23.00	22.98	22.67	22.41
HSDPA Sub 2	23.00	22.50	22.47	22.17
HSDPA Sub 3	22.50	22.20	22.10	21.80
HSDPA Sub 4	22.50	22.01	22.06	21.77
HSUPA Sub 1	23.00	22.88	22.58	22.19
HSUPA Sub 2	23.00	22.82	22.63	22.40
HSUPA Sub 3	22.50	22.39	22.34	22.07
HSUPA Sub 4	23.00	22.47	22.50	22.10
HSUPA Sub 5	23.00	22.65	22.26	22.27

7.3. LTE Conducted Power

Band	Band Width	Modulation	RB Configuration		Tune-up (dBm)	Channel/Frequency(MHz)		
			RB Size	RB Offset		18607/1850.7	18900/1880	19193/1909.3
LTE Band 2	1.4MHz	QPSK	1	0	24.50	23.08	24.16	24.14
			1	2	24.50	24.18	24.11	24.10
			1	5	24.50	24.08	24.13	24.23
			3	0	24.50	24.22	24.22	24.13
			3	1	24.50	24.26	24.23	24.13
			3	2	24.50	24.18	24.08	24.14
		16QAM	6	0	23.50	23.14	23.08	23.02
			1	0	24.00	23.50	23.56	23.70
			1	2	24.00	23.54	23.60	23.67
			1	5	24.00	23.57	23.58	23.67
			3	0	24.00	23.61	23.19	23.26
			3	1	24.00	23.67	23.21	23.22
			3	2	24.00	23.64	23.20	23.22
			6	0	22.50	22.42	22.47	22.10
Band	Band	Modulation	RB		Tune-up	Channel/Frequency(MHz)		

	Width		Configuration		(dBm)			
			RB Size	RB Offset		18615/1851.5	18900/1880	19185/1908.5
LTE Band 2	3MHz	QPSK	1	0	24.50	23.00	24.32	24.20
			1	7	24.50	24.13	24.30	24.10
			1	14	24.50	24.13	24.29	24.13
			8	0	23.50	23.08	23.09	23.11
			8	4	23.50	23.02	23.02	23.06
			8	7	23.50	22.99	23.07	23.02
		16QAM	15	0	23.50	23.12	22.96	22.96
			1	0	24.00	23.28	23.86	23.79
			1	7	24.00	23.29	23.79	23.67
			1	14	24.00	23.34	23.87	23.65
			8	0	22.50	22.20	22.03	22.40
			8	4	22.50	22.21	22.08	22.39
			8	7	22.50	22.20	22.07	22.39
15	0	22.50	22.31	22.21	22.21			
Band	Band Width	Modulation	RB Configuration		Tune-up (dBm)	Channel/Frequency(MHz)		
			RB Size	RB Offset		18625/1852.5	18900/1880	19175/1907.5
LTE Band 2	5MHz	QPSK	1	0	24.50	23.98	24.18	23.93
			1	12	24.50	23.90	24.19	23.98
			1	24	24.50	23.97	24.19	23.95
			12	0	23.50	23.06	22.98	23.11
			12	6	23.50	22.98	22.93	23.04
			12	11	23.50	23.15	23.07	23.01
		16QAM	25	0	23.50	23.03	23.06	23.03
			1	0	24.00	23.42	22.83	23.12
			1	12	24.00	23.55	22.80	23.08
			1	24	24.00	23.49	22.90	23.04
			12	0	22.50	22.11	22.03	22.22
			12	6	22.50	22.08	21.99	22.15
			12	11	22.50	22.15	21.96	22.09
25	0	22.50	22.22	22.23	22.11			
Band	Band Width	Modulation	RB Configuration		Tune-up (dBm)	Channel/Frequency(MHz)		
			RB Size	RB Offset		18650/1855	18900/1880	19150/1905
LTE	10MHz	QPSK	1	0	24.50	23.07	24.21	24.31

Band 2			1	24	24.50	24.18	24.19	24.27
			1	49	24.50	24.08	24.18	24.20
			25	0	23.50	23.12	22.98	23.09
			25	12	23.50	23.11	23.06	23.09
			25	24	23.50	23.11	23.05	23.16
			50	0	23.50	23.15	23.07	23.20
		16QAM	1	0	24.50	24.43	23.88	23.66
			1	24	24.50	24.42	23.74	23.61
			1	49	24.50	24.49	23.77	23.47
			25	0	22.50	22.06	22.24	22.29
			25	12	22.50	22.18	22.25	22.31
			25	24	22.50	22.23	22.22	22.25
Band	Band Width	Modulation	RB Configuration		Tune-up (dBm)	Channel/Frequency(MHz)		
			RB Size	RB Offset		18675/1857.5	18900/1880	19125/1902.5
LTE Band 2	15MHz	QPSK	1	0	25.00	24.35	24.50	24.17
			1	37	25.00	24.22	24.34	24.17
			1	74	25.00	24.27	24.35	24.17
			36	0	23.50	23.10	23.08	23.18
			36	18	23.50	23.24	23.10	23.05
			36	37	23.50	23.20	23.11	23.13
		16QAM	1	0	24.50	23.96	24.48	23.24
			1	37	24.50	24.00	24.39	23.27
			1	74	24.50	24.02	24.39	23.21
			36	0	22.50	22.24	22.27	22.33
			36	18	22.50	22.22	22.27	22.36
			36	37	22.50	22.34	22.27	22.29
Band	Band Width	Modulation	RB Configuration		Tune-up (dBm)	Channel/Frequency(MHz)		
			RB Size	RB Offset		18700/1860	18900/1880	19100/1900
LTE Band 2	20MHz	QPSK	1	0	24.50	24.29	24.09	24.31
			1	49	24.50	24.26	23.99	24.30
			1	99	24.50	24.35	24.07	24.30
			50	0	23.50	23.09	23.03	23.14
			50	24	23.50	23.14	23.10	23.00
			50	49	23.50	23.06	23.11	23.02
			100	0	23.50	23.17	23.06	23.14

16QAM	1	0	23.50	22.95	23.06	23.06
	1	49	23.50	22.93	22.99	23.02
	1	99	23.50	22.98	22.98	23.02
	50	0	22.50	22.36	22.32	22.18
	50	24	22.50	22.42	22.26	22.28
	50	49	22.50	22.37	22.12	22.22

Band	Band Width	Modulation	RB Configuration		Tune-up (dBm)	Channel/Frequency(MHz)		
			RB Size	RB Offset		19957/1710.7	20175/1732.5	20393/1754.3
LTE Band 4	1.4MHz	QPSK	1	0	25.00	24.30	24.24	24.52
			1	2	25.00	24.22	24.26	24.52
			1	5	25.00	24.19	24.34	24.52
			3	0	24.50	24.17	24.29	24.31
			3	1	24.50	24.21	24.34	24.31
			3	2	24.50	24.11	24.29	24.26
		16QAM	6	0	23.50	23.16	23.33	23.25
			1	0	24.50	24.28	24.13	23.90
			1	2	24.50	24.32	24.06	23.89
			1	5	24.50	24.30	24.13	23.98
			3	0	24.00	23.42	23.52	23.72
			3	1	24.00	23.38	23.54	23.70
			3	2	24.00	23.42	23.50	23.63
			6	0	23.00	22.53	22.36	22.47
Band	Band Width	Modulation	RB Configuration		Tune-up (dBm)	Channel/Frequency(MHz)		
			RB Size	RB Offset		19965/1711.5	20175/1732.5	20385/1753.5
LTE Band 4	3MHz	QPSK	1	0	25.00	24.12	24.26	24.51
			1	7	25.00	24.15	24.30	24.53
			1	14	25.00	24.15	24.34	24.50
			8	0	23.50	23.11	23.31	23.20
			8	4	23.50	23.13	23.37	23.22
			8	7	23.50	23.13	23.33	23.13
			15	0	23.50	23.09	23.34	23.18
		16QAM	1	0	24.50	24.43	24.06	23.82
			1	7	24.50	24.30	24.01	23.90
			1	14	24.50	24.38	24.06	23.86
			8	0	23.00	22.15	22.64	22.34

Band	Band Width	Modulation	RB Configuration		Tune-up (dBm)	Channel/Frequency(MHz)		
			RB Size	RB Offset		19975/1712.5	20175/1732.5	20375/1752.5
			8	4	23.00	22.11	22.69	22.37
			8	7	23.00	22.14	22.74	22.42
			15	0	23.00	22.36	22.50	22.30
Band	Band Width	Modulation	RB Configuration		Tune-up (dBm)	Channel/Frequency(MHz)		
			RB Size	RB Offset		19975/1712.5	20175/1732.5	20375/1752.5
LTE Band 4	5MHz	QPSK	1	0	24.50	23.97	24.41	24.16
			1	12	24.50	24.03	24.43	24.13
			1	24	24.50	24.00	24.45	24.18
			12	0	23.50	23.07	23.31	23.29
			12	6	23.50	23.17	23.23	23.27
			12	11	23.50	23.10	23.31	23.16
			25	0	23.50	23.04	23.33	23.24
		16QAM	1	0	24.00	23.45	23.02	23.46
			1	12	24.00	23.50	23.09	23.46
			1	24	24.00	23.46	23.05	23.49
			12	0	22.50	22.24	22.31	22.37
			12	6	22.50	22.23	22.29	22.36
			12	11	22.50	22.18	22.39	22.26
			25	0	23.00	22.29	22.54	22.29
Band	Band Width	Modulation	RB Configuration		Tune-up (dBm)	Channel/Frequency(MHz)		
			RB Size	RB Offset		20000/1715	20175/1732.5	20350/1750
LTE Band 4	10MHz	QPSK	1	0	25.00	24.11	24.25	24.53
			1	24	25.00	24.07	24.35	24.60
			1	49	25.00	24.11	24.37	24.54
			25	0	23.50	23.15	23.30	23.31
			25	12	23.50	23.04	23.23	23.26
			25	24	23.50	23.19	23.34	23.27
			50	0	23.50	23.17	23.21	23.28
		16QAM	1	0	25.00	24.41	24.02	24.50
			1	24	25.00	24.42	24.03	24.46
			1	49	25.00	24.42	24.06	24.43
			25	0	23.00	22.12	22.50	22.37
			25	12	23.00	22.20	22.55	22.43
			25	24	23.00	22.18	22.49	22.37
			Band	Band Width	Modulation	RB Configuration		Tune-up (dBm)
RB Size	RB Offset	20000/1715				20175/1732.5	20350/1750	

Band	Band Width	Modulation	RB Configuration		Tune-up (dBm)	Channel/Frequency(MHz)		
			RB Size	RB Offset		20050/1720	20175/1732.5	20300/1745
LTE Band 4	15MHz	QPSK	1	0	24.50	20025/1717.5	20175/1732.5	20325/1747.5
			1	37	24.50	24.16	24.24	24.20
			1	74	24.50	24.09	24.30	24.13
			36	0	23.50	24.23	24.34	24.07
			36	18	23.50	23.00	23.17	23.22
			36	37	23.50	23.18	23.27	23.32
		16QAM	36	37	23.50	23.16	23.25	23.15
			75	0	23.50	23.18	23.23	23.35
			1	0	25.00	24.41	23.40	24.32
			1	37	25.00	24.36	23.44	24.20
			1	74	25.00	24.53	23.51	24.22
			36	0	23.00	22.31	22.58	22.40
LTE Band 4	20MHz	QPSK	36	18	23.00	22.29	22.55	22.36
			36	37	23.00	22.35	22.56	22.33
			1	0	25.00	24.30	23.99	24.28
			1	49	25.00	24.29	24.15	24.19
			1	99	25.00	24.53	24.24	24.21
			50	0	23.50	23.04	23.18	23.33
		16QAM	50	24	23.50	23.12	23.25	23.26
			50	49	23.50	23.24	23.27	23.28
			100	0	23.50	23.09	23.30	23.40
			1	0	24.00	22.91	23.56	23.48
			1	49	24.00	22.95	23.74	23.38
			1	99	24.00	23.09	23.77	23.40
LTE Band 5	1.4MHz	QPSK	50	0	22.50	22.33	22.41	22.37
			50	24	22.50	22.36	22.45	22.45
			50	49	22.50	22.47	22.37	22.48

Band	Band Width	Modulation	RB Configuration		Tune-up (dBm)	Channel/Frequency(MHz)		
			RB Size	RB Offset		20407/824.7	20525/836.5	20643/848.3
LTE Band 5	1.4MHz	QPSK	1	0	24.00	22.53	23.50	23.46
			1	2	24.00	23.61	23.51	23.55
			1	5	24.00	23.61	23.56	23.49

			3	0	24.00	23.50	23.44	23.51
			3	1	24.00	23.49	23.44	23.52
			3	2	24.00	23.47	23.36	23.48
			6	0	23.00	22.56	22.42	22.53
		16QAM	1	0	24.00	22.61	23.66	22.97
			1	2	24.00	22.61	23.67	22.92
			1	5	24.00	22.53	23.64	22.94
			3	0	23.00	22.42	22.71	22.68
			3	1	23.00	22.48	22.71	22.71
			3	2	23.00	22.46	22.75	22.69
			6	0	22.00	21.55	21.73	21.89
Band	Band Width		Modulation	RB Configuration		Tune-up (dBm)	Channel/Frequency(MHz)	
		RB Size		RB Offset	20415/825.5		20525/836.5	20635/847.5
LTE Band 5	3MHz	QPSK	1	0	24.00	23.57	23.40	23.78
			1	7	24.00	23.53	23.41	23.82
			1	14	24.00	23.44	23.40	23.82
			8	0	23.00	22.54	22.45	22.39
			8	4	23.00	22.39	22.45	22.53
			8	7	23.00	22.40	22.34	22.47
			15	0	23.00	22.38	22.40	22.54
		16QAM	1	0	24.00	23.46	23.06	23.55
			1	7	24.00	23.34	23.08	23.57
			1	14	24.00	23.39	23.14	23.58
			8	0	22.00	21.42	21.69	21.58
			8	4	22.00	21.35	21.73	21.56
			8	7	22.00	21.35	21.68	21.85
			15	0	22.00	21.54	21.50	21.60
Band	Band Width	Modulation	RB Configuration		Tune-up (dBm)	Channel/Frequency(MHz)		
			RB Size	RB Offset		20425/826.5	20525/836.5	20625/846.5
LTE Band 5	5MHz	QPSK	1	0	24.00	23.31	23.52	23.38
			1	12	24.00	23.22	23.47	23.32
			1	24	24.00	23.34	23.55	23.42
			12	0	23.00	22.54	22.46	22.49
			12	6	23.00	22.36	22.41	22.58
			12	11	23.00	22.31	22.46	22.46
			25	0	23.00	22.30	22.41	22.55

Band	Band Width	Modulation	RB Configuration		Tune-up (dBm)	Channel/Frequency(MHz)		
			RB Size	RB Offset		20450/829	20525/836.5	20600/844
LTE Band 5	10MHz	16QAM	1	0	23.00	22.69	22.11	22.45
			1	12	23.00	22.59	22.02	22.48
			1	24	23.00	22.62	22.13	22.49
			12	0	22.00	21.44	21.32	21.89
			12	6	22.00	21.29	21.37	21.55
			12	11	22.00	21.40	21.33	21.57
			25	0	22.00	21.51	21.58	21.45
		QPSK	1	0	24.00	23.39	23.36	23.60
			1	24	24.00	23.41	23.36	23.58
			1	49	24.00	23.46	23.39	23.66
			25	0	23.00	22.50	22.48	22.53
			25	12	23.00	22.34	22.34	22.57
			25	24	23.00	22.54	22.44	22.52
			50	0	22.50	22.33	22.33	22.42
16QAM	1	0	24.00	23.53	23.08	22.77		
	1	24	24.00	23.53	23.09	22.79		
	1	49	24.00	23.48	23.07	22.87		
	25	0	22.00	21.40	21.51	21.49		
	25	12	22.00	21.34	21.57	21.56		
	25	24	22.00	21.39	21.56	21.60		

Band	Band Width	Modulation	RB Configuration		Tune-up (dBm)	Channel/Frequency(MHz)		
			RB Size	RB Offset		20775/2502.5	21100/2535	21425/2567.5
LTE Band 7	5MHz	QPSK	1	0	24.00	22.49	23.42	23.33
			1	12	24.00	23.12	23.70	23.51
			1	24	24.00	22.86	23.11	22.73
			12	0	23.50	22.84	23.18	23.06
			12	6	23.50	23.04	23.24	23.07
			12	11	23.50	23.01	23.24	23.07
			25	0	23.50	22.90	23.32	23.23
		16QAM	1	0	23.50	22.83	23.04	23.49
			1	12	23.50	23.32	23.07	23.33
			1	24	23.50	23.24	23.03	22.95
			12	0	22.50	22.28	22.31	22.37

Band	Band Width	Modulation	RB Configuration		Tune-up (dBm)	Channel/Frequency(MHz)		
			RB Size	RB Offset		20800/2505	21100/2535	21400/2565
			12	6	22.50	22.28	22.24	22.30
			12	11	22.50	22.27	22.38	22.31
			25	0	23.00	22.51	22.48	22.30
LTE Band 7	10MHz	QPSK	1	0	24.00	23.17	23.78	23.91
			1	24	24.00	23.47	23.69	23.79
			1	49	24.00	23.17	23.66	23.39
			25	0	23.50	23.08	23.23	23.20
			25	12	23.50	23.18	23.25	23.30
			25	24	23.50	23.15	23.30	23.15
			50	0	23.50	23.31	23.32	23.19
		16QAM	1	0	24.50	22.39	24.04	23.96
			1	24	24.50	23.11	23.98	23.84
			1	49	24.50	23.85	23.97	23.47
			25	0	22.50	22.40	22.23	22.38
			25	12	22.50	22.48	22.35	22.49
			25	24	22.50	22.49	22.37	22.36
Band	Band Width	Modulation	RB Configuration		Tune-up (dBm)	Channel/Frequency(MHz)		
			RB Size	RB Offset		20825/2507.5	21100/2535	21375/2562.5
LTE Band 7	15MHz	QPSK	1	0	24.50	22.67	24.01	23.89
			1	37	24.50	23.40	23.48	23.83
			1	74	24.50	24.15	23.21	23.02
			36	0	23.50	23.10	23.18	23.21
			36	18	23.50	23.23	23.32	23.27
			36	37	23.50	23.14	23.21	23.27
			75	0	23.50	23.31	23.19	23.21
		16QAM	1	0	24.50	22.96	24.08	23.96
			1	37	24.50	23.72	23.58	23.91
			1	74	24.50	24.46	23.33	23.13
			36	0	23.00	22.40	22.52	22.34
			36	18	23.00	22.42	22.52	22.32
			36	37	23.00	22.40	22.58	22.35
Band	Band Width	Modulation	RB Configuration		Tune-up (dBm)	Channel/Frequency(MHz)		
			RB	RB		20850/2510	21100/2535	21350/2560

			Size	Offset				
LTE Band 7	20MHz	QPSK	1	0	24.50	23.35	24.35	23.73
			1	49	24.50	24.17	23.70	23.98
			1	99	24.50	24.46	24.01	23.86
			50	0	23.50	23.17	23.25	23.19
			50	24	23.50	23.29	23.21	23.18
			50	49	23.50	23.28	23.25	23.34
			100	0	23.50	23.25	23.32	23.15
		16QAM	1	0	24.00	23.15	23.59	23.86
			1	49	24.00	23.80	23.56	23.74
			1	99	24.00	23.91	23.69	23.75
			50	0	23.00	22.48	22.49	22.39
			50	24	23.00	22.45	22.50	22.41
			50	49	23.00	22.43	22.47	22.43

Band	Band Width	Modulation	RB Configuration		Tune-up (dBm)	Channel/Frequency(MHz)		
			RB Size	RB Offset		26697/814.7	26740/819	26783/823.3
LTE Band 26a	1.4MHz	QPSK	1	0	21.00	20.95	18.39	19.61
			1	2	21.00	19.27	18.63	19.82
			1	5	21.00	19.19	18.52	19.63
			3	0	20.00	19.26	18.48	19.71
			3	1	20.00	19.30	18.56	19.78
			3	2	20.00	19.21	18.55	19.73
			6	0	22.00	21.90	21.80	21.69
		16QAM	1	0	19.00	17.87	16.98	18.32
			1	2	19.00	18.16	17.35	18.54
			1	5	19.00	18.06	17.29	18.33
			3	0	19.00	18.16	17.57	18.56
			3	1	19.00	18.25	17.69	18.61
			3	2	19.00	18.23	17.72	18.53
			6	0	21.50	21.08	20.87	20.81
Band	Band Width	Modulation	RB Configuration		Tune-up (dBm)	Channel/Frequency(MHz)		
			RB Size	RB Offset		26705/818.5	26740/819	26775/822.5
LTE Band	3MHz	QPSK	1	0	20.00	19.04	17.99	19.14
			1	7	20.00	19.19	18.49	19.66

26a			1	14	20.00	19.27	18.64	19.54
			8	0	22.00	21.77	21.73	21.73
			8	4	22.00	21.75	21.77	21.69
			8	7	22.00	21.79	21.75	21.71
			15	0	22.00	21.78	21.73	21.80
		16QAM	1	0	18.50	17.95	16.91	17.78
			1	7	18.50	18.33	17.58	18.23
			1	14	18.50	18.36	17.75	17.96
			8	0	21.00	20.76	20.88	20.80
			8	4	21.00	20.78	20.93	20.92
			8	7	21.00	20.72	20.87	20.78
			15	0	21.00	20.91	20.84	20.79
			Band	Band Width	Modulation	RB Configuration		Tune-up (dBm)
RB Size	RB Offset	26715/816.5				26740/819	26765/821.5	
LTE Band 26a	5MHz	QPSK	1	0	19.50	18.63	17.50	18.00
			1	12	19.50	19.12	18.44	19.29
			1	24	19.50	19.00	18.70	19.11
			12	0	22.00	21.84	21.78	21.74
			12	6	22.00	21.79	21.81	21.72
			12	11	22.00	21.77	21.71	21.70
			25	0	22.00	21.85	21.86	21.77
		16QAM	1	0	19.00	17.74	16.51	17.16
			1	12	19.00	18.54	17.69	18.46
			1	24	19.00	18.62	17.92	18.07
			12	0	21.00	20.68	20.61	20.74
			12	6	21.00	20.74	20.72	20.73
			12	11	21.00	20.61	20.57	20.77
			25	0	21.00	20.90	20.86	20.85
Band	Band Width	Modulation	RB Configuration		Tune-up (dBm)	Channel/Frequency(MHz)		
			RB Size	RB Offset		/	26740/819	/
LTE Band 26a	10MHz	QPSK	1	0	20.00	/	17.70	/
			1	24	20.00	/	18.42	/
			1	49	20.00	/	19.84	/
			25	0	22.00	/	21.79	/
			25	12	22.00	/	21.86	/
			25	24	22.00	/	21.80	/

			50	0	22.50	/	21.86	/
		16QAM	1	0	19.00	/	16.62	/
			1	24	19.00	/	17.74	/
			1	49	19.00	/	18.81	/
			25	0	22.00	/	20.87	/
			25	12	22.00	/	20.88	/
			25	24	22.00	/	20.75	/
			50	0	22.00	/	20.80	/

Band	Band Width	Modulation	RB Configuration		Tune-up (dBm)	Channel/Frequency(MHz)		
			RB Size	RB Offset		26797/824.7	26915/836.5	27033/848.3
LTE Band 26b	1.4MHz	QPSK	1	0	23.50	23.26	23.04	23.20
			1	2	23.50	23.19	22.97	23.25
			1	5	23.50	23.17	22.95	23.22
			3	0	23.50	23.12	22.99	23.07
			3	1	23.50	23.14	23.09	23.08
			3	2	23.50	23.10	22.98	23.09
		16QAM	6	0	22.50	22.08	22.00	22.02
			1	0	24.00	23.20	22.69	23.58
			1	2	24.00	23.17	22.75	23.10
			1	5	24.00	23.18	22.72	23.07
			3	0	23.00	22.46	22.13	22.95
			3	1	23.00	22.41	22.15	22.62
			3	2	23.00	22.39	22.12	22.56
			6	0	21.50	21.21	20.98	21.19

Band	Band Width	Modulation	RB Configuration		Tune-up (dBm)	Channel/Frequency(MHz)		
			RB Size	RB Offset		26805/825.5	26915/836.5	27025/847.5
LTE Band 26b	3MHz	QPSK	1	0	23.50	23.22	22.97	23.21
			1	7	23.50	23.22	22.91	23.15
			1	14	23.50	23.31	22.96	23.24
			8	0	22.50	22.13	21.94	22.32
			8	4	22.50	22.13	21.94	22.25
			8	7	22.50	22.07	22.07	21.93
			15	0	22.50	22.13	21.93	22.27
		16QAM	1	0	24.00	23.09	22.62	23.51
			1	7	24.00	23.06	22.64	23.44

Band	Band Width	Modulation	RB Configuration		Tune-up (dBm)	Channel/Frequency(MHz)		
			RB Size	RB Offset		26815/826.5	26915/836.5	27015/846.5
			1	14	24.00	23.05	22.73	22.94
			8	0	22.00	21.04	21.58	21.34
			8	4	22.00	21.06	21.24	21.32
			8	7	22.00	21.00	21.23	20.96
			15	0	21.50	21.17	21.11	21.46
LTE Band 26b	5MHz	QPSK	1	0	23.50	23.01	23.07	22.86
			1	12	23.50	23.07	22.96	22.83
			1	24	23.50	23.01	23.06	22.83
			12	0	22.50	22.11	22.08	22.05
			12	6	22.50	22.15	22.06	22.27
			12	11	22.50	22.15	22.04	22.36
			25	0	22.50	22.03	22.05	22.30
		16QAM	1	0	22.50	22.35	21.70	22.03
			1	12	22.50	22.34	21.65	22.37
			1	24	22.50	22.36	21.75	22.00
			12	0	21.50	21.11	21.18	21.07
			12	6	21.50	21.04	20.93	21.38
			12	11	21.50	20.98	20.95	21.41
			25	0	21.50	21.18	21.14	21.38
Band	Band Width	Modulation	RB Configuration		Tune-up (dBm)	Channel/Frequency(MHz)		
			RB Size	RB Offset		26840/829	26915/836.5	26990/844
LTE Band 26b	10MHz	QPSK	1	0	23.50	23.06	22.98	23.15
			1	24	23.50	23.12	22.87	23.19
			1	49	23.50	23.02	23.06	23.19
			25	0	22.50	22.10	21.91	22.14
			25	12	22.50	22.05	21.94	22.05
			25	24	22.50	22.04	22.04	22.38
		16QAM	50	0	22.50	22.09	22.11	22.13
			1	0	23.50	23.14	22.69	22.44
			1	24	23.50	23.08	22.69	22.36
			1	49	23.50	23.19	22.68	22.40
			25	0	21.50	21.10	21.41	21.14
			25	12	21.50	21.33	21.09	21.11
			25	24	21.50	21.01	21.11	21.48

Band	Band Width	Modulation	RB Configuration		Tune-up (dBm)	Channel/Frequency(MHz)		
			RB Size	RB Offset		26865/831.5	26915/836.5	26965/841.5
			50	0	22.00	21.02	21.14	21.50
LTE Band 26b	15MHz	QPSK	1	0	23.50	23.28	23.41	22.99
			1	37	23.50	23.17	23.31	23.08
			1	74	23.50	23.11	23.35	23.01
			36	0	22.50	22.15	22.09	22.10
			36	18	22.50	22.06	22.03	22.10
			36	37	22.50	21.95	21.97	21.99
			75	0	22.50	22.04	22.06	21.95
		16QAM	1	0	23.50	22.83	23.13	22.65
			1	37	23.50	22.68	23.19	22.63
			1	74	23.50	22.61	23.14	22.73
			36	0	21.50	21.43	21.08	21.20
			36	18	21.50	21.09	21.08	21.20
			36	37	21.50	21.39	21.08	21.16
			75	0	21.50	21.41	21.12	21.20

Band	Band Width	Modulation	RB Configuration		Tune-up (dBm)	Channel/Frequency(MHz)		
			RB Size	RB Offset		37775/2572.5	38000/2595	38225/2617.5
LTE Band 38	5MHz	QPSK	1	0	24.00	23.67	23.77	23.80
			1	12	24.00	23.88	23.63	23.80
			1	24	24.00	23.58	23.66	23.85
			12	0	23.00	22.91	22.88	22.83
			12	6	23.00	22.92	22.90	22.86
			12	11	23.00	22.76	22.94	22.89
			25	0	23.00	22.78	22.92	22.88
		16QAM	1	0	23.50	22.58	22.59	23.26
			1	12	23.50	22.57	22.64	23.32
			1	24	23.50	22.53	22.64	23.34
			12	0	22.00	21.99	21.86	21.98
			12	6	22.00	21.97	21.86	21.93
			12	11	22.00	21.96	21.92	21.95
			25	0	22.50	22.09	22.10	22.19
Band	Band Width	Modulation	RB Configuration		Tune-up (dBm)	Channel/Frequency(MHz)		

Band	Band Width	Modulation	RB Configuration		Tune-up (dBm)	Channel/Frequency(MHz)		
			RB Size	RB Offset		37825/2577.5	38000/2595	38175/2615
LTE Band 38	10MHz	QPSK	1	0	24.50	37800/2575	38000/2595	38200/2615
			1	24	24.50	23.66	23.79	23.71
			1	49	24.50	23.92	23.81	23.78
			25	0	23.00	24.08	23.94	23.79
			25	12	23.00	22.76	22.88	22.88
			25	24	23.00	22.86	22.90	22.80
			25	24	23.00	22.99	22.92	22.90
		16QAM	50	0	23.00	22.87	22.92	22.84
			1	0	24.00	23.80	22.73	23.19
			1	24	24.00	23.86	22.78	23.03
			1	49	24.00	23.90	22.73	23.23
			25	0	22.50	21.98	22.09	22.10
			25	12	22.50	21.94	22.07	22.09
			25	24	22.50	21.97	22.15	22.17
50	0	22.50	21.98	22.18	22.20			
LTE Band 38	15MHz	QPSK	1	0	24.00	37825/2577.5	38000/2595	38175/2615
			1	37	24.00	23.77	23.81	23.92
			1	74	24.00	23.79	23.86	23.92
			36	0	23.00	23.81	23.87	23.92
			36	18	23.00	22.83	22.91	22.75
			36	18	23.00	22.79	22.84	22.80
			36	37	23.00	22.87	22.80	22.83
		16QAM	75	0	23.00	22.84	22.88	22.87
			1	0	24.00	23.87	22.65	23.01
			1	37	24.00	23.56	22.75	23.07
			1	74	24.00	23.63	22.78	23.13
			36	0	22.50	22.08	22.17	22.05
			36	18	22.50	22.03	22.07	22.10
			36	37	22.50	22.13	22.06	22.09
75	0	22.50	22.15	22.08	22.14			
LTE Band	20MHz	QPSK	RB Configuration		Tune-up (dBm)	Channel/Frequency(MHz)		
			RB Size	RB Offset		37850/2580	38000/2595	38150/2610
LTE Band	20MHz	QPSK	1	0	24.50	37850/2580	38000/2595	38150/2610
			1	49	24.50	23.75	23.87	23.70
LTE Band	20MHz	QPSK	1	0	24.50	23.75	23.87	23.70
			1	49	24.50	23.76	24.17	23.69

38			1	99	24.50	23.80	24.13	23.70	
			50	0	23.50	22.83	22.90	22.76	
			50	24	23.50	22.95	22.88	22.91	
			50	49	23.50	23.04	22.95	22.84	
			100	0	23.00	22.81	22.94	22.85	
	16QAM			1	0	23.50	22.99	22.72	22.85
				1	49	23.50	22.98	22.69	22.72
				1	99	23.50	23.04	22.48	22.75
				50	0	22.50	22.21	21.98	22.10
				50	24	22.50	22.31	22.04	22.15
				50	49	22.50	22.29	22.07	22.16
				100	0	22.50	22.33	22.17	22.21

Band	Band Width	Modulation	RB Configuration		Tune-up (dBm)	Channel/Frequency(MHz)				
			RB Size	RB Offset		131979/1710.7	132322/1745	132665/1779.3		
LTE Band 66	1.4MHz	QPSK	1	0	25.00	24.66	24.43	24.48		
			1	2	25.00	24.68	24.47	24.43		
			1	5	25.00	0.00	24.47	24.47		
			3	0	25.00	24.50	24.48	24.30		
			3	1	25.00	24.54	24.51	24.50		
			3	2	25.00	24.48	24.44	24.40		
			6	0	23.50	23.40	23.40	23.37		
		16QAM			1	0	25.00	24.65	24.29	23.74
					1	2	25.00	24.60	24.21	23.81
					1	5	25.00	24.59	24.25	23.68
					3	0	24.00	23.89	23.96	23.81
					3	1	24.00	23.82	23.92	23.81
					3	2	24.00	23.81	23.99	23.82
					6	0	23.00	22.66	22.57	22.67
Band	Band Width	Modulation	RB Configuration		Tune-up (dBm)	Channel/Frequency(MHz)				
			RB Size	RB Offset		131987/1711.5	132322/1745	132657/1778.5		
LTE Band 66	3MHz	QPSK	1	0	25.00	24.52	24.45	24.52		
			1	7	25.00	24.57	24.42	24.47		
			1	14	25.00	24.55	24.42	24.45		
			8	0	24.00	23.48	23.50	23.37		
			8	4	24.00	23.55	23.52	23.38		

Band	Band Width	Modulation	RB Configuration		Tune-up (dBm)	Channel/Frequency(MHz)		
			RB Size	RB Offset		131997/1712.5	132322/1745	132647/1777.5
		16QAM	8	7	24.00	23.55	23.44	23.31
			15	0	23.50	23.43	23.48	23.36
			1	0	25.00	24.74	24.32	23.82
			1	7	25.00	24.64	24.24	23.77
			1	14	25.00	24.65	24.25	23.73
			8	0	23.00	22.56	22.79	22.51
			8	4	23.00	22.52	22.81	22.52
			8	7	23.00	22.52	22.75	22.48
			15	0	23.00	22.75	22.63	22.60
LTE Band 66	5MHz	QPSK	1	0	25.00	24.36	24.63	24.17
			1	12	25.00	24.33	24.50	24.17
			1	24	25.00	24.33	24.52	24.24
			12	0	24.00	23.50	23.50	23.33
			12	6	24.00	23.48	23.33	23.33
			12	11	24.00	23.41	23.46	23.31
			25	0	23.50	23.44	23.45	23.35
		16QAM	1	0	24.00	23.85	23.28	23.34
			1	12	24.00	23.90	23.20	23.40
			1	24	24.00	23.88	23.21	23.40
			12	0	23.00	22.55	22.43	22.51
			12	6	23.00	22.53	22.41	22.48
			12	11	23.00	22.48	22.41	22.39
			25	0	23.00	22.62	22.63	22.49
			LTE Band 66	10MHz	QPSK	1	0	25.00
1	24	25.00				24.44	24.60	24.36
1	49	25.00				24.47	24.57	24.35
25	0	23.50				23.40	23.40	23.43
25	12	23.50				23.36	23.39	23.42
25	24	23.50				23.40	23.38	23.34
50	0	23.50				23.38	23.39	23.36
16QAM	1	0			25.00	23.96	24.71	24.06
	1	24			25.00	24.02	24.68	24.04

Band	Band Width	Modulation	RB Configuration		Tune-up (dBm)	Channel/Frequency(MHz)		
			RB Size	RB Offset		132047/1717.5	132322/1745	132597/1772.5
			1	49	25.00	24.01	24.65	23.98
			25	0	23.00	22.71	22.58	22.57
			25	12	23.00	22.70	22.58	22.54
			25	24	23.00	22.64	22.48	22.58
LTE Band 66	15MHz	QPSK	1	0	25.00	24.53	24.53	24.22
			1	37	25.00	24.43	24.43	24.25
			1	74	25.00	24.49	24.36	24.23
			36	0	24.00	23.45	23.51	23.33
			36	18	24.00	23.42	23.46	23.43
			36	37	24.00	23.53	23.30	23.32
			75	0	23.50	23.43	23.36	23.32
		16QAM	1	0	25.00	24.69	24.11	24.20
			1	37	25.00	24.60	23.99	24.17
			1	74	25.00	24.63	23.95	24.21
			36	0	23.00	22.65	22.74	22.43
			36	18	23.00	22.75	22.71	22.48
			36	37	23.00	22.64	22.68	22.47
Band	Band Width	Modulation	RB Configuration		Tune-up (dBm)	Channel/Frequency(MHz)		
			RB Size	RB Offset		132072/1720	132322/1745	132572/1770
LTE Band 66	20MHz	QPSK	1	0	25.00	24.69	24.38	24.50
			1	49	25.00	24.60	24.27	24.52
			1	99	25.00	24.70	24.23	24.58
			50	0	24.00	23.45	23.46	23.38
			50	24	24.00	23.46	23.54	23.27
			50	49	24.00	23.49	23.47	23.28
			100	0	23.50	23.49	23.42	23.26
		16QAM	1	0	24.50	23.30	24.27	23.25
			1	49	24.50	23.26	24.19	23.22
			1	99	24.50	23.33	24.07	23.27
			50	0	23.00	22.74	22.72	22.45
			50	24	23.00	22.69	22.60	22.45
			50	49	23.00	22.76	22.54	22.47

7.4. Bluetooth Output Power

BR+EDR	Output Power (dBm)				
	Data Rates	Tune-up (dBm)	Channel		
			0CH	39CH	78CH
1M	7.50	6.51	7.13	6.44	
2M	9.00	8.93	8.71	7.18	
3M	9.00	8.94	8.70	7.17	

NOTE: Power measurement results of Bluetooth.

8. Stand-alone SAR test exclusion

Refer to FCC KDB 447498D01, the 1-g SAR and 10-g SAR test exclusion thresholds for 100 MHz to 6 GHz at test separation distances ≤ 50 mm are determined by:

$[(\text{max. power of channel, including tune-up tolerance, mW}) / (\text{min. test separation distance, mm})] \cdot [\sqrt{f_{\text{(GHz)}}}] \leq 3.0$ for 1-g SAR and ≤ 7.5 for 10-g extremity SAR, where:

- $f_{\text{(GHz)}}$ is the RF channel transmit frequency in GHz
- Power and distance are rounded to the nearest mW and mm before calculation
- The result is rounded to one decimal place for comparison

When the minimum test separation distance is < 5 mm, a distance of 5 mm is applied to determine SAR test exclusion.

Mode	P_{max} (dBm)	P_{max} (mW)	Distance (mm)	f (GHz)	Calculation Result	SAR Exclusion threshold	SAR test exclusion
Bluetooth	9.00	7.94	5	2.480	2.5	3.0	Yes

NOTE: Standalone SAR test exclusion for Bluetooth.

When standalone SAR test exclusion applies to an antenna that transmits simultaneously with other antennas, the standalone SAR must be estimated according to following to determine simultaneous transmission SAR test exclusion:

$[(\text{max. power of channel, including tune-up tolerance, mW}) / (\text{min. test separation distance, mm})] \cdot [\sqrt{f_{\text{(GHz)}}} / x] \text{ W/kg}$ for test separation distances ≤ 50 mm, where $x = 7.5$ for 1-g SAR and $x = 18.75$ for 10-g SAR.

When the minimum test separation distance is < 5 mm, a distance of 5 mm is applied to determine SAR test exclusion.

Mode	Position	P_{max} (dBm)	P_{max} (mW)	Distance (mm)	f (GHz)	x	Estimated SAR (W/Kg)
Bluetooth	Head	9.00	7.94	5	2.48	7.5	0.334
Bluetooth	Body	9.00	7.94	10	2.48	7.5	0.167

NOTE: Estimated SAR calculation for Bluetooth

9. SAR Results

9.1. SAR measurement Result

9.1.1. SAR measurement Result of GSM850

Test Position of Head	Test channel /Freq.	Mode	SAR Value (W/kg)		Power Drift(%)	Conducted Power (dBm)	Tune-up Power (dBm)	Scaled SAR 1-g (W/Kg)	Date	Plot
			1-g	10-g						
Left Cheek	189/836.4	GPRS(GMSK 3TS)	0.622	0.328	-3.21	29.57	30.00	0.687	2022/12/12	1#
Left Tilt 15 Degree	189/836.4	GPRS(GMSK 3TS)	0.366	0.191	1.84	29.57	30.00	0.404	2022/12/12	
Right Cheek	189/836.4	GPRS(GMSK 3TS)	0.591	0.312	-3.82	29.57	30.00	0.653	2022/12/12	
Right Tilt 15 Degree	189/836.4	GPRS(GMSK 3TS)	0.325	0.165	-2.91	29.57	30.00	0.359	2022/12/12	

NOTE: Head SAR test results of GSM850.

Test Position of Body-Worn with 10mm	Test channel /Freq.	Mode	SAR Value (W/kg)		Power Drift(%)	Conducted Power (dBm)	Tune-up Power (dBm)	Scaled SAR 1-g (W/Kg)	Date	Plot
			1-g	10-g						
Front Side	189/836.4	GPRS(GMSK 3TS)	0.126	0.087	-1.26	29.57	30.00	0.139	2022/12/12	
Back Side	189/836.4	GPRS(GMSK 3TS)	0.196	0.136	0.86	29.57	30.00	0.216	2022/12/12	2#

NOTE: Body-Worn SAR test results of GSM850

9.1.2. SAR measurement Result of GSM1900

Test Position of Head	Test channel /Freq.	Mode	SAR Value (W/kg)		Power Drift(%)	Conducted Power (dBm)	Tune-up Power (dBm)	Scaled SAR 1-g (W/Kg)	Date	Plot
			1-g	10-g						
Left Cheek	661/1880	GPRS(GMSK 3TS)	0.232	0.138	0.45	27.28	27.50	0.244	2022/12/09	3#
Left Tilt 15 Degree	661/1880	GPRS(GMSK 3TS)	0.136	0.078	1.40	27.28	27.50	0.143	2022/12/09	
Right Cheek	661/1880	GPRS(GMSK 3TS)	0.207	0.123	1.14	27.28	27.50	0.218	2022/12/09	

		3TS)								
Right Tilt 15 Degree	661/1880	GPRS(GMSK 3TS)	0.097	0.055	1.40	27.28	27.50	0.102	2022/12/09	

NOTE: Head SAR test results of GSM1900

Test Position of Body-Worn with 10mm	Test channel /Freq.	Mode	SAR Value (W/kg)		Power Drift(%)	Conducted Power (dBm)	Tune-up Power (dBm)	Scaled SAR 1-g (W/Kg)	Date	Plot
			1-g	10-g						
Front Side	661/1880	GPRS(GMSK 3TS)	0.516	0.264	-1.51	27.28	27.50	0.543	2022/12/09	
Back Side	661/1880	GPRS(GMSK 3TS)	0.814	0.420	-0.12	27.28	27.50	0.856	2022/12/09	
Back Side	512/1850.2	GPRS(GMSK 3TS)	0.878	0.433	-1.62	27.25	27.50	0.930	2022/12/09	
Back Side	810/1909.8	GPRS(GMSK 3TS)	0.885	0.359	-3.56	27.28	27.50	0.931	2022/12/09	4#
Back Side Repeated	810/1909.8	GPRS(GMSK 3TS)	0.876	0.350	1.20	27.28	27.50	0.922	2022/12/09	

NOTE: Body-Worn SAR test results of GSM1900

9.1.3. SAR measurement Result of WCDMA Band 2

Test Position of Head	Test channel /Freq	Mode	SAR Value (W/kg)		Power Drift(%)	Conducted Power (dBm)	Tune-up Power (dBm)	Scaled SAR 1-g (W/Kg)	Date	Plot
			1-g	10-g						
Left Cheek	9400/1880	RMC12.2K	0.949	0.668	-1.89	23.50	24.00	1.065	2022/12/09	5#
Left Cheek Repeated	9400/1880	RMC12.2K	0.940	0.661	0.23	23.50	24.00	1.055	2022/12/09	
Left Tilt 15 Degree	9400/1880	RMC12.2K	0.549	0.375	3.87	23.50	24.00	0.616	2022/12/09	
Right Cheek	9400/1880	RMC12.2K	0.869	0.593	2.55	23.50	24.00	0.975	2022/12/09	
Right Tilt 15 Degree	9400/1880	RMC12.2K	0.410	0.283	0.94	23.50	24.00	0.460	2022/12/09	
Left Cheek	9262/1852.4	RMC12.2K	0.797	0.533	-0.36	23.39	24.00	0.917	2022/12/09	
Left Cheek	9538/1907.6	RMC12.2K	0.845	0.577	0.67	23.48	24.00	0.952	2022/12/09	

NOTE: Head SAR test results of WCDMA Band 2

Test Position of Body-Worn with 10mm	Test channel /Freq.	Mode	SAR Value (W/kg)		Power Drift(%)	Conducted Power (dBm)	Tune-up Power (dBm)	Scaled SAR 1-g (W/Kg)	Date	Plot
			1-g	10-g						
Front Side	9400/1880	RMC12.2K	0.348	0.174	-3.82	23.50	24.00	0.390	2022/12/09	
Back Side	9400/1880	RMC12.2K	0.553	0.280	0.62	23.50	24.00	0.620	2022/12/09	6#

NOTE: Body-Worn SAR test results of WCDMA Band 2

9.1.4. SAR measurement Result of WCDMA Band 4

Test Position of Head	Test channel /Freq	Mode	SAR Value (W/kg)		Power Drift(%)	Conducted Power (dBm)	Tune-up Power (dBm)	Scaled SAR 1-g (W/Kg)	Date	Plot
			1-g	10-g						
Left Cheek	1413/1732.6	RMC12.2K	0.688	0.387	-0.47	23.74	24.00	0.730	2022/12/16	7#
Left Tilt 15 Degree	1413/1732.6	RMC12.2K	0.411	0.231	-1.97	23.74	24.00	0.436	2022/12/16	
Right Cheek	1413/1732.6	RMC12.2K	0.596	0.318	3.81	23.74	24.00	0.633	2022/12/16	
Right Tilt 15 Degree	1413/1732.6	RMC12.2K	0.272	0.148	2.08	23.74	24.00	0.289	2022/12/16	

NOTE: Head SAR test results of WCDMA Band 4

Test Position of Body-Worn with 10mm	Test channel /Freq	Mode	SAR Value (W/kg)		Power Drift(%)	Conducted Power (dBm)	Tune-up Power (dBm)	Scaled SAR 1-g (W/Kg)	Date	Plot
			1-g	10-g						
Front Side	1413/1732.6	RMC12.2K	0.456	0.245	-3.99	23.74	24.00	0.484	2022/12/16	
Back Side	1413/1732.6	RMC12.2K	0.732	0.402	0.36	23.74	24.00	0.777	2022/12/16	8#

NOTE: Body-Worn SAR test results of WCDMA Band 4

9.1.5. SAR measurement Result of WCDMA Band 5

Test Position of Head	Test channel /Freq	Mode	SAR Value (W/kg)		Power Drift(%)	Conducted Power (dBm)	Tune-up Power (dBm)	Scaled SAR 1-g (W/Kg)	Date	Plot
			1-g	10-g						
Left Cheek	4182/836.4	RMC12.2K	0.289	0.165	-1.21	22.83	23.00	0.301	2022/12/12	9#
Left Tilt 15	4182/836.4	RMC12.2K	0.168	0.096	3.76	22.83	23.00	0.175	2022/12/12	

Degree										
Right Cheek	4182/836.4	RMC12.2K	0.249	0.141	-1.59	22.83	23.00	0.259	2022/12/12	
Right Tilt 15 Degree	4182/836.4	RMC12.2K	0.117	0.065	1.20	22.83	23.00	0.122	2022/12/12	

NOTE: Head SAR test results of WCDMA Band 5

Test Position of Body-Worn with 10mm	Test channel /Freq.	Mode	SAR Value (W/kg)		Power Drift(%)	Conducted Power (dBm)	Tune-up Power (dBm)	Scaled SAR 1-g (W/Kg)	Date	Plot
			1-g	10-g						
Front Side	4182/836.4	RMC12.2K	0.402	0.266	-1.28	22.83	23.00	0.418	2022/12/12	
Back Side	4182/836.4	RMC12.2K	0.644	0.440	-0.65	22.83	23.00	0.670	2022/12/12	10#

NOTE: Body-Worn SAR test results of WCDMA Band 5

9.1.6. SAR measurement Result of LTE Band 2

Test Position of Head	Test channel /Freq.	Mode	SAR Value (W/kg)		Power Drift(%)	Conducted Power (dBm)	Tune-up Power (dBm)	Scaled SAR 1-g (W/Kg)	Date	Plot
			1-g	10-g						
1RB										
Left Cheek	18900/1880	20M QPSK(1,99)	0.751	0.557	-2.49	24.07	24.50	0.829	2022/12/09	
Left Tilt 15 Degree	18900/1880	20M QPSK(1,99)	0.413	0.295	3.03	24.07	24.50	0.456	2022/12/09	
Right Cheek	18900/1880	20M QPSK(1,99)	0.731	0.534	1.37	24.07	24.50	0.807	2022/12/09	
Right Tilt 15 Degree	18900/1880	20M QPSK(1,99)	0.365	0.261	-0.35	24.07	24.50	0.403	2022/12/09	
Left Cheek	18700/1860	20M QPSK(1,99)	0.812	0.605	-3.42	24.35	24.50	0.841	2022/12/09	11#
Left Cheek Repeated	18700/1860	20M QPSK(1,99)	0.806	0.597	0.32	24.35	24.50	0.834	2022/12/09	
Left Cheek	19100/1900	20M QPSK(1,99)	0.690	0.494	-2.20	24.30	24.50	0.723	2022/12/09	
50%RB										
Left Cheek	18900/1880	20M QPSK(50,24)	0.439	0.318	3.16	23.10	23.50	0.481	2022/12/09	
Left Tilt 15	18900/1880	20M	0.226	0.166	0.71	23.10	23.50	0.248	2022/12/09	

Degree		QPSK(50,24)								
Right Cheek	18900/1880	20M QPSK(50,24)	0.434	0.295	4.09	23.10	23.50	0.476	2022/12/09	
Right Tilt 15 Degree	18900/1880	20M QPSK(50,24)	0.206	0.134	-2.36	23.10	23.50	0.226	2022/12/09	
100%RB										
Left Cheek	18900/1880	20M QPSK(100,0)	0.425	0.310	0.23	23.06	23.50	0.470	2022/12/09	

NOTE: Head SAR test results of LTE Band 2

Test Position of Body-Worn with 10mm	Test channel /Freq.	Mode	SAR Value (W/kg)		Power Drift(%)	Conducted Power (dBm)	Tune-up Power (dBm)	Scaled SAR 1-g (W/Kg)	Date	Plot
			1-g	10-g						
1RB										
Front Side	18900/1880	20M QPSK(1,99)	0.378	0.191	-2.11	24.07	24.50	0.417	2022/12/09	
Back Side	18900/1880	20M QPSK(1,99)	0.622	0.314	1.17	24.07	24.50	0.687	2022/12/09	12#
50%RB										
Front Side	18900/1880	20M QPSK(50,24)	0.214	0.100	0.22	23.10	23.50	0.235	2022/12/09	
Back Side	18900/1880	20M QPSK(50,24)	0.316	0.171	-2.24	23.10	23.50	0.346	2022/12/09	

NOTE: Body-Worn SAR test results of LTE Band 2

9.1.7. SAR measurement Result of LTE Band 4

Test Position of Head	Test channel /Freq.	Mode	SAR Value (W/kg)		Power Drift(%)	Conducted Power (dBm)	Tune-up Power (dBm)	Scaled SAR 1-g (W/Kg)	Date	Plot
			1-g	10-g						
1RB										
Left Cheek	20175/1732.5	20M QPSK(1,99)	0.644	0.360	1.65	24.24	25.00	0.767	2022/12/16	13#
Left Tilt 15 Degree	20175/1732.5	20M QPSK(1,99)	0.381	0.211	3.72	24.24	25.00	0.454	2022/12/16	
Right	20175/1732.5	20M	0.561	0.314	2.59	24.24	25.00	0.668	2022/12/16	

Cheek		QPSK(1,99)								
Right Tilt 15 Degree	20175/1732.5	20M QPSK(1,99)	0.278	0.154	1.25	24.24	25.00	0.331	2022/12/16	
50%RB										
Left Cheek	20175/1732.5	20M QPSK(50,0)	0.365	0.215	-1.21	23.18	23.50	0.393	2022/12/16	
Left Tilt 15 Degree	20175/1732.5	20M QPSK(50,0)	0.217	0.125	3.48	23.18	23.50	0.234	2022/12/16	
Right Cheek	20175/1732.5	20M QPSK(50,0)	0.296	0.169	4.18	23.18	23.50	0.319	2022/12/16	
Right Tilt 15 Degree	20175/1732.5	20M QPSK(50,0)	0.158	0.084	0.45	23.18	23.50	0.170	2022/12/16	

NOTE: Head SAR test results of LTE Band 4

Test Position of Body-Worn with 10mm	Test channel /Freq.	Mode	SAR Value (W/kg)		Power Drift(%)	Conducted Power (dBm)	Tune-up Power (dBm)	Scaled SAR 1-g (W/Kg)	Date	Plot
			1-g	10-g						
1RB										
Front Side	20175/1732.5	20M QPSK(1,99)	0.522	0.270	2.50	24.24	25.00	0.622	2022/12/16	
Back Side	20175/1732.5	20M QPSK(1,99)	0.865	0.462	1.63	24.24	25.00	1.030	2022/12/16	14#
Back Side	20050/1720	20M QPSK(1,99)	0.890	0.478	-4.05	24.53	25.00	0.992	2022/12/16	
Back Side Repeated	20050/1720	20M QPSK(1,99)	0.880	0.465	1.32	24.53	25.00	0.981	2022/12/16	
Back Side	20300/1745	20M QPSK(1,99)	0.833	0.450	-1.45	24.21	25.00	0.999	2022/12/16	
50%RB										
Front Side	20175/1732.5	20M QPSK(50,0)	0.303	0.140	-4.16	23.18	23.50	0.326	2022/12/16	
Back Side	20175/1732.5	20M QPSK(50,0)	0.457	0.271	2.49	23.18	23.50	0.492	2022/12/16	
100%RB										
Back Side	20175/1732.5	20M QPSK(100,0)	0.430	0.260	1.32	23.30	23.50	0.450	2022/12/16	

NOTE: Body-Worn SAR test results of LTE Band 4

9.1.8. SAR measurement Result of LTE Band 5

Test Position of Head	Test channel /Freq.	Mode	SAR Value (W/kg)		Power Drift(%)	Conducted Power (dBm)	Tune-up Power (dBm)	Scaled SAR 1-g (W/Kg)	Date	Plot
			1-g	10-g						
1RB										
Left Cheek	20525/836.5	10M QPSK(1,49)	0.351	0.192	-2.01	23.39	24.00	0.404	2022/12/12	15#
Left Tilt 15 Degree	20525/836.5	10M QPSK(1,49)	0.193	0.102	0.08	23.39	24.00	0.222	2022/12/12	
Right Cheek	20525/836.5	10M QPSK(1,49)	0.318	0.169	3.20	23.39	24.00	0.366	2022/12/12	
Right Tilt 15 Degree	20525/836.5	10M QPSK(1,49)	0.171	0.092	-2.80	23.39	24.00	0.197	2022/12/12	
50%RB										
Left Cheek	20525/836.5	10M QPSK(25,12)	0.192	0.097	-4.71	22.34	23.00	0.224	2022/12/12	
Left Tilt 15 Degree	20525/836.5	10M QPSK(25,12)	0.111	0.055	2.95	22.34	23.00	0.129	2022/12/12	
Right Cheek	20525/836.5	10M QPSK(25,12)	0.160	0.091	2.25	22.34	23.00	0.186	2022/12/12	
Right Tilt 15 Degree	20525/836.5	10M QPSK(25,12)	0.098	0.049	0.67	22.34	23.00	0.114	2022/12/12	

NOTE: Head SAR test results of LTE Band 5

Test Position of Body-Worn with 10mm	Test channel /Freq.	Mode	SAR Value (W/kg)		Power Drift(%)	Conducted Power (dBm)	Tune-up Power (dBm)	Scaled SAR 1-g (W/Kg)	Date	Plot
			1-g	10-g						
1RB										
Front Side	20525/836.5	10M QPSK(1,49)	0.340	0.243	-2.87	23.39	24.00	0.391	2022/12/12	
Back Side	20525/836.5	10M QPSK(1,49)	0.763	0.493	0.40	23.39	24.00	0.878	2022/12/12	16#
Back Side	20450/829	10M QPSK(1,49)	0.610	0.374	0.97	23.46	24.00	0.691	2022/12/12	
Back Side	20600/844	10M	0.656	0.407	3.69	23.66	24.00	0.709	2022/12/12	

		QPSK(1,49)								
50%RB										
Front Side	20525/836.5	10M QPSK(25,12)	0.197	0.134	-0.34	22.34	23.00	0.229	2022/12/12	
Back Side	20525/836.5	10M QPSK(25,12)	0.416	0.290	-1.32	22.34	23.00	0.484	2022/12/12	
100%RB										
Back Side	20525/836.5	10M QPSK(50,0)	0.408	0.288	1.30	22.33	22.50	0.424	2022/12/12	

NOTE: Body-Worn SAR test results of LTE Band 5

9.1.9. SAR measurement Result of LTE Band 7

Test Position of Head	Test channel /Freq.	Mode	SAR Value (W/kg)		Power Drift(%)	Conducted Power (dBm)	Tune-up Power (dBm)	Scaled SAR 1-g (W/Kg)	Date	Plot
			1-g	10-g						
1RB										
Left Cheek	21100/2535	20M QPSK(1,99)	1.045	0.478	1.50	24.01	24.50	1.170	2022/12/08	
Left Tilt 15 Degree	21100/2535	20M QPSK(1,99)	0.616	0.255	0.76	24.01	24.50	0.690	2022/12/08	
Right Cheek	21100/2535	20M QPSK(1,99)	1.031	0.430	-0.48	24.01	24.50	1.154	2022/12/08	
Right Tilt 15 Degree	21100/2535	20M QPSK(1,99)	0.565	0.224	0.13	24.01	24.50	0.632	2022/12/08	
Left Cheek	20850/2510	20M QPSK(1,99)	1.185	0.488	-2.39	24.46	24.50	1.196	2022/12/08	17#
Left Cheek Repeated	20850/2510	20M QPSK(1,99)	1.120	0.470	1.30	24.46	24.50	1.130	2022/12/08	
Left Cheek	21350/2560	20M QPSK(1,99)	0.957	0.403	-3.40	23.86	24.50	1.109	2022/12/08	
50%RB										
Left Cheek	21100/2535	20M QPSK(50,49)	0.632	0.241	1.16	23.25	23.50	0.669	2022/12/08	
Left Tilt 15 Degree	21100/2535	20M QPSK(50,49)	0.322	0.129	2.34	23.25	23.50	0.341	2022/12/08	
Right Cheek	21100/2535	20M QPSK(50,49)	0.522	0.218	1.96	23.25	23.50	0.553	2022/12/08	

Right Tilt 15 Degree	21100/2535	20M QPSK(50,49)	0.326	0.113	4.77	23.25	23.50	0.345	2022/12/08	
100%RB										
Left Cheek	21100/2535	20M QPSK(100,0)	0.611	0.226	0.32	23.32	23.50	0.637	2022/12/08	

NOTE: Head SAR test results of LTE Band 7

Test Position of Body-Worn with 10mm	Test channel /Freq.	Mode	SAR Value (W/kg)		Power Drift(%)	Conducted Power (dBm)	Tune-up Power (dBm)	Scaled SAR 1-g (W/Kg)	Date	Plot
			1-g	10-g						
1RB										
Front Side	21100/2535	20M QPSK(1,99)	0.552	0.221	1.64	24.01	24.50	0.618	2022/12/08	
Back Side	21100/2535	20M QPSK(1,99)	0.872	0.368	-4.77	24.01	24.50	0.976	2022/12/08	
Back Side	20850/2510	20M QPSK(1,99)	0.809	0.340	-3.94	24.01	24.50	0.906	2022/12/08	
Back Side	21350/2560	20M QPSK(1,99)	0.965	0.397	-1.55	24.01	24.50	1.080	2022/12/08	18#
Back Side Repeated	21350/2560	20M QPSK(1,99)	0.958	0.390	0.20	24.01	24.50	1.072	2022/12/08	
50%RB										
Front Side	21100/2535	20M QPSK(50,49)	0.291	0.117	3.60	23.25	23.50	0.308	2022/12/08	
Back Side	21100/2535	20M QPSK(50,49)	0.481	0.201	3.46	23.25	23.50	0.510	2022/12/08	
100%RB										
Back Side	21100/2535	20M QPSK(100,0)	0.477	0.197	0.32	23.32	23.50	0.497	2022/12/08	

NOTE: Body-Worn SAR test results of LTE Band 7

9.1.10. SAR measurement Result of LTE Band 26A

Test Position of Head	Test channel /Freq.	Mode	SAR Value (W/kg)		Power Drift(%)	Conducted Power (dBm)	Tune-up Power (dBm)	Scaled SAR 1-g (W/Kg)	Date	Plot
			1-g	10-g						
1RB										
Left	26740/819	10M	0.472	0.271	0.03	19.84	20.00	0.490	2022/12/12	23#

Cheek		QPSK(1,0)								
Left Tilt 15 Degree	26740/819	10M QPSK(1,0)	0.239	0.136	-0.13	19.84	20.00	0.248	2022/12/12	
Right Cheek	26740/819	10M QPSK(1,0)	0.431	0.243	3.46	19.84	20.00	0.447	2022/12/12	
Right Tilt 15 Degree	26740/819	10M QPSK(1,0)	0.228	0.124	0.71	19.84	20.00	0.237	2022/12/12	
50%RB										
Left Cheek	26740/819	10M QPSK(25,12)	0.412	0.241	1.20	21.86	22.00	0.425	2022/12/12	
Left Tilt 15 Degree	26740/819	10M QPSK(25,12)	0.214	0.120	-3.86	21.86	22.00	0.221	2022/12/12	
Right Cheek	26740/819	10M QPSK(25,12)	0.378	0.218	2.26	21.86	22.00	0.390	2022/12/12	
Right Tilt 15 Degree	26740/819	10M QPSK(25,12)	0.213	0.115	1.59	21.86	22.00	0.220	2022/12/12	

NOTE: Head SAR test results of LTE Band 26A

Test Position of Body-worn with 10mm	Test channel /Freq.	Mode	SAR Value (W/kg)		Power Drift(%)	Conducted Power (dBm)	Tune-up Power (dBm)	Scaled SAR 1-g (W/Kg)	Date	Plot
			1-g	10-g						
1RB										
Front Side	26740/819	10M QPSK(1,0)	0.502	0.372	0.24	19.84	20.00	0.521	2022/12/12	
Back Side	26740/819	10M QPSK(1,0)	0.587	0.396	-1.04	19.84	20.00	0.609	2022/12/12	25#
50%RB										
Front Side	26740/819	10M QPSK(25,12)	0.441	0.322	1.15	21.86	22.00	0.455	2022/12/12	
Back Side	26740/819	10M QPSK(25,12)	0.494	0.348	3.25	21.86	22.00	0.510	2022/12/12	

NOTE: Body-worn SAR test results of LTE Band 26A

Test	Test	Mode	SAR Value	Power	Conducted	Tune-up	Scaled	Date	Plot
------	------	------	-----------	-------	-----------	---------	--------	------	------

Position of Hotspot with 10mm	channel /Freq.		(W/kg)		Drift(%)	Power (dBm)	Power (dBm)	SAR 1-g (W/Kg)		
			1-g	10-g						
1RB										
Front Side	26740/819	10M QPSK(1,0)	0.502	0.372	0.24	19.84	20.00	0.521	2022/12/12	
Back Side	26740/819	10M QPSK(1,0)	0.587	0.396	-1.04	19.84	20.00	0.609	2022/12/12	
50%RB										
Front Side	26740/819	10M QPSK(25,12)	0.441	0.322	1.15	21.86	22.00	0.455	2022/12/12	
Back Side	26740/819	10M QPSK(25,12)	0.494	0.348	3.25	21.86	22.00	0.510	2022/12/12	

NOTE: Hotspot SAR test results of LTE Band 26A

9.1.11. SAR measurement Result of LTE Band 26B

Test Position of Head	Test channel /Freq.	Mode	SAR Value (W/kg)		Power Drift(%)	Conducted Power (dBm)	Tune-up Power (dBm)	Scaled SAR 1-g (W/Kg)	Date	Plot
			1-g	10-g						
1RB										
Left Cheek	26865/831.5	15M QPSK(1,0)	0.621	0.353	1.78	23.41	23.50	0.634	2022/12/12	24#
Left Tilt 15 Degree	26865/831.5	15M QPSK(1,0)	0.363	0.198	-0.13	23.41	23.50	0.371	2022/12/12	
Right Cheek	26865/831.5	15M QPSK(1,0)	0.567	0.306	2.46	23.41	23.50	0.579	2022/12/12	
Right Tilt 15 Degree	26865/831.5	15M QPSK(1,0)	0.310	0.174	-1.16	23.41	23.50	0.316	2022/12/12	
50%RB										
Left Cheek	26865/831.5	15M QPSK(36,0)	0.539	0.316	3.51	22.09	22.50	0.592	2022/12/12	
Left Tilt 15 Degree	26865/831.5	15M QPSK(36,0)	0.316	0.172	-2.57	22.09	22.50	0.347	2022/12/12	

Right Cheek	26865/831.5	15M QPSK(36,0)	0.519	0.281	-4.70	22.09	22.50	0.570	2022/12/12	
Right Tilt 15 Degree	26865/831.5	15M QPSK(36,0)	0.272	0.154	0.39	22.09	22.50	0.299	2022/12/12	

NOTE: Head SAR test results of LTE Band 26B

Test Position of Body-worn with 10mm	Test channel /Freq.	Mode	SAR Value (W/kg)		Power Drift(%)	Conducted Power (dBm)	Tune-up Power (dBm)	Scaled SAR 1-g (W/Kg)	Date	Plot
			1-g	10-g						
1RB										
Front Side	26865/831.5	15M QPSK(1,0)	0.600	0.438	0.28	23.41	23.50	0.613	2022/12/12	
Back Side	26865/831.5	15M QPSK(1,0)	0.719	0.478	-0.92	23.41	23.50	0.734	2022/12/12	26#
50%RB										
Front Side	26865/831.5	15M QPSK(36,0)	0.558	0.397	-3.72	22.09	22.50	0.613	2022/12/12	
Back Side	26865/831.5	15M QPSK(36,0)	0.636	0.417	-4.69	22.09	22.50	0.699	2022/12/12	

NOTE: Body-worn SAR test results of LTE Band 26B

Test Position of Hotspot with 10mm	Test channel /Freq.	Mode	SAR Value (W/kg)		Power Drift(%)	Conducted Power (dBm)	Tune-up Power (dBm)	Scaled SAR 1-g (W/Kg)	Date	Plot
			1-g	10-g						
1RB										
Front Side	26865/831.5	15M QPSK(1,0)	0.600	0.438	0.28	23.41	23.50	0.613	2022/12/12	
Back Side	26865/831.5	15M QPSK(1,0)	0.719	0.478	-0.92	23.41	23.50	0.734	2022/12/12	
50%RB										
Front Side	26865/831.5	15M QPSK(36,0)	0.558	0.397	-3.72	22.09	22.50	0.613	2022/12/12	
Back	26865/831.5	15M	0.636	0.417	-4.69	22.09	22.50	0.699	2022/12/12	

Side		QPSK(36,0)								
------	--	------------	--	--	--	--	--	--	--	--

NOTE: Hotspot SAR test results of LTE Band 26B

9.1.12. SAR measurement Result of LTE Band 38

Test Position of Head	Test channel /Freq.	Mode	SAR Value (W/kg)		Power Drift(%)	Conducted Power (dBm)	Tune-up Power (dBm)	Scaled SAR 1-g (W/Kg)	Date	Plot
			1-g	10-g						
1RB										
Left Cheek	38000/2595	20M QPSK(1,49)	0.078	0.035	0.63	24.17	24.50	0.084	2022/12/08	21#
Left Tilt 15 Degree	38000/2595	20M QPSK(1,49)	0.040	0.018	-2.95	24.17	24.50	0.043	2022/12/08	
Right Cheek	38000/2595	20M QPSK(1,49)	0.067	0.029	-0.26	24.17	24.50	0.072	2022/12/08	
Right Tilt 15 Degree	38000/2595	20M QPSK(1,49)	0.034	0.015	-1.78	24.17	24.50	0.037	2022/12/08	
50%RB										
Left Cheek	38000/2595	20M QPSK(50,0)	0.069	0.031	3.54	22.95	23.50	0.078	2022/12/08	
Left Tilt 15 Degree	38000/2595	20M QPSK(50,0)	0.035	0.016	3.96	22.95	23.50	0.040	2022/12/08	
Right Cheek	38000/2595	20M QPSK(50,0)	0.061	0.026	-2.28	22.95	23.50	0.069	2022/12/08	
Right Tilt 15 Degree	38000/2595	20M QPSK(50,0)	0.030	0.014	-2.67	22.95	23.50	0.034	2022/12/08	

NOTE: Head SAR test results of LTE Band 38

Test Position of Body-Worn with 10mm	Test channel /Freq.	Mode	SAR Value (W/kg)		Power Drift(%)	Conducted Power (dBm)	Tune-up Power (dBm)	Scaled SAR 1-g (W/Kg)	Date	Plot
			1-g	10-g						
1RB										
Front Side	38000/2595	20M QPSK(1,49)	0.230	0.146	0.08	24.17	24.50	0.248	2022/12/08	

Back Side	38000/2595	20M QPSK(1,49)	0.262	0.111	-1.60	24.17	24.50	0.283	2022/12/08	22#
50%RB										
Front Side	38000/2595	20M QPSK(50,0)	0200	0.155	-4.60	22.95	23.50	0.227	2022/12/08	
Back Side	38000/2595	20M QPSK(50,0)	0.229	0.097	-1.70	22.95	23.50	0.260	2022/12/08	

NOTE: Body-Worn SAR test results of LTE Band 38

Test Position of Hotspot with 10mm	Test channel /Freq.	Mode	SAR Value (W/kg)		Power Drift(%)	Conducted Power (dBm)	Tune-up Power (dBm)	Scaled SAR 1-g (W/Kg)	Date	Plot
			1-g	10-g						
1RB										
Front Side	38000/2595	20M QPSK(1,49)	0.600	0.186	0.08	24.17	24.50	0.647	2022/12/08	
Back Side	38000/2595	20M QPSK(1,49)	0.262	0.111	-1.60	24.17	24.50	0.283	2022/12/08	
50%RB										
Front Side	38000/2595	20M QPSK(50,0)	0.540	0.175	-4.60	22.95	23.50	0.613	2022/12/08	
Back Side	38000/2595	20M QPSK(50,0)	0.229	0.097	-1.70	22.95	23.50	0.260	2022/12/08	

NOTE: Hotspot SAR test results of LTE Band 38

9.1.13. SAR measurement Result of LTE Band 66

Test Position of Head	Test channel /Freq.	Mode	SAR Value (W/kg)		Power Drift(%)	Conducted Power (dBm)	Tune-up Power (dBm)	Scaled SAR 1-g (W/Kg)	Date	Plot
			1-g	10-g						
1RB										
Left Cheek	132322/1745	20M QPSK(1,99)	0.661	0.373	-0.03	24.23	25.00	0.789	2022/12/16	19#
Left Tilt 15 Degree	132322/1745	20M QPSK(1,99)	0.367	0.203	-3.82	24.23	25.00	0.438	2022/12/16	
Right	132322/1745	20M	0.624	0.352	0.57	24.23	25.00	0.745	2022/12/16	

Cheek		QPSK(1,99)								
Right Tilt 15 Degree	132322/1745	20M QPSK(1,99)	0.325	0.180	-0.60	24.23	25.00	0.388	2022/12/16	
50%RB										
Left Cheek	132322/1745	20M QPSK(50,24)	0.382	0.190	-2.50	23.54	24.00	0.425	2022/12/16	
Left Tilt 15 Degree	132322/1745	20M QPSK(50,24)	0.205	0.105	-2.89	23.54	24.00	0.228	2022/12/16	
Right Cheek	132322/1745	20M QPSK(50,24)	0.320	0.178	-3.33	23.54	24.00	0.356	2022/12/16	
Right Tilt 15 Degree	132322/1745	20M QPSK(50,24)	0.176	0.104	3.59	23.54	24.00	0.196	2022/12/16	

NOTE: Head SAR test results of LTE Band 66

Test Position of Body-Worn with 10mm	Test channel /Freq.	Mode	SAR Value (W/kg)		Power Drift(%)	Conducted Power (dBm)	Tune-up Power (dBm)	Scaled SAR 1-g (W/Kg)	Date	Plot
			1-g	10-g						
1RB										
Front Side	132322/1745	20M QPSK(1,99)	0.528	0.278	3.31	24.23	25.00	0.630	2022/12/16	
Back Side	132322/1745	20M QPSK(1,99)	0.875	0.480	4.88	24.23	25.00	1.045	2022/12/16	
Back Side	132072/1720	20M QPSK(1,99)	1.015	0.557	-2.94	24.70	25.00	1.088	2022/12/16	20#
Back Side Repeated	132072/1720	20M QPSK(1,99)	1.006	0.548	0.32	24.70	25.00	1.078	2022/12/16	
Back Side	132572/1770	20M QPSK(1,99)	0.953	0.518	-0.67	24.58	25.00	1.050	2022/12/16	
50%RB										
Front Side	132322/1745	20M QPSK(50,24)	0.287	0.159	2.67	23.54	24.00	0.319	2022/12/16	
Back Side	132322/1745	20M QPSK(50,24)	0.499	0.242	3.59	23.54	24.00	0.555	2022/12/16	
100%RB										
Back Side	132322/1745	20M QPSK(100,0)	0.470	0.226	1.20	23.42	23.50	0.479	2022/12/16	

NOTE: Body-Worn SAR test results of LTE Band 66

9.2. Simultaneous Transmission Analysis

Per KDB 447498 D01, simultaneous transmission SAR is compliant if,

- 1) Scalar SAR summation < 1.6W/kg.
- 2) $SPLSR = (SAR_1 + SAR_2)^{1.5} / (\text{min. separation distance, mm})$, and the peak separation distance is determined from the square root of $[(x_1-x_2)^2 + (y_1-y_2)^2 + (z_1-z_2)^2]$, where (x_1, y_1, z_1) and (x_2, y_2, z_2) are the coordinates of the extrapolated peak SAR locations in the zoom scan. If $SPLSR \leq 0.04$, simultaneously transmission SAR measurement is not necessary.

Test Position		Scaled SAR _{MAX}		Σ 1-g SAR (W/Kg)	SPLSR	Remark
		WWAN	DSS			
Head	Left Cheek	1.196	0.334	1.530	N/A	N/A
	Left Tilt 15 Degree	0.690	0.334	1.024	N/A	N/A
	Right Cheek	1.154	0.334	1.488	N/A	N/A
	Right Tilt 15 Degree	0.632	0.334	0.966	N/A	N/A
Body-Worn	Front Side	0.630	0.167	0.797	N/A	N/A
	Back Side	1.088	0.167	1.255	N/A	N/A

10. Appendix A. Photo documentation

Refer to appendix Test Setup photo---SAR

11. Appendix B. System Check Plots

Table of contents
MEASUREMENT 1 System Performance Check - 835MHz
MEASUREMENT 2 System Performance Check - 1800MHz
MEASUREMENT 3 System Performance Check - 1900MHz
MEASUREMENT 4 System Performance Check - 2600MHz

MEASUREMENT 1

Date of measurement: 12/12/2022

A. Experimental conditions.

Area Scan	<u>dx=15mm dy=15mm, h= 5.00 mm</u>
ZoomScan	<u>5x5x7, dx=8mm dy=8mm dz=5mm</u>
Phantom	<u>Validation plane</u>
Device Position	<u>Dipole</u>
Band	<u>CW835</u>
Channels	<u>Middle</u>
Signal	<u>CW (Crest factor: 1.0)</u>
ConvF	<u>1.50</u>

B. SAR Measurement Results

Frequency (MHz)	835.000000
Relative permittivity (real part)	41.375076
Relative permittivity (imaginary part)	20.103582
Conductivity (S/m)	0.932583
Variation (%)	1.970000

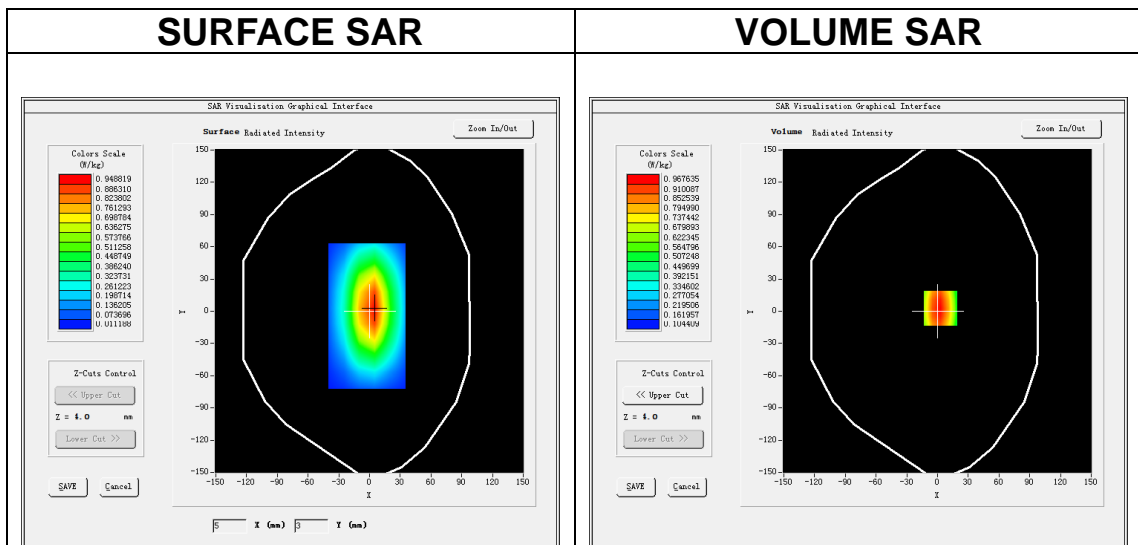

Maximum location: X=3.00, Y=3.00
SAR Peak: 1.30 W/Kg

SAR 10g (W/Kg)	0.664191
SAR 1g (W/Kg)	1.006231

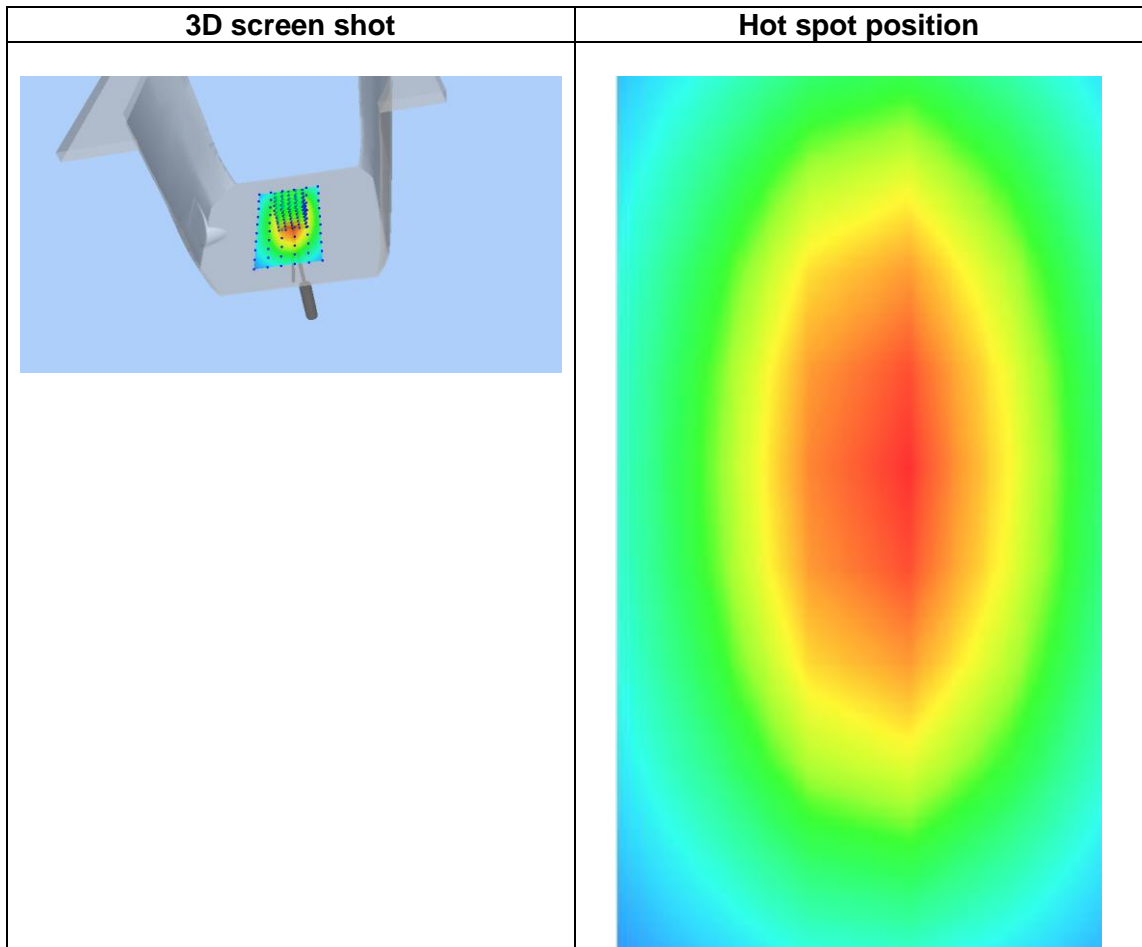
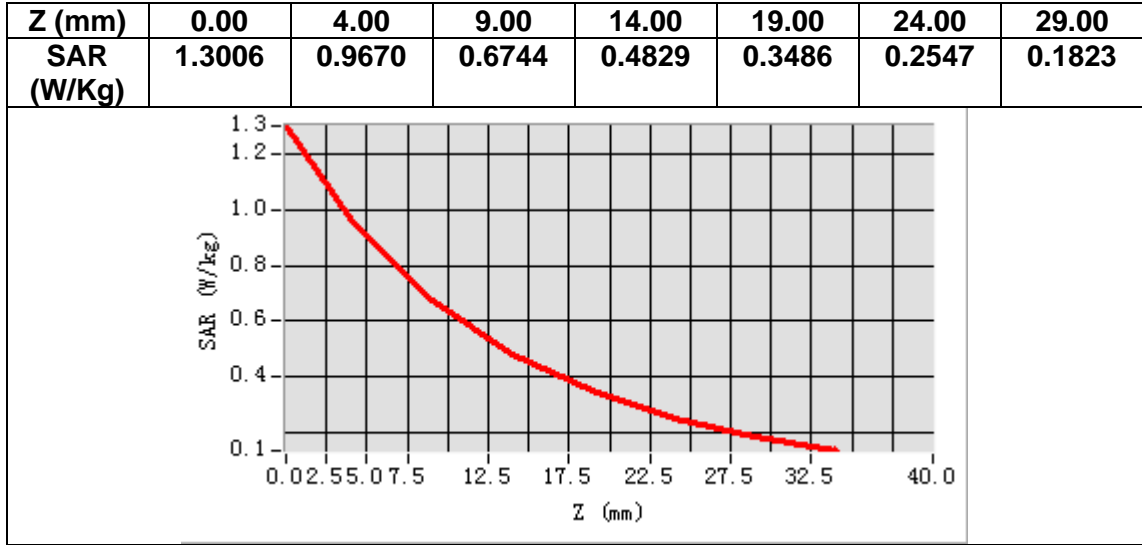

MEASUREMENT 2

Date of measurement: 16/12/2022

A. Experimental conditions.

Area Scan	<u>dx=15mm dy=15mm, h= 5.00 mm</u>
ZoomScan	<u>5x5x7, dx=8mm dy=8mm dz=5mm</u>
Phantom	<u>Validation plane</u>
Device Position	<u>Dipole</u>
Band	<u>CW1800</u>
Channels	<u>Middle</u>
Signal	<u>CW (Crest factor: 1.0)</u>
ConvF	<u>1.73</u>

B. SAR Measurement Results

Frequency (MHz)	1800.000000
Relative permittivity (real part)	39.043626
Relative permittivity (imaginary part)	14.026072
Conductivity (S/m)	1.402607
Variation (%)	-2.520000

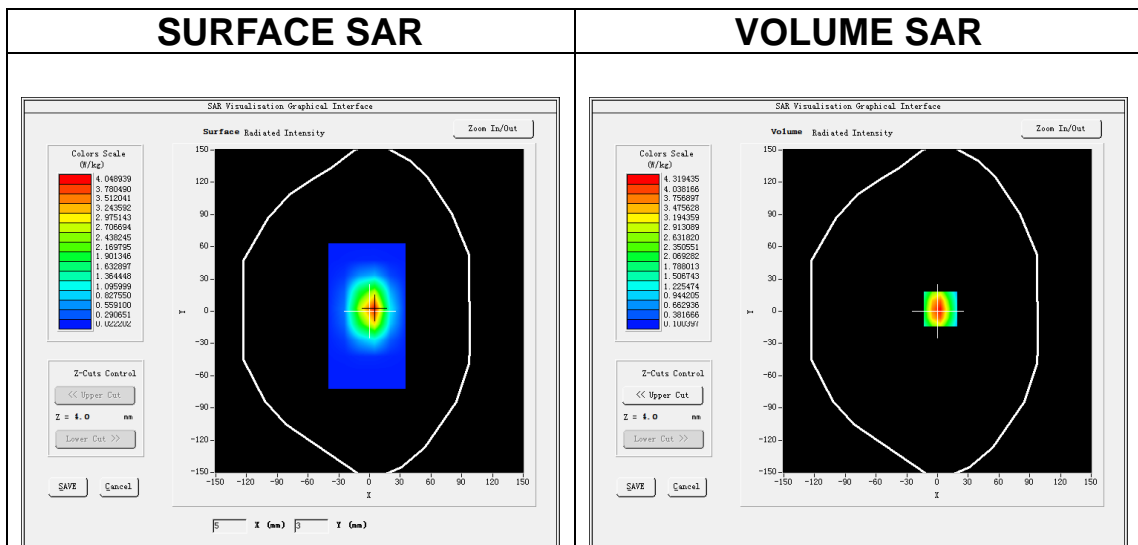

Maximum location: X=3.00, Y=2.00
SAR Peak: 6.82 W/kg

SAR 10g (W/Kg)	1.953296
SAR 1g (W/Kg)	3.588160

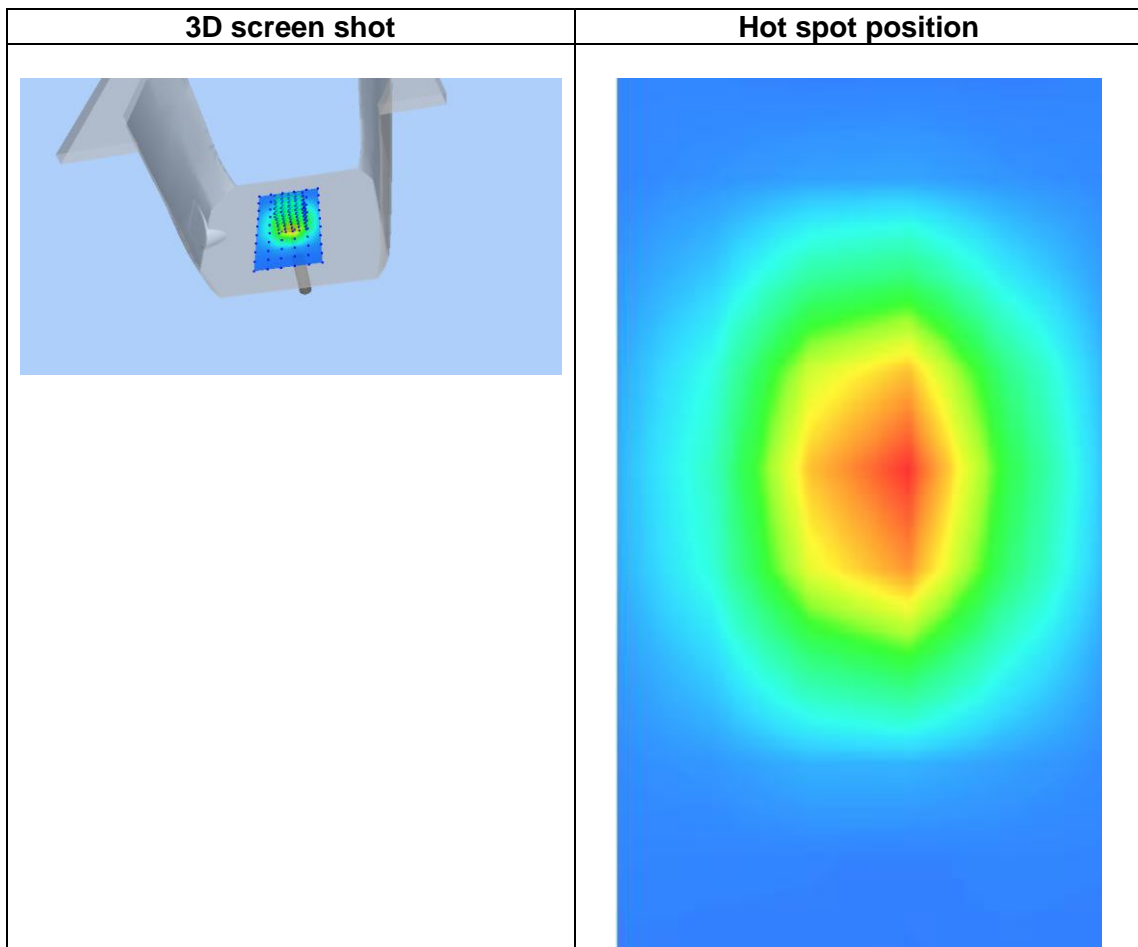
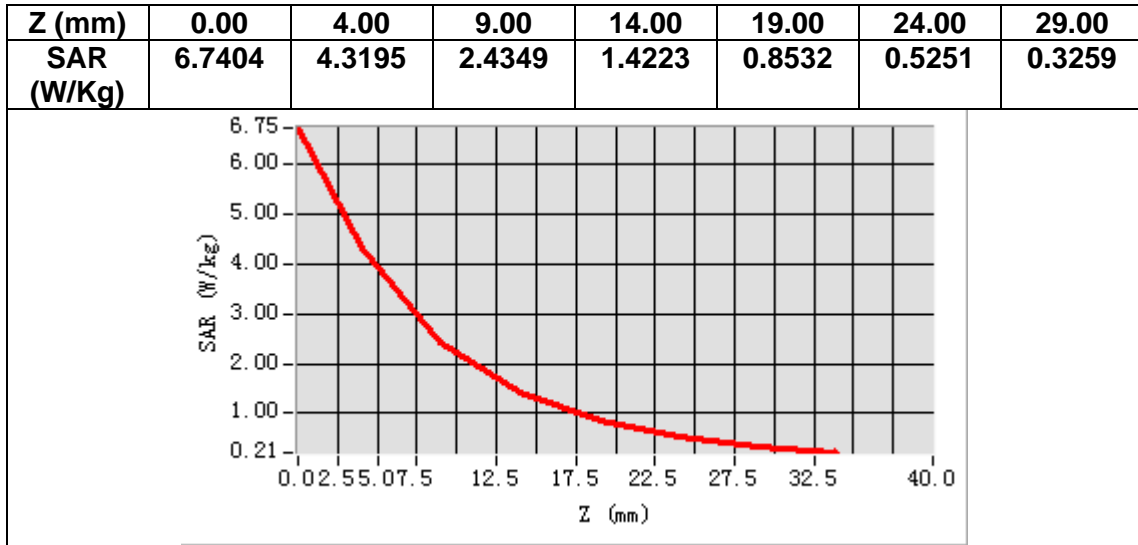

MEASUREMENT 3

Date of measurement: 9/12/2022

A. Experimental conditions.

Area Scan	<u>dx=15mm dy=15mm, h= 5.00 mm</u>
ZoomScan	<u>5x5x7, dx=8mm dy=8mm dz=5mm</u>
Phantom	<u>Validation plane</u>
Device Position	<u>Dipole</u>
Band	<u>CW1900</u>
Channels	<u>Middle</u>
Signal	<u>CW (Crest factor: 1.0)</u>
ConvF	<u>1.91</u>

B. SAR Measurement Results

Frequency (MHz)	1900.000000
Relative permittivity (real part)	38.779690
Relative permittivity (imaginary part)	13.744798
Conductivity (S/m)	1.450840
Variation (%)	2.050000

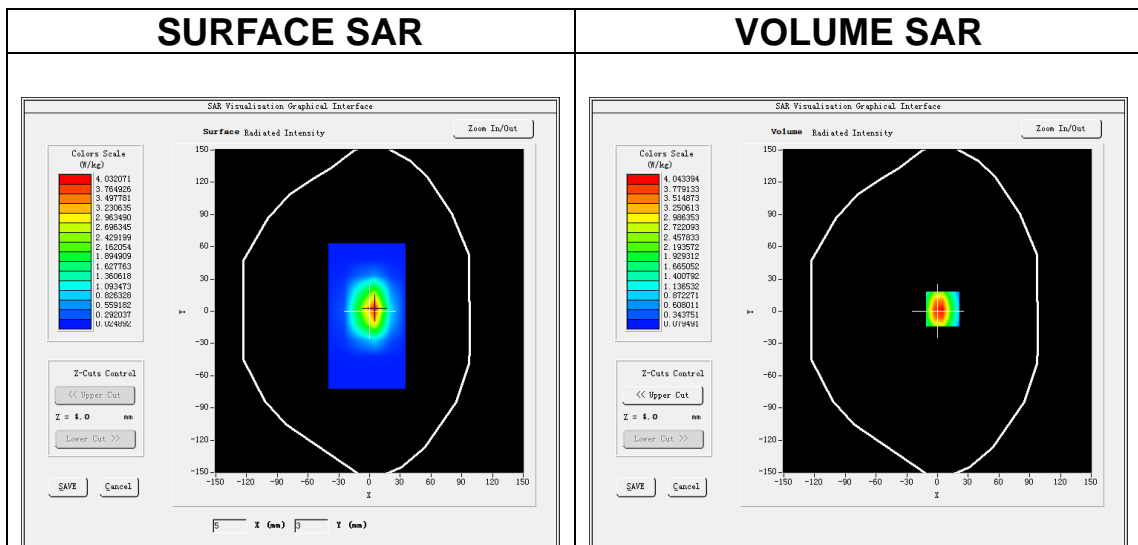

Maximum location: X=5.00, Y=2.00
SAR Peak: 6.70 W/kg

SAR 10g (W/Kg)	1.991384
SAR 1g (W/Kg)	3.727097

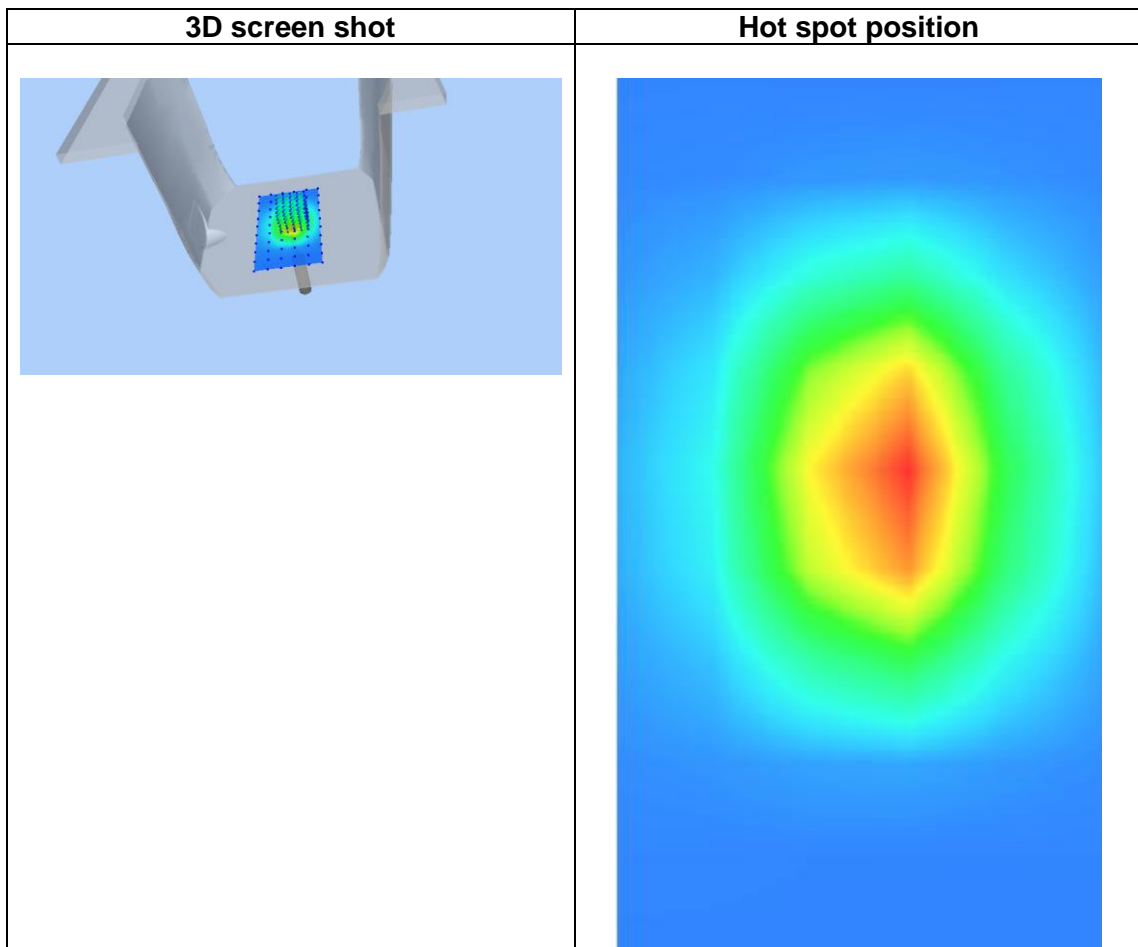
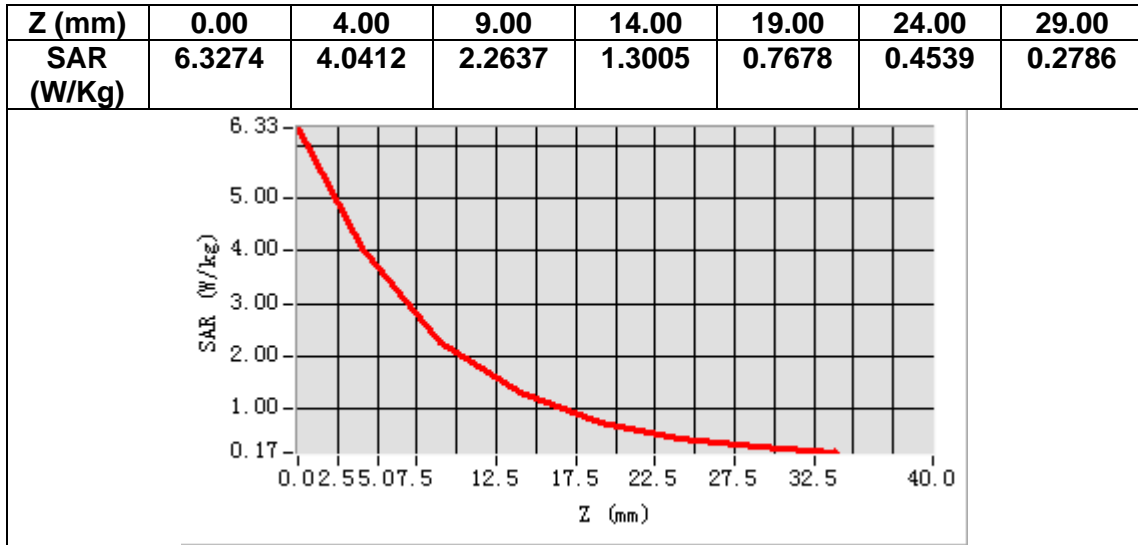

MEASUREMENT 4

Date of measurement: 8/12/2022

A. Experimental conditions.

Area Scan	<u>dx=12mm dy=12mm, h= 5.00 mm</u>
ZoomScan	<u>7x7x7, dx=5mm dy=5mm dz=5mm</u>
Phantom	<u>Validation plane</u>
Device Position	<u>Dipole</u>
Band	<u>CW2600</u>
Channels	<u>Middle</u>
Signal	<u>CW (Crest factor: 1.0)</u>
ConvF	<u>1.87</u>

B. SAR Measurement Results

Frequency (MHz)	2600.000000
Relative permittivity (real part)	38.081805
Relative permittivity (imaginary part)	13.711922
Conductivity (S/m)	1.980611
Variation (%)	1.570000

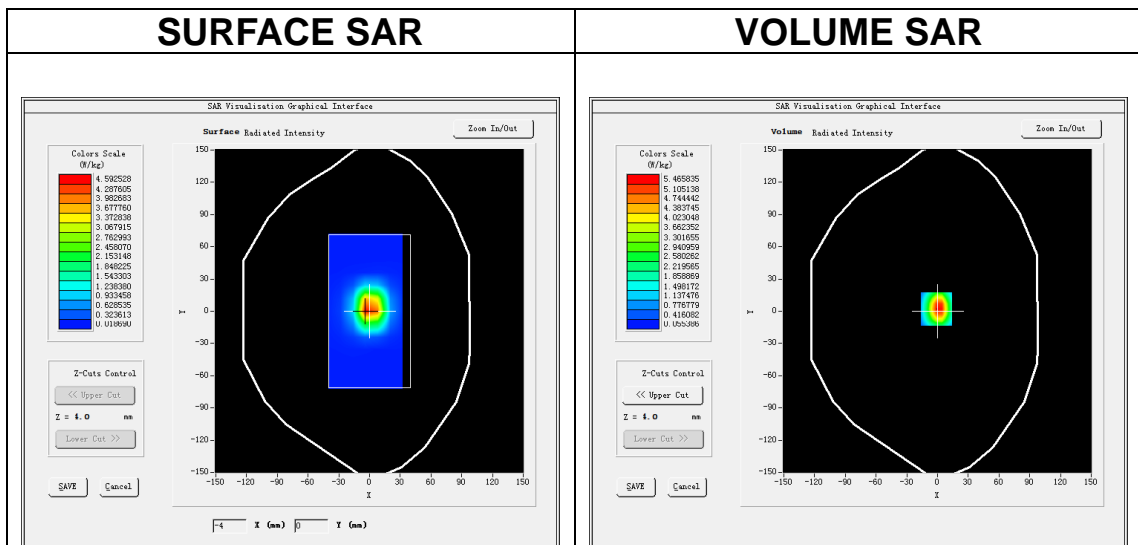

Maximum location: X=-1.00, Y=2.00

SAR Peak: 9.07 W/kg

SAR 10g (W/Kg)	2.521172
SAR 1g (W/Kg)	5.591128

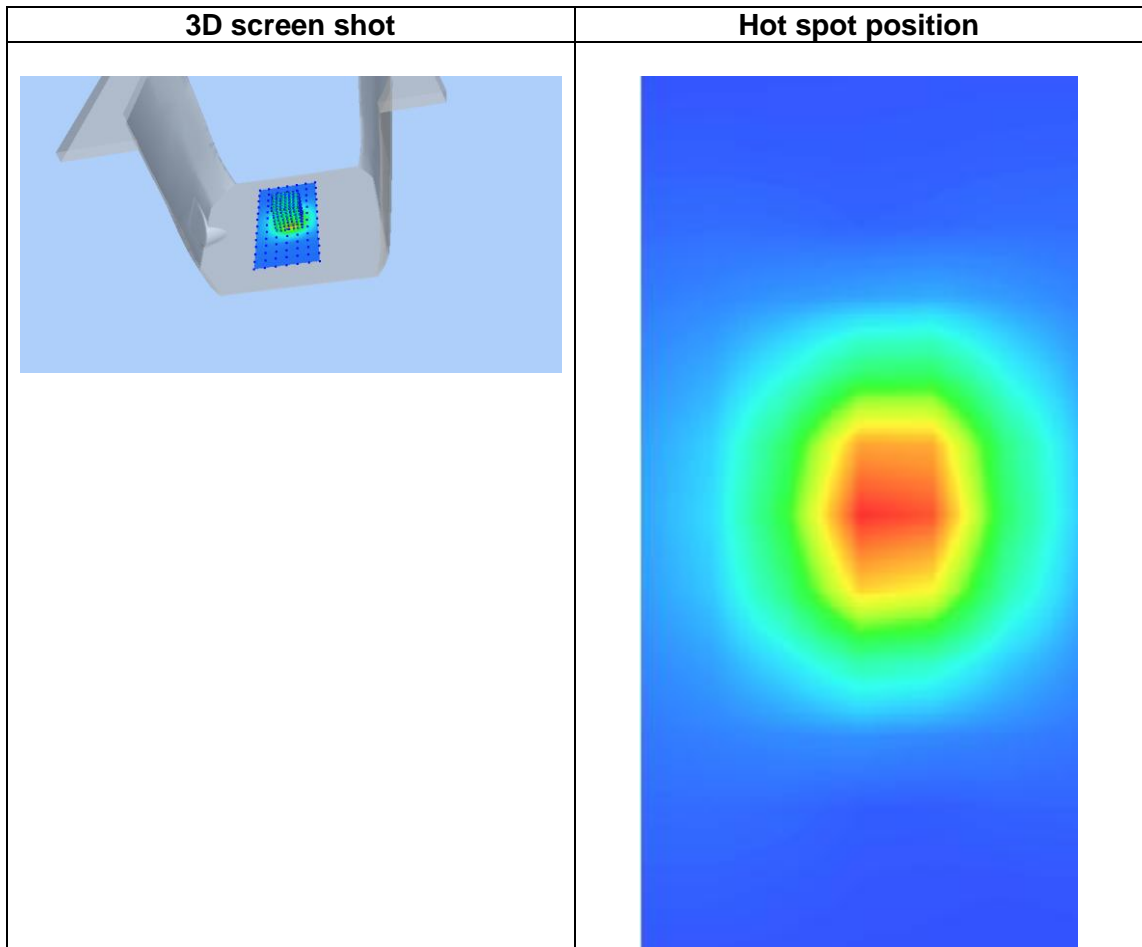
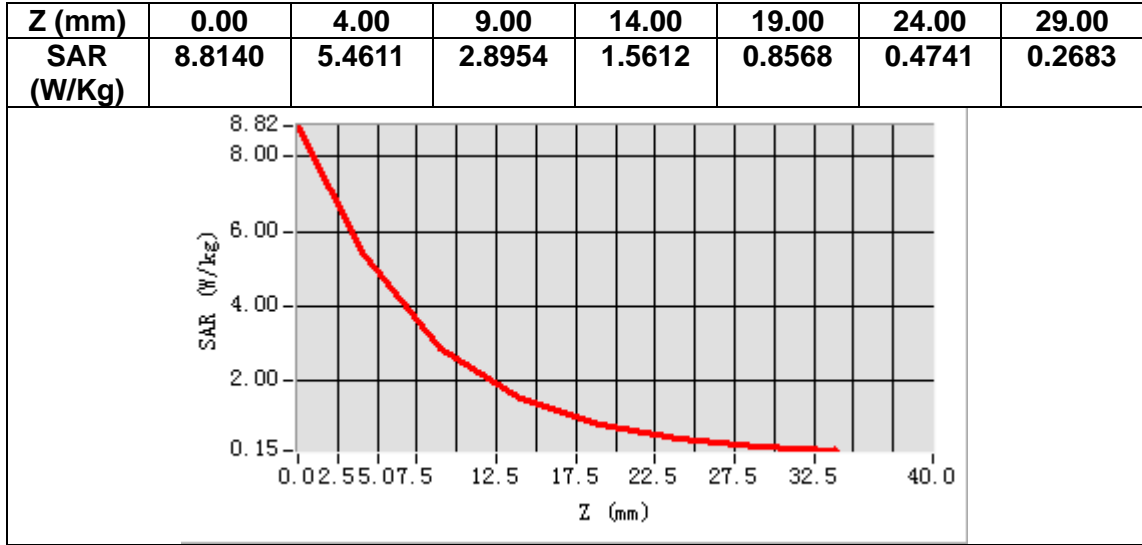

12. Appendix C. Plots of High SAR Measurement

Table of contents
MEASUREMENT 1 GSM 850 Head
MEASUREMENT 2 GSM 850 Body
MEASUREMENT 3 GSM 1900 Head
MEASUREMENT 4 GSM 1900 Body
MEASUREMENT 5 WCDMA Band 2 Head
MEASUREMENT 6 WCDMA Band 2 Body
MEASUREMENT 7 WCDMA Band 4 Head
MEASUREMENT 8 WCDMA Band 4 Body
MEASUREMENT 9 WCDMA Band 5 Head
MEASUREMENT 10 WCDMA Band 5 Body
MEASUREMENT 11 LTE Band 2 Head
MEASUREMENT 12 LTE Band 2 Body
MEASUREMENT 13 LTE Band 4 Head
MEASUREMENT 14 LTE Band 4 Body
MEASUREMENT 15 LTE Band 5 Head
MEASUREMENT 16 LTE Band 5 Body
MEASUREMENT 17 LTE Band 7 Head
MEASUREMENT 18 LTE Band 7 Body
MEASUREMENT 19 LTE Band 66 Head
MEASUREMENT 20 LTE Band 66 Body

MEASUREMENT 1

Date of measurement: 12/12/2022

A. Experimental conditions.

Area Scan	<u>dx=15mm dy=15mm, h= 5.00 mm</u>
ZoomScan	<u>5x5x7,dx=8mm dy=8mm dz=5mm</u>
Phantom	<u>Left head</u>
Device Position	<u>Cheek</u>
Band	<u>GSM850</u>
Channels	<u>Middle</u>
Signal	<u>TDMA (Crest factor: 2.7)</u>
ConvF	<u>1.50</u>

B. SAR Measurement Results

Frequency (MHz)	836.400000
Relative permittivity (real part)	41.290737
Relative permittivity (imaginary part)	20.129421
Conductivity (S/m)	0.935347
Variation (%)	-3.210000

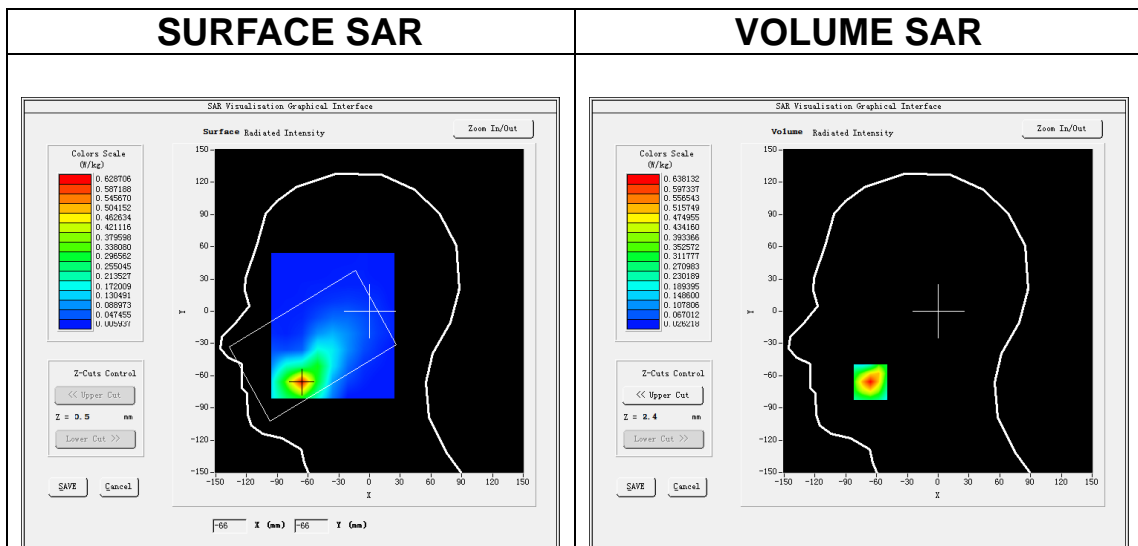

Maximum location: X=-66.00, Y=-66.00
SAR Peak: 1.08 W/kg

SAR 10g (W/Kg)	0.327811
SAR 1g (W/Kg)	0.622054

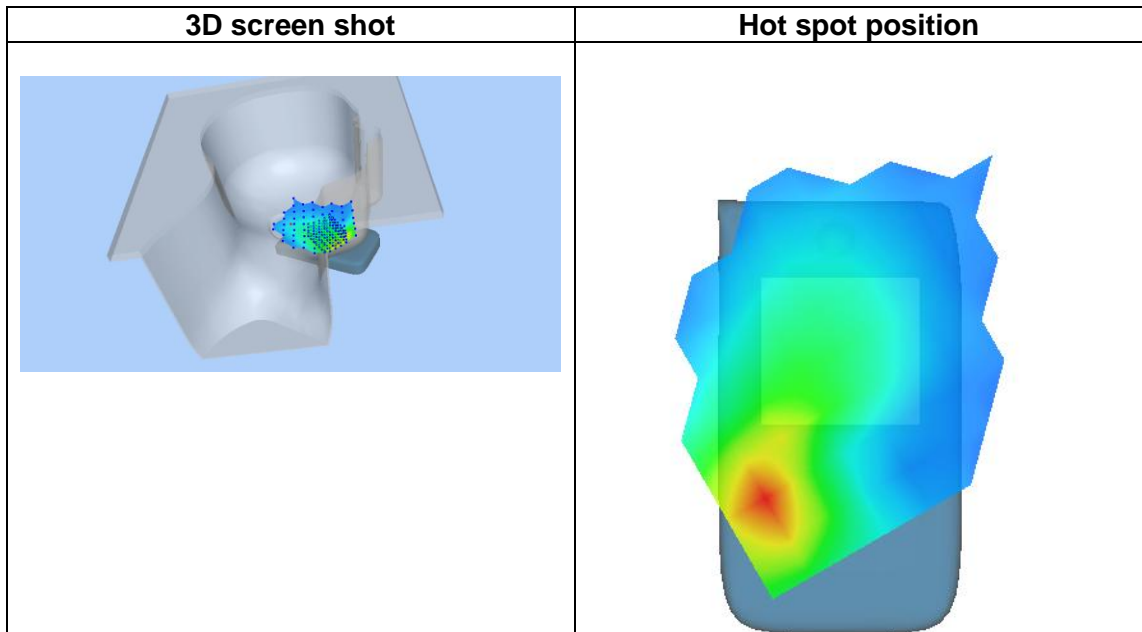
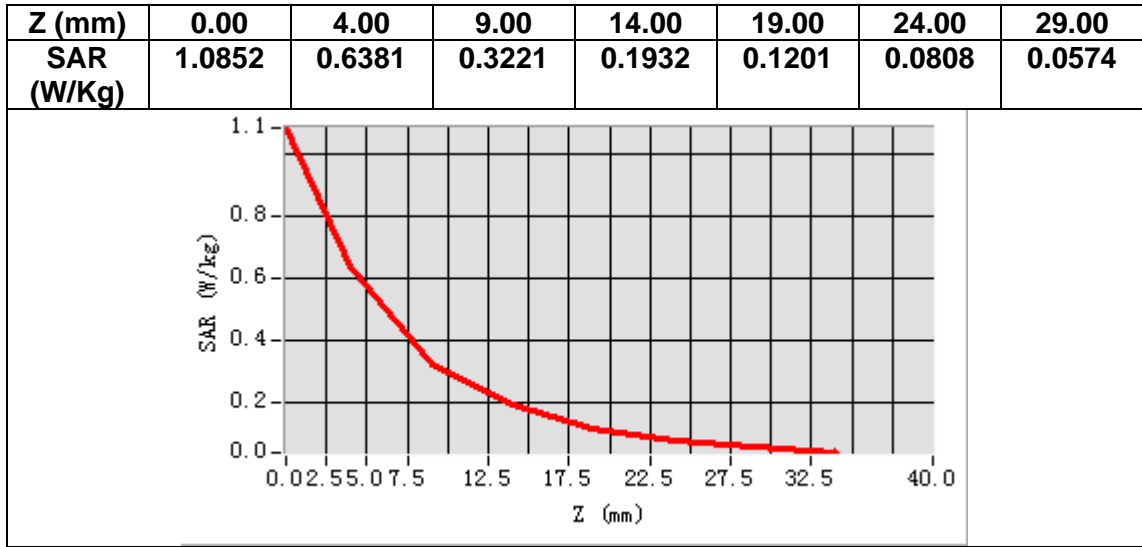

MEASUREMENT 2

Date of measurement: 12/12/2022

A. Experimental conditions.

Area Scan	<u>dx=15mm dy=15mm, h= 5.00 mm</u>
ZoomScan	<u>5x5x7, dx=8mm dy=8mm dz=5mm</u>
Phantom	<u>Validation plane</u>
Device Position	<u>Body</u>
Band	<u>GSM850</u>
Channels	<u>Middle</u>
Signal	<u>TDMA (Crest factor: 2.7)</u>
ConvF	<u>1.50</u>

B. SAR Measurement Results

Frequency (MHz)	836.400000
Relative permittivity (real part)	41.290737
Relative permittivity (imaginary part)	20.129421
Conductivity (S/m)	0.935347
Variation (%)	0.860000

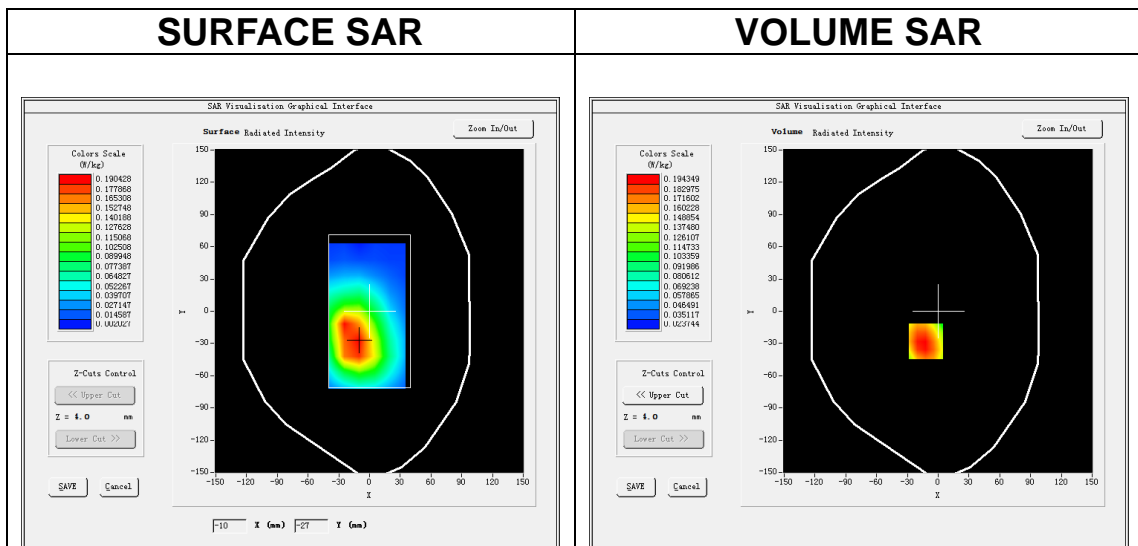

Maximum location: X=-12.00, Y=-28.00
SAR Peak: 0.25 W/kg

SAR 10g (W/Kg)	0.136376
SAR 1g (W/Kg)	0.195931

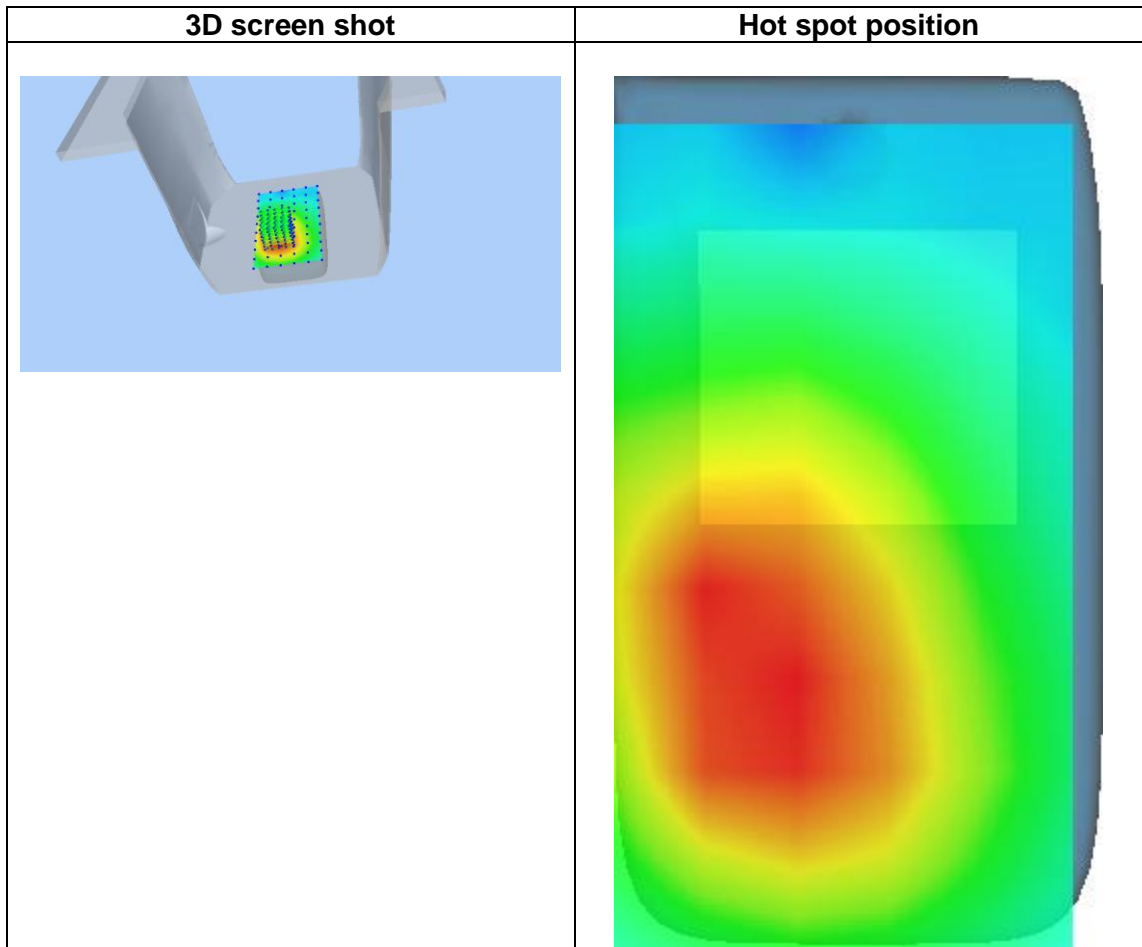
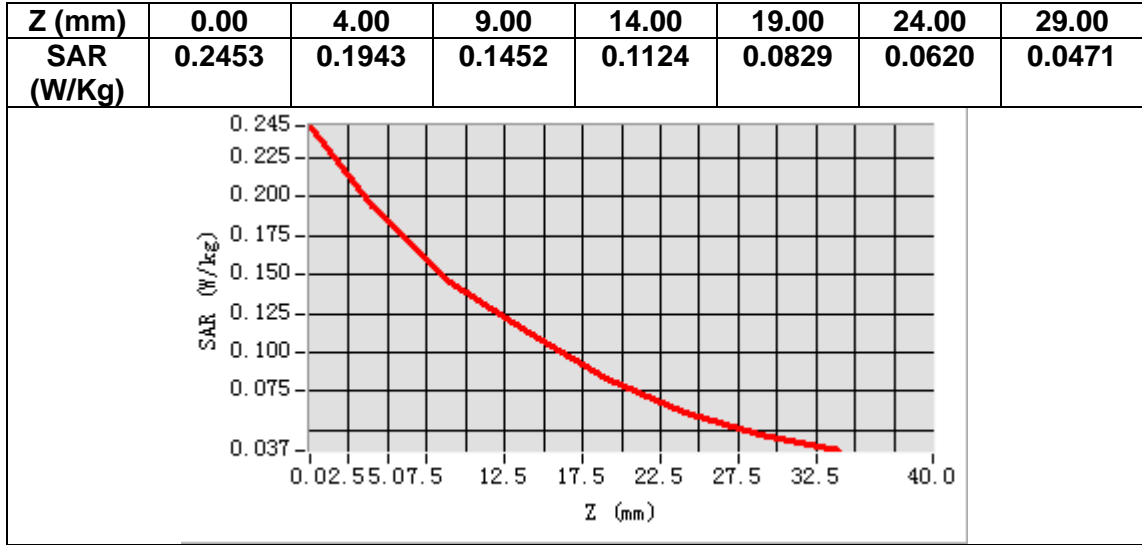

MEASUREMENT 3

Date of measurement: 9/12/2022

A. Experimental conditions.

Area Scan	<u>dx=15mm dy=15mm, h= 5.00 mm</u>
ZoomScan	<u>5x5x7,dx=8mm dy=8mm dz=5mm</u>
Phantom	<u>Left head</u>
Device Position	<u>Cheek</u>
Band	<u>GSM1900</u>
Channels	<u>Middle</u>
Signal	<u>TDMA (Crest factor: 2.7)</u>
ConvF	<u>1.91</u>

B. SAR Measurement Results

Frequency (MHz)	1880.000000
Relative permittivity (real part)	38.866089
Relative permittivity (imaginary part)	13.762598
Conductivity (S/m)	1.437427
Variation (%)	0.450000

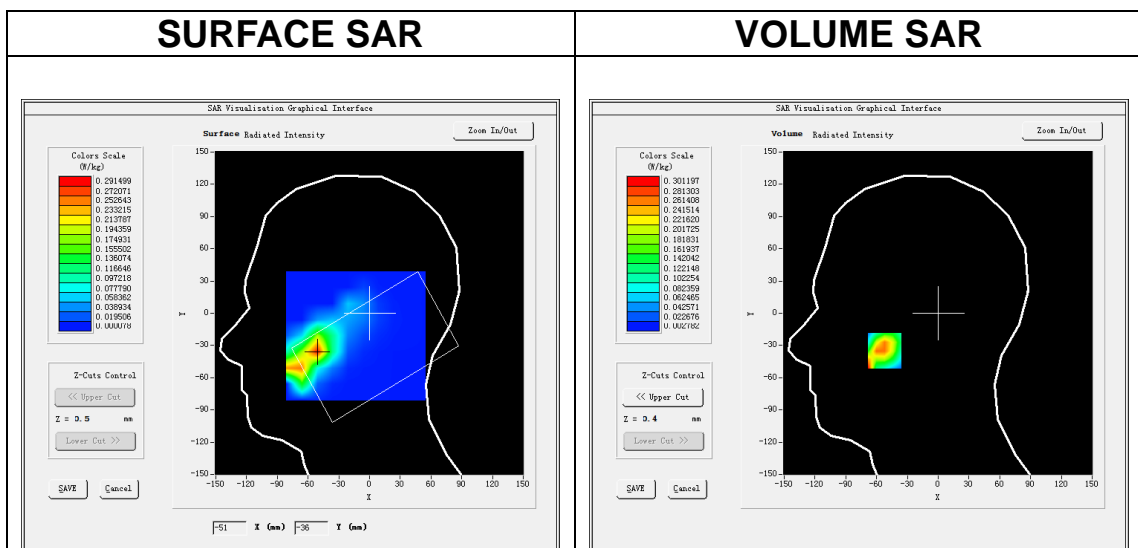

Maximum location: X=-52.00, Y=-35.00
SAR Peak: 0.53 W/kg

SAR 10g (W/Kg)	0.137849
SAR 1g (W/Kg)	0.231698

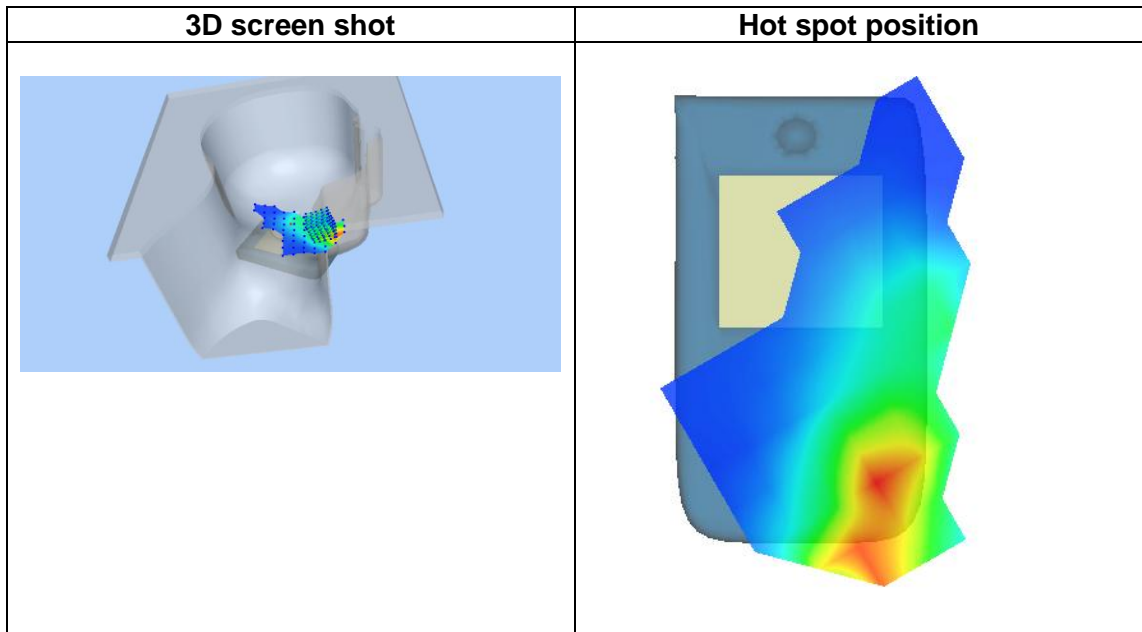
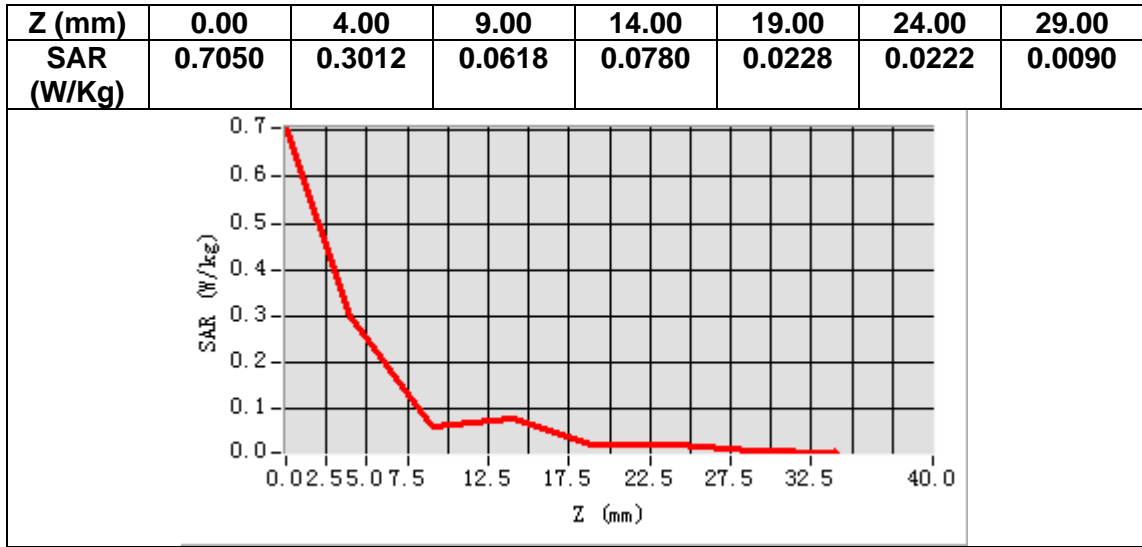

MEASUREMENT 4

Date of measurement: 9/12/2022

A. Experimental conditions.

Area Scan	<u>dx=15mm dy=15mm, h= 5.00 mm</u>
ZoomScan	<u>5x5x7, dx=8mm dy=8mm dz=5mm</u>
Phantom	<u>Validation plane</u>
Device Position	<u>Body</u>
Band	<u>GSM1900</u>
Channels	<u>High</u>
Signal	<u>TDMA (Crest factor: 2.7)</u>
ConvF	<u>1.91</u>

B. SAR Measurement Results

Frequency (MHz)	1909.800000
Relative permittivity (real part)	38.743370
Relative permittivity (imaginary part)	13.689598
Conductivity (S/m)	1.452466
Variation (%)	-3.560000

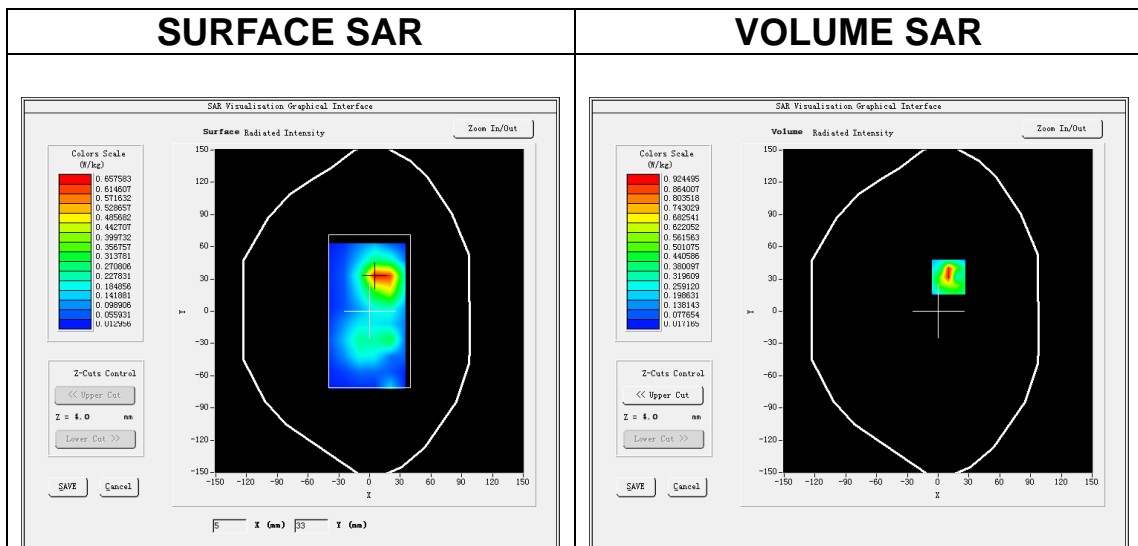

Maximum location: X=10.00, Y=32.00
SAR Peak: 1.95 W/kg

SAR 10g (W/Kg)	0.359072
SAR 1g (W/Kg)	0.884649

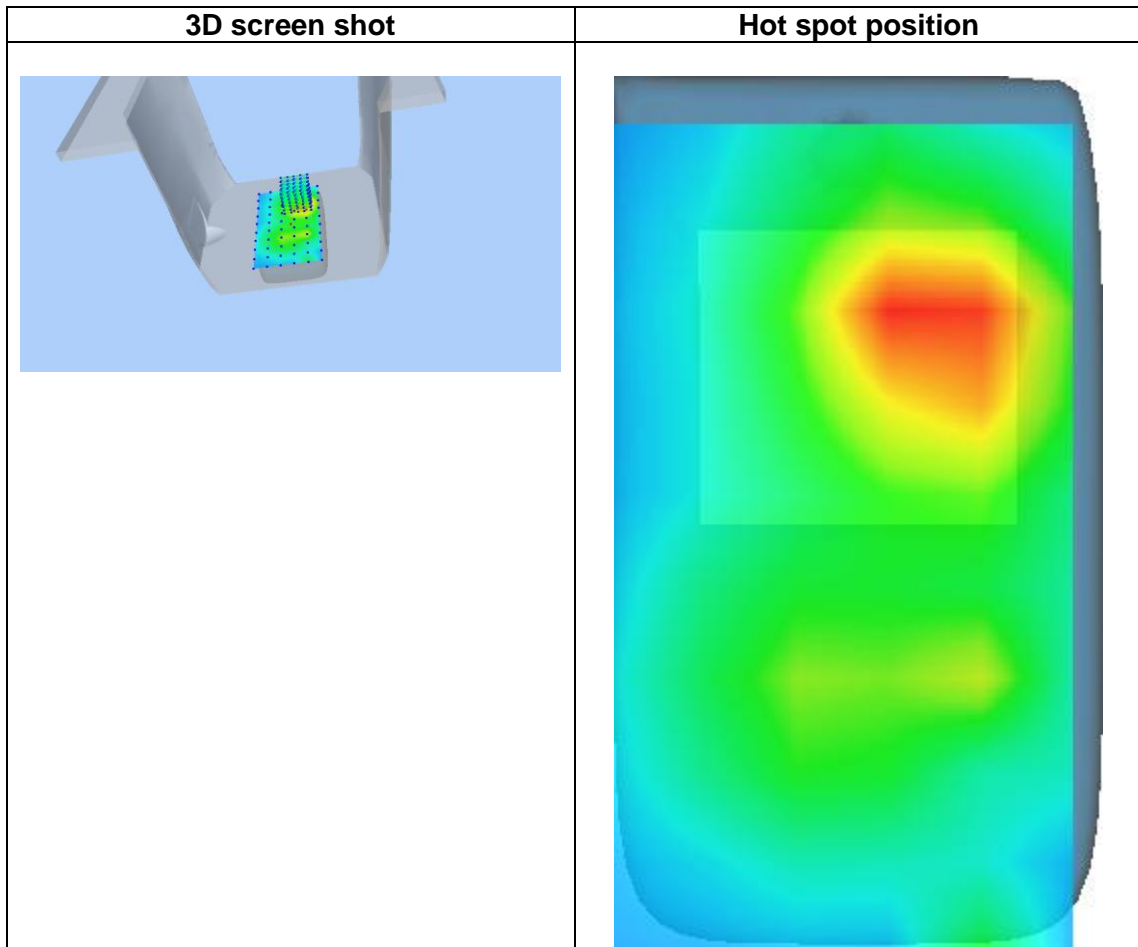
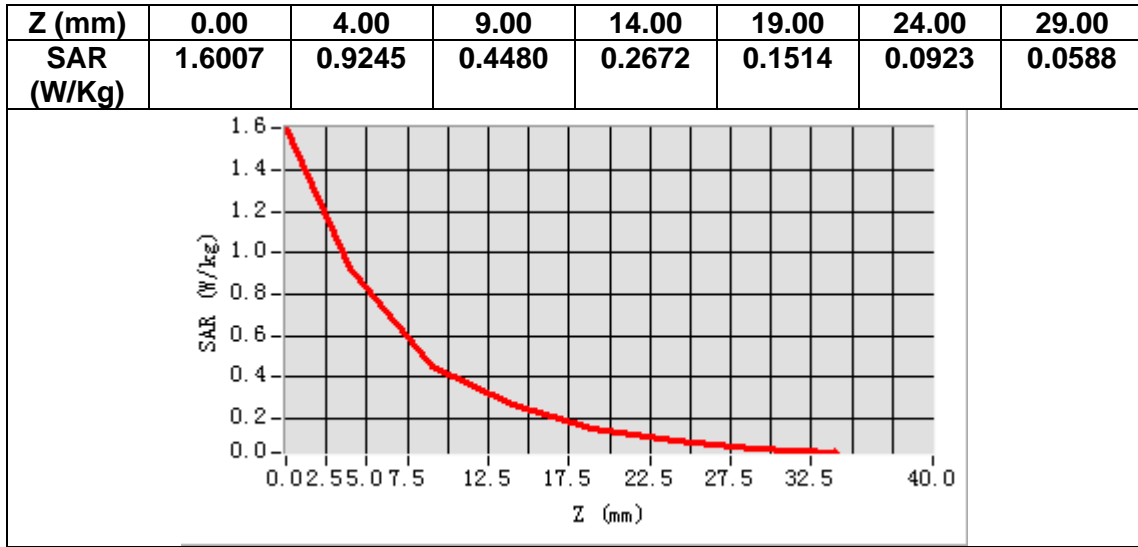

MEASUREMENT 5

Date of measurement: 9/12/2022

A. Experimental conditions.

Area Scan	<u>dx=15mm dy=15mm, h= 5.00 mm</u>
ZoomScan	<u>5x5x7,dx=8mm dy=8mm dz=5mm</u>
Phantom	<u>Left head</u>
Device Position	<u>Cheek</u>
Band	<u>Band2 WCDMA1900</u>
Channels	<u>Middle</u>
Signal	<u>WCDMA (Crest factor: 1.0)</u>
ConvF	<u>1.91</u>

B. SAR Measurement Results

Frequency (MHz)	1880.000000
Relative permittivity (real part)	38.866089
Relative permittivity (imaginary part)	13.762598
Conductivity (S/m)	1.437427
Variation (%)	-1.890000

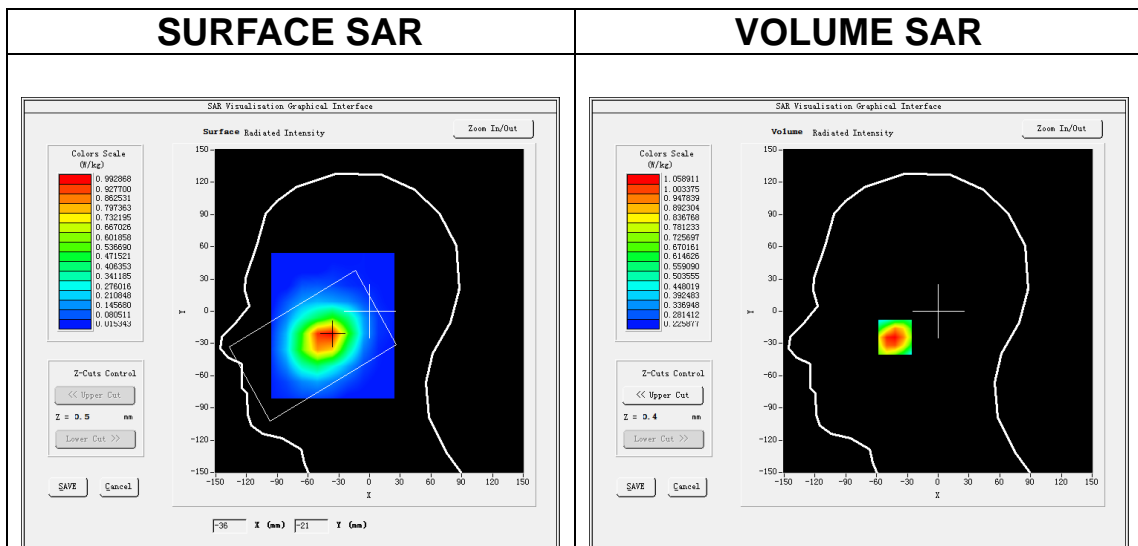

Maximum location: X=-42.00, Y=-24.00
SAR Peak: 1.34 W/kg

SAR 10g (W/Kg)	0.667950
SAR 1g (W/Kg)	0.948515

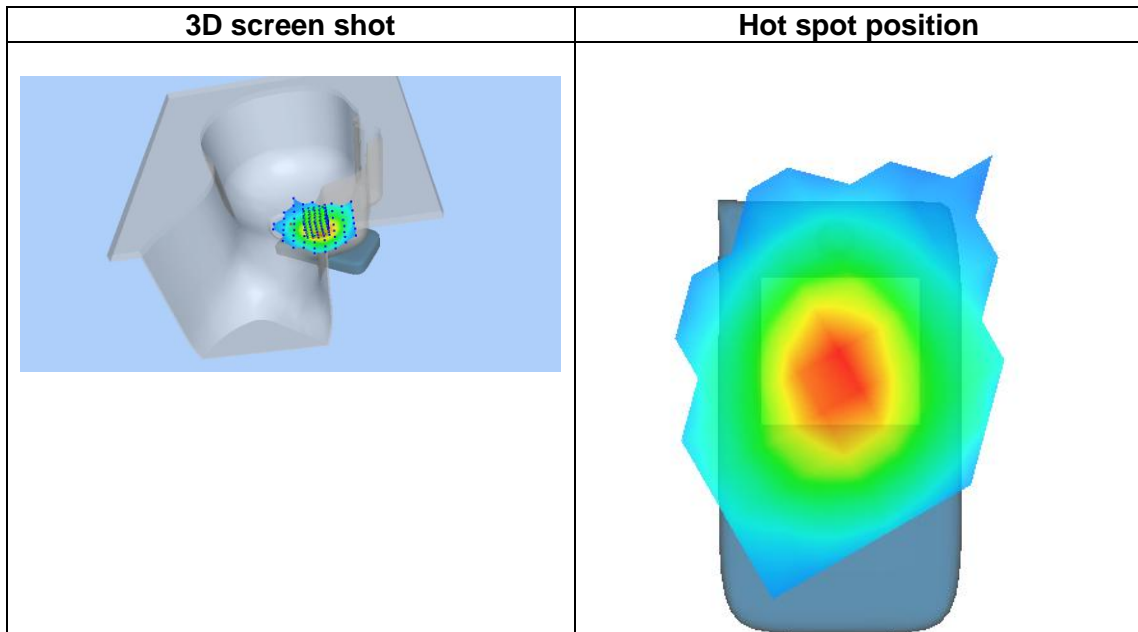
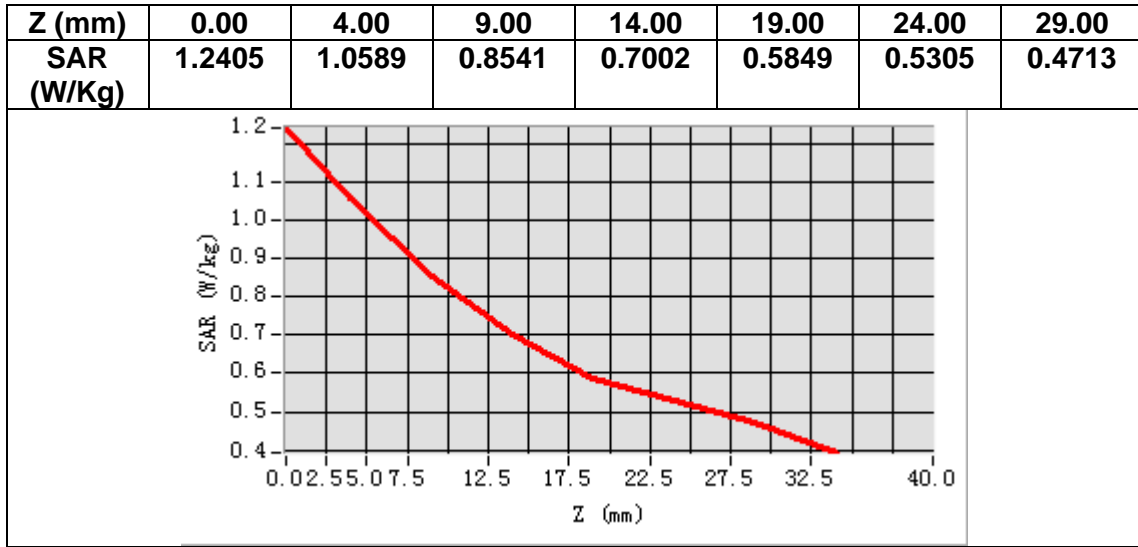

MEASUREMENT 6

Date of measurement: 9/12/2022

A. Experimental conditions.

Area Scan	<u>dx=15mm dy=15mm, h= 5.00 mm</u>
ZoomScan	<u>5x5x7, dx=8mm dy=8mm dz=5mm</u>
Phantom	<u>Validation plane</u>
Device Position	<u>Body</u>
Band	<u>Band2 WCDMA1900</u>
Channels	<u>Middle</u>
Signal	<u>WCDMA (Crest factor: 1.0)</u>
ConvF	<u>1.91</u>

B. SAR Measurement Results

Frequency (MHz)	1880.000000
Relative permittivity (real part)	38.866089
Relative permittivity (imaginary part)	13.762598
Conductivity (S/m)	1.437427
Variation (%)	0.620000

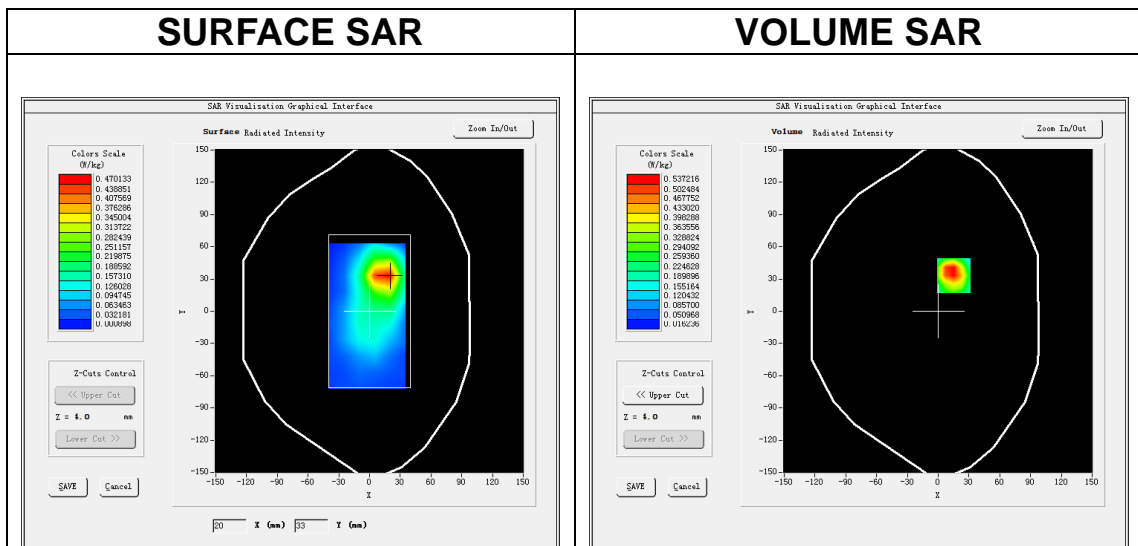

Maximum location: X=15.00, Y=33.00
SAR Peak: 0.91 W/kg

SAR 10g (W/Kg)	0.279991
SAR 1g (W/Kg)	0.553275

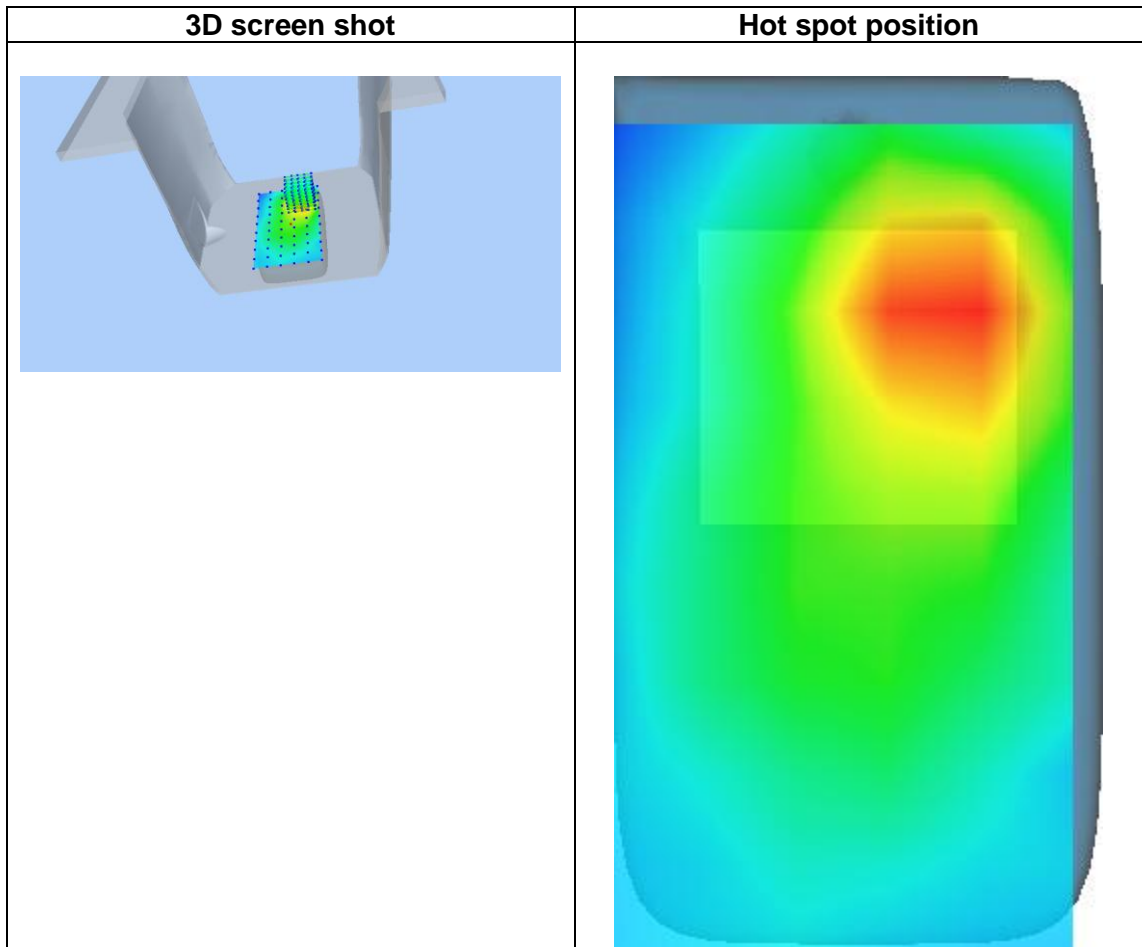
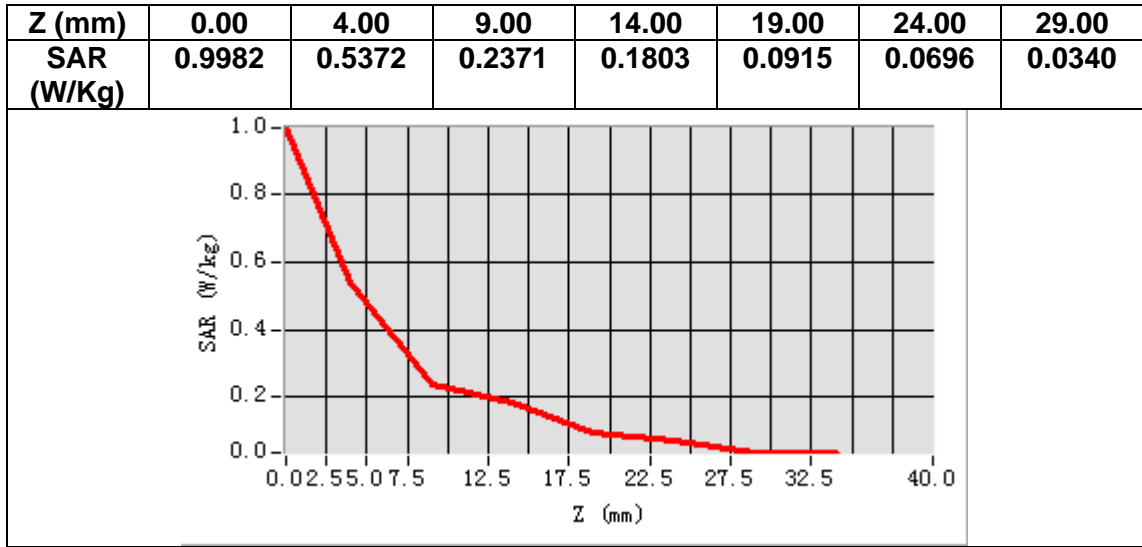

MEASUREMENT 7

Date of measurement: 16/12/2022

A. Experimental conditions.

Area Scan	<u>dx=15mm dy=15mm, h= 5.00 mm</u>
ZoomScan	<u>5x5x7,dx=8mm dy=8mm dz=5mm</u>
Phantom	<u>Left head</u>
Device Position	<u>Cheek</u>
Band	<u>Band4 WCDMA1700</u>
Channels	<u>Middle</u>
Signal	<u>WCDMA (Crest factor: 1.0)</u>
ConvF	<u>1.73</u>

B. SAR Measurement Results

Frequency (MHz)	1732.600000
Relative permittivity (real part)	39.503326
Relative permittivity (imaginary part)	13.978372
Conductivity (S/m)	1.345030
Variation (%)	-0.470000

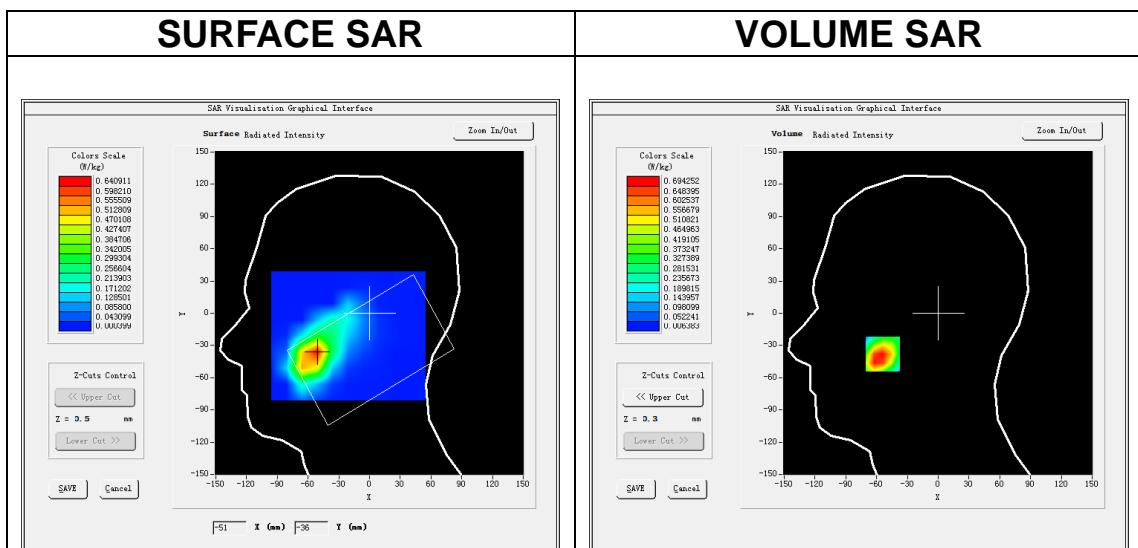

Maximum location: X=-54.00, Y=-38.00
SAR Peak: 1.04 W/kg

SAR 10g (W/Kg)	0.386632
SAR 1g (W/Kg)	0.688142

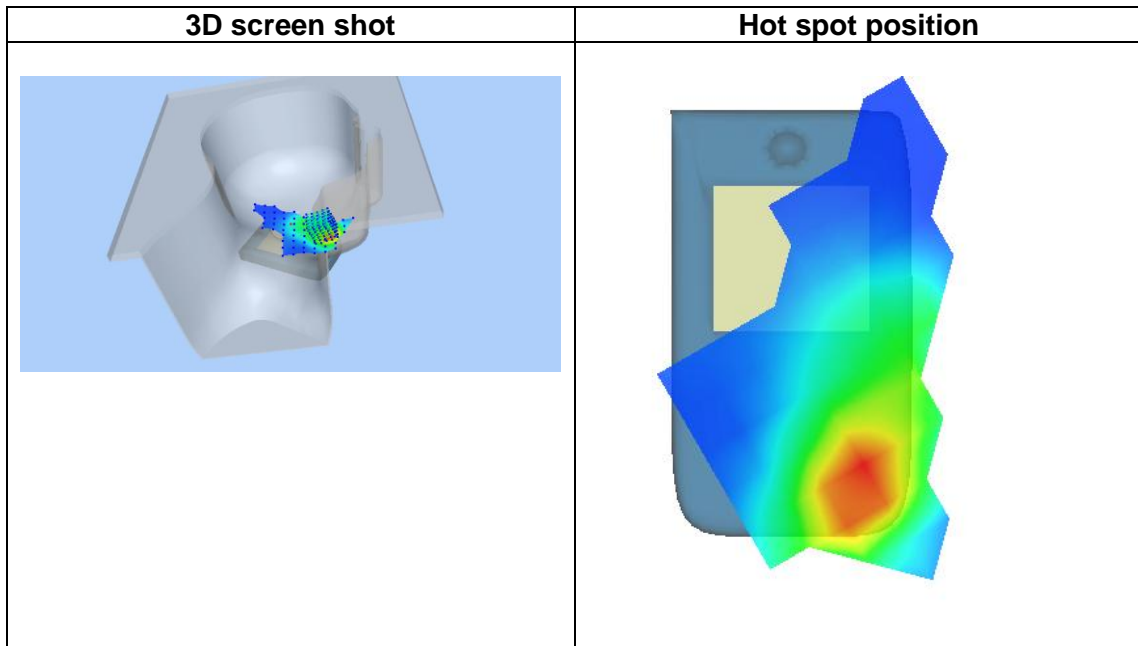
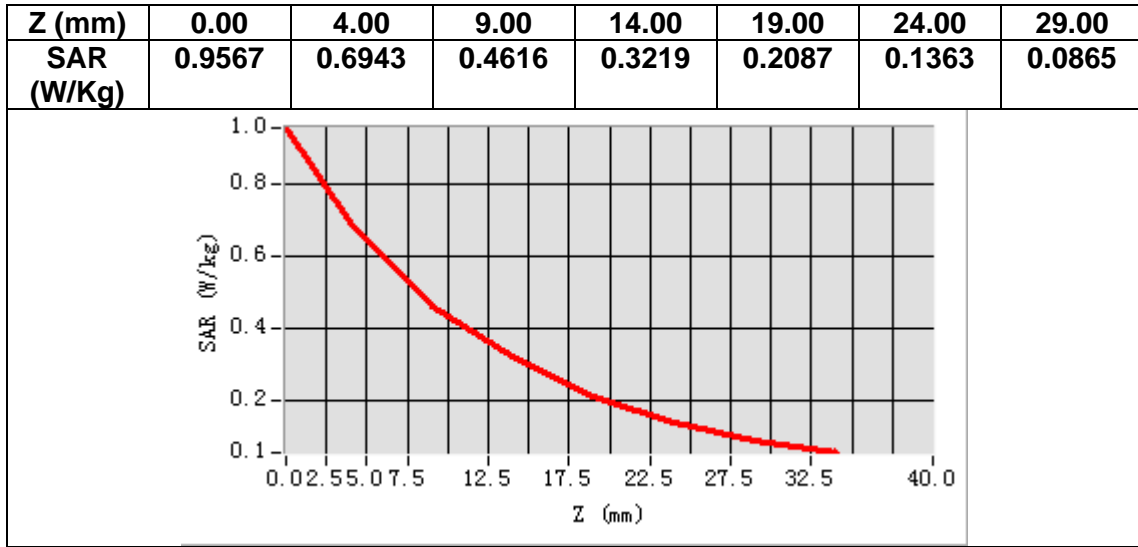

MEASUREMENT 8

Date of measurement: 16/12/2022

A. Experimental conditions.

Area Scan	<u>dx=15mm dy=15mm, h= 5.00 mm</u>
ZoomScan	<u>5x5x7, dx=8mm dy=8mm dz=5mm</u>
Phantom	<u>Validation plane</u>
Device Position	<u>Body</u>
Band	<u>Band4 WCDMA1700</u>
Channels	<u>Middle</u>
Signal	<u>WCDMA (Crest factor: 1.0)</u>
ConvF	<u>1.73</u>

B. SAR Measurement Results

Frequency (MHz)	1732.600000
Relative permittivity (real part)	39.503326
Relative permittivity (imaginary part)	13.978372
Conductivity (S/m)	1.345030
Variation (%)	0.360000

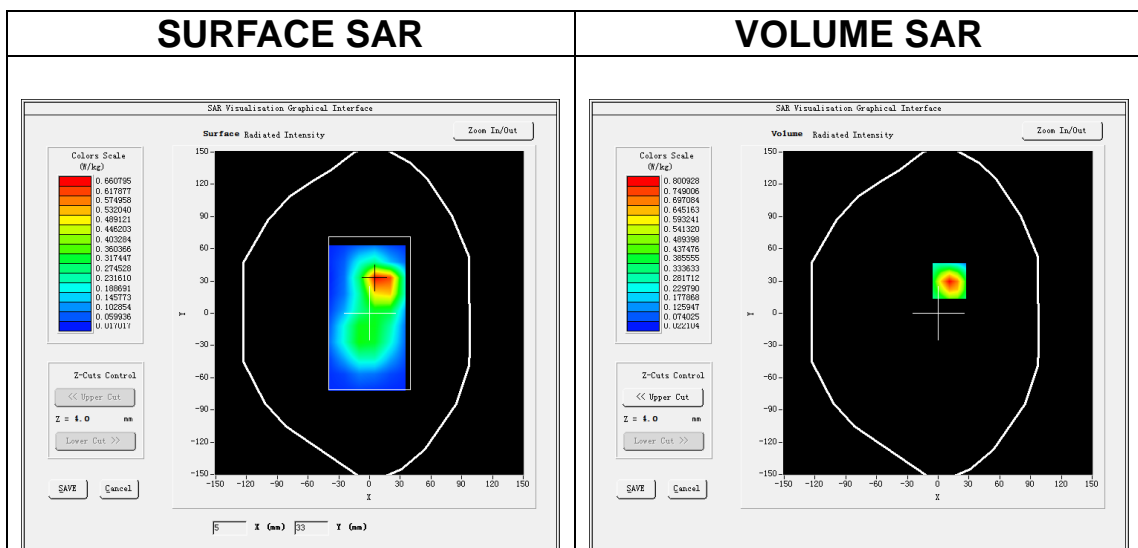

Maximum location: X=11.00, Y=30.00
SAR Peak: 1.13 W/kg

SAR 10g (W/Kg)	0.402379
SAR 1g (W/Kg)	0.732208

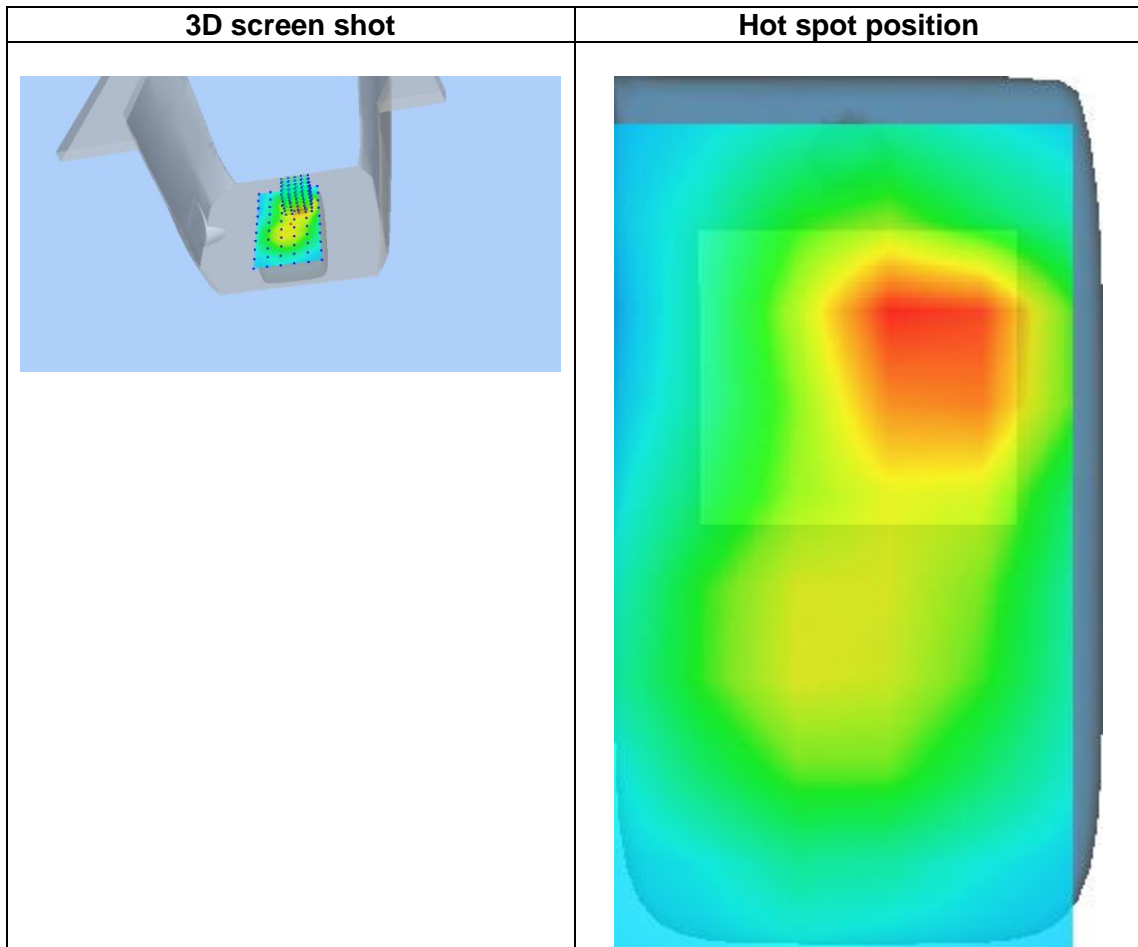
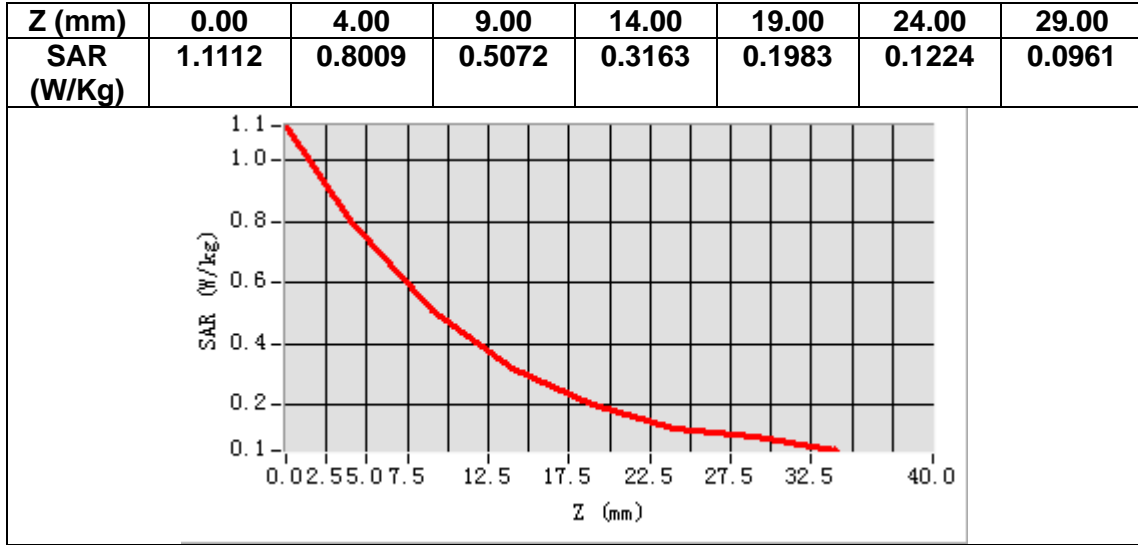

MEASUREMENT 9

Date of measurement: 12/12/2022

A. Experimental conditions.

Area Scan	<u>dx=15mm dy=15mm, h= 5.00 mm</u>
ZoomScan	<u>5x5x7,dx=8mm dy=8mm dz=5mm</u>
Phantom	<u>Left head</u>
Device Position	<u>Cheek</u>
Band	<u>Band5_WCDMA850</u>
Channels	<u>Middle</u>
Signal	<u>WCDMA (Crest factor: 1.0)</u>
ConvF	<u>1.50</u>

B. SAR Measurement Results

Frequency (MHz)	836.400000
Relative permittivity (real part)	41.290737
Relative permittivity (imaginary part)	20.129421
Conductivity (S/m)	0.935347
Variation (%)	-1.210000

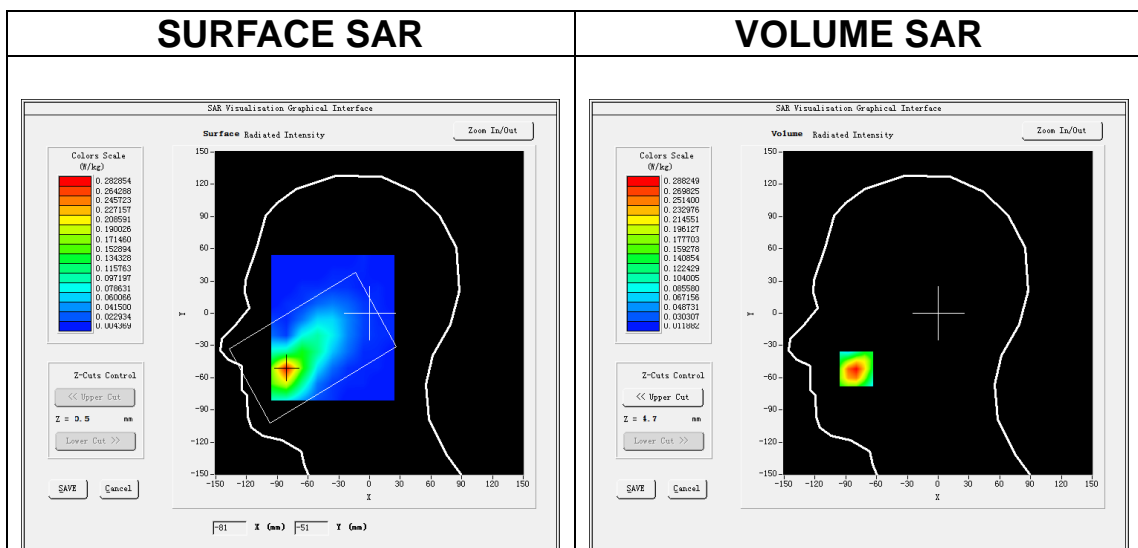

Maximum location: X=-80.00, Y=-52.00
SAR Peak: 0.47 W/kg

SAR 10g (W/Kg)	0.164850
SAR 1g (W/Kg)	0.288698

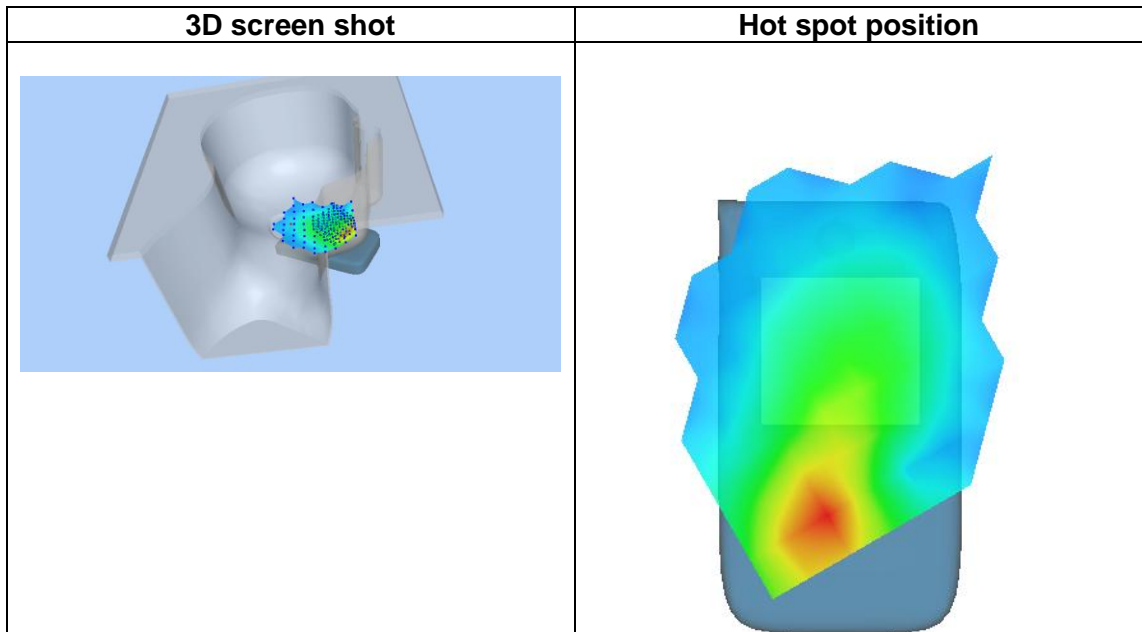
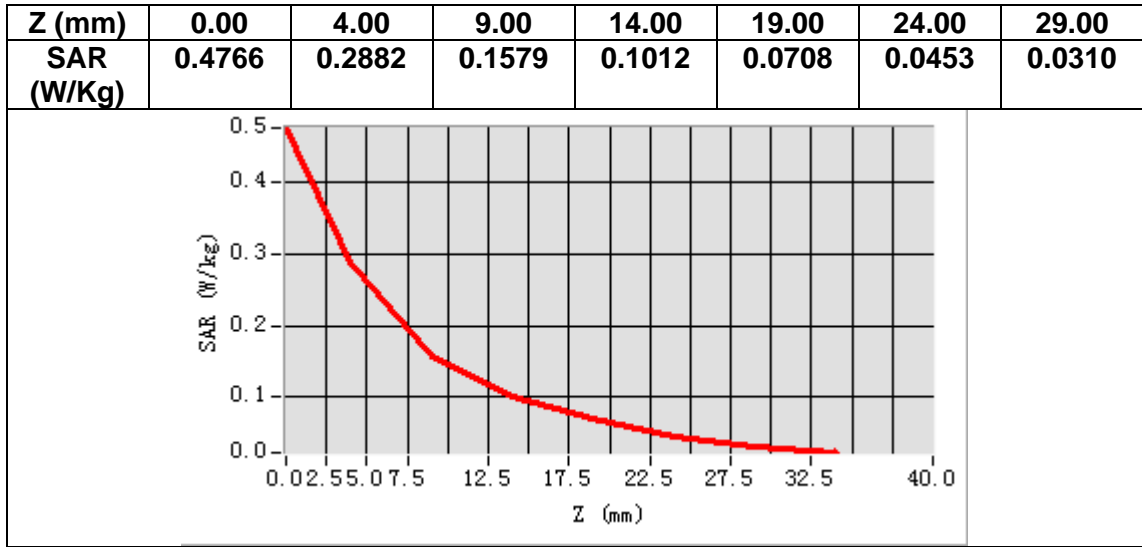

MEASUREMENT 10

Date of measurement: 12/12/2022

A. Experimental conditions.

Area Scan	<u>dx=15mm dy=15mm, h= 5.00 mm</u>
ZoomScan	<u>5x5x7, dx=8mm dy=8mm dz=5mm</u>
Phantom	<u>Validation plane</u>
Device Position	<u>Body</u>
Band	<u>Band5_WCDMA850</u>
Channels	<u>Middle</u>
Signal	<u>WCDMA (Crest factor: 1.0)</u>
ConvF	<u>1.50</u>

B. SAR Measurement Results

Frequency (MHz)	836.400000
Relative permittivity (real part)	41.290737
Relative permittivity (imaginary part)	20.129421
Conductivity (S/m)	0.935347
Variation (%)	-0.650000

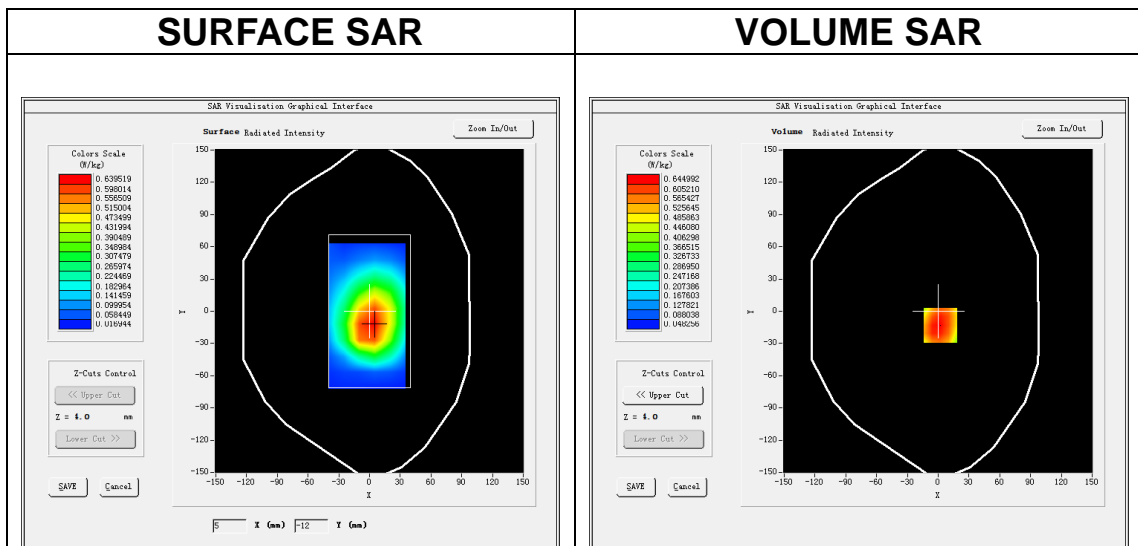

Maximum location: X=2.00, Y=-13.00
SAR Peak: 0.86 W/kg

SAR 10g (W/Kg)	0.440169
SAR 1g (W/Kg)	0.644405

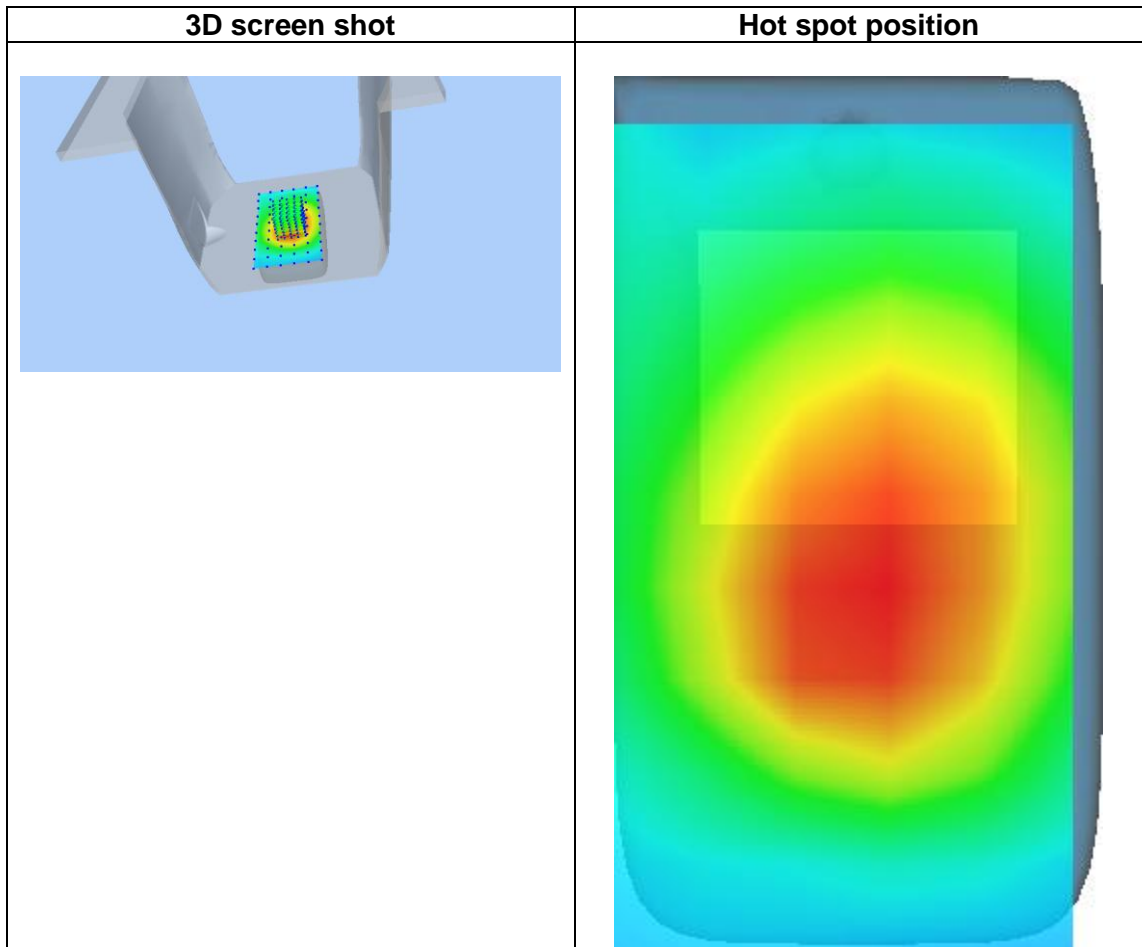
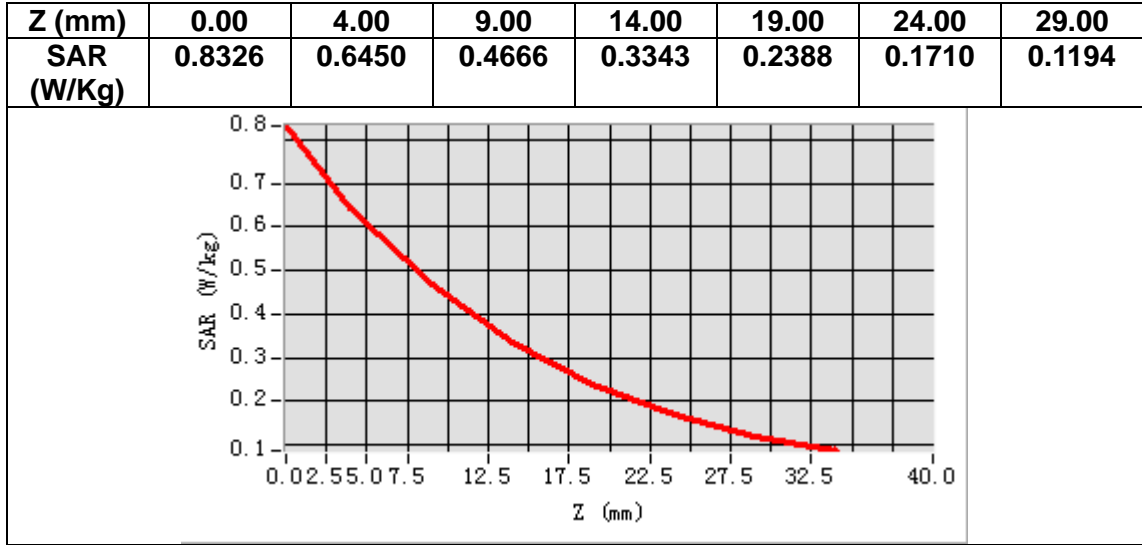

MEASUREMENT 11

Date of measurement: 9/12/2022

A. Experimental conditions.

Area Scan	<u>dx=15mm dy=15mm, h= 5.00 mm</u>
ZoomScan	<u>5x5x7, dx=8mm dy=8mm dz=5mm</u>
Phantom	<u>Left head</u>
Device Position	<u>Cheek</u>
Band	<u>LTE band 2</u>
Channels	<u>Low</u>
Signal	<u>LTE (Crest factor: 1.0)</u>
ConvF	<u>1.91</u>

B. SAR Measurement Results

Frequency (MHz)	1860.000000
Relative permittivity (real part)	38.967739
Relative permittivity (imaginary part)	13.791148
Conductivity (S/m)	1.424702
Variation (%)	-3.420000

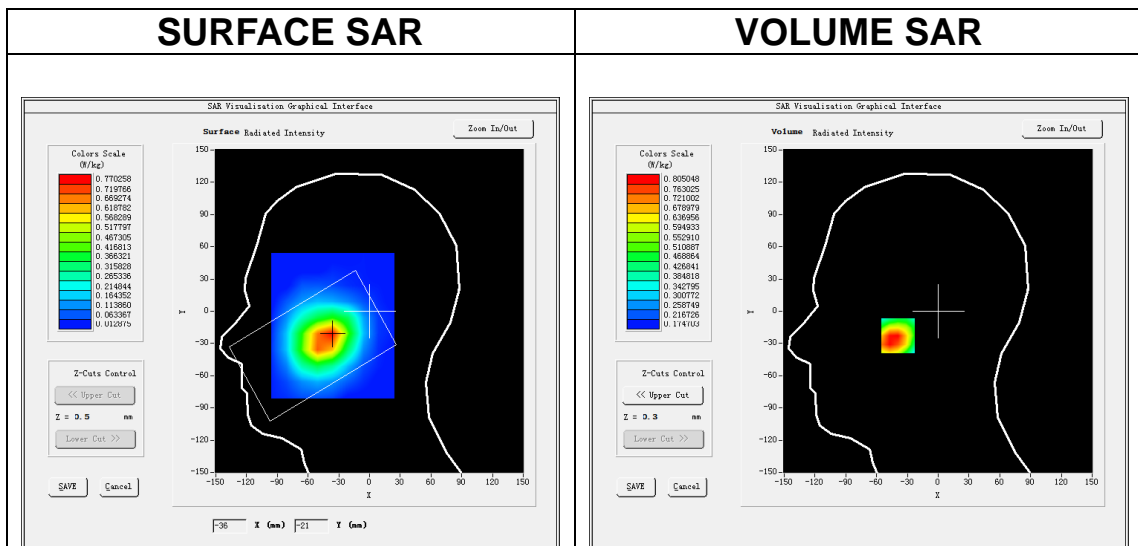

Maximum location: X=-39.00, Y=-23.00
SAR Peak: 1.04 W/kg

SAR 10g (W/Kg)	0.604542
SAR 1g (W/Kg)	0.812334

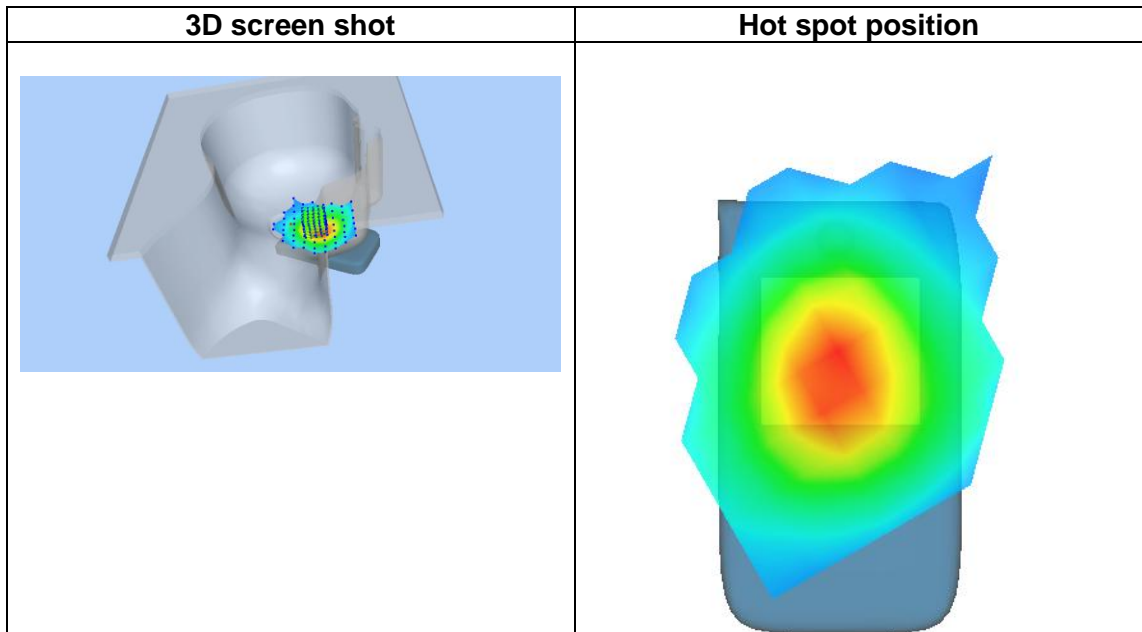
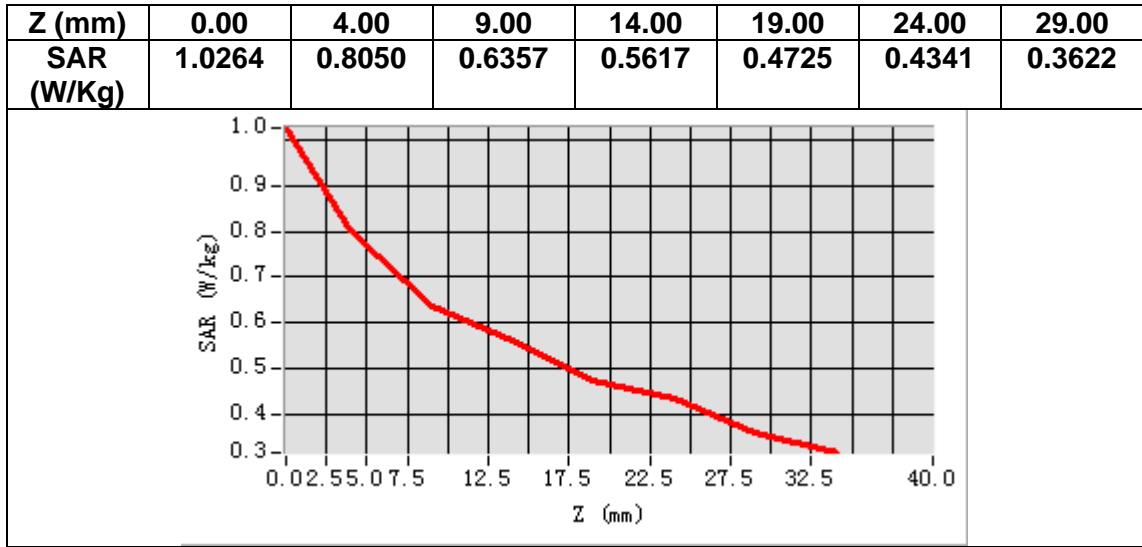

MEASUREMENT 12

Date of measurement: 9/12/2022

A. Experimental conditions.

Area Scan	<u>dx=15mm dy=15mm, h= 5.00 mm</u>
ZoomScan	<u>5x5x7, dx=8mm dy=8mm dz=5mm</u>
Phantom	<u>Validation plane</u>
Device Position	<u>Body</u>
Band	<u>LTE band 2</u>
Channels	<u>Middle</u>
Signal	<u>LTE (Crest factor: 1.0)</u>
ConvF	<u>1.91</u>

B. SAR Measurement Results

Frequency (MHz)	1880.000000
Relative permittivity (real part)	38.874592
Relative permittivity (imaginary part)	13.766348
Conductivity (S/m)	1.437436
Variation (%)	1.170000

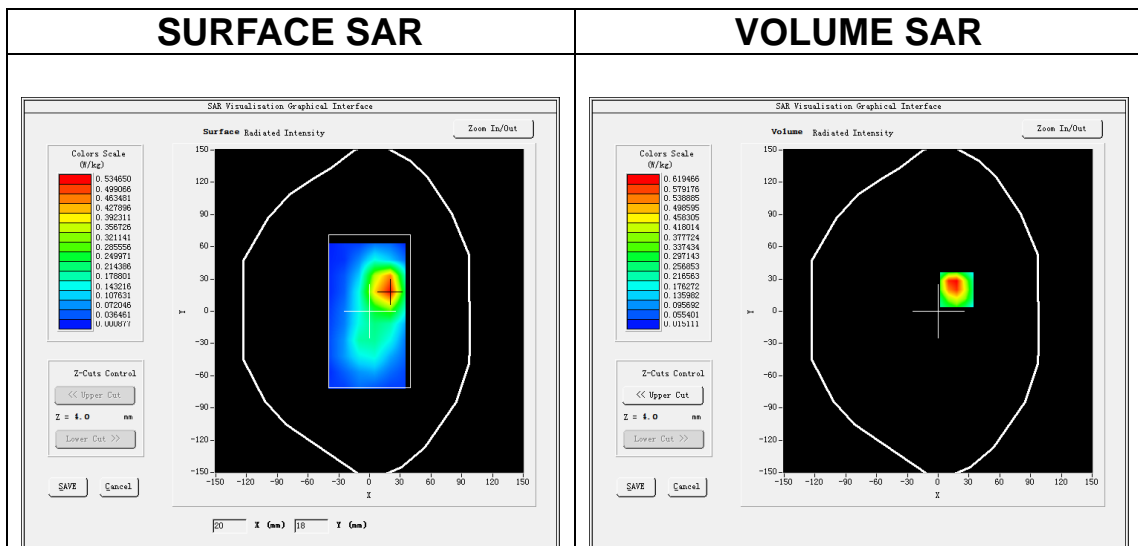

Maximum location: X=18.00, Y=20.00
SAR Peak: 1.05 W/kg

SAR 10g (W/Kg)	0.314230
SAR 1g (W/Kg)	0.621763

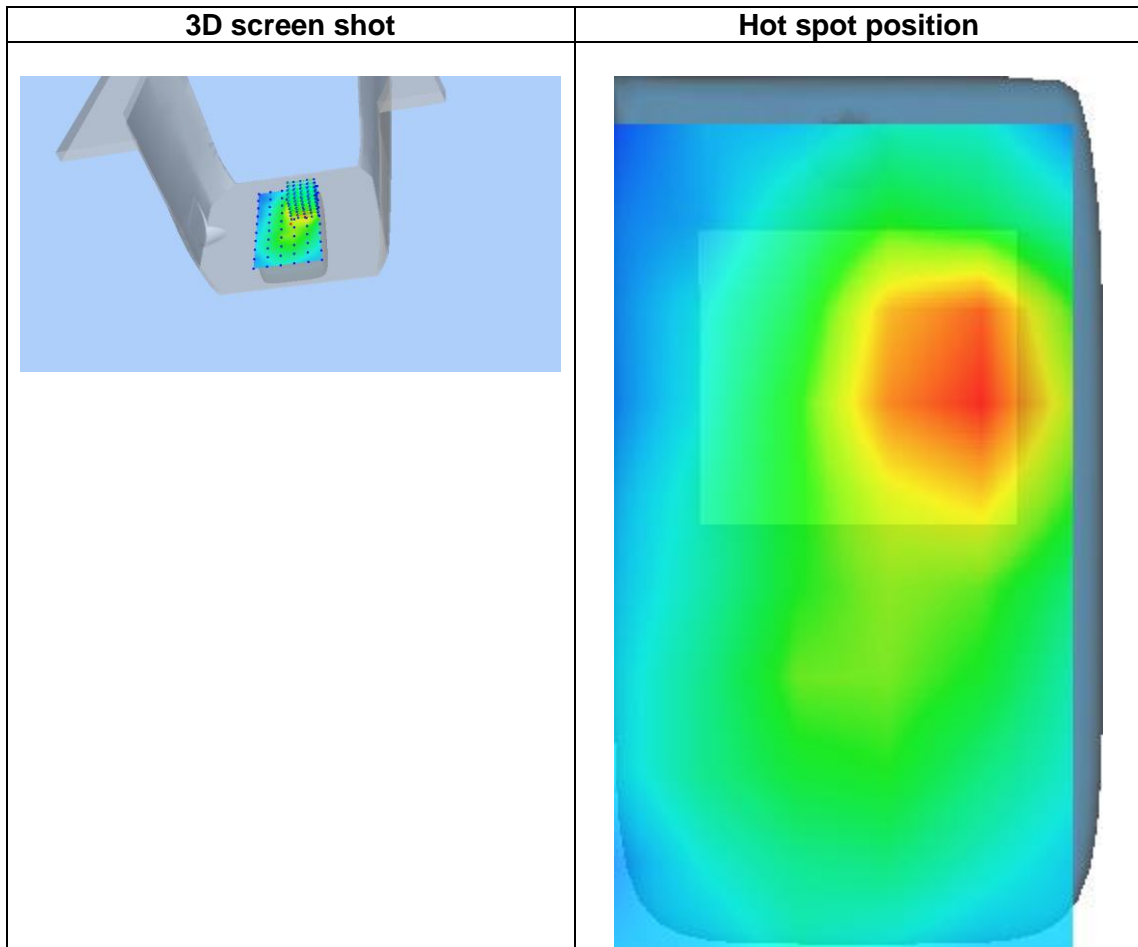
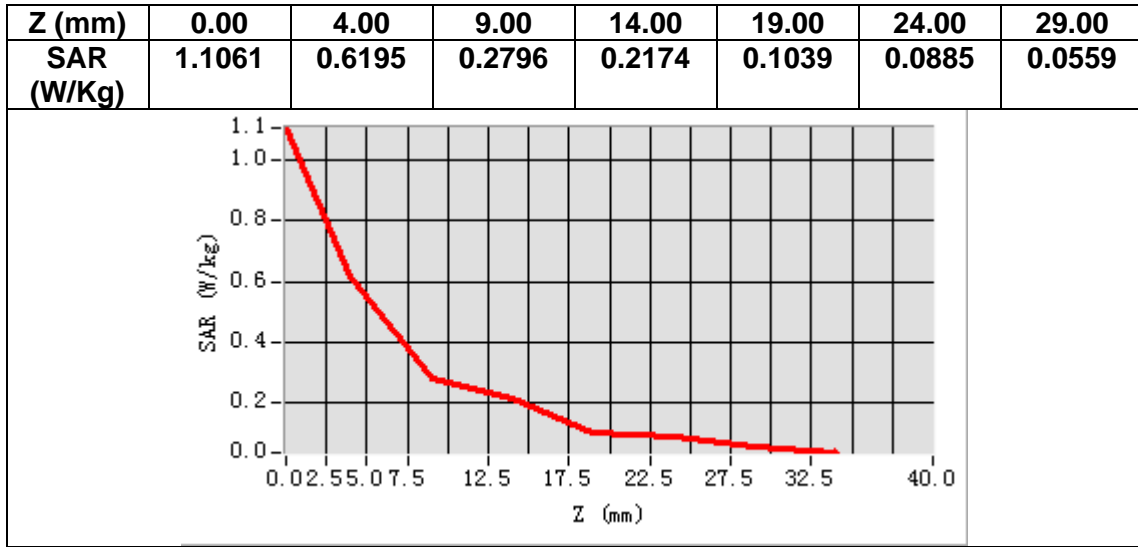

MEASUREMENT 13

Date of measurement: 16/12/2022

A. Experimental conditions.

Area Scan	<u>dx=15mm dy=15mm, h= 5.00 mm</u>
ZoomScan	<u>5x5x7,dx=8mm dy=8mm dz=5mm</u>
Phantom	<u>Left head</u>
Device Position	<u>Cheek</u>
Band	<u>LTE band 4</u>
Channels	<u>Middle</u>
Signal	<u>LTE (Crest factor: 1.0)</u>
ConvF	<u>1.73</u>

B. SAR Measurement Results

Frequency (MHz)	1732.500000
Relative permittivity (real part)	39.511227
Relative permittivity (imaginary part)	13.963222
Conductivity (S/m)	1.343960
Variation (%)	1.650000

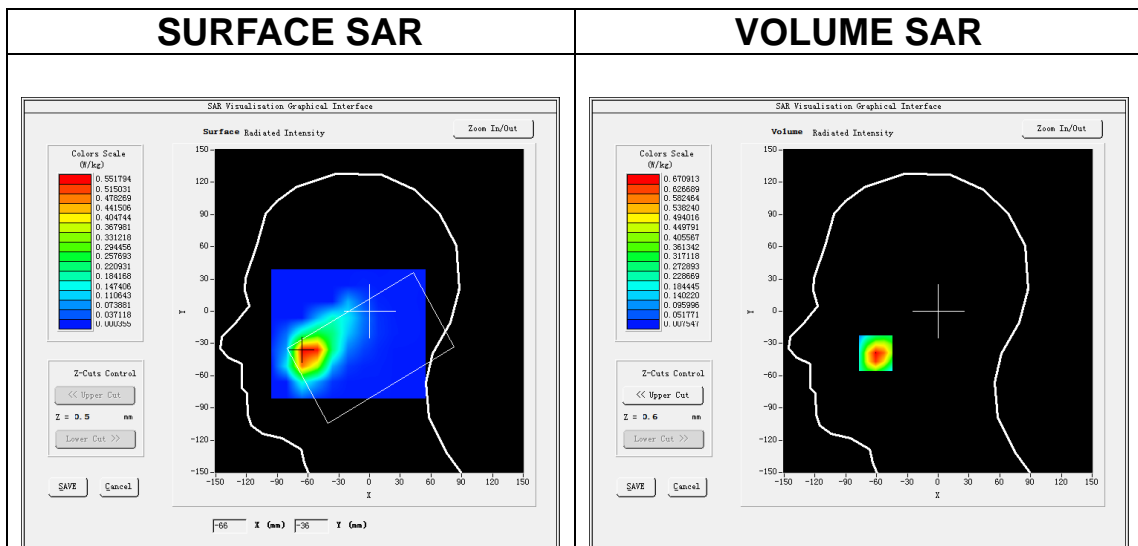

Maximum location: X=-61.00, Y=-39.00
SAR Peak: 0.98 W/kg

SAR 10g (W/Kg)	0.360480
SAR 1g (W/Kg)	0.644251

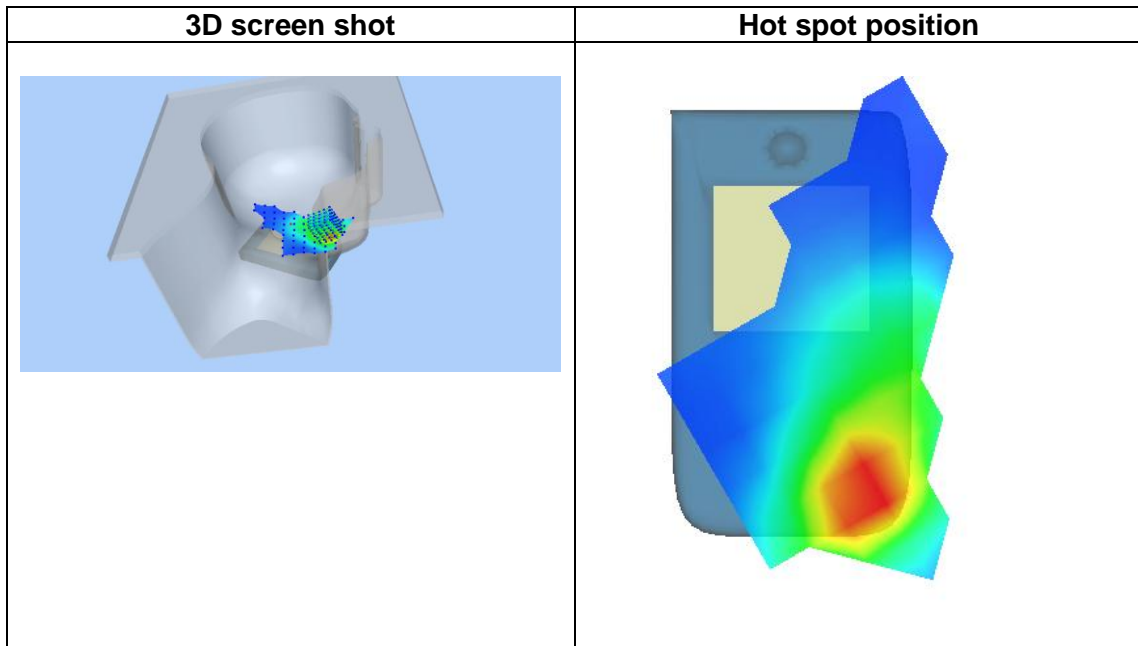
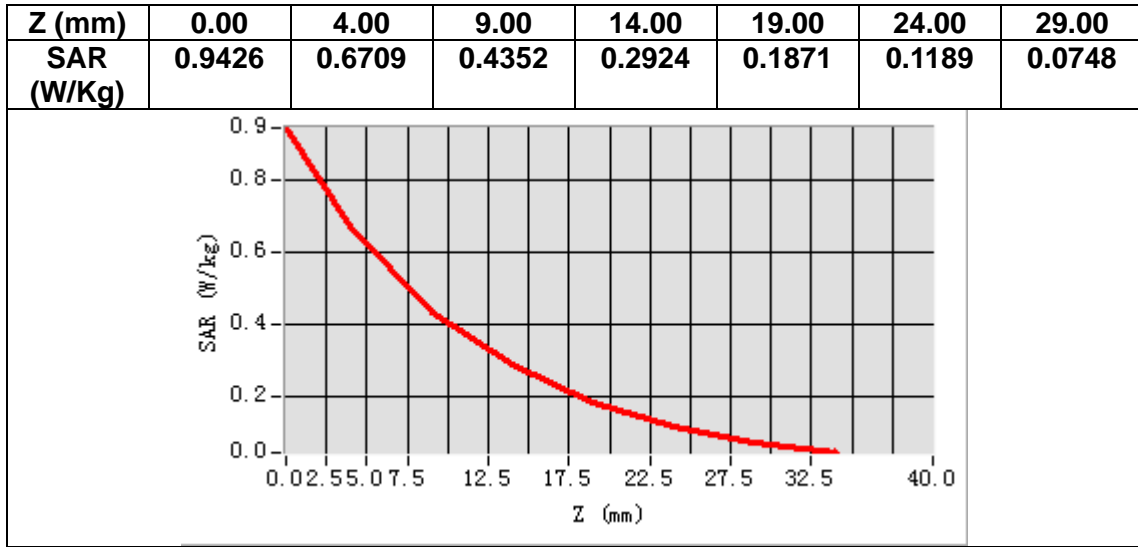

MEASUREMENT 14

Date of measurement: 16/12/2022

A. Experimental conditions.

Area Scan	<u>dx=15mm dy=15mm, h= 5.00 mm</u>
ZoomScan	<u>5x5x7, dx=8mm dy=8mm dz=5mm</u>
Phantom	<u>Validation plane</u>
Device Position	<u>Body</u>
Band	<u>LTE band 4</u>
Channels	<u>Low</u>
Signal	<u>LTE (Crest factor: 1.0)</u>
ConvF	<u>1.73</u>

B. SAR Measurement Results

Frequency (MHz)	1720.000000
Relative permittivity (real part)	39.643925
Relative permittivity (imaginary part)	13.921572
Conductivity (S/m)	1.329897
Variation (%)	-4.050000

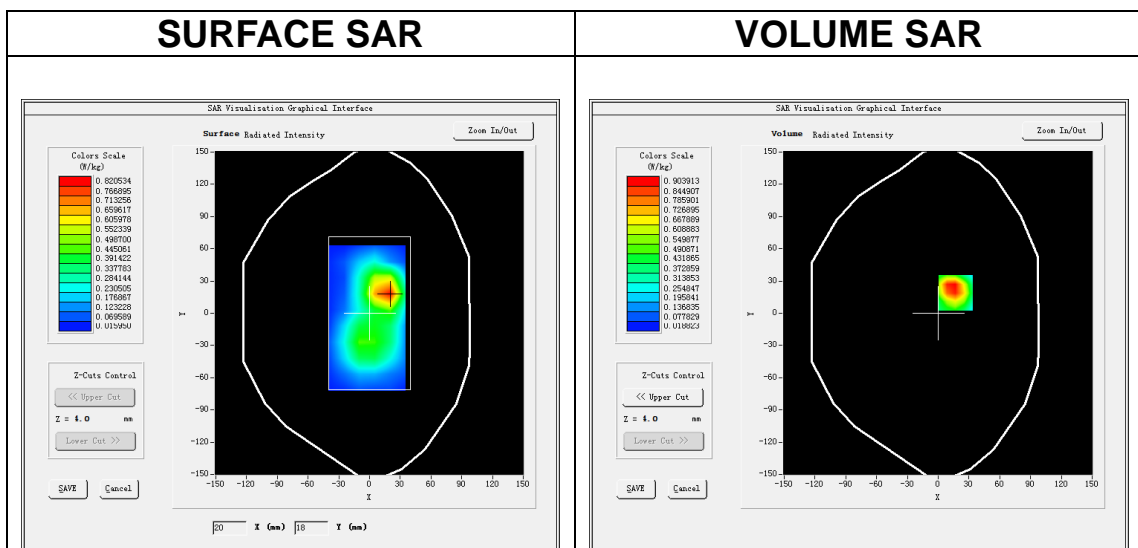

Maximum location: X=17.00, Y=19.00
SAR Peak: 1.42 W/kg

SAR 10g (W/Kg)	0.478299
SAR 1g (W/Kg)	0.890391

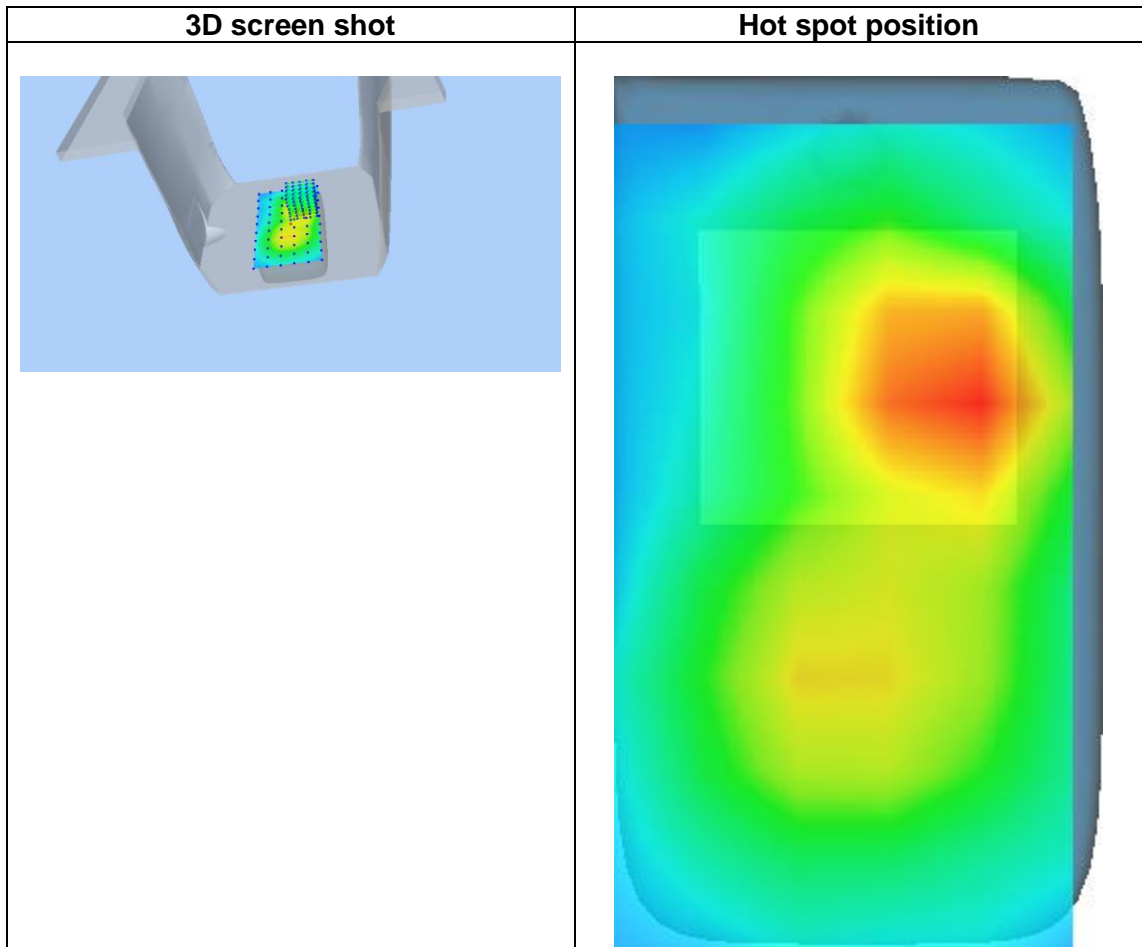
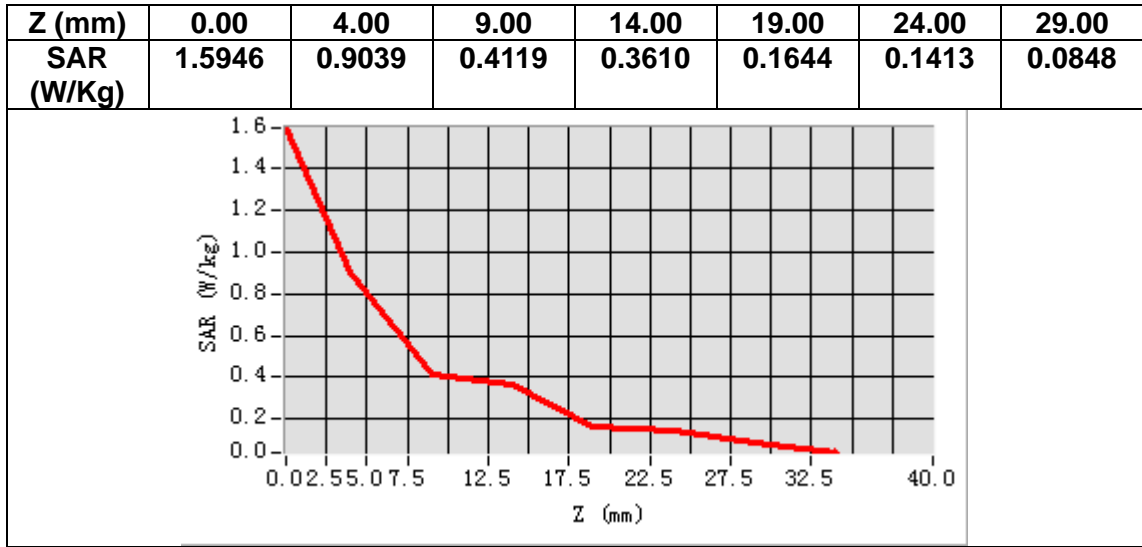

MEASUREMENT 15

Date of measurement: 12/12/2022

A. Experimental conditions.

Area Scan	<u>dx=15mm dy=15mm, h= 5.00 mm</u>
ZoomScan	<u>5x5x7,dx=8mm dy=8mm dz=5mm</u>
Phantom	<u>Left head</u>
Device Position	<u>Cheek</u>
Band	<u>LTE band 5</u>
Channels	<u>Middle</u>
Signal	<u>LTE (Crest factor: 1.0)</u>
ConvF	<u>1.50</u>

B. SAR Measurement Results

Frequency (MHz)	836.500000
Relative permittivity (real part)	41.293327
Relative permittivity (imaginary part)	20.128082
Conductivity (S/m)	0.935397
Variation (%)	-2.010000

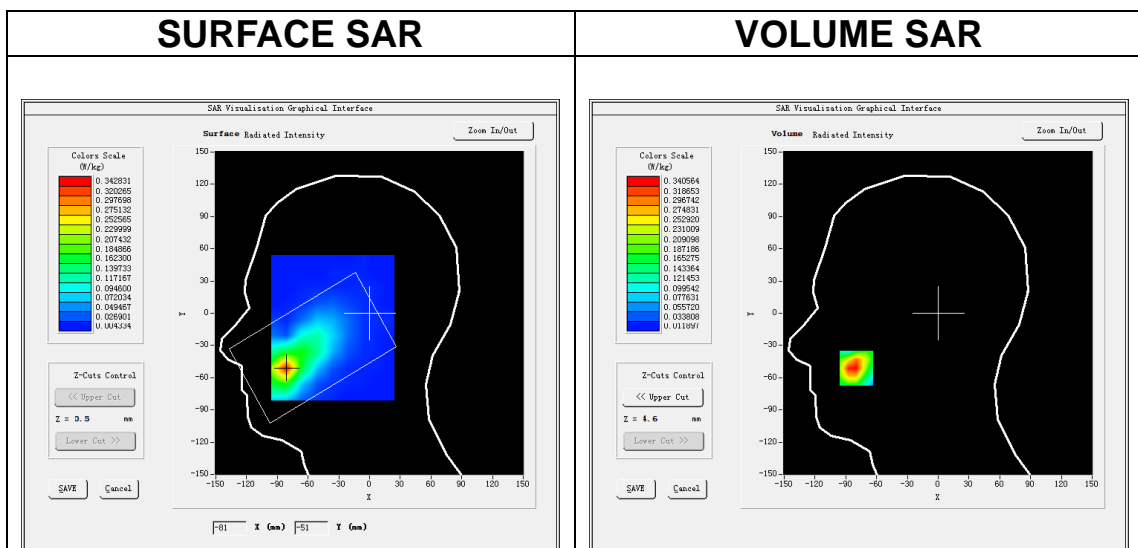

Maximum location: X=-80.00, Y=-51.00
SAR Peak: 0.59 W/kg

SAR 10g (W/Kg)	0.192031
SAR 1g (W/Kg)	0.351152

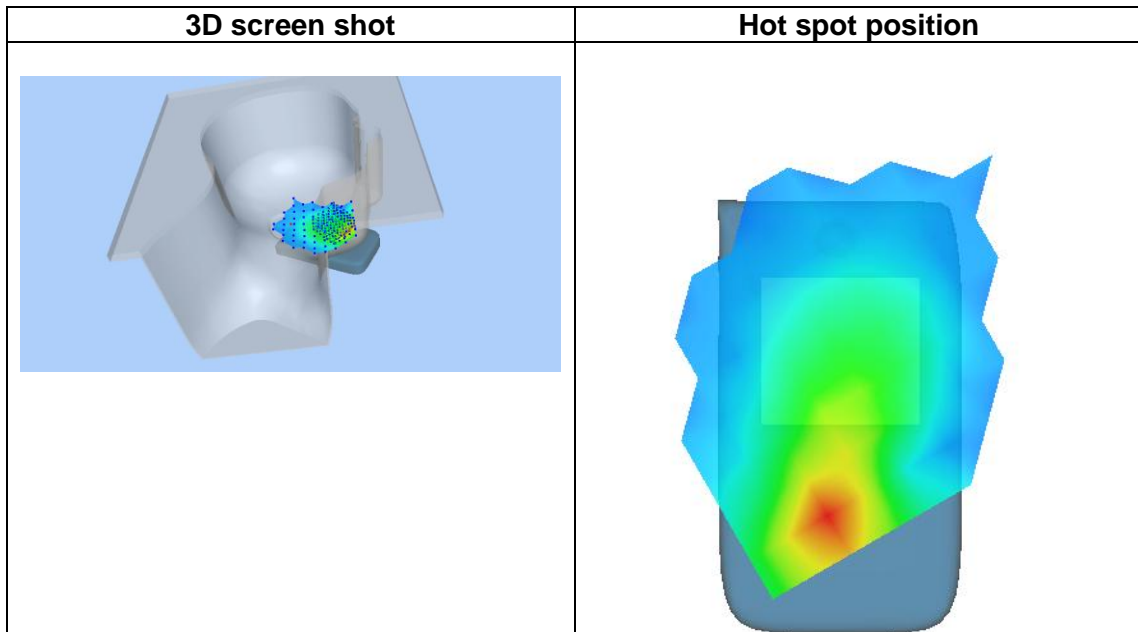
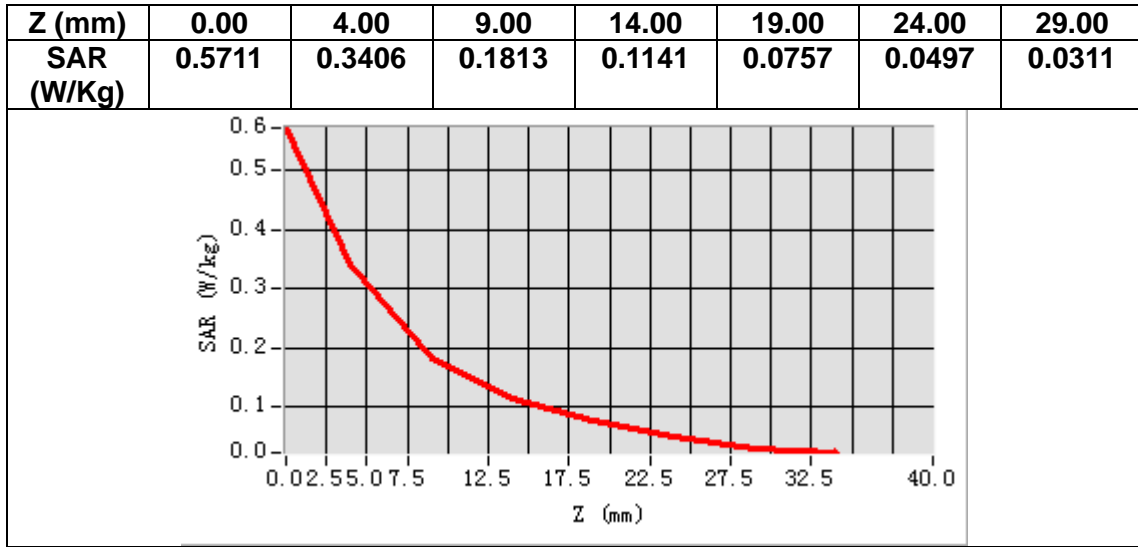

MEASUREMENT 16

Date of measurement: 12/12/2022

A. Experimental conditions.

Area Scan	<u>dx=15mm dy=15mm, h= 5.00 mm</u>
ZoomScan	<u>5x5x7, dx=8mm dy=8mm dz=5mm</u>
Phantom	<u>Validation plane</u>
Device Position	<u>Body</u>
Band	<u>LTE band 5</u>
Channels	<u>Middle</u>
Signal	<u>LTE (Crest factor: 1.0)</u>
ConvF	<u>1.50</u>

B. SAR Measurement Results

Frequency (MHz)	836.500000
Relative permittivity (real part)	41.293327
Relative permittivity (imaginary part)	20.128082
Conductivity (S/m)	0.935397
Variation (%)	0.400000

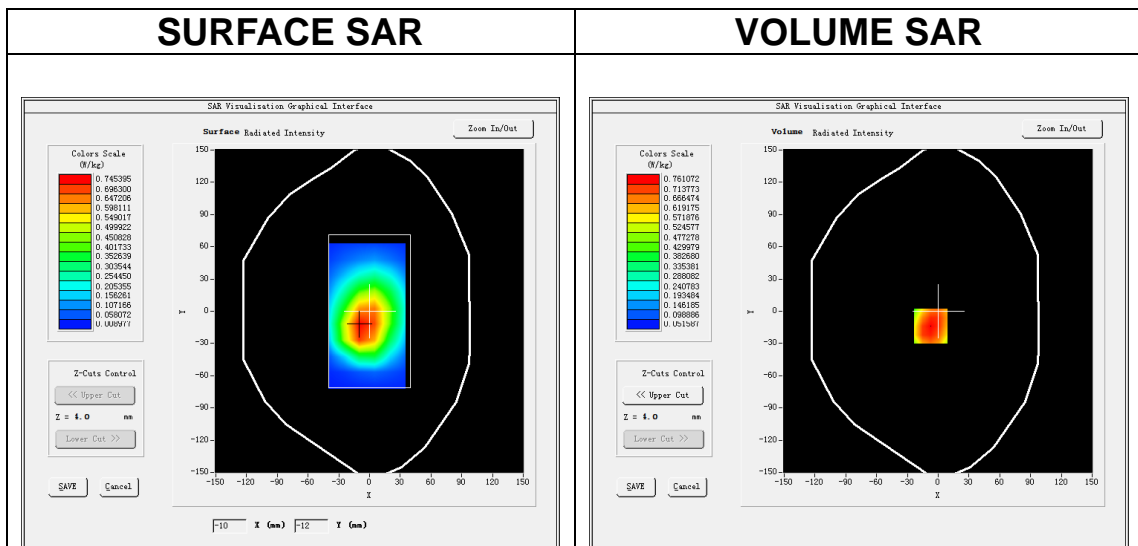

Maximum location: X=-7.00, Y=-14.00
SAR Peak: 1.15 W/kg

SAR 10g (W/Kg)	0.493462
SAR 1g (W/Kg)	0.763088

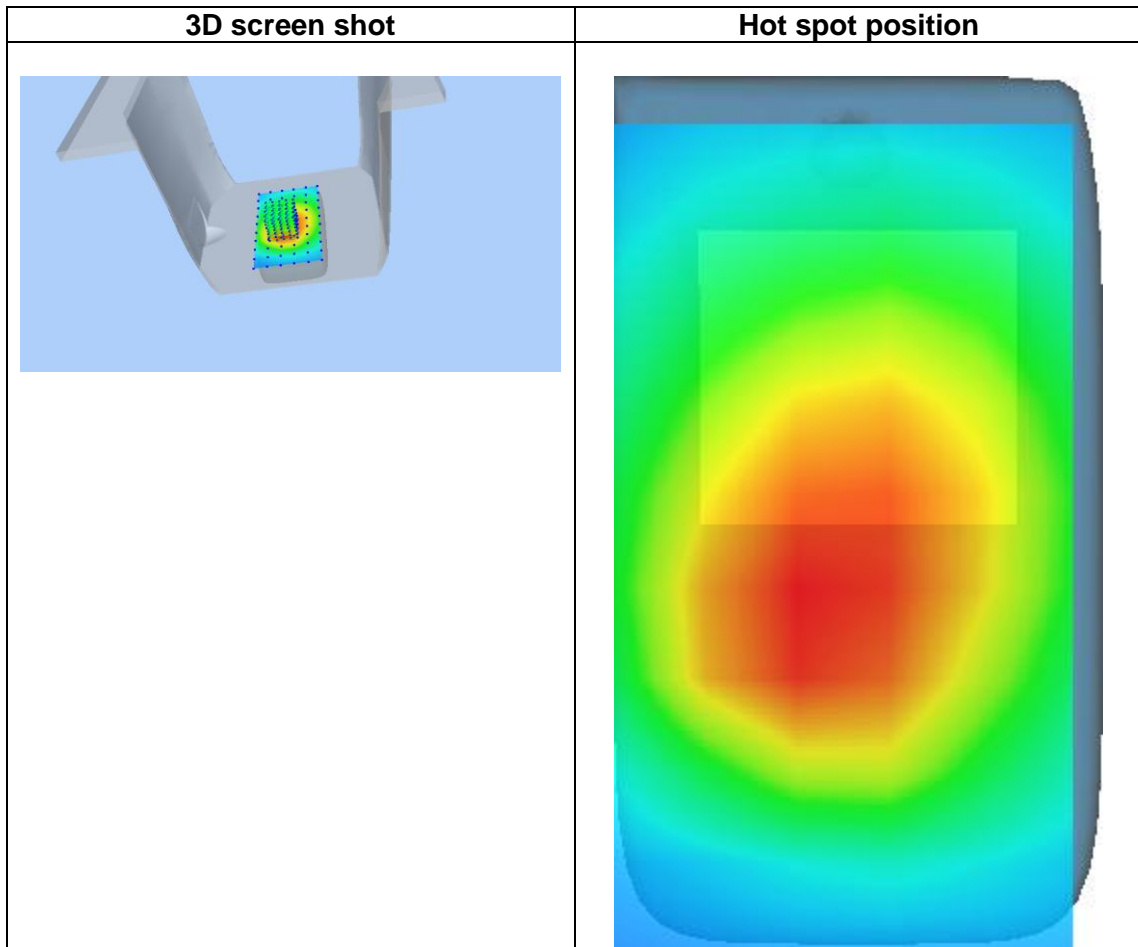
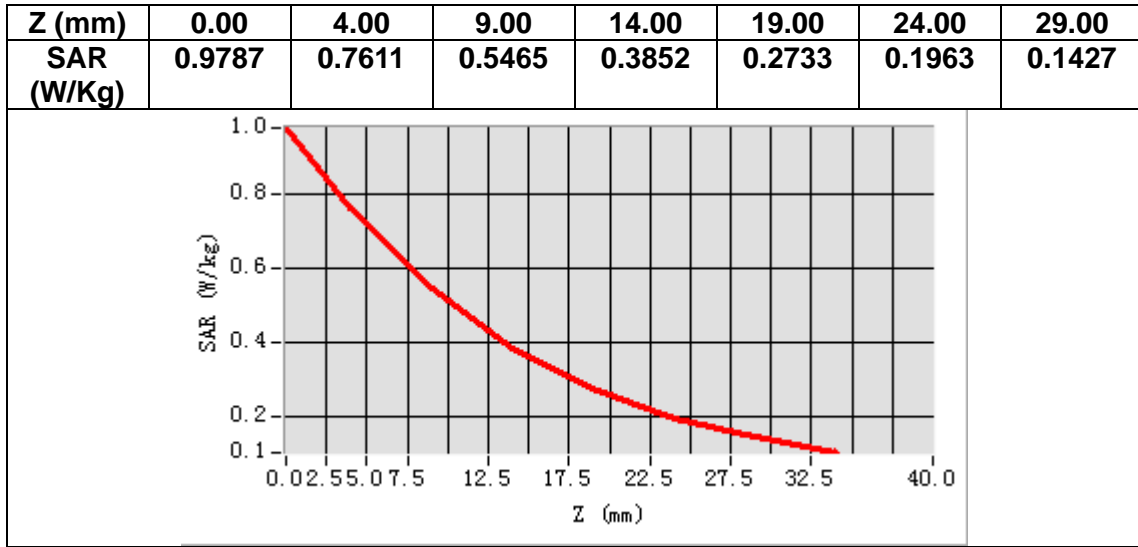

MEASUREMENT 17

Date of measurement: 8/12/2022

A. Experimental conditions.

Area Scan	<u>dx=12mm dy=12mm, h= 5.00 mm</u>
ZoomScan	<u>7x7x7,dx=5mm dy=5mm dz=5mm</u>
Phantom	<u>Left head</u>
Device Position	<u>Cheek</u>
Band	<u>LTE band 7</u>
Channels	<u>Low</u>
Signal	<u>LTE (Crest factor: 1.0)</u>
ConvF	<u>1.87</u>

B. SAR Measurement Results

Frequency (MHz)	2510.000000
Relative permittivity (real part)	38.532204
Relative permittivity (imaginary part)	13.522522
Conductivity (S/m)	1.885641
Variation (%)	-2.390000

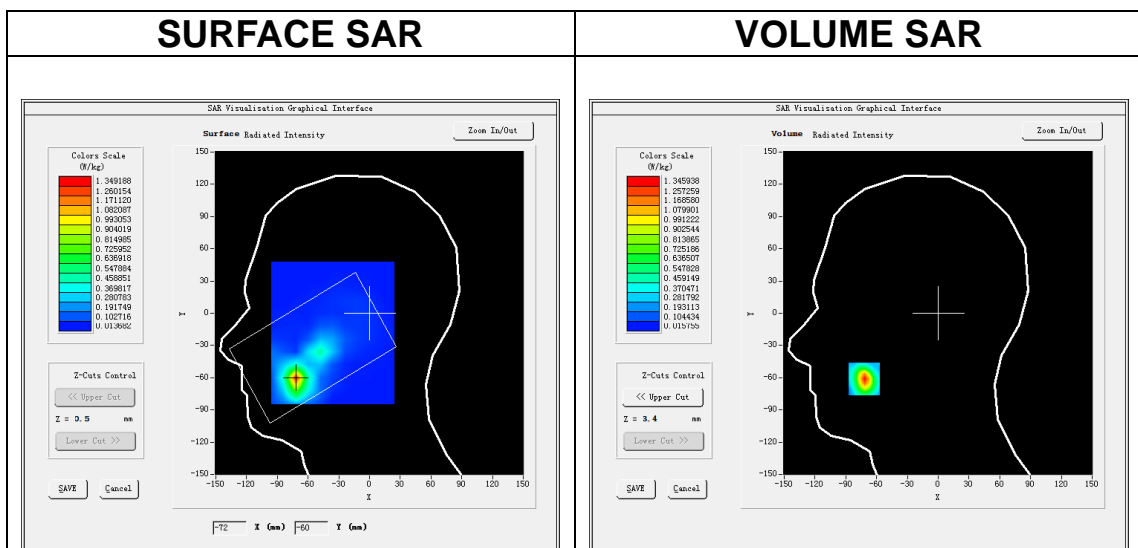

Maximum location: X=-72.00, Y=-61.00
SAR Peak: 2.38 W/kg

SAR 10g (W/Kg)	0.488073
SAR 1g (W/Kg)	1.184809

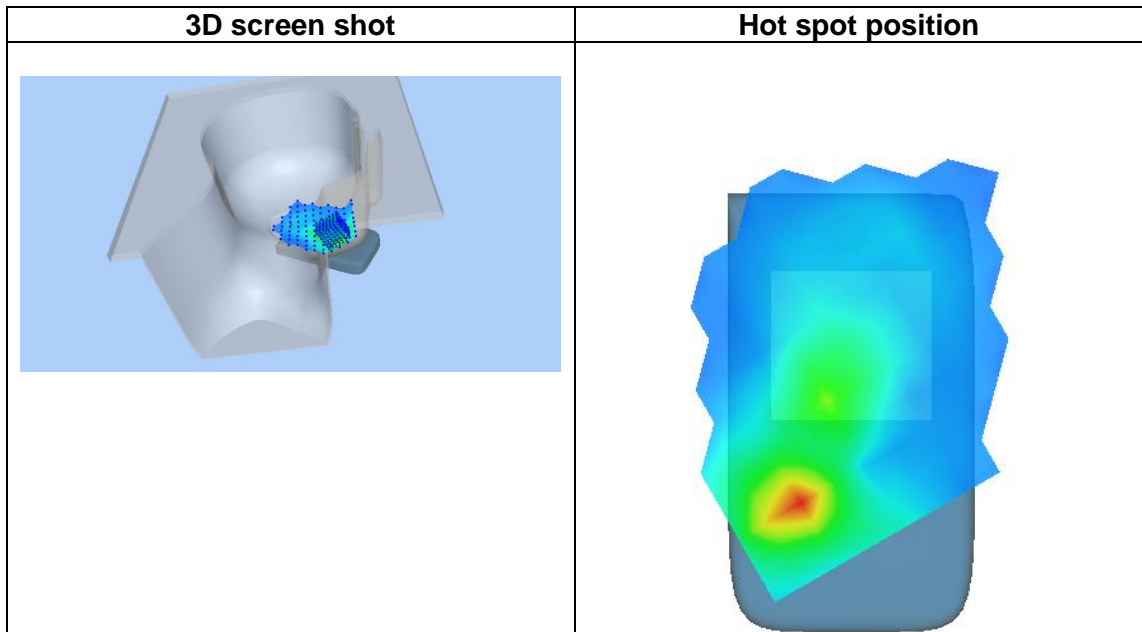
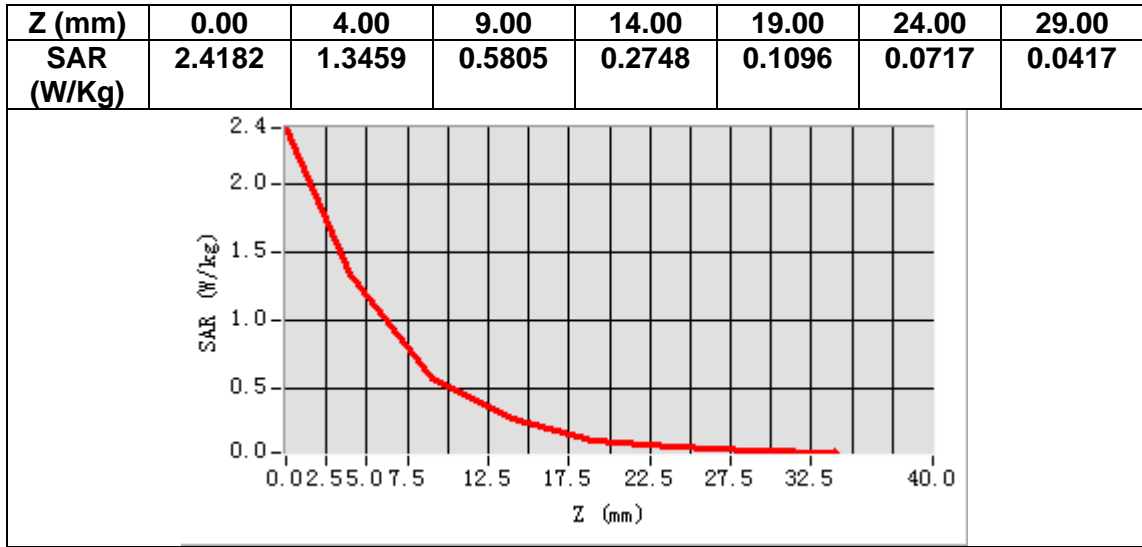

MEASUREMENT 18

Date of measurement: 8/12/2022

A. Experimental conditions.

Area Scan	<u>dx=12mm dy=12mm, h= 5.00 mm</u>
ZoomScan	<u>7x7x7, dx=5mm dy=5mm dz=5mm</u>
Phantom	<u>Validation plane</u>
Device Position	<u>Body</u>
Band	<u>LTE band 7</u>
Channels	<u>High</u>
Signal	<u>LTE (Crest factor: 1.0)</u>
ConvF	<u>1.87</u>

B. SAR Measurement Results

Frequency (MHz)	2560.000000
Relative permittivity (real part)	38.264606
Relative permittivity (imaginary part)	13.647522
Conductivity (S/m)	1.940981
Variation (%)	-1.550000

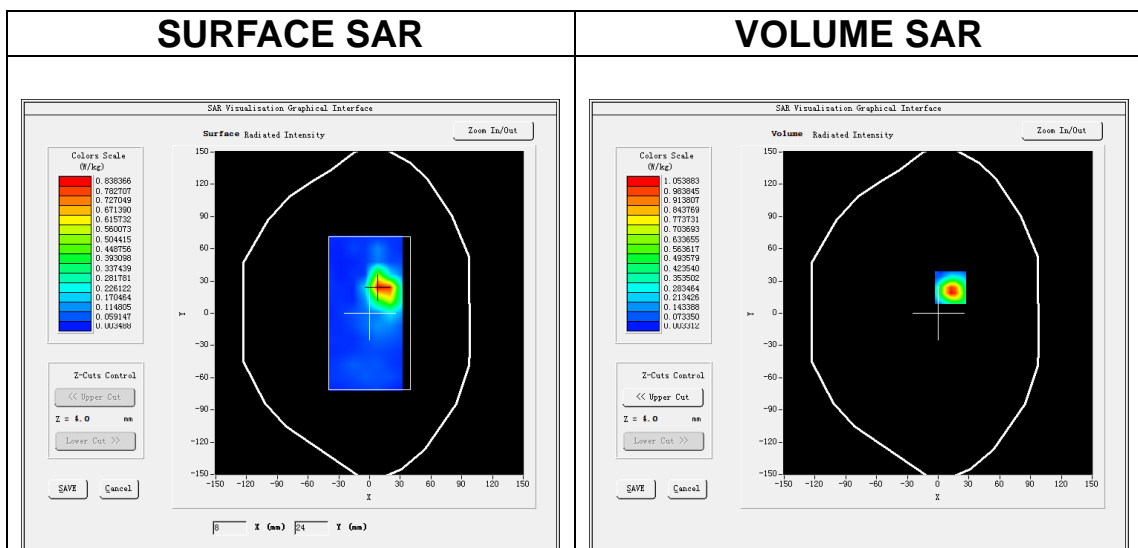

Maximum location: X=12.00, Y=24.00
SAR Peak: 1.83 W/kg

SAR 10g (W/Kg)	0.396532
SAR 1g (W/Kg)	0.965225

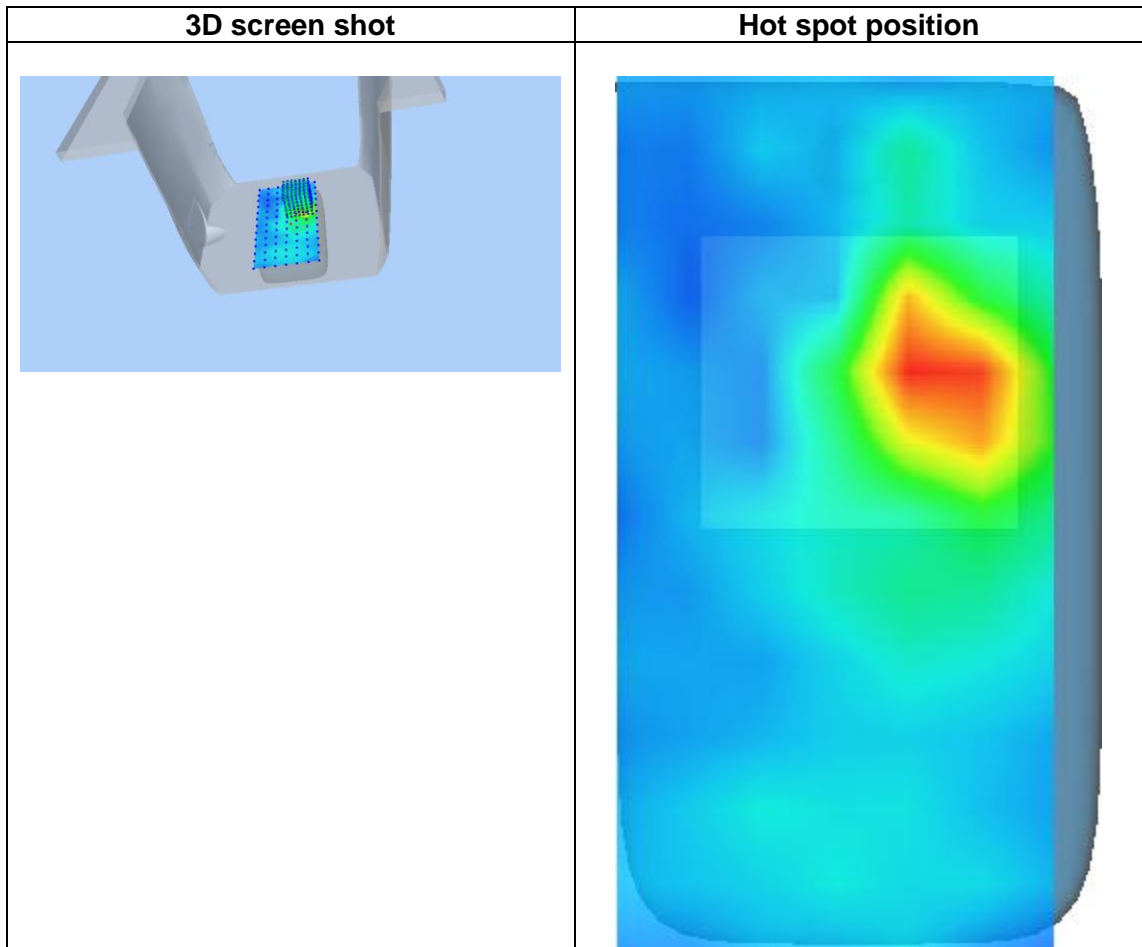
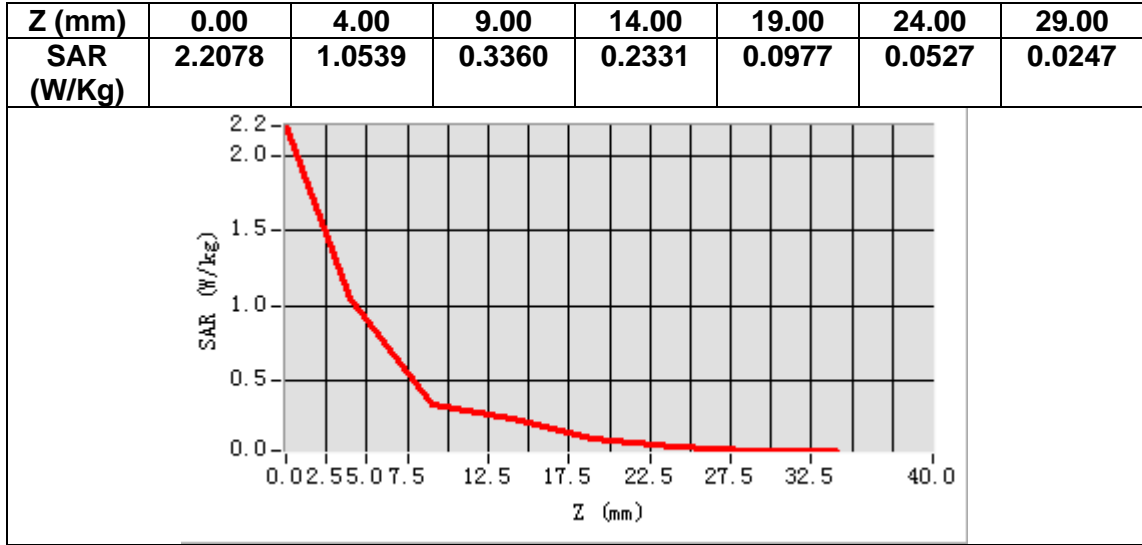

MEASUREMENT 19

Date of measurement: 16/12/2022

A. Experimental conditions.

Area Scan	<u>dx=15mm dy=15mm, h= 5.00 mm</u>
ZoomScan	<u>5x5x7, dx=8mm dy=8mm dz=5mm</u>
Phantom	<u>Left head</u>
Device Position	<u>Cheek</u>
Band	<u>LTE band 66</u>
Channels	<u>Middle</u>
Signal	<u>LTE (Crest factor: 1.0)</u>
ConvF	<u>1.73</u>

B. SAR Measurement Results

Frequency (MHz)	1745.000000
Relative permittivity (real part)	39.439426
Relative permittivity (imaginary part)	13.960772
Conductivity (S/m)	1.353419
Variation (%)	-0.030000

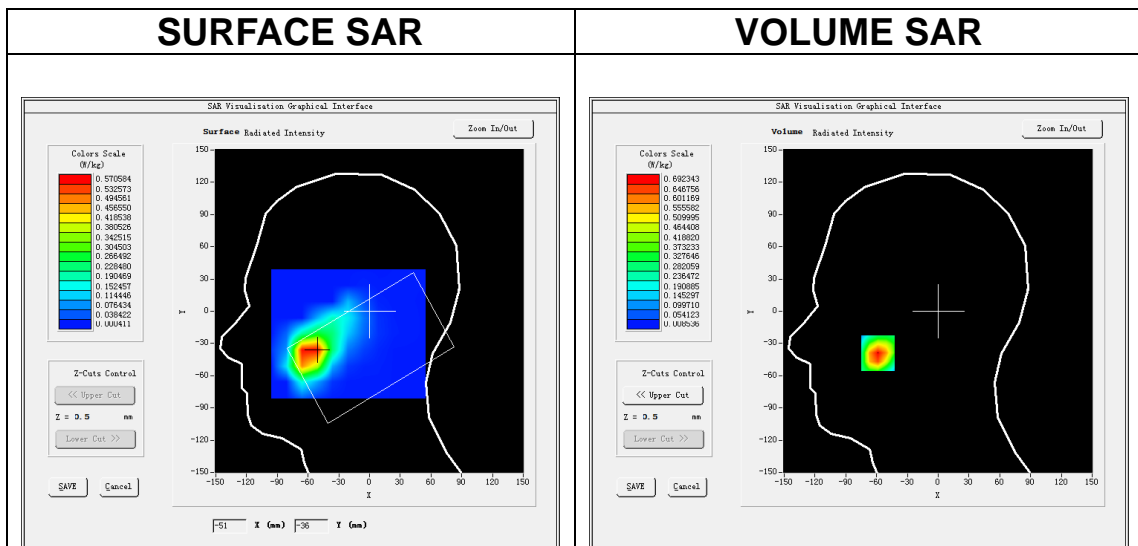

Maximum location: X=-59.00, Y=-39.00
SAR Peak: 0.99 W/kg

SAR 10g (W/Kg)	0.372632
SAR 1g (W/Kg)	0.660590

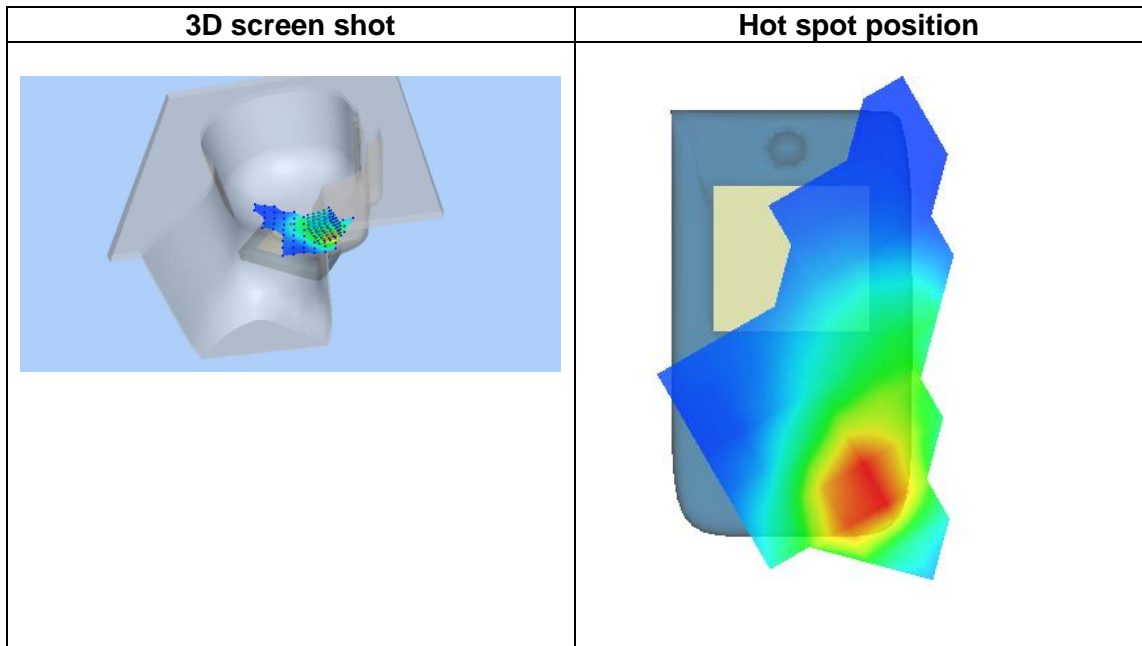
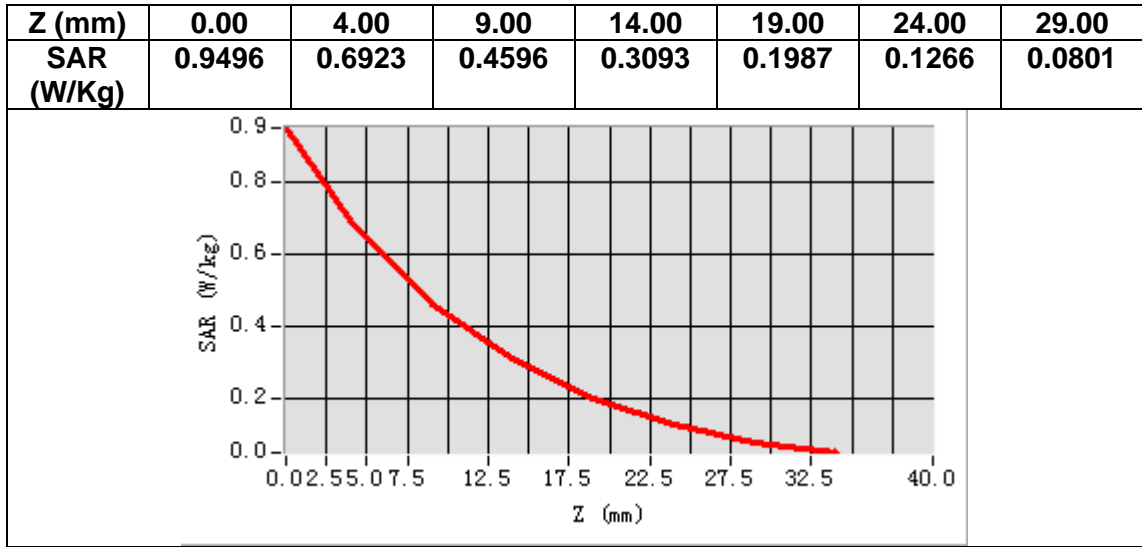

MEASUREMENT 20

Date of measurement: 16/12/2022

A. Experimental conditions.

Area Scan	<u>dx=15mm dy=15mm, h= 5.00 mm</u>
ZoomScan	<u>5x5x7, dx=8mm dy=8mm dz=5mm</u>
Phantom	<u>Validation plane</u>
Device Position	<u>Body</u>
Band	<u>LTE band 66</u>
Channels	<u>Middle</u>
Signal	<u>LTE (Crest factor: 1.0)</u>
ConvF	<u>1.73</u>

B. SAR Measurement Results

Frequency (MHz)	1720.000000
Relative permittivity (real part)	39.633626
Relative permittivity (imaginary part)	13.953872
Conductivity (S/m)	1.333370
Variation (%)	-2.940000

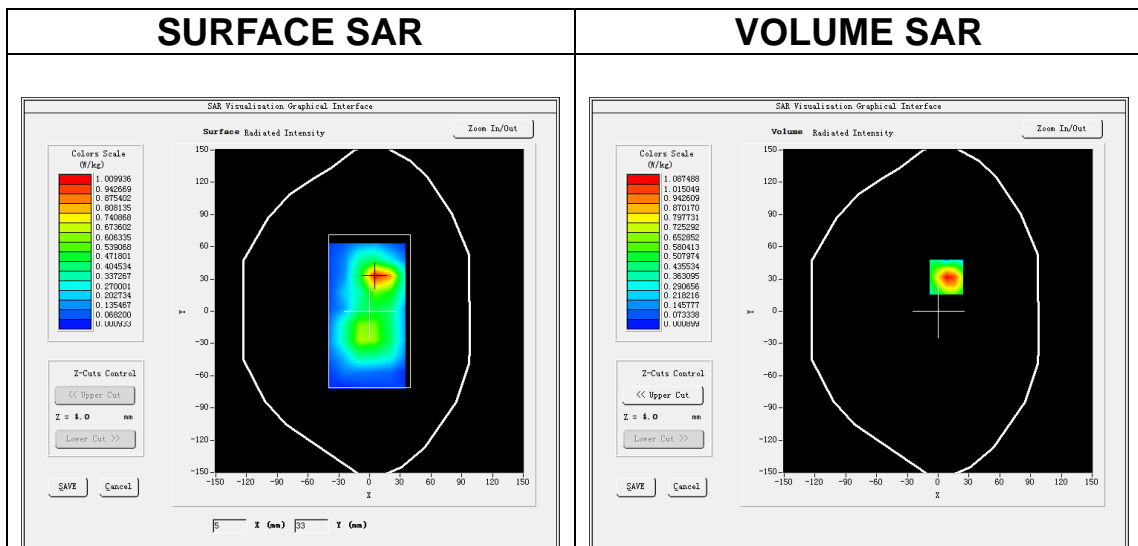

Maximum location: X=8.00, Y=32.00
SAR Peak: 1.58 W/kg

SAR 10g (W/Kg)	0.557283
SAR 1g (W/Kg)	1.015211

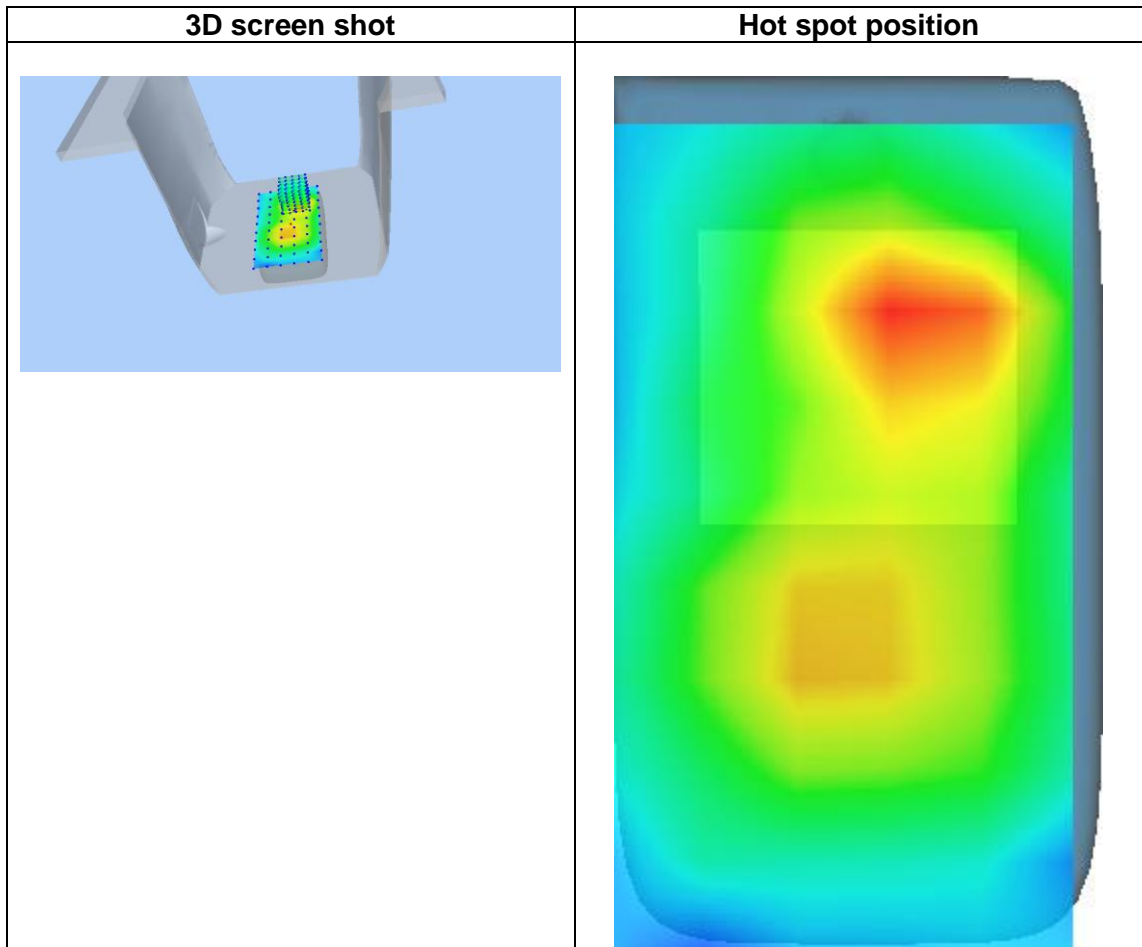
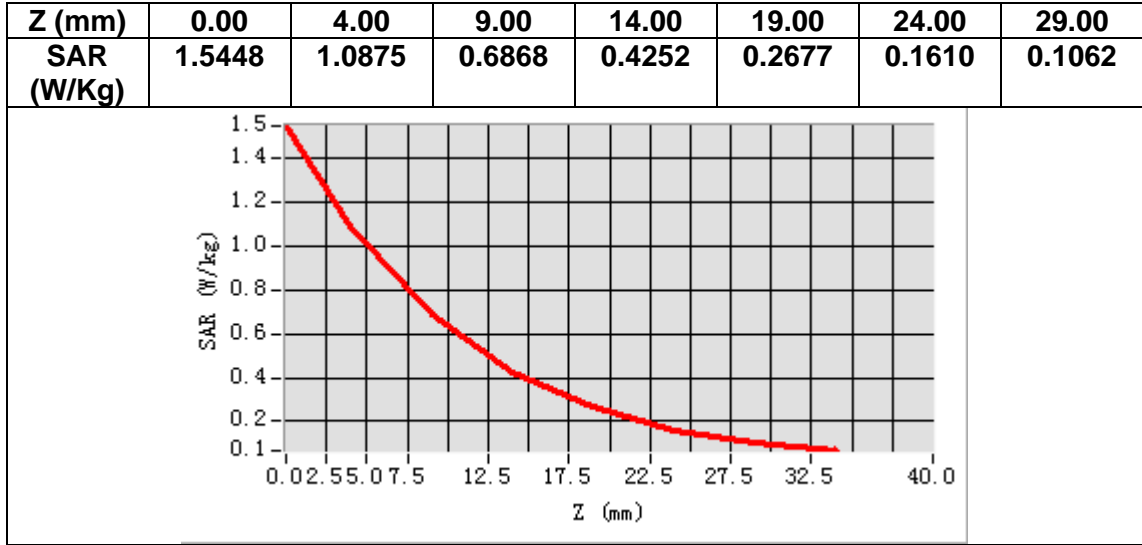

MEASUREMENT 21

Date of measurement: 12/08/2022

A. Experimental conditions.

Area Scan	<u>dx=12mm dy=12mm, h= 5.00 mm</u>
ZoomScan	<u>7x7x7,dx=5mm dy=5mm dz=5mm</u>
Phantom	<u>Left head</u>
Device Position	<u>Cheek</u>
Band	<u>LTE band 38</u>
Channels	<u>Middle</u>
Signal	<u>LTE (Crest factor: 1.0)</u>
ConvF	<u>1.87</u>

B. SAR Measurement Results

Frequency (MHz)	2595.000000
Relative permittivity (real part)	38.049205
Relative permittivity (imaginary part)	13.793622
Conductivity (S/m)	1.988581
Variation (%)	0.630000

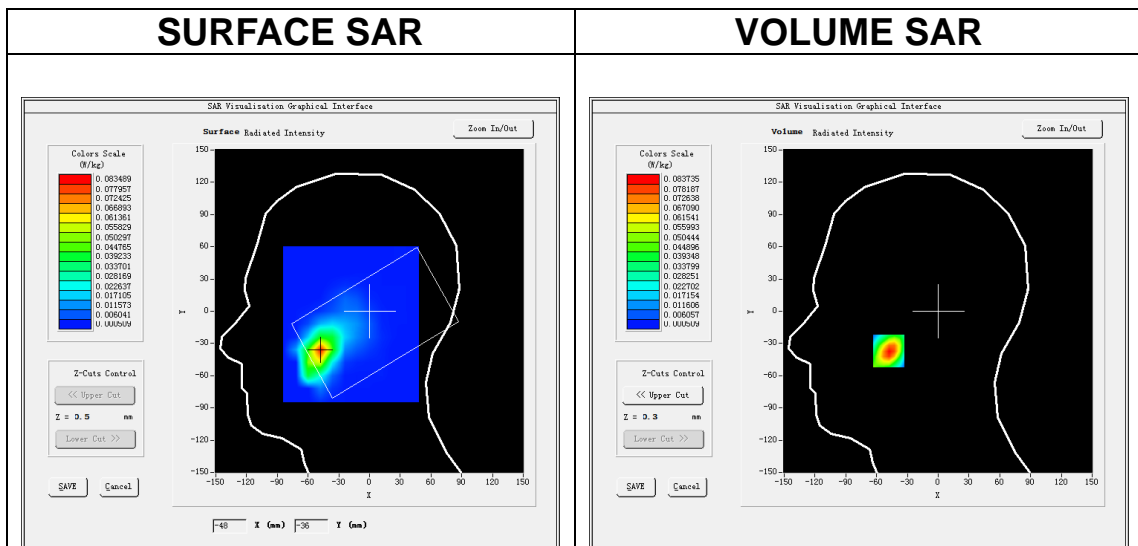

Maximum location: X=-48.00, Y=-37.00
SAR Peak: 0.14 W/kg

SAR 10g (W/Kg)	0.035150
SAR 1g (W/Kg)	0.077985

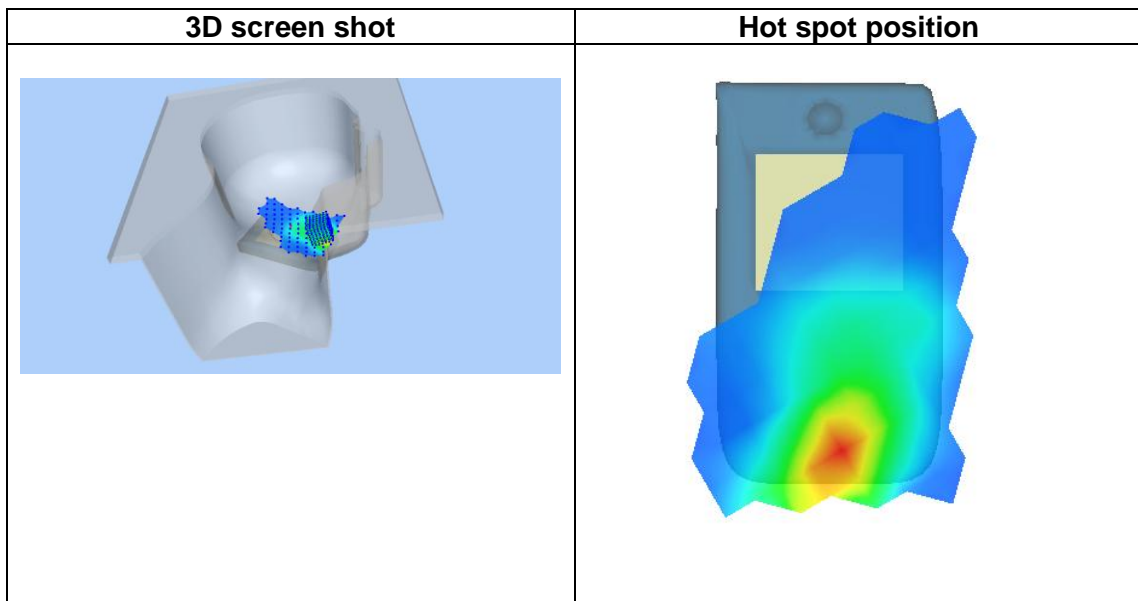
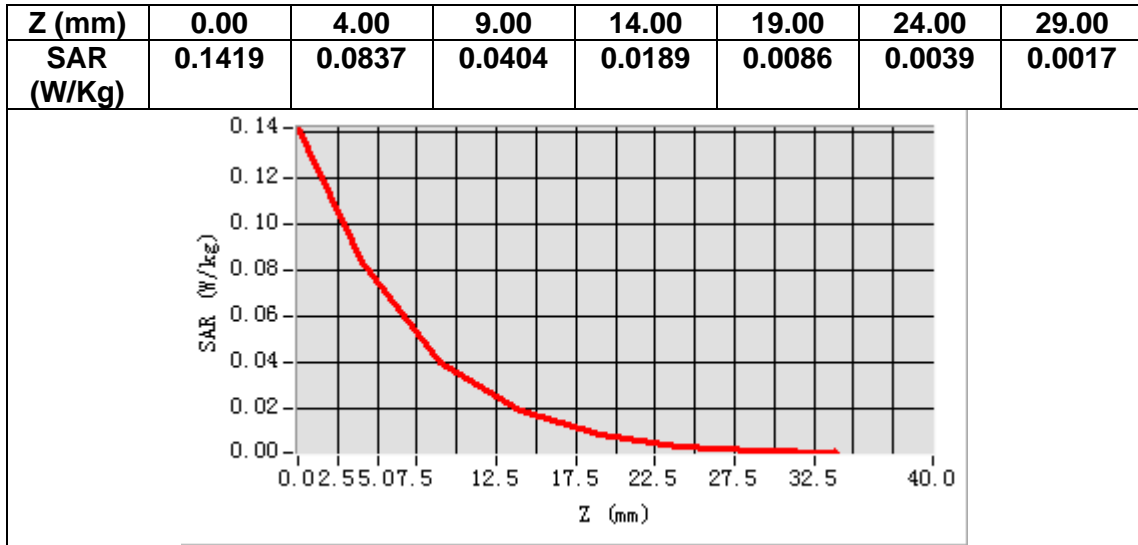

MEASUREMENT 22

Date of measurement: 12/12/2022

A. Experimental conditions.

Area Scan	<u>dx=12mm dy=12mm, h= 5.00 mm</u>
ZoomScan	<u>7x7x7, dx=5mm dy=5mm dz=5mm</u>
Phantom	<u>Validation plane</u>
Device Position	<u>Body</u>
Band	<u>LTE band 38</u>
Channels	<u>Middle</u>
Signal	<u>LTE (Crest factor: 1.0)</u>
ConvF	<u>1.87</u>

B. SAR Measurement Results

Frequency (MHz)	2595.000000
Relative permittivity (real part)	38.049205
Relative permittivity (imaginary part)	13.793622
Conductivity (S/m)	1.988581
Variation (%)	-1.600000

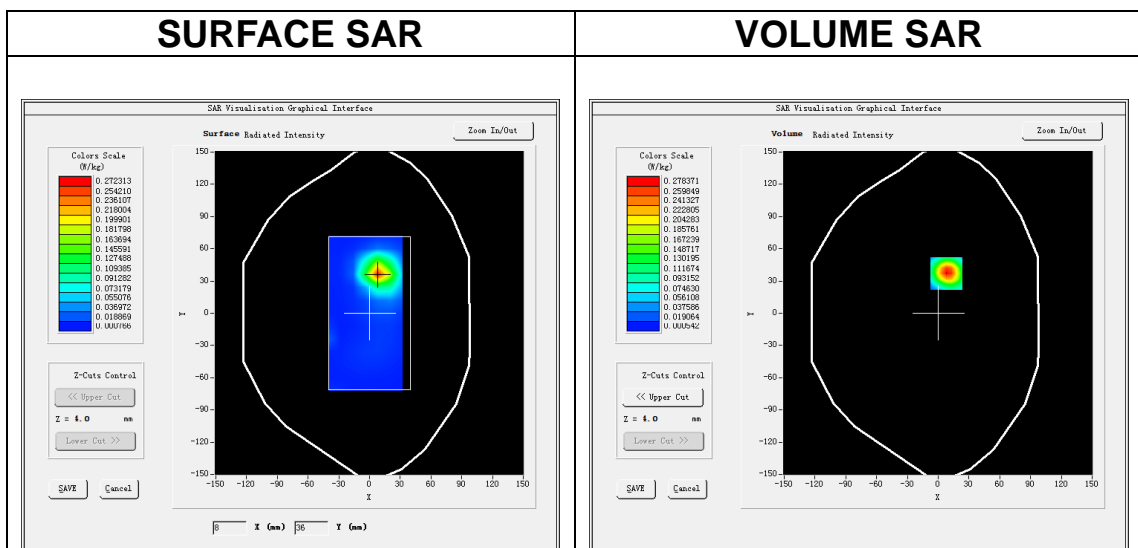

Maximum location: X=8.00, Y=37.00
SAR Peak: 0.50 W/kg

SAR 10g (W/Kg)	0.110591
SAR 1g (W/Kg)	0.261919

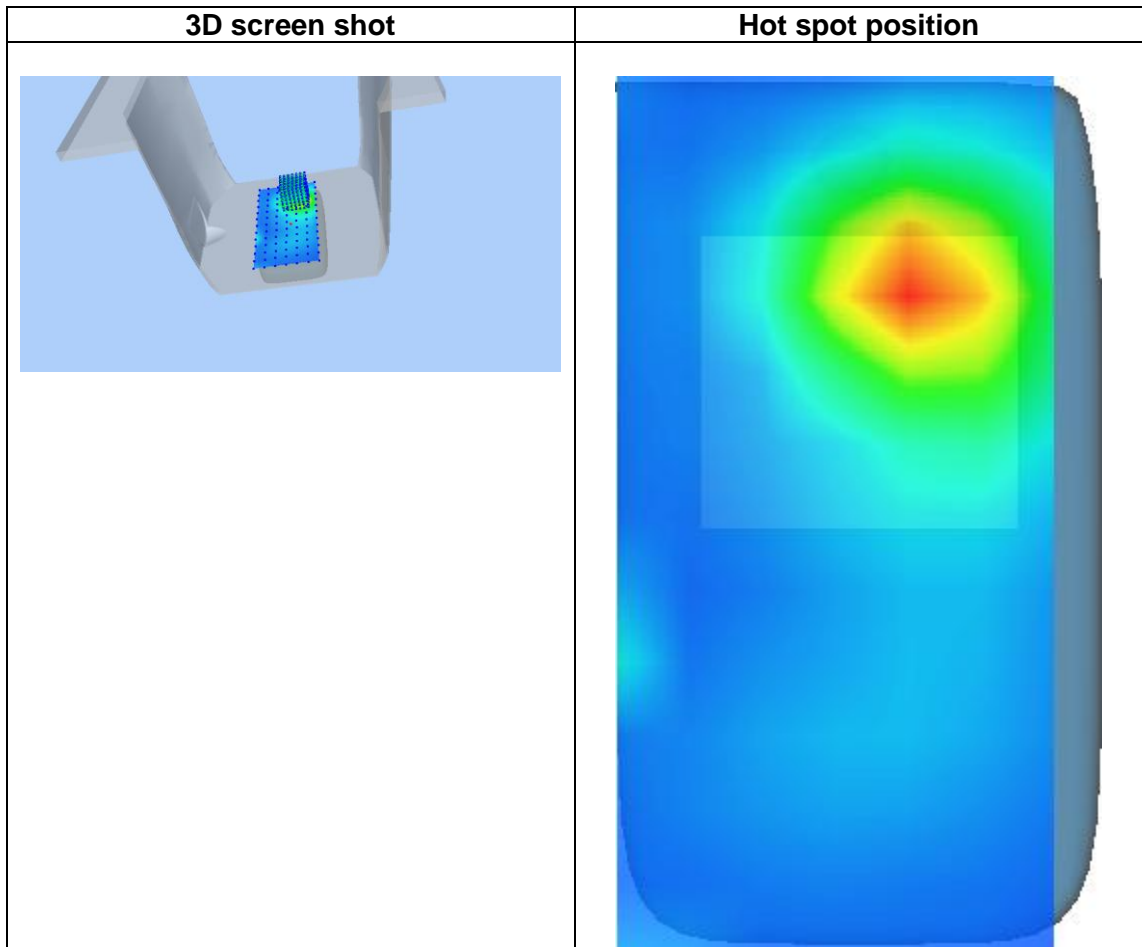
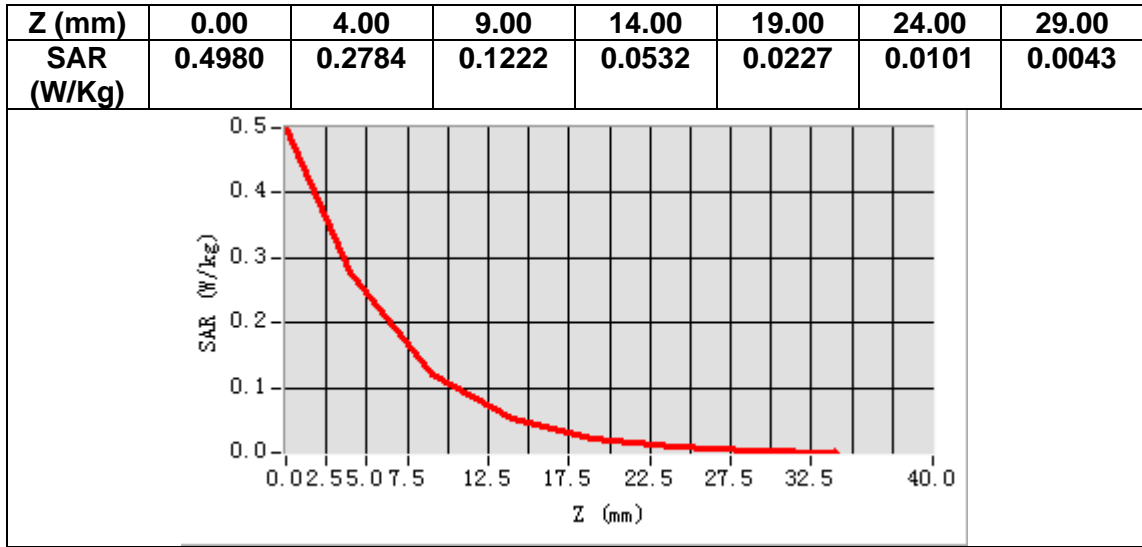

MEASUREMENT 23

Date of measurement: 12/12/2022

A. Experimental conditions.

Area Scan	<u>dx=15mm dy=15mm, h= 5.00 mm</u>
ZoomScan	<u>5x5x7,dx=8mm dy=8mm dz=5mm</u>
Phantom	<u>Left head</u>
Device Position	<u>Cheek</u>
Band	<u>CUSTOM (FDDBand26A)</u>
Channels	<u>Middle</u>
Signal	<u>Duty Cycle: 1.00 (Crest factor: 1.0)</u>
ConvF	

B. SAR Measurement Results

Frequency (MHz)	819.000000
Relative permittivity (real part)	41.559976
Relative permittivity (imaginary part)	20.111882
Conductivity (S/m)	0.915090
Variation (%)	0.030000

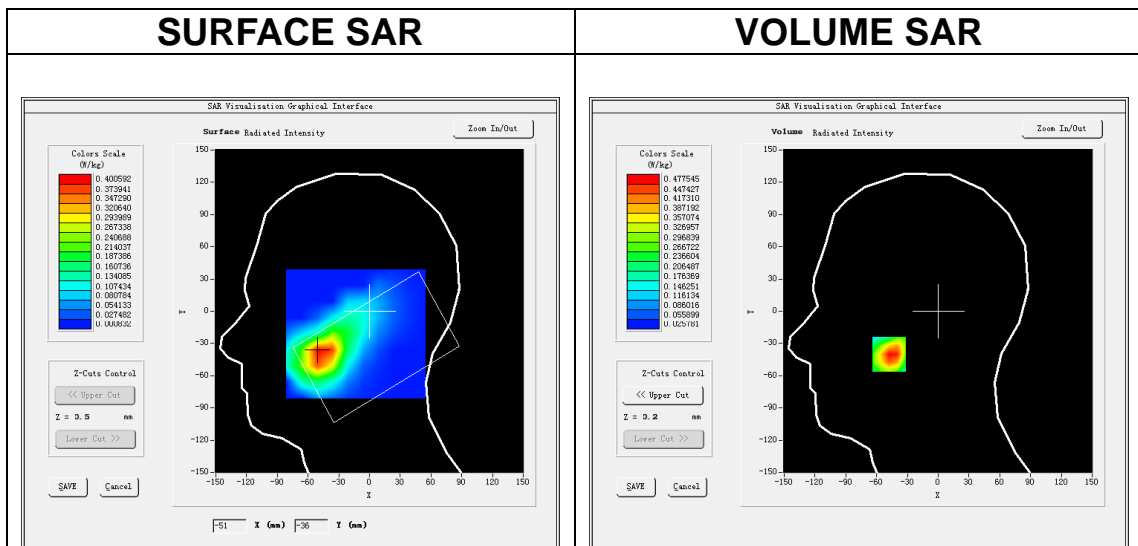

Maximum location: X=-48.00, Y=-40.00
SAR Peak: 0.75 W/kg

SAR 10g (W/Kg)	0.271308
SAR 1g (W/Kg)	0.471505

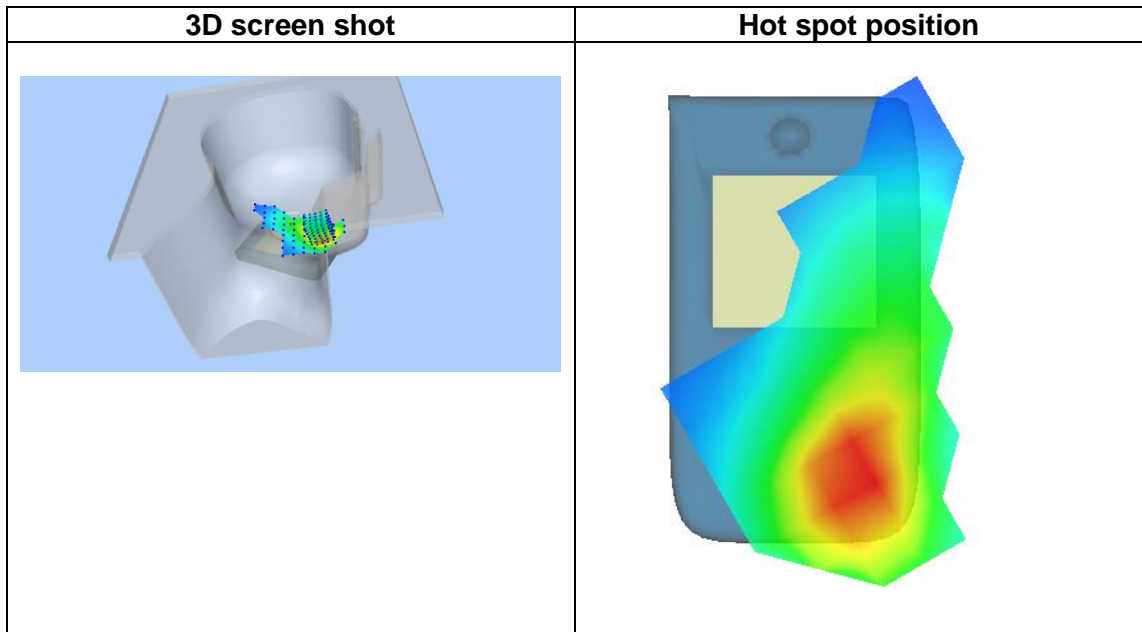
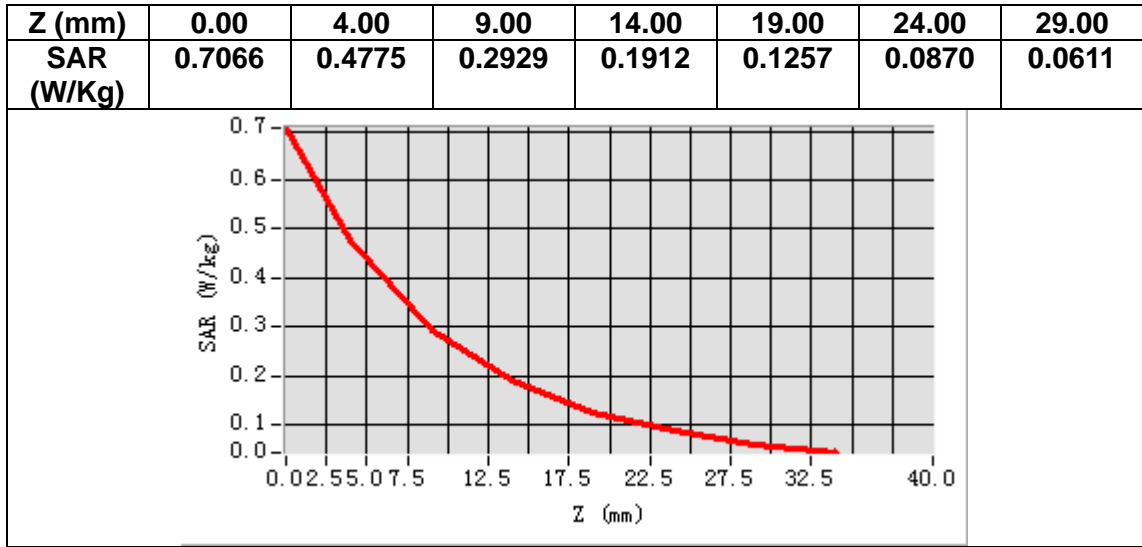

MEASUREMENT 24

Date of measurement: 12/12/2022

A. Experimental conditions.

Area Scan	<u>dx=15mm dy=15mm, h= 5.00 mm</u>
ZoomScan	<u>5x5x7,dx=8mm dy=8mm dz=5mm</u>
Phantom	<u>Left head</u>
Device Position	<u>Cheek</u>
Band	<u>CUSTOM (FDDBand26B)</u>
Channels	<u>Middle</u>
Signal	<u>Duty Cycle: 1.00 (Crest factor: 1.0)</u>
ConvF	

B. SAR Measurement Results

Frequency (MHz)	831.500000
Relative permittivity (real part)	41.559976
Relative permittivity (imaginary part)	20.111882
Conductivity (S/m)	0.915090
Variation (%)	1.780000

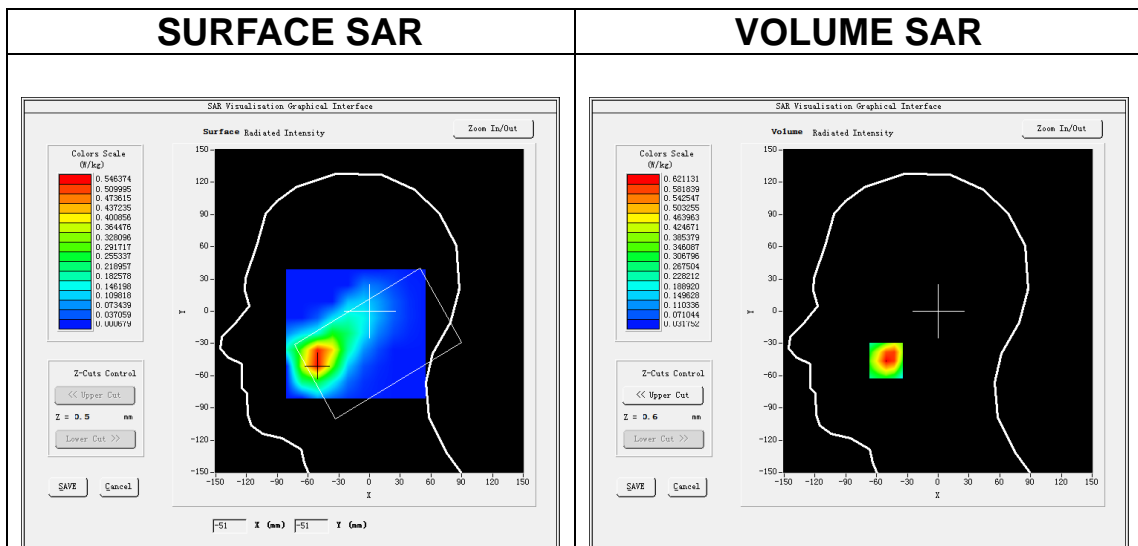

Maximum location: X=-51.00, Y=-46.00
SAR Peak: 1.01 W/kg

SAR 10g (W/Kg)	0.353460
SAR 1g (W/Kg)	0.620906

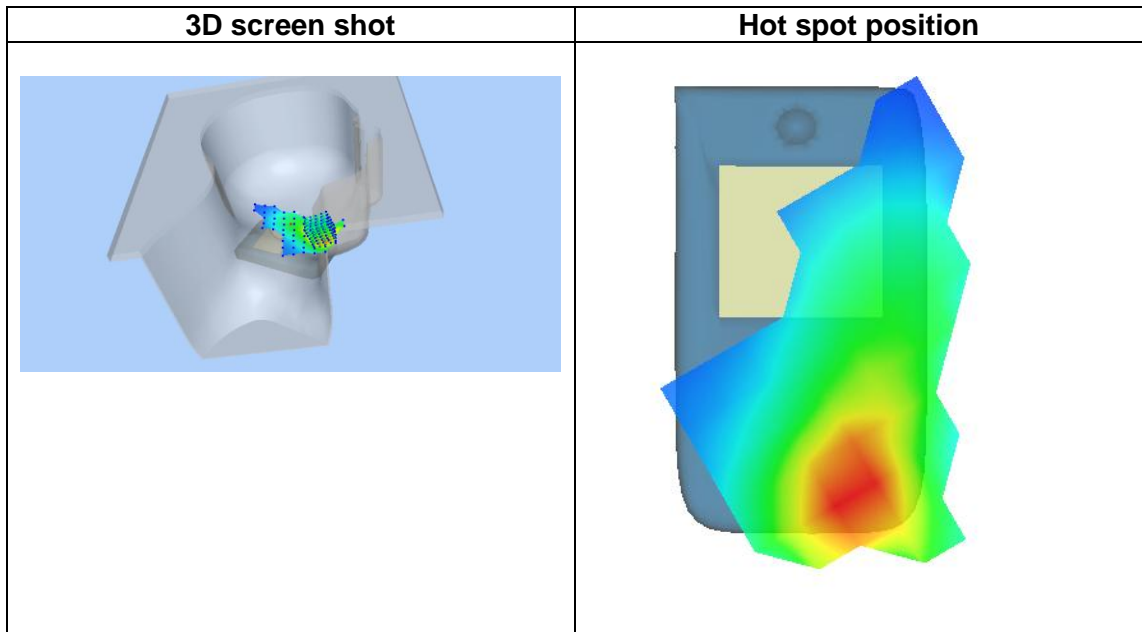
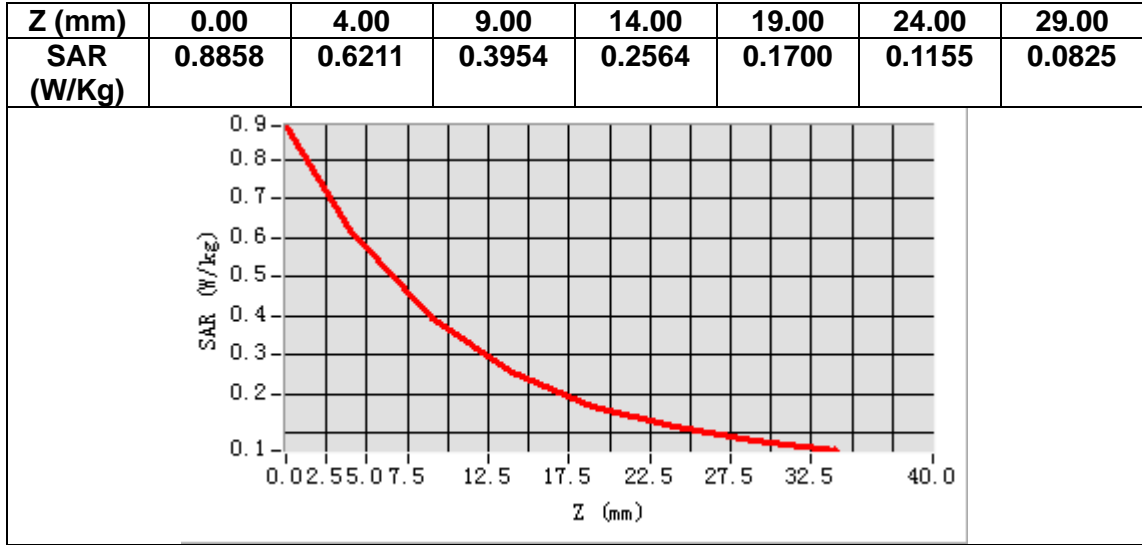

MEASUREMENT 25

Date of measurement: 12/12/2022

A. Experimental conditions.

Area Scan	<u>dx=15mm dy=15mm, h= 5.00 mm</u>
ZoomScan	<u>5x5x7, dx=8mm dy=8mm dz=5mm</u>
Phantom	<u>Validation plane</u>
Device Position	<u>Body</u>
Band	<u>CUSTOM (FDDBand26A)</u>
Channels	<u>Middle</u>
Signal	<u>Duty Cycle: 1.00 (Crest factor: 1.0)</u>
ConvF	

B. SAR Measurement Results

Frequency (MHz)	831.500000
Relative permittivity (real part)	41.375076
Relative permittivity (imaginary part)	20.103582
Conductivity (S/m)	0.928674
Variation (%)	-1.040000

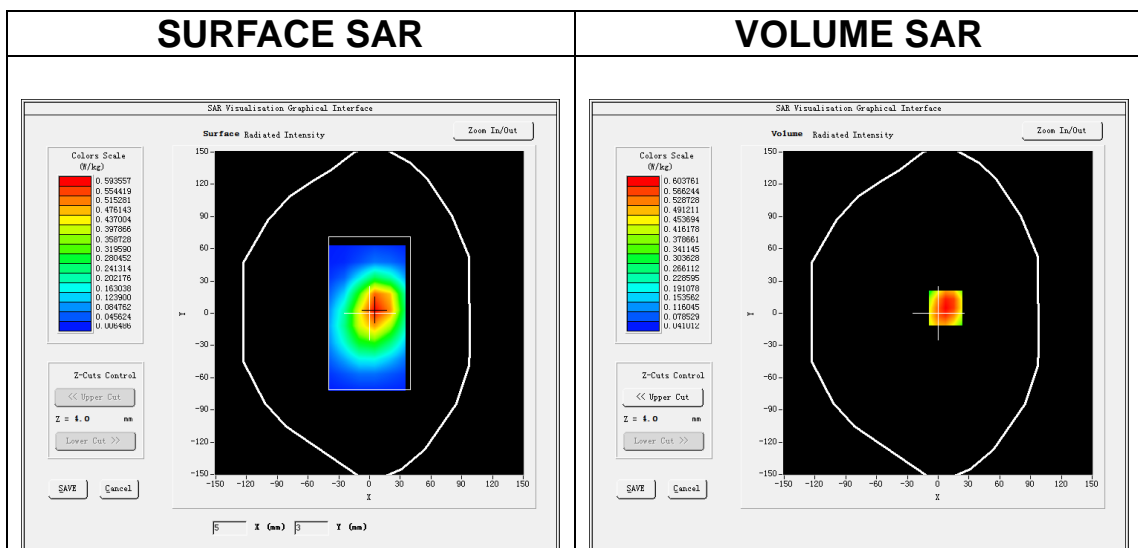

Maximum location: X=7.00, Y=5.00
SAR Peak: 0.79 W/kg

SAR 10g (W/Kg)	0.396124
SAR 1g (W/Kg)	0.586709

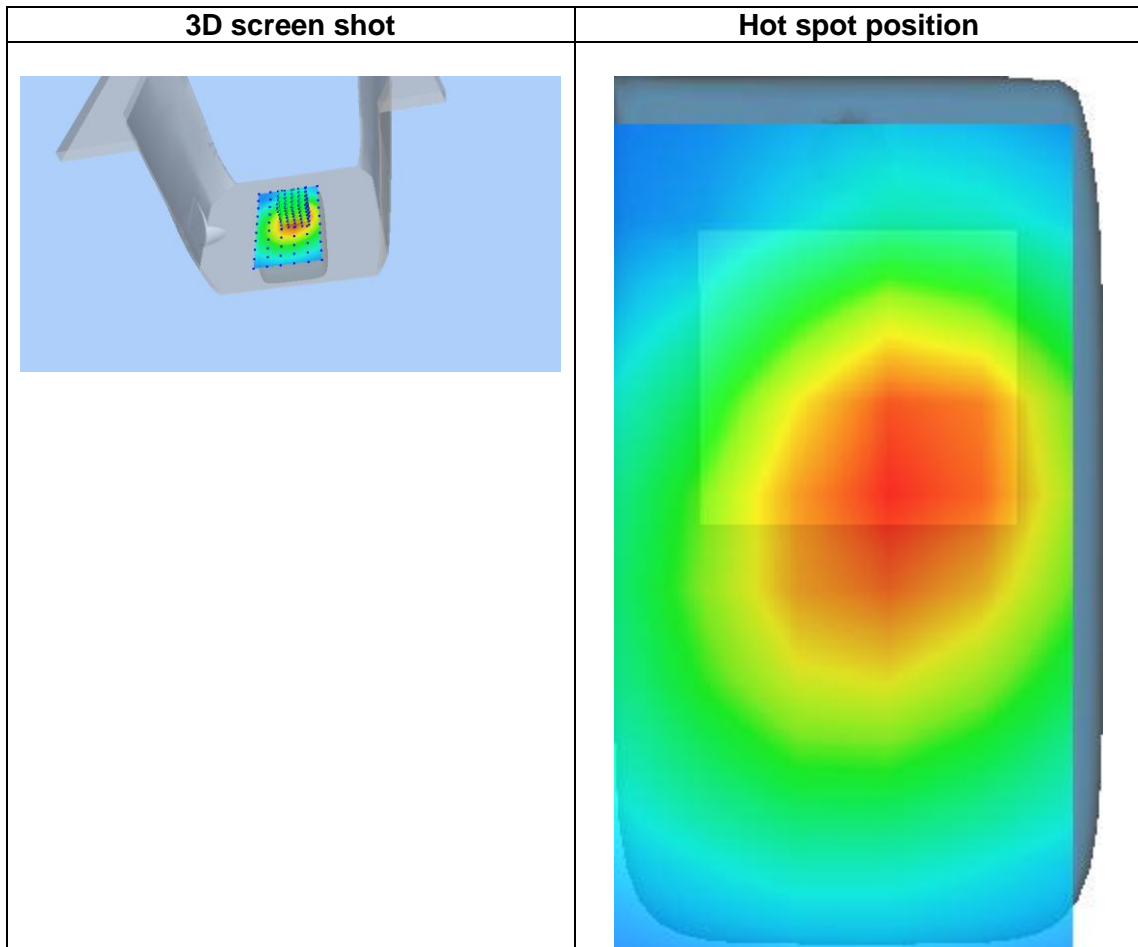
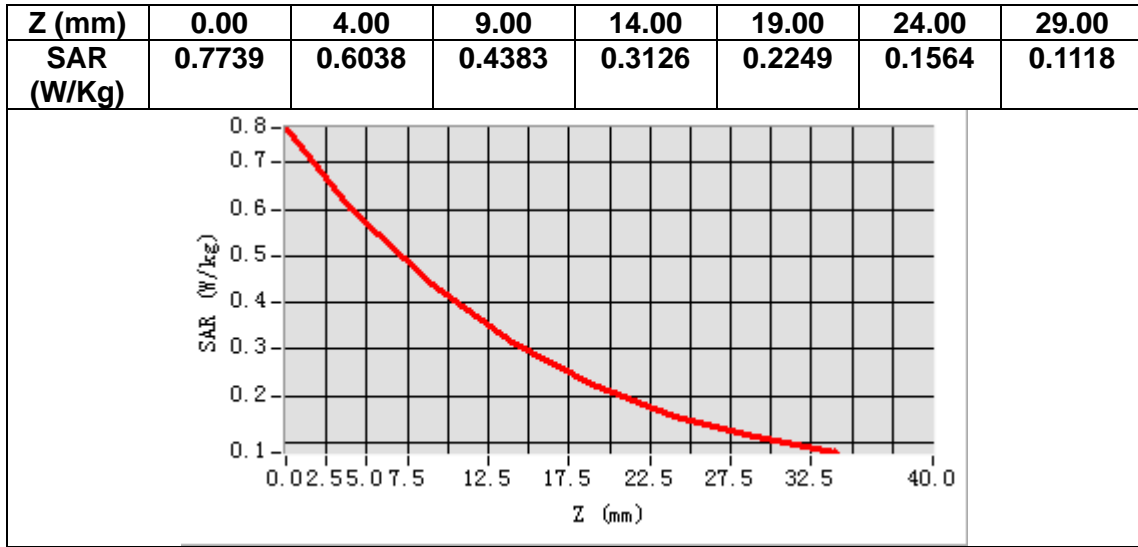

MEASUREMENT 26

Date of measurement: 12/12/2022

A. Experimental conditions.

Area Scan	<u>dx=15mm dy=15mm, h= 5.00 mm</u>
ZoomScan	<u>5x5x7, dx=8mm dy=8mm dz=5mm</u>
Phantom	<u>Validation plane</u>
Device Position	<u>Body</u>
Band	<u>CUSTOM (FDDBand26B)</u>
Channels	<u>Middle</u>
Signal	<u>Duty Cycle: 1.00 (Crest factor: 1.0)</u>
ConvF	

B. SAR Measurement Results

Frequency (MHz)	831.500000
Relative permittivity (real part)	41.375076
Relative permittivity (imaginary part)	20.103582
Conductivity (S/m)	0.928674
Variation (%)	-0.920000

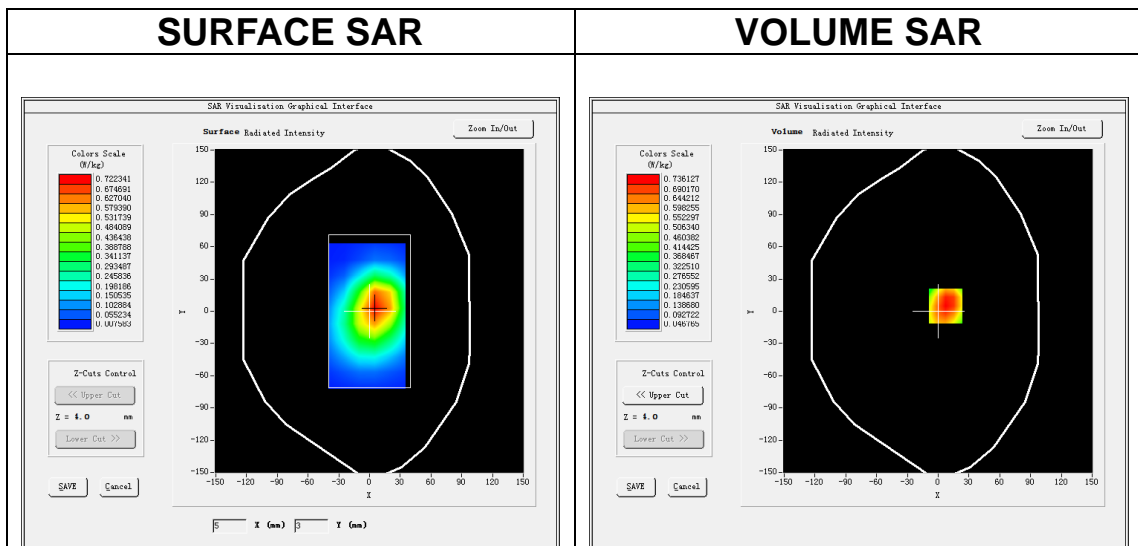

Maximum location: X=7.00, Y=5.00
SAR Peak: 0.99 W/kg

SAR 10g (W/Kg)	0.478383
SAR 1g (W/Kg)	0.718985

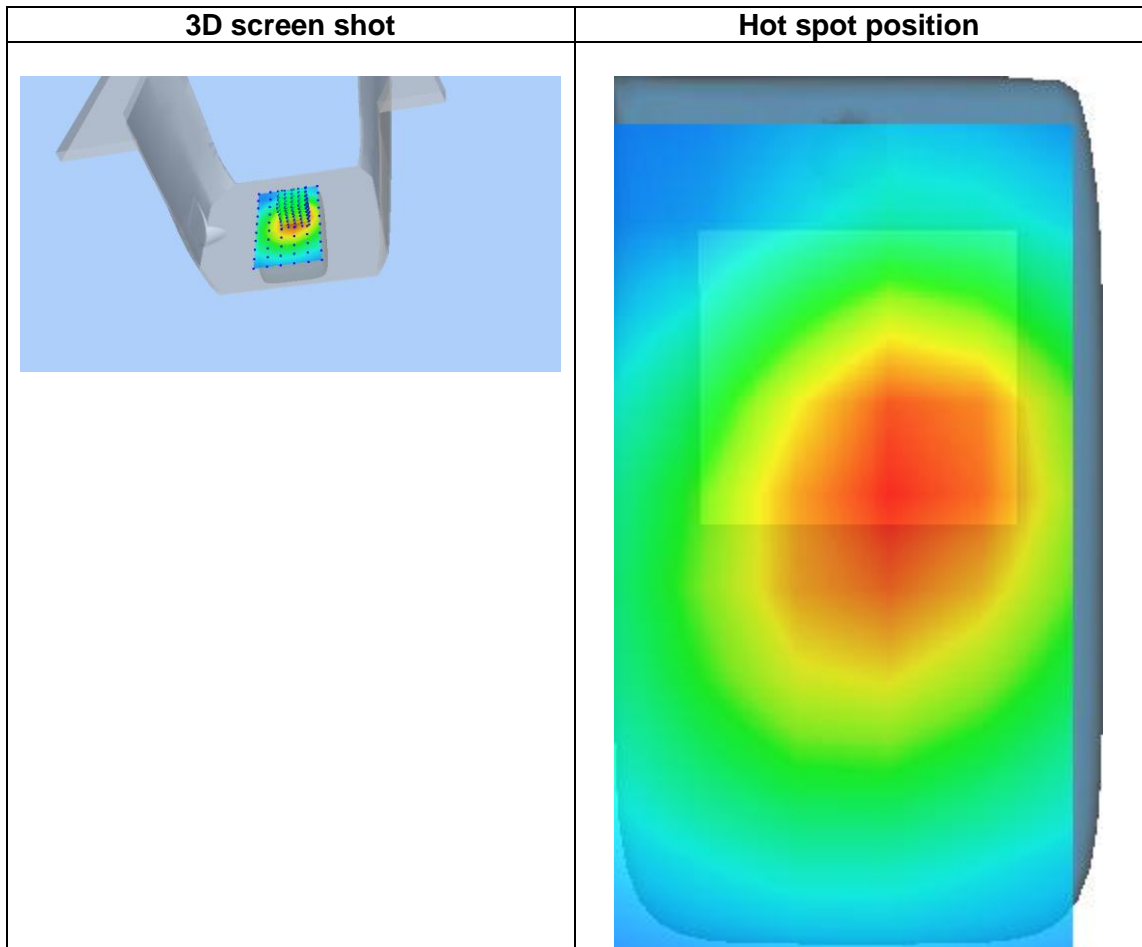
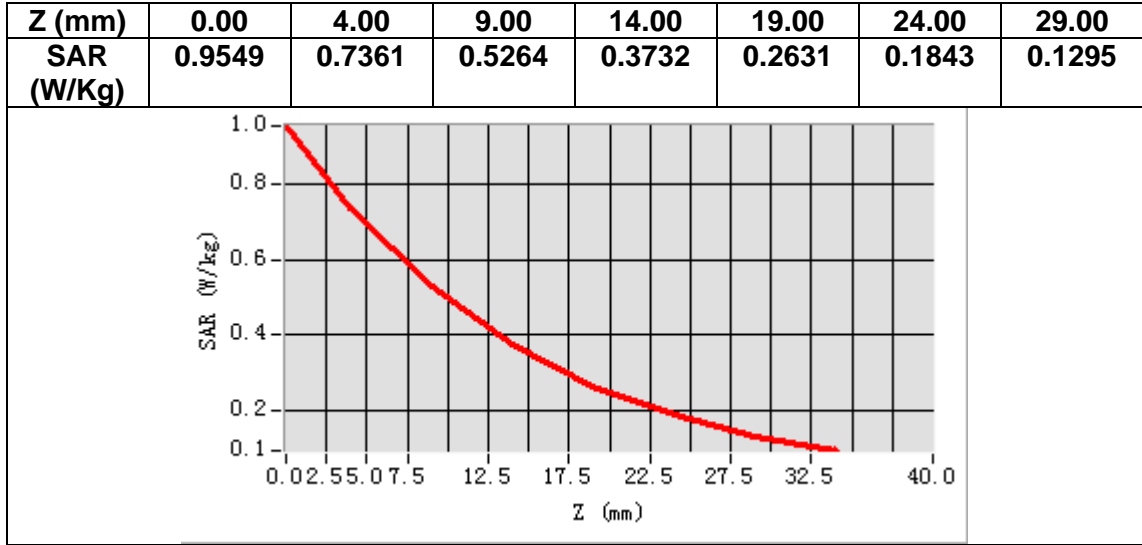

13. Appendix D. Calibration Certificate

Table of contents
E Field Probe - SN 08/16 EPGO287
835 MHz Dipole - SN 03/15 DIP 0G835-347
1800 MHz Dipole - SN 03/15 DIP 1G800-349
1900 MHz Dipole - SN 03/15 DIP 1G900-350
2600 MHz Dipole - SN 03/15 DIP 2G600-356
Extended Calibration Certificate



COMOSAR E-Field Probe Calibration Report

Ref : ACR.60.1.21.MVGB.A

**SHENZHEN NTEK TESTING TECHNOLOGY
CO., LTD.**

**BUILDING E, FENDA SCIENCE PARK, SANWEI
COMMUNITY, XIXIANG STREET,
BAO'AN DISTRICT, SHENZHEN GUANGDONG, CHINA
MVG COMOSAR DOSIMETRIC E-FIELD PROBE
SERIAL NO.: SN 08/16 EPGO287**

Calibrated at MVG

Z.I. de la pointe du diable

**Technopôle Brest Iroise – 295 avenue Alexis de Rochon
29280 PLOUZANE - FRANCE**

Calibration date: 02/01/2022



Accreditations #2-6789 and #2-6814
Scope available on www.cofrac.fr

Summary:

This document presents the method and results from an accredited COMOSAR E-Field Probe calibration performed at MVG, using the CALIPROBE test bench, for use with a MVG COMOSAR system only. The test results covered by accreditation are traceable to the International System of Units (SI).



COMOSAR E-FIELD PROBE CALIBRATION REPORT

Ref: ACR.60.1.21.MVGB.A

	Name	Function	Date	Signature
Prepared by :	Jérôme Luc	Technical Manager	2/1/2022	<i>JS</i>
Checked by :	Jérôme Luc	Technical Manager	2/1/2022	<i>JS</i>
Approved by :	Yann Toutain	Laboratory Director	2/1/2022	<i>Yann Toutain</i>

Mode d'emploi
2022.02.0
1 10:07:13
+01'00'

PHILIPS

	Customer Name
Distribution :	SHENZHEN NTEK TESTING TECHNOLOGY CO., LTD.

Issue	Name	Date	Modifications
A	Jérôme Luc	2/1/2022	Initial release