

SHENZHEN KENXINDA TECHNOLOGY CO.,LTD

GSM&WCDMA MOBILE PHONE

Model: S-502

28 September, 2011

Report No.: 11070066-FCC Part 15B
(This report supersedes NONE)



Modifications made to the product : None

This Test Report is Issued Under the Authority of:

Andy wang

Andy wang
Compliance Engineer

Spring Zhou

Spring Zhou
Technical Director

This test report may be reproduced in full only.
Test result presented in this test report is applicable to the representative sample only.

EMC Test Report

TO: FCC Part 15 Subpart B Class B: 2010

SIEMIC, INC.
Accessing global markets



Laboratory Introduction

SIEMIC, headquartered in the heart of Silicon Valley, with superior facilities in US and Asia, is one of the leading independent testing and certification facilities providing customers with one-stop shop services for Compliance Testing and Global Certifications.



In addition to [testing](#) and [certification](#), SIEMIC provides initial design reviews and [compliance management](#) through out a project. Our extensive experience with [China](#), [Asia Pacific](#), [North America](#), [European](#), and [international](#) compliance requirements, assures the fastest, most cost effective way to attain regulatory compliance for the [global markets](#).

Accreditations for Conformity Assessment

Country/Region	Accreditation Body	Scope
USA	FCC, A2LA	EMC , RF/Wireless , Telecom
Canada	IC, A2LA, NIST	EMC, RF/Wireless , Telecom
Taiwan	BSMI , NCC , NIST	EMC, RF, Telecom , Safety
Hong Kong	OFTA , NIST	RF/Wireless , Telecom
Australia	NATA, NIST	EMC, RF, Telecom , Safety
Korea	KCC/RRA, NIST	EMI, EMS, RF , Telecom, Safety
Japan	VCCI, JATE, TELEC, RFT	EMI, RF/Wireless, Telecom
Mexico	NOM, COFETEL, Caniety	Safety, EMC , RF/Wireless, Telecom
Europe	A2LA, NIST	EMC, RF, Telecom , Safety

Accreditations for Product Certifications

Country	Accreditation Body	Scope
USA	FCC TCB, NIST	EMC , RF , Telecom
Canada	IC FCB , NIST	EMC , RF , Telecom
Singapore	iDA, NIST	EMC , RF , Telecom
EU	NB	EMC & R&TTE Directive



SIEMIC, Inc.

Accessing global markets

Title: EMC Test Report for GSM&WCDMA MOBILE PHONE
Model: S-502
To: FCC Part 15B:2010

Serial#: 11070066-FCC Part 15B
Issue Date: 28 September, 2011
Page: 3 of 37
www.siemic.com.cn

This page has been left blank intentionally.

CONTENTS

1 EXECUTIVE SUMMARY & EUT INFORMATION..... 5

2 TECHNICAL DETAILS 6

3 MODIFICATION 7

4 TEST SUMMARY 8

5 MEASUREMENTS, EXAMINATION AND DERIVED RESULTS..... 9

ANNEX A. TEST INSTRUMENT & METHOD 15

ANNEX B. EUT AND TEST SETUP PHOTOGRAPHS..... 19

ANNEX C. TEST SETUP AND SUPPORTING EQUIPMENT..... 29

ANNEX D. USER MANUAL / BLOCK DIAGRAM / SCHEMATICS / PART LIST..... 33

ANNEX E. SIEMIC ACCREDITATION CERTIFICATES 34

1 Executive Summary & EUT information

The purpose of this test programme was to demonstrate compliance of the SHENZHEN KENXINDA TECHNOLOGY CO.,LTD , GSM&WCDMA MOBILE PHONE , and model: S-502 against the current Stipulated Standards. The GSM&WCDMA MOBILE PHONE has demonstrated compliance with the FCC Part 15B:2010.

EUT Information

EUT Description	GSM&WCDMA MOBILE PHONE
Model No	S-502
Serial No	N/A
Input Power	Powered by Power Adapter Trade Name.: ti.phone Input: AC100-240V, 50/60Hz, 0.25A Output: DC5.0V, 500mA Li-ion Battery Model No.: BL-4D Rating: 3.7V, 1200mAh Restrictive Voltage: 4.2V
Classification Per Stipulated Test Standard	Class B Emission Product

2 TECHNICAL DETAILS

Purpose	Compliance testing of GSM&WCDMA MOBILE PHONE with stipulated standard
Applicant / Client	SHENZHEN KENXINDA TECHNOLOGY CO.,LTD 18th FLOOR, FUCHUN ORIENT BUILDING,SHENNAN AV7006,FUTIAN DISTRICT,SHENZHEN,P.R.CHINA
Manufacturer	SHENZHEN KENXINDA TECHNOLOGY CO.,LTD BAO'AN BRANCH 1-6 FLOOR,NO.105 WORK SHOP&1-5 FLOOR,NO.104 WORK SHOP,XINWEIHUANING ROAD,DALANG COMMUNITY,DALANG STREET,BAO'AN DISTRICT,SHENZHEN,P.R.CHINA
Laboratory performing the tests	SIEMIC Nanjing (China) Laboratories NO.2-1,Longcang Dadao, Yuhua Economic Development Zone, Nanjing, China Tel:+86(25)86730128/86730129 Fax:+86(25)86730127 Email: info@siemic.com
Test report reference number	11070066-FCC Part 15B
Date EUT received	25 September, 2011
Standard applied	FCC Part 15B:2010
Dates of test	26 September, 2011
No of Units :	1
Equipment Category :	Class B Emission Product
Trade Name :	SEFTON
Model :	S-502
RF Operating Frequency (ies)	GSM850 TX : 824.2 ~ 848.8 MHz RX :869.2 ~ 893.8 MHz PCS1900 TX : 1850.2 ~ 1909.8 MHz RX :1930.2 ~ 1989.8 MHz UMTS Band V TX : 826.4 ~ 846.6 MHz RX :871.4 ~ 891.6 MHz UMTS Band II TX : 1852.4 ~ 1907.6 MHz RX :1932.4 ~ 1987.6 MHz BT:2402MHz-2480MHz WIFI:2.4GHz band: 802.11b/g: 2412MHz-2462MHz
Number of Channels :	300 (PCS1900) and 125 (PCS850) BT: 79CH WIFI:2.4GHz band: 802.11b/g-20MHz 11CH
Modulation:	GSM / GPRS/ EGPRS : GMSK, 8PSK WCDMA:QPSK BT: GFSK, $\pi/4$ DPSK,8DPSK WIFI:DSSS
FCC ID :	ZSHS-502



SIEMIC, Inc.
Accessing global markets

Title: EMC Test Report for GSM&WCDMA MOBILE PHONE
Model: S-502
To: FCC Part 15B:2010

Serial#: 11070066-FCC Part 15B
Issue Date: 28 September, 2011
Page: 7 of 37
www.siemec.com.cn

3 MODIFICATION

NONE

4 TEST SUMMARY

The product was tested in accordance with the following specifications.
All testing has been performed according to below product classification:

Class B Emission Product

Test Results Summary

Emissions			
Test Standard	Description	Product Class	Pass / Fail
FCC Part 15B:2010	AC Line Conducted Emissions	See Above	N/A
FCC Part 15B:2010	Radiated Emissions	See Above	Pass

All measurement uncertainty is not taken into consideration for all presented test result.

Test Mode:	Mode 1: USB Mode Power-- Line
------------	----------------------------------

Peak Detector  **Quasi Peak Limit** 
Average Detector  **Average Limit** 

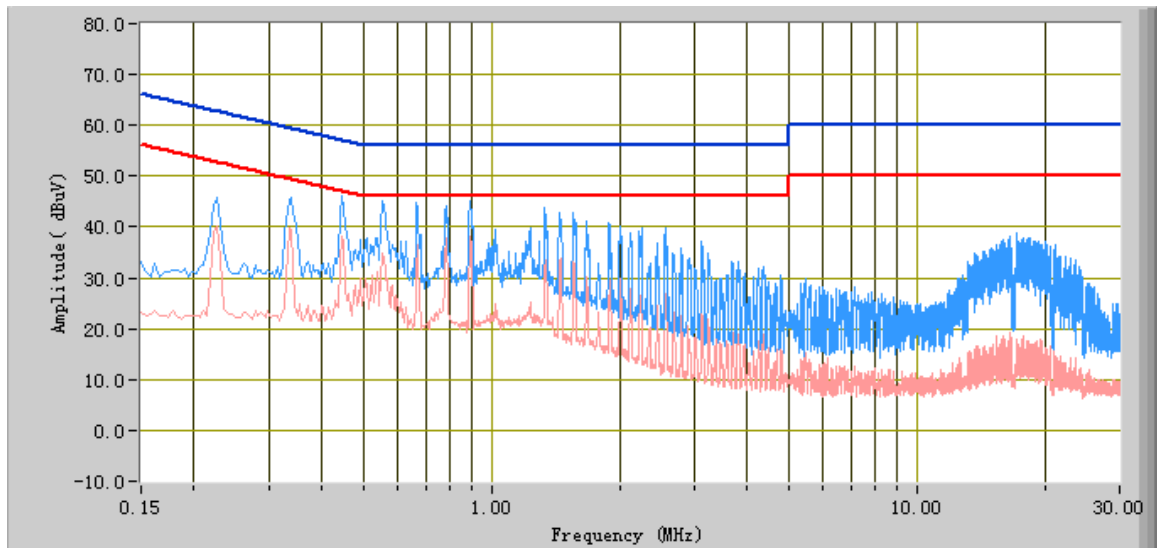

Phase Line Plot at 230Vac, 50Hz

Frequency (MHz)	Peak (dBuV)	Limit (dBuV)	Margin (dB)	Average (dBuV)	Limit (dBuV)	Margin (dB)	Factors (dB)
0.890	45.218	56.000	-10.782	35.721	46.000	-10.279	10.169
0.554	45.159	56.000	-10.841	34.752	46.000	-11.248	10.157
0.446	46.117	56.964	-10.847	38.198	46.964	-8.766	10.170
0.666	44.784	56.000	-11.216	34.709	46.000	-11.291	10.129
0.782	44.233	56.000	-11.767	37.866	46.000	-8.134	10.153
1.334	43.777	56.000	-12.223	32.723	46.000	-13.277	10.173

Test Mode:	Mode 1: USB Mode Power-- Neutral
-------------------	-------------------------------------

Peak Detector	Quasi Peak Limit	
Average Detector	Average Limit	

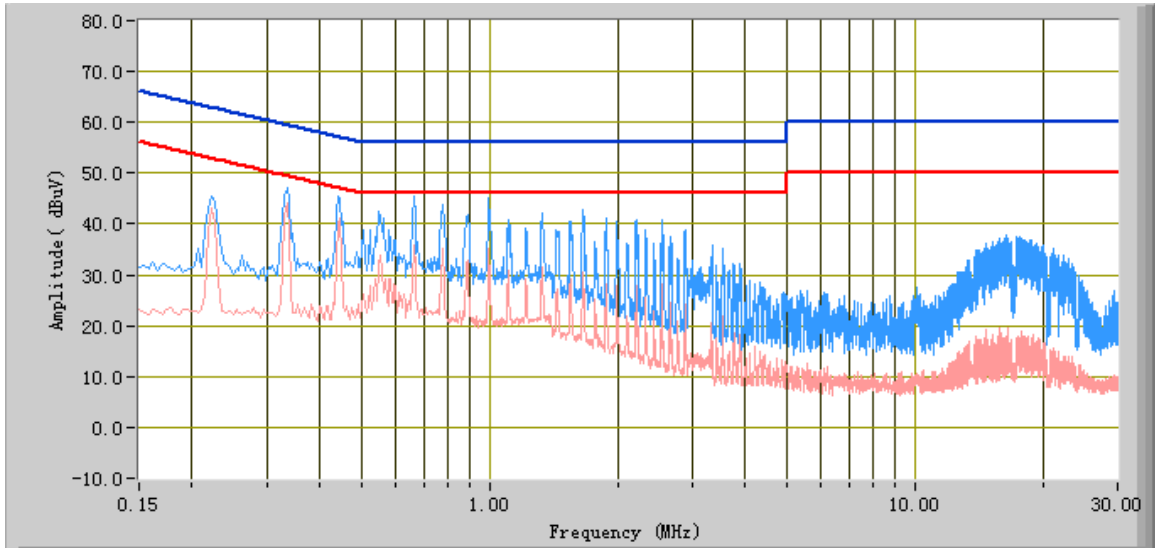

Phase Neutral Plot at 230Vac, 50Hz

Frequency (MHz)	Quasi Peak (dBuV)	Limit (dBuV)	Margin (dB)	Average (dBuV)	Limit (dBuV)	Margin (dB)	Factors (dB)
0.341	50.80	59.31	-8.51	44.78	49.31	-4.53	10.18
0.532	48.32	56.00	-7.68	40.00	46.00	-6.00	10.16
0.234	65.10	62.72	2.38	60.25	52.72	7.54	10.26
0.450	51.07	56.89	-5.82	39.63	46.89	-7.26	10.17
0.337	47.056	59.412	-12.356	44.044	49.412	-5.368	10.183
1.658	42.824	56.000	-13.176	30.548	46.000	-15.452	10.186



5.2.1 Test Result Complying For FCC Part 15B:2010

Test mode:

Mode 1: USB Mode

Below 1GHz

Antenna polarity: Vertical

Peak Detector 
Quasi Peak Limit 

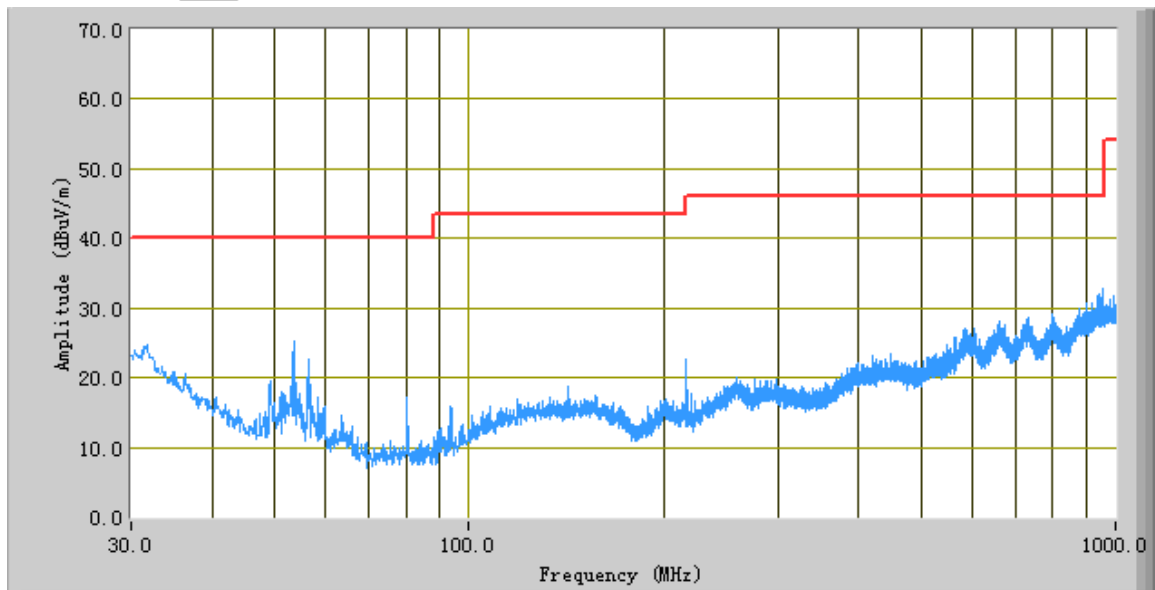

Test Data



Frequency (MHz)	Peak (dBuV/m)	Azimuth	Polarity(H/V)	Height (cm)	Factors (dB)	Limit (dBuV/m)	Margin (dB)
953.44	32.79	26.20	V	100.00	-17.34	46.00	-13.21
945.20	32.06	166.70	V	100.00	-17.41	46.00	-13.94
934.77	31.86	19.70	V	100.00	-17.48	46.00	-14.14
53.52	25.26	309.80	V	100.00	-36.57	40.00	-14.74
916.94	30.67	340.90	V	100.00	-17.60	46.00	-15.33
900.45	30.65	35.90	V	100.00	-17.71	46.00	-15.35

Test mode:

Mode 1: USB Mode

Below 1GHz

Antenna polarity: Horizontal

Peak Detector 
Quasi Peak Limit 

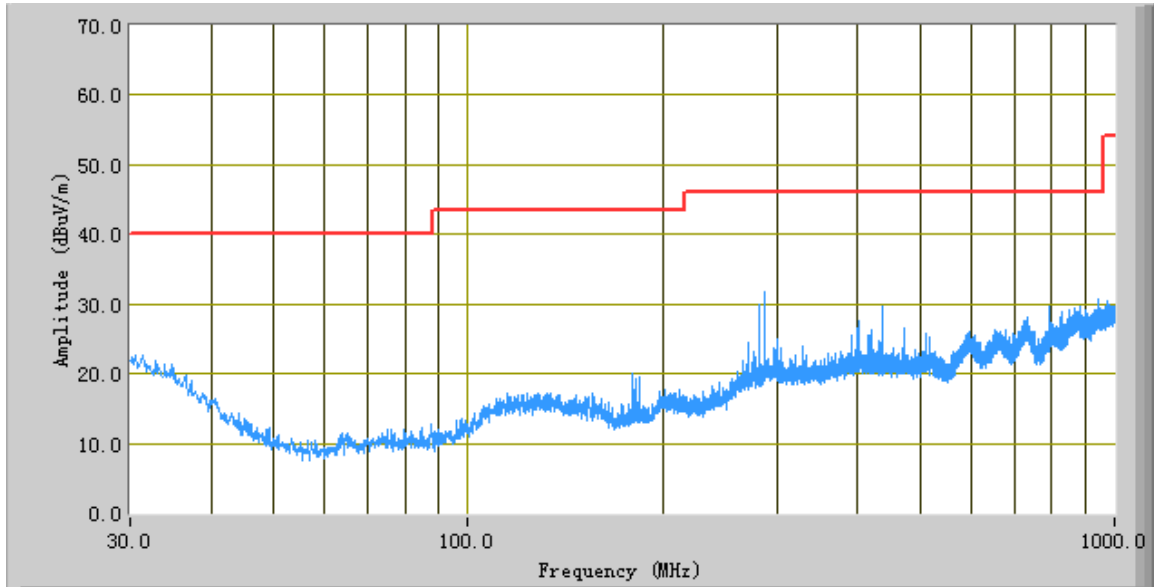

Test Data

Frequency (MHz)	Peak (dBuV/m)	Azimuth	Polarity(H/V)	Height (cm)	Factors (dB)	Limit (dBuV/m)	Margin (dB)
287.05	31.68	237.10	H	100.00	-27.18	46.00	-14.32
945.07	30.58	349.10	H	100.00	-18.33	46.00	-15.42
793.27	29.66	36.30	H	200.00	-21.29	46.00	-16.34
883.36	29.58	39.20	H	100.00	-18.70	46.00	-16.42
436.43	29.55	121.90	H	100.00	-27.09	46.00	-16.45
866.50	29.49	144.50	H	200.00	-18.59	46.00	-16.51

Above 1GHz

Freq. (MHz)	Ant. Pol H/V	Peak Reading (dBuV)	AV Reading (dBuV)	Factors (dB)	Emission Level		Peak Limit (dBuV/m)	AV Limit (dBuV/m)	Peak Margin (dB)	AV Margin (dB)
					Peak (dBuV/m)	AV (dBuV/m)				
1753.42	V	45.71	41.60	-2.97	42.74	38.63	70.00	50.00	-27.26	-11.37
2743.75	V	52.23	42.28	1.86	54.09	44.14	70.00	50.00	-15.91	-5.86
1872.13	H	46.34	43.56	-3.94	42.40	39.62	70.00	50.00	-27.60	-10.38
2870.11	H	48.12	44.37	1.86	49.98	46.23	70.00	50.00	-20.02	-3.77

Note: The frequency that above 3GHz is mainly from the environment noise.

Annex A. TEST INSTRUMENT & METHOD

Annex A.i. TEST INSTRUMENTATION & GENERAL PROCEDURES

Instrument	Model	Calibration Due
AC Conducted Emissions		
R&S EMI Test Receiver	ESPI3	05/25/2012
R&S LISN	LI-115	05/25/2012
R&S LISN	LI-115	05/25/2012
Universal Radio Communication Tester	CMU200	02/22/2012
Radiated Emissions		
Spectrum Analyzer	8563E	01/10/2012
EMI Receiver	ESPI3	05/18/2012
Antenna(1 ~18GHz)	3115	6/2/2012
Antenna (30MHz~2GHz)	JB1	05/25/2012
Chamber	3m	4/13/2012
Pre-Amplifier(1 ~ 18GHz)	AMF-7D-00101800-30-10P	5/25/2012
Horn Antenna (18~40GHz)	AH-840	7/23/2013
Microwave Pre-Amp (18~40GHz)	PA-840	Every 2000 Hours
Universal Radio Communication Tester	CMU200	02/22/2012
Signal Analyzer	8665B	1/21/2012
Temperature/Humidity Chamber	1007H	06/08/2012

Note: Functional Verification

Annex A.ii. CONDUCTED EMISSIONS TEST DESCRIPTION

Test Set-up

1. The EUT and supporting equipment were set up in accordance with the requirements of the standard on top of a 1.5m x 1m x 0.8m high, non-metallic table, as shown in Annex B.
2. The power supply for the EUT was fed through a 50Ω/50μH EUT LISN, connected to filtered mains.
3. The RF OUT of the EUT LISN was connected to the EMI test receiver via a low-loss coaxial cable.
4. All other supporting equipments were powered separately from another main supply.

Test Method

1. The EUT was switched on and allowed to warm up to its normal operating condition.
2. A scan was made on the NEUTRAL line (for AC mains) or Earth line (for DC power) over the required frequency range using an EMI test receiver.
3. High peaks, relative to the limit line, were then selected.
4. The EMI test receiver was then tuned to the selected frequencies and the necessary measurements made with a receiver bandwidth setting of 10 KHz. For FCC tests, only Quasi-peak measurements were made; while for CISPR/EN tests, both Quasi-peak and Average measurements were made.
5. Steps 2 to 4 were then repeated for the LIVE line (for AC mains) or DC line (for DC power).

Sample Calculation Example

At 20 MHz limit = 250 μV = 47.96 dBμV
Transducer factor of LISN, pulse limiter & cable loss at 20 MHz = 11.20 dB
Q-P reading obtained directly from EMI Receiver = 40.00 dBμV
(Calibrated for system losses)
Therefore, Q-P margin = 47.96 – 40.00 = 7.96 i.e. **7.96 dB below limit**

Annex A.iii. RADIATED EMISSIONS TEST DESCRIPTION

EUT Characterisation

EUT characterisation, over the frequency range from 30MHz to 10th Harmonic, was done in order to minimise radiated emissions testing time while still maintaining high confidence in the test results.

The EUT was placed in the chamber, at a height of about 0.8m on a turntable. Its radiated emissions frequency profile was observed, using a spectrum analyzer /receiver with the appropriate broadband antenna placed 3m away from the EUT. Radiated emissions from the EUT were maximised by rotating the turntable manually, changing the antenna polarisation and manipulating the EUT cables while observing the frequency profile on the spectrum analyzer / receiver. Frequency points at which maximum emissions occurred, clock frequencies and operating frequencies were then noted for the formal radiated emissions test at the Open Area Test Site (OATS).

Test Set-up

1. The EUT and supporting equipment were set up in accordance with the requirements of the standard on top of a 1.5m X 1.0m X 0.8m high, non-metallic table.
2. The filtered power supply for the EUT and supporting equipment were tapped from the appropriate power sockets located on the turntable.
3. The relevant broadband antenna was set at the required test distance away from the EUT and supporting equipment boundary.

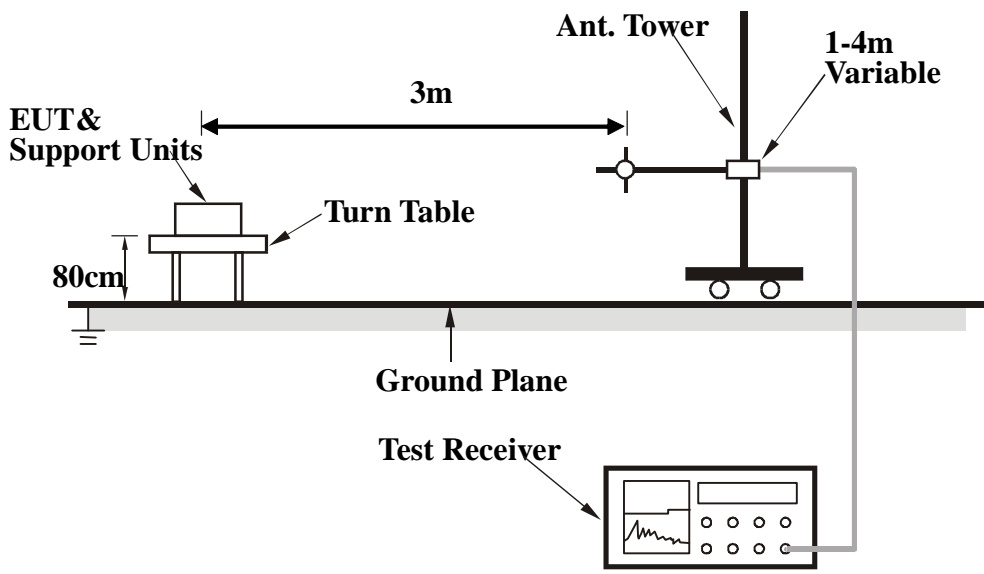

Test Method

The following procedure was performed to determine the maximum emission axis of EUT:

1. With the receiving antenna is H polarization, rotate the EUT in turns with three orthogonal axes to determine the axis of maximum emission.
2. With the receiving antenna is V polarization, rotate the EUT in turns with three orthogonal axes to determine the axis of maximum emission.
3. Compare the results derived from above two steps. So, the axis of maximum emission from EUT was determined and the configuration was used to perform the final measurement.

Final Radiated Emission Measurement

1. Setup the configuration according to figure 1. Turn on EUT and make sure that it is in normal function.
2. For emission frequencies measured below 1 GHz, a pre-scan is performed in a shielded chamber to determine the accurate frequencies of higher emissions will be checked on a open test site. As the same purpose, for emission frequencies measured above 1 GHz, a pre-scan also be performed with a 1 meter measuring distance before final test.
3. For emission frequencies measured below and above 1 GHz, set the spectrum analyzer on a 100 kHz and 1 MHz resolution bandwidth respectively for each frequency measured in step 2.
4. The search antenna is to be raised and lowered over a range from 1 to 4 meters in horizontally polarized orientation. Position the highness when the highest value is indicated on spectrum analyzer, then change the orientation of EUT on test table over a range from 0 ° to 360 ° with a speed as slow as possible, and keep the azimuth that highest emission is indicated on the spectrum analyzer. Vary the antenna position again and record the highest value as a final reading.
5. Repeat step 4 until all frequencies need to be measured were complete.
6. Repeat step 5 with search antenna in vertical polarized orientations.

During the radiated emission test, the Spectrum Analyzer was set with the following configurations:

Frequency Band (MHz)	Function	Resolution bandwidth	Video Bandwidth
30 to 1000	Peak	100 kHz	100 kHz
Above 1000	Peak	1 MHz	1 MHz
	Average	1 MHz	10 Hz

Sample Calculation Example

The field strength is calculated by adding the Antenna Factor and Cable Factor, and subtracting the Amplifier Gain (if any) from the measured reading. For the limit is employed average value, therefore the peak value can be transferred to average value by subtracting the duty factor. The basic equation with a sample calculation is as follows:

$$\text{Peak} = \text{Reading} + \text{Corrected Factor}$$

where

$$\text{Corr. Factor} = \text{Antenna Factor} + \text{Cable Factor} - \text{Amplifier Gain (if any)}$$

And the average value is

$$\text{Average} = \text{Peak Value} + \text{Duty Factor or}$$

$$\text{Set RBW} = 1\text{MHz, VBW} = 10\text{Hz.}$$

Note:

If the measured frequencies are fall in the restricted frequency band, the limit employed must be quasi peak value when frequencies are below or equal to 1 GHz. And the measuring instrument is set to quasi peak detector function.

Annex B. EUT AND TEST SETUP PHOTOGRAPHS

Annex B.i. Photograph : EUT External Photo



Front View of EUT



Rear View of EUT



Top View of EUT



Bottom View of EUT

Annex B.ii. Photograph : EUT Internal Photo



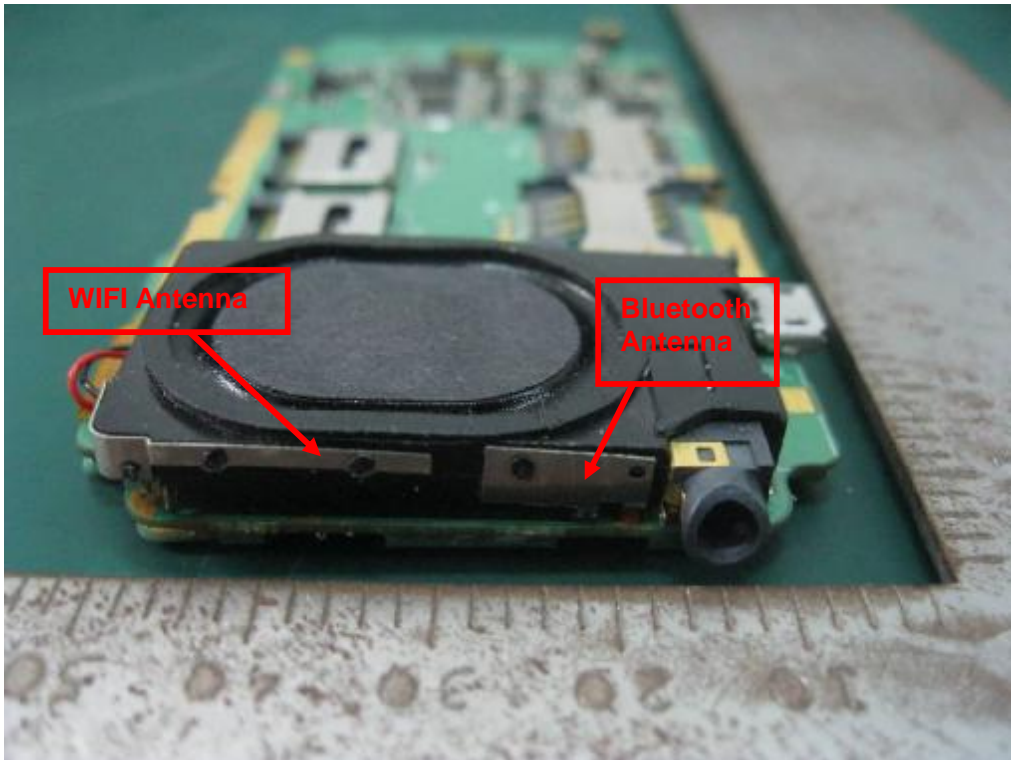

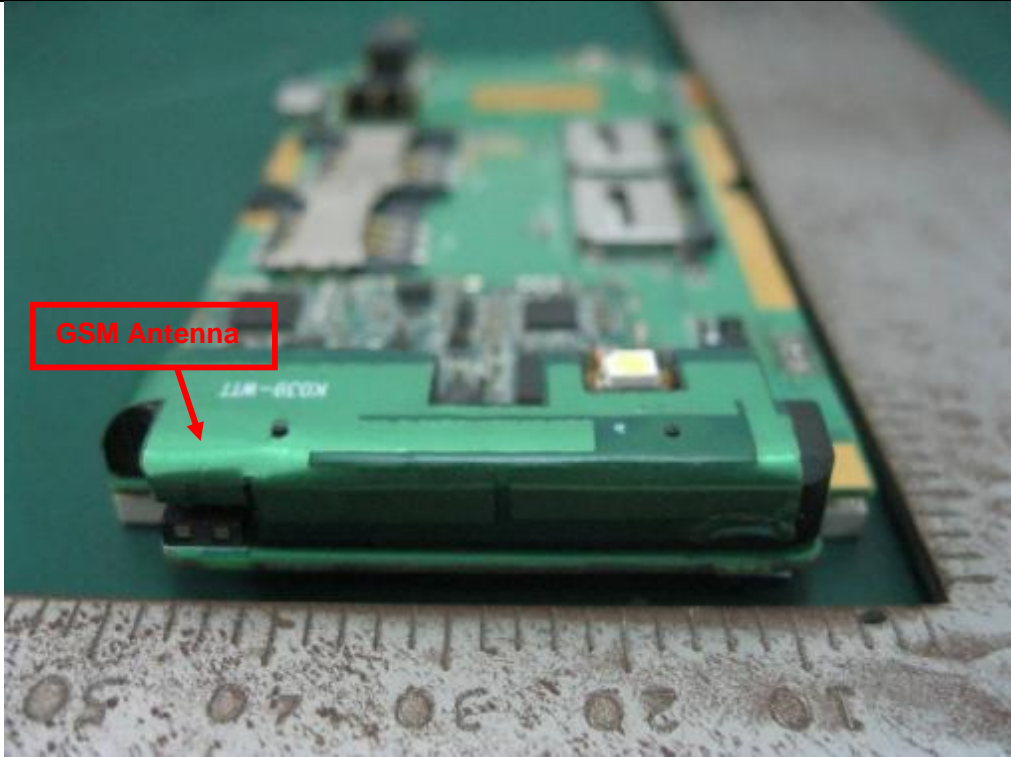



SIEMIC, Inc.

Accessing global markets

Title: EMC Test Report for GSM&WCDMA MOBILE PHONE
Model: S-502
To: FCC Part 15B:2010

Serial#: 11070066-FCC Part 15B
Issue Date: 28 September, 2011
Page: 25 of 37
www.siemic.com.cn

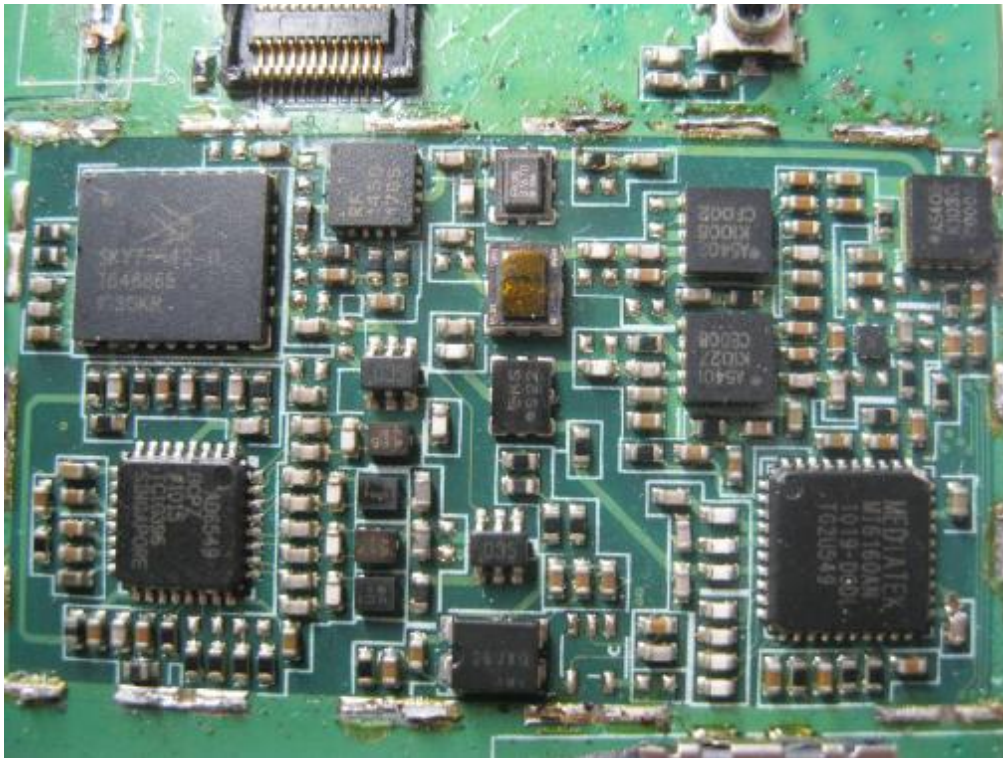

Annex B.iii. Photograph : Test Setup Photo

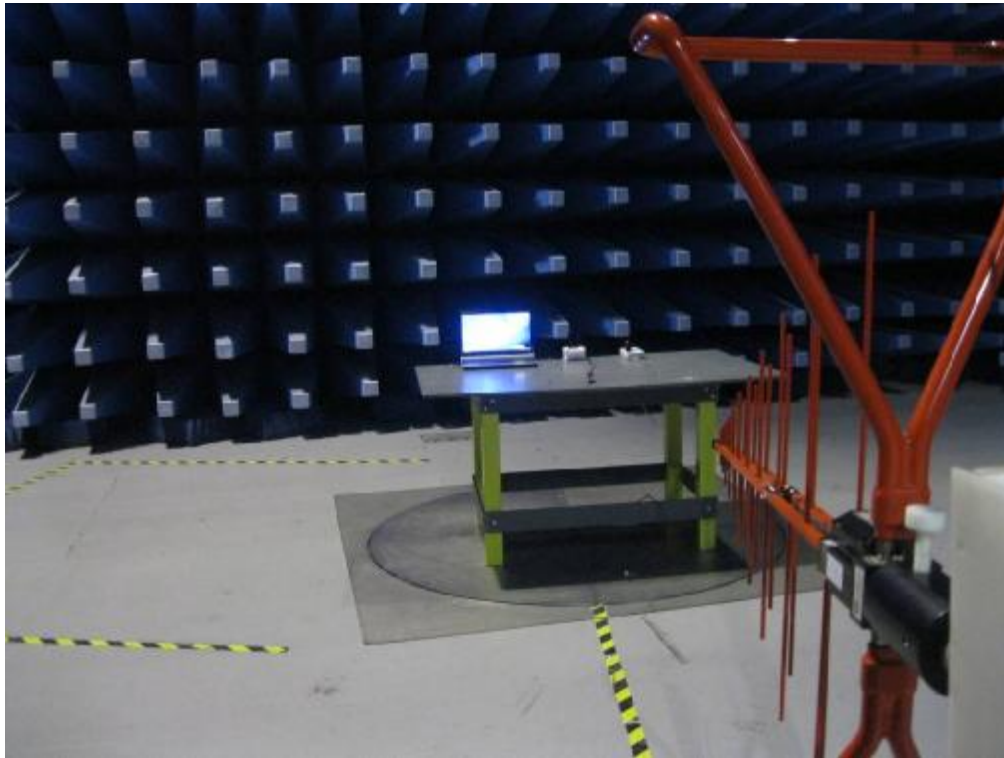

Radiated Emission Test Setup Front View Below 1GHz

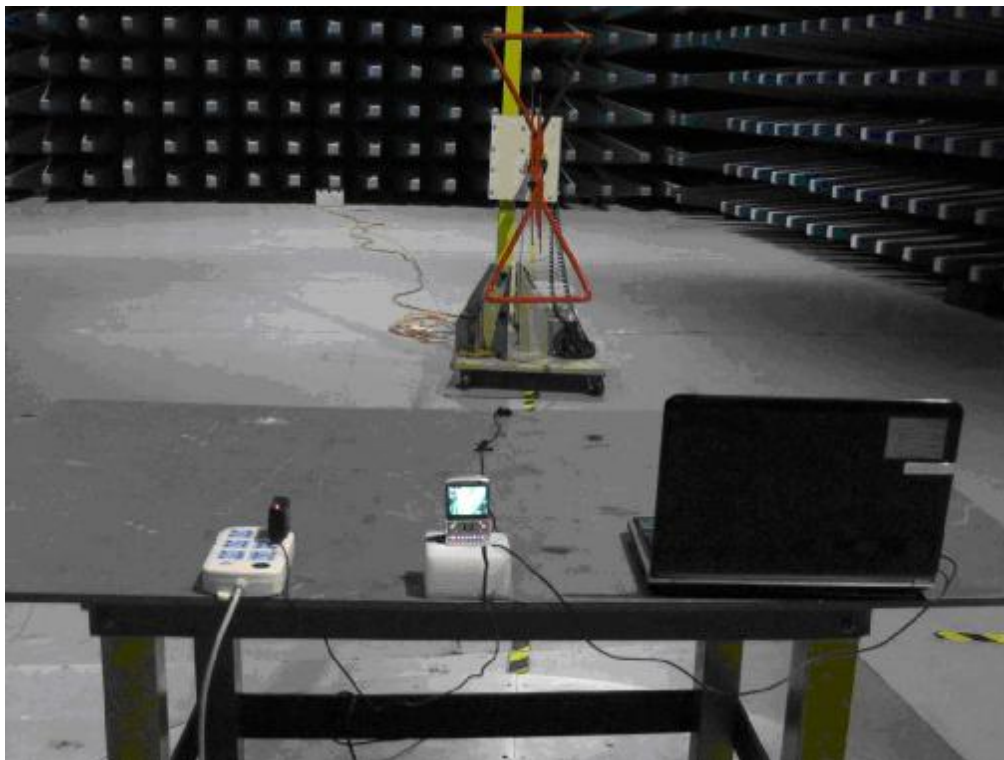

Radiated Emission Test Setup Front View Below 1GHz

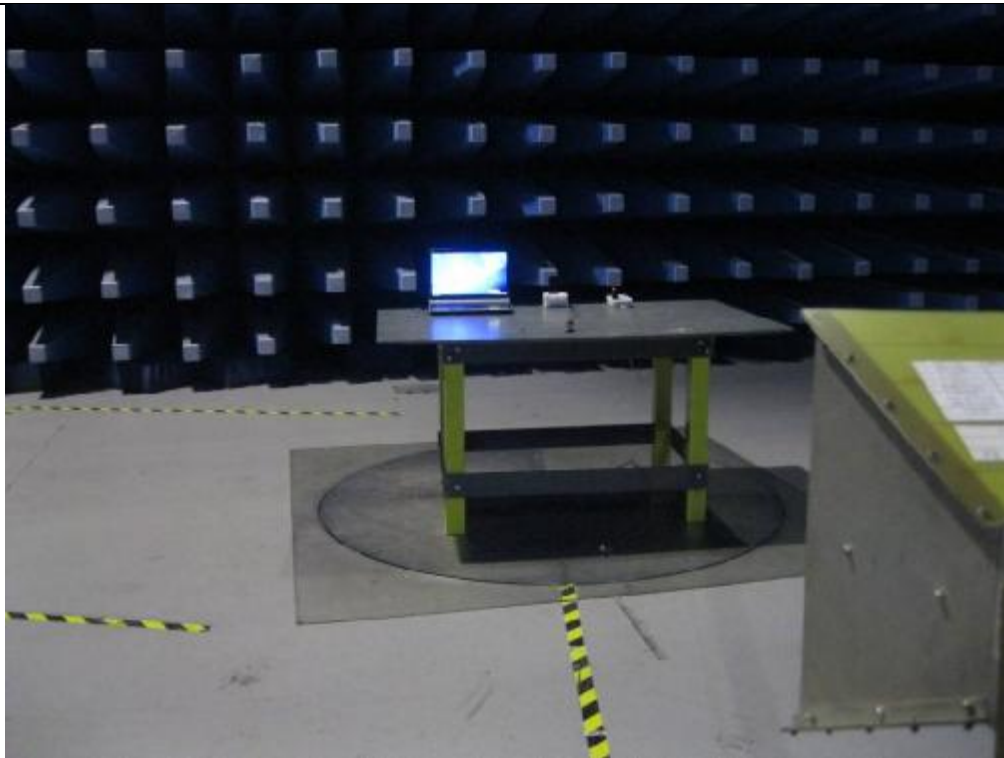

Radiated Emission Test Setup Front View Above 1GHz

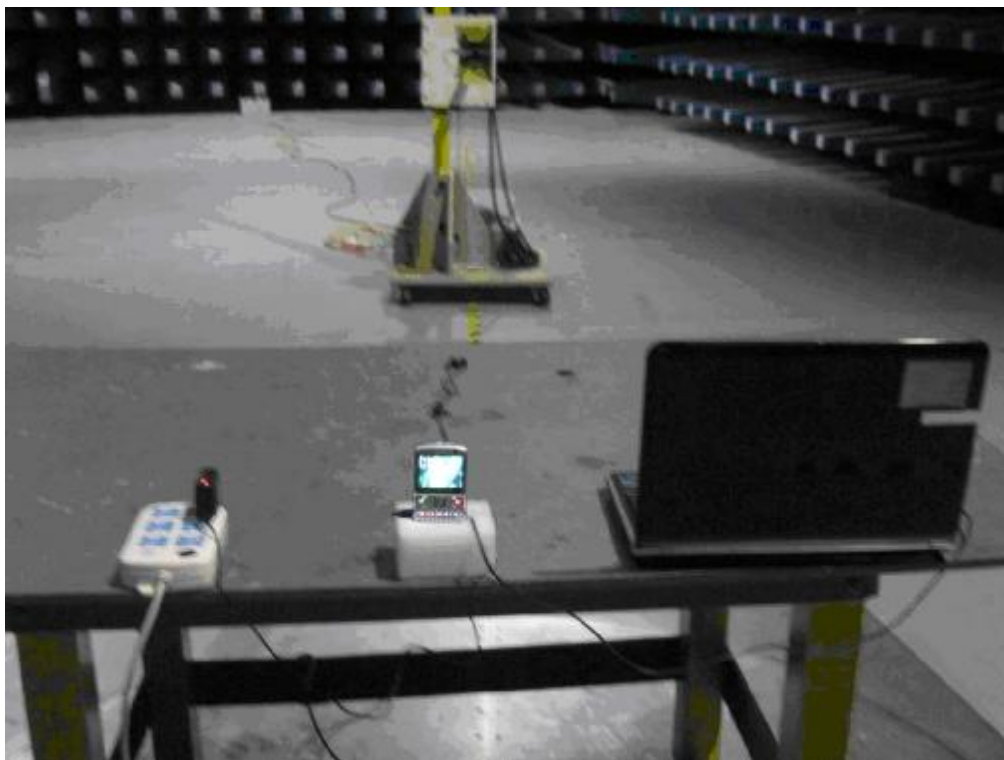

Radiated Emission Test Setup Front View Above 1GHz

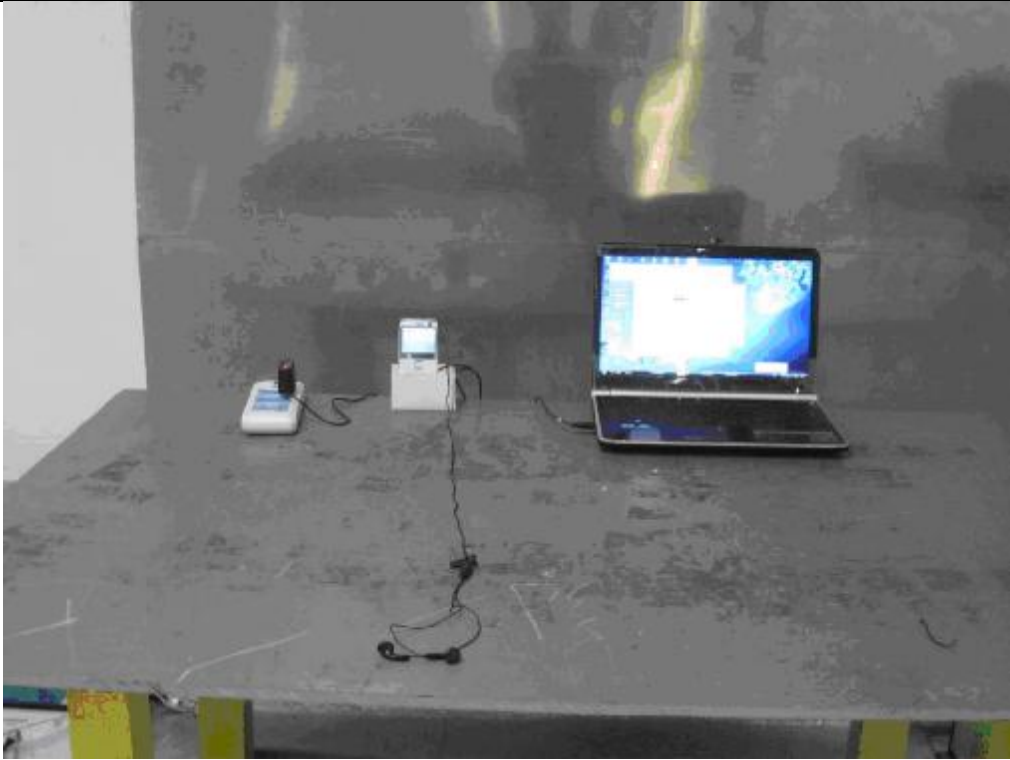

Conducted Emissions Test Setup Front View



Conducted Emissions Test Setup Side View

Annex C. TEST SETUP AND SUPPORTING EQUIPMENT

EUT TEST CONDITIONS

Annex C. i. SUPPORTING EQUIPMENT DESCRIPTION

The following is a description of supporting equipment and details of cables used with the EUT.

Equipment Description (Including Brand Name)	Model & Serial Number	Cable Description (List Length, Type & Purpose)
Gateway Laptop	MS2288 & LXWHF02013951C3CA92200	N/A

Block Configuration Diagram for Conducted Emission

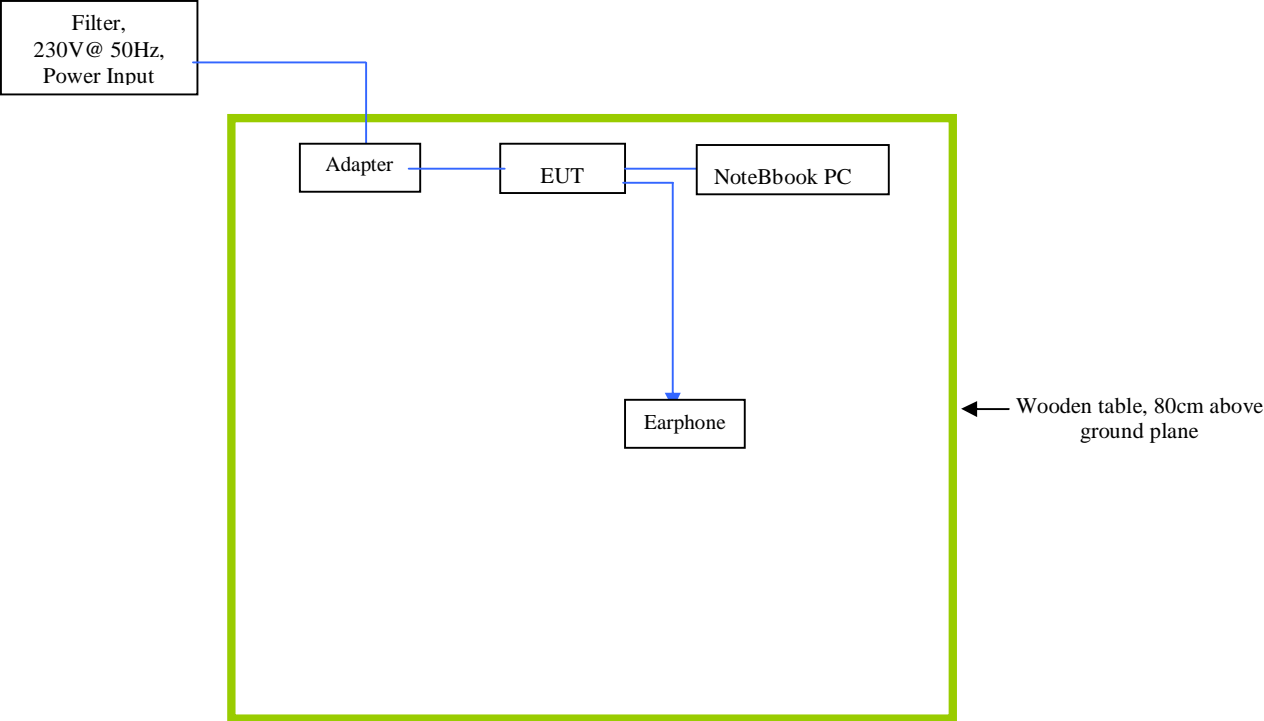

Block Configuration Diagram for Radiated Emission

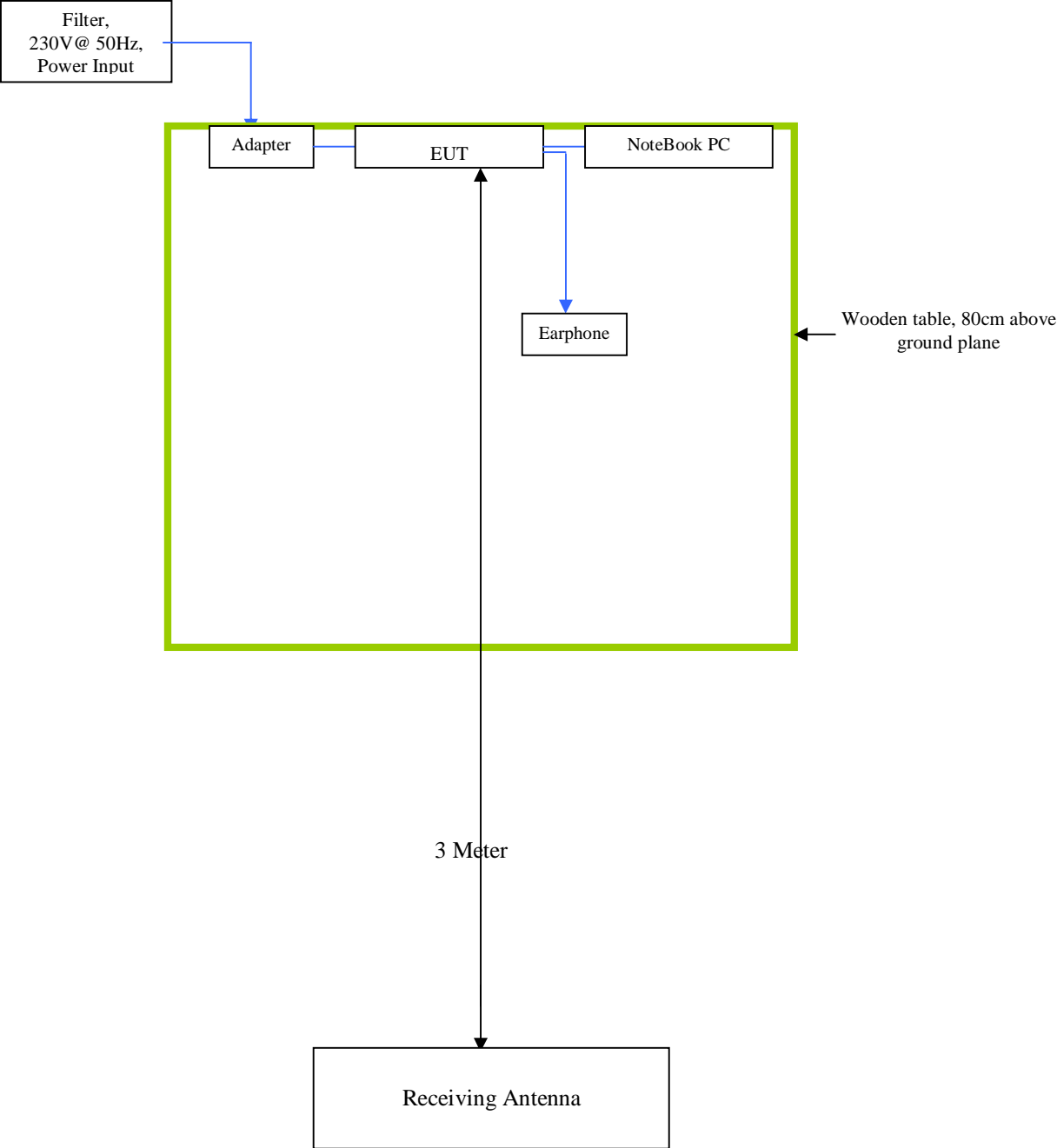



SIEMIC, INC.

Accessing global markets

Title: EMC Test Report for GSM&WCDMA MOBILE PHONE
Model: S-502
To: FCC Part 15B:2010

Serial#: 11070066-FCC Part 15B
Issue Date: 28 September, 2011
Page: 32 of 37
www.siemic.com.cn

Annex C.ii. EUT OPERATING CONDITIONS

The following is the description of how the EUT is exercised during testing.

Test	Description Of Operation
Emissions Testing	TX mode is USB link continuous transmitting



SIEMIC, Inc.

Accessing global markets

Title: EMC Test Report for GSM&WCDMA MOBILE PHONE
Model: S-502
To: FCC Part 15B:2010

Serial#: 11070066-FCC Part 15B
Issue Date: 28 September, 2011
Page: 33 of 37
www.siemic.com.cn

Annex D. USER MANUAL / BLOCK DIAGRAM / SCHEMATICS / PART LIST

Please see attachment

Annex E. SIEMIC ACCREDITATION CERTIFICATES

SIEMIC ACCREDITATION DETAILS: FCC Registration NO:986914





SIEMIC, Inc.

Accessing global markets

Title: EMC Test Report for GSM&WCDMA MOBILE PHONE
Model: S-502
To: FCC Part 15B:2010

Serial#: 11070066-FCC Part 15B
Issue Date: 28 September, 2011
Page: 35 of 37
www.siemic.com.cn

SIEMIC ACCREDITATION DETAILS: FCC Listing, Registration NO:986914

FEDERAL COMMUNICATIONS COMMISSION

Laboratory Division
7435 Oakland Mills Road
Columbia, MD 21046

April 19, 2011

Registration Number: 986914

SIEMIC Nanjing (China) Laboratories
2-1 Longcang Avenue,
Yuhua Economic and Technology Development Park,
Nanjing, 210039
China

Attention: Leslie Bai,

Re: Measurement facility located at 2-1 Longcang Avenue, Nanjing, China
Anechoic chamber (3 meters) and 3&10 meter OATS
Date of Renewal: April 19, 2011

Dear Sir or Madam:

Your request for renewal of the registration of the subject measurement facility has been received. The information submitted has been placed in your file and the registration has been renewed. The name of your organization will remain on the list of facilities whose measurement data will be accepted in conjunction with applications for Certification under Parts 15 or 18 of the Commission's Rules. Please note that the file must be updated for any changes made to the facility and the registration must be renewed at least every three years.

Measurement facilities that have indicated that they are available to the public to perform measurement services on a fee basis may be found on the FCC website www.fcc.gov under E-Filing, OET Equipment Authorization Electronic Filing, Test Firms.

Sincerely,

Phyllis Parrish
Industry Analyst

SIEMIC ACCREDITATION DETAILS: Industry of Canada Registration No. 4842

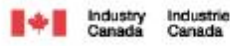

January 25, 2011

OUR FILE: 46405-4842
Submission No: 145222

Siemic Nanjing (China) Laboratories
2-1 Longcang Avenue
Yuhua Economic & Technology Dev. Park, Nanjing
China

Attention: Leslie Bai

Dear Sir/Madame:

The Bureau has received your application for the registration of a 3/10m OATS. Be advised that the information received was satisfactory to Industry Canada. The following number(s) is now associated to the site(s) for which registration / renewal was sought (**Site# 4842B-2**). Please reference the appropriate site number in the body of test reports containing measurements performed on the site. In addition, please keep for your records the following information;

- The company address code associated to the site(s) located at the above address is: **4842B**

Furthermore, to obtain or renew a unique site number, the applicant shall demonstrate that the site has been accredited to ANSI C63.4-2003 or later. A scope of accreditation indicating the accreditation by a recognized accreditation body to ANSI C63.4-2003 or later shall be accepted. Please indicate in a letter the previous assigned site number if applicable and the type of site (example: 3 metre OATS or 3 metre chamber). If the test facility is not accredited to ANSI C63.4-2003 or later, the test facility shall submit test data demonstrating full compliance with the ANSI standard. The Bureau will evaluate the filing to determine if recognition shall be granted.

The frequency for re-validation of the test site and the information that is required to be filed or retained by the testing party shall comply with the requirements established by the accrediting organization. However, in all cases, test site re-validation shall occur on an interval not to exceed three years. There is no fee or form associated with an OATS filing. OATS submissions are encouraged to be submitted electronically to the Bureau using the following URL;
http://strategis.ic.gc.ca/epic/internet/inceb-bhst.nsf/en/h_tt00052e.html.

If you have any questions, you may contact the Bureau by e-mail at certification.bureau@ic.gc.ca Please reference our file and submission number above for all correspondence.

Yours sincerely,

Dalwinder Gill
For: Wireless Laboratory Manager
Certification and Engineering Bureau
3701 Carling Ave., Building 94
P.O. Box 11490, Station "H"
Ottawa, Ontario K2H 8S2
Email: dalwinder.gill@ic.gc.ca
Tel. No. (613) 996-8363
Fax. No. (613) 990-4752



SIEMIC, INC.

Accessing global markets

Title: EMC Test Report for GSM&WCDMA MOBILE PHONE
Model: S-502
To: FCC Part 15B:2010

Serial#: 11070066-FCC Part 15B
Issue Date: 28 September, 2011
Page: 37 of 37
www.siemic.com.cn