

FCC REPORT (Mobile Phone)

Applicant: SHENZHEN KENXINDA TECHNOLOGY CO.,LTD

Address of Applicant: 18TH FLOOR,FUCHUN ORIENT BUILDING,SHENNAN
AV 7006, SHENZHEN, CHINA

Equipment Under Test (EUT)

Product Name: GSM MOBILE PHONE

Model No.: S-250

Trade mark: SEFTON

FCC ID: ZSHS-250

Applicable standards: FCC CFR Title 47 Part 2: 2010
FCC CFR Title 47 Part22 Subpart H: 2010
FCC CFR Title 47 Part24 Subpart E: 2010

Date of sample receipt: Nov. 1, 2011

Date of Test: Nov. 1-14, 2011

Date of report issued: Nov. 16, 2011

Test Result : PASS *

* In the configuration tested, the EUT complied with the standards specified above.

Authorized Signature:



Stephen Guo
Laboratory Manage

This report details the results of the testing carried out on one sample. The results contained in this test report do not relate to other samples of the same product and does not permit the use of the GTS product certification mark. The manufacturer should ensure that all products in series production are in conformity with the product sample detailed in this report.

This report may only be reproduced and distributed in full. If the product in this report is used in any configuration other than that detailed in the report, the manufacturer must ensure the new system complies with all relevant standards. Any mention of GTS International Electrical Approvals or testing done by GTS International Electrical Approvals in connection with, distribution or use of the product described in this report must be approved by GTS International Electrical Approvals in writing.

This document cannot be reproduced except in full, without prior written approval of the Company. Any unauthorized alteration, forgery or falsification of the content or appearance of this document is unlawful and offenders may be prosecuted to the fullest extent of the law. Unless otherwise stated the results shown in this test report refer only to the sample(s) tested and such sample(s) are retained for 90 days only."

2 Version

Version No.	Date	Description
00	Nov. 16, 2011	Original

Prepared By: Collin He **Date:** Nov. 16, 2011
Project Engineer

Check By: Hans Hu **Date:** Nov. 16, 2011
Reviewer

3 Contents

	Page
1 COVER PAGE	1
2 VERSION	2
3 CONTENTS	3
4 TEST SUMMARY	4
5 GENERAL INFORMATION	5
5.1 CLIENT INFORMATION	5
5.2 GENERAL DESCRIPTION OF E.U.T.	5
5.3 TEST MODE:	6
5.4 RELATED SUBMITTAL(S) / GRANT (S)	7
5.5 TEST METHODOLOGY	7
5.6 TEST FACILITY.....	7
5.7 TEST LOCATION	7
5.8 TEST INSTRUMENTS LIST	8
6 SYSTEM TEST CONFIGURATION.....	9
6.1 EUT CONFIGURATION.....	9
6.2 EUT EXERCISE	9
6.3 CONFIGURATION OF TESTED SYSTEM	9
6.4 DESCRIPTION OF TEST MODES	9
6.5 CONDUCTED EMISSIONS.....	10
6.6 CONDUCTED PEAK OUTPUT POWER.....	13
6.7 OCCUPY BANDWIDTH.....	14
6.8 MODULATION CHARACTERISTIC	19
6.9 OUT OF BAND EMISSION AT ANTENNA TERMINALS	19
6.10 ERP, EIRP MEASUREMENT	28
6.11 FIELD STRENGTH OF SPURIOUS RADIATION MEASUREMENT	32
6.12 FREQUENCY STABILITY V.S. TEMPERATURE MEASUREMENT	37
6.13 FREQUENCY STABILITY V.S. VOLTAGE MEASUREMENT	39
7 TEST SETUP PHOTO	40
8 EUT CONSTRUCTIONAL DETAILS	42

4 Test Summary

Test Item	Section in CFR 47	Result
RF Exposure (SAR)	Part 1.1307 Part 2.1093	Passed* (Please refer to SAR Report)
RF Output Power	Part 2.1046 Part 22.913 (a)(2) Part 24.232 (c)	Pass
Modulation Characteristics	Part 2.1047	Pass
99% & -26 dB Occupied Bandwidth	Part 2.1049 Part 22.917 Part 24.238	Pass
Spurious Emissions at Antenna Terminal	Part 2.1051 Part 22.917 (a) Part 24.238 (a)	Pass
Field Strength of Spurious Radiation	Part 2.1053 Part 22.917 (a) Part 24.238 (a)	Pass
Out of band emission, Band Edge	Part 22.917 (a) Part 24.238 (a)	Pass
Frequency stability vs. temperature	Part 2.1055(a)(1)(b)	Pass
Frequency stability vs. voltage	Part 2.1055(d)(1)(2)	Pass

Pass: The EUT complies with the essential requirements in the standard.

5 General Information

5.1 Client Information

Applicant:	SHENZHEN KENXINDA TECHNOLOGY CO.,LTD
Address of Applicant:	18TH FLOOR,FUCHUN ORIENT BUILDING,SHENNAN AV 7006 ,SHENZHEN, CHINA
Manufacturer	SHENZHEN KENXINDA TECHNOLOGY CO.,LTD BAO'AN BRANCH
Address of Manufacturer	1-6 FLOOR,NO.105 WORK SHOP&1-5 FLOOR,NO.104 WORKSHOP,XINWEIHUANING ROAD,DALANG COMMUNITY, DALANGSTREET,BAO'AN DISTRICT,SHENZHEN, P.R.CHINA

5.2 General Description of E.U.T.

Product Name:	GSM MOBILE PHONE
Model No.:	S-250
Trade mark:	SEFTON
Operation Frequency range:	GSM/GPRS 850: 824MHz-849MHz PCS1900: 1850MHz-1910MHz
Type of Emission:	248KGXW
IMEI:	356478040280222
Software Version:	PAC_6620_SL71_A36620_K082_M10_SL71_V011_LAN(A6)
Hardware Version:	MP2.0
Data cable(USB):	Length 1m
Earphone line:	Length 1.5m
AC adapter:	Model No:HWT-2.5W-5050G Input: AC 100-240V 50/60Hz Output: DC 5V 500mA
Power supply:	Type: Li-ion Battery 3.7V 900mAh Voltage:DC 3.7V

Operation Frequency List:

GSM 850		PCS1900	
Channel:	Frequency (MHz)	Channel:	Frequency (MHz)
128	824.20	512	1850.20
129	824.40	513	1850.40
...
189	836.40	660	1879.80
190	836.60	661	1880.00
191	836.80	662	1880.20
...
250	848.60	809	1909.60
251	848.80	810	1909.80

Regards to the operating frequency range over 10 MHz, the Lowest frequency, the middle frequency, and the highest frequency of channel were selected to perform the test, and the selected channel see below:

GSM850			PCS1900		
	Channel	Frequency(MHz)		Channel	Frequency(MHz)
Lowest channel	128	824.20	Lowest channel	512	1850.20
Middle channel	190	836.60	Middle channel	661	1880.00
Highest channel	251	848.80	Highest channel	810	1909.80

5.3 Test mode:

GSM850 mode	Keep the EUT in communicating continuously with CMU200 in 850MHz band, the EUT's operation mode is GSM mode.
GPRS850 mode1	Keep the EUT in communicating continuously with CMU200 in 850MHz band, the EUT's operation mode is GPRS mode which it is 4 downlink and 1 uplink.
GPRS850 mode2	Keep the EUT in communicating continuously with CMU200 in 850MHz band, the EUT's operation mode is GPRS mode which it is 4 downlink and 2 uplink.
PCS1900 mode	Keep the EUT in communicating continuously with CMU200 in 1900MHz band, the EUT's operation mode is GSM mode.
GPRS1900 mode1	Keep the EUT in communicating continuously with CMU200 in 1900MHz band, the EUT's operation mode is GPRS mode which it is 4 downlink and 1 uplink.
GPRS1900 mode2	Keep the EUT in communicating continuously with CMU200 in 1900MHz band, the EUT's operation mode is GPRS mode which it is 4 downlink and 2 uplink.

Pre-scan mode:

Have pre-scan the GSM mode, GPRS mode1 and GPRS mode2, and found the GSM mode which it was worst case mode, so only show the worst case mode in the test report.

Final test mode:

850MHz band	GSM 850 mode
1900MHz band	PCS1900 mode

5.4 Related Submittal(s) / Grant (s)

This submittal(s) (test report) is filing to comply with Section Part 22 subpart H and Part 24 subpart E of the FCC CFR 47 Rules.

5.5 Test Methodology

Both conducted and radiated testing were performed according to the procedures document on chapter 13 of ANSI C63.4 (2009) and FCC CFR 47.1046, 2.1047, 2.1049, 2.1051, 2.1053, 2.1055 and 2.1057

5.6 Test Facility

The test facility is recognized, certified, or accredited by the following organizations:

FCC —Registration No.: 600491

Global United Technology Services Co., Ltd., Shenzhen EMC Laboratory has been registered and fully described in a report filed with the (FCC) Federal Communications Commission. The acceptance letter from the FCC is maintained in files. Registration 600491, July 20, 2010.

Industry Canada (IC)

The 3m Semi-anechoic chamber of Global United Technology Services Co., Ltd. has been Registered by Certification and Engineering Bureau of Industry Canada for radio equipment testing with Registration No.: 9079A-1.

5.7 Test Location

All tests were performed at:

Global United Technology Services Co., Ltd.

Address: 2nd Floor, Block No.2, Laodong Industrial Zone, Xixiang Road Baoan District, Shenzhen, China

Tel: 0755-27798480

Fax: 0755-27798960

5.8 Test Instruments list

Radiated Emission:						
Item	Test Equipment	Manufacturer	Model No.	Inventory No.	Cal.Date (mm-dd-yy)	Cal.Due date (mm-dd-yy)
1	3m Semi- Anechoic Chamber	ZhongYu Electron	9.2(L)*6.2(W)* 6.4(H)	GTS250	Mar. 30 2011	Mar. 29 2012
2	Control Room	ZhongYu Electron	6.2(L)*2.5(W)* 2.4(H)	GTS251	N/A	N/A
3	EMI Test Receiver	Rohde & Schwarz	ESU26	GTS203	Jul. 04 2011	Jul. 03 2012
4	BiConiLog Antenna	SCHWARZBECK MESS-ELEKTRONIK	VULB9163	GTS214	Feb. 26 2011	Feb. 25 2012
5	Double -ridged waveguide horn	SCHWARZBECK MESS-ELEKTRONIK	9120D-829	GTS208	June 30 2011	June 29 2012
6	Horn Antenna	ETS-LINDGREN	3160	GTS217	Mar. 30 2011	Mar. 29 2012
7	EMI Test Software	AUDIX	E3	N/A	N/A	N/A
8	Coaxial Cable	GTS	N/A	GTS213	Apr. 01 2011	Mar. 31 2012
9	Coaxial Cable	GTS	N/A	GTS211	Apr. 01 2011	Mar. 31 2012
9	Coaxial cable	GTS	N/A	GTS210	Apr. 01 2011	Mar. 31 2012
11	Coaxial Cable	GTS	N/A	GTS212	Apr. 01 2011	Mar. 31 2012
12	Amplifier(100kHz-3GHz)	HP	8347A	GTS204	Jul. 04 2011	Jul. 03 2012
13	Amplifier(2GHz-20GHz)	HP	8349B	GTS206	Jul. 04 2011	Jul. 03 2012
14	Pre-amplifier (18-26GHz)	Rohde & Schwarz	AFS33-18002 650-30-8P-44	GTS218	Apr. 01 2011	Mar. 31 2012
15	Band filter	Amindeon	82346	GTS219	Apr. 01 2011	Mar. 31 2012
16	Universal radio communication tester	Rohde & Schwarz	CMU200	GTS235	May 11 2011	May 11 2012
17	Signal Generator	Rohde & Schwarz	SML03	GTS236	May 11 2011	May 11 2012
18	Temp. Humidity/ Barometer	Oregon Scientific	BA-888	GTS248	May 11 2011	May 11 2012
19	D.C. Power Supply	Instek	PS-3030	GTS232	NA	NA
20	Splitter	Agilent	11636B	GTS237	May 11 2011	May 11 2012
21	Power meter	Rohde & Schwarz	NRVS	GTS238	May 11 2011	May 11 2012

Conducted Emission:						
Item	Test Equipment	Manufacturer	Model No.	Inventory No.	Cal.Date (mm-dd-yy)	Cal.Due date (mm-dd-yy)
1	Shielding Room	ZhongYu Electron	7.0(L)x3.0(W)x3.0(H)	GTS252	Jul. 04 2011	Jul. 03 2012
2	EMI Test Receiver	Rohde & Schwarz	ESCS30	GTS223	Jul. 04 2011	Jul. 03 2012
3	10dB Pulse Limita	Rohde & Schwarz	N/A	GTS224	Jul. 04 2011	Jul. 03 2012
4	LISN	SCHWARZBECK MESS-ELEKTRONIK	NSLK 8127	GTS226	Jul. 04 2011	Jul. 03 2012
5	Coaxial Cable	GTS	N/A	GTS227	Apr. 01 2011	Mar. 31 2012
6	EMI Test Software	AUDIX	E3	N/A	N/A	N/A

6 System test configuration

6.1 EUT Configuration

The EUT configuration for testing is installed on RF field strength measurement to meet the commissions requirement and operating in a manner which intends to maximize its emission characteristics in a continuous normal application.

6.2 EUT Exercise

The EUT (Transmitter) was operated in the engineering mode to fix the Tx frequency which was for the purpose of the measurements.

6.3 Configuration of Tested System

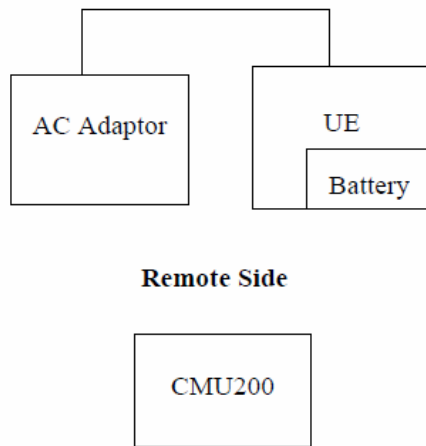

6.4 DESCRIPTION OF TEST MODES

The EUT has been tested under operating condition. EUT staying in continuous transmitting mode. Channel Low, Mid and High for each type band with rated data rate were chosen for full testing. The field strength of spurious radiation emission was measured as EUT stand-up position (H mode) and lie down position (E1, E2 mode) for both GSM/PCS with power adaptors, earphone and Data cable. The worst-case H mode for GSM 850 band, PCS1900 band.

6.5 Conducted Emissions

Test Requirement:	FCC Part15 C Section 15.207														
Test Method:	ANSI C63.4: 2009														
Test Frequency Range:	150KHz to 30MHz														
Class / Severity:	Class B														
Receiver setup:	RBW=9KHz, VBW=30KHz														
Limit:	<table border="1"> <thead> <tr> <th rowspan="2">Frequency range (MHz)</th> <th colspan="2">Limit (dBuV)</th> </tr> <tr> <th>Quasi-peak</th> <th>Average</th> </tr> </thead> <tbody> <tr> <td>0.15-0.5</td> <td>66 to 56*</td> <td>56 to 46*</td> </tr> <tr> <td>0.5-5</td> <td>56</td> <td>46</td> </tr> <tr> <td>5-30</td> <td>60</td> <td>50</td> </tr> </tbody> </table> <p>* Decreases with the logarithm of the frequency.</p>	Frequency range (MHz)	Limit (dBuV)		Quasi-peak	Average	0.15-0.5	66 to 56*	56 to 46*	0.5-5	56	46	5-30	60	50
Frequency range (MHz)	Limit (dBuV)														
	Quasi-peak	Average													
0.15-0.5	66 to 56*	56 to 46*													
0.5-5	56	46													
5-30	60	50													
Test procedure	<ol style="list-style-type: none"> The E.U.T and simulators are connected to the main power through a line impedance stabilization network(L.I.S.N.). The provide a 50ohm/50uH coupling impedance for the measuring equipment. The peripheral devices are also connected to the main power through a LISN that provides a 50ohm/50uH coupling impedance with 50ohm termination. (Please refers to the block diagram of the test setup and photographs). Both sides of A.C. line are checked for maximum conducted interference. In order to find the maximum emission, the relative positions of equipment and all of the interface cables must be changed according to ANSI C63.4: 2009 on conducted measurement. 														
Test setup:	<p>Remark: <i>E.U.T: Equipment Under Test</i> <i>LISN: Line Impedance Stabilization Network</i> <i>Test table height=0.8m</i></p>														
Test Instruments:	Refer to section 5.8 for details														
Test mode:	Pre-scan the all mode, found the communicate mode (PCS1900) which it was worse case mode.														
Test results:	Passed														

Measurement Data

Live Line:

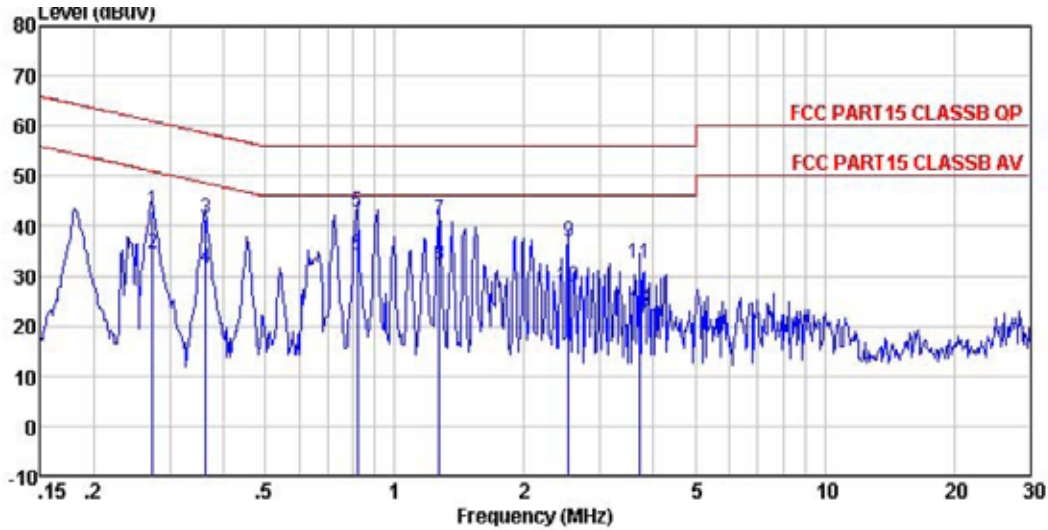

Condition : FCC PART15 CLASSB QP LISN(2011) LINE
 Job No. : 881RF
 Test Mode : communicate mode
 Test Engineer: Collin
 Remark : PCS1900

	Freq	Read Level	LISN Factor	Cable Loss	Level	Limit Line	Over Limit	Remark
	MHz	dBuV	dB	dB	dBuV	dBuV	dB	
1	0.273	42.37	0.62	0.10	43.09	61.03	-17.94	QP
2	0.273	33.65	0.62	0.10	34.37	51.03	-16.66	Average
3	0.363	40.71	0.59	0.10	41.40	58.65	-17.25	QP
4	0.363	30.89	0.59	0.10	31.58	48.65	-17.07	Average
5	0.817	42.08	0.50	0.10	42.68	56.00	-13.32	QP
6	0.817	33.65	0.50	0.10	34.25	46.00	-11.75	Average
7	1.269	40.49	0.45	0.10	41.04	56.00	-14.96	QP
8	1.269	31.58	0.45	0.10	32.13	46.00	-13.87	Average
9	2.540	36.31	0.37	0.10	36.78	56.00	-19.22	QP
10	2.540	27.48	0.37	0.10	27.95	46.00	-18.05	Average
11	3.720	31.95	0.33	0.10	32.38	56.00	-23.62	QP
12	3.720	22.58	0.33	0.10	23.01	46.00	-22.99	Average

Neutral Line:

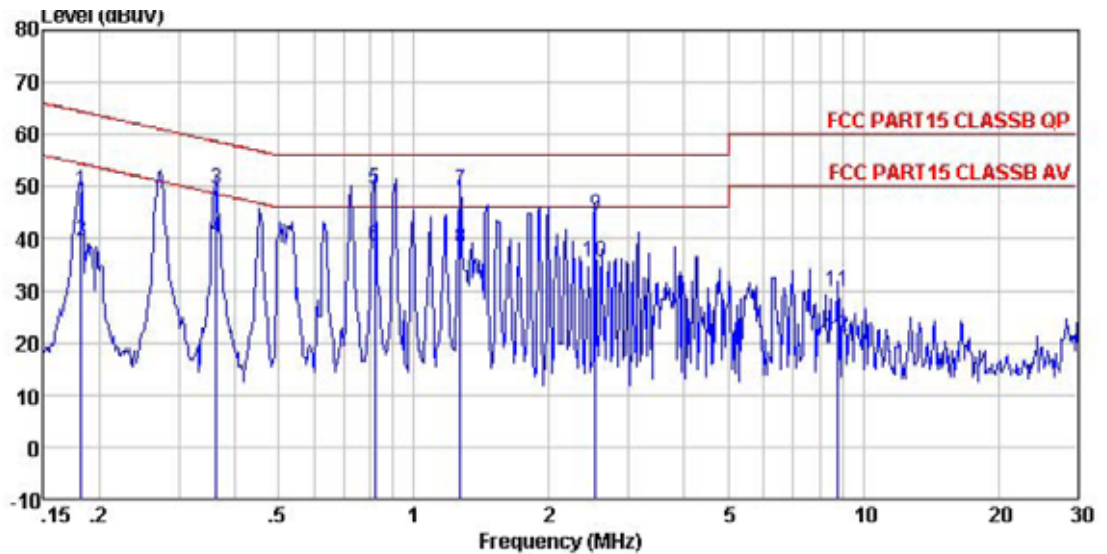

Condition : FCC PART15 CLASSB QP LISN(2011) NEUTRAL
 Job No. : 881RF
 Test Mode : communicate mode
 Test Engineer: Collin
 Remark : PCS1900

	Freq	Read Level	LISN Factor	Cable Loss	Level	Limit Line	Over Limit	Remark
	MHz	dBuV	dB	dB	dBuV	dBuV	dB	
1	0.182	48.32	0.67	0.10	49.09	64.42	-15.33	QP
2	0.182	38.56	0.67	0.10	39.33	54.42	-15.09	Average
3	0.363	48.92	0.59	0.10	49.61	58.65	-9.04	QP
4	0.363	39.45	0.59	0.10	40.14	48.65	-8.51	Average
5	0.817	48.94	0.50	0.10	49.54	56.00	-6.46	QP
6	0.817	37.89	0.50	0.10	38.49	46.00	-7.51	Average
7	1.269	48.50	0.45	0.10	49.05	56.00	-6.95	QP
8	1.269	37.77	0.45	0.10	38.32	46.00	-7.68	Average
9	2.540	43.89	0.37	0.10	44.36	56.00	-11.64	QP
10	2.540	34.87	0.37	0.10	35.34	46.00	-10.66	Average
11	8.776	29.57	0.24	0.19	30.00	60.00	-30.00	QP
12	8.776	20.88	0.24	0.19	21.31	50.00	-28.69	Average

Notes:

1. An initial pre-scan was performed on the live and neutral lines with peak detector.
2. Quasi-Peak and Average measurement were performed at the frequencies with maximized peak emission.
3. Final Level = Receiver Read level + LISN Factor + Cable Loss

6.6 Conducted Peak Output Power

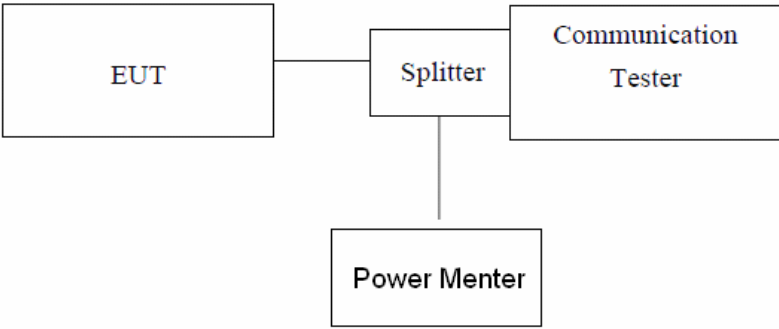
Test Requirement:	FCC part22.913(a) and FCC part24.232(b)
Test Method:	FCC part2.1046
Limit:	GSM850 7W PCS1900 2W
Test setup:	 <p style="text-align: center;"><i>Note: Measurement setup for testing on Antenna connector</i></p>
Test Procedure:	The transmitter output was connected to a calibrated attenuator, the other end of which was connected to the power meter. Transmitter output was read off the power meter in dBm.
Test Instruments:	Refer to section 5.8 for details
Test mode:	Refer to section 5.3 for details
Test results:	Passed

Measurement Data

EUT Mode	Channel	Frequency (MHz)	PK power (dBm)	Limit(dBm)	Result
GSM 850	128	824.20	31.21	38.45	Pass
	190	836.60	31.11		
	251	848.80	31.42		
PCS 1900	512	1850.20	26.89	33.00	Pass
	661	1880.00	26.79		
	810	1909.80	26.54		

6.7 Occupy Bandwidth

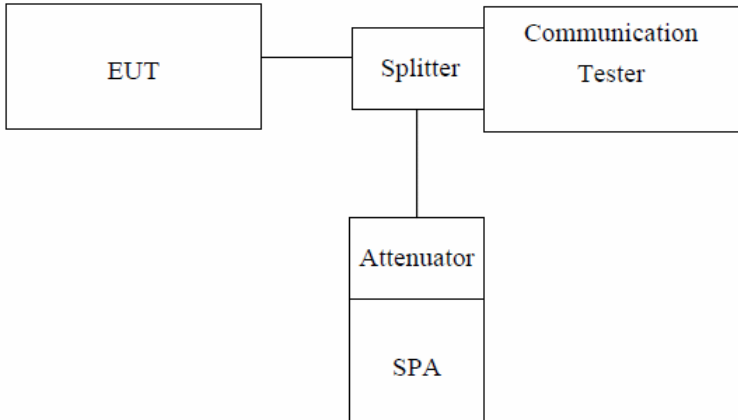
Test Requirement:	FCC part22.913(a) and FCC part24.232(b)
Test Method:	FCC part2.1049
Test setup:	 <p><i>Note: Measurement setup for testing on Antenna connector</i></p>
Test Procedure:	<ol style="list-style-type: none"> 1. The EUT's output RF connector was connected with a short cable to the spectrum analyzer 2. RBW was set to about 1% of emission BW, VBW= 3 times RBW. 3. -26dBc display line was placed on the screen (or 99% bandwidth), the occupied bandwidth is the delta frequency between the two points where the display line intersects the signal trace.
Test Instruments:	Refer to section 5.8 for details
Test mode:	Refer to section 5.3 for details
Test results:	Passed

Measurement Data

EUT Mode	Channel	Frequency (MHz)	99% Occupy bandwidth (KHz)	-26dB bandwidth (KHz)
GSM 850	128	824.20	244	314
	190	836.60	242	318
	251	848.80	242	314
PCS 1900	512	1850.20	244	320
	661	1880.00	248	316
	810	1909.80	246	314

Test plot as follows:

Test Item:	99% Occupy bandwidth	Test Mode:	GSM850
------------	----------------------	------------	--------

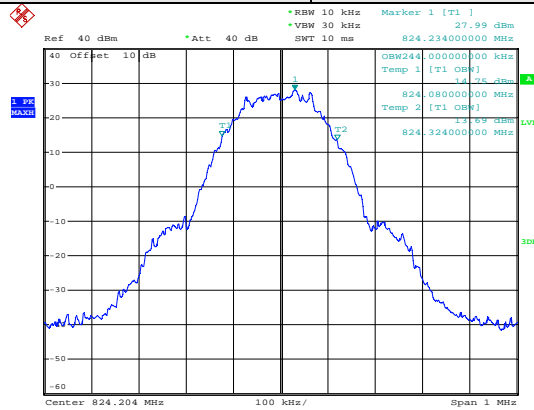

Date: 2.NOV.2011 08:42:00

Lowest channel

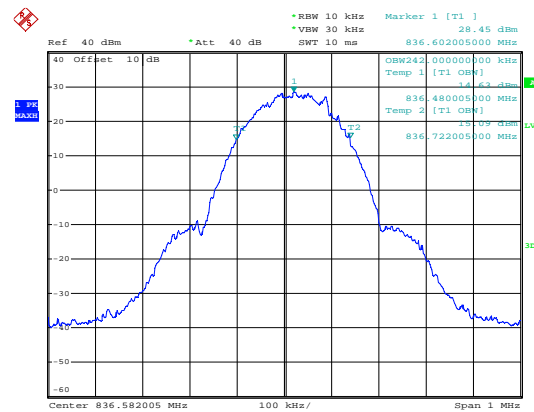

Date: 2.NOV.2011 08:47:32

Middle channel

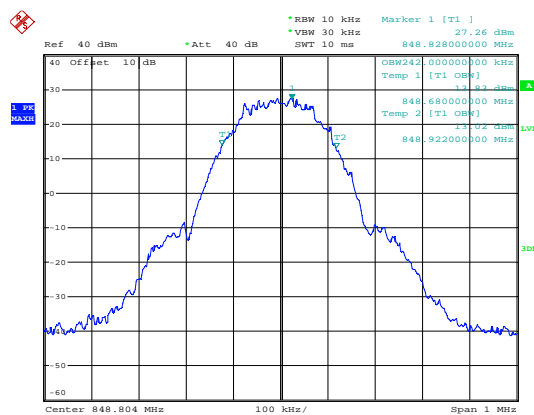

Date: 2.NOV.2011 08:49:53

Highest channel:

Test Item:	99% Occupy bandwidth	Test Mode:	PCS1900
------------	----------------------	------------	---------

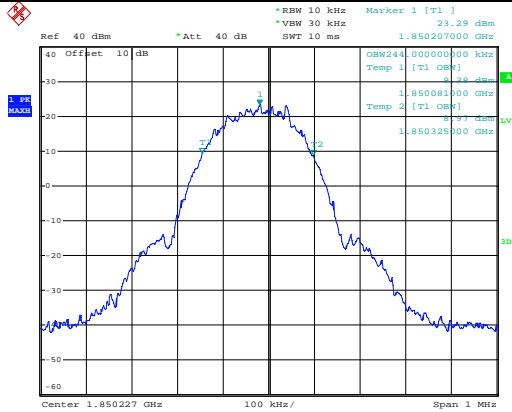

Date: 2.NOV.2011 09:20:59

Lowest channel

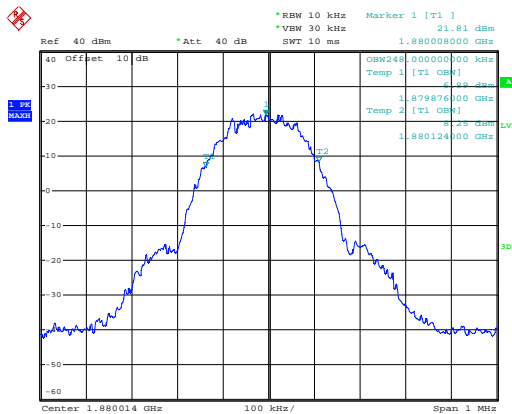

Date: 2.NOV.2011 09:24:47

Middle channel

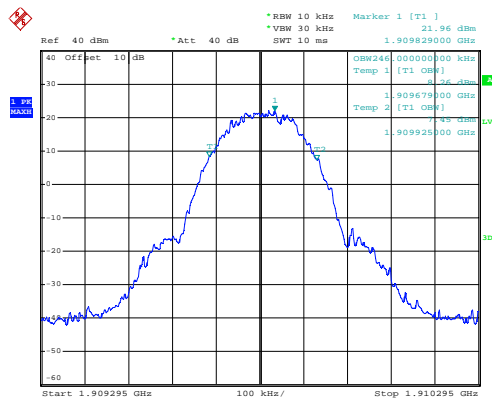

Date: 2.NOV.2011 09:27:36

Highest channel:

Test Item:	-26dB bandwidth	Test Mode:	GSM850
------------	-----------------	------------	--------

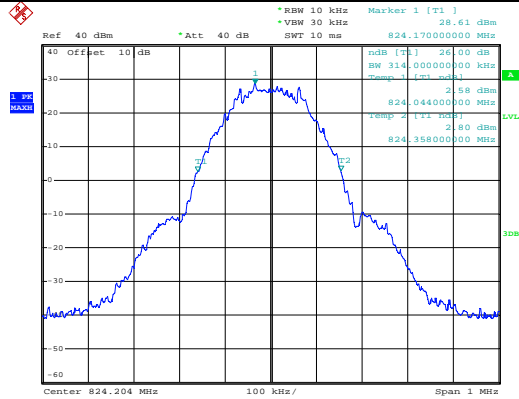

Date: 2.NOV.2011 08:41:23

Lowest channel

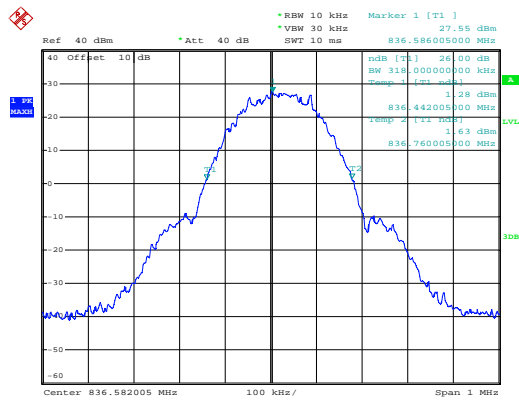

Date: 2.NOV.2011 08:45:26

Middle channel

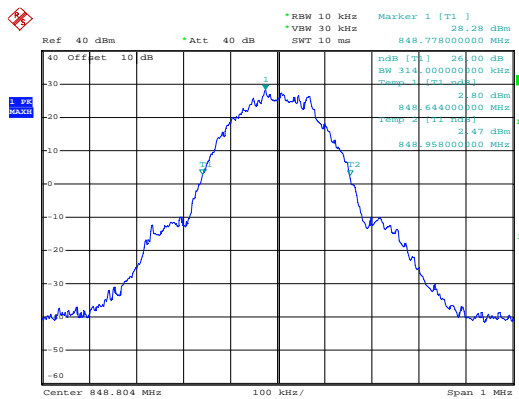

Date: 2.NOV.2011 08:49:21

Highest channel:

Test Item:	-26dB bandwidth	Test Mode:	PCS1900
------------	-----------------	------------	---------

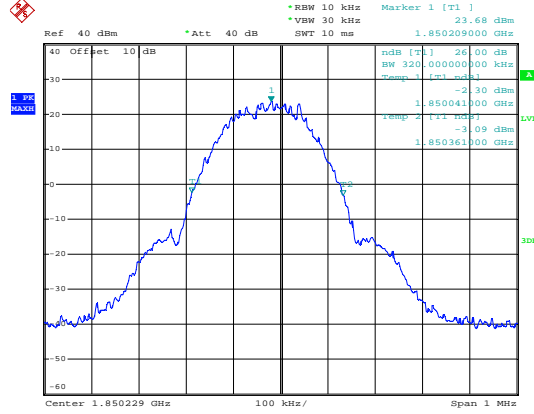

Date: 2.NOV.2011 09:20:32

Lowest channel

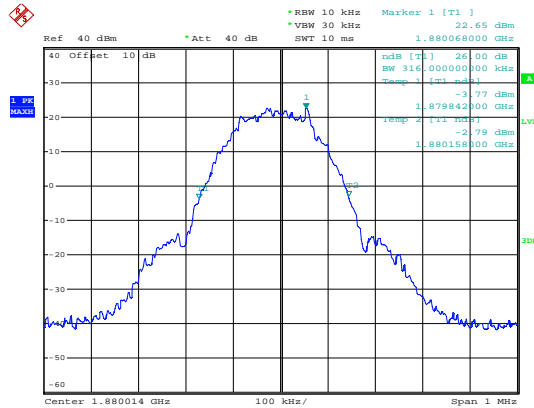

Date: 2.NOV.2011 09:24:24

Middle channel

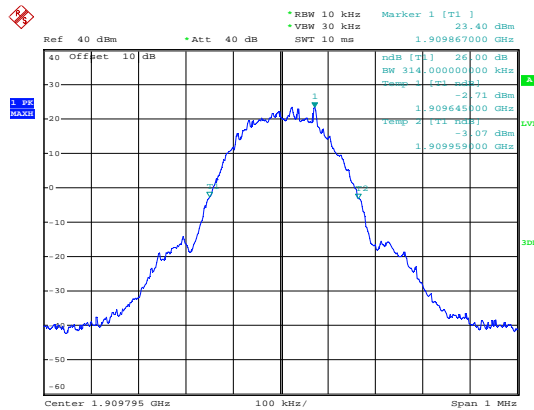

Date: 2.NOV.2011 09:27:08

Highest channel:

6.8 MODULATION CHARACTERISTIC

According to FCC § 2.1047(d), Part 22H & 24E there is no specific requirement for digital modulation, therefore modulation characteristic is not presented.

6.9 Out of band emission at antenna terminals

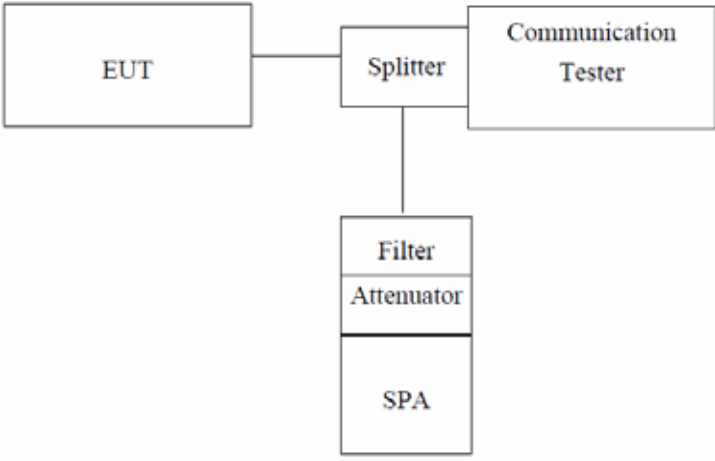
Test Requirement:	FCC part22.917(a) and FCC part24.238(a)
Test Method:	FCC part2.1051
Limit:	-13dBm
Test setup:	 <p><i>Note: Measurement setup for testing on Antenna connector</i></p>
Test Procedure:	<ol style="list-style-type: none"> 1 The RF output of the transceiver was connected to a spectrum analyzer through appropriate attenuation. 2 The resolution bandwidth of the spectrum analyzer was set at 1MHz, sufficient scans were taken to show the out of band Emissions if any up to 10th harmonic. 3 For the out of band: Set the RBW, VBW = 1MHz, Start=30MHz, Stop= 10th harmonic. 4 Band Edge Requirements: In the 1 MHz bands immediately outside and adjacent to the frequency block, a resolution bandwidth of at least 1 percent of the emission bandwidth of the fundamental emission of the transmitter may be employed to measure the out of band Emissions.
Test Instruments:	Refer to section 5.8 for details
Test mode:	Refer to section 5.3 for details
Test results:	Passed

Test plot as follows:

Spurious emission

Test Mode:	GSM850	Test Channel:	Lowest channel
------------	--------	---------------	----------------

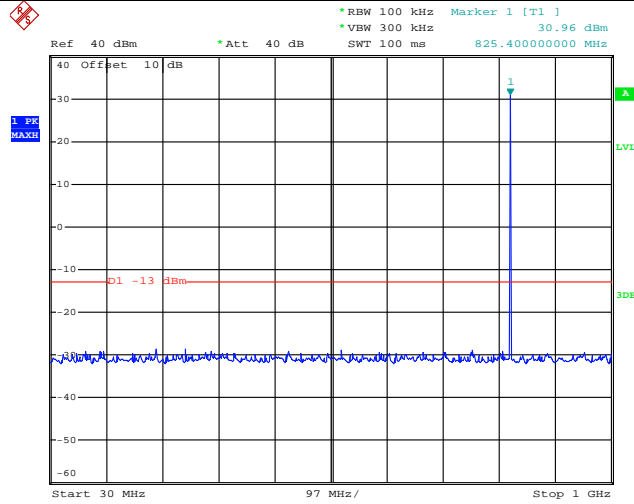

Date: 2.NOV.2011 08:43:32

30MHz~1GHz

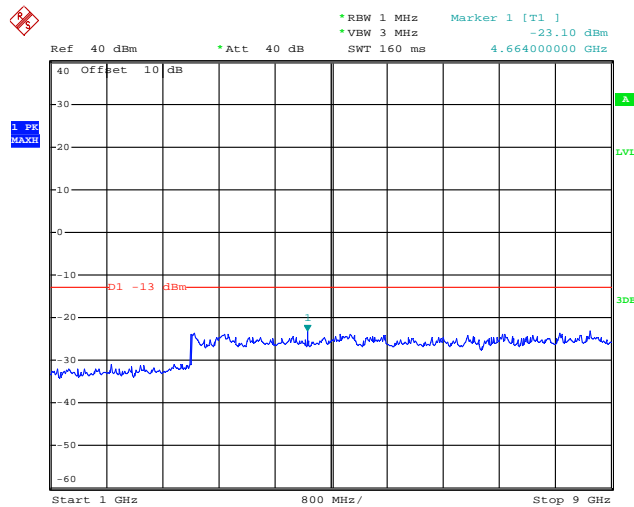

Date: 2.NOV.2011 08:44:02

1GHz~9GHz

Test Mode:	GSM850	Test Channel:	Middle channel
------------	--------	---------------	----------------

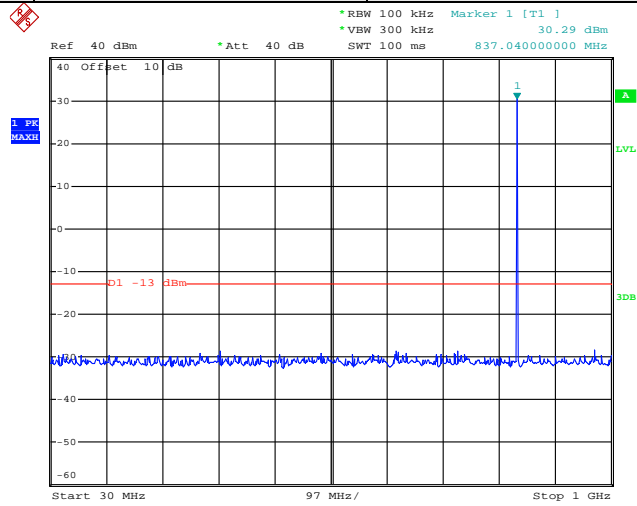

Date: 2.NOV.2011 08:47:58

30MHz~1GHz

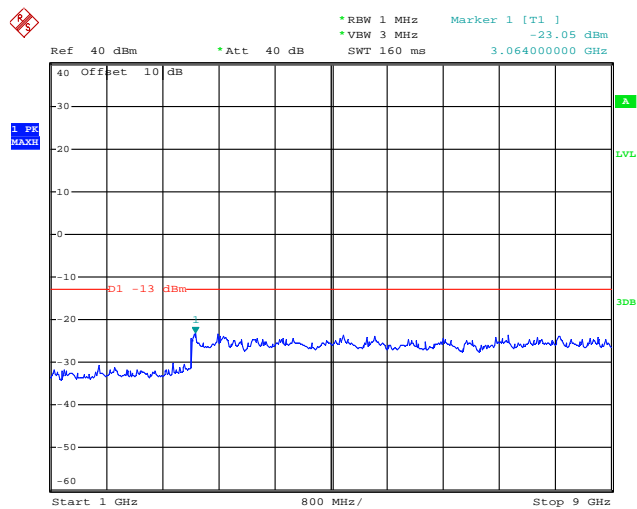

Date: 2.NOV.2011 08:48:18

1GHz~9GHz

Test Mode:	GSM850	Test Channel:	Highest channel
------------	--------	---------------	-----------------

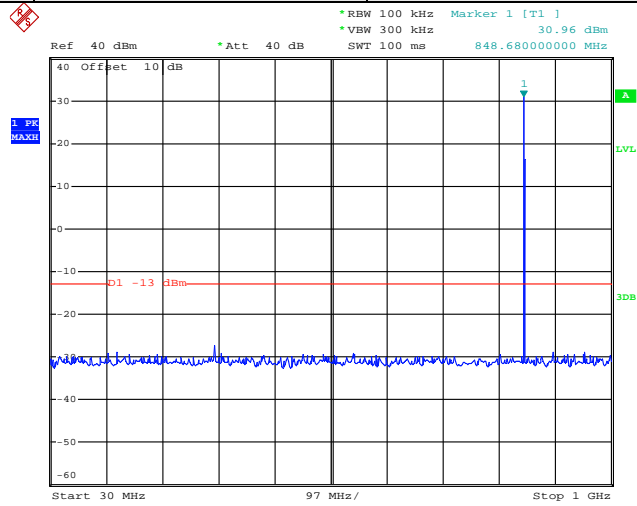

Date: 2.NOV.2011 08:51:34

30MHz~1GHz

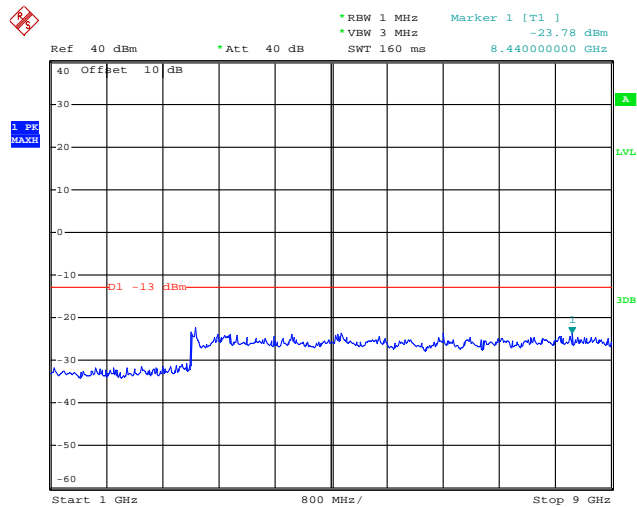

Date: 2.NOV.2011 08:51:52

1GHz~9GHz

Test Mode:	PCS1900	Test Channel:	Lowest channel
------------	---------	---------------	----------------

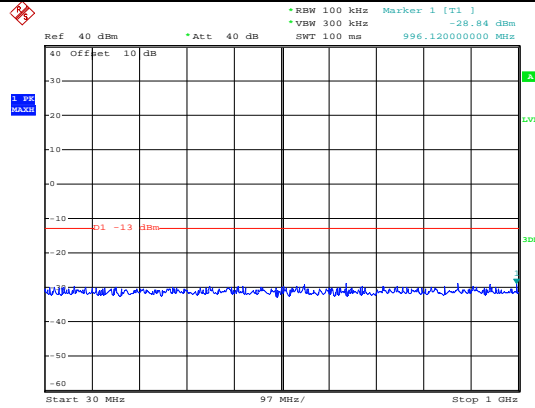

Date: 2.NOV.2011 09:22:12

30MHz~1GHz

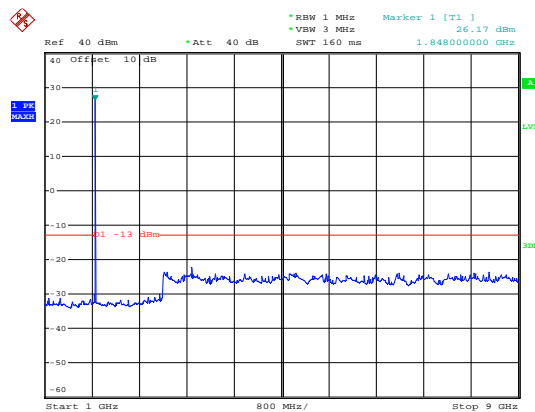

Date: 2.NOV.2011 09:22:35

1GHz~9GHz

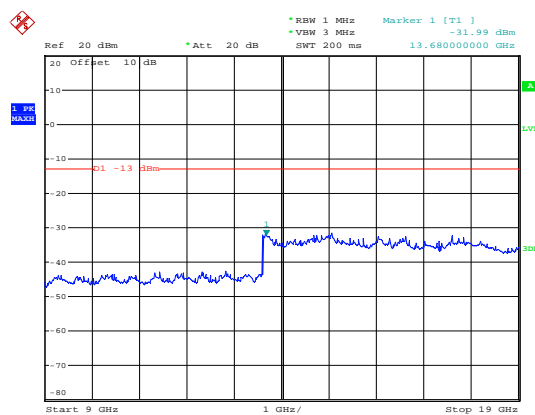

Date: 2.NOV.2011 09:22:56

9GHz~19GHz

Test Mode:	PCS1900	Test Channel:	Middle channel
------------	---------	---------------	----------------

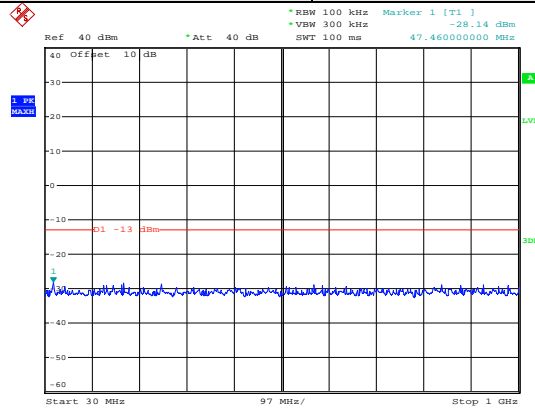

Date: 2.NOV.2011 09:25:12

30MHz~1GHz

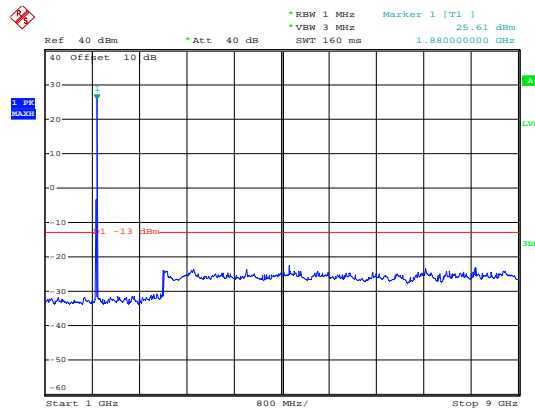

Date: 2.NOV.2011 09:25:35

1GHz~9GHz

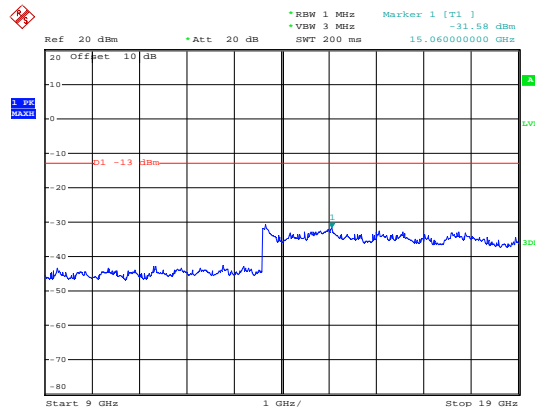

Date: 2.NOV.2011 09:23:05

9GHz~19GHz

Test Mode:	PCS1900	Test Channel:	Highest channel
------------	---------	---------------	-----------------

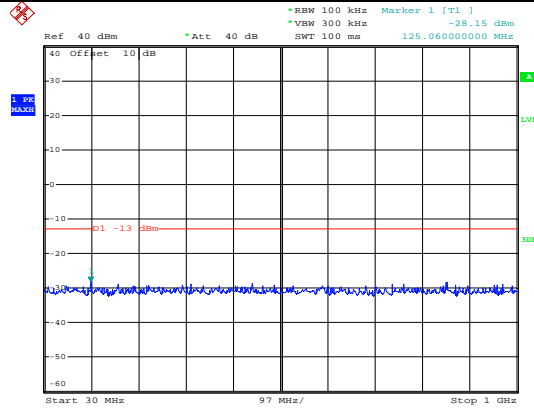

Date: 2.NOV.2011 09:31:24

30MHz~1GHz

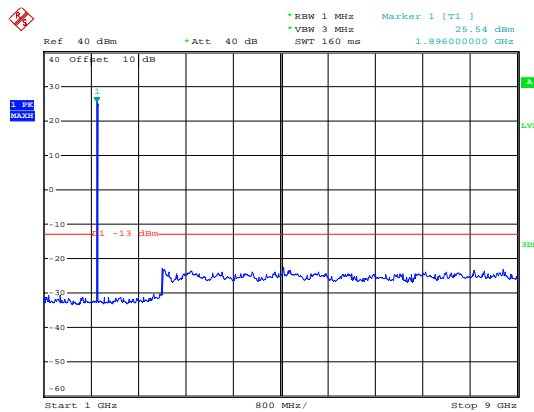

Date: 2.NOV.2011 09:32:07

1GHz~9GHz

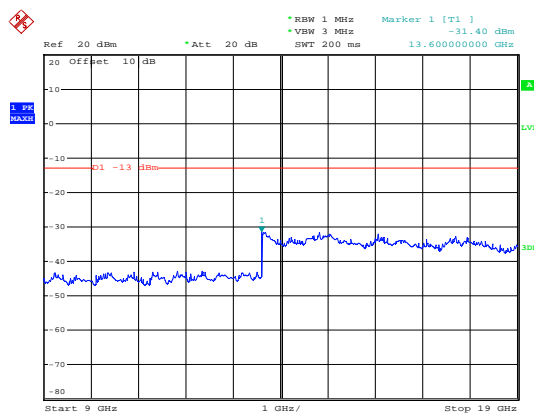

Date: 2.NOV.2011 09:23:15

9GHz~19GHz

Band edge emission:

Test Mode:	GSM850
------------	--------

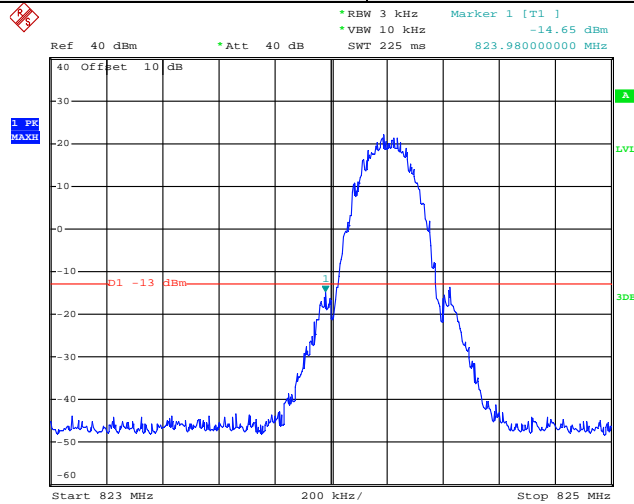

Date: 2.NOV.2011 08:42:44

Lowest channel

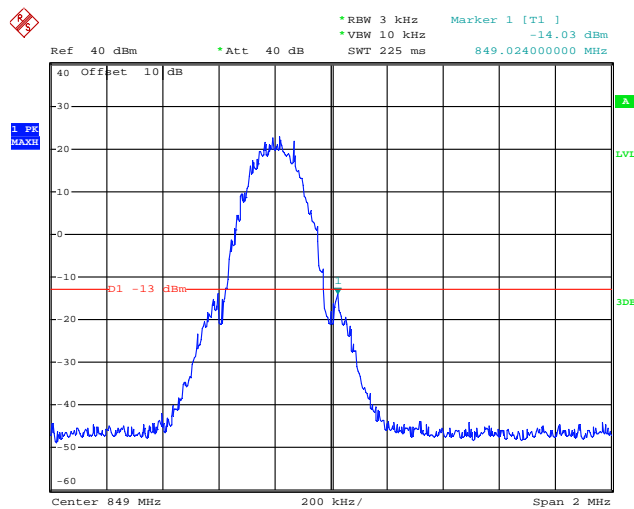

Date: 2.NOV.2011 08:50:41

Highest channel

Test Mode:	PCS1900
------------	---------

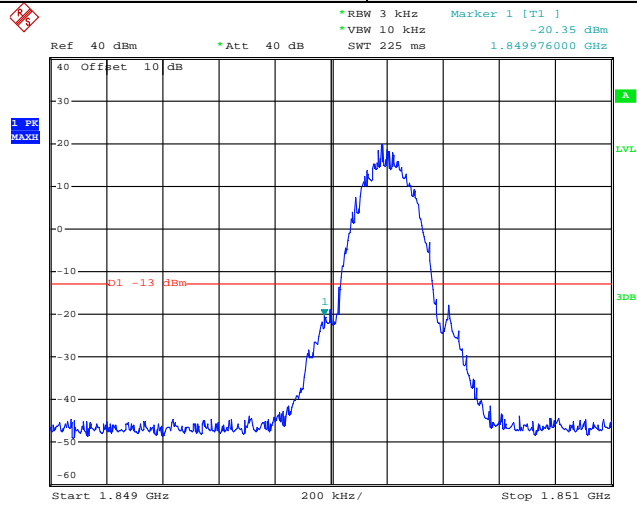

Date: 2.NOV.2011 09:21:53

Lowest channel

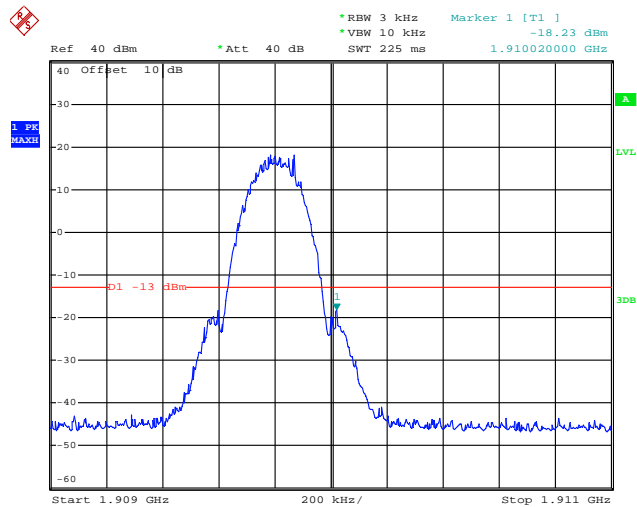

Date: 2.NOV.2011 09:30:37

Highest channel

6.10 ERP, EIRP Measurement

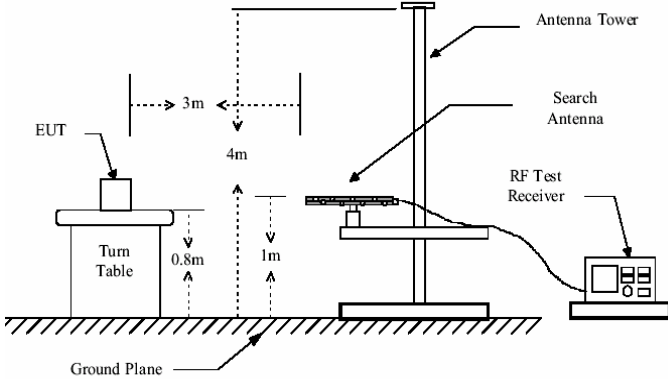
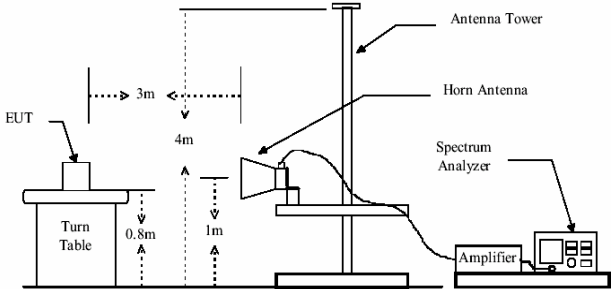
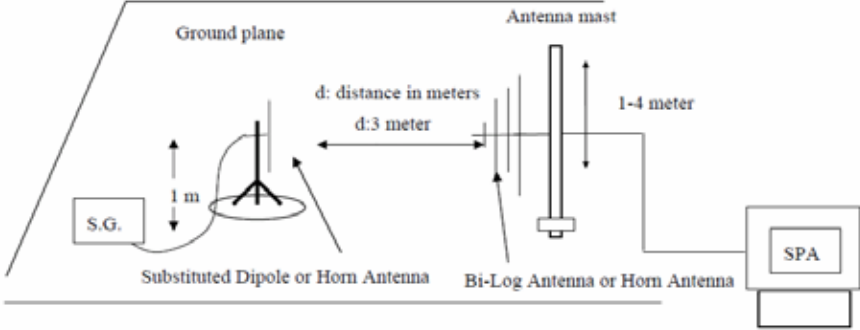
Test Requirement:	FCC part22.913(a) and FCC part24.232(b)
Test Method:	FCC part2.1046
Limit:	GSM850 7W ERP PCS1900 2W EIRP
Test setup:	<p>Below 1GHz</p>  <p>Above 1GHz</p>  <p>Substituted method:</p> 

<p>Test Procedure:</p>	<ol style="list-style-type: none"> 1. The EUT was placed on an non-conductive turntable using a non-conductive support. The radiated emission at the fundamental frequency was measured at 3 m with a test antenna and EMI spectrum analyzer. 2. During the measurement, the EUT was communication with the station. The highest emission was recorded with the rotation of the turntable and the lowering of the test antenna from 4m to 1m. The reading was recorded and the field strength (E in dBuV/m) was calculated. 3. ERP in frequency band 824.2 –848.80.8MHz were measured using a substitution method. The EUT was replaced by dipole antenna connected, the S.G. output was recorded and ERP was calculated asfollows: $\text{ERP} = \text{S.G. output (dBm)} + \text{Antenna Gain (dBd)} - \text{Cable Loss (dB)}$ 4. EIRP in frequency band 1850.2 –1909.8MHz were measured using a substitution method. The EUT was replaced by or horn antenna connected, the S.G. output was recorded and EIRP was calculated as follows: $\text{EIRP} = \text{S.G. output (dBm)} + \text{Antenna Gain (dBi)} - \text{Cable Loss (dB)}$
<p>Test Instruments:</p>	<p>Refer to section 5.8 for details</p>
<p>Test mode:</p>	<p>Refer to section 5.3 for details</p>
<p>Test results:</p>	<p>Passed</p>

Measurement Data

EUT mode	Channel	EUT Pol.	Antenna Pol.	ERP(dBm)	Limit (dBm)	Result
GSM850	Lowest	H	V	30.25	38.45	Pass
			H	29.69		
		E1	V	28.31		
			H	28.95		
		E2	V	26.81		
			H	27.76		
	Middle	H	V	30.17	38.45	Pass
			H	29.38		
		E1	V	28.24		
			H	28.41		
		E2	V	27.16		
			H	27.64		
	Highest	H	V	30.11	38.45	Pass
			H	29.14		
		E1	V	28.02		
			H	28.91		
		E2	V	27.11		
			H	28.06		

EUT mode	Channel	EUT Pol.	Antenna Pol.	EIRP (dBm)	Limit (dBm)	Result
PCS1900	Lowest	H	V	28.56	33.00	Pass
			H	26.95		
		E1	V	24.12		
			H	26.87		
		E2	V	23.34		
			H	26.73		
	Middle	H	V	28.07	33.00	Pass
			H	25.83		
		E1	V	24.41		
			H	26.96		
		E2	V	24.48		
			H	26.86		
	Highest	H	V	27.93	33.00	Pass
			H	25.44		
		E1	V	23.08		
			H	26.69		
		E2	V	22.15		
			H	26.37		

6.11 Field strength of spurious radiation measurement

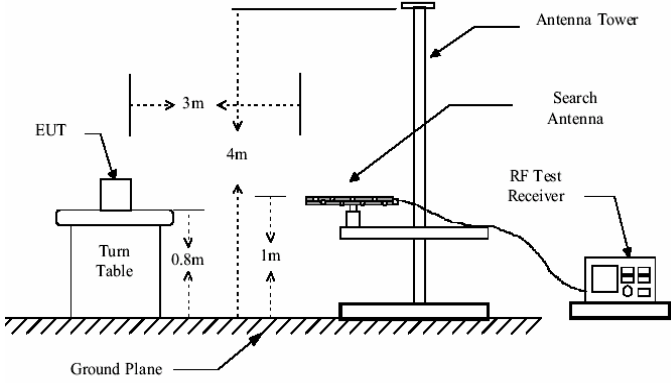
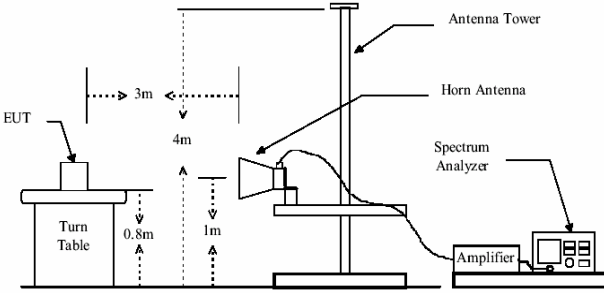
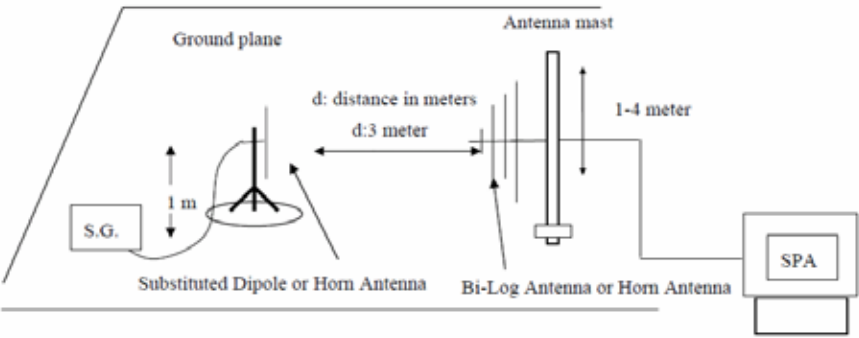
Test Requirement:	FCC part22.917(a) and FCC part24.238(a)
Test Method:	FCC part2.1053
Limit:	-13dBm
Test setup:	<p>Below 1GHz</p>  <p>Above 1GHz</p>  <p>Substituted method:</p> 

<p>Test Procedure:</p>	<ol style="list-style-type: none"> 1. The EUT was placed on a non-conductive turntable using a non-conductive support. The radiated emission at the fundamental frequency was measured at 3 m with a test antenna and EMI spectrum analyzer. 2. During the tests, the antenna height and the EUT azimuth were varied in order to identify the maximum level of emissions from the EUT. This maximization process was repeated with the EUT positioned in each of its three orthogonal orientations. 3. The frequency range up to tenth harmonic was investigated for each of three fundamental frequency (low, middle and high channels). Once spurious emission was identified, the power of the emission was determined using the substitution method. 4. The spurious emissions attenuation was calculated as the difference between radiated power at the fundamental frequency and the spurious emissions frequency. $\text{ERP / EIRP} = \text{S.G. output (dBm)} + \text{Antenna Gain(dB/dBi)} - \text{Cable Loss (dB)}$
<p>Test Instruments:</p>	<p>Refer to section 5.8 for details</p>
<p>Test mode:</p>	<p>Refer to section 5.3 for details</p>
<p>Test results:</p>	<p>Passed</p>

Measurement Data

Test mode:	GSM850		Test channel:	Lowest
Frequency (MHz)	Spurious Emission		Limit (dBm)	Result
	Polarization	Level (dBm)		
1648.40	Vertical	-33.52	-13.00	Pass
2472.60	V	-29.66		
3296.80	V	-40.55		
4121.00	V	-45.04		
4945.20	V	---		
5769.40	V	---		
1648.40	Horizontal	-35.08	-13.00	Pass
2472.60	H	-31.10		
3296.80	H	-42.10		
4121.00	H	-46.70		
4945.20	H	---		
5769.40	H	---		
Test mode:	GSM850		Test channel:	Middle
Frequency (MHz)	Spurious Emission		Limit (dBm)	Result
	Polarization	Level (dBm)		
1673.20	Vertical	-34.25	-13.00	Pass
2509.80	V	-30.93		
3346.40	V	-42.58		
4183.00	V	-40.69		
5019.60	V	---		
5856.20	V	---		
1673.20	Horizontal	-35.81	-13.00	Pass
2509.80	H	-32.41		
3346.40	H	-44.11		
4183.00	H	-42.25		
5019.60	H	---		
5856.20	H	---		

Remark :

1. The emission behaviour belongs to narrowband spurious emission.
2. Remark"---" means that the emission level is too low to be measured
3. The emission levels of other frequencies are very lower than the limit and not show in test report.

Test mode:	GSM850		Test channel:	Highest
Frequency (MHz)	Spurious Emission		Limit (dBm)	Result
	Polarization	Level (dBm)		
1697.60	Vertical	-30.72	-13.00	Pass
2546.40	V	-29.34		
3395.20	V	-36.14		
4244.00	V	-41.76		
5092.80	V	---		
5941.60	V	---		
1697.60	Horizontal	-32.28	-13.00	Pass
2546.40	H	-30.69		
3395.20	H	-37.63		
4244.00	H	-43.28		
5092.80	H	---		
5941.60	H	---		
Test mode:	PCS1900		Test channel:	Lowest
Frequency (MHz)	Spurious Emission		Limit (dBm)	Result
	Polarization	Level (dBm)		
3700.40	Vertical	-21.45	-13.00	Pass
5550.60	V	-31.07		
7400.80	V	-33.71		
9251.00	V	-32.80		
11101.20	V	---		
12951.40	V	---		
3700.40	Horizontal	-23.62	-13.00	Pass
5550.60	H	-33.41		
7400.80	H	-35.89		
9251.00	H	-35.24		
11101.20	H	---		
12951.40	H	---		

Remark :

1. The emission behaviour belongs to narrowband spurious emission.
2. Remark"---" means that the emission level is too low to be measured
3. The emission levels of other frequencies are very lower than the limit and not show in test report.

Test mode:	PCS1900		Test channel:	Middle
Frequency (MHz)	Spurious Emission		Limit (dBm)	Result
	Polarization	Level (dBm)		
3760.00	Vertical	-21.59	-13.00	Pass
5640.00	V	-30.41		
7520.00	V	-36.55		
9400.00	V	-33.26		
11280.00	V	---		
13160.00	V	---		
3760.00	Horizontal	-23.01	-13.00	Pass
5640.00	H	-32.60		
7520.00	H	-38.25		
9400.00	H	-35.32		
11280.00	H	---		
13160.00	H	---		
Test mode:	PCS1900		Test channel:	Highest
Frequency (MHz)	Spurious Emission		Limit (dBm)	Result
	Polarization	Level (dBm)		
3819.60	Vertical	-22.76	-13.00	Pass
5729.40	V	-29.06		
7639.20	V	-38.10		
9549.00	V	-30.96		
11458.80	V	---		
13368.60	V	---		
3819.60	Horizontal	-25.14	-13.00	Pass
5729.40	H	-31.14		
7639.20	H	-40.76		
9549.00	H	-33.18		
11458.80	H	---		
13368.60	H	---		

Remark :

1. The emission behaviour belongs to narrowband spurious emission.
2. Remark"---" means that the emission level is too low to be measured
3. The emission levels of other frequencies are very lower than the limit and not show in test report.

6.12 Frequency stability V.S. Temperature measurement

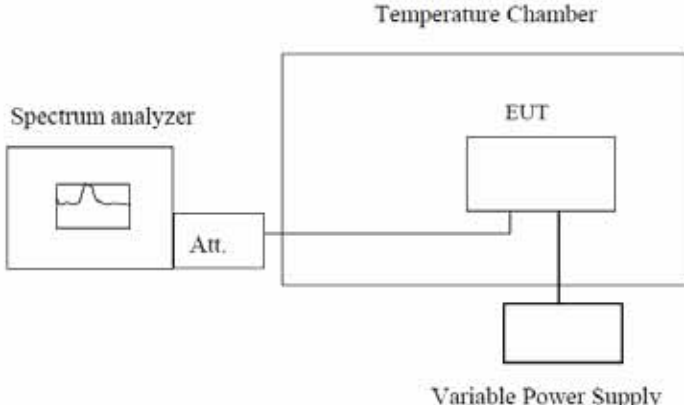
Test Requirement:	FCC Part2.1055(a)(1)(b)
Test Method:	FCC Part2.1055(a)(1)(b)
Limit:	2.5ppm
Test setup:	 <p>Note : Measurement setup for testing on Antenna connector</p>
Test procedure:	<ol style="list-style-type: none"> 1. The equipment under test was connected to an external DC power supply and input rated voltage. 2. RF output was connected to a frequency counter or spectrum analyzer via feed through attenuators. 3. The EUT was placed inside the temperature chamber. 4. Set the spectrum analyzer RBW low enough to obtain the desired frequency resolution and measure EUT 25 operating frequency as reference frequency. 5. Turn EUT off and set the chamber temperature to -30 . After the temperature stabilized for approximately 30 minutes recorded the frequency. 6. Repeat step measure with 10 increased per stage until the highest temperature of $+50$ reached.
Test Instruments:	Refer to section 5.8 for details
Test mode:	Refer to section 5.3 for details
Test results:	Passed

Measurement Data

Reference Frequency: GSM850 Middle channel=190 channel=836.6MHz					
Power supplied (Vdc)	Temperature ()	Frequency error		Limit (ppm)	Result
		Hz	ppm		
3.70	-30	40	0.0478	2.5	Pass
	-20	41	0.0490		
	-10	39	0.0466		
	0	33	0.0394		
	10	32	0.0383		
	20	29	0.0347		
	30	36	0.0430		
	40	37	0.0442		
	50	38	0.0454		
Reference Frequency: PCS1900 Middle channel=661 channel=1880MHz					
Power supplied (Vdc)	Temperature ()	Frequency error		Limit (ppm)	Result
		Hz	ppm		
3.70	-30	45	0.0239	2.5	Pass
	-20	48	0.0255		
	-10	46	0.0245		
	0	45	0.0239		
	10	41	0.0218		
	20	43	0.0229		
	30	44	0.0234		
	40	47	0.0250		
	50	42	0.0223		

6.13 Frequency stability V.S. Voltage measurement

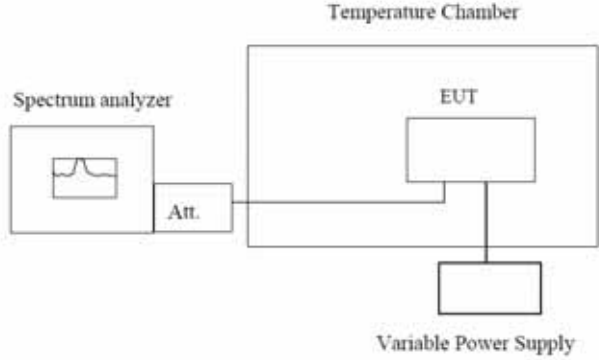
Test Requirement:	FCC Part2.1055(d)(1)(2)
Test Method:	FCC Part2.1055(d)(1)(2)
Limit:	2.5ppm
Test setup:	 <p>Note : Measurement setup for testing on Antenna connector</p>
Test procedure:	<ol style="list-style-type: none"> 1. Set chamber temperature to 25 . Use a variable DC power source to power the EUT and set the voltage to rated voltage. 2. Set the spectrum analyzer RBW low enough to obtain the desired frequency resolution and recorded the frequency. 3. Reduce the input voltage to specified extreme voltage variation (+/- 15%) and endpoint, record the maximum frequency change.
Test Instruments:	Refer to section 5.8 for details
Test mode:	Refer to section 5.3 for details
Test results:	Passed

Measurement Data

Reference Frequency: GSM850 Middle channel=190 channel=836.6MHz					
Temperature ()	Power supplied (Vdc)	Frequency error		Limit (ppm)	Result
		Hz	ppm		
25	4.25	24	0.0287	2.5	Pass
	3.70	29	0.0347		
	3.40	32	0.0383		
Reference Frequency: PCS1900 Middle channel=661 channel=1880MHz					
Temperature ()	Power supplied (Vdc)	Frequency error		Limit (ppm)	Result
		Hz	ppm		
25	4.25	38	0.0202	2.5	Pass
	3.70	43	0.0229		
	3.40	40	0.0213		