

FCC TEST REPORT	
FCC Part 22 /Part 24	
Report Reference No.:	LCS180515028AEA
FCC ID:	ZSHR7720
Date of Issue:	June 25, 2018
Testing Laboratory Name	Shenzhen LCS Compliance Testing Laboratory Ltd.
Address	1/F., Xingyuan Industrial Park, Tongda Road, Bao'an Avenue, Bao'an District, Shenzhen, Guangdong, China
Applicant's name:	SHENZHEN KENXINDA TECHNOLOGY CO.,LTD
Address	18TH FLOOR,FUCHUN ORIENT BUILDING,SHENNAN AV 7006,SHENZHEN,CHINA
Test specification	
Standard	FCC Part 22: Public Mobile Services
	FCC Part 24: Personal Communication Services
Test Report Form No	LCSEMC-1.0
TRF Originator.....:	Shenzhen LCS Compliance Testing Laboratory Ltd.
Master TRF.....:	Dated 2011-03
Shenzhen LCS Compliance Testing Laboratory Ltd. All rights reserved.	
This publication may be reproduced in whole or in part for non-commercial purposes as long as the Shenzhen LCS Compliance Testing Laboratory Ltd. is acknowledged as copyright owner and source of the material. Shenzhen LCS Compliance Testing Laboratory Ltd. takes no responsibility for and will not assume liability for damages resulting from the reader's interpretation of the reproduced material due to its placement and context.	
Test item description	Feature phone
Trade Mark	KENXINDA (Ken mobile)
Model/Type reference.....:	R7720
Listed Models	R7720, R7710
Ratings	DC 3.7V by Rechargeable Li-ion Battery(2500mAh)
	Maximum Charging Voltage: DC 4.2V
Hardware version	K7730CA-2B
Software version	V1.07
Frequency.....:	GSM 850MHz; PCS 1900MHz;
Result.....:	PASS

Compiled by:

Supervised by:

Approved by:

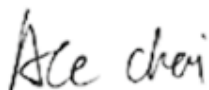

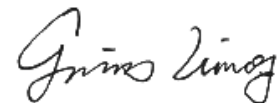

Ace Chai/ Administrators

Dick Su/ Technique principal

Gavin Liang/ Manager

TEST REPORT

Test Report No. :	LCS180515028AEA	June 25, 2018
		Date of issue

Equipment under Test : Feature phone

Model /Type : R7720

Listed Models : R7720, R7710

Model Declaration : PCB board, structure and internal of these model(s) are the same,
So no additional models were tested.

Applicant : **SHENZHEN KENXINDA TECHNOLOGY CO.,LTD**

Address : 18TH FLOOR,FUCHUN ORIENT BUILDING,SHENNAN AV
7006,SHENZHEN,CHINA

Manufacturer : **SHENZHEN KENXINDA TECHNOLOGY CO.,LTD**

Address : 18TH FLOOR,FUCHUN ORIENT BUILDING,SHENNAN AV
7006,SHENZHEN,CHINA

Factory : **SHENZHEN KENXINDA TECHNOLOGY CO.,LTD**

Address : No.8 Building, Shiao Second Industrial Zone, Dalang Clothing
Base, Longhua New District, Shenzhen, China

Test Result:	PASS
---------------------	-------------

The test report merely corresponds to the test sample.
It is not permitted to copy extracts of these test result without the written permission of the test laboratory.

Revision History

Revision	Issue Date	Revisions	Revised By
000	June 01, 2018	Initial Issue	Gavin Liang
001	June 25, 2018	Add model number	Gavin Liang

Contents

<u>1</u>	<u>TEST STANDARDS</u>	<u>5</u>
<u>2</u>	<u>SUMMARY</u>	<u>6</u>
2.1	General Remarks	6
2.2	Product Description	6
2.3	Equipment under Test	6
2.4	Short description of the Equipment under Test (EUT)	7
2.5	Internal Identification of AE used during the test	7
2.6	Normal Accessory setting	7
2.7	EUT configuration	7
2.8	Related Submittal(s) / Grant (s)	8
2.9	Modifications	8
2.10	General Test Conditions/Configurations	8
<u>3</u>	<u>TEST ENVIRONMENT</u>	<u>9</u>
3.1	Address of the test laboratory	9
3.2	Test Facility	9
3.3	Environmental conditions	9
3.4	Test Description	9
3.5	Equipments Used during the Test	11
3.6	Measurement uncertainty	12
<u>4</u>	<u>TEST CONDITIONS AND RESULTS</u>	<u>13</u>
4.1	Output Power	13
4.2	Radiated Spurious Emission	16
4.3	Occupied Bandwidth and Emission Bandwidth	19
4.4	Band Edge Compliance	21
4.5	Spurious Emission on Antenna Port	23
4.6	Frequency Stability Test	28
4.7	Peak-to-Average Ratio (PAR)	30
<u>5</u>	<u>TEST SETUP PHOTOS OF THE EUT</u>	<u>31</u>
<u>6</u>	<u>EXTERNAL PHOTOS OF THE EUT</u>	<u>31</u>
<u>7</u>	<u>INTERNAL PHOTOS OF THE EUT</u>	<u>31</u>

1 TEST STANDARDS

The tests were performed according to following standards:

[FCC Part 22 \(10-1-16 Edition\)](#): Private Land Mobile Radio Services.

[FCC Part 24\(10-1-16 Edition\)](#): Public Mobile Services.

[ANSI/TIA-603-E-2016](#): Land Mobile FM or PM Communications Equipment Measurement and Performance Standards.

[971168 D01 Power Meas License Digital Systems v03](#) : Measurement Guidance For Certification of Licensed Digital Transmitters

[FCC Part 2](#): Frequency Allocations And Radio Treaty Matters: General Rules And Regulations.

[ANSI C63.26:2015](#): American National Standard for Compliance Testing of Transmitters Used in Licensed Radio Services.

2 SUMMARY

2.1 General Remarks

Date of receipt of test sample	:	May 17, 2018
Testing commenced on	:	May 17, 2018
Testing concluded on	:	June 01, 2018

2.2 Product Description

The **Shenzhen kenxinda Technology Co.,Ltd**'s Model: R7720 or the "EUT" as referred to in this report; more general information as follows, for more details, refer to the user's manual of the EUT.

Name of EUT	Feature phone
Model Number	R7720
Modulation Type	GMSK for GSM/GPRS
Hardware version	K7730CA-2B
Software version	V1.07
Operation Frequency Band	GSM850/PCS1900/GPRS850/GPRS1900
GSM/EDGE/GPRS	Supported GSM /GPRS
GSM Release Version	R99
GSM/EDGE/GPRS Power Class	GSM850:Power Class 4/ PCS1900:Power Class 1
GPRS/EDGE Multislot Class	GPRS: Multi-slot Class 12
GPRS operation mode	Class B
Antenna Type	Internal Antenna
Antenna Gain	0.6dBi(max.) For GSM 850, 0.8dBi(max.) For GSM 1900
Extreme temp. Tolerance	-25°C to +75°C
Extreme vol. Limits	3.33VDC to 4.07VDC (Normal: 3.7VDC)
Bluetooth	
Bluetooth Operation frequency	2402MHz-2480MHz
Bluetooth Version	2.1+EDR
Bluetooth Channel Number	79 Channels
Bluetooth Channel Spacing	1 MHz
Antenna Description	Internal Antenna, 1.0dB
FM Function	Support and only RX
Frequency Rang	88~108MHz
Modulation Type	FM
Antenna Description	External Antenna(earphone)

2.3 Equipment under Test

Power supply system utilised

Power supply voltage	:	<input type="radio"/> 120V / 60 Hz	<input type="radio"/> 115V / 60Hz
		<input type="radio"/> 12 V DC	<input type="radio"/> 24 V DC
		<input checked="" type="radio"/> 3.7 V DC	
		<input type="radio"/> Other (specified in blank below)	

Test frequency list

Test Mode	TX/RX	RF Channel		
		Low(L)	Middle (M)	High (H)
GSM850	TX	Channel 128	Channel 190	Channel 251
		824.2 MHz	836.6 MHz	848.8 MHz
	RX	Channel 128	Channel 190	Channel 251
		869.2 MHz	881.6 MHz	893.8 MHz
Test Mode	TX/RX	RF Channel		
		Low(L)	Middle (M)	High (H)
GSM1900	TX	Channel 512	Channel 661	Channel 810
		1850.2 MHz	1880.0 MHz	1909.8 MHz
	RX	Channel 512	Channel 661	Channel 810
		1930.2 MHz	1960.0 MHz	1989.8 MHz

2.4 Short description of the Equipment under Test (EUT)

2.4.1 General Description

Assist monitoring system Sekurlt is subscriber equipment in the GSM system. The GSM/GPRS frequency band includes GSM850 and GSM900 and DCS1800 and PCS1900, but only GSM850 and PCS1900 bands test data included in this report. The Wireless Door Intercom implements such functions as RF signal receiving/transmitting, GSM/GPRS protocol processing, positioning service and etc. Externally it provides SIM card interface.

NOTE: Unless otherwise noted in the report, the functional boards installed in the units shall be selected from the below list, but not means all the functional boards listed below shall be installed in one unit.

2.5 Internal Identification of AE used during the test

AE ID*	Description
AE1	Li-ion Battery

AE1
DC 3.7V by Rechargeable Li-ion Battery(1000mAh)

*AE ID: is used to identify the test sample in the lab internally.

2.6 Normal Accessory setting

AC/DC Adapter was used during the test.

2.7 EUT configuration

The following peripheral devices and interface cables were connected during the measurement:

● - supplied by the manufacturer

○ - supplied by the lab

<input type="radio"/>	Power Cable	Length (m) :	/
<input type="radio"/>		Shield :	/
<input type="radio"/>		Detachable :	/
<input type="radio"/>	Multimeter	Manufacturer :	/
<input type="radio"/>		Model No. :	/

2.8 Related Submittal(s) / Grant (s)

This submittal(s) (test report) is intended for **FCC ID: ZSHR7720** filing to comply with FCC Part 22 and Part 24 Rules.

2.9 Modifications

No modifications were implemented to meet testing criteria.

2.10 General Test Conditions/Configurations

2.10.1 Test Modes

NOTE: The test mode(s) are selected according to relevant radio technology specifications.

Test Mode	Test Modes Description
GSM/TM1	GSM system, GPRS, GMSK modulation
GSM/TM2	GSM system, GPRS, GMSK modulation

Note:

- As GSM and GPRS with the same emission designator, test result recorded in this report at the worst case GSM/TM1 only after exploratory scan.

2.10.2 Test Environment

Environment Parameter	Selected Values During Tests	
Relative Humidity	Ambient	
Temperature	TN	Ambient
Voltage	VL	3.33V
	VN	3.70V
	VH	4.07V

NOTE: VL=lower extreme test voltage VN=nominal voltage
VH=upper extreme test voltage TN=normal temperature

3 TEST ENVIRONMENT

3.1 Address of the test laboratory

Shenzhen LCS Compliance Testing Laboratory Ltd

1/F., Xingyuan Industrial Park, Tongda Road, Bao'an Avenue, Bao'an District, Shenzhen, Guangdong, China

The sites are constructed in conformance with the requirements of ANSI C63.4 (2014) and CISPR Publication 22.

3.2 Test Facility

The test facility is recognized, certified, or accredited by the following organizations:

FCC Registration Number. is 254912.

Industry Canada Registration Number. is 9642A-1.

ESMD Registration Number. is ARCB0108.

UL Registration Number. is 100571-492.

TUV SUD Registration Number. is SCN1081.

TUV RH Registration Number. is UA 50296516-001

NVLAP Registration Code is 600167-0

3.3 Environmental conditions

During the measurement the environmental conditions were within the listed ranges:

Temperature:	15-35 ° C
Humidity:	30-60 %
Atmospheric pressure:	950-1050mbar

3.4 Test Description

3.4.1 Cellular Band (824-849MHz paired with 869-894MHz)

Test Item	FCC Rule No.	Requirements	Verdict
Effective(Isotropic) Radiated Output Power	§2.1046, §22.913	FCC: ERP ≤ 7W. ISED: ERP ≤ 11.5W.	Pass
Modulation Characteristics	§2.1047	Digital modulation	N/A
Bandwidth	§2.1049	OBW: No limit. EBW: No limit.	Pass
Band Edges Compliance	§2.1051, §22.917	≤-13dBm/1%*EBW, in 1MHz bands immediately outside and adjacent to The frequency block.	Pass
Spurious Emission at Antenna Terminals	§2.1051, §22.917	≤ -13dBm/100kHz, from 9kHz to 10th harmonics but outside authorized operating frequency ranges.	Pass
Field Strength of Spurious Radiation	§2.1053, §22.917	≤ -13dBm/100kHz.	Pass
Frequency Stability	§2.1055, §22.355	≤ ±2.5ppm.	Pass
Peak-Average Ratio	N/A	IC:Limit≤13dB	Pass
Receiver Spurious Emissions	N/A	--	Pass

NOTE 1: For the verdict, the "N/A" denotes "not applicable", the "N/T" de notes "not tested".

3.4.2 PCS Band (1850-1915MHz paired with 1930-1995MHz)

Test Item	FCC Rule No.	Requirements	Verdict
Effective(Isotropic) Radiated Output Power	§2.1046, §24.232	EIRP ≤ 2W	Pass
Peak-Average Ratio	§2.1046, §24.232	≤13dB	Pass
Modulation Characteristics	§2.1047	Digital modulation	N/A
Bandwidth	§2.1049	OBW: No limit. EBW: No limit.	Pass
Band Edges Compliance	§2.1051, §24.238	≤ -13dBm/1%*EBW, In 1MHz bands immediately outside and adjacent to The frequency block.	Pass
Spurious Emission at Antenna Terminals	§2.1051, §24.238	≤-13dBm/1MHz, from 9kHz to 10th harmonics but outside authorized Operating frequency ranges.	Pass
Field Strength of Spurious Radiation	§2.1053, §24.238	≤ -13dBm/1MHz.	Pass
Frequency Stability	§2.1055, §24.235	≤ ±2.5ppm.	Pass
Receiver Spurious Emissions	N/A	--	Pass

NOTE 1: For the verdict, the "N/A" denotes "not applicable", the "N/T" denotes "not tested".

Remark: 1. The measurement uncertainty is not included in the test result.

3.5 Equipments Used during the Test

Item	Equipment	Manufacturer	Model No.	Serial No.	Cal Date	Due Date
1	Power Meter	R&S	NRVS	100444	2017-06-17	2018-06-16
2	Power Sensor	R&S	NRV-Z81	100458	2017-06-17	2018-06-16
3	Power Sensor	R&S	NRV-Z32	10057	2017-06-17	2018-06-16
4	X-series USB Peak and Average Power Sensor Agilent	Agilent	U2021XA	MY54080022	2017-10-26	2018-10-25
5	4 CH. Simultaneous Sampling 14 Bits 2MS/s	Agilent	U2531A	MY54080016	2017-10-26	2018-10-25
6	Test Software	Ascentest	AT890-SW	20160630	N/A	N/A
7	RF Control Unit	Ascentest	AT890-RFB	N/A	2017-06-17	2018-06-16
8	ESA-E SERIES SPECTRUM ANALYZER	Agilent	E4407B	MY41440754	2017-11-17	2018-11-16
9	MXA Signal Analyzer	Agilent	N9020A	MY49100040	2017-06-17	2018-06-16
10	SPECTRUM ANALYZER	R&S	FSP	100503	2017-06-17	2018-06-16
11	MXG Vector Signal Generator	Agilent	N5182A	MY47071151	2017-11-17	2018-11-16
12	ESG VECTOR SIGNAL GENERATOR	Agilent	E4438C	MY42081396	2017-11-17	2018-11-16
13	PSG Analog Signal Generator	Agilent	E8257D	MY4520521	2017-11-17	2018-11-16
14	Universal Radio Communication Tester	R&S	CMU 200	105788	2017-06-17	2018-06-16
15	WIDEBAND RADIO COMMUNICATION TESTER	R&S	CMW 500	103818	2017-06-17	2018-06-16
16	RF Control Unit	Tonscend	JS0806-1	N/A	2017-06-17	2018-06-16
17	DC Power Supply	Agilent	E3642A	N/A	2017-11-17	2018-11-16
18	LTE Test Software	Tonscend	JS1120-1	N/A	N/A	N/A
19	Temperature & Humidity Chamber	GUANGZHOU GOGNWEN	GDS-100	70932	2017-10-11	2018-10-10
20	DC Source	CHROMA	62012P-80-60	34782951	2017-10-11	2018-10-10
21	RF Filter	Micro-Tronics	BRC50718	S/N-017	2017-06-17	2018-06-16
22	RF Filter	Micro-Tronics	BRC50719	S/N-011	2017-06-17	2018-06-16
23	RF Filter	Micro-Tronics	BRC50720	S/N-011	2017-06-17	2018-06-16
24	RF Filter	Micro-Tronics	BRC50721	S/N-013	2017-06-17	2018-06-16
25	RF Filter	Micro-Tronics	BRM50702	S/N-195	2017-06-17	2018-06-16
26	Splitter/Combiner	Micro-Tronics	PS2-15	CB11-20	2017-06-17	2018-06-16
27	Splitter/Combiner	Micro-Tronics	CB11-20	N/A	2017-06-17	2018-06-16
28	Attenuator	Micro-Tronics	PAS-8-10	S/N23466	2017-06-17	2018-06-16
29	Exposure Level Tester	Narda	ELT-400	N-0713	2018-04-03	2019-04-02
30	B-Field Probe	Narda	ELT-400	M-1154	2018-04-11	2019-04-10
31	3m Semi Anechoic Chamber	SIDT FRANKONIA	SAC-3M	03CH03-HY	2017-06-17	2018-06-16
32	Positioning Controller	MF	MF-7082	/	2017-06-17	2018-06-16
33	EMI Test Software	AUDIX	E3	N/A	2017-06-17	2018-06-16
34	EMI Test Receiver	R&S	ESR 7	101181	2017-06-17	2018-06-16
35	AMPLIFIER	QuieTek	QTK-A2525G	CHM10809065	2017-11-17	2018-11-16
36	Active Loop Antenna	SCHWARZBECK	FMZB 1519B	00005	2017-06-23	2018-06-22
37	By-log Antenna	SCHWARZBECK	VULB9163	9163-470	2018-05-02	2019-05-01
38	Horn Antenna	EMCO	3115	6741	2017-06-23	2018-06-22
39	Broadband Horn Antenna	SCHWARZBECK	BBHA 9170	791	2017-09-21	2018-09-20
40	Broadband Preamplifier	SCHWARZBECK	BBV 9719	9719-025	2017-09-21	2018-09-20
41	RF Cable-R03m	Jye Bao	RG142	CB021	2017-06-17	2018-06-16
42	RF Cable-HIGH	SUHNER	SUCOFLEX 106	03CH03-HY	2017-06-17	2018-06-16

Note: All equipment is calibrated through GUANGZHOU LISAI CALIBRATION AND TEST CO.,LTD.

3.6 Measurement uncertainty

The data and results referenced in this document are true and accurate. The reader is cautioned that there may be errors within the calibration limits of the equipment and facilities. The measurement uncertainty was calculated for all measurements listed in this test report acc. to ETSI TR 100 028 “ Electromagnetic compatibility and Radio spectrum Matters (ERM); Uncertainties in the measurement of mobile radio equipment characteristics” and is documented in the Shenzhen LCS Compliance Testing Laboratory Ltd. quality system acc. to DIN EN ISO/IEC 17025. Furthermore, component and process variability of devices similar to that tested may result in additional deviation. The manufacturer has the sole responsibility of continued compliance of the device.

Hereafter the best measurement capability for Shenzhen LCS Compliance Testing Laboratory Ltd. is reported:

Test	Range	Measurement Uncertainty	Notes
Radiated Emission	30~1000MHz	3.10 dB	(1)
Radiated Emission	1~18GHz	3.70 dB	(1)
Radiated Emission	18-40GHz	3.90 dB	(1)
Conducted Disturbance	0.15~30MHz	1.63 dB	(1)
Conducted Power	9KHz~18GHz	0.61 dB	(1)
Spurious RF Conducted Emission	9KHz~40GHz	1.22 dB	(1)
Band Edge Compliance of RF Emission	9KHz~40GHz	1.22 dB	(1)
Occupied Bandwidth	9KHz~40GHz	-	(1)

(1) This uncertainty represents an expanded uncertainty expressed at approximately the 95% confidence level using a coverage factor of k=1.96.

4 TEST CONDITIONS AND RESULTS

4.1 Output Power

TEST APPLICABLE

During the process of testing, the EUT was controlled via R&S Digital Radio Communication tester (CMU200) to ensure max power transmission and proper modulation. This result contains output power and EIRP measurements for the EUT. In all cases, output power is within the specified limits.

4.1.1 Conducted Output Power

TEST CONFIGURATION

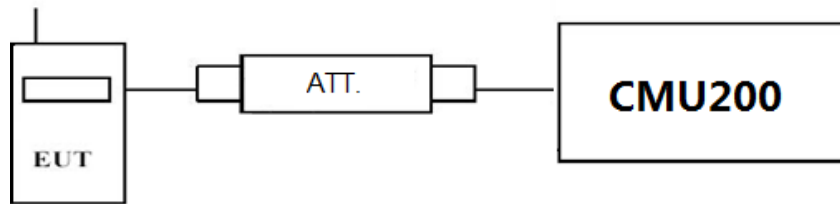

TEST PROCEDURE

Conducted Power Measurement:

- Place the EUT on a bench and set it in transmitting mode.
- Connect a low loss RF cable from the antenna port to a CMU200 by an Att.
- EUT Communicate with CMU200 then selects a channel for testing.
- Add a correction factor to the display CMU200, and then test.

TEST RESULTS

GSM 850		Burst Average Conducted power (dBm)		
		Channel/Frequency(MHz)		
		128/824.2	190/836.6	251/848.8
GSM		29.35	29.50	29.24
GPRS (GMSK)	1TX slot	28.35	28.46	28.19
	2TX slot	27.33	27.49	27.22
	3TX slot	25.25	25.37	25.20
	4TX slot	24.16	24.41	24.26

GSM 1900		Burst Average Conducted power (dBm)		
		Channel/Frequency(MHz)		
		512/1850.2	661/1880	810/1909.8
GSM		27.74	27.73	27.59
GPRS (GMSK)	1TX slot	26.75	26.35	26.64
	2TX slot	25.64	25.53	25.75
	3TX slot	24.31	24.69	24.08
	4TX slot	23.23	23.66	23.02

4.1.2 Radiated Output Power

TEST DESCRIPTION

This is the test for the maximum radiated power from the EUT.

Per rule Part 24.232(c) specifies, "Mobile/portable stations are limited to 2 watts e.i.r.p. Peak power" and 24.232(e) specifies that "Peak transmit power must be measured over any interval of continuous transmission using instrumentation calibrated in terms of an rms-equivalent voltage."

Per rule Part 22.913(a) specifies "The ERP of mobile transmitters and auxiliary test transmitters must not exceed 7 Watts."

TEST CONFIGURATION

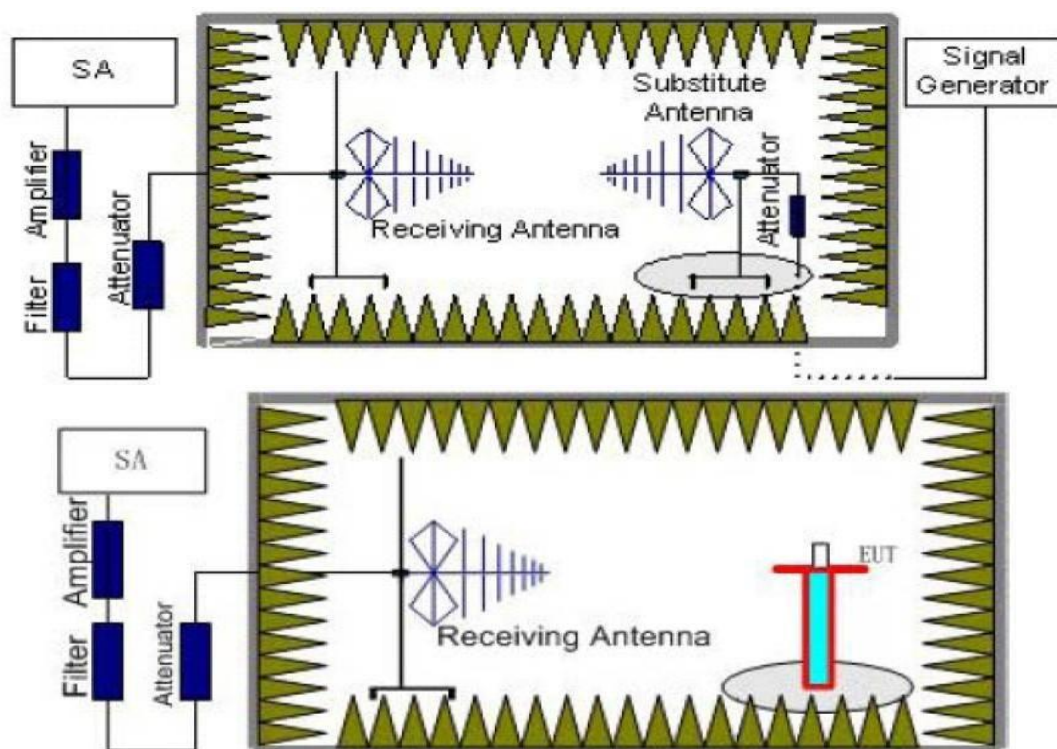

TEST PROCEDURE

1. EUT was placed on a 1.50 meter high non-conductive stand at a 3 meter test distance from the receive antenna. A receiving antenna was placed on the antenna mast 3 meters from the EUT for emission measurements. The height of receiving antenna is 1.50 m. Detected emissions were maximized at each frequency by rotating the EUT through 360° and adjusting the receiving antenna polarization. The radiated emission measurements of all transmit frequencies in three channels (High, Middle, Low) were measured with peak detector.
2. A log-periodic antenna or double-ridged waveguide horn antenna shall be substituted in place of the EUT. The log-periodic antenna will be driven by a signal generator and the level will be adjusted till the same power value on the spectrum analyzer or receiver. The level of the spurious emissions can be calculated through the level of the signal generator, cable loss, the gain of the substitution antenna and the reading of the spectrum analyzer or receiver.
3. The EUT is then put into continuously transmitting mode at its maximum power level during the test. Set Test Receiver or Spectrum RBW=1MHz, VBW=3MHz, And the maximum value of the receiver should be recorded as (P_r).
4. The EUT shall be replaced by a substitution antenna. In the chamber, an substitution antenna for the frequency band of interest is placed at the reference point of the chamber. An RF Signal source for the frequency band of interest is connected to the substitution antenna with a cable that has been constructed to not interfere with the radiation pattern of the antenna. A power (P_{Mea}) is applied to the input of the substitution antenna, and adjust the level of the signal generator output until the value of the receiver reach the previously recorded (P_r). The power of signal source (P_{Mea}) is recorded. The test should be performed by rotating the test item and adjusting the receiving antenna polarization.

5. A amplifier should be connected to the Signal Source output port. And the cable should be connect between the Amplifier and the Substitution Antenna. The cable loss (P_{cl}), the Substitution Antenna Gain (G_a) and the Amplifier Gain (P_{Ag}) should be recorded after test.
The measurement results are obtained as described below:
 $Power(EIRP)=P_{Mea} + P_{Ag} - P_{cl} + G_a$
6. This value is EIRP since the measurement is calibrated using an antenna of known gain (2.15 dBi) and known input power.
7. ERP can be calculated from EIRP by subtracting the gain of the dipole, $ERP = EIRP - 2.15dBi$.

TEST LIMIT

According to 22.913(a), 24.232(c) , the ERP should be not exceed following table limits:

GSM850(GPRS850,EDGE850)		
Function	Power Step	Burst Peak ERP (dBm)
GSM	5	FCC: $\leq 38.45dBm$ (7W)
GPRS	3	FCC: $\leq 38.45dBm$ (7W)

PCS1900(GPRS1900,EDGE1900)		
Function	Power Step	Burst Peak EIRP (dBm)
GSM	0	$\leq 33.01dBm$ (2W)
GPRS	2	$\leq 33.01dBm$ (2W)

TEST RESULTS

Remark:

- We were tested all Configuration refer 3GPP TS151 010.
- $EIRP = P_{Mea}(dBm) - P_{cl}(dB) + P_{Ag}(dB) + G_a(dBi)$
- $ERP = EIRP - 2.15dBi$ as EIRP by subtracting the gain of the dipole.
- Margin = Emission Level - Limit
- We test the H direction and V direction recorded worst case.

GSM/TM1/GSM850

Frequency (MHz)	P_{Mea} (dBm)	P_{cl} (dB)	G_a Antenna Gain(dB)	Correction (dB)	P_{Ag} (dB)	Burst Average ERP (dBm)	Limit (dBm)	Margin (dB)	Polarization
824.2	-6.96	3.45	8.45	2.15	33.79	29.68	38.45	-8.77	V
836.6	-6.97	3.49	8.45	2.15	33.85	29.69	38.45	-8.76	V
848.8	-6.95	3.55	8.36	2.15	33.88	29.59	38.45	-8.86	V

GSM/TM1/GSM1900

Frequency (MHz)	P_{Mea} (dBm)	P_{cl} (dB)	G_a Antenna Gain(dB)	P_{Ag} (dB)	Burst Average EIRP (dBm)	Limit (dBm)	Margin (dB)	Polarization
1850.2	-12.04	4.03	8.38	35.51	27.82	33.01	-5.19	V
1880	-12.01	4.08	8.33	35.56	27.80	33.01	-5.21	V
1909.8	-11.94	4.14	8.26	35.63	27.81	33.01	-5.20	V

4.2 Radiated Spurious Emission

TEST APPLICABLE

According to the TIA/EIA 603D:2010 and FCC Part 2.1033 test method, The Receiver or Spectrum was scanned from lowest frequency frequency generated within the equipment to the 10th harmonic of the highest frequency generated within the equipment, which is the transmitted carrier that can be as high as 1910 MHz. The resolution bandwidth is set as outlined in Part 24.238, Part 22.917, RSS-132 §5.5 and RSS-133 §6.5. The spectrum is scanned with the mobile station transmitting at carrier frequencies that pertain to low, mid and high channels of PCS1900 and GSM850.

TEST CONFIGURATION

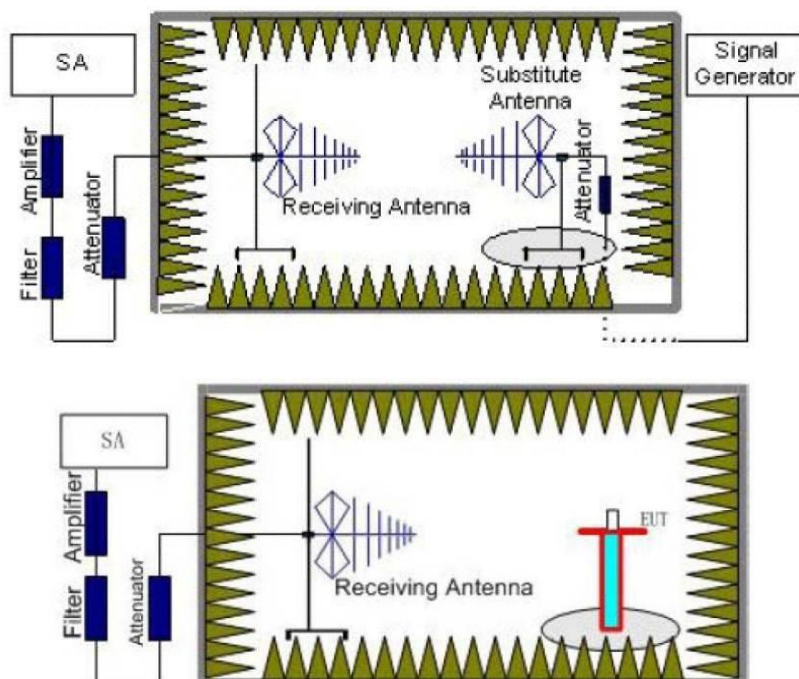

TEST PROCEDURE

1. EUT was placed on a 1.50 meter high non-conductive stand at a 3 meter test distance from the receive antenna. A receiving antenna was placed on the antenna mast 3 meters from the EUT for emission measurements. The height of receiving antenna is 1.50 m. Detected emissions were maximized at each frequency by rotating the EUT through 360° and adjusting the receiving antenna polarization. The radiated emission measurements of all transmit frequencies in three channels (High, Middle, Low) were measured with peak detector.
2. A log-periodic antenna or double-ridged waveguide horn antenna shall be substituted in place of the EUT. The log-periodic antenna will be driven by a signal generator and the level will be adjusted till the same power value on the spectrum analyzer or receiver. The level of the spurious emissions can be calculated through the level of the signal generator, cable loss, the gain of the substitution antenna and the reading of the spectrum analyzer or receiver.
3. The EUT is then put into continuously transmitting mode at its maximum power level during the test. Set Test Receiver or Spectrum RBW=1MHz, VBW=3MHz, And the maximum value of the receiver should be recorded as (P_r).
4. The EUT shall be replaced by a substitution antenna. In the chamber, an substitution antenna for the frequency band of interest is placed at the reference point of the chamber. An RF Signal source for the frequency band of interest is connected to the substitution antenna with a cable that has been constructed to not interfere with the radiation pattern of the antenna. A power (P_{Mea}) is applied to the input of the substitution antenna, and adjust the level of the signal generator output until the value of the receiver reach the previously recorded (P_r). The power of signal source (P_{Mea}) is recorded. The test should be performed by rotating the test item and adjusting the receiving antenna polarization.

5. A amplifier should be connected to the Signal Source output port. And the cable should be connect between the Amplifier and the Substitution Antenna. The cable loss (P_{cl}), the Substitution Antenna Gain (G_a) and the Amplifier Gain (P_{Ag}) should be recorded after test.
The measurement results are obtained as described below:
Power(EIRP)= $P_{Mea} + P_{Ag} - P_{cl} + G_a$
6. This value is EIRP since the measurement is calibrated using an antenna of known gain (2.15 dBi) and known input power.
7. ERP can be calculated from EIRP by subtracting the gain of the dipole, ERP = EIRP -2.15dBi.
8. In order to make sure test results more clearly,we set frequency range and sweep time for difference frequency range as follows table:

Working Frequency	Subrange (GHz)	RBW	VBW	Sweep time (s)
TM1/GSM 850	0.00009~0.15	1KHz	3KHz	30
	0.00015~0.03	10KHz	30KHz	10
	0.03~1	100KHz	300KHz	10
	1~2	1 MHz	3 MHz	2
	2~5	1 MHz	3 MHz	3
	5~8	1 MHz	3 MHz	3
	8~10	1 MHz	3 MHz	3
TM1/GSM 1900	0.00009~0.15	1KHz	3KHz	30
	0.00015~0.03	10KHz	30KHz	10
	0.03~1	100KHz	300KHz	10
	1~2	1 MHz	3 MHz	2
	2~5	1 MHz	3 MHz	3
	5~8	1 MHz	3 MHz	3
	8~11	1 MHz	3 MHz	3
	11~14	1 MHz	3 MHz	3
	14~18	1 MHz	3 MHz	3
	18~20	1 MHz	3 MHz	2

TEST LIMITS

According to 24.238 and 22.917 specify that the power of any emission outside of the authorized operating frequency ranges must be attenuated below the transmitting power (P) by a factor of at least $43 + 10 \log(P)$ dB.

The specification that emissions shall be attenuated below the transmitter power (P) by at least $43 + 10 \log(P)$ dB, translates in the relevant power range (1 to 0.001 W) to -13 dBm. At 1 W the specified minimum attenuation becomes 43 dB and relative to a 30 dBm (1 W) carrier becomes a limit of -13 dBm. At 0.001 W (0 dBm) the minimum attenuation is 13 dB, which again yields a limit of -13 dBm. In this way a translation of the specification from relative to absolute terms is carried out.

Frequency	Channel	Frequency Range	Verdict
TM1/GSM 850	Low	9KHz-10GHz	PASS
	Middle	9KHz -10GHz	PASS
	High	9KHz -10GHz	PASS
TM1/GSM 1900	Low	9KHz -20GHz	PASS
	Middle	9KHz -20GHz	PASS
	High	9KHz -20GHz	PASS

TEST RESULTS

Remark:

1. We were tested all refer 3GPP TS151 010.
2. $EIRP = P_{Mea}(dBm) - P_{cl}(dB) + G_a(dBi)$
3. We were not recorded other points as values lower than limits.
4. Margin = EIRP - Limit

GSM/TM1/GSM850_ Low Channel

Frequency (MHz)	P _{Mea} (dBm)	P _{cl} (dB)	Diatance	G _a Antenna Gain(dB)	Peak EIRP (dBm)	Limit (dBm)	Margin (dB)	Polarization
1648.40	-43.67	3.86	3.00	8.56	-38.97	-13.00	-25.97	H
2472.60	-44.03	4.29	3.00	6.98	-41.34	-13.00	-28.34	H
1648.40	-39.98	3.86	3.00	8.56	-35.28	-13.00	-22.28	V
2472.60	-41.70	4.29	3.00	6.98	-39.01	-13.00	-26.01	V

GSM/TM1/ GSM850_ Middle Channel

Frequency (MHz)	P _{Mea} (dBm)	P _{cl} (dB)	Diatance	G _a Antenna Gain(dB)	Peak EIRP (dBm)	Limit (dBm)	Margin (dB)	Polarization
1673.20	-41.50	3.9	3.00	8.58	-36.82	-13.00	-23.82	H
2509.80	-46.37	4.32	3.00	6.8	-43.89	-13.00	-30.89	H
1673.20	-37.80	3.9	3.00	8.58	-33.12	-13.00	-20.12	V
2509.80	-42.90	4.32	3.00	6.8	-40.42	-13.00	-27.42	V

GSM/TM1/ GSM850_ High Channel

Frequency (MHz)	P _{Mea} (dBm)	P _{cl} (dB)	Diatance	G _a Antenna Gain(dB)	Peak EIRP (dBm)	Limit (dBm)	Margin (dB)	Polarization
1697.60	-46.67	3.91	3.00	9.06	-41.52	-13.00	-28.52	H
2546.40	-49.51	4.32	3.00	6.65	-47.18	-13.00	-34.18	H
1697.60	-43.15	3.91	3.00	9.06	-38.00	-13.00	-25.00	V
2546.40	-45.22	4.32	3.00	6.65	-42.89	-13.00	-29.89	V

GSM/TM1/GSM1900_ Low Channel

Frequency (MHz)	P _{Mea} (dBm)	P _{cl} (dB)	Diatance	G _a Antenna Gain(dB)	Peak EIRP (dBm)	Limit (dBm)	Margin (dB)	Polarization
3700.40	-45.32	5.26	3.00	9.88	-40.70	-13.00	-27.70	H
5550.60	-46.28	6.11	3.00	11.36	-41.03	-13.00	-28.03	H
3700.40	-42.07	5.26	3.00	9.88	-37.45	-13.00	-24.45	V
5550.60	-43.71	6.11	3.00	11.36	-38.46	-13.00	-25.46	V

GSM/TM1/ GSM1900_ Middle Channel

Frequency (MHz)	P _{Mea} (dBm)	P _{cl} (dB)	Diatance	G _a Antenna Gain(dB)	Peak EIRP (dBm)	Limit (dBm)	Margin (dB)	Polarization
3760.00	-43.94	5.32	3.00	10.03	-39.23	-13.00	-26.23	H
5640.00	-48.56	6.19	3.00	11.41	-43.34	-13.00	-30.34	H
3760.00	-39.55	5.32	3.00	10.03	-34.84	-13.00	-21.84	V
5640.00	-44.99	6.19	3.00	11.41	-39.77	-13.00	-26.77	V

GSM/TM1/ GSM1900_ High Channel

Frequency (MHz)	P _{Mea} (dBm)	P _{cl} (dB)	Diatance	G _a Antenna Gain(dB)	Peak EIRP (dBm)	Limit (dBm)	Margin (dB)	Polarization
3819.60	-49.08	5.36	3.00	9.62	-44.82	-13.00	-31.82	H
5729.40	-51.11	6.24	3.00	11.46	-45.89	-13.00	-32.89	H
3819.60	-44.89	5.36	3.00	9.62	-40.63	-13.00	-27.63	V
5729.40	-47.09	6.24	3.00	11.46	-41.87	-13.00	-28.87	V

4.3 Occupied Bandwidth and Emission Bandwidth

TEST APPLICABLE

Similar to conducted emissions; occupied bandwidth measurements are only provided for selected frequencies in order to reduce the amount of submitted data. Data were taken at the extreme and mid frequencies of PCS1900 band and GSM850 band. The table below lists the measured 99% Bandwidth and -26dBc Bandwidth.

TEST CONFIGURATION

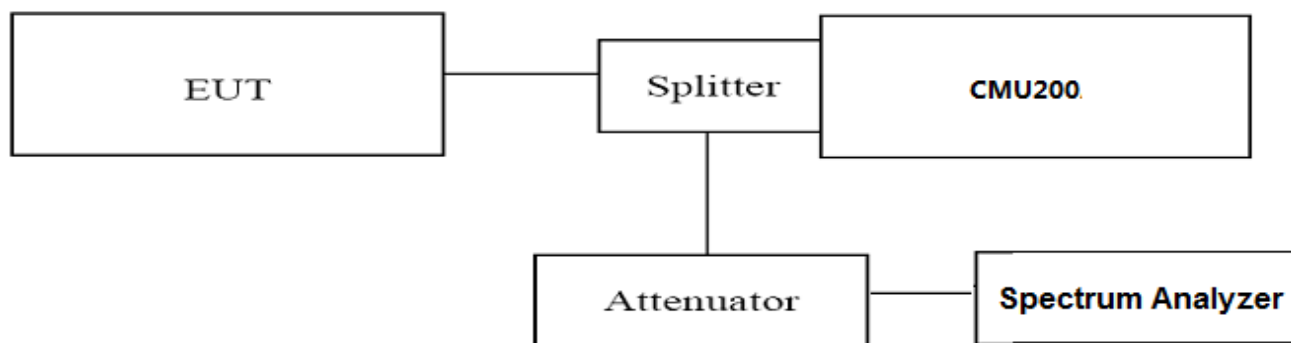

TEST PROCEDURE

1. The EUT was set up for the max output power with pseudo random data modulation;
2. The Occupied bandwidth and Emission Bandwidth were measured with Spectrum Analyzer N9020A;
3. Set RBW=5.1KHz, VBW=51KHz, Span=1MHz, SWT=Auto;
4. Set SPA Max hold and View, Set 99% Occupied Bandwidth/ Set -26dBc Occupied Bandwidth
5. These measurements were done at 3 frequencies, 1850.20 MHz, 1880.00 MHz and 1909.80 MHz for PCS1900 band; 824.20MHz, 836.60 MHz and 848.80 MHz for GSM850 band. (Low, middle and high of operational frequency range).

TEST RESULTS

Test Mode	Channel	Frequency (MHz)	Occupied Bandwidth (99% BW) (KHz)	Emission Bandwidth (-26 dBc BW) (KHz)	Verdict
GSM/TM1/ GSM850	128	824.2	244.8	311	PASS
	190	836.6	246.9	302	PASS
	251	848.8	248.4	314	PASS
GSM/TM1/ GSM1900	512	1850.2	243.7	312	PASS
	661	1880.0	242.5	308	PASS
	810	1908.8	244.7	309	PASS

Remark:

1. Test results including cable loss;
2. Please refer to following plots;

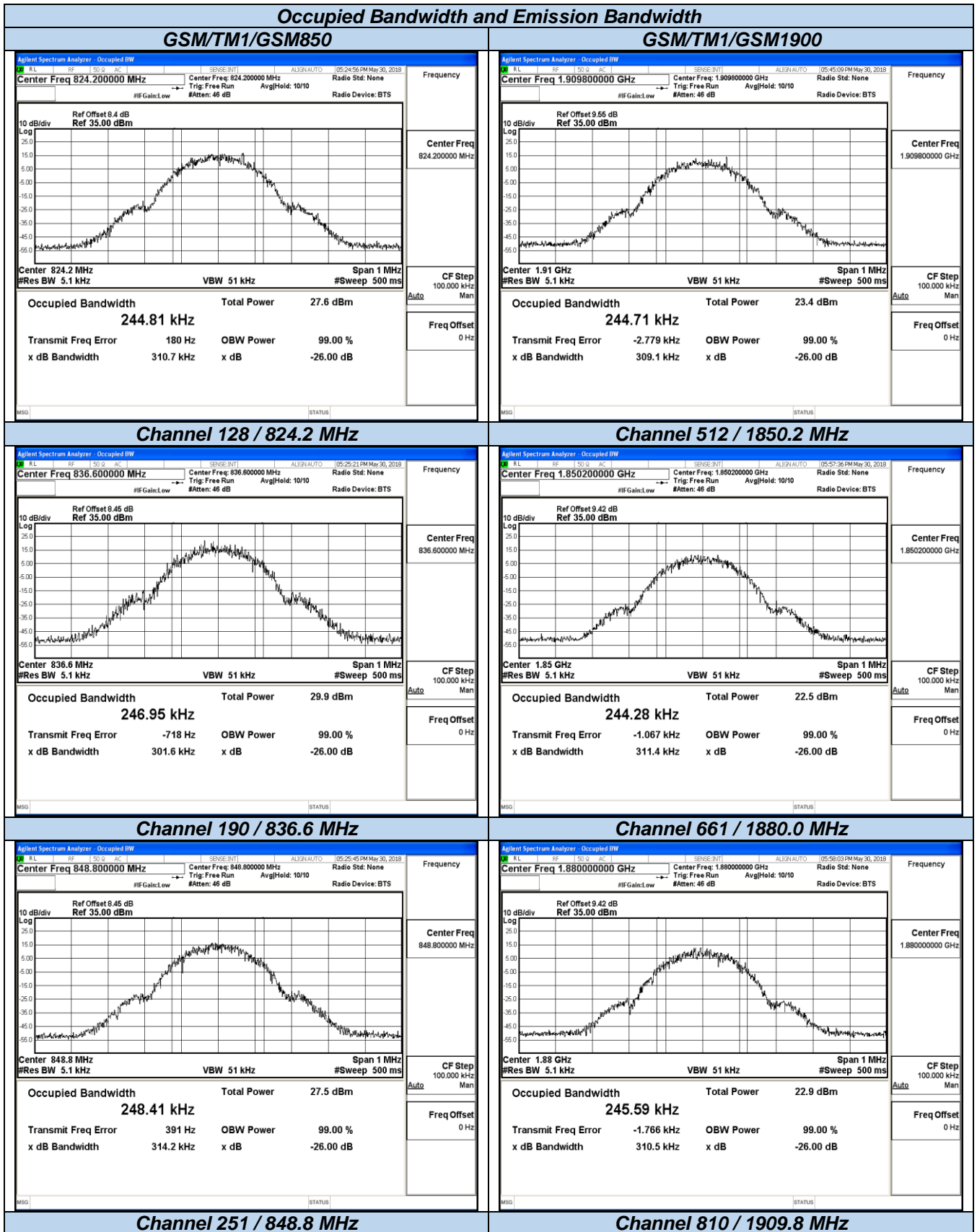

4.4 Band Edge Compliance

TEST APPLICABLE

During the process of testing, the EUT was controlled via Digital Radio Communication tester (CMU200) to ensure max power transmission and proper modulation.

TEST CONFIGURATION

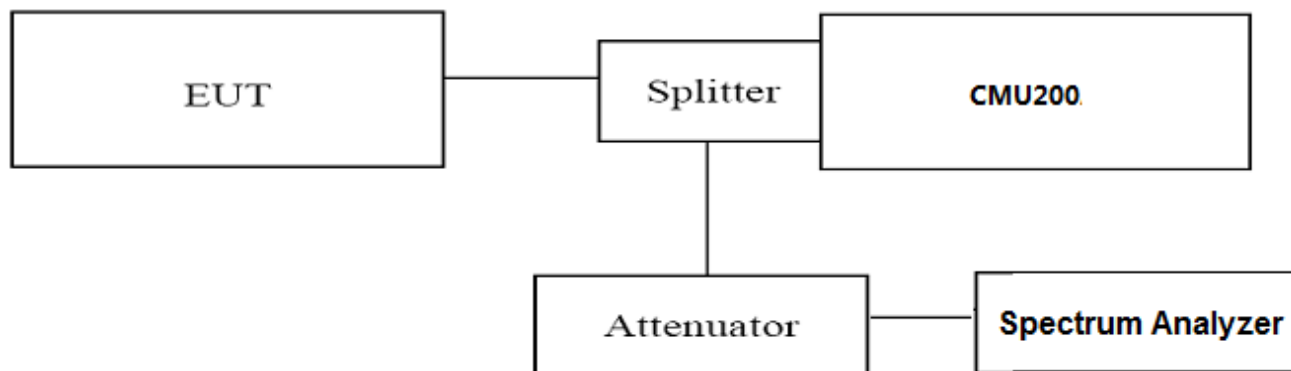

TEST PROCEDURE

1. The EUT was set up for the max output power with pseudo random data modulation;
2. The power was measured with Spectrum Analyzer N9020A;
3. Set RBW=5.1KHz,VBW=51KHz,Span=2MHz,SWT=Auto, Dector: RMS;
1. These measurements were done at 2 frequencies, 1850.20 MHz and 1909.80 MHz for PCS1900 band; 824.20 MHz and 848.80 MHz for GSM850 band. (bottom and top of operational frequency range).

TEST RESULTS

Test Mode	Channel	Frequency (MHz)	Band Edg Compliance (dBm)	Limits (dBm)	Verdict
GSM/TM1/GSM850	128	824.2	<-13dBm	-13dBm	PASS
	251	848.8	<-13dBm		
GSM/TM1/GSM1900	512	1850.2	<-13dBm	-13dBm	PASS
	810	1909.8	<-13dBm		

Remark:

1. Test results including cable loss;
2. please refer to following plots;

Band-edge Compliance

GSM/TM1/GSM850

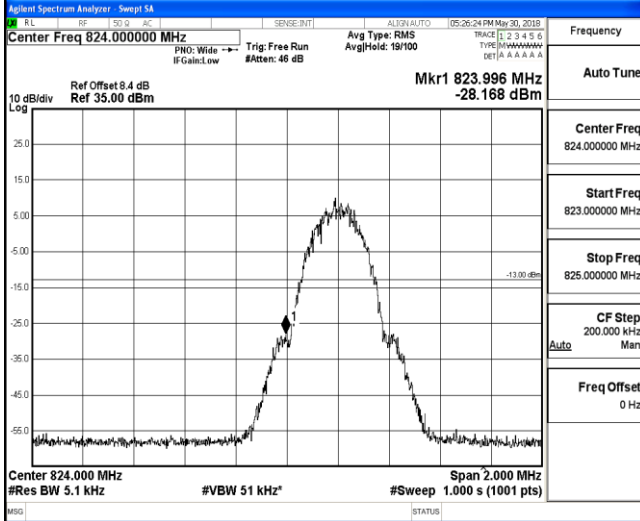

GSM/TM1/GSM1900

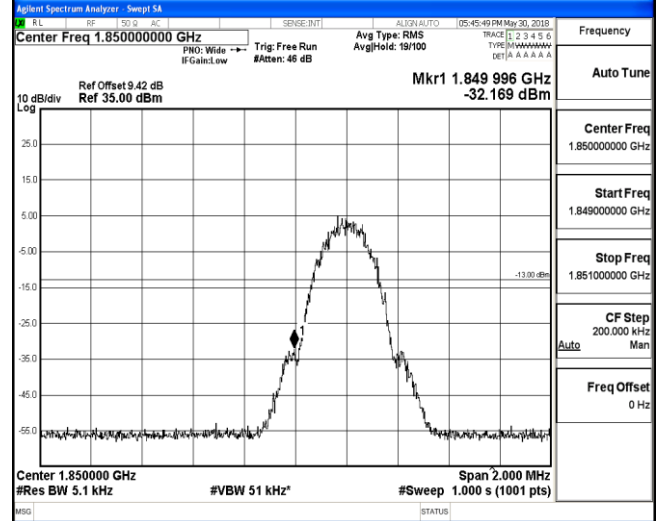

Channel 128 / 824.2 MHz

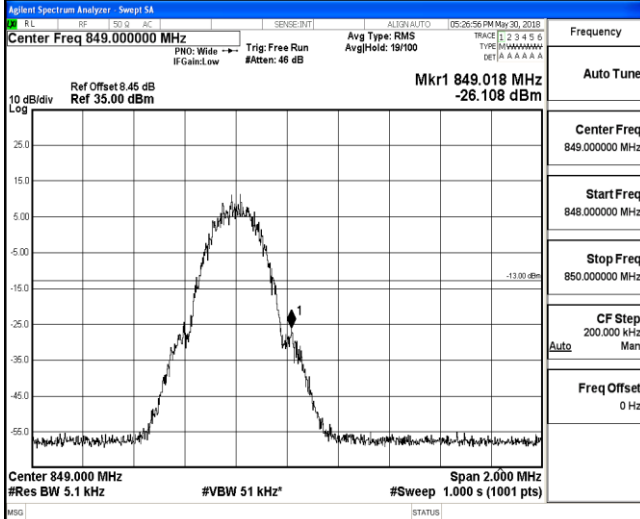

Channel 512 / 1850.2 MHz

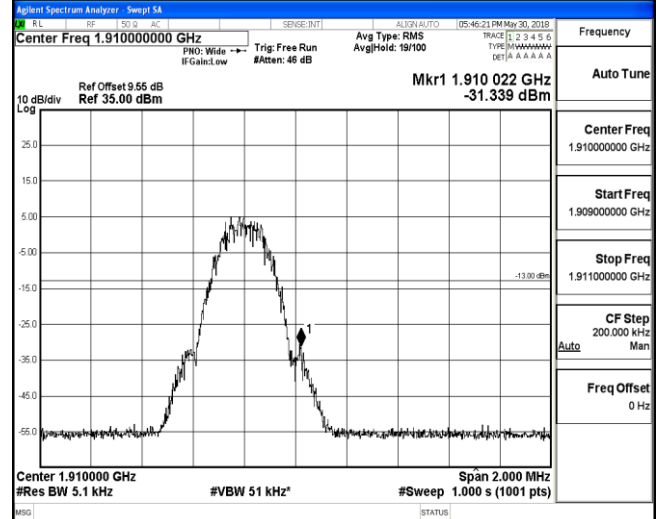

Channel 251 / 848.8 MHz

Channel 810 / 1909.8 MHz

4.5 Spurious Emission on Antenna Port

TEST APPLICABLE

The following steps outline the procedure used to measure the conducted emissions from the EUT.

1. Determine frequency range for measurements: From CFR 2.1057 and RSS-GEN the spectrum should be investigated from the lowest radio frequency generated in the equipment up to at least the 10th harmonic of the carrier frequency. For the equipment of PCS1900 band, this equates to a frequency range of 9 KHz to 20 GHz, data taken from 30 MHz to 20 GHz. For GSM850, this equates to a frequency range of 9 KHz to 9 GHz, data taken from 30 MHz to 9 GHz.
2. The sweep time is set automatically by instrument itself. That should be the optimal sweep time for the span and the RBW. If the sweep time is too short, that is sweep is too fast, the sweep result is not accurate; if the sweep time is too long, that is sweep is too low, some frequency components may be lost. The instrument will give an optimal sweep time according the selected span and RBW.
3. The procedure to get the conducted spurious emission is as follows:
The trace mode is set to MaxHold to get the highest signal at each frequency;
Wait 25 seconds;
Get the result.
4. Determine EUT transmit frequencies: below outlines the band edge frequencies pertinent to conducted emissions testing.

TEST CONFIGURATION

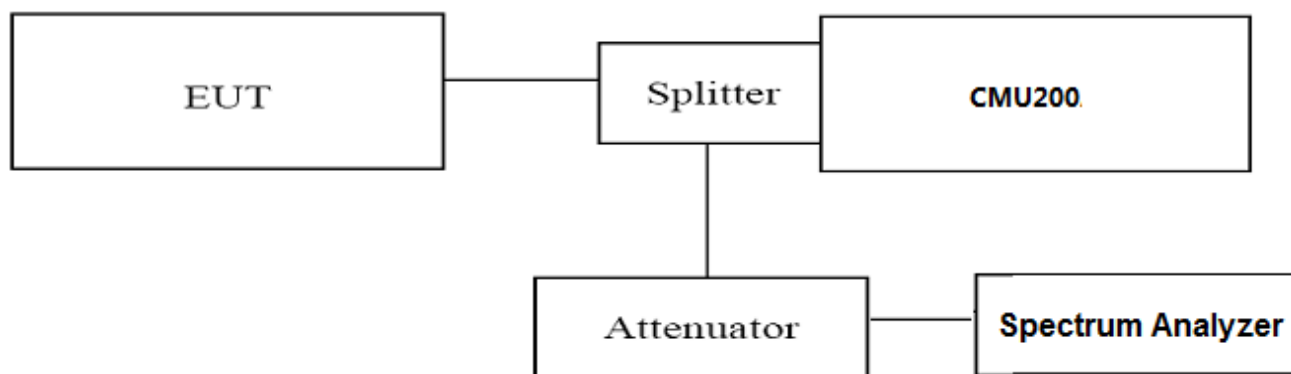

TEST PROCEDURE

1. The EUT was set up for the max output power with pseudo random data modulation;
2. The power was measured with Spectrum Analyzer N9020A;
3. These measurements were done at 3 frequencies, 1850.20 MHz, 1880.00 MHz and 1909.80 MHz for PCS1900 band; 824.20 MHz, 836.60 MHz and 848.80 MHz for GSM850 band. (Low, middle and high of operational frequency range).

TEST LIMIT

Part 24.238, Part 22.917 specify that the power of any emission outside of the authorized operating frequency ranges must be attenuated below the transmitting power (P) by a factor of at least $43 + 10 \log(P)$ dB.

The specification that emissions shall be attenuated below the transmitter power (P) by at least $43 + 10 \log(P)$ dB, translates in the relevant power range (1 to 0.001 W) to -13 dBm. At 1 W the specified minimum attenuation becomes 43 dB and relative to a 30 dBm (1 W) carrier becomes a limit of -13 dBm. At 0.001 W (0 dBm) the minimum attenuation is 13 dB, which again yields a limit of -13 dBm. In this way a translation of the specification from relative to absolute terms is carried out.

TEST RESULTS

Test Mode	Channel	Frequency (MHz)	Spurious RF Conducted Emission (dBm)	Limits (dBm)	Verdict
GSM/TM1/GSM850	128	824.2	<-13dBm	-13dBm	PASS
	190	836.6	<-13dBm	-13dBm	
	251	848.8	<-13dBm	-13dBm	
GSM/TM1/GSM1900	512	1850.2	<-13dBm	-13dBm	PASS
	661	1880.0	<-13dBm	-13dBm	
	810	1908.8	<-13dBm	-13dBm	

Remark:

1. Test results including cable loss;
2. Please refer to following plots;
3. Not reorded test plots from 9 KHz to 30 MHz as emission levels 20dB lower than emission limit;

Spurious Emission on Antenna Port

GSM/TM1/GSM850
Channel 128 / 824.2 MHz

GSM/TM1/GSM850
Channel 190 / 836.6 MHz

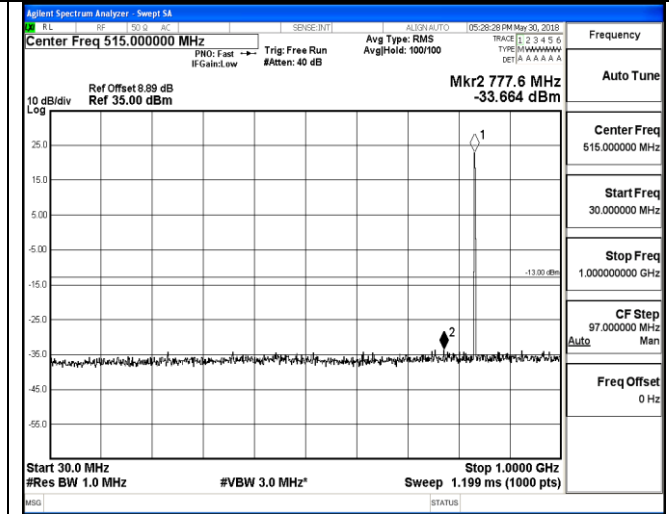
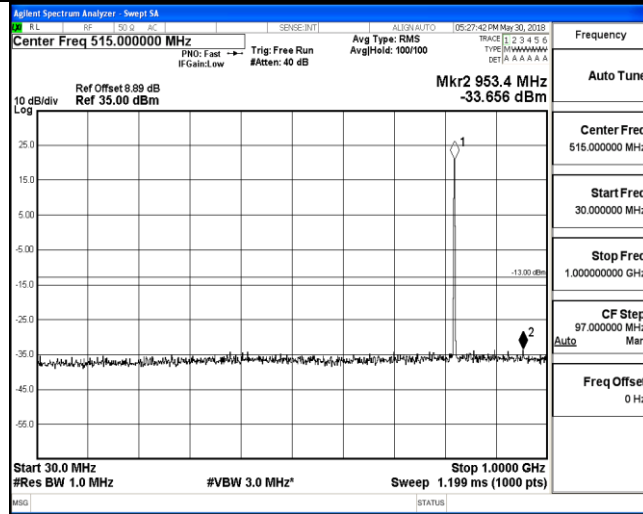

30 MHz – 1000 MHz

30 MHz – 1000 MHz

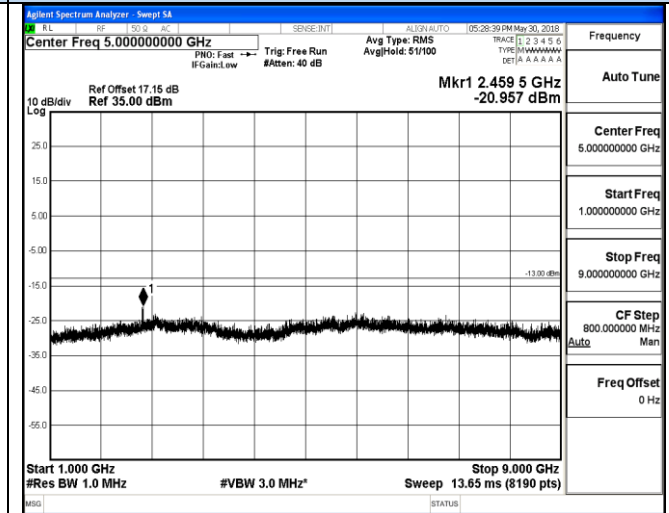
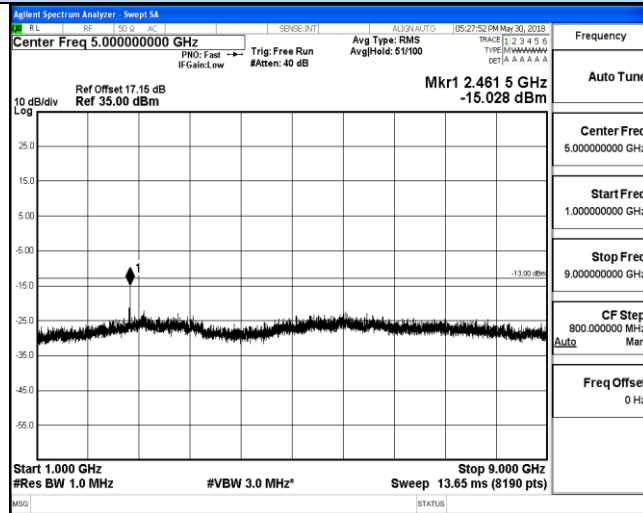

1 GHz – 9 GHz

1 GHz – 9 GHz

Channel 251 / 848.8 MHz

Channel 251 / 848.8 MHz

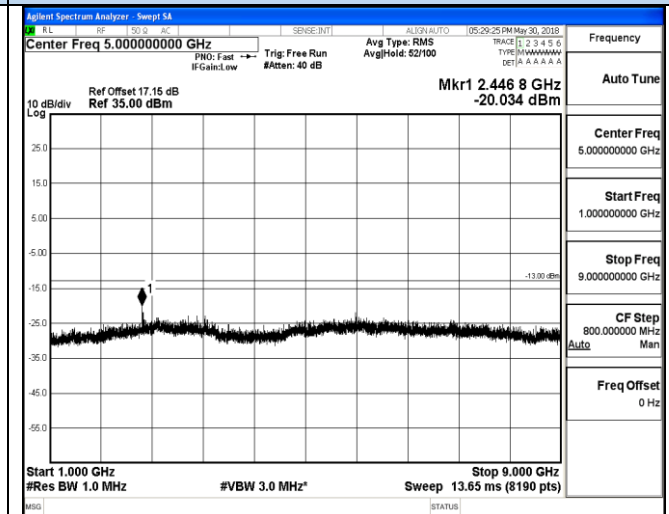
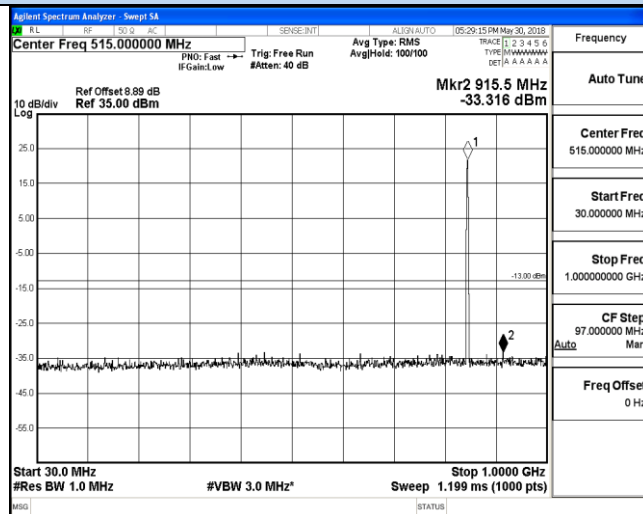

30 MHz – 1000 MHz

1 GHz – 9 GHz

Spurious Emission on Antenna Port

**GSM/TM1/GSM1900
Channel 512 / 1850.2 MHz**

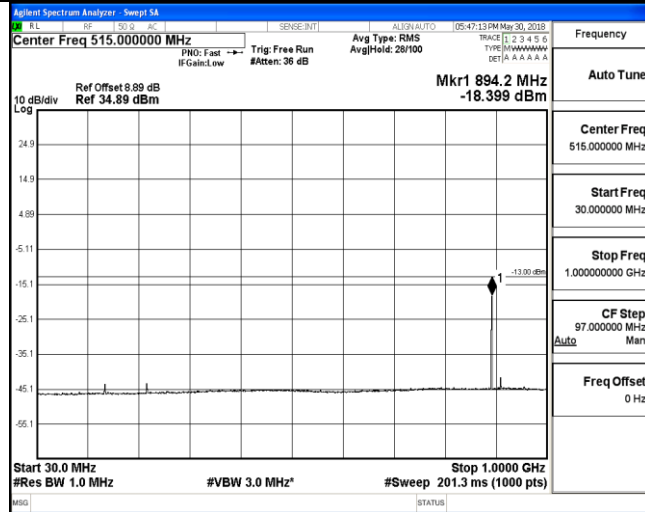

**GSM/TM1/GSM1900
Channel 661 / 1880 MHz**

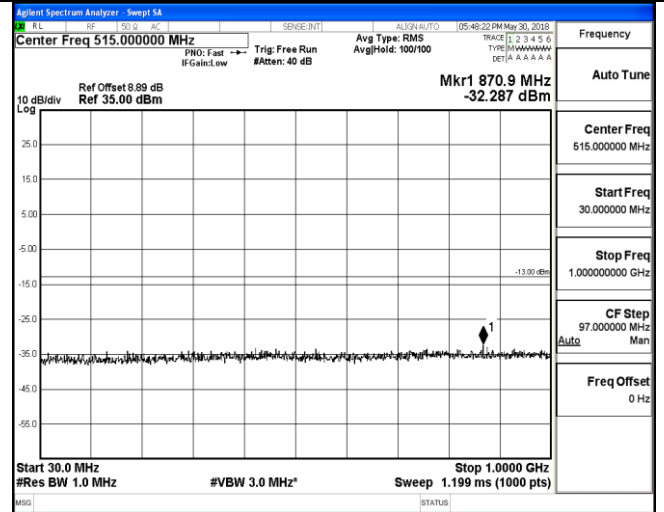

30 MHz – 1000 MHz

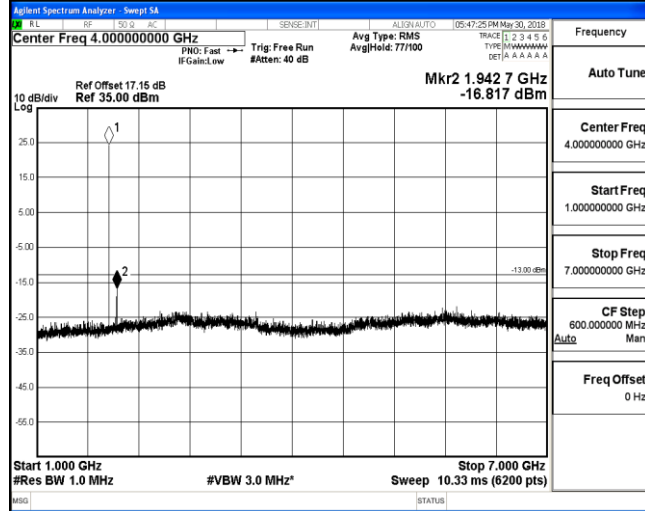

30 MHz – 1000 MHz

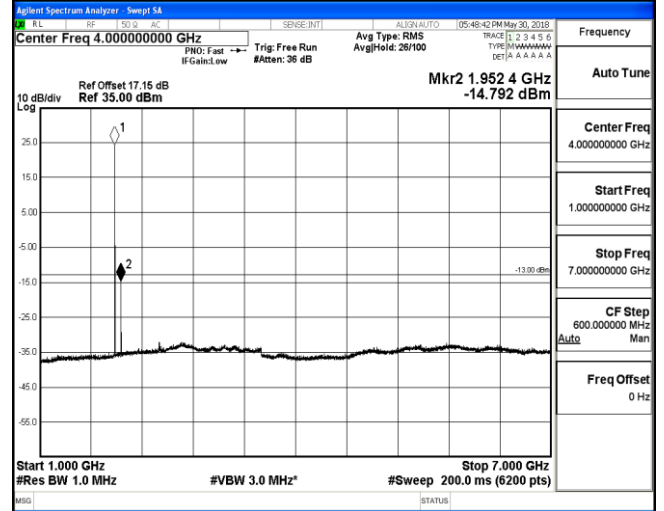

1 GHz – 7 GHz

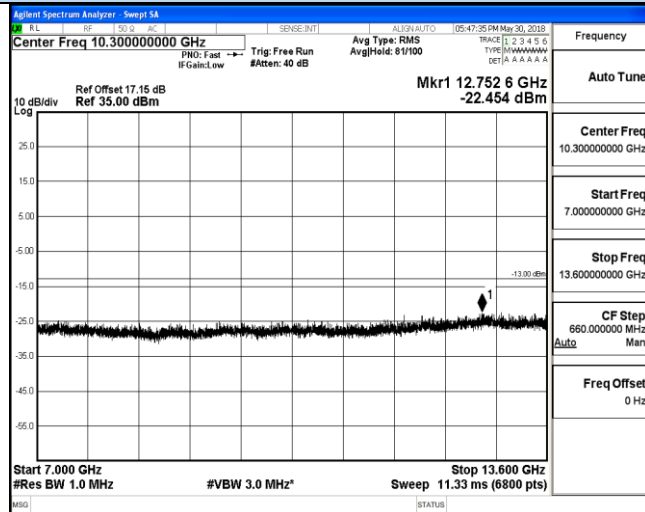

1 GHz – 7 GHz

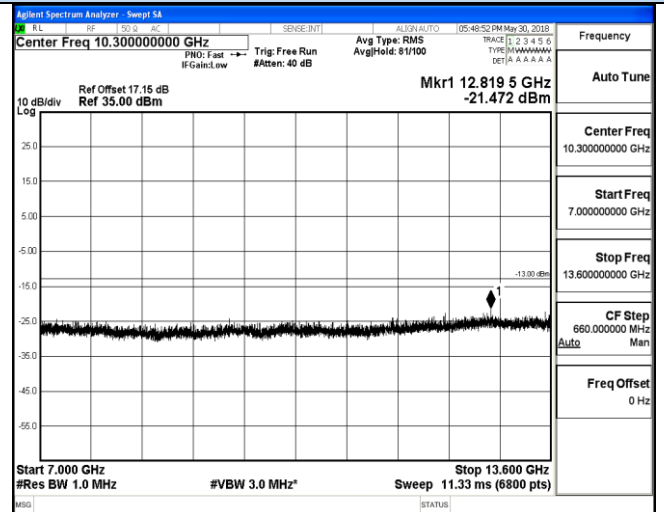

7 GHz – 13.6 GHz

7 GHz – 13.6 GHz

Spurious Emission on Antenna Port

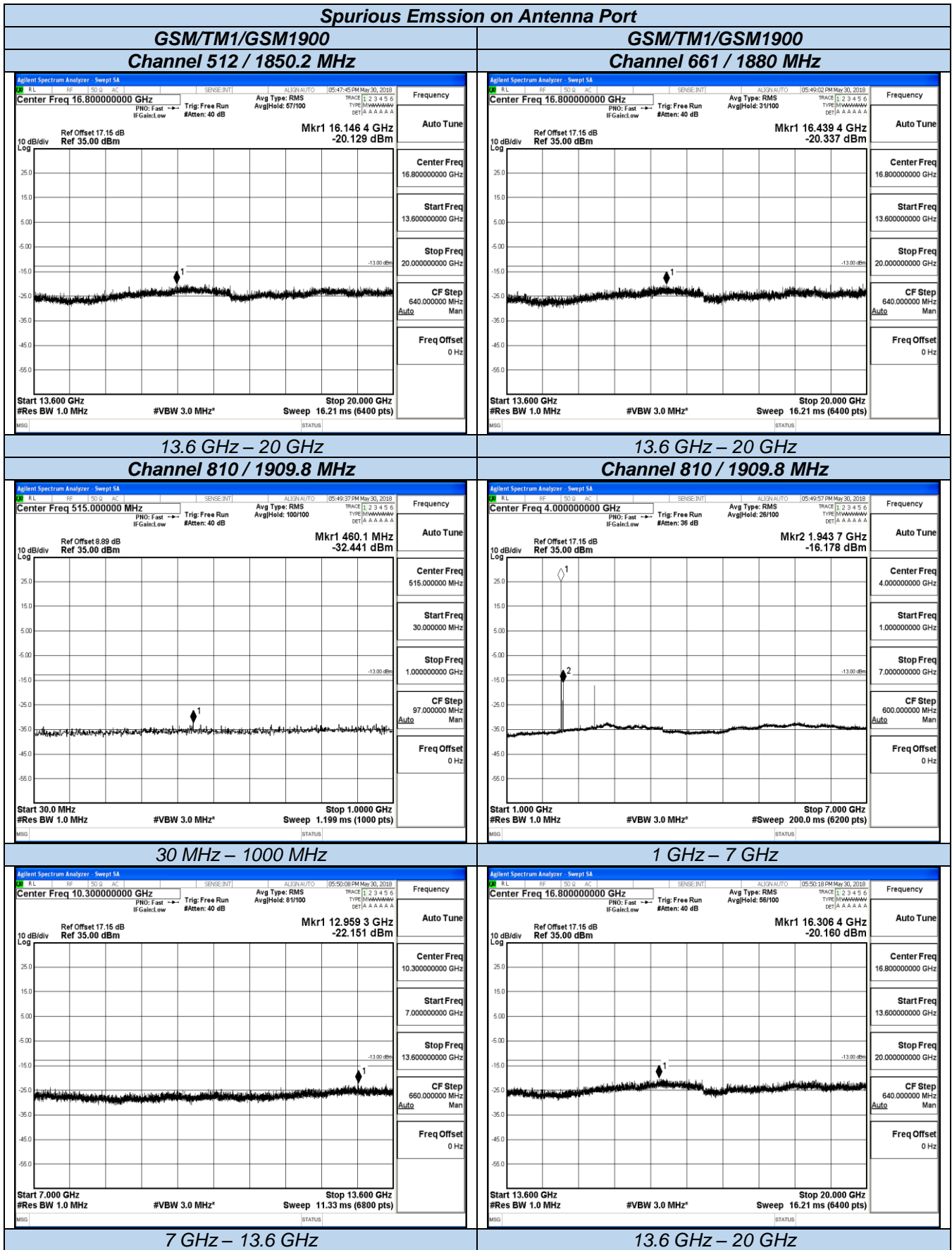

4.6 Frequency Stability Test

TEST APPLICABLE

1. According to FCC Part 2 Section 2.1055 (a)(1) and RSS-GEN, the frequency stability shall be measured with variation of ambient temperature from -30°C to +50°C centigrade.
2. According to FCC Part 2 Section 2.1055 (E) (2) and RSS-GEN, for battery powered equipment, the frequency stability shall be measured with reducing primary supply voltage to the battery operating end point, which is specified by the manufacture.
3. Vary primary supply voltage from 85 to 115 percent of the nominal value for other than hand carried voltage equipment.

TEST PROCEDURE

In order to measure the carrier frequency under the condition of AFC lock, it is necessary to make measurements with the EUT in a "call mode". This is accomplished with the use of R&S CMU200 DIGITAL RADIO COMMUNICATION TESTER.

1. Measure the carrier frequency at room temperature;
2. Subject the EUT to overnight soak at -30°C;
3. With the EUT, powered via nominal voltage, connected to the CMU200 and in a simulated call on middle channel of PCS 1900 and GSM850, measure the carrier frequency. These measurements should be made within 2 minutes of Powering up the EUT, to prevent significant self-warming;
4. Repeat the above measurements at 10°C increments from -30°C to +50°C. Allow at least 0.5 hours at each temperature, unpowered, before making measurements;
5. Remeasure carrier frequency at room temperature with nominal voltage. Vary supply voltage from minimum voltage to maximum voltage, in 0.1Volt increments remeasuring carrier frequency at each voltage. Pause at nominal voltage for 0.5 hours unpowered, to allow any self-heating to stabilize, before continuing;
6. Subject the EUT to overnight soak at +50°C;
7. With the EUT, powered via nominal voltage, connected to the CMU200 and in a simulated call on the centre channel, measure the carrier frequency. These measurements should be made within 2 minutes of Powering up the EUT, to prevent significant self-warming;
8. Repeat the above measurements at 10°C increments from +50°C to -30°C. Allow at least 0.5 hours at each temperature, unpowered, before making measurements;
9. At all temperature levels hold the temperature to +/- 0.5°C during the measurement procedure;

TEST CONFIGURATION

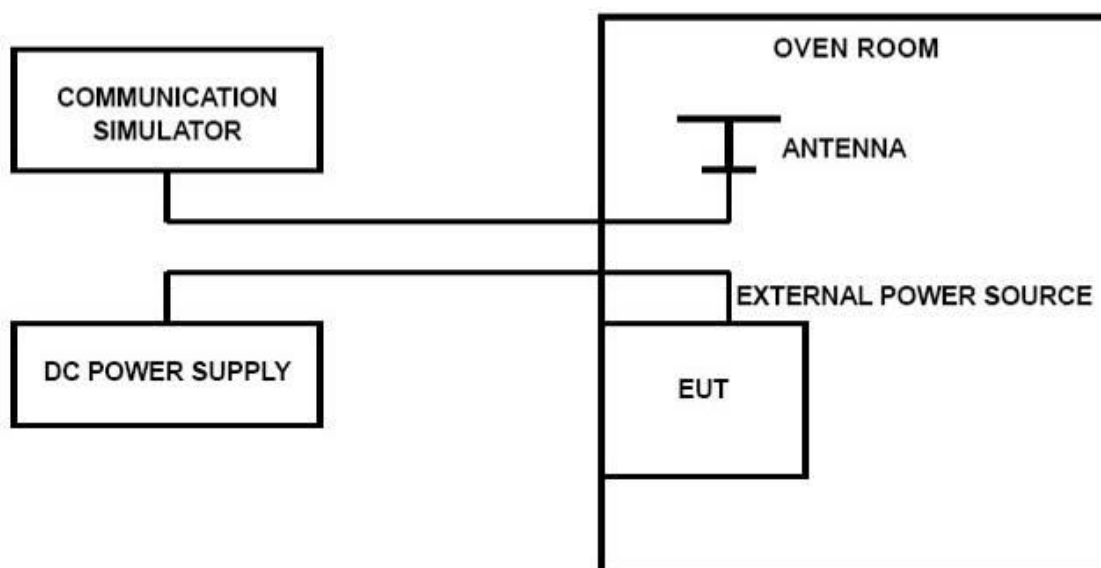

TEST LIMITS***For Hand carried battery powered equipment***

According to the JTC standard the frequency stability of the carrier shall be accurate to within 0.1 ppm of the received frequency from the base station. This accuracy is sufficient to meet Sec. 24.235, Frequency Stability. The frequency stability shall be sufficient to ensure that the fundamental emission stays within the authorized frequency block. As this transceiver is considered "Hand carried, battery powered equipment" Section 2.1055(d)(2) applies. This requires that the lower voltage for frequency stability testing be specified by the manufacturer. This transceiver is specified to operate with an input voltage of between 2.60VDC and 3.3VDC, with a nominal voltage of 3.0DC. Operation above or below these voltage limits is prohibited by transceiver software in order to prevent improper operation as well as to protect components from overstress. These voltages represent a tolerance of -10 % and +12.5 %. For the purposes of measuring frequency stability these voltage limits are to be used.

For equipment powered by primary supply voltage

According to the JTC standard the frequency stability of the carrier shall be accurate to within 0.1 ppm of the received frequency from the base station. This accuracy is sufficient to meet Sec. 24.235, Frequency Stability. The frequency stability shall be sufficient to ensure that the fundamental emission stays within the authorized frequency block. For this EUT section 2.1055(d)(1) applies. This requires varying primary supply voltage from 85 to 115 percent of the nominal value for other than hand carried battery equipment.

TEST RESULTS

GSM/TM1/GSMS850					
DC Power	Temperature (°C)	Frequency error(Hz)	Frequency error(ppm)	Limit (ppm)	Verdict
3.33	25	-8	-0.010	2.50	PASS
3.70	25	3	0.004	2.50	PASS
4.07	25	8	0.010	2.50	PASS
3.70	-25	-3	-0.003	2.50	PASS
3.70	-20	-8	-0.009	2.50	PASS
3.70	-10	3	0.004	2.50	PASS
3.70	0	8	0.009	2.50	PASS
3.70	10	-13	-0.016	2.50	PASS
3.70	20	7	0.008	2.50	PASS
3.70	30	11	0.013	2.50	PASS
3.70	40	-7	-0.008	2.50	PASS
3.70	50	5	0.006	2.50	PASS
3.70	60	-11	-0.013	2.50	PASS
3.70	70	-8	-0.009	2.50	PASS
3.70	75	-10	-0.012	2.50	PASS

GSM/TM1/GSM1900					
DC Power	Temperature (°C)	Frequency error(Hz)	Frequency error(ppm)	Limit (ppm)	Verdict
3.33	25	13	0.007	2.50	PASS
3.70	25	1	0.001	2.50	PASS
4.07	25	-14	-0.007	2.50	PASS
3.70	-25	12	0.006	2.50	PASS
3.70	-20	-1	0.000	2.50	PASS
3.70	-10	-3	-0.002	2.50	PASS
3.70	0	7	0.004	2.50	PASS
3.70	10	-6	-0.003	2.50	PASS
3.70	20	-15	-0.008	2.50	PASS
3.70	30	8	0.004	2.50	PASS
3.70	40	12	0.006	2.50	PASS
3.70	50	14	0.007	2.50	PASS
3.70	60	-3	-0.002	2.50	PASS
3.70	70	-7	-0.004	2.50	PASS
3.70	75	14	0.007	2.50	PASS

4.7 Peak-to-Average Ratio (PAR)

LIMIT

The Peak-to-Average Ratio (PAR) of the transmission may not exceed 13 dB.

TEST CONFIGURATION

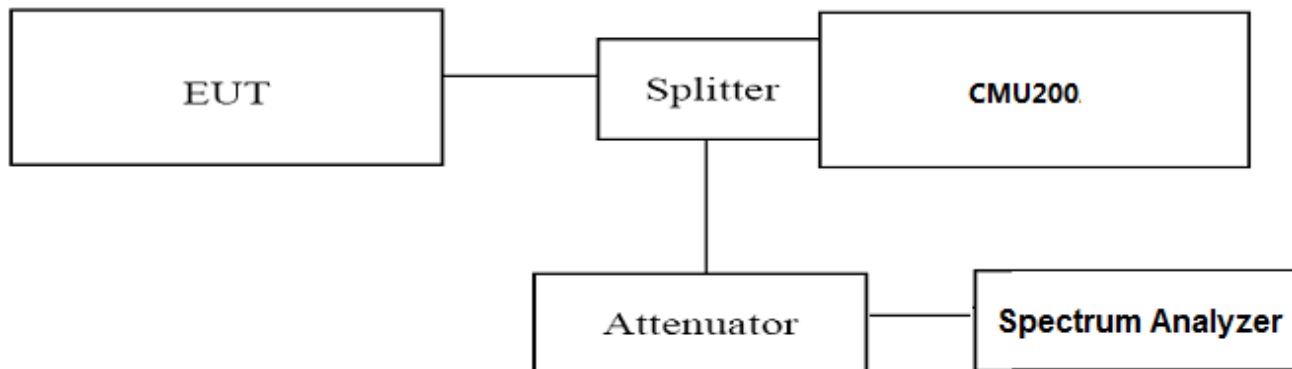

TEST PROCEDURE

Use spectrum to measure the total peak power and record as P_{Pk}. Use spectrum to measure the total average power and record as P_{Avg}. Both the peak and average power levels must be expressed in the same logarithmic units (e.g., dBm).

Determine the PAPR from:

$$PAPR (dB) = P_{Pk} (dBm) - P_{Avg} (dBm).$$

TEST RESULTS

Test Mode	Channel	Frequency (MHz)	PAPR Value (dB)	Limits (dB)	Verdict
GSM/TM1/ GSM850	128	824.2	1.49	13.0	PASS
	190	836.6	1.51	13.0	
	251	848.8	1.58	13.0	
GSM/TM1/GSM1900	512	1850.2	2.39	13.0	PASS
	661	1880.0	2.27	13.0	
	810	1908.8	2.26	13.0	

5 Test Setup Photos of the EUT

Please refer to separated files for Test Setup Photos of the EUT.

6 External Photos of the EUT

Please refer to separated files for External Photos of the EUT.

7 Internal Photos of the EUT

Please refer to separated files for Internal Photos of the EUT.

.....**End of Report**.....