

SAR TEST REPORT

For

SHENZHEN KENXINDA TECHNOLOGY CO.,LTD**4G Smartphone****Model No.: T50****List Model No.: T55, T50S, T55S, T60, T66**

Prepared for : SHENZHEN KENXINDA TECHNOLOGY CO.,LTD
Address : 18TH FLOOR,FUCHUN ORIENT BUILDING, SHENNAN
AV 7006, SHENZHEN, CHINA

Prepared by : Shenzhen LCS Compliance Testing Laboratory Ltd.
Address : 1/F., Xingyuan Industrial Park, Tongda Road, Bao'an
Avenue, Bao'an District, Shenzhen, Guangdong, China

Tel : (86)755-82591330
Fax : (86)755-82591332
Web : www.LCS-cert.com
Mail : webmaster@LCS-cert.com

Date of receipt of test sample : Sep 30, 2018
Number of tested samples : 1
Serial number : Prototype
Date of Test : Oct 10, 2018~Oct 23, 2018
Date of Report : Oct 30, 2018

SAR TEST REPORT**Report Reference No. : LCS180522036AEB**

Date Of Issue : Oct 30, 2018

Testing Laboratory Name : Shenzhen LCS Compliance Testing Laboratory Ltd.Address : 1/F., Xingyuan Industrial Park, Tongda Road, Bao'an Avenue,
Bao'an District, Shenzhen, Guangdong, ChinaTesting Location/ Procedure : Full application of Harmonised standards
Partial application of Harmonised standards
Other standard testing method **Applicant's Name..... : SHENZHEN KENXINDA TECHNOLOGY CO.,LTD**Address : 18TH FLOOR,FUCHUN ORIENT BUILDING, SHENNAN AV
7006, SHENZHEN, CHINA**Test Specification:**

Standard : IEEE Std C95.1, 2005& IEEE Std 1528™-2013&FCC Part 2.1093

Test Report Form No. : LCSEMC-1.0

TRF Originator : Shenzhen LCS Compliance Testing Laboratory Ltd.

Master TRF : Dated 2014-09

Shenzhen LCS Compliance Testing Laboratory Ltd. All rights reserved.

This publication may be reproduced in whole or in part for non-commercial purposes as long as the Shenzhen LCS Compliance Testing Laboratory Ltd. is acknowledged as copyright owner and source of the material. Shenzhen LCS Compliance Testing Laboratory Ltd. takes no responsibility for and will not assume liability for damages resulting from the reader's interpretation of the reproduced material due to its placement and context.

Test Item Description. : 4G Smartphone

Trade Mark : Kenxinda, Ken mobile, KXD, E&L, EL

Model/Type Reference : T50

Operation Frequency : GSM 850/PCS1900, WCDMA Band II/V,LTE Band2/4/7,
WLAN2.4G, Bluetooth4.2

Modulation Type : Refer to page 7

Ratings : DC 3.7V by Rechargeable Li-ion Battery(2000mAh)
Recharged by DC 5V/1A TRAVEL CHARGER**Result : Positive****Compiled by:**

Vera Deng/ File administrators

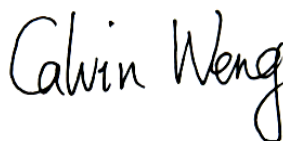
Supervised by:

Calvin Weng/ Technique principal

Approved by:

Gavin Liang/ Manager

SAR -- TEST REPORT

Test Report No. : LCS180522036AEB	<u>Oct 30, 2018</u> Date of issue
---	--------------------------------------

Type / Model..... : T50
EUT..... : 4G Smartphone
Applicant..... : SHENZHEN KENXINDA TECHNOLOGY CO.,LTD Address..... : 18TH FLOOR,FUCHUN ORIENT BUILDING, SHENNAN AV 7006, SHENZHEN, CHINA Telephone..... : / Fax..... : /
Manufacturer..... : SHENZHEN KENXINDA TECHNOLOGY CO.,LTD Address..... : 18TH FLOOR,FUCHUN ORIENT BUILDING, SHENNAN AV 7006, SHENZHEN, CHINA Telephone..... : / Fax..... : /
Factory..... : SHENZHEN KENXINDA TECHNOLOGY CO.,LTD Address..... : No.8 Building, Shiao Second Industrial Zone, Dalang Clothing Base, Longhua New District, Shenzhen, China Telephone..... : / Fax..... : /

Test Result	Positive
--------------------	-----------------

The test report merely corresponds to the test sample.
 It is not permitted to copy extracts of these test result without the written permission of the test laboratory.

Revision History

Revision	Issue Date	Revisions	Revised By
000	Oct 30, 2018	Initial Issue	Gavin Liang

TABLE OF CONTENTS

1. TEST STANDARDS AND TEST DESCRIPTION.....	6
1.1. TEST STANDARDS	6
1.2. TEST DESCRIPTION	6
1.3. GENERAL REMARKS	6
1.4. PRODUCT DESCRIPTION	6
1.5. STATEMENT OF COMPLIANCE	8
2. TEST ENVIRONMENT	9
2.1. TEST FACILITY	9
2.2. ENVIRONMENTAL CONDITIONS	9
2.3. SAR LIMITS	9
2.4. EQUIPMENTS USED DURING THE TEST	10
3. SAR MEASUREMENTS SYSTEM CONFIGURATION	12
3.1. SAR MEASUREMENT SET-UP	12
3.2. OPENSAR E-FIELD PROBE SYSTEM	13
3.3. PHANTOMS.....	14
3.4. DEVICE HOLDER	14
3.5. SCANNING PROCEDURE	15
3.6. DATA STORAGE AND EVALUATION.....	16
3.7. POSITION OF THE WIRELESS DEVICE IN RELATION TO THE PHANTOM	17
3.8. TISSUE DIELECTRIC PARAMETERS FOR HEAD AND BODY PHANTOMS	19
3.9. TISSUE EQUIVALENT LIQUID PROPERTIES	19
3.10. SYSTEM CHECK	20
3.11. SAR MEASUREMENT PROCEDURE	22
3.12. POWER REDUCTION	27
3.13. POWER DRIFT	27
4. TEST CONDITIONS AND RESULTS.....	28
4.1. CONDUCTED POWER RESULTS	28
4.2. MANUFACTURING TOLERANCE	39
4.3. TRANSMIT ANTENNAS AND SAR MEASUREMENT POSITION	46
4.4. SAR MEASUREMENT RESULTS	47
4.5. SIMULTANEOUS TX SAR CONSIDERATIONS	51
4.6. SAR MEASUREMENT VARIABILITY	54
4.7. GENERAL DESCRIPTION OF TEST PROCEDURES	55
4.8. MEASUREMENT UNCERTAINTY (450MHZ-6GHZ).....	56
4.9. SYSTEM CHECK RESULTS	57
4.10 SAR TEST GRAPH RESULTS	67
5. CALIBRATION CERTIFICATES	83
5.1 PROBE-EPGO281 CALIBRATION CERTIFICATE.....	83
5.2 SID750DIPOLE CALIBRATION CERITICATE.....	93
5.3 SID835DIPOLE CALIBRATION CERITICATE.....	104
5.4 SID1800 DIPOLE CALIBRATION CERTIFICATE	115
5.5 SID1900 DIPOLE CALIBRATION CERTIFICATE	126
5.6 SID2450 DIPOLE CALIBRATION CERITICATE.....	137
5.7 SID2600 DIPOLE CALIBRATION CERITICATE.....	148
6. EUT TEST PHOTOGRAPHS	159
6.1 PHOTOGRAPH OF LIQUID DEPTH.....	159
6.2 PHOTOGRAPH OF THE TEST	165
7. EUT PHOTOGRAPHS	170

1. TEST STANDARDS AND TEST DESCRIPTION

1.1. Test Standards

[IEEE Std C95.1, 2005](#): IEEE Standard for Safety Levels with Respect to Human Exposure to Radio Frequency Electromagnetic Fields, 3 KHz to 300 GHz. It specifies the maximum exposure limit of 1.6 W/kg as averaged over any 1 gram of tissue for portable devices being used within 20 cm of the user in the uncontrolled environment.

[IEEE Std 1528™-2013](#): IEEE Recommended Practice for Determining the Peak Spatial-Average Specific Absorption Rate (SAR) in the Human Head from Wireless Communications Devices: Measurement Techniques.

[FCC Part 2.1093](#): Radiofrequency Radiation Exposure Evaluation: Portable Devices

[KDB447498 D01 General RF Exposure Guidance](#) : Mobile and Portable Device RF Exposure Procedures and Equipment Authorization Policies

[KDB648474 D04](#): Handset SAR v01r03: SAR Evaluation Considerations for Wireless Handsets

[KDB865664 D01 SAR Measurement 100 MHz to 6 GHz](#) : SAR Measurement Requirements for 100 MHz to 6 GHz

[KDB865664 D02 RF Exposure Reporting](#): RF Exposure Compliance Reporting and Documentation Considerations

[KDB248227 D01 802.11 Wi-Fi SAR](#): SAR Guidance For IEEE 802.11 (Wi-Fi) Transmitters

[KDB941225 D01 3G SAR Procedures](#): 3G SAR Measurement Procedures

[KDB 941225 D06 Hotspot Mode](#): SAR Evaluation Procedures For Portable Devices With Wireless Router Capabilities

[KDB 941225 D05 SAR for LTE Devices](#): SAR Evaluation Considerations For LTE Devices

1.2. Test Description

The EUT battery must be fully charged and checked periodically during the test to ascertain uniform power . And Test device is identical prototype.

1.3. General Remarks

Date of receipt of test sample	:	Sep 30, 2018
Testing commenced on	:	Oct 08, 2018
Testing concluded on	:	Oct 23, 2018

1.4. Product Description

The **SHENZHEN KENXINDA TECHNOLOGY CO.,LTD.**'s Model: **T50** or the "EUT" as referred to in this report; more general information as follows, for more details, refer to the user's manual of the EUT.

General Description	
Product Name:	4G Smartphone
Model/Type reference:	T50
List Model No.:	T55, T50S, T55S, T60, T66
Model Declaration:	PCB board, structure and internal of these model(s) are the same, So no additional models were tested.
Modulation Type:	GMSK for GSM/GPRS, 8-PSK for EDGE, QPSK for UMTS, QPSK, 16QAM for LTE
Device category:	Portable Device
Exposure category:	General population/uncontrolled environment
EUT Type:	Production Unit
Hardware Version	A555-MB-V1.0A
Software Version:	V1.0
Power supply:	DC 3.7V by Rechargeable Li-ion Battery(2000mAh) Recharged by DC 5V/1A TRAVEL CHARGER
Hotspot:	Supported, power not reduced when Hotspot open
VoIP	Supported
<p><i>The EUT is GSM, WCDMA, LTE, mobile phone. the mobile phone is intended for speech and Multimedia Message Service (MMS) transmission. It is equipped with GPRS/EDGE class 12 for GSM850, PCS1900, WCDMA Band II, Band V, LTE Band 2, LTE Band 4, Band7, and Bluetooth, WiFi2.4G camera functions. For more information see the following datasheet</i></p>	

Technical Characteristics	
GSM	
Support Networks	GSM, GPRS, EDGE
Support Band	GSM850/ DCS1800/ GSM900/ PCS1900
Frequency	GSM850: 824.2~848.8MHz GSM1900: 1850.2~1909.8MHz
Power Class:	GSM850:Power Class 4 PCS1900:Power Class 1
Modulation Type:	GSM850/PCS1900/GPRS850/GPRS1900/EDGE850/EDGE1900
GSM Release Version	R99
GPRS Multislot Class	12
EGPRS Multislot Class	12
DTM Mode	Not Supported
Antenna Gain:	1 dBi (max.) For GSM 850, PCS 1900;
Antenna Type:	PIFA Antenna
UMTS	
Support Networks	WCDMA RMC12.2K,HSDPA,HSUPA
Operation Band:	WCDMA Band II, Band V
Frequency Range	WCDMA Band II: 1852.4 ~ 1907.6MHz WCDMA Band V: 826.4 ~ 846.6MHz
Modulation Type:	QPSK for WCDMA/HSUPA/HSDPA
Power Class:	Class 3
WCDMA Release Version:	R8
HSDPA Release Version:	Release 8
HSUPA Release Version:	Release 6
DC-HSUPA Release Version:	Not Supported
Antenna Gain:	1 dBi (max.) For WCDMA Band II, V;
Antenna Type:	PIFA Antenna
LTE	
Support Band	LTE Band2, Band4, Band7
Frequency Range	LTE Band2:1850 ~ 1910MHz LTE Band4:1710 ~ 1755MHz LTE Band7:2510 ~ 2560MHz
Power Class:	Class 3
Modulation Type:	QPSK/16QAM/64QAM
LTE Release Version:	Release 9
VoLTE	Not Support
Antenna Gain:	1 dBi (max.) For LTE Band 2, 4, 7;
Antenna Type:	PIFA Antenna

WIFI 2.4G	
Supported Standards:	IEEE 802.11b/802.11g/802.11n(HT20)
Operation frequency:	2412-2462MHz for 11b/g/n(HT20)
Type of Modulation:	CCK, OFDM, QPSK, BPSK, 16QAM, 64QAM
Data Rate:	1-11Mbps, 6-54Mbps, up to 150Mbps
Channel number:	IEEE 802.11b/802.11g/802.11n(HT20):11
Channel separation:	5MHz
Antenna Description	PIFA Antenna; 0.8 dBi (max.)
Bluetooth	
Bluetooth Version:	V4.2
Modulation:	GFSK, $\pi/4$ -DQPSK, 8-DPSK (BT V4.2)
Operation frequency:	2402MHz~2480MHz
Channel number:	40/79
Channel separation:	1MHz/2MHz
Antenna Description	PIFA Antenna; 0.8 dBi (max.)

1.5. Statement of Compliance

The maximum of results of SAR found during testing for T50 are follows:

<Highest Reported standalone SAR Summary>

Classment Class	Frequency Band	Head (Report SAR _{1-g} (W/kg))	Hotspot (Report SAR _{1-g} (W/kg))	Body-worn (Report SAR _{1-g} (W/kg))
			(Separation Distance 10mm)	
PCE	GSM 850	0.072	0.161	0.161
	GSM1900	0.129	0.276	0.276
	WCDMA Band V	0.060	0.109	0.109
	WCDMA Band II	0.259	0.489	0.489
	LTE Band 2	0.191	0.513	0.513
	LTE Band 4	0.193	0.387	0.387
	LTE Band 7	0.358	0.278	0.278
DTS	WIFI2.4G	0.172	0.131	0.131

This device is in compliance with Specific Absorption Rate (SAR) for general population/uncontrolled exposure limits (1.6 W/kg) specified in FCC 47 CFR part 2 (2.1093) and ANSI/IEEE C95.1-2005, and had been tested in accordance with the measurement methods and procedures specified in IEEE 1528-2013.

<Highest Reported simultaneous SAR Summary>

Exposure Position	Frequency Band	Reported SAR _{1-g} (W/kg)	Classment Class	Highest Reported Simultaneous Transmission SAR _{1-g} (W/kg)
Hotspot	LTE Band 2	0.513	PCE	0.644
	WIFI2.4G	0.131	DTS	

2. TEST ENVIRONMENT

2.1. Test Facility

The test facility is recognized, certified, or accredited by the following organizations:

Site Description
EMC Lab. : FCC Registration Number. is 254912
Industry Canada Registration Number. is 9642A-1.
ESMD Registration Number. is ARCB0108.
UL Registration Number. is 100571-492.
TUV SUD Registration Number. is SCN1081.
TUV RH Registration Number. is UA 50296516-001
NVLAP Registration Code is 600167-0.

2.2. Environmental conditions

During the measurement the environmental conditions were within the listed ranges:

Temperature:	18-25 ° C
Humidity:	40-65 %
Atmospheric pressure:	950-1050mbar

2.3. SAR Limits

EXPOSURE LIMITS	FCC Limit (1g Tissue)	
	SAR (W/kg)	
	(General Population / Uncontrolled Exposure Environment)	(Occupational / Controlled Exposure Environment)
Spatial Average(averaged over the whole body)	0.08	0.4
Spatial Peak(averaged over any 1 g of tissue)	1.6	8.0
Spatial Peak(hands/wrists/ feet/anklesaveraged over 10 g)	4.0	20.0

Population/Uncontrolled Environments are defined as locations where there is the exposure of individual who have no knowledge or control of their exposure.

Occupational/Controlled Environments are defined as locations where there is exposure that may be incurred by people who are aware of the potential for exposure (i.e. as a result of employment or occupation).

2.4. Equipments Used during the Test

Test Equipment	Manufacturer	Type/Model	Serial Number	Calibration	
				Calibration Date	Calibration Due
PC	Lenovo	G5005	MY42081102	N/A	N/A
SAR Measurement system	SATIMO	4014_01	SAR_4014_01	N/A	N/A
Signal Generator	Agilent	E4438C	MY42081396	11/18/2017	11/18/2018
Multimeter	Keithley	MiltiMeter 2000	4059164	11/18/2017	11/18/2018
S-parameter Network Analyzer	Agilent	8753ES	US38432944	11/18/2017	11/18/2018
Wireless Communication Test Set	R & S	CMU200	105988	11/18/2017	11/18/2018
Wideband Radia Communication Tester	R&S	CMW500	1201.0002K50	11/18/2017	11/18/2018
E-Field PROBE	SATIMO	SSE2	SN 45/15 EPGO281	02/04/2018	02/03/2019
DIPOLE 835	SATIMO	SID 835	SN 07/14 DIP 0G835-303	10/01/2018	09/30/2021
DIPOLE 1800	SATIMO	SID 1800	SN 07/14 DIP 1G800-301	10/01/2018	09/30/2021
DIPOLE 1900	SATIMO	SID 1900	SN 30/14 DIP 1G900-333	09/01/2018	08/31/2021
DIPOLE 2450	SATIMO	SID 2450	SN 07/14 DIP 2G450-306	10/01/2018	09/30/2021
DIPOLE 2600	SATIMO	SID2600	SN 30/14 DIP 2G600-336	09/01/2018	08/31/2021
COMOSAR OPEN Coaxial Probe	SATIMO	OCPG 68	SN 40/14 OCPG68	11/18/2017	11/18/2018
SAR Locator	SATIMO	VPS51	SN 40/14 VPS51	11/18/2017	11/18/2018
Communication Antenna	SATIMO	ANTA57	SN 39/14 ANTA57	11/18/2017	11/18/2018
Mobile Phone POSITIONING DEVICE	SATIMO	MSH98	SN 40/14 MSH98	N/A	N/A
DUMMY PROBE	SATIMO	DP60	SN 03/14 DP60	N/A	N/A
SAM PHANTOM	SATIMO	SAM117	SN 40/14 SAM117	N/A	N/A
Liquid measurement Kit	HP	85033D	3423A03482	11/18/2017	11/18/2018
Power meter	Agilent	E4419B	MY45104493	06/16/2018	06/15/2019
Power meter	Agilent	E4418B	GB4331256	06/16/2018	06/15/2019
Power sensor	Agilent	E9301H	MY41497725	06/16/2018	06/15/2019
Power sensor	Agilent	E9301H	MY41495234	06/16/2018	06/15/2019
Directional Coupler	MCLI/USA	4426-20	0D2L51502	06/16/2018	06/15/2019

Note:

- 1) Per KDB865664D01 requirements for dipole calibration, the test laboratory has adopted three year extended calibration interval. Each measured dipole is expected to evaluate with following criteria at least on annual interval.
 - a) There is no physical damage on the dipole;
 - b) System check with specific dipole is within 10% of calibrated values;
 - c) The most recent return-loss results, measured at least annually, deviates by no more than 20% from the previous measurement;
 - d) The most recent measurement of the real or imaginary parts of the impedance, measured at least annually is within 5Ω from the previous measurement.
- 2) Network analyzer probe calibration against air, distilled water and a shorting block performed before measuring liquid parameters.

3. SAR MEASUREMENTS SYSTEM CONFIGURATION

3.1. SAR Measurement Set-up

The OPENSAR system for performing compliance tests consist of the following items:

A standard high precision 6-axis robot (KUKA) with controller and software.

KUKA Control Panel (KCP)

A dosimetric probe, i.e., an isotropic E-field probe optimized and calibrated for usage in tissue simulating liquid. The probe is equipped with a Video Positioning System(VPS).

The stress sensor is composed with mechanical and electronic when the electronic part detects a change on the electro-mechanical switch,It sends an "Emergency signal" to the robot controller that to stop robot's moves

A computer operating Windows XP.

OPENSAR software

Remote control with teaches pendant and additional circuitry for robot safety such as warning lamps, etc.

The SAM phantom enabling testing left-hand right-hand and body usage.

The Position device for handheld EUT

Tissue simulating liquid mixed according to the given recipes .

System validation dipoles to validate the proper functioning of the system.

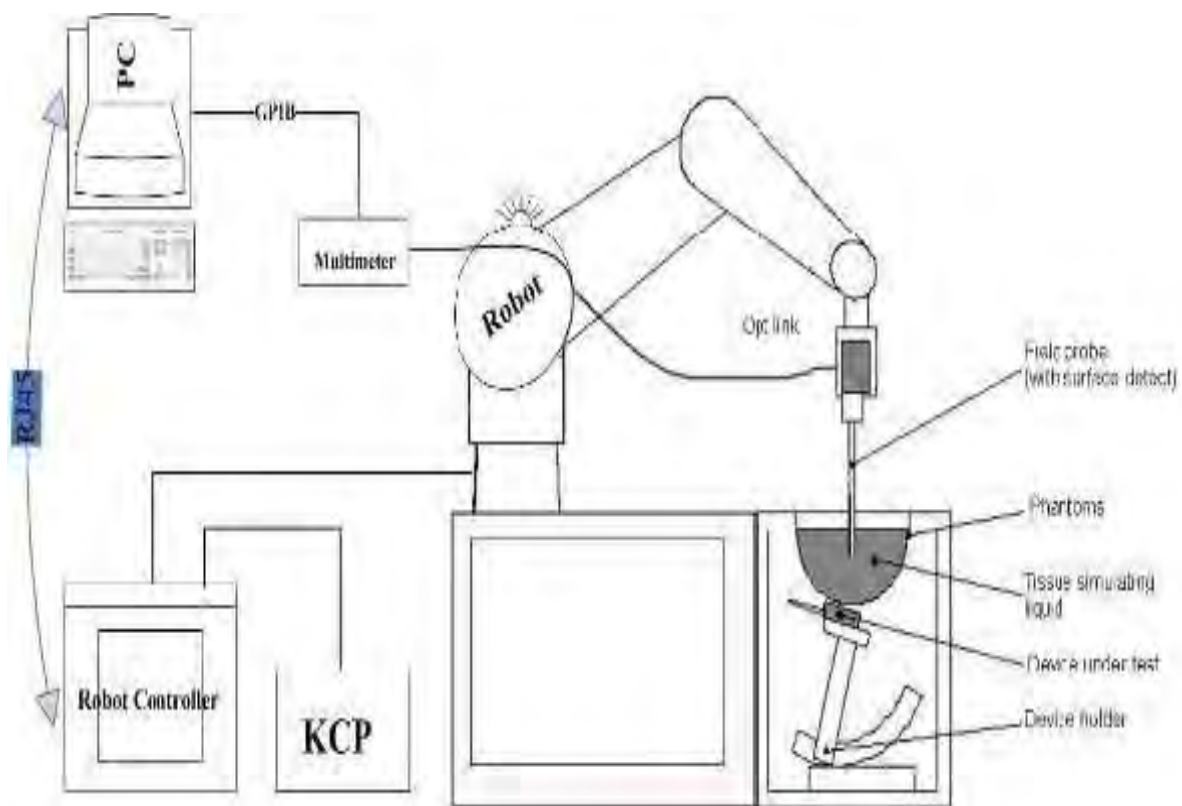

3.2. OPENSAR E-field Probe System

The SAR measurements were conducted with the dosimetric probe EPGO281 (manufactured by SATIMO), designed in the classical triangular configuration and optimized for dosimetric evaluation.

Probe Specification

Construction Symmetrical design with triangular core
 Interleaved sensors
 Built-in shielding against static charges
 PEEK enclosure material (resistant to organic solvents, e.g., DGBE)

Calibration ISO/IEC 17025 calibration service available.

Frequency	450 MHz to 6 GHz; Linearity: 0.25dB(450 MHz to 6GHz)
Directivity	0.25 dB in HSL (rotation around probe axis) 0.5 dB in tissue material (rotation normal to probe axis)
Dynamic Range	0.01W/kg to > 100 W/kg; Linearity: 0.25 dB
Dimensions	Overall length: 330 mm (Tip: 16mm) Tip diameter: 5 mm (Body: 8 mm) Distance from probe tip to sensor centers: 2.5 mm
Application	General dosimetry up to 6 GHz Dosimetry in strong gradient fields Compliance tests of Mobile Phones



Isotropic E-Field Probe

The isotropic E-Field probe has been fully calibrated and assessed for isotropicity, and boundary effect within a controlled environment. Depending on the frequency for which the probe is calibrated the method utilized for calibration will change.

The E-Field probe utilizes a triangular sensor arrangement as detailed in the diagram below:

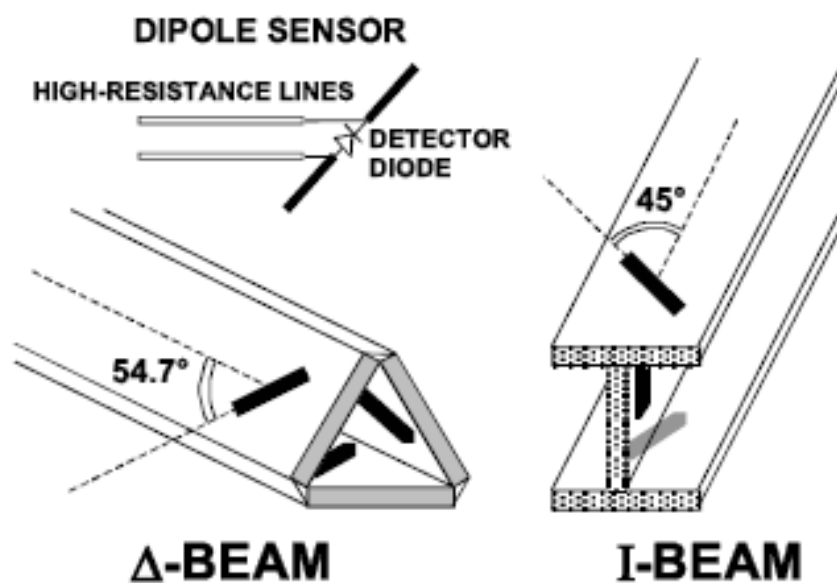

3.3. Phantoms

The SAM Phantom SAM117 is constructed of a fiberglass shell integrated in a wooden table. The shape of the shell is in compliance with the specification set in IEEE P1528 and CENELEC EN62209-1, EN62209-2:2010. The phantom enables the dosimetric evaluation of left and right hand phone usage as well as body mounted usage at the flat phantom region. A cover prevents the evaporation of the liquid. Reference markings on the Phantom allow the complete setup of all predefined phantom positions and measurement grids by manually teaching three points in the robot.

System checking was performed using the flat section, whilst Head SAR tests used the left and right head profile sections. Body SAR testing also used the flat section between the head profiles.

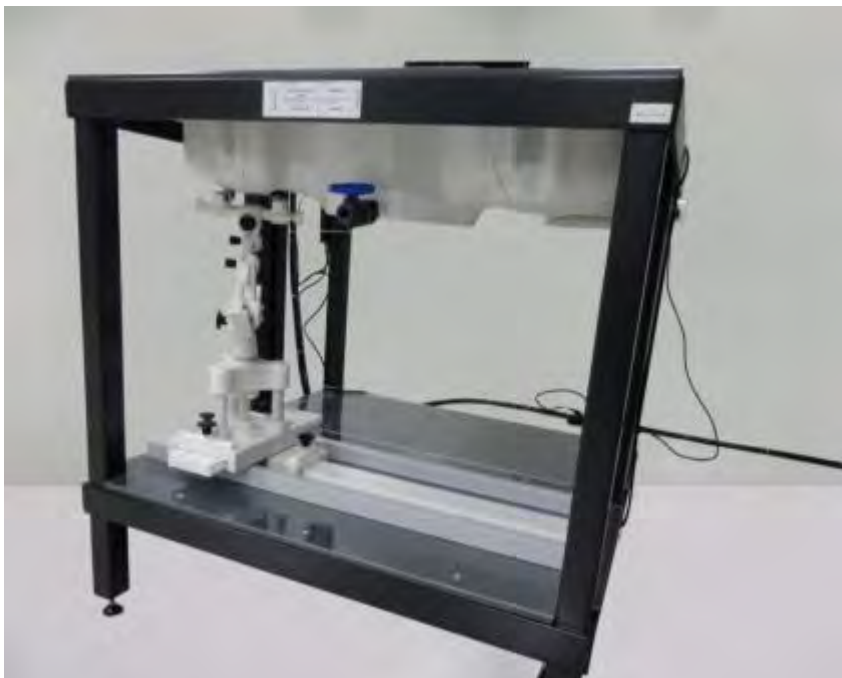

SAM Twin Phantom

3.4. Device Holder

In combination with the Generic Twin Phantom SAM117, the Mounting Device enables the rotation of the mounted transmitter in spherical coordinates whereby the rotation points is the ear opening. The devices can be easily, accurately, and repeatedly positioned according to the FCC and CENELEC specifications. The device holder can be locked at different phantom locations (left head, right head, flat phantom).



Device holder supplied by SATIMO

3.5. Scanning Procedure

The procedure for assessing the peak spatial-average SAR value consists of the following steps

Power Reference Measurement

The reference and drift jobs are useful jobs for monitoring the power drift of the device under test in the batch process. Both jobs measure the field at a specified reference position, at a selectable distance from the phantom surface. The reference position can be either the selected section's grid reference point or a user point in this section. The reference job projects the selected point onto the phantom surface, orients the probe perpendicularly to the surface, and approaches the surface using the selected detection method.

Area Scan

The Area Scan is used as a fast scan in two dimensions to find the area of high field values before running a detailed measurement around the hot spot. Before starting the area scan a grid spacing of 15 mm x 15 mm is set. During the scan the distance of the probe to the phantom remains unchanged. After finishing area scan, the field maxima within a range of 2 dB will be ascertained.

	≤ 3 GHz	> 3 GHz
Maximum distance from closest measurement point (geometric center of probe sensors) to phantom surface	5 mm ± 1 mm	$\frac{1}{2} \cdot \delta \cdot \ln(2)$ mm ± 0.5 mm
Maximum probe angle from probe axis to phantom surface normal at the measurement location	30° ± 1°	20° ± 1°
Maximum area scan spatial resolution: Δx_{Area} , Δy_{Area}	≤ 2 GHz: ≤ 15 mm 2 – 3 GHz: ≤ 12 mm	3 – 4 GHz: ≤ 12 mm 4 – 6 GHz: ≤ 10 mm
	When the x or y dimension of the test device, in the measurement plane orientation, is smaller than the above, the measurement resolution must be ≤ the corresponding x or y dimension of the test device with at least one measurement point on the test device.	

Zoom Scan

Zoom Scans are used to estimate the peak spatial SAR values within a cubic averaging volume containing 1 g and 10 g of simulated tissue. The default Zoom Scan is done by 7x7x7 points within a cube whose base is centered around the maxima found in the preceding area scan.

Maximum zoom scan spatial resolution: Δx_{Zoom} , Δy_{Zoom}		≤ 2 GHz: ≤ 8 mm 2 – 3 GHz: ≤ 5 mm*	3 – 4 GHz: ≤ 5 mm* 4 – 6 GHz: ≤ 4 mm*
Maximum zoom scan spatial resolution, normal to phantom surface	uniform grid: $\Delta z_{Zoom}(n)$	≤ 5 mm	3 – 4 GHz: ≤ 4 mm 4 – 5 GHz: ≤ 3 mm 5 – 6 GHz: ≤ 2 mm
	graded grid	$\Delta z_{Zoom}(1)$: between 1 st two points closest to phantom surface	≤ 4 mm 3 – 4 GHz: ≤ 3 mm 4 – 5 GHz: ≤ 2.5 mm 5 – 6 GHz: ≤ 2 mm
		$\Delta z_{Zoom}(n>1)$: between subsequent points	≤ 1.5 · $\Delta z_{Zoom}(n-1)$ mm
Minimum zoom scan volume	x, y, z	≥ 30 mm	3 – 4 GHz: ≥ 28 mm 4 – 5 GHz: ≥ 25 mm 5 – 6 GHz: ≥ 22 mm
Note: δ is the penetration depth of a plane-wave at normal incidence to the tissue medium; see IEEE Std 1528-2013 for details.			
* When zoom scan is required and the <i>reported</i> SAR from the <i>area scan based 1-g SAR estimation</i> procedures of KDB Publication 447498 is ≤ 1.4 W/kg, ≤ 8 mm, ≤ 7 mm and ≤ 5 mm zoom scan resolution may be applied, respectively, for 2 GHz to 3 GHz, 3 GHz to 4 GHz and 4 GHz to 6 GHz.			

Power Drift measurement

The drift job measures the field at the same location as the most recent reference job within the same procedure, and with the same settings. The drift measurement gives the field difference in dB from the reading conducted within the last reference measurement. Several drift measurements are possible for one reference measurement. This allows a user to monitor the power drift of the device under test within a batch process. In the properties of the Drift job, the user can specify a limit for the drift and have OPENSAR software stop the measurements if this limit is exceeded.

3.6. Data Storage and Evaluation

Data Storage

The OPENSAR software stores the acquired data from the data acquisition electronics as raw data (in microvolt readings from the probe sensors), together with all necessary software parameters for the data evaluation (probe calibration data, liquid parameters and device frequency and modulation data) in measurement files. The software evaluates the desired unit and format for output each time the data is visualized or exported. This allows verification of the complete software setup even after the measurement and allows correction of incorrect parameter settings. For example, if a measurement has been performed with a wrong crest factor parameter in the device setup, the parameter can be corrected afterwards and the data can be re-evaluated.

The measured data can be visualized or exported in different units or formats, depending on the selected probe type ([V/m], [A/m], [°C], [mW/g], [mW/cm²], [dBrel], etc.). Some of these units are not available in certain situations or show meaningless results, e.g., a SAR output in a lossless media will always be zero. Raw data can also be exported to perform the evaluation with other software packages.

Data Evaluation

The OPENSAR software automatically executes the following procedures to calculate the field units from the microvolt readings at the probe connector. The parameters used in the evaluation are stored in the configuration modules of the software:

Probe parameters:	- Sensitivity	Normi, ai0, ai1, ai2
	- Conversion factor	ConvFi
	- Diode compression point	Dcpi
Device parameters:	- Frequency	f
	- Crest factor	cf
Media parameters:	- Conductivity	σ
	- Density	ρ

These parameters must be set correctly in the software. They can be found in the component documents or they can be imported into the software from the configuration files issued for the OPENSAR components. In the direct measuring mode of the multimeter option, the parameters of the actual system setup are used. In the scan visualization and export modes, the parameters stored in the corresponding document files are used.

The first step of the evaluation is a linearization of the filtered input signal to account for the compression characteristics of the detector diode. The compensation depends on the input signal, the diode type and the DC-transmission factor from the diode to the evaluation electronics. If the exciting field is pulsed, the crest factor of the signal must be known to correctly compensate for peak power. The formula for each channel can be given as:

$$V_i = U_i + U_i^2 \cdot \frac{cf}{dcp_i}$$

With V_i = compensated signal of channel i ($i = x, y, z$)

U_i = input signal of channel i ($i = x, y, z$)

cf = crest factor of exciting field

dcp_i = diode compression point

From the compensated input signals the primary field data for each channel can be evaluated:

$$E - \text{fieldprobes} : E_i = \sqrt{\frac{V_i}{\text{Norm}_i \cdot \text{ConvF}}}$$

$$H - \text{fieldprobes} : H_i = \sqrt{V_i} \cdot \frac{a_{i0} + a_{i1}f + a_{i2}f^2}{f}$$

With V_i = compensated signal of channel i ($i = x, y, z$)

Norm_i = sensor sensitivity of channel i ($i = x, y, z$)
[mV/(V/m)²] for E-field Probes

ConvF = sensitivity enhancement in solution

- a_{ij} = sensor sensitivity factors for H-field probes
 f = carrier frequency [GHz]
 E_i = electric field strength of channel i in V/m
 H_i = magnetic field strength of channel i in A/m

The RSS value of the field components gives the total field strength (Hermitian magnitude):

$$E_{tot} = \sqrt{E_x^2 + E_y^2 + E_z^2}$$

The primary field data are used to calculate the derived field units.

$$SAR = E_{tot}^2 \cdot \frac{\sigma}{\rho \cdot 1'000}$$

- with SAR = local specific absorption rate in mW/g
 E_{tot} = total field strength in V/m
 σ = conductivity in [mho/m] or [Siemens/m]
 ρ = equivalent tissue density in g/cm³

Note that the density is normally set to 1 (or 1.06), to account for actual brain density rather than the density of the simulation liquid.

3.7. Position of the wireless device in relation to the phantom

General considerations

This standard specifies two handset test positions against the head phantom – the “cheek” position and the “tilt” position.

The power flow density is calculated assuming the excitation field as a free space field

$$P_{(pwe)} = \frac{E_{tot}^2}{3770} \text{ or } P_{(pwe)} = H_{tot}^2 \cdot 37.7$$

Where P_{pwe} = Equivalent power density of a plane wave in mW/cm²

E_{tot} = total electric field strength in V/m

H_{tot} = total magnetic field strength in A/m

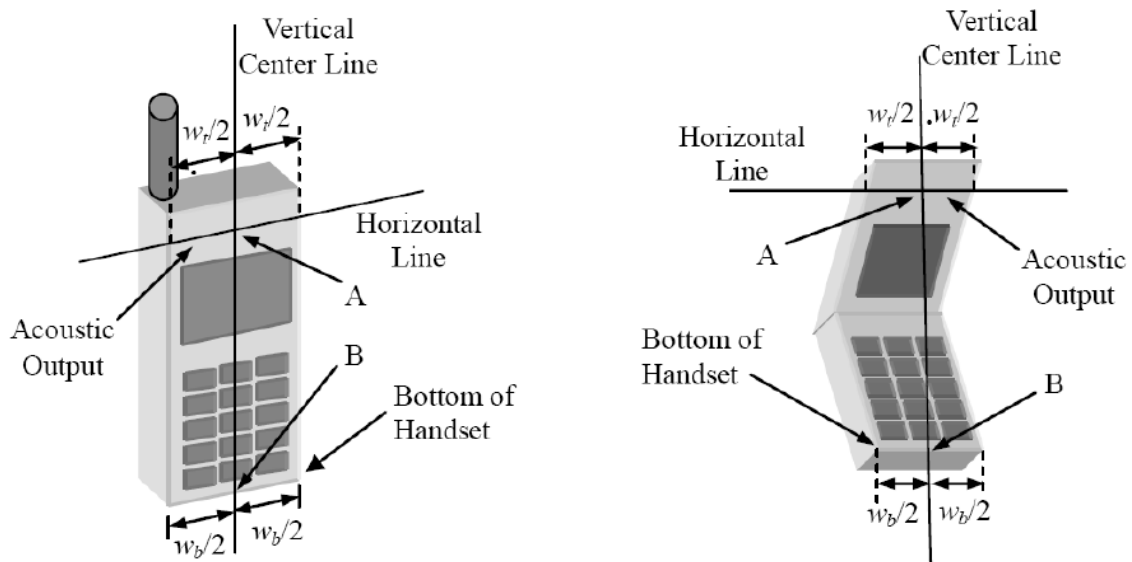

W_t Width of the handset at the level of the acoustic

W_b Width of the bottom of the handset

A Midpoint of the width w_r of the handset at the level of the acoustic output

B Midpoint of the width w_b of the bottom of the handset

Picture 1-a Typical “fixed” case handset Picture 1-b Typical “clam-shell” case handset

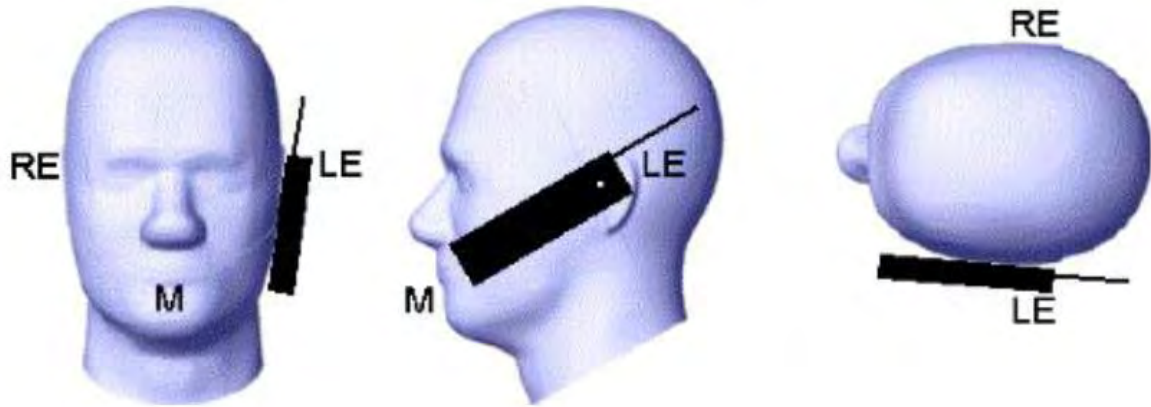

Picture 2 Cheek position of the wireless device on the left side of SAM

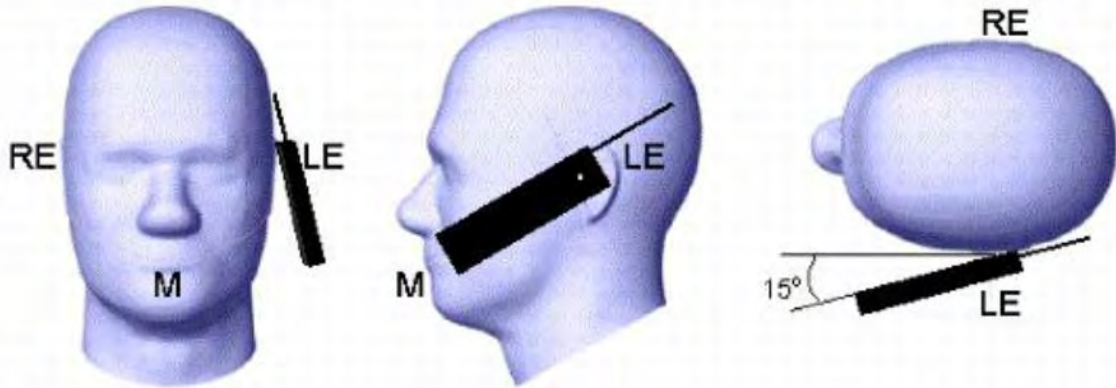

Picture 3 Tilt position of the wireless device on the left side of SAM

For body SAR test we applied to FCC KDB941225, KDB447498, KDB248227, KDB648654;

3.8. Tissue Dielectric Parameters for Head and Body Phantoms

The liquid is consisted of water,salt,Glycol,Sugar,Preventol and Cellulose.The liquid has previously been proven to be suited for worst-case.It's satisfying the latest tissue dielectric parameters requirements proposed by the KDB865664.

The composition of the tissue simulating liquid

Ingredient (% Weight)	750MHz		835MHz		1800 MHz		1900 MHz		2450MHz		2600MHz		5000MHz	
	Head	Body	Head	Body	Head	Body	Head	Body	Head	Body	Head	Body	Head	Body
Water	39.28	51.3	41.45	52.5	54.5	40.2	54.9	40.4	62.7	73.2	60.3	71.4	65.5	78.6
Preventol	0.10	0.10	0.10	0.10	0.00	0.00	0.00	0.00	0.00	0.00	0.00	0.00	0.00	0.00
HEC	1.00	1.00	1.00	1.00	0.00	0.00	0.00	0.00	0.00	0.00	0.00	0.00	0.00	0.00
DGBE	0.00	0.00	0.00	0.00	45.33	59.31	44.92	59.10	36.80	26.70	39.10	28.40	0.00	0.00
Triton X-100	0.00	0.00	0.00	0.00	0.00	0.00	0.00	0.00	0.00	0.00	0.00	0.00	17.2	10.7

Target Frequency (MHz)	Head		Body	
	ϵ_r	σ (S/m)	ϵ_r	σ (S/m)
150	52.3	0.76	61.9	0.80
300	45.3	0.87	58.2	0.92
450	43.5	0.87	56.7	0.94
835	41.5	0.90	55.2	0.97
900	41.5	0.97	55.0	1.05
915	41.5	0.98	55.0	1.06
1450	40.5	1.20	54.0	1.30
1610	40.3	1.29	53.8	1.40
1800-2000	40.0	1.40	53.3	1.52
2450	39.2	1.80	52.7	1.95
3000	38.5	2.40	52.0	2.73
5800	35.3	5.27	48.2	6.00

3.9. Tissue equivalent liquid properties

Dielectric Performance of Head and Body Tissue Simulating Liquid

Tissue Type	Measured Frequency (MHz)	Target Tissue		Measured Tissue				Liquid Temp.	Test Data
		σ	ϵ_r	σ	Dev.	ϵ_r	Dev.		
835H	835	0.90	41.50	0.88	-2.22%	41.92	1.01%	20.4	10/10/2018
1800H	1800	1.40	40.00	1.41	0.71%	39.65	-0.88%	21.1	10/12/2018
1900H	1900	1.40	40.00	1.42	1.43%	41.07	2.68%	20.6	10/16/2018
2450H	2450	1.80	39.20	1.78	-1.11%	39.51	0.79%	21.7	10/18/2018
2600H	2600	1.96	39.00	1.91	-2.55%	39.55	1.41%	20.3	10/22/2018
835B	835	0.97	55.20	0.96	-1.03%	54.61	-1.07%	21.2	10/11/2018
1800B	1800	1.52	53.30	1.54	1.32%	52.47	-1.56%	20.8	10/15/2018
1900B	1900	1.52	53.30	1.53	0.66%	54.71	2.65%	21.1	10/17/2018
2450B	2450	1.95	52.70	1.97	1.03%	51.54	-2.20%	20.6	10/19/2018
2600B	2600	2.16	52.50	2.18	0.93%	51.35	-2.19%	21.0	10/23/2018

3.10. System Check

The purpose of the system check is to verify that the system operates within its specifications at the device test frequency. The system check is simple check of repeatability to make sure that the system works correctly at the time of the compliance test;

System check results have to be equal or near the values determined during dipole calibration with the relevant liquids and test system ($\pm 10\%$).

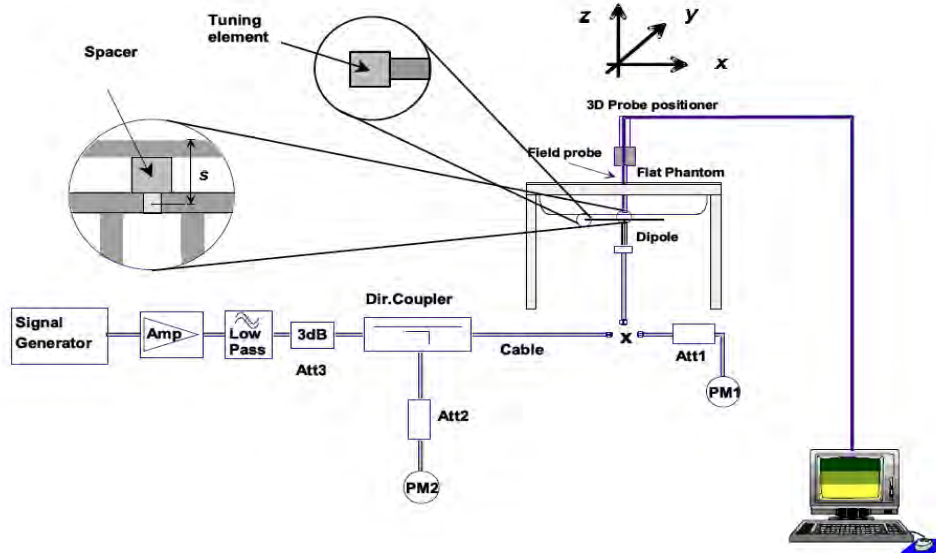

The output power on dipole port must be calibrated to 20 dBm (100mW) before dipole is connected.



Photo of Dipole Setup

Justification for Extended SAR Dipole Calibrations

Referring to KDB 865664D01V01r04, if dipoles are verified in return loss (<-20dB, within 20% of prior calibration), and in impedance (within 5 ohm of prior calibration), the annual calibration is not necessary and the calibration interval can be extended. While calibration intervals not exceed 3 years.

SID835 SN 07/14 DIP 0G835-303 Extend Dipole Calibrations

Date of Measurement	Return-Loss (dB)	Delta (%)	Real Impedance (ohm)	Delta (ohm)	Imaginary Impedance (ohm)	Delta (ohm)
2018-10-01	-24.49		54.9		2.8	

SID1800 SN 30/14 DIP 1G800-301 Extend Dipole Calibrations

Date of Measurement	Return-Loss (dB)	Delta (%)	Real Impedance (ohm)	Delta (ohm)	Imaginary Impedance (ohm)	Delta (ohm)
2018-10-01	-20.26		43.1		6.9	

SID1900 SN 30/14 DIP 1G900-333 Extend Dipole Calibrations

Date of Measurement	Return-Loss (dB)	Delta (%)	Real Impedance (ohm)	Delta (ohm)	Imaginary Impedance (ohm)	Delta (ohm)
2018-09-01	-22.98		50.9		6.7	

SID2450 SN 07/14 DIP 2G450-306 Extend Dipole Calibrations

Date of Measurement	Return-Loss (dB)	Delta (%)	Real Impedance (ohm)	Delta (ohm)	Imaginary Impedance (ohm)	Delta (ohm)
2018-10-01	-25.59		44.7		-1.1	

SID2600 SN 30/14 DIP 2G600-336 Extend Dipole Calibrations

Date of Measurement	Return-Loss (dB)	Delta (%)	Real Impedance (ohm)	Delta (ohm)	Imaginary Impedance (ohm)	Delta (ohm)
2018-09-01	-34.43		50.5		1.7	

Mixture Type	Frequency (MHz)	Power	SAR _{1g} (W/kg)	SAR _{10g} (W/kg)	Drift (%)	1W Target		Difference percentage		Liquid Temp	Date
						SAR _{1g} (W/kg)	SAR _{10g} (W/kg)	1g	10g		
Head	835	100 mW	0.919	0.638	-3.63	9.60	6.20	-4.27%	2.90%	20.4	10/10/2018
		Normalize to 1 Watt	9.19	6.38							
Body	835	100 mW	0.978	0.637	-0.68	9.90	6.39	-1.21%	-0.31%	21.2	10/11/2018
		Normalize to 1 Watt	9.78	6.37							
Head	1800	100 mW	3.838	2.015	-3.62	38.13	20.2	0.66%	-0.25%	21.1	10/12/2018
		Normalize to 1 Watt	38.38	20.15							
Body	1800	100 mW	4.078	2.136	-0.62	39.03	20.65	4.48%	3.44%	20.8	10/15/2018
		Normalize to 1 Watt	40.78	21.36							
Head	1900	100 mW	3.918	2.006	-1.07	39.84	20.20	-1.66%	-0.69%	20.6	10/16/2018
		Normalize to 1 Watt	39.18	20.06							
Body	1900	100 mW	4.275	2.117	3.20	43.33	21.59	-1.34%	-1.95%	21.1	10/17/2018
		Normalize to 1 Watt	42.75	21.17							
Head	2450	100 mW	5.256	2.384	-1.33	53.89	24.15	-2.47%	-1.28%	21.7	10/18/2018
		Normalize to 1 Watt	52.56	23.84							
Body	2450	100 mW	5.244	2.387	-0.25	54.65	24.58	-4.04%	-2.89%	20.6	10/19/2018
		Normalize to 1 Watt	52.44	23.87							
Head	2600	100 mW	5.475	2.346	1.21	56.19	24.08	-2.56%	-2.57%	20.3	10/22/2018
		Normalize to 1 Watt	54.75	23.46							
Body	2600	100 mW	5.587	2.436	-4.30	57.49	24.88	-2.84%	-2.09%	21.0	10/23/2018
		Normalize to 1 Watt	55.87	24.36							

3.11. SAR measurement procedure

The measurement procedures are as follows:

3.11.1 Conducted power measurement

- For WWAN power measurement, use base station simulator connection with RF cable, at maximum power in each supported wireless interface and frequency band.
- Read the WWAN RF power level from the base station simulator.
- For WLAN/BT power measurement, use engineering software to configure EUT WLAN/BT continuously Transmission, at maximum RF power in each supported wireless interface and frequency band.
- Connect EUT RF port through RF cable to the power meter, and measure WLAN/BT output power.

3.11.2 GSM Test Configuration

SAR tests for GSM 850 and GSM 1900, a communication link is set up with a System Simulator (SS) by air link. Using CMU200 the power level is set to "5" for GSM 850, set to "0" for GSM 1900. Since the GPRS class is 12 for this EUT, it has at most 4 timeslots in uplink and at most 4 timeslots in downlink, the maximum total timeslots is 5. the EGPRS class is 12 for this EUT, it has at most 4 timeslots in uplink and at most 4 timeslots in downlink, the maximum total timeslots is 5.

SAR test reduction for GPRS and EDGE modes is determined by the source-based time-averaged output power specified for production units, including tune-up tolerance. The data mode with highest specified time-averaged output power should be tested for SAR compliance in the applicable exposure conditions. For modes with the same specified maximum output power and tolerance, the higher number time-slot configuration should be tested. GSM voice and GPRS data use GMSK, which is a constant amplitude modulation with minimal peak to average power difference within the time-slot burst. For EDGE, GMSK is used for MCS 1 – MCS 4 and 8-PSK is used for MCS 5 – MCS 9; where 8-PSK has an inherently higher peak-to-average power ratio. The GMSK and 8-PSK EDGE configurations are considered separately for SAR compliance. The GMSK EDGE configurations are grouped with GPRS and considered with respect to time-averaged maximum output power to determine compliance. The 3G SAR test reduction procedure is applied to 8-PSK EDGE with GMSK GPRS/EDGE as the primary mode.

3.11.3 UMTS Test Configuration

3G SAR Test Reduction Procedure

In the following procedures, the mode tested for SAR is referred to as the primary mode. The equivalent modes considered for SAR test reduction are denoted as secondary modes. Both primary and secondary modes must be in the same frequency band. When the maximum output power and tune-up tolerance specified for production

units in a secondary mode is $\leq \frac{1}{4}$ dB higher than the primary mode or when the highest reported SAR of the primary mode is scaled by the ratio of specified maximum output power and tune-up tolerance of secondary to primary mode and the adjusted SAR is ≤ 1.2 W/kg, SAR measurement is not required for the secondary mode.³ This is referred to as the 3G SAR test reduction procedure in the following SAR test guidance, where the primary mode is identified in the applicable wireless mode test procedures and the secondary mode is wireless mode being considered for SAR test reduction by that procedure. When the 3G SAR test reduction procedure is not satisfied, it is identified as “otherwise” in the applicable procedures; SAR measurement is required for the secondary mode.

Output power Verification

Maximum output power is verified on the high, middle and low channels according to procedures described in section 5.2 of 3GPP TS 34.121, using the appropriate RMC or AMR with TPC (transmit power control) set to all “1’s” for WCDMA/HSDPA or by applying the required inner loop power control procedures to maintain maximum output power while HSUPA is active. Results for all applicable physical channel configurations (DPCCH, DPDCHn and spreading codes, HSDPA, HSPA) are required in the SAR report. All configurations that are not supported by the handset or cannot be measured due to technical or equipment limitations must be clearly identified.

Head SAR

SAR for next to the ear head exposure is measured using a 12.2 kbps RMC with TPC bits configured to all “1’s”. The 3G SAR test reduction procedure is applied to AMR configurations with 12.2 kbps RMC as the primary mode. Otherwise, SAR is measured for 12.2 kbps AMR in 3.4 kbps SRB (signaling radio bearer) using the highest reported SAR configuration in 12.2 kbps RMC for head exposure.

1) Body-Worn Accessory SAR

SAR for body-worn accessory configurations is measured using a 12.2 kbps RMC with TPC bits configured to all “1’s”. The 3G SAR test reduction procedure is applied to other spreading codes and multiple DPDCHn configurations supported by the handset with 12.2 kbps RMC as the primary mode. Otherwise, SAR is measured using an applicable RMC configuration with the corresponding spreading code or DPDCHn, for the highest reported body-worn accessory exposure SAR configuration in 12.2 kbps RMC. When more than 2 DPDCHn are supported by the handset, it may be necessary to configure additional DPDCHn using FTM (Factory Test Mode) or other chipset based test approaches with parameters similar to those used in 384 kbps and 768 kbps RMC.

2) Handsets with Release 5 HSDPA

The 3G SAR test reduction procedure is applied to HSDPA body-worn accessory configurations with 12.2 kbps RMC as the primary mode. Otherwise, SAR is measured for HSDPA using the HSDPA body SAR procedures in the “Release 5 HSDPA Data Devices” section of this document, for the highest reported SAR body-worn accessory exposure configuration in 12.2 kbps RMC. Handsets with both HSDPA and HSUPA are tested according to Release 6 HSPA test procedures.

HSDPA should be configured according to the UE category of a test device. The number of HSDSCH/ HS-PDSCHs, HARQ processes, minimum inter-TTI interval, transport block sizes and RV coding sequence are defined by the H-set. To maintain a consistent test configuration and stable transmission conditions, QPSK is used in the H-set for SAR testing. HS-DPCCH should be configured with a CQI feedback cycle of 4 ms with a CQI repetition factor of 2 to maintain a constant rate of active CQI slots. DPCCH and DPDCH gain factors (β_c , β_d), and HS-DPCCH power offset parameters (Δ_{ACK} , Δ_{NACK} , Δ_{CQI}) should be set according to values indicated in the Table below. The CQI value is determined by the UE category, transport block size, number of HS-PDSCHs and modulation used in the H-set

Table 2: Subtests for UMTS Release 5 HSDPA

Sub-set	β_c	β_d	β_d (SF)	β_c/β_d	β_{hs} (note 1, note 2)	CM(dB) (note 3)	MPR(dB)
1	2/15	15/15	64	2/15	4/15	0.0	0.0
2	12/15 (note 4)	15/15 (note 4)	64	12/15 (note 4)	24/15	1.0	0.0
3	15/15	8/15	64	15/8	30/15	1.5	0.5
4	15/15	4/15	64	15/4	30/15	1.5	0.5

Note1: Δ_{ACK} , Δ_{NACK} and $\Delta_{CQI} = 8 \Leftrightarrow A_{hs} = \beta_{hs}/\beta_c = 30/15 \Leftrightarrow \beta_{hs} = 30/15 * \beta_c$

Note2: CM=1 for $\beta_c/\beta_d = 12/15$, $\beta_{hs}/\beta_c = 24/15$.

Note3: For subtest 2 the β_c/β_d ratio of 12/15 for the TFC during the measurement period (TF1, TF0) is achieved by setting the signaled gain factors for the reference TFC (TFC1, TF1) to $\beta_c = 11/15$ and $\beta_d = 15/15$.

HSUPA Test Configuration

The 3G SAR test reduction procedure is applied to HSPA (HSUPA/HSDPA with RMC) body-worn accessory configurations with 12.2 kbps RMC as the primary mode. Otherwise, SAR is measured for HSPA using the HSPA body SAR procedures in the "Release 6 HSPA Data Devices" section of this document, for the highest reported body-worn accessory exposure SAR configuration in 12.2 kbps RMC. When VOIP is applicable for next to the ear head exposure in HSPA, the 3G SAR test reduction procedure is applied to HSPA with 12.2 kbps RMC as the primary mode; otherwise, the same HSPA configuration used for body-worn accessory measurements is tested for next to the ear head exposure.

Due to inner loop power control requirements in HSPA, a communication test set is required for output power and SAR tests. The 12.2 kbps RMC, FRC H-set 1 and E-DCH configurations for HSPA are configured according to the β values indicated in Table 2 and other applicable procedures described in the 'WCDMA Handset' and 'Release 5 HSDPA Data Devices' sections of this document

Table 3: Sub-Test 5 Setup for Release 6 HSUPA

Sub-set	β_c	β_d	β_d (SF)	β_c/β_d	$\beta_{hs}^{(1)}$	β_{ec}	β_{ed}	β_{ed} (SF)	β_{ed} (codes)	CM ⁽²⁾ (dB)	MPR (dB)	AG ⁽⁴⁾ Index	E-TFCI
1	11/15 ⁽³⁾	15/15 ⁽³⁾	64	11/15 ⁽³⁾	22/15	209/225	1039/225	4	1	1.0	0.0	20	75
2	6/15	15/15	64	6/15	12/15	12/15	94/75	4	1	3.0	2.0	12	67
3	15/15	9/15	64	15/9	30/15	30/15	$\beta_{ed1} = 47/15$ $\beta_{ed2} = 47/15$	4	2	2.0	1.0	15	92
4	2/15	15/15	64	2/15	4/15	2/15	56/75	4	1	3.0	2.0	17	71
5	15/15 ⁽⁴⁾	15/15 ⁽⁴⁾	64	15/15 ⁽⁴⁾	30/15	24/15	134/15	4	1	1.0	0.0	21	81

Note 1: Δ_{ACK} , Δ_{NACK} and $\Delta_{CQI} = 8 \Leftrightarrow A_{hs} = \beta_{hs}/\beta_c = 30/15 \Leftrightarrow \beta_{hs} = 30/15 * \beta_c$.

Note 2: CM = 1 for $\beta_c/\beta_d = 12/15$, $\beta_{hs}/\beta_c = 24/15$. For all other combinations of DPDCH, DPCCH, HS-DPCCH, E-DPDCH and E-DPCCH the MPR is based on the relative CM difference.

Note 3: For subtest 1 the β_c/β_d ratio of 11/15 for the TFC during the measurement period (TF1, TF0) is achieved by setting the signaled gain factors for the reference TFC (TF1, TF1) to $\beta_c = 10/15$ and $\beta_d = 15/15$.

Note 4: For subtest 5 the β_c/β_d ratio of 15/15 for the TFC during the measurement period (TF1, TF0) is achieved by setting the signaled gain factors for the reference TFC (TF1, TF1) to $\beta_c = 14/15$ and $\beta_d = 15/15$.

Note 5: Testing UE using E-DPDCH Physical Layer category 1 Sub-test 3 is not required according to TS 25.306 Figure 5.1g.

Note 6: β_{ed} can not be set directly; it is set by Absolute Grant Value.

3.11.4 LTE Test Configuration

QPSK with 1 RB allocation

Start with the largest channel bandwidth and measure SAR for QPSK with 1 RB allocation, using the RB offset and required test channel combination with the highest maximum output power among RB offsets at the upper edge, middle and lower edge of each required test channel. When the reported SAR is ≤ 0.8 W/kg, testing of the remaining RB offset configurations and required test channels is not required for 1 RB allocation; otherwise, SAR is required for the remaining required test channels and only for the RB offset configuration with the highest output power for that channel.8 When the reported SAR of a required test channel is > 1.45 W/kg, SAR is required for all three RB offset configurations for that required test channel.

QPSK with 50% RB allocation

The procedures required for 1 RB allocation in section 4.2.1 are applied to measure the SAR for QPSK with 50% RB allocation.9

QPSK with 100% RB allocation

For QPSK with 100% RB allocation, SAR is not required when the highest maximum output power for 100 % RB allocation is less than the highest maximum output power in 50% and 1 RB allocations and the highest reported SAR for 1 RB and 50% RB allocation in sections 4.2.1 and 4.2.2 are ≤ 0.8 W/kg. Otherwise, SAR is measured for the highest output power channel; and if the reported SAR is > 1.45 W/kg, the remaining required test channels must also be tested.

3.11.5 WIFI Test Configuration

The SAR measurement and test reduction procedures are structured according to either the DSSS or OFDM transmission mode configurations used in each standalone frequency band and aggregated band. For devices that operate in exposure configurations that require multiple test positions, additional SAR test reduction may be applied. The maximum output power specified for production units, including tune-up tolerance, are used to determine initial SAR test requirements for the 802.11 transmission modes in a frequency band. SAR is measured using the highest measured maximum output power channel for the initial test configuration. SAR measurement and test reduction for the remaining 802.11 modes and test channels are determined according to measured or specified maximum output power and reported SAR of the initial measurements. The general test reduction and SAR measurement approaches are summarized in the following:

1. The maximum output power specified for production units are determined for all applicable 802.11 transmission modes in each standalone and aggregated frequency band. Maximum output power is measured for the highest maximum output power configuration(s) in each frequency band according to the default power measurement procedures.
2. For OFDM transmission configurations in the 2.4 GHz and 5 GHz bands, an "initial test configuration" is first determined for each standalone and aggregated frequency band according to the maximum output power and tune-up tolerance specified for production units.
 - a. When the same maximum power is specified for multiple transmission modes in a frequency band, the largest channel bandwidth, lowest order modulation, lowest data rate and lowest order 802.11a/g/n/ac mode is used for SAR measurement, on the highest measured output power channel in the initial test configuration, for each frequency band.
 - b. SAR is measured for OFDM configurations using the initial test configuration procedures. Additional frequency band specific SAR test reduction may be considered for individual frequency bands
 - c. Depending on the reported SAR of the highest maximum output power channel tested in the initial test configuration, SAR test reduction may apply to subsequent highest output channels in the initial test configuration to reduce the number of SAR measurements.
3. The Initial test configuration does not apply to DSSS. The 2.4 GHz band SAR test requirements and 802.11b DSSS procedures are used to establish the transmission configurations required for SAR measurement.
4. An "initial test position" is applied to further reduce the number of SAR tests for devices operating in next to the ear, UMPC mini-tablet or hotspot mode exposure configurations that require multiple test positions .
 - a. SAR is measured for 802.11b according to the 2.4 GHz DSSS procedure using the exposure condition established by the initial test position.
 - b. SAR is measured for 2.4 GHz and 5 GHz OFDM configurations using the initial test configuration. 802.11b/g/n operating modes are tested independently according to the service requirements in each frequency band. 802.11b/g/n modes are tested on the maximum average output channel.
5. The Initial test position does not apply to devices that require a fixed exposure test position. SAR is measured in a fixed exposure test position for these devices in 802.11b according to the 2.4 GHz DSSS procedure or in 2.4 GHz and 5 GHz OFDM configurations using the initial test configuration procedures .
6. The "subsequent test configuration" procedures are applied to determine if additional SAR measurements are required for the remaining OFDM transmission modes that have not been tested in the initial test configuration. SAR test exclusion is determined according to reported SAR in the initial test configuration and maximum output power specified or measured for these other OFDM configurations.

2.4 GHz and 5GHz SAR Procedures

Separate SAR procedures are applied to DSSS and OFDM configurations in the 2.4 GHz band to simplify DSSS test requirements. For 802.11b DSSS SAR measurements, DSSS SAR procedure applies to fixed exposure test position and initial test position procedure applies to multiple exposure test positions. When SAR measurement is required for an OFDM configuration, the initial test configuration, subsequent test configuration and initial test position procedures are applied. The SAR test exclusion requirements for 802.11g/n OFDM configurations are described in section 5.2.2.

1. 802.11b DSSS SAR Test Requirements

SAR is measured for 2.4 GHz 802.11b DSSS using either a fixed test position or, when applicable, the initial test position procedure. SAR test reduction is determined according to the following:

- a. When the reported SAR of the highest measured maximum output power channel (section 3.1) for the exposure configuration is ≤ 0.8 W/kg, no further SAR testing is required for 802.11b DSSS in that exposure configuration.
- b. When the reported SAR is > 0.8 W/kg, SAR is required for that exposure configuration using the next highest measured output power channel. When any reported SAR is > 1.2 W/kg, SAR is required for the third channel; i.e., all channels require testing.

1. 2.4 GHz 802.11g/n OFDM SAR Test Exclusion Requirements

When SAR measurement is required for 2.4 GHz 802.11g/n OFDM configurations, the measurement and test reduction procedures for OFDM are applied (section 5.3). SAR is not required for the following 2.4 GHz OFDM conditions.

- a. When KDB Publication 447498 SAR test exclusion applies to the OFDM configuration
 - b. When the highest reported SAR for DSSS is adjusted by the ratio of OFDM to DSSS specified maximum output power and the adjusted SAR is ≤ 1.2 W/kg.
2. SAR Test Requirements for OFDM Configurations

When SAR measurement is required for 802.11 a/g/n/ac OFDM configurations, each standalone and frequency aggregated band is considered separately for SAR test reduction. When the same transmitter and antenna(s) are used for U-NII-1 and U-NII-2A bands, additional SAR test reduction applies. When band gap channels between U-NII-2C band and 5.8 GHz U-NII-3 or §15.247 band are supported, the highest maximum output power transmission mode configuration and maximum output power channel across the bands must be used to determine SAR test reduction, according to the initial test configuration and subsequent test configuration requirements.²⁰ In applying the initial test configuration and subsequent test configuration procedures, the 802.11 transmission configuration with the highest specified maximum output power and the channel within a test configuration with the highest measured maximum output power should be clearly distinguished to apply the procedures.

3. OFDM Transmission Mode SAR Test Configuration and Channel Selection Requirements

The initial test configuration for 2.4 GHz and 5 GHz OFDM transmission modes is determined by the 802.11 configuration with the highest maximum output power specified for production units, including tune-up tolerance, in each standalone and aggregated frequency band. SAR for the initial test configuration is measured using the highest maximum output power channel determined by the default power measurement procedures (section 4). When multiple configurations in a frequency band have the same specified maximum output power, the initial test configuration is determined according to the following steps applied sequentially.

- a. The largest channel bandwidth configuration is selected among the multiple configurations with the same specified maximum output power.
- b. If multiple configurations have the same specified maximum output power and largest channel bandwidth, the lowest order modulation among the largest channel bandwidth configurations is selected.
- c. If multiple configurations have the same specified maximum output power, largest channel bandwidth and lowest order modulation, the lowest data rate configuration among these configurations is selected.
- d. When multiple transmission modes (802.11a/g/n/ac) have the same specified maximum output power, largest channel bandwidth, lowest order modulation and lowest data rate, the lowest order 802.11 mode is selected; i.e., 802.11a is chosen over 802.11n then 802.11ac or 802.11g is chosen over 802.11n.

After an initial test configuration is determined, if multiple test channels have the same measured maximum output power, the channel chosen for SAR measurement is determined according to the following. These channel selection procedures apply to both the initial test configuration and subsequent test configuration(s), with respect to the default power measurement procedures or additional power measurements required for further SAR test reduction. The same procedures also apply to subsequent highest output power channel(s) selection.

- a. Channels with measured maximum output power within $\frac{1}{4}$ dB of each other are considered to have the same maximum output.
- b. When there are multiple test channels with the same measured maximum output power, the channel closest to mid-band frequency is selected for SAR measurement.
- c. When there are multiple test channels with the same measured maximum output power and equal separation from mid-band frequency; for example, high and low channels or two mid-band channels, the higher frequency (number) channel is selected for SAR measurement.

Initial Test Configuration Procedures

An initial test configuration is determined for OFDM transmission modes according to the channel bandwidth, modulation and data rate combination(s) with the highest maximum output power specified for production units in each standalone and aggregated frequency band. SAR is measured using the highest measured maximum output power channel. For configurations with the same specified or measured maximum output power, additional transmission mode and test channel selection procedures are required (see section 5.3.2). SAR test reduction of subsequent highest output test channels is based on the reported SAR of the initial test configuration. For next to the ear, hotspot mode and UMC mini-tablet exposure configurations where multiple test positions are required, the initial test position procedure is applied to minimize the number of test positions required for SAR measurement using the initial test configuration transmission mode.²³ For fixed exposure conditions that do not have multiple SAR test positions, SAR is measured in the transmission mode determined by the initial test configuration. When the reported SAR of the initial test configuration is > 0.8 W/kg, SAR measurement is required for the subsequent next highest measured output power channel(s) in the initial test configuration until the reported SAR is ≤ 1.2 W/kg or all required channels are tested.

4. Subsequent Test Configuration Procedures

SAR measurement requirements for the remaining 802.11 transmission mode configurations that have not been tested in the initial test configuration are determined separately for each standalone and aggregated frequency band, in each exposure condition, according to the maximum output power specified for production units. The initial test position procedure is applied to next to the ear, UMPC mini-tablet and hotspot mode configurations. When the same maximum output power is specified for multiple transmission modes, the procedures in section 5.3.2 are applied to determine the test configuration. Additional power measurements may be required to determine if SAR measurements are required for subsequent highest output power channels in a subsequent test

configuration. The subsequent test configuration and SAR measurement procedures are described in the following.

- a. When SAR test exclusion provisions of KDB Publication 447498 are applicable and SAR measurement is not required for the initial test configuration, SAR is also not required for the next highest maximum output power transmission mode subsequent test configuration(s) in that frequency band or aggregated band and exposure configuration.
- b. When the highest reported SAR for the initial test configuration (when applicable, include subsequent highest output channels), according to the initial test position or fixed exposure position requirements, is adjusted by the ratio of the subsequent test configuration to initial test configuration specified maximum output power and the adjusted SAR is ≤ 1.2 W/kg, SAR is not required for that subsequent test configuration.
- c. The number of channels in the initial test configuration and subsequent test configuration can be different due to differences in channel bandwidth. When SAR measurement is required for a subsequent test configuration and the channel bandwidth is smaller than that in the initial test configuration, all channels in the subsequent test configuration that overlap with the larger bandwidth channel tested in the initial test configuration should be used to determine the highest maximum output power channel. This step requires additional power measurement to identify the highest maximum output power channel in the subsequent test configuration to determine SAR test reduction.
 - 1). SAR should first be measured for the channel with highest measured output power in the subsequent test configuration.
 - 2). SAR for subsequent highest measured maximum output power channels in the subsequent test configuration is required only when the reported SAR of the preceding higher maximum output power channel(s) in the subsequent test configuration is > 1.2 W/kg or until all required channels are tested.
 - a) For channels with the same measured maximum output power, SAR should be measured using the channel closest to the center frequency of the larger channel bandwidth channel in the initial test configuration.
 - d. SAR measurements for the remaining highest specified maximum output power OFDM transmission mode configurations that have not been tested in the initial test configuration (highest maximum output) or subsequent test configuration(s) (subsequent next highest maximum output power) is determined by applying the subsequent test configuration procedures in this section to the remaining configurations according to the following:
 - 1) replace "subsequent test configuration" with "next subsequent test configuration" (i.e., subsequent next highest specified maximum output power configuration)
 - 2) replace "initial test configuration" with "all tested higher output power configurations."

3.12. Power Reduction

The product without any power reduction.

3.13. Power Drift

To control the output power stability during the SAR test, SAR system calculates the power drift by measuring the E-field at the same location at the beginning and at the end of the measurement for each test position. This ensures that the power drift during one measurement is within 5%.

4. TEST CONDITIONS AND RESULTS

4.1. Conducted Power Results

According KDB 447498 D01 General RF Exposure Guidance v06 Section 4.1 2) states that "Unless it is specified differently in the published RF exposure KDB procedures, these requirements also apply to test reduction and test exclusion considerations. Time-averaged maximum conducted output power applies to SAR and, as required by § 2.1091(c), time-averaged ERP applies to MPE. When an antenna port is not available on the device to support conducted power measurement, such as FRS and certain Part 15 transmitters with built-in integral antennas, the maximum output power allowed for production units should be used to determine RF exposure test exclusion and compliance."

<GSM Conducted Power>

General Note:

1. Per KDB 447498 D01v06, the maximum output power channel is used for SAR testing and for further SAR test reduction.
2. According to October 2013TCB Workshop, for GSM / GPRS / EGPRS, the number of time slots to test for SAR should correspond to the highest frame-average maximum output power configuration, considering the possibility of e.g. 3rd party VoIP operation for head and body-worn SAR testing, the EUT was set in GPRS (3Tx slot) for GSM850/GSM1900 band due to their highest frame-average power.
3. For hotspot mode SAR testing, GPRS / EDGE should be evaluated, therefore the EUT was set in GPRS (3 Tx slots) for GSM850/GSM1900 band due to its highest frame-average power.

<SIM1>

Conducted power measurement results for GSM850/PCS1900

GSM 850		Tune-up	Burst Conducted power (dBm)			Division Factors	Tune-up	Average power (dBm)		
			Channel/Frequency(MHz)					Channel/Frequency(MHz)		
		Max	128/824.2	190/836.6	251/848.8		Max	128/824.2	190/836.6	251/848.8
GSM		33.00	32.50	32.47	32.51	-9.03dB	23.97	23.47	23.44	23.48
GPRS (GMSK)	1TX slot	32.50	32.29	32.30	32.35	-9.03dB	23.47	23.26	23.27	23.32
	2TX slot	31.50	31.00	31.03	30.84	-6.02dB	25.48	24.98	25.01	24.82
	3TX slot	30.00	29.48	29.51	29.72	-4.26dB	25.74	25.22	25.25	25.46
	4TX slot	28.50	27.98	27.98	28.23	-3.01dB	25.49	24.97	24.97	25.22
EDGE (8PSK)	1TX slot	26.50	25.99	26.00	26.35	-9.03dB	17.47	16.96	16.97	17.32
	2TX slot	25.00	24.52	24.51	24.13	-6.02dB	18.98	18.50	18.49	18.11
	3TX slot	23.50	23.02	22.97	22.57	-4.26dB	19.24	18.76	18.71	18.31
	4TX slot	22.00	21.51	21.47	21.08	-3.01dB	18.99	18.50	18.46	18.07
GSM 1900		Tune-up	Burst Conducted power (dBm)			Division Factors	Tune-up	Average power (dBm)		
			Channel/Frequency(MHz)					Channel/Frequency(MHz)		
		Max	512/1850.2	661/1880	810/1909.8		Max.	512/1850.2	661/1880	810/1909.8
GSM		30.00	29.53	29.57	29.53	-9.03dB	20.97	20.50	20.54	20.50
GPRS (GMSK)	1TX slot	29.50	29.40	29.39	29.37	-9.03dB	20.47	20.37	20.36	20.34
	2TX slot	28.50	27.99	28.01	27.74	-6.02dB	22.48	21.97	21.99	21.72
	3TX slot	27.00	26.52	26.51	26.81	-4.26dB	22.74	22.26	22.25	22.55
	4TX slot	25.50	25.02	25.02	25.32	-3.01dB	22.49	22.01	22.01	22.31
EDGE (8PSK)	1TX slot	26.00	25.48	25.53	25.77	-9.03dB	16.97	16.45	16.50	16.74
	2TX slot	24.00	23.98	23.98	23.56	-6.02dB	17.98	17.96	17.96	17.54
	3TX slot	23.00	22.50	22.49	22.13	-4.26dB	18.74	18.24	18.23	17.87
	4TX slot	21.50	20.99	21.03	20.58	-3.01dB	18.49	17.98	18.02	17.57

<SIM2>

GSM 850		Burst Average Conducted power (dBm)		
		Channel/Frequency(MHz)		
		128/824.2	190/836.6	251/848.8
GSM		32.43	32.42	32.41
GPRS (GMSK)	1TX slot	32.33	32.29	32.20
	2TX slot	30.81	30.77	30.56
	3TX slot	29.33	29.30	29.26
	4TX slot	27.78	27.77	27.73
EDGE (8PSK)	1TX slot	25.78	25.79	25.78
	2TX slot	24.32	24.31	23.94
	3TX slot	22.81	22.78	22.37
	4TX slot	21.28	21.29	20.87
GSM 1900		Burst Average Conducted power (dBm)		
		Channel/Frequency(MHz)		
		512/1850.2	661/1880	810/1909.8
GSM		29.44	29.42	29.44
GPRS (GMSK)	1TX slot	29.33	29.29	29.09
	2TX slot	27.78	27.78	27.55
	3TX slot	26.30	26.28	26.25
	4TX slot	24.79	24.82	24.85
EDGE (8PSK)	1TX slot	25.31	25.29	25.28
	2TX slot	23.82	23.83	23.46
	3TX slot	22.31	22.28	21.94
	4TX slot	20.81	20.79	20.47

Notes:

1. Division Factors

To average the power, the division factor is as follows:

1TX-slot = 1 transmit time slot out of 8 time slots=> conducted power divided by (8/1) => -9.00dB

2TX-slots = 2 transmit time slots out of 8 time slots=> conducted power divided by (8/2) => -6.00dB

3TX-slots = 3 transmit time slots out of 8 time slots=> conducted power divided by (8/3) => -4.26dB

4TX-slots = 4 transmit time slots out of 8 time slots=> conducted power divided by (8/4) => -3.00dB

2. According to the conducted power as above, the GPRS measurements are performed with 3Txslot for GPRS850 and 3Txslot GPRS1900.

<UMTS Conducted Power>

The following tests were conducted according to the test requirements outlines in 3GPP TS 34.121 specification. A summary of these settings are illustrated below:

HSDPA Setup Configuration:

- a. The EUT was connected to Base Station E5515C referred to the Setup Configuration.
- b. The RF path losses were compensated into the measurements.
- c. A call was established between EUT and Base Station with following setting:
 - i. Set Gain Factors (β_c and β_d) and parameters were set according to each
 - ii. Specific sub-test in the following table, C10.1.4, quoted from the TS 34.121
 - iii. Set RMC 12.2Kbps + HSDPA mode.
 - iv. Set Cell Power = -86 dBm
 - v. Set HS-DSCH Configuration Type to FRC (H-set 1, QPSK)
 - vi. Select HSDPA Uplink Parameters
 - vii. Set Delta ACK, Delta NACK and Delta CQI = 8
 - viii. Set Ack-Nack Repetition Factor to 3
 - ix. Set CQI Feedback Cycle (k) to 4 ms
 - x. Set CQI Repetition Factor to 2
 - xi. Power Ctrl Mode = All Up bits
- d. The transmitted maximum output power was recorded.

Table C.10.1.4: β values for transmitter characteristics tests with HS-DPCCH

Sub-test	β_c	β_d	β_d (SF)	β_c/β_d	β_{HS} (Note 1, Note 2)	CM (dB) (Note 3)	MPR (dB) (Note 3)
1	2/15	15/15	64	2/15	4/15	0.0	0.0
2	12/15 (Note 4)	15/15 (Note 4)	64	12/15 (Note 4)	24/15	1.0	0.0
3	15/15	8/15	64	15/8	30/15	1.5	0.5
4	15/15	4/15	64	15/4	30/15	1.5	0.5

Note 1: Δ_{ACK} , Δ_{NACK} and $\Delta_{CQI} = 30/15$ with $\beta_{HS} = 30/15 * \beta_c$.

Note 2: For the HS-DPCCH power mask requirement test in clause 5.2C, 5.7A, and the Error Vector Magnitude (EVM) with HS-DPCCH test in clause 5.13.1A, and HSDPA EVM with phase discontinuity in clause 5.13.1AA, Δ_{ACK} and $\Delta_{NACK} = 30/15$ with $\beta_{HS} = 30/15 * \beta_c$, and $\Delta_{CQI} = 24/15$ with $\beta_{HS} = 24/15 * \beta_c$.

Note 3: CM = 1 for $\beta_c/\beta_d = 12/15$, $\beta_{HS}/\beta_c = 24/15$. For all other combinations of DPDCH, DPCCH and HS-DPCCH the MPR is based on the relative CM difference. This is applicable for only UEs that support HSDPA in release 6 and later releases.

Note 4: For subtest 2 the β_c/β_d ratio of 12/15 for the TFC during the measurement period (TF1, TF0) is achieved by setting the signalled gain factors for the reference TFC (TF1, TF1) to $\beta_c = 11/15$ and $\beta_d = 15/15$.

Setup Configuration**HSUPA Setup Configuration:**

- The EUT was connected to Base Station R&S CMU200 referred to the Setup Configuration.
- The RF path losses were compensated into the measurements.
- A call was established between EUT and Base Station with following setting * :
 - Call Configs = 5.2B, 5.9B, 5.10B, and 5.13.2B with QPSK
 - Set the Gain Factors (β_c and β_d) and parameters (AG Index) were set according to each specific sub-test in the following table, C11.1.3, quoted from the TS 34.121
 - Set Cell Power = -86 dBm
 - Set Channel Type = 12.2k + HSPA
 - Set UE Target Power
 - Power Ctrl Mode= Alternating bits
 - Set and observe the E-TFCI
 - Confirm that E-TFCI is equal to the target E-TFCI of 75 for sub-test 1, and other subtest's E-TFCI
- The transmitted maximum output power was recorded.

Table C.11.1.3: β values for transmitter characteristics tests with HS-DPCCH and E-DCH

Sub-test	β_c	β_d	β_d (SF)	β_c/β_d	β_{HS} (Note 1)	β_{ec}	β_{ed} (Note 5) (Note 6)	β_{ed} (SF)	β_{ed} (Codes)	CM (dB) (Note 2)	MPR (dB) (Note 2)	AG Index (Note 6)	E- TFCI
1	11/15 (Note 3)	15/15 (Note 3)	64	11/15 (Note 3)	22/15	209/25	1309/225	4	1	1.0	0.0	20	75
2	6/15	15/15	64	6/15	12/15	12/15	94/75	4	1	3.0	2.0	12	67
3	15/15	9/15	64	15/9	30/15	30/15	$\beta_{ed1}: 47/15$ $\beta_{ed2}: 47/15$	4	2	2.0	1.0	15	92
4	2/15	15/15	64	2/15	4/15	2/15	56/75	4	1	3.0	2.0	17	71
5	15/15 (Note 4)	15/15 (Note 4)	64	15/15 (Note 4)	30/15	24/15	134/15	4	1	1.0	0.0	21	81

Note 1: Δ_{ACK} , Δ_{NACK} and $\Delta_{CQI} = 30/15$ with $\beta_{HS} = 30/15 * \beta_c$.

Note 2: CM = 1 for $\beta_c/\beta_d = 12/15$, $\beta_{HS}/\beta_c = 24/15$. For all other combinations of DPDCH, DPCCH, HS-DPCCH, E-DPCCH and E-DPCCH the MPR is based on the relative CM difference.

Note 3: For subtest 1 the β_c/β_d ratio of 11/15 for the TFC during the measurement period (TF1, TF0) is achieved by setting the signalled gain factors for the reference TFC (TF1, TF1) to $\beta_c = 10/15$ and $\beta_d = 15/15$.

Note 4: For subtest 5 the β_c/β_d ratio of 15/15 for the TFC during the measurement period (TF1, TF0) is achieved by setting the signalled gain factors for the reference TFC (TF1, TF1) to $\beta_c = 14/15$ and $\beta_d = 15/15$.

Note 5: In case of testing by UE using E-DPCCH Physical Layer category 1, Sub-test 3 is omitted according to TS25.306 Table 5.1g.

Note 6: β_{ed} can not be set directly, it is set by Absolute Grant Value.

General Note

1. Per KDB 941225 D01, RMC 12.2kbps setting is used to evaluate SAR. If AMR 12.2kbps power is < 0.25dB higher than RMC 12.2kbps, SAR tests with AMR 12.2kbps can be excluded.
2. By design, AMR and HSDPA/HSUPA RF power will not be larger than RMC 12.2kbps, detailed information is included in Tune-up Procure exhibit.
3. It is expected by the manufacturer that MPR for some HSDPA/HSUPA subtests may differ from the specification of 3GPP, according to the chipset implementation in this model. The implementation and expected deviation are detailed in tune-up procedure exhibit.

<SIM1>Conducted Power Measurement Results(WCDMA Band II /V)

Item	band	WCDMA Band II result (dBm)			WCDMA Band V result (dBm)		
		Channel/Frequency(MHz)			Channel/Frequency(MHz)		
	sub-test	9262/ 1852.4	9400/ 1880	9538/ 1907.6	4132/ 826.4	4182/ 836.4	4233/ 846.6
RMC	12.2kbps	23.35	23.28	23.43	23.28	23.31	23.29
	64kbps	22.67	22.73	22.56	22.82	22.78	22.60
	144kbps	22.58	22.70	22.47	22.47	22.43	22.23
	384kbps	22.41	22.66	22.15	22.44	22.06	21.89
HSDPA	Sub –Test 1	22.89	22.80	22.71	22.70	22.64	22.72
	Sub –Test 2	22.63	22.68	22.84	22.59	22.56	22.77
	Sub –Test 3	22.55	22.79	22.75	22.59	22.82	22.59
	Sub –Test 4	22.82	22.76	22.72	22.75	22.82	22.79
HSUPA	Sub –Test 1	22.61	22.84	22.71	22.59	22.59	22.72
	Sub –Test 2	22.83	22.57	22.76	22.75	22.59	22.72
	Sub –Test 3	22.75	22.63	22.68	22.76	22.71	22.63
	Sub –Test 4	22.59	22.78	22.61	22.71	22.71	22.82
	Sub –Test 5	22.64	22.81	22.56	22.78	22.77	22.74

<SIM2> (Not Supported)

Note: When the maximum output power and tune-up tolerance specified for production units in a secondary mode is $\leq 1/2$ dB higher than the primary mode (RMC12.2kbps) or when the highest reported SAR of the primary mode is scaled by the ratio of specified maximum output power and tune-up tolerance of secondary to primary mode and the adjusted SAR is ≤ 1.2 W/kg, SAR measurement is not required for the secondary mode.

LTE Band2

BW (MHz)	Frequency (MHz)	RB Configuration		Average Power [dBm]	
		Size	Offset	QPSK	16QAM
1.4	1850.7	1	0	22.92	21.70
		1	3	22.81	21.72
		1	5	22.87	21.67
		3	0	22.73	21.72
		3	2	22.71	21.63
		3	3	22.67	21.64
		6	0	21.93	20.74
	1880.0	1	0	23.46	22.43
		1	3	23.33	22.46
		1	5	23.41	22.48
		3	0	23.35	22.16
		3	2	23.33	22.17
		3	3	23.37	22.20
		6	0	22.50	21.33
	1909.3	1	0	21.79	21.13
		1	3	21.46	20.89
		1	5	21.49	20.86
		3	0	21.80	20.94
		3	2	21.61	20.78
		3	3	21.57	20.75
		6	0	20.93	20.22
3	1851.5	1	0	22.59	21.82
		1	7	22.54	21.79
		1	14	22.70	21.71
		8	0	21.95	20.87
		8	4	21.88	20.86
		8	7	21.87	20.79
		15	0	21.82	20.71
	1880.0	1	0	23.29	22.32
		1	7	23.15	22.42
		1	14	23.13	22.44
		8	0	22.52	21.48
		8	4	22.54	21.49
		8	7	22.58	21.48
		15	0	22.45	21.35
	1908.5	1	0	22.15	21.58
		1	7	21.65	21.10
		1	14	21.35	20.84
		8	0	21.39	20.52
		8	4	21.09	20.24
		8	7	20.94	20.12
		15	0	21.16	20.31
5	1852.5	1	0	22.63	22.01
		1	12	22.44	21.83
		1	24	22.68	21.82
		12	0	21.95	20.98
		12	6	21.91	20.94
		12	13	21.83	20.91
		25	0	21.85	20.83
	1880.0	1	0	23.32	22.52
		1	12	22.95	22.40
		1	24	22.99	22.49
		12	0	22.50	21.52
		12	6	22.51	21.56
		12	13	22.50	21.57
		25	0	22.45	21.41
	1907.5	1	0	22.53	21.57
		1	12	21.64	20.71

		1	24	21.32	20.38
		12	0	21.40	20.58
		12	6	21.00	20.22
		12	13	20.67	19.90
		25	0	21.08	20.22
10	1855.0	1	0	22.25	21.68
		1	24	22.41	21.81
		1	49	21.78	21.16
		25	0	21.86	20.79
		25	12	21.79	20.74
		25	25	21.65	20.71
		50	0	21.78	20.78
	1880.0	1	0	22.76	22.15
		1	24	22.89	22.33
		1	49	22.23	21.69
		25	0	22.41	21.35
		25	12	22.44	21.44
		25	25	22.21	21.34
		50	0	22.37	21.45
	1905.0	1	0	22.14	21.61
		1	24	22.05	21.55
		1	49	20.76	20.27
		25	0	21.66	20.79
		25	12	21.43	20.59
		25	25	20.89	20.08
		50	0	21.33	20.51
15	1857.5	1	0	22.25	21.68
		1	37	22.03	21.43
		1	74	21.53	20.88
		37	0	21.85	20.93
		37	18	21.50	20.62
		37	38	20.94	20.08
		75	0	21.47	20.54
	1880.0	1	0	22.61	21.98
		1	37	22.75	22.18
		1	74	22.04	21.50
		37	0	22.17	21.24
		37	18	22.23	21.34
		37	38	21.90	21.06
		75	0	22.09	21.19
	1902.5	1	0	21.82	21.15
		1	37	22.08	21.47
		1	74	20.88	20.25
		37	0	21.28	20.42
		37	18	21.35	20.53
		37	38	21.00	20.20
		75	0	21.15	20.30
20	1860.0	1	0	22.41	21.77
		1	49	21.95	21.19
		1	99	21.85	21.09
		50	0	21.79	20.79
		50	25	21.19	20.31
		50	50	20.82	19.94
		100	0	21.38	20.43
	1880.0	1	0	22.47	21.71
		1	49	22.93	22.25
		1	99	21.86	21.15
		50	0	22.05	21.09
		50	25	22.15	21.21
		50	50	21.75	20.84
		100	0	21.92	20.99

	1900.0	1	0	21.99	21.36
		1	49	22.06	21.46
		1	99	20.80	20.25
		50	0	21.02	20.17
		50	25	21.18	20.35
		50	50	20.99	20.18
		100	0	21.04	20.14

LTE Band4

BW (MHz)	Frequency (MHz)	RB Configuration		Average Power [dBm]		
		Size	Offset	QPSK	16QAM	
1.4	1710.7	1	0	21.28	21.39	
		1	3	21.19	21.40	
		1	5	21.45	21.58	
		3	0	21.25	21.35	
		3	2	21.28	21.35	
		3	3	21.36	21.43	
		6	0	21.36	21.29	
	1732.5	1	0	21.87	22.11	
		1	3	21.89	22.16	
		1	5	21.93	22.14	
		3	0	21.98	21.86	
		3	2	21.91	21.85	
		3	3	21.97	21.88	
		6	0	21.95	21.85	
	1754.3	1	0	22.00	22.02	
		1	3	21.76	21.88	
		1	5	21.84	21.90	
		3	0	21.98	21.89	
		3	2	21.88	21.81	
		3	3	21.84	21.79	
		6	0	21.92	21.95	
	3	1711.5	1	0	21.25	21.40
			1	7	21.32	21.49
			1	14	21.72	21.85
8			0	21.42	21.43	
8			4	21.55	21.57	
8			7	21.71	21.68	
15			0	21.55	21.48	
1732.5		1	0	21.74	21.92	
		1	7	21.81	21.98	
		1	14	21.83	21.98	
		8	0	21.93	21.94	
		8	4	21.96	21.97	
		8	7	22.00	21.96	
		15	0	21.94	21.85	
1753.5		1	0	22.24	22.28	
		1	7	21.93	22.03	
		1	14	21.84	21.99	
		8	0	22.20	22.08	
		8	4	22.05	21.94	
		8	7	22.00	21.91	
		15	0	22.05	21.99	
5	1712.0	1	0	21.28	21.51	
		1	12	21.25	21.48	
		1	24	21.88	22.04	
		12	0	21.28	21.37	

		12	6	21.40	21.48
		12	13	21.74	21.78
		25	0	21.47	21.45
	1732.5	1	0	21.88	22.09
		1	12	21.89	22.11
		1	24	21.97	22.18
		12	0	21.99	22.02
		12	6	21.99	22.04
		12	13	22.06	22.11
		25	0	21.95	21.91
	1752.5	1	0	22.33	21.98
		1	12	21.73	21.50
		1	24	21.82	21.55
		12	0	22.00	21.94
		12	6	21.80	21.76
		12	13	21.69	21.67
		25	0	21.85	21.77
10	1715.0	1	0	20.78	20.93
		1	24	21.71	21.77
		1	49	21.64	21.73
		25	0	21.56	21.48
		25	12	21.87	21.77
		25	25	21.88	21.76
		50	0	21.78	21.69
	1732.5	1	0	21.75	21.83
		1	24	21.89	21.98
		1	49	21.43	21.58
		25	0	21.87	21.61
		25	12	21.93	21.64
		25	25	21.91	21.74
		50	0	21.74	21.72
	1750.0	1	0	21.95	22.01
		1	24	22.04	22.08
		1	49	21.37	21.48
25		0	22.25	22.12	
25		12	22.24	22.08	
25		25	22.01	21.89	
50		0	22.10	22.01	
15	1717.5	1	0	21.10	21.21
		1	37	21.71	21.80
		1	74	21.62	21.74
		37	0	21.83	21.70
		37	18	21.89	21.77
		37	38	21.84	21.73
		75	0	21.92	21.81
	1732.5	1	0	21.61	21.72
		1	37	21.80	21.94
		1	74	21.69	21.83
		37	0	21.88	21.79
		37	18	21.96	21.89
		37	38	21.89	21.80
		75	0	21.92	21.86
	1747.5	1	0	21.95	22.03
		1	37	21.77	21.80
		1	74	21.31	21.41
37		0	21.96	21.87	
37		18	21.87	21.77	
37		38	21.70	21.61	
75		0	21.81	21.70	
20	1720.0	1	0	21.12	21.15
		1	49	21.82	21.84

		1	99	21.73	21.77
		50	0	21.75	21.62
		50	25	21.74	21.60
		50	50	21.77	21.66
		100	0	21.76	21.64
	1732.5	1	0	21.73	21.67
		1	49	21.71	21.71
		1	99	21.39	21.40
		50	0	21.68	21.54
		50	25	21.59	21.48
		50	50	21.44	21.34
		100	0	21.52	21.41
	1745.0	1	0	21.63	21.64
		1	49	21.36	21.36
		1	99	20.82	20.93
		50	0	21.60	21.49
		50	25	21.45	21.32
		50	50	21.26	21.12
100		0	21.39	21.79	

LTE Band7

BW (MHz)	Frequency (MHz)	RB Configuration		Average Power [dBm]	
		Size	Offset	QPSK	16QAM
5	2502.5	1	0	22.86	22.79
		1	12	22.85	22.88
		1	24	22.05	22.23
		12	0	22.07	21.42
		12	6	22.09	21.37
		12	13	22.15	21.39
		25	0	22.26	21.25
	2535.0	1	0	23.19	21.63
		1	12	23.21	21.72
		1	24	22.63	21.61
		12	0	22.22	21.46
		12	6	22.19	21.41
		12	13	22.23	21.38
		25	0	22.24	21.47
	2567.5	1	0	22.32	22.14
		1	12	21.80	21.73
		1	24	20.59	20.63
		12	0	21.96	21.27
		12	6	21.63	21.22
		12	13	21.05	21.20
		25	0	21.48	21.20
10	2505.0	1	0	22.22	22.30
		1	24	21.99	22.17
		1	49	22.20	22.42
		25	0	22.05	21.33
		25	12	21.95	21.24
		25	25	22.02	21.20
		50	0	22.04	21.31
	2535.0	1	0	23.01	23.12
		1	24	23.06	23.15
		1	49	22.36	22.55
		25	0	22.25	21.27
		25	12	22.19	21.29
		25	25	22.27	21.22
		50	0	22.19	21.30
2565.0	1	0	22.99	22.53	

		1	24	22.61	22.57	
		1	49	21.03	21.30	
		25	0	22.11	21.16	
		25	12	22.02	21.16	
		25	25	21.85	21.18	
		50	0	21.96	21.25	
15	2507.5	1	0	22.25	22.27	
		1	37	21.99	22.16	
		1	74	22.87	23.05	
		37	0	21.96	21.30	
		37	18	21.89	21.22	
		37	38	22.13	21.26	
		75	0	22.03	21.29	
	2535.0	1	0	22.93	23.01	
		1	37	23.03	23.12	
		1	74	21.79	22.05	
		37	0	22.23	21.31	
		37	18	22.20	21.40	
		37	38	22.17	21.42	
		75	0	22.19	21.32	
	2562.5	1	0	22.99	22.88	
		1	37	23.10	22.92	
		1	74	20.80	21.04	
		37	0	22.00	21.09	
		37	18	22.08	21.08	
		37	38	22.06	21.16	
		75	0	21.99	21.17	
	20	2510.0	1	0	22.37	22.33
			1	49	22.34	22.39
			1	99	23.32	22.65
50			0	21.90	21.21	
50			25	22.11	21.29	
50			50	22.09	21.14	
100			0	22.10	21.20	
2535.0		1	0	23.30	22.17	
		1	49	23.24	22.33	
		1	99	22.28	22.31	
		50	0	22.24	21.28	
		50	25	22.22	21.36	
		50	50	22.26	21.37	
		100	0	22.25	21.39	
2560		1	0	22.20	22.19	
		1	49	23.19	22.26	
		1	99	21.42	21.61	
		50	0	21.96	21.16	
		50	25	21.98	21.12	
		50	50	22.06	21.12	
		100	0	22.01	21.21	

<WLAN 2.4GHz Conducted Power>

Mode	Channel	Frequency (MHz)	Data rate (Mbps)	Average Output Power (dBm)
IEEE 802.11b	1	2412	1	11.02
			2	10.72
			5.5	10.53
			11	10.44
	6	2437	1	12.21
			2	12.19
			5.5	12.14
			11	12.10
	11	2462	1	11.53
			2	11.50
			5.5	11.46
			11	11.40
IEEE 802.11g	1	2412	6	10.68
			9	10.36
			12	10.32
			18	10.30
			24	10.28
			36	10.25
			48	10.22
			54	10.10
	6	2437	6	11.83
			9	11.79
			12	11.77
			18	11.72
			24	11.65
			36	11.63
			48	11.60
			54	11.42
	11	2462	6	10.21
			9	10.20
			12	10.18
			18	10.15
			24	10.13
			36	10.12
			48	10.10
			54	10.05
IEEE 802.11n HT20	1	2412	MCS0	9.63
			MCS1	9.55
			MCS2	9.50
			MCS3	9.43
			MCS4	9.40
			MCS5	9.35
			MCS6	9.33
			MCS7	9.12
	6	2437	MCS0	10.43
			MCS1	10.40
			MCS2	10.35
			MCS3	10.33
			MCS4	10.30
			MCS5	10.28
			MCS6	10.25
			MCS7	10.20
	11	2462	MCS0	9.40
			MCS1	9.36
			MCS2	9.35
			MCS3	9.30
			MCS4	9.21
			MCS5	9.20

			MCS6	9.11
			MCS7	9.02

63

Note: SAR is not required for the following 2.4 GHz OFDM conditions as the highest reported SAR for DSSS is adjusted by the ratio of OFDM to DSSS specified maximum output power and the adjusted SAR is ≤ 1.2 W/kg.

<BT Conducted Power>

Mode	channel	Frequency (MHz)	Conducted AVG output power (dBm)
GFSK-BLE	0	2402	1.102
	19	2440	0.869
	39	2480	1.420
GFSK	0	2402	1.165
	39	2441	0.762
	78	2480	1.539
$\pi/4$ -DQPSK	0	2402	0.410
	39	2441	0.365
	78	2480	1.725
8DPSK	0	2402	0.569
	39	2441	0.305
	78	2480	0.784

Per KDB 447498 D01v06, the 1-g and 10-g SAR test exclusion thresholds for 100 MHz to 6 GHz at test separation distances ≤ 50 mm are determined by:

$[(\text{max. power of channel, including tune-up tolerance, mW}) / (\text{min. test separation distance, mm})] \cdot [\sqrt{f(\text{GHz})}] \leq 3.0$
for 1-g SAR and ≤ 7.5 for 10-g extremity SAR

- $f(\text{GHz})$ is the RF channel transmit frequency in GHz
- Power and distance are rounded to the nearest mW and mm before calculation
- The result is rounded to one decimal place for comparison

Bluetooth Turn up Power (dBm)	Separation Distance (mm)	Frequency (GHz)	Exclusion Thresholds
2.0	5	2.45	0.5

Per KDB 447498 D01v06, when the minimum test separation distance is < 5 mm, a distance of 5 mm is applied to determine SAR test exclusion. The test exclusion threshold is $0.5 < 3.0$, SAR testing is not required.

4.2. Manufacturing tolerance

GSM Speech <SIM1>

GSM 850 (GMSK) (Burst Average Power)			
Channel	Channel 251	Channel 190	Channel 128
Target (dBm)	32.0	31.5	32.0
Tolerance \pm (dB)	1.0	1.0	1.0
GSM 1900 (GMSK) (Burst Average Power)			
Channel	Channel 810	Channel 661	Channel 512
Target (dBm)	29.0	29.0	29.0
Tolerance \pm (dB)	1.0	1.0	1.0

GSM 850 GPRS (GMSK) (Burst Average Power)				
Channel		128	190	251
1 Txslot	Target (dBm)	31.5	31.5	31.5
	Tolerance \pm (dB)	1.0	1.0	1.0
2 Txslot	Target (dBm)	30.5	30.5	30.0
	Tolerance \pm (dB)	1.0	1.0	1.0
3 Txslot	Target (dBm)	28.5	29.0	29.0
	Tolerance \pm (dB)	1.0	1.0	1.0
4 Txslot	Target (dBm)	27.0	27.0	27.5
	Tolerance \pm (dB)	1.0	1.0	1.0
GSM 850 EDGE (8PSK) (Burst Average Power)				
Channel		128	190	251

1 Txslot	Target (dBm)	25.0	25.5	25.5
	Tolerance \pm (dB)	1.0	1.0	1.0
2 Txslot	Target (dBm)	24.0	24.0	23.5
	Tolerance \pm (dB)	1.0	1.0	1.0
3 Txslot	Target (dBm)	22.5	22.0	22.0
	Tolerance \pm (dB)	1.0	1.0	1.0
4 Txslot	Target (dBm)	21.0	20.5	20.5
	Tolerance \pm (dB)	1.0	1.0	1.0
GSM 1900 GPRS (GMSK) (Burst Average Power)				
Channel		512	661	810
1 Txslot	Target (dBm)	28.5	28.5	28.5
	Tolerance \pm (dB)	1.0	1.0	1.0
2 Txslot	Target (dBm)	27.0	27.5	27.0
	Tolerance \pm (dB)	1.0	1.0	1.0
3 Txslot	Target (dBm)	26.0	26.0	26.0
	Tolerance \pm (dB)	1.0	1.0	1.0
4 Txslot	Target (dBm)	24.5	24.5	24.5
	Tolerance \pm (dB)	1.0	1.0	1.0
GSM 1900 EDGE (8PSK) (Burst Average Power)				
Channel		512	661	810
1 Txslot	Target (dBm)	24.5	25.0	25.0
	Tolerance \pm (dB)	1.0	1.0	1.0
2 Txslot	Target (dBm)	23.0	23.0	23.0
	Tolerance \pm (dB)	1.0	1.0	1.0
3 Txslot	Target (dBm)	22.0	21.5	21.5
	Tolerance \pm (dB)	1.0	1.0	1.0
4 Txslot	Target (dBm)	20.0	20.5	20.0
	Tolerance \pm (dB)	1.0	1.0	1.0

GSM Speech <SIM2>

GSM 850 (GMSK) (Burst Average Power)			
Channel	Channel 251	Channel 190	Channel 128
Target (dBm)	31.5	31.5	31.5
Tolerance \pm (dB)	1.0	1.0	1.0
GSM 1900 (GMSK) (Burst Average Power)			
Channel	Channel 810	Channel 661	Channel 512
Target (dBm)	28.5	28.5	28.5
Tolerance \pm (dB)	1.0	1.0	1.0

GSM 850 GPRS (GMSK) (Burst Average Power)				
Channel		128	190	251
1 Txslot	Target (dBm)	31.5	31.5	31.5
	Tolerance \pm (dB)	1.0	1.0	1.0
2 Txslot	Target (dBm)	30.0	30.0	30.0
	Tolerance \pm (dB)	1.0	1.0	1.0
3 Txslot	Target (dBm)	28.5	28.5	28.5
	Tolerance \pm (dB)	1.0	1.0	1.0
4 Txslot	Target (dBm)	27.0	27.0	27.0
	Tolerance \pm (dB)	1.0	1.0	1.0
GSM 850 EDGE (8PSK) (Burst Average Power)				
Channel		128	190	251
1 Txslot	Target (dBm)	25.0	25.0	25.0
	Tolerance \pm (dB)	1.0	1.0	1.0
2 Txslot	Target (dBm)	23.5	23.5	23.0
	Tolerance \pm (dB)	1.0	1.0	1.0
3 Txslot	Target (dBm)	22.0	22.0	21.5
	Tolerance \pm (dB)	1.0	1.0	1.0
4 Txslot	Target (dBm)	20.5	20.5	20.0

	Tolerance \pm (dB)	1.0	1.0	1.0
GSM 1900 GPRS (GMSK) (Burst Average Power)				
Channel		512	661	810
1 Txslot	Target (dBm)	28.5	28.5	28.5
	Tolerance \pm (dB)	1.0	1.0	1.0
2 Txslot	Target (dBm)	27.0	27.0	27.0
	Tolerance \pm (dB)	1.0	1.0	1.0
3 Txslot	Target (dBm)	25.5	25.5	25.5
	Tolerance \pm (dB)	1.0	1.0	1.0
4 Txslot	Target (dBm)	24.0	24.0	24.0
	Tolerance \pm (dB)	1.0	1.0	1.0
GSM 1900 EDGE (8PSK) (Burst Average Power)				
Channel		512	661	810
1 Txslot	Target (dBm)	24.5	24.5	24.5
	Tolerance \pm (dB)	1.0	1.0	1.0
2 Txslot	Target (dBm)	23.0	23.0	22.5
	Tolerance \pm (dB)	1.0	1.0	1.0
3 Txslot	Target (dBm)	21.5	21.5	21.0
	Tolerance \pm (dB)	1.0	1.0	1.0
4 Txslot	Target (dBm)	20.0	20.0	19.5
	Tolerance \pm (dB)	1.0	1.0	1.0

UMTS<SIM1>**UMTS Band V**

Channel	Channel 4132	Channel 4183	Channel 4233
Target (dBm)	23.0	23.0	23.0
Tolerance \pm (dB)	1.0	1.0	1.0
UMTS Band V HSDPA(sub-test 1)			
Channel	Channel 4132	Channel 4183	Channel 4233
Target (dBm)	22.0	22.0	22.0
Tolerance \pm (dB)	1.0	1.0	1.0
UMTS Band V HSDPA(sub-test 2)			
Channel	Channel 4132	Channel 4183	Channel 4233
Target (dBm)	22.0	22.0	22.0
Tolerance \pm (dB)	1.0	1.0	1.0
UMTS Band V HSDPA(sub-test 3)			
Channel	Channel 4132	Channel 4183	Channel 4233
Target (dBm)	22.0	22.0	22.0
Tolerance \pm (dB)	1.0	1.0	1.0
UMTS Band V HSDPA(sub-test 4)			
Channel	Channel 4132	Channel 4183	Channel 4233
Target (dBm)	22.0	22.0	22.0
Tolerance \pm (dB)	1.0	1.0	1.0
UMTS Band V HSUPA(sub-test 1)			
Channel	Channel 4132	Channel 4183	Channel 4233
Target (dBm)	22.0	22.0	22.0
Tolerance \pm (dB)	1.0	1.0	1.0
UMTS Band V HSUPA(sub-test 2)			
Channel	Channel 4132	Channel 4183	Channel 4233
Target (dBm)	22.0	22.0	22.0
Tolerance \pm (dB)	1.0	1.0	1.0
UMTS Band V HSUPA(sub-test 3)			
Channel	Channel 4132	Channel 4183	Channel 4233
Target (dBm)	22.0	22.0	22.0
Tolerance \pm (dB)	1.0	1.0	1.0
UMTS Band V HSUPA(sub-test 4)			
Channel	Channel 4132	Channel 4183	Channel 4233
Target (dBm)	22.0	22.0	22.0
Tolerance \pm (dB)	1.0	1.0	1.0
UMTS Band V HSUPA(sub-test 5)			
Channel	Channel 4132	Channel 4183	Channel 4233

Target (dBm)	22.0	22.0	22.0
Tolerance \pm (dB)	1.0	1.0	1.0

UMTS Band II			
Channel	Channel 9262	Channel 9400	Channel 9538
Target (dBm)	23.0	23.0	23.0
Tolerance \pm (dB)	1.0	1.0	1.0
UMTS Band II HSDPA(sub-test 1)			
Channel	Channel 9262	Channel 9400	Channel 9538
Target (dBm)	22.0	23.0	22.0
Tolerance \pm (dB)	1.0	1.0	1.0
UMTS Band II HSDPA(sub-test 2)			
Channel	Channel 9262	Channel 9400	Channel 9538
Target (dBm)	22.0	22.0	22.0
Tolerance \pm (dB)	1.0	1.0	1.0
UMTS Band II HSDPA(sub-test 3)			
Channel	Channel 9262	Channel 9400	Channel 9538
Target (dBm)	22.0	22.0	22.0
Tolerance \pm (dB)	1.0	1.0	1.0
UMTS Band II HSDPA(sub-test 4)			
Channel	Channel 9262	Channel 9400	Channel 9538
Target (dBm)	22.0	22.0	22.0
Tolerance \pm (dB)	1.0	1.0	1.0
UMTS Band II HSUPA(sub-test 1)			
Channel	Channel 9262	Channel 9400	Channel 9538
Target (dBm)	22.0	22.0	22.0
Tolerance \pm (dB)	1.0	1.0	1.0
UMTS Band II HSUPA(sub-test 2)			
Channel	Channel 9262	Channel 9400	Channel 9538
Target (dBm)	22.0	22.0	22.0
Tolerance \pm (dB)	1.0	1.0	1.0
UMTS Band II HSUPA(sub-test 3)			
Channel	Channel 9262	Channel 9400	Channel 9538
Target (dBm)	22.0	22.0	22.0
Tolerance \pm (dB)	1.0	1.0	1.0
UMTS Band II HSUPA(sub-test 4)			
Channel	Channel 9262	Channel 9400	Channel 9538
Target (dBm)	22.0	22.0	22.0
Tolerance \pm (dB)	1.0	1.0	1.0
UMTS Band II HSUPA(sub-test 5)			
Channel	Channel 9262	Channel 9400	Channel 9538
Target (dBm)	22.0	22.0	22.0
Tolerance \pm (dB)	1.0	1.0	1.0

LTE Band 2

BW:1.4MHz [<RB=1>]						
Channel	Channel 18607		Channel 18900		Channel 19193	
	QPSK	16QAM	QPSK	16QAM	QPSK	16QAM
Target (dBm)	22.0	21.0	23.0	22.0	21.0	21.0
Tolerance \pm (dB)	1.0	1.0	1.0	1.0	1.0	1.0
BW:1.4MHz [<RB=3>, <RB=6>]						
Channel	Channel 18607		Channel 18900		Channel 19193	
	QPSK	16QAM	QPSK	16QAM	QPSK	16QAM
Target (dBm)	22.0	21.0	23.0	22.0	21.0	20.0
Tolerance \pm (dB)	1.0	1.0	1.0	1.0	1.0	1.0
BW:3MHz [<RB=1>]						
Channel	Channel 18615		Channel 18900		Channel 19185	
	QPSK	16QAM	QPSK	16QAM	QPSK	16QAM
Target (dBm)	22.0	21.0	23.0	22.0	22.0	21.0

Tolerance \pm (dB)	1.0	1.0	1.0	1.0	1.0	1.0
BW:3MHz [<RB=8>, <RB=15>]						
Channel	Channel 18615		Channel 18900		Channel 19185	
	QPSK	16QAM	QPSK	16QAM	QPSK	16QAM
Target (dBm)	21.0	20.0	22.0	21.0	21.0	20.0
Tolerance \pm (dB)	1.0	1.0	1.0	1.0	1.0	1.0
BW:5MHz [<RB=1>]						
Channel	Channel 18625		Channel 18900		Channel 19175	
	QPSK	16QAM	QPSK	16QAM	QPSK	16QAM
Target (dBm)	22.0	22.0	23.0	22.0	22.0	21.0
Tolerance \pm (dB)	1.0	1.0	1.0	1.0	1.0	1.0
BW:5MHz [<RB=12>, <RB=25>]						
Channel	Channel 18625		Channel 18900		Channel 19175	
	QPSK	16QAM	QPSK	16QAM	QPSK	16QAM
Target (dBm)	21.0	20.0	22.0	21.0	21.0	20.0
Tolerance \pm (dB)	1.0	1.0	1.0	1.0	1.0	1.0
BW:10MHz [<RB=1>]						
Channel	Channel 18650		Channel 18900		Channel 19150	
	QPSK	16QAM	QPSK	16QAM	QPSK	16QAM
Target (dBm)	22.0	21.0	22.0	22.0	22.0	21.0
Tolerance \pm (dB)	1.0	1.0	1.0	1.0	1.0	1.0
BW:10MHz [<RB=25>, <RB=50>]						
Channel	Channel 18650		Channel 18900		Channel 19150	
	QPSK	16QAM	QPSK	16QAM	QPSK	16QAM
Target (dBm)	21.0	20.0	22.0	21.0	21.0	20.0
Tolerance \pm (dB)	1.0	1.0	1.0	1.0	1.0	1.0
BW:15MHz [<RB=1>]						
Channel	Channel 18675		Channel 18900		Channel 19125	
	QPSK	16QAM	QPSK	16QAM	QPSK	16QAM
Target (dBm)	22.0	21.0	22.0	22.0	22.0	21.0
Tolerance \pm (dB)	1.0	1.0	1.0	1.0	1.0	1.0
BW:15MHz [<RB=37>, <RB=75>]						
Channel	Channel 18675		Channel 18900		Channel 19125	
	QPSK	16QAM	QPSK	16QAM	QPSK	16QAM
Target (dBm)	21.0	20.0	22.0	21.0	21.0	20.0
Tolerance \pm (dB)	1.0	1.0	1.0	1.0	1.0	1.0
BW:20MHz [<RB=1>]						
Channel	Channel 18700		Channel 18900		Channel 19100	
	QPSK	16QAM	QPSK	16QAM	QPSK	16QAM
Target (dBm)	22.0	21.0	22.0	22.0	22.0	21.0
Tolerance \pm (dB)	1.0	1.0	1.0	1.0	1.0	1.0
BW:20MHz [<RB=50>, <RB=100>]						
Channel	Channel 18700		Channel 18900		Channel 19100	
	QPSK	16QAM	QPSK	16QAM	QPSK	16QAM
Target (dBm)	21.0	20.0	22.0	21.0	21.0	20.0
Tolerance \pm (dB)	1.0	1.0	1.0	1.0	1.0	1.0

LTE Band 4

BW:1.4MHz [<RB=1>]						
Channel	Channel 19957		Channel 20175		Channel 20393	
	QPSK	16QAM	QPSK	16QAM	QPSK	16QAM
Target (dBm)	21.0	21.0	21.0	22.0	22.0	22.0
Tolerance \pm (dB)	1.0	1.0	1.0	1.0	1.0	1.0
BW:1.4MHz [<RB=3>, <RB=6>]						
Channel	Channel 19957		Channel 20175		Channel 20393	
	QPSK	16QAM	QPSK	16QAM	QPSK	16QAM
Target (dBm)	21.0	21.0	21.0	21.0	21.0	21.0
Tolerance \pm (dB)	1.0	1.0	1.0	1.0	1.0	1.0
BW:3MHz [<RB=1>]						
Channel	Channel 19965		Channel 20175		Channel 20385	
	QPSK	16QAM	QPSK	16QAM	QPSK	16QAM

Target (dBm)	21.0	21.0	21.0	21.0	22.0	22.0
Tolerance \pm (dB)	1.0	1.0	1.0	1.0	1.0	1.0
BW:3MHz [<RB=8>, <RB=15>]						
Channel	Channel 19965		Channel 20175		Channel 20385	
	QPSK	16QAM	QPSK	16QAM	QPSK	16QAM
Target (dBm)	21.0	21.0	22.0	21.0	22.0	22.0
Tolerance \pm (dB)	1.0	1.0	1.0	1.0	1.0	1.0
BW:5MHz [<RB=1>]						
Channel	Channel 19975		Channel 20175		Channel 20375	
	QPSK	16QAM	QPSK	16QAM	QPSK	16QAM
Target (dBm)	21.0	22.0	21.0	22.0	22.0	21.0
Tolerance \pm (dB)	1.0	1.0	1.0	1.0	1.0	1.0
BW:5MHz [<RB=12>, <RB=25>]						
Channel	Channel 19975		Channel 20175		Channel 20375	
	QPSK	16QAM	QPSK	16QAM	QPSK	16QAM
Target (dBm)	21.0	21.0	22.0	22.0	22.0	21.0
Tolerance \pm (dB)	1.0	1.0	1.0	1.0	1.0	1.0
BW:10MHz [<RB=1>]						
Channel	Channel 20000		Channel 20175		Channel 20350	
	QPSK	16QAM	QPSK	16QAM	QPSK	16QAM
Target (dBm)	21.0	21.0	21.0	21.0	22.0	22.0
Tolerance \pm (dB)	1.0	1.0	1.0	1.0	1.0	1.0
BW:10MHz [<RB=25>, <RB=50>]						
Channel	Channel 20000		Channel 20175		Channel 20350	
	QPSK	16QAM	QPSK	16QAM	QPSK	16QAM
Target (dBm)	21.0	21.0	21.0	21.0	22.0	22.0
Tolerance \pm (dB)	1.0	1.0	1.0	1.0	1.0	1.0
BW:15MHz [<RB=1>]						
Channel	Channel 20025		Channel 20175		Channel 20325	
	QPSK	16QAM	QPSK	16QAM	QPSK	16QAM
Target (dBm)	21.0	21.0	21.0	21.0	21.0	22.0
Tolerance \pm (dB)	1.0	1.0	1.0	1.0	1.0	1.0
BW:15MHz [<RB=37>, <RB=75>]						
Channel	Channel 20025		Channel 20175		Channel 20325	
	QPSK	16QAM	QPSK	16QAM	QPSK	16QAM
Target (dBm)	21.0	21.0	21.0	21.0	21.0	21.0
Tolerance \pm (dB)	1.0	1.0	1.0	1.0	1.0	1.0
BW:20MHz [<RB=1>]						
Channel	Channel 20050		Channel 20175		Channel 20300	
	QPSK	16QAM	QPSK	16QAM	QPSK	16QAM
Target (dBm)	21.0	21.0	21.0	21.0	21.0	21.0
Tolerance \pm (dB)	1.0	1.0	1.0	1.0	1.0	1.0
BW:20MHz [<RB=50>, <RB=100>]						
Channel	Channel 20050		Channel 20175		Channel 20300	
	QPSK	16QAM	QPSK	16QAM	QPSK	16QAM
Target (dBm)	21.0	21.0	21.0	21.0	21.0	21.0
Tolerance \pm (dB)	1.0	1.0	1.0	1.0	1.0	1.0

LTE Band 7

BW:5MHz [<RB=1>]						
Channel	Channel 20775		Channel 21100		Channel 21425	
	QPSK	16QAM	QPSK	16QAM	QPSK	16QAM
Target (dBm)	22.0	22.0	23.0	21.0	22.0	22.0
Tolerance \pm (dB)	1.0	1.0	1.0	1.0	1.0	1.0
BW:5MHz [<RB=12>, <RB=25>]						
Channel	Channel 20775		Channel 21100		Channel 21425	
	QPSK	16QAM	QPSK	16QAM	QPSK	16QAM
Target (dBm)	22.0	21.0	22.0	21.0	21.0	21.0
Tolerance \pm (dB)	1.0	1.0	1.0	1.0	1.0	1.0
BW:10MHz [<RB=1>]						
Channel	Channel 20800		Channel 21100		Channel 21400	

	QPSK	16QAM	QPSK	16QAM	QPSK	16QAM
Target (dBm)	22.0	22.0	23.0	23.0	22.0	22.0
Tolerance \pm (dB)	1.0	1.0	1.0	1.0	1.0	1.0
BW:10MHz [<RB=25>, <RB=50>]						
Channel	Channel 20800		Channel 21100		Channel 21400	
	QPSK	16QAM	QPSK	16QAM	QPSK	16QAM
Target (dBm)	22.0	21.0	22.0	21.0	22.0	21.0
Tolerance \pm (dB)	1.0	1.0	1.0	1.0	1.0	1.0
BW:15MHz [<RB=1>]						
Channel	Channel 20825		Channel 21100		Channel 21375	
	QPSK	16QAM	QPSK	16QAM	QPSK	16QAM
Target (dBm)	22.0	23.0	23.0	23.0	23.0	22.0
Tolerance \pm (dB)	1.0	1.0	1.0	1.0	1.0	1.0
BW:15MHz [<RB=37>, <RB=75>]						
Channel	Channel 20825		Channel 21100		Channel 21375	
	QPSK	16QAM	QPSK	16QAM	QPSK	16QAM
Target (dBm)	22.0	21.0	22.0	21.0	22.0	21.0
Tolerance \pm (dB)	1.0	1.0	1.0	1.0	1.0	1.0
BW:20MHz [<RB=1>]						
Channel	Channel 20850		Channel 21100		Channel 21350	
	QPSK	16QAM	QPSK	16QAM	QPSK	16QAM
Target (dBm)	23.0	22.0	23.0	22.0	23.0	22.0
Tolerance \pm (dB)	1.0	1.0	1.0	1.0	1.0	1.0
BW:20MHz [<RB=50>, <RB=100>]						
Channel	Channel 20850		Channel 21100		Channel 21350	
	QPSK	16QAM	QPSK	16QAM	QPSK	16QAM
Target (dBm)	22.0	21.0	22.0	21.0	22.0	21.0
Tolerance \pm (dB)	1.0	1.0	1.0	1.0	1.0	1.0

WiFi 2.4G

802.11b (Average)			
Channel	Channel 1	Channel 6	Channel 11
Target (dBm)	11.0	12.0	11.0
Tolerance \pm (dB)	1.0	1.0	1.0
802.11g (Average)			
Channel	Channel 1	Channel 6	Channel 11
Target (dBm)	10.0	11.0	10.0
Tolerance \pm (dB)	1.0	1.0	1.0
802.11n HT20 (Average)			
Channel	Channel 1	Channel 6	Channel 11
Target (dBm)	9.0	10.0	9.0
Tolerance \pm (dB)	1.0	1.0	1.0

Bluetooth V4.2

BLE-GFSK (Average)			
Channel	Channel 0	Channel 19	Channel 39
Target (dBm)	1.0	0.0	1.0
Tolerance \pm (dB)	1.0	1.0	1.0
GFSK (Average)			
Channel	Channel 0	Channel 39	Channel 78
Target (dBm)	1.0	0.0	1.0
Tolerance \pm (dB)	1.0	1.0	1.0
π/4DQPSK (Average)			
Channel	Channel 0	Channel 39	Channel 78
Target (dBm)	0.0	0.0	1.0
Tolerance \pm (dB)	1.0	1.0	1.0
8DPSK (Average)			
Channel	Channel 0	Channel 39	Channel 78
Target (dBm)	0.0	0.0	0.0
Tolerance \pm (dB)	1.0	1.0	1.0

4.3. Transmit Antennas and SAR Measurement Position

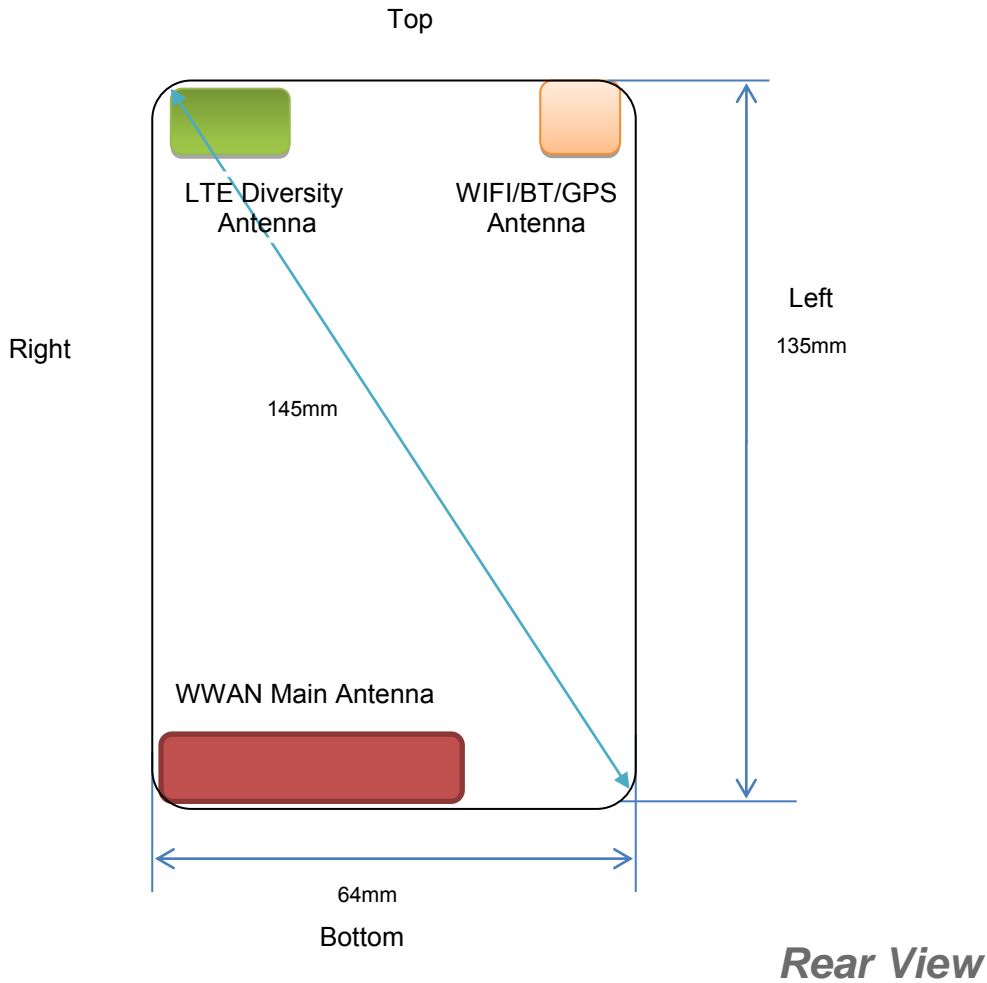

Antenna information:

WWAN Main Antenna	GSM/UMTS/LTE TX/RX
LTE Diversity antenna	Only RX
WLAN/GPS/BT Antenna	WLAN/BT TX/RX

Note:

- 1). Per KDB648474 D04, because the overall diagonal distance of this devices is 145mm<160mm, it is considered as “Phablet” device.
- 2). Per KDB648474 D04, 10-g extremity SAR is not required when Body-Worn mode 1-g reported SAR < 1.2 W/Kg.
- 3). According to the KDB941225 D06 Hot Spot SAR v02, the edges with less than 25 mm distance to the antennas need to be tested for SAR.

Distance of The Antenna to the EUT surface and edge (mm)						
Antennas	Front	Back	Top Side	Bottom Side	Left Side	Right Side
WWAN	<5	<5	124	<5	25	<5
BT/WLAN	<5	<5	<5	123	<5	49

Positions for SAR tests; Hotspot mode						
Antennas	Front	Back	Top Side	Bottom Side	Left Side	Right Side
WWAN	Yes	Yes	No	Yes	Yes	Yes
BT/WLAN	Yes	Yes	Yes	No	Yes	No

General Note: Referring to KDB 941225 D06 v02, When the overall device length and width are ≥9cm*5cm, the test distance is 10mm, SAR must be measured for all sides and surfaces with a transmitting antenna located with 25mm from that surface or edge.

4.4. SAR Measurement Results

The calculated SAR is obtained by the following formula:

$$\text{Reported SAR} = \text{Measured SAR} * 10^{(P_{\text{target}} - P_{\text{measured}})/10}$$

$$\text{Scaling factor} = 10^{(P_{\text{target}} - P_{\text{measured}})/10}$$

$$\text{Reported SAR} = \text{Measured SAR} * \text{Scaling factor}$$

Where

P_{target} is the power of manufacturing upper limit;

P_{measured} is the measured power;

Measured SAR is measured SAR at measured power which including power drift)

Reported SAR which including Power Drift and Scaling factor

Duty Cycle

Test Mode	Duty Cycle
Speech for GSM850/1900	1:8
GPRS850	1:2.67
GPRS1900	1:2.67
UMTS	1:1
LTE	1:1
WLAN2450	1:1

4.4.1 SAR Results

SAR Values [GSM 850]

Ch.	Freq. (MHz)	Time slots	Test Position	Conducted Power (dBm)	Maximum Allowed Power (dBm)	Power Drift (%)	Scaling Factor	SAR _{1-g} results(W/kg)		Graph Results
								Measured	Reported	
<i>measured / reported SAR numbers – Head <SIM1></i>										
251	848.8	Voice	Left Cheek	32.51	33.00	2.75	1.119	0.064	0.072	Plot 1
251	848.8	Voice	Left Tilt	32.51	33.00	1.33	1.119	0.036	0.040	
251	848.8	Voice	Right Cheek	32.51	33.00	-1.69	1.119	0.058	0.065	
251	848.8	Voice	Right Tilt	32.51	33.00	-0.72	1.119	0.033	0.037	
<i>measured / reported SAR numbers - Body (hotspot open, distance 10mm) <SIM1></i>										
251	848.8	3Txslots	Front	29.72	30.00	-1.20	1.067	0.086	0.092	
251	848.8	3Txslots	Rear	29.72	30.00	0.26	1.067	0.151	0.161	Plot 2
251	848.8	3Txslots	Left	29.72	30.00	-1.30	1.067	0.020	0.021	
251	848.8	3Txslots	Right	29.72	30.00	-1.22	1.067	0.051	0.054	
251	848.8	3Txslots	Bottom	29.72	30.00	3.65	1.067	0.079	0.084	

Remark:

1. The value with black color is the maximum SAR Value of each test band.
2. The frame average of GPRS (3Tx slots) higher than GSM and sample can support VoIP function, tested at GPRS (3Tx slots) mode for head.
3. Per FCC KDB Publication 447498 D01, if the reported (scaled) SAR measured at the middle channel or highest output power channel for each test configuration is ≤ 0.8 W/kg then testing at the other channels is optional for such test configuration(s).

SAR Values [GSM 1900]

Ch.	Freq. (MHz)	time slots	Test Position	Conducted Power (dBm)	Maximum Allowed Power (dBm)	Power Drift (%)	Scaling Factor	SAR _{1-g} results(W/kg)		Graph Results
								Measured	Reported	
<i>measured / reported SAR numbers – Head<SIM1></i>										
661	1850.2	Voice	Left Cheek	29.57	30.00	3.88	1.104	0.117	0.129	Plot 3
661	1850.2	Voice	Left Tilt	29.57	30.00	-0.21	1.104	0.075	0.083	
661	1850.2	Voice	Right Cheek	29.57	30.00	0.29	1.104	0.099	0.109	
661	1850.2	Voice	Right Tilt	29.57	30.00	1.28	1.104	0.062	0.068	
<i>measured / reported SAR numbers – Body (hotspot open, distance 10mm) <SIM1></i>										
810	1909.8	3Txslots	Front	26.81	27.00	1.84	1.045	0.154	0.161	
810	1909.8	3Txslots	Rear	26.81	27.00	-4.41	1.045	0.264	0.276	Plot 4
810	1909.8	3Txslots	Left	26.81	27.00	0.62	1.045	0.041	0.043	

810	1909.8	3Txslots	Right	26.81	27.00	-3.12	1.045	0.095	0.099	
810	1909.8	3Txslots	Bottom	26.81	27.00	-3.25	1.045	0.126	0.132	

Remark:

1. The value with black color is the maximum SAR Value of each test band.
2. The frame average of GPRS (3Tx slots) higher than GSM and sample can support VoIP function, tested at GPRS (3Tx slots) mode for head.
3. Per FCC KDB Publication 447498 D01, if the reported (scaled) SAR measured at the middle channel or highest output power channel for each test configuration is ≤ 0.8 W/kg then testing at the other channels is optional for such test configuration(s).

SAR Values [WCDMA Band V]

Ch.	Freq. (MHz)	Channel Type	Test Position	Conducted Power (dBm)	Maximum Allowed Power (dBm)	Power Drift (%)	Scaling Factor	SAR _{1-g} results(W/kg)		Graph Results
								Measured	Reported	
measured / reported SAR numbers – Head <SIM1>										
4182	836.4	RMC*	Left Cheek	23.31	24.00	-0.04	1.172	0.044	0.052	
4182	836.4	RMC*	Left Tilt	23.31	24.00	0.51	1.172	0.021	0.025	
4182	836.4	RMC*	Right Cheek	23.31	24.00	-0.66	1.172	0.051	0.060	Plot 5
4182	836.4	RMC*	Right Tilt	23.31	24.00	1.69	1.172	0.026	0.030	
measured / reported SAR numbers - Body (hotspot open, distance 10mm) <SIM1>										
4182	836.4	RMC*	Front	23.31	24.00	-0.01	1.172	0.067	0.079	
4182	836.4	RMC*	Rear	23.31	24.00	-3.88	1.172	0.093	0.109	Plot 6
4182	836.4	RMC*	Left	23.31	24.00	-1.02	1.172	0.021	0.025	
4182	836.4	RMC*	Right	23.31	24.00	-3.21	1.172	0.055	0.064	
4182	836.4	RMC*	Bottom	23.31	24.00	-1.13	1.172	0.062	0.073	

Remark:

1. The value with black color is the maximum SAR Value of each test band.
2. Per FCC KDB Publication 447498 D01, if the reported (scaled) SAR measured at the middle channel or highest output power channel for each test configuration is ≤ 0.8 W/kg then testing at the other channels is optional for such test configuration(s).
3. RMC* - RMC 12.2kbps mode;

SAR Values [WCDMA Band II]

Ch.	Freq. (MHz)	Channel Type	Test Position	Conducted Power (dBm)	Maximum Allowed Power (dBm)	Power Drift (%)	Scaling Factor	SAR _{1-g} results(W/kg)		Graph Results
								Measured	Reported	
measured / reported SAR numbers – Head <SIM1>										
9538	1907.6	RMC	Left Cheek	23.43	24.00	-1.94	1.140	0.227	0.259	Plot 7
9538	1907.6	RMC	Left Tilt	23.43	24.00	-1.02	1.140	0.120	0.137	
9538	1907.6	RMC	Right Cheek	23.43	24.00	-0.52	1.140	0.168	0.192	
9538	1907.6	RMC	Right Tilt	23.43	24.00	3.69	1.140	0.103	0.117	
measured / reported SAR numbers - Body (hotspot open, distance 10mm) <SIM1>										
9400	1880.0	RMC	Front	23.43	24.00	3.28	1.140	0.265	0.302	
9400	1880.0	RMC	Rear	23.43	24.00	-0.27	1.140	0.429	0.489	Plot 8
9400	1880.0	RMC	Left	23.43	24.00	0.62	1.140	0.135	0.154	
9400	1880.0	RMC	Right	23.43	24.00	1.68	1.140	0.226	0.258	
9400	1880.0	RMC	Bottom	23.43	24.00	-2.58	1.140	0.243	0.277	

Remark:

1. The value with black color is the maximum SAR Value of each test band.
2. Per FCC KDB Publication 447498 D01, if the reported (scaled) SAR measured at the middle channel or highest output power channel for each test configuration is ≤ 0.8 W/kg then testing at the other channels is optional for such test configuration(s).
3. RMC* - RMC 12.2kbps mode;

SAR Values [LTE Band 2]

Ch.	Freq. (MHz)	Channel Type (20M)	Test Position	Conducted Power (dBm)	Maximum Allowed Power (dBm)	Power Drift (%)	Scaling Factor	SAR _{1-g} results(W/kg)		Graph Results
								Measured	Reported	
<i>measured / reported SAR numbers – Head <SIM1></i>										
18900	1880.0	1RB	Left Cheek	23.46	24.00	-0.64	1.132	0.169	0.191	Plot 9
18900	1880.0	1RB	Left Tilt	23.46	24.00	1.20	1.132	0.101	0.114	
18900	1880.0	1RB	Right Cheek	23.46	24.00	-1.63	1.132	0.135	0.153	
18900	1880.0	1RB	Right Tilt	23.46	24.00	-2.65	1.132	0.086	0.097	
18900	1880.0	50%RB	Left Cheek	22.37	23.00	-1.66	1.156	0.152	0.176	
18900	1880.0	50%RB	Left Tilt	22.37	23.00	0.54	1.156	0.095	0.110	
18900	1880.0	50%RB	Right Cheek	22.37	23.00	2.39	1.156	0.120	0.139	
18900	1880.0	50%RB	Right Tilt	22.37	23.00	-1.65	1.156	0.073	0.084	
<i>measured / reported SAR numbers - Body (hotspot open, distance 10mm) <SIM1></i>										
18900	1880.0	1RB	Front	23.46	24.00	-0.85	1.132	0.193	0.219	
18900	1880.0	1RB	Rear	23.46	24.00	-0.46	1.132	0.453	0.513	Plot 10
18900	1880.0	1RB	Left	23.46	24.00	-1.02	1.132	0.086	0.097	
18900	1880.0	1RB	Right	23.46	24.00	-1.28	1.132	0.162	0.183	
18900	1880.0	1RB	Bottom	23.46	24.00	1.96	1.132	0.185	0.209	
18900	1880.0	50%RB	Front	22.37	23.00	-2.25	1.156	0.169	0.195	
18900	1880.0	50%RB	Rear	22.37	23.00	-1.62	1.156	0.327	0.378	
18900	1880.0	50%RB	Left	22.37	23.00	1.08	1.156	0.049	0.057	
18900	1880.0	50%RB	Right	22.37	23.00	-2.56	1.156	0.126	0.146	
18900	1880.0	50%RB	Bottom	22.37	23.00	-1.25	1.156	0.157	0.182	

SAR Values [LTE Band 4]

Ch.	Freq. (MHz)	Channel Type (20M)	Test Position	Conducted Power (dBm)	Maximum Allowed Power (dBm)	Power Drift (%)	Scaling Factor	SAR _{1-g} results(W/kg)		Graph Results
								Measured	Reported	
<i>measured / reported SAR numbers – Head <SIM1></i>										
20300	1745.0	1RB	Left Cheek	22.33	23.00	1.17	1.167	0.165	0.193	Plot 11
20300	1745.0	1RB	Left Tilt	22.33	23.00	1.22	1.167	0.093	0.109	
20300	1745.0	1RB	Right Cheek	22.33	23.00	3.95	1.167	0.129	0.151	
20300	1745.0	1RB	Right Tilt	22.33	23.00	-1.05	1.167	0.078	0.091	
20300	1745.0	50%RB	Left Cheek	22.10	23.00	-1.67	1.230	0.136	0.167	
20300	1745.0	50%RB	Left Tilt	22.10	23.00	-1.05	1.230	0.095	0.117	
20300	1745.0	50%RB	Right Cheek	22.10	23.00	1.39	1.230	0.101	0.124	
20300	1745.0	50%RB	Right Tilt	22.10	23.00	-1.66	1.230	0.063	0.078	
<i>measured / reported SAR numbers - Body (hotspot open, distance 10mm) <SIM1></i>										
20300	1745.0	1RB	Front	22.33	23.00	-0.68	1.167	0.243	0.284	
20300	1745.0	1RB	Rear	22.33	23.00	-2.35	1.167	0.332	0.387	Plot 12
20300	1745.0	1RB	Left	22.33	23.00	1.72	1.167	0.101	0.118	
20300	1745.0	1RB	Right	22.33	23.00	-1.28	1.167	0.200	0.233	
20300	1745.0	1RB	Bottom	22.33	23.00	-1.96	1.167	0.226	0.264	
20300	1745.0	50%RB	Front	22.10	23.00	1.80	1.230	0.205	0.252	
20300	1745.0	50%RB	Rear	22.10	23.00	-0.64	1.230	0.268	0.330	
20300	1745.0	50%RB	Left	22.10	23.00	1.22	1.230	0.087	0.107	
20300	1745.0	50%RB	Right	22.10	23.00	2.97	1.230	0.150	0.185	
20300	1745.0	50%RB	Bottom	22.10	23.00	-2.94	1.230	0.192	0.236	

SAR Values [LTE Band 7]

Ch.	Freq. (MHz)	Channel Type (20M)	Test Position	Conducted Power (dBm)	Maximum Allowed Power (dBm)	Power Drift (%)	Scaling Factor	SAR _{1-g} results(W/kg)		Graph Results
								Measured	Reported	
measured / reported SAR numbers – Head <SIM1>										
21100	2535.0	1RB	Left Cheek	23.30	24.00	-2.99	1.175	0.131	0.154	
21100	2535.0	1RB	Left Tilt	23.30	24.00	-1.47	1.175	0.092	0.108	
21100	2535.0	1RB	Right Cheek	23.30	24.00	3.43	1.175	0.305	0.358	Plot 13
21100	2535.0	1RB	Right Tilt	23.30	24.00	-1.05	1.175	0.128	0.150	
21100	2535.0	50%RB	Left Cheek	22.26	23.00	2.42	1.186	0.106	0.126	
21100	2535.0	50%RB	Left Tilt	22.26	23.00	-0.26	1.186	0.079	0.094	
21100	2535.0	50%RB	Right Cheek	22.26	23.00	1.55	1.186	0.263	0.312	
21100	2535.0	50%RB	Right Tilt	22.26	23.00	-2.63	1.186	0.092	0.109	
measured / reported SAR numbers - Body (hotspot open, distance 10mm) <SIM1>										
21100	2535.0	1RB	Front	23.30	24.00	-3.17	1.175	0.212	0.249	
21100	2535.0	1RB	Rear	23.30	24.00	-0.49	1.175	0.237	0.278	Plot 14
21100	2535.0	1RB	Left	23.30	24.00	1.02	1.175	0.073	0.086	
21100	2535.0	1RB	Right	23.30	24.00	-1.54	1.175	0.153	0.180	
21100	2535.0	1RB	Bottom	23.30	24.00	-2.34	1.175	0.187	0.220	
21100	2535.0	50%RB	Front	22.26	23.00	2.91	1.186	0.201	0.238	
21100	2535.0	50%RB	Rear	22.26	23.00	-0.64	1.186	0.220	0.261	
21100	2535.0	50%RB	Left	22.26	23.00	-3.45	1.186	0.059	0.070	
21100	2535.0	50%RB	Right	22.26	23.00	4.51	1.186	0.139	0.165	
21100	2535.0	50%RB	Bottom	22.26	23.00	2.60	1.186	0.155	0.184	

Remark:

1. The value with black color is the maximum SAR Value of each test band.
2. Per FCC KDB Publication 447498 D01, if the reported (scaled) SAR measured at the middle channel or highest output power channel for each test configuration is ≤ 0.8 W/kg then testing at the other channels is optional for such test configuration(s).

SAR Values [WIFI2.4G]

Ch.	Freq. (MHz)	Service	Test Position	Conducted Power (dBm)	Maximum Allowed Power (dBm)	Power Drift (%)	Scaling Factor	SAR _{1-g} results(W/kg)		Graph Results
								Measured	Reported	
measured / reported SAR numbers – Head<SIM1>										
6	2437	DSSS	Left Cheek	12.21	13.00	-0.48	1.199	0.143	0.172	Plot 15
6	2437	DSSS	Left Tilt	12.21	13.00	-1.02	1.199	0.083	0.100	
6	2437	DSSS	Right Cheek	12.21	13.00	3.68	1.199	0.108	0.130	
6	2437	DSSS	Right Tilt	12.21	13.00	2.64	1.199	0.071	0.085	
measured / reported SAR numbers - Body (hotspot open, distance 10mm) <SIM1>										
6	2437	DSSS	Front	12.21	13.00	-0.68	1.199	0.075	0.090	
6	2437	DSSS	Rear	12.21	13.00	3.74	1.199	0.109	0.131	Plot16
6	2437	DSSS	Left	12.21	13.00	-1.01	1.199	0.040	0.048	
6	2437	DSSS	Top	12.21	13.00	-0.62	1.199	0.061	0.073	

Remark:

1. The value with blue color is the maximum SAR Value of each test band.
2. Per FCC KDB Publication 447498 D01, if the reported (scaled) SAR measured at the middle channel or highest output power channel for each test configuration is ≤ 0.8 W/kg then testing at the other channels is optional for such test configuration(s).
3. SAR is not required for the following 2.4 GHz OFDM conditions as the highest reported SAR for DSSS is adjusted by the ratio of OFDM to DSSS specified maximum output power and the adjusted SAR is $0.188[0.199*(28.97/30.62)] \leq 1.2$ W/Kg.

4.4.2 Standalone SAR Test Exclusion Considerations and Estimated SAR

Per KDB447498 requires when the standalone SAR test exclusion of section 4.3.1 is applied to an antenna that transmits simultaneously with other antennas, the standalone SAR must be estimated according to the following to determine simultaneous transmission SAR test exclusion;

• $(\text{max. power of channel, including tune-up tolerance, mW}) / (\text{min. test separation distance, mm}) \cdot [\sqrt{f(\text{GHz})} / x]$
W/kg for test separation distances ≤ 50 mm;

where $x = 7.5$ for 1-g SAR, and $x = 18.75$ for 10-g SAR.

• 0.4 W/kg for 1-g SAR and 1.0 W/kg for 10-g SAR, when the test separation distances is > 50 mm

Per FCC KD B447498 D01, simultaneous transmission SAR test exclusion may be applied when the sum of the 1-g SAR for all the transmitting antenna in a specific a physical test configuration is ≤ 1.6 W/Kg. When the sum is greater than the SAR limit, SAR test exclusion is determined by the SAR to peak location separation ratio.

$$\text{Ratio} = \frac{(\text{SAR}_1 + \text{SAR}_2)^{1.5}}{(\text{peak location separation, mm})} < 0.04$$

Estimated stand alone SAR					
Communication system	Frequency (MHz)	Configuration	Maximum Power (dBm)	Separation Distance (mm)	Estimated SAR _{1-g} (W/kg)
Bluetooth*	2450	Head	3.00	5	0.066
Bluetooth*	2450	Hotspot	3.00	10	0.033
Bluetooth*	2450	Body-worn	3.00	10	0.033

Remark:

1. Bluetooth*- Including Lower power Bluetooth
2. Maximum average power including tune-up tolerance;
3. When the minimum test separation distance is < 5 mm, a distance of 5 mm is applied to determine SAR test exclusion
4. Body as body use distance is 10mm from manufacturer declaration of user manual

4.5. Simultaneous TX SAR Considerations

4.5.1 Introduction

The following procedures adopted from "FCC SAR Considerations for Cell Phones with Multiple Transmitters" are applicable to handsets with built-in unlicensed transmitters such as 802.11 a/b/g/n and Bluetooth devices which may simultaneously transmit with the licensed transmitter.

For the DUT, the BT and WiFi modules sharing same antenna, GSM, WCDMA and LTE modules sharing a single antenna; BT/WLAN and GSM/UMTS/LTE can simultaneous transmit;

Application Simultaneous Transmission information:

Air-Interface	Band (MHz)	Type	Simultaneous Transmissions	Voice over Digital Transport(Data)
GSM	850	VO	Yes, WLAN or BT/BLE	N/A
	1900	VO		
	GPRS/EDGE	DT	Yes, WLAN or BT/BLE	N/A
WCDMA	Band II/ BandV	DT	Yes, WLAN or BT/BLE	N/A
LTE	Band2/Band4/Band7	DT	Yes, WLAN or BT/BLE	N/A
WLAN	2450	DT	Yes, GSM, GPRS, EDGE, UMTS, LTE	Yes
BT/BLE	2450	DT	Yes, GSM, GPRS, EDGE, UMTS, LTE	N/A

Note: VO-Voice Service only; DT-Digital Transport

Note:

BT and WLAN can be active at the same time, but only with interleaving of packages switched on board level. That means that they don't transmit at the same time.

BLE-Bluetooth low energy;

BT- Classical Bluetooth;

4.5.2 Evaluation of Simultaneous SAR

Head Exposure Conditions

Simultaneous transmission SAR for WiFi and GSM

Test Position	GSM850 Reported SAR _{1-g} (W/Kg)	GSM1900 Reported SAR _{1-g} (W/Kg)	WiFi2.4G Reported SAR _{1-g} (W/Kg)	MAX. Σ SAR _{1-g} (W/Kg)	SAR _{1-g} Limit (W/Kg)	Peak location separation ratio	Simut Meas. Required
Left Cheek	0.072	0.129	0.172	0.301	1.6	no	no
Left Tilt	0.040	0.083	0.100	0.183	1.6	no	no
Right Cheek	0.065	0.109	0.130	0.239	1.6	no	no
Right Tilt	0.037	0.068	0.085	0.153	1.6	no	no

Simultaneous transmission SAR for WiFi and UMTS

Test Position	UMTS Band V Reported SAR _{1-g} (W/Kg)	UMTS Band II Reported SAR _{1-g} (W/Kg)	WiFi2.4G Reported SAR _{1-g} (W/Kg)	MAX. Σ SAR _{1-g} (W/Kg)	SAR _{1-g} Limit (W/Kg)	Peak location separation ratio	Simut Meas. Required
Left Cheek	0.052	0.259	0.172	0.431	1.6	no	no
Left Tilt	0.025	0.137	0.100	0.237	1.6	no	no
Right Cheek	0.060	0.192	0.130	0.322	1.6	no	no
Right Tilt	0.030	0.117	0.085	0.202	1.6	no	no

Simultaneous transmission SAR for WiFi and LTE

Test Position	LTE Band2 Reported SAR _{1-g} (W/Kg)	LTE Band4 Reported SAR _{1-g} (W/Kg)	LTE Band7 Reported SAR _{1-g} (W/Kg)	WiFi2.4G Reported SAR _{1-g} (W/Kg)	MAX. Σ SAR _{1-g} (W/Kg)	SAR _{1-g} Limit (W/Kg)	Peak location separation ratio	Simut Meas. Required
Left Cheek	0.191	0.193	0.154	0.172	0.365	1.6	no	no
Left Tilt	0.114	0.109	0.108	0.100	0.214	1.6	no	no
Right Cheek	0.153	0.151	0.358	0.130	0.488	1.6	no	no
Right Tilt	0.097	0.091	0.150	0.085	0.235	1.6	no	no

Simultaneous transmission SAR for BT and GSM

Test Position	GSM850 Reported SAR _{1-g} (W/Kg)	GSM1900 Reported SAR _{1-g} (W/Kg)	BT Estimated SAR _{1-g} (W/Kg)	MAX. Σ SAR _{1-g} (W/Kg)	SAR _{1-g} Limit (W/Kg)	Peak location separation ratio	Simut Meas. Required
Left Cheek	0.072	0.329	0.066	0.395	1.6	no	no
LeftTilt	0.040	0.138	0.066	0.204	1.6	no	no
Right Cheek	0.065	0.274	0.066	0.340	1.6	no	no
Right Tilt	0.037	0.114	0.066	0.180	1.6	no	no

Simultaneous transmission SAR for BT and UMTS

Test Position	UMTS Band V Reported SAR _{1-g} (W/Kg)	UMTS Band II Reported SAR _{1-g} (W/Kg)	BT Estimated SAR _{1-g} (W/Kg)	MAX. Σ SAR _{1-g} (W/Kg)	SAR _{1-g} Limit (W/Kg)	Peak location separation ratio	Simut Meas. Required
Left Cheek	0.052	0.259	0.066	0.325	1.6	no	no
LeftTilt	0.025	0.137	0.066	0.203	1.6	no	no
RightChek	0.060	0.192	0.066	0.258	1.6	no	no
Right Tilt	0.030	0.117	0.066	0.183	1.6	no	no

Simultaneous transmission SAR for BT and LTE

Test Position	LTE Band2 Reported SAR _{1-g} (W/Kg)	LTE Band4 Reported SAR _{1-g} (W/Kg)	LTE Band7 Reported SAR _{1-g} (W/Kg)	BT Reported SAR _{1-g} (W/Kg)	MAX. Σ SAR _{1-g} (W/Kg)	SAR _{1-g} Limit (W/Kg)	Peak location separation ratio	Simut Meas. Required
Left Cheek	0.191	0.193	0.154	0.066	0.259	1.6	no	no
Left Tilt	0.114	0.109	0.108	0.066	0.180	1.6	no	no
Right Cheek	0.153	0.151	0.358	0.066	0.424	1.6	no	no
Right Tilt	0.097	0.091	0.150	0.066	0.216	1.6	no	no

Body Hotspot Exposure Conditions**Simultaneous transmission SAR for WiFi and GSM**

Test Position	GSM850 Reported SAR _{1-g} (W/Kg)	GSM1900 Reported SAR _{1-g} (W/Kg)	WiFi2.4G Reported SAR _{1-g} (W/Kg)	MAX. Σ SAR _{1-g} (W/Kg)	SAR _{1-g} Limit (W/Kg)	Peak location separation ratio	Simut Meas. Required
Front	0.092	0.161	0.090	0.251	1.6	no	no
Rear	0.161	0.276	0.131	0.407	1.6	no	no
Left	0.021	0.043	0.048	0.091	1.6	no	no
Right	0.054	0.099	/	0.258	1.6	no	no
Bottom	0.084	0.132	/	0.277	1.6	no	no
Top	/	/	0.073	0.073	1.6	no	no

Simultaneous transmission SAR for WiFi and UMTS

Test Position	UMTS Band V Reported SAR _{1-g} (W/Kg)	UMTS Band II Reported SAR _{1-g} (W/Kg)	WiFi2.4G Reported SAR _{1-g} (W/Kg)	MAX. Σ SAR _{1-g} (W/Kg)	SAR _{1-g} Limit (W/Kg)	Peak location separation ratio	Simut Meas. Required
Front	0.079	0.302	0.090	0.392	1.6	no	no
Rear	0.109	0.489	0.131	0.620	1.6	no	no
Left	0.025	0.154	0.048	0.202	1.6	no	no
Right	0.064	0.258	/	0.258	1.6	no	no
Bottom	0.073	0.277	/	0.277	1.6	no	no
Top	/	/	0.073	0.073	1.6	no	no

Simultaneous transmission SAR for WiFi and LTE

Test Position	LTE Band2 Reported SAR _{1-g} (W/Kg)	LTE Band4 Reported SAR _{1-g} (W/Kg)	LTE Band7 Reported SAR _{1-g} (W/Kg)	WiFi2.4G Reported SAR _{1-g} (W/Kg)	MAX. Σ SAR _{1-g} (W/Kg)	SAR _{1-g} Limit (W/Kg)	Peak location separation ratio	Simut Meas. Required
Front	0.219	0.284	0.249	0.090	0.374	1.6	no	no
Rear	0.513	0.387	0.278	0.131	0.644	1.6	no	no
Left	0.097	0.118	0.086	0.048	0.162	1.6	no	no
Right	0.183	0.233	0.180	/	0.233	1.6	no	no
Bottom	0.209	0.264	0.220	/	0.264	1.6	no	no
Top	/	/	/	0.073	0.073	1.6	no	no

Simultaneous transmission SAR for BT and GSM

Test Position	GSM850 Reported SAR _{1-g} (W/Kg)	GSM1900 Reported SAR _{1-g} (W/Kg)	BT Estimated SAR _{1-g} (W/Kg)	MAX. Σ SAR _{1-g} (W/Kg)	SAR _{1-g} Limit (W/Kg)	Peak location separation ratio	Simut Meas. Required
Front	0.092	0.161	0.033	0.194	1.6	no	no
Rear	0.161	0.276	0.033	0.309	1.6	no	no
Left	0.021	0.043	0.033	0.076	1.6	no	no
Right	0.054	0.099	/	0.099	1.6	no	no
Bottom	0.084	0.132	/	0.132	1.6	no	no
Top	/	/	0.033	0.033	1.6	no	no

Simultaneous transmission SAR for BT and UMTS

Test Position	UMTS Band V Reported SAR _{1-g} (W/Kg)	UMTS Band II Reported SAR _{1-g} (W/Kg)	BT Estimated SAR _{1-g} (W/Kg)	MAX. Σ SAR _{1-g} (W/Kg)	SAR _{1-g} Limit (W/Kg)	Peak location separation ratio	Simut Meas. Required
Front	0.079	0.302	0.033	0.335	1.6	no	no
Rear	0.109	0.489	0.033	0.522	1.6	no	no
Left	0.025	0.154	0.033	0.187	1.6	no	no
Right	0.064	0.258	/	0.258	1.6	no	no
Bottom	0.073	0.277	/	0.299	1.6	no	no
Top	/	/	0.033	0.033	1.6	no	no

Simultaneous transmission SAR for BT and LTE

Test Position	LTE Band2 Reported SAR _{1-g} (W/Kg)	LTE Band4 Reported SAR _{1-g} (W/Kg)	LTE Band7 Reported SAR _{1-g} (W/Kg)	BT Estimated SAR _{1-g} (W/Kg)	MAX. Σ SAR _{1-g} (W/Kg)	SAR _{1-g} Limit (W/Kg)	Peak location separation ratio	Simut Meas. Required
Front	0.219	0.284	0.249	0.033	0.317	1.6	no	no
Rear	0.513	0.387	0.278	0.033	0.546	1.6	no	no
Left	0.097	0.118	0.086	0.033	0.151	1.6	no	no
Right	0.183	0.233	0.180	/	0.233	1.6	no	no
Bottom	0.209	0.264	0.220	/	0.264	1.6	no	no
Top	/	/	/	0.033	0.033	1.6	no	no

Note:

1. The WiFi and BT share same antenna, so cannot transmit at same time.
2. The value with block color is the maximum values of standalone
3. The value with blue color is the maximum values of Σ SAR_{1-g}

4.6. SAR Measurement Variability

According to KDB865664, Repeated measurements are required only when the measured SAR is ≥ 0.80 W/kg. If the measured SAR value of the initial repeated measurement is < 1.45 W/kg with $\leq 20\%$ variation, only one repeated measurement is required to reaffirm that the results are not expected to have substantial variations, which may introduce significant compliance concerns. A second repeated measurement is required only if the measured result for the initial repeated measurement is within 10% of the SAR limit and vary by more than 20%, which are often related to device and measurement setup difficulties. The following procedures are applied to determine if repeated measurements are required. The same procedures should be adapted for measurements according to extremity and occupational exposure limits by applying a factor of 2.5 for extremity exposure and a factor of 5 for occupational exposure to the corresponding SAR thresholds.19 The repeated measurement results must be clearly identified in the SAR report. All measured SAR, including the repeated results, must be considered to determine compliance and for reporting according to KDB 690783. Repeated measurement is not required when the original highest measured SAR is < 0.80 W/kg; steps 2) through 4) do not apply.

- 3) When the original highest measured SAR is ≥ 0.80 W/kg, repeat that measurement once.
- 4) Perform a second repeated measurement only if the ratio of largest to smallest SAR for the original and first repeated measurements is > 1.20 or when the original or repeated measurement is ≥ 1.45 W/kg ($\sim 10\%$ from the 1-g SAR limit).
- 5) Perform a third repeated measurement only if the original, first or second repeated measurement is ≥ 1.5 W/kg and the ratio of largest to smallest SAR for the original, first and second repeated measurements is > 1.20 .

- 6) Perform a third repeated measurement only if the original, first or second repeated measurement is ≥ 1.5 W/kg and the ratio of largest to smallest SAR for the original, first and second repeated measurements is > 1.20

Frequency Band (MHz)	Air Interface	RF Exposure Configuration	Test Position	Repeated SAR (yes/no)	Highest Measured SAR _{1-g} (W/Kg)	First Repeated	
						Measured SAR _{1-g} (W/Kg)	Largest to Smallest SAR Ratio
850	GSM850	Standalone	Body-Rear	no	0.161	n/a	n/a
	WCDMA Band V	Standalone	Body-Rear	no	0.093	n/a	n/a
1800	LTE Band 4	Standalone	Body-Rear	no	0.332	n/a	n/a
1900	GSM1900	Standalone	Body-Rear	no	0.264	n/a	n/a
	WCDMA Band II	Standalone	Body-Rear	no	0.429	n/a	n/a
	LTE Band 2	Standalone	Body-Rear	no	0.453	n/a	n/a
2450	2.4GWLAN	Standalone	Cheek-Left	no	0.143	n/a	n/a
2600	LTE Band 7	Standalone	Cheek-Right	no	0.305	n/a	n/a

Remark:

1. *Second Repeated Measurement is not required since the ratio of the largest to smallest SAR for the original and first repeated measurement is not > 1.20 or 3 (1-g or 10-g respectively)*

4.7. General description of test procedures

- The DUT is tested using CMU 200 communications testers as controller unit to set test channels and maximum output power to the DUT, as well as for measuring the conducted peak power.
- Test positions as described in the tables above are in accordance with the specified test standard.
- Tests in body position were performed in that configuration, which generates the highest time based averaged output power (see conducted power results).
- Tests in head position with GSM were performed in voice mode with 1 timeslot unless GPRS/EGPRS/DTM function allows parallel voice and data traffic on 2 or more timeslots.
- UMTS was tested in RMC mode with 12.2 kbit/s and TPC bits set to 'all 1'.
- WiFi was tested in 802.11b/g/n mode with 1 Mbit/s and 6 Mbit/s. According to KDB 248227 the SAR testing for 802.11g/n is not required since When the highest reported SAR for DSSS is adjusted by the ratio of OFDM to DSSS specified maximum output power and the adjusted SAR is ≤ 1.2 W/kg.
- Required WiFi test channels were selected according to KDB 248227
- According to FCC KDB pub 248227 D01, When there are multiple test channels with the same measured maximum output power, the channel closest to mid-band frequency is selected for SAR measurement and when there are multiple test channels with the same measured maximum output power and equal separation from mid-band frequency; for example, high and low channels or two mid-band channels, the higher frequency (number) channel is selected for SAR measurement.
- According to FCC KDB pub 941225 D06 this device has been tested with 10 mm distance to the phantom for operation in WiFi hot spot mode.
- Per FCC KDB pub 941225 D06 the edges with antennas within 2.5 cm are required to be evaluated for SAR to cover WiFi hot spot function.
- According to IEEE 1528 the SAR test shall be performed at middle channel. Testing of top and bottom channel is optional.
- According to KDB 447498 D01 testing of other required channels within the operating mode of a frequency band is not required when the reported 1-g or 10-g SAR for the mid-band or highest output power channel is:
 - ≤ 0.8 W/kg or 2.0 W/kg, for 1-g or 10-g respectively, when the transmission band is ≤ 100 MHz
 - ≤ 0.6 W/kg or 1.5 W/kg, for 1-g or 10-g respectively, when the transmission band is between 100 MHz and 200 MHz
 - ≤ 0.4 W/kg or 1.0 W/kg, for 1-g or 10-g respectively, when the transmission band is ≥ 200 MHz
- IEEE 1528-2003 require the middle channel to be tested first. This generally applies to wireless devices that are designed to operate in technologies with tight tolerances for maximum output power variations across channels in the band.
- Per KDB648474 D04 require when the reported SAR for a body-worn accessory, measured without a headset connected to the handset, is < 1.2 W/kg.
- Per KDB648474 D04 require when the separation distance required for body-worn accessory testing is larger than or equal to that tested for hotspot mode, using the same wireless mode test configuration for voice and data, such as UMTS, LTE and Wi-Fi, and for the same surface of the phone, the hotspot mode SAR data may be used to support body-worn accessory SAR compliance for that particular configuration (surface)
- 10-g extremity SAR is required only for the surfaces and edges with hotspot mode 1-g SAR > 1.2 W/kg.

17. Per KDB648474 D04 require for phablet SAR test considerations. For 4G Smartphones with a display diagonal dimension > 15.0 cm or an overall diagonal dimension > 16.0 cm, When hotspot mode applies, 10-g extremity SAR is required only for the surfaces and edges with hotspot mode 1-g reported SAR > 1.2 W/kg.
18. 10-g extremity SAR is required only for the surfaces and edges with hotspot mode 1-g SAR > 1.2 W/kg.

4.8. Measurement Uncertainty (450MHz-6GHz)

Not required as SAR measurement uncertainty analysis is required in SAR reports only when the highest measured SAR in a frequency band is ≥ 1.5 W/kg for 1-g SAR according to KDB865664D01.

4.9. System Check Results

Test mode:835MHz(Head)
 Product Description:Validation
 Model:Dipole SID835
 E-Field Probe:SSE2(SN 45/15 EPGO281)
 Test Date:Oct 10, 2018

Medium(liquid type)	HSL_850
Frequency (MHz)	835.0000
Relative permittivity (real part)	41.92
Conductivity (S/m)	0.88
Input power	100mW
Crest Factor	1.0
Conversion Factor	1.78
Variation (%)	-3.620000
SAR 10g (W/Kg)	0.918695
SAR 1g (W/Kg)	0.637581

SURFACE SAR

VOLUME SAR

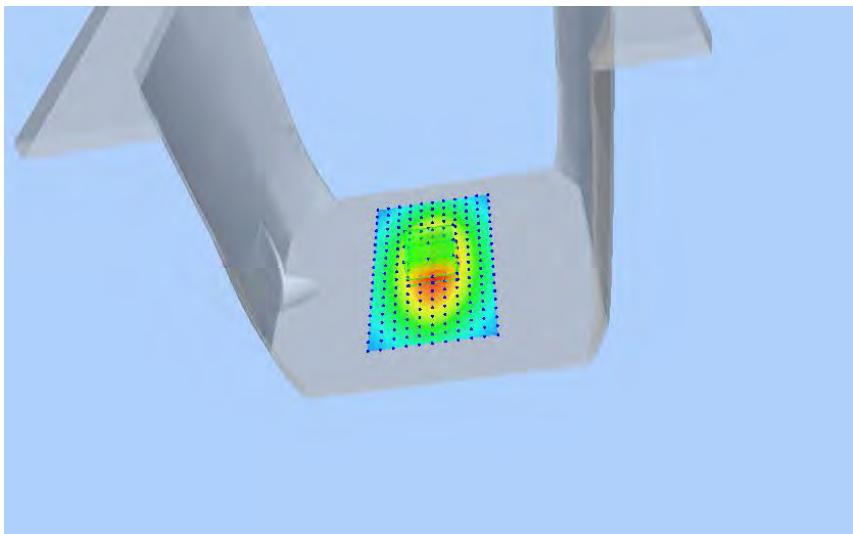
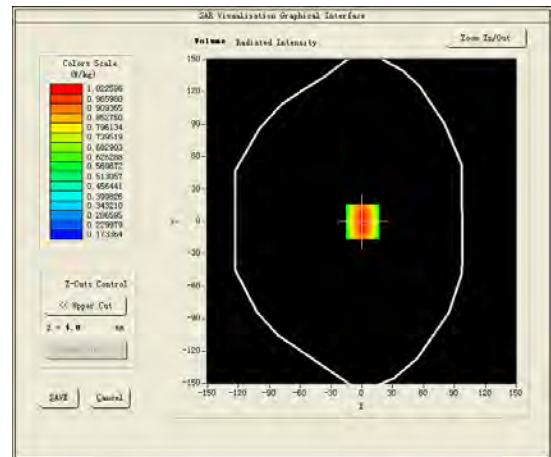
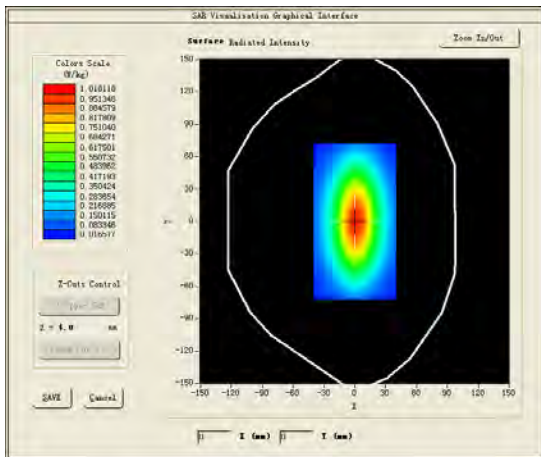

Test mode:835MHz(Body)
 Product Description:Validation
 Model:Dipole SID835
 E-Field Probe:SSE2(SN 45/15 EPGO281)
 Test Date: Oct 11, 2018

Medium(liquid type)	MSL_850
Frequency (MHz)	835.0000
Relative permittivity (real part)	54.61
Conductivity (S/m)	0.96
Input power	100mW
Crest Factor	1.0
Conversion Factor	1.85
Variation (%)	-0.680000
SAR 10g (W/Kg)	0.636582
SAR 1g (W/Kg)	0.977524

SURFACE SAR

VOLUME SAR

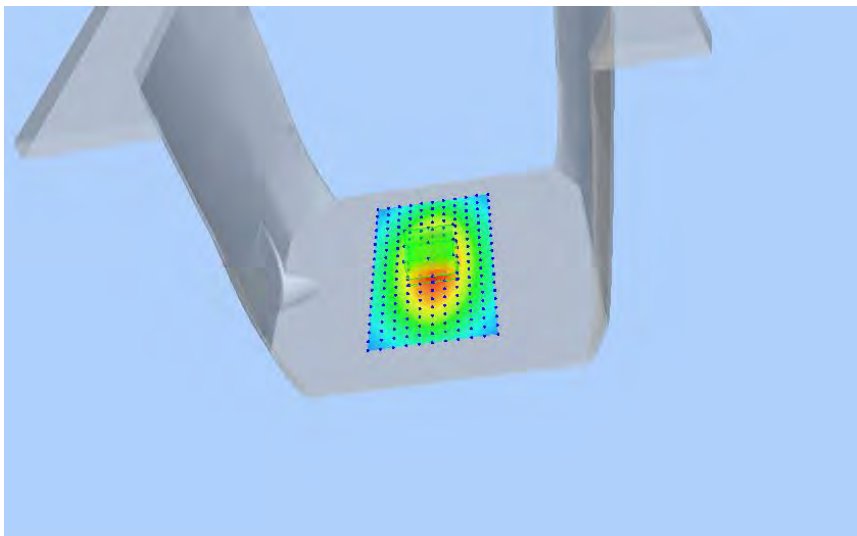
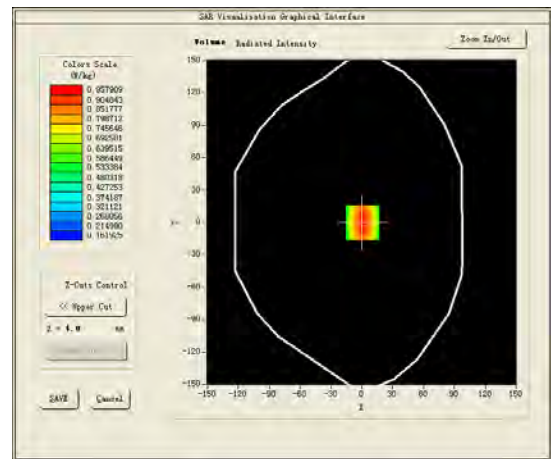
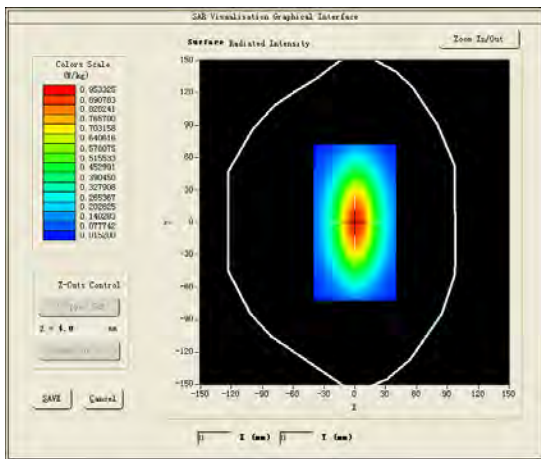

Test mode:1800MHz(Head)
 Product Description:Validation
 Model :Dipole SID1800
 E-Field Probe:SSE2(SN 45/15 EPGO281)
 Test Date: Oct 12, 2018

Medium(liquid type)	HSL_1800
Frequency (MHz)	1800.0000
Relative permittivity (real part)	39.65
Conductivity (S/m)	1.41
Input power	100mW
Crest Factor	1.0
Conversion Factor	1.83
Variation (%)	-3.620000
SAR 10g (W/Kg)	2.014625
SAR 1g (W/Kg)	3.837542

SURFACE SAR

VOLUME SAR

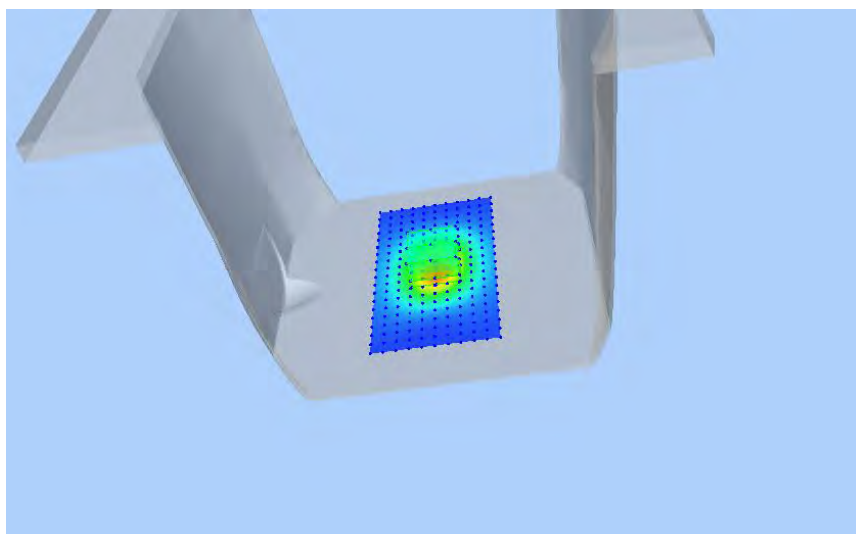
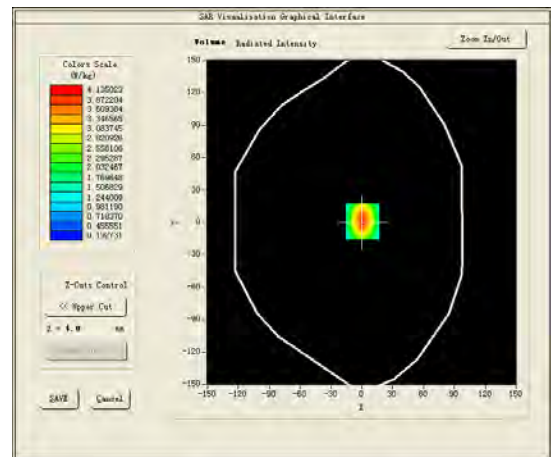
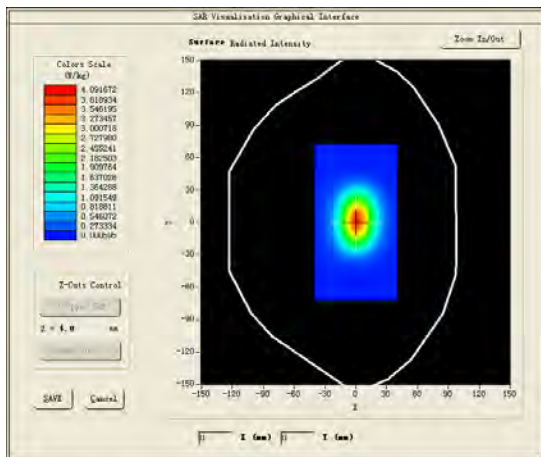

Test mode:1800MHz(Body)
 Product Description:Validation
 Model :Dipole SID1800
 E-Field Probe:SSE2(SN 45/15 EPGO281)
 Test Date: Oct 15, 2018

Medium(liquid type)	MSL_1800
Frequency (MHz)	1800.0000
Relative permittivity (real part)	52.47
Conductivity (S/m)	1.54
Input power	100mW
Crest Factor	1.0
Conversion Factor	1.87
Variation (%)	-0.620000
SAR 10g (W/Kg)	2.135684
SAR 1g (W/Kg)	4.077542

SURFACE SAR

VOLUME SAR

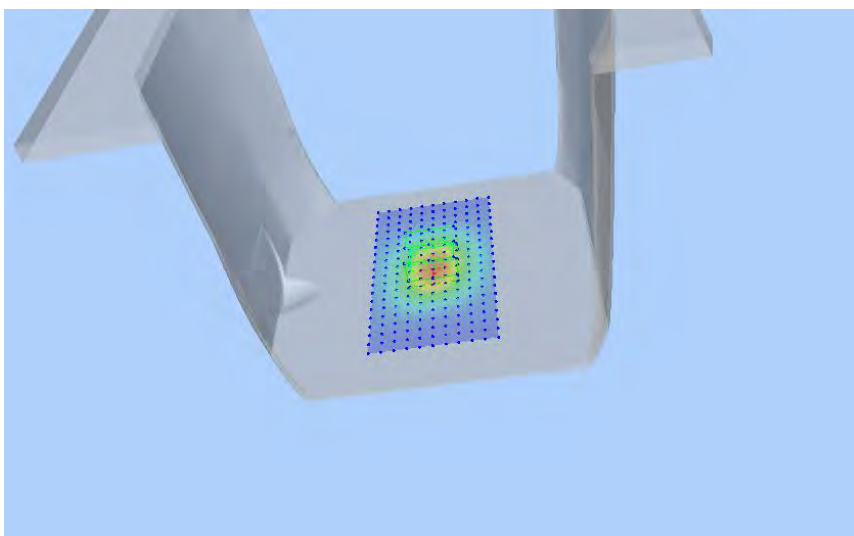
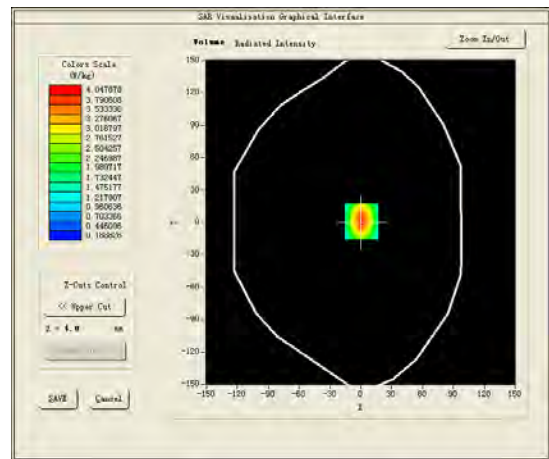
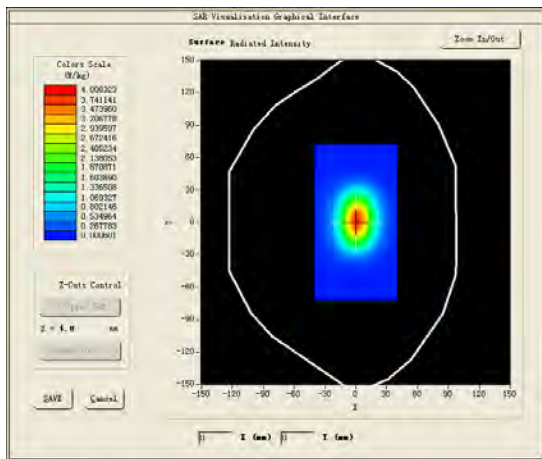

Test mode:1900MHz(Head)
 Product Description:Validation
 Model :Dipole SID1900
 E-Field Probe: SSE2(SN 45/15 EPGO281)
 Test Date: Oct 16, 2018

Medium(liquid type)	HSL_1900
Frequency (MHz)	1900.0000
Relative permittivity (real part)	41.07
Conductivity (S/m)	1.42
Input power	100mW
Crest Factor	1.0
Conversion Factor	2.10
Variation (%)	-1.070000
SAR 10g (W/Kg)	2.006254
SAR 1g (W/Kg)	3.917542

SURFACE SAR

VOLUME SAR

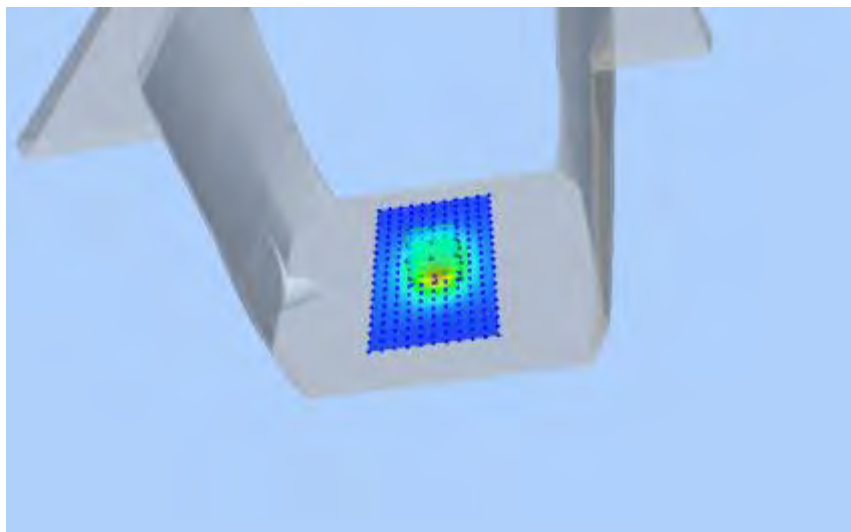
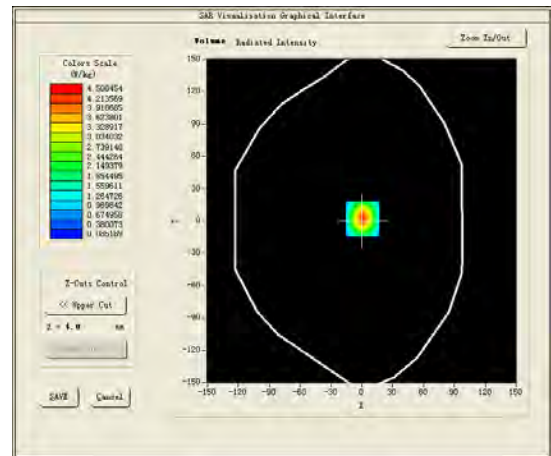
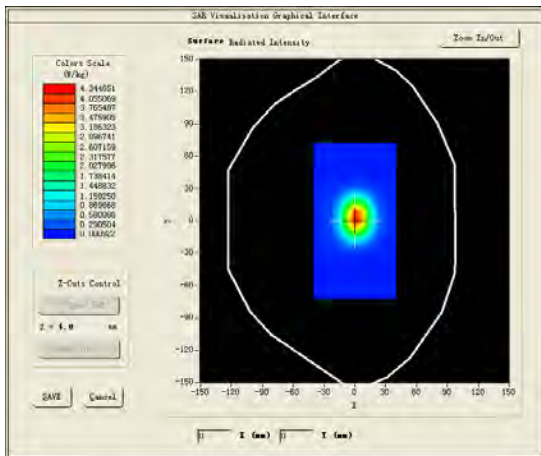

Test mode:1900MHz(Body)
 Product Description:Validation
 Model :Dipole SID1900
 E-Field Probe: SSE2(SN 45/15 EPGO281)
 Test Date: Oct 17, 2018

Medium(liquid type)	MSL_1900
Frequency (MHz)	1900.0000
Relative permittivity (real part)	54.71
Conductivity (S/m)	1.53
Input power	100mW
Crest Factor	1.0
Conversion Factor	2.16
Variation (%)	3.200000
SAR 10g (W/Kg)	2.117251
SAR 1g (W/Kg)	4.275285

SURFACE SAR

VOLUME SAR

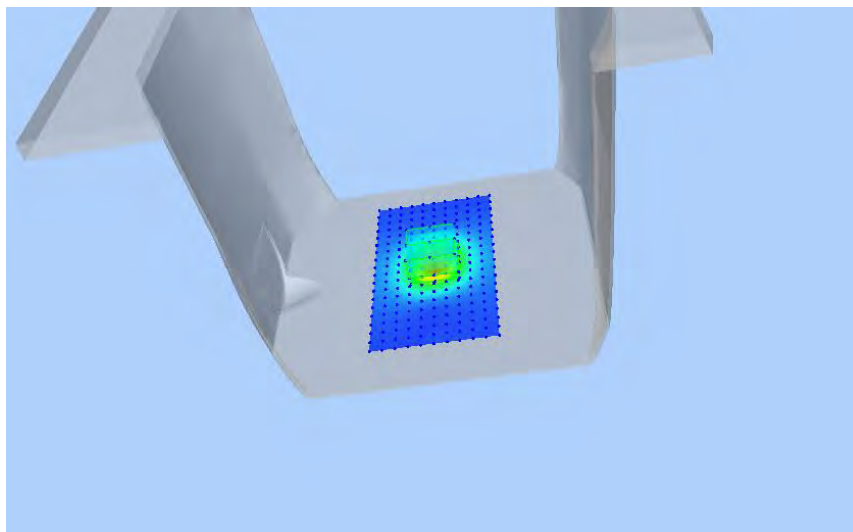
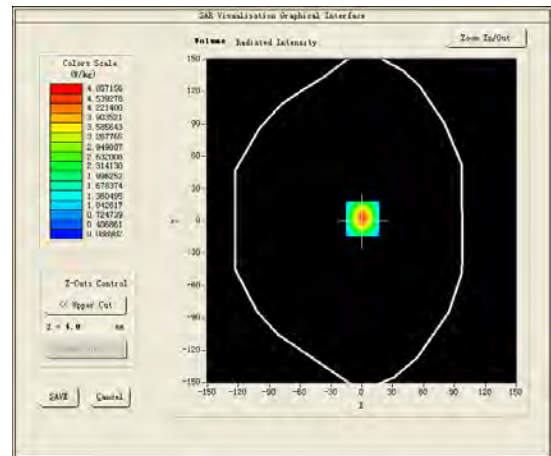
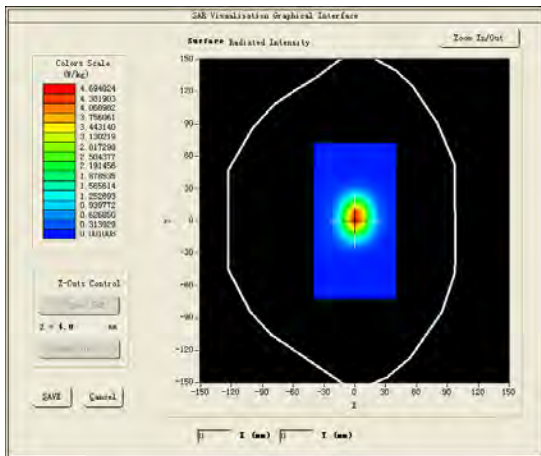

Test mode:2450MHz(Head)
 Product Description:Validation
 Model:Dipole SID2450
 E-Field Probe:SSE2(SN 45/15 EPGO281)
 Test Date: Oct 18, 2018

Medium(liquid type)	HSL_2450
Frequency (MHz)	2450.0000
Relative permittivity (real part)	39.51
Conductivity (S/m)	1.78
Input power	100mW
Crest Factor	1.0
Conversion Factor	2.21
Variation (%)	-1.330000
SAR 10g (W/Kg)	2.383654
SAR 1g (W/Kg)	5.255842

SURFACE SAR

VOLUME SAR

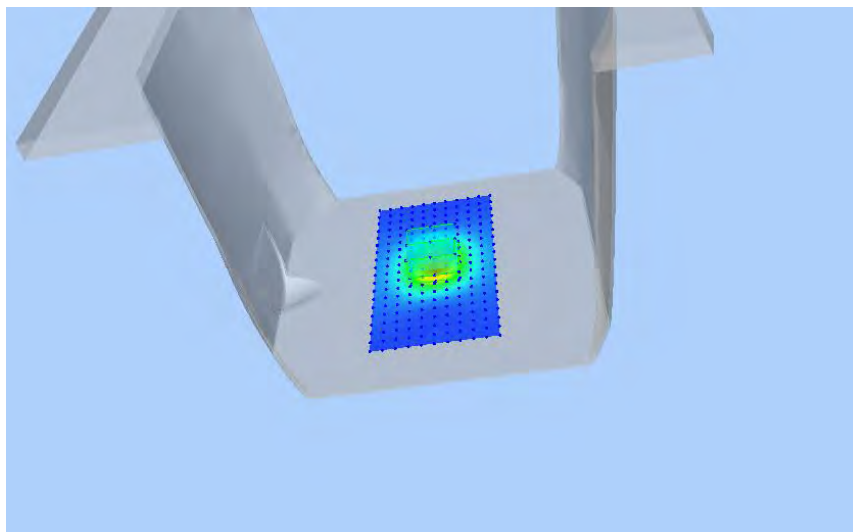
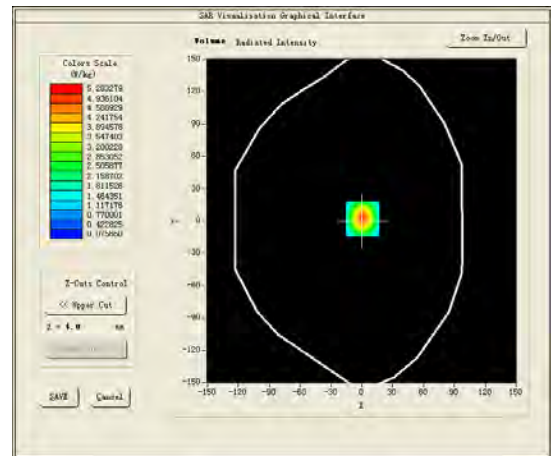
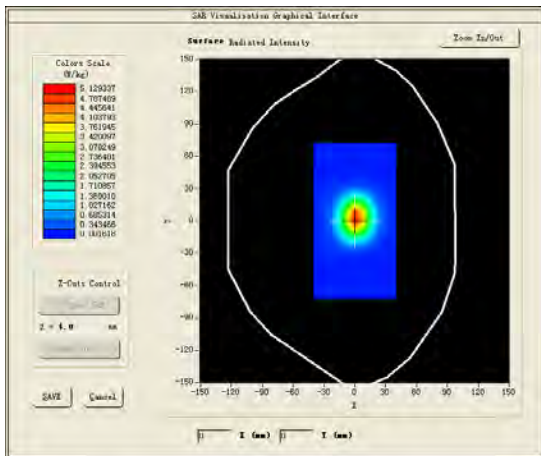

Test mode:2450MHz(Body)
 Product Description:Validation
 Model:Dipole SID2450
 E-Field Probe:SSE2(SN 45/15 EPGO281)
 Test Date: Oct 19, 2018

Medium(liquid type)	MSL_2450
Frequency (MHz)	2450.0000
Relative permittivity (real part)	51.54
Conductivity (S/m)	1.97
Input power	100mW
Crest Factor	1.0
Conversion Factor	2.28
Variation (%)	-0.250000
SAR 10g (W/Kg)	2.386584
SAR 1g (W/Kg)	5.244425

SURFACE SAR

VOLUME SAR

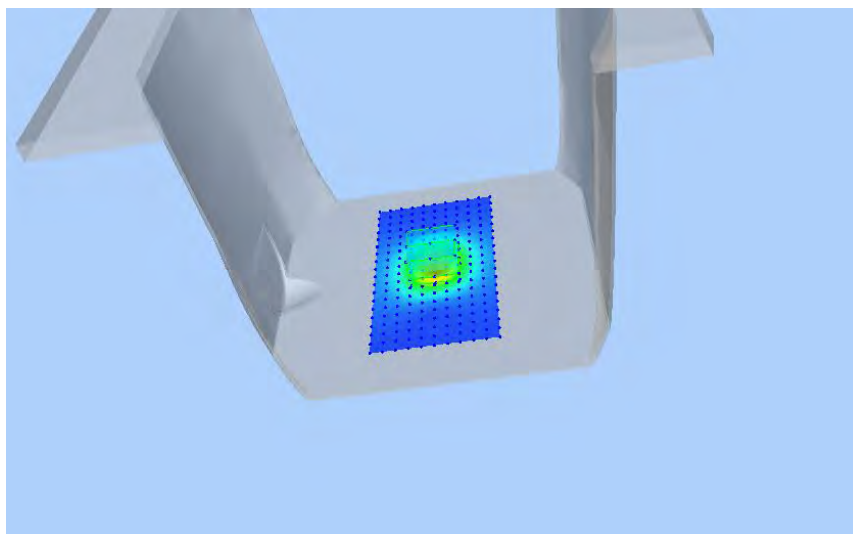
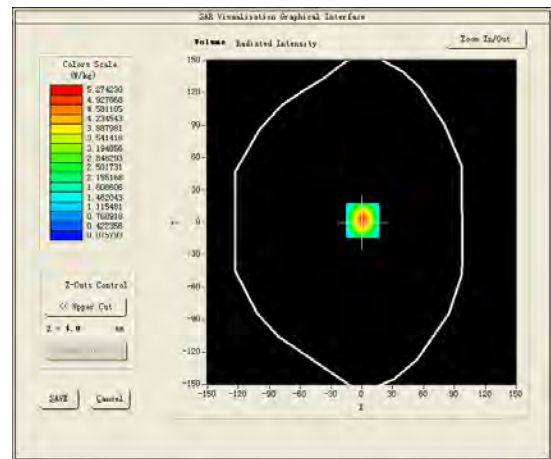
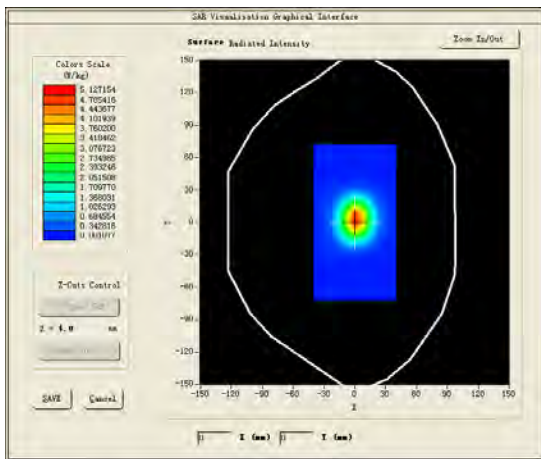

Test mode:2600MHz(Head)
 Product Description:Validation
 Model:Dipole SID2600
 E-Field Probe:SSE2(SN 45/15 EPGO281)
 Test Date: Oct 22, 2018

Medium(liquid type)	HSL_2600
Frequency (MHz)	2600.0000
Relative permittivity (real part)	39.55
Conductivity (S/m)	1.91
Input power	100mW
Crest Factor	1.0
Conversion Factor	2.32
Variation (%)	1.210000
SAR 10g (W/Kg)	2.346352
SAR 1g (W/Kg)	5.474758

SURFACE SAR

VOLUME SAR

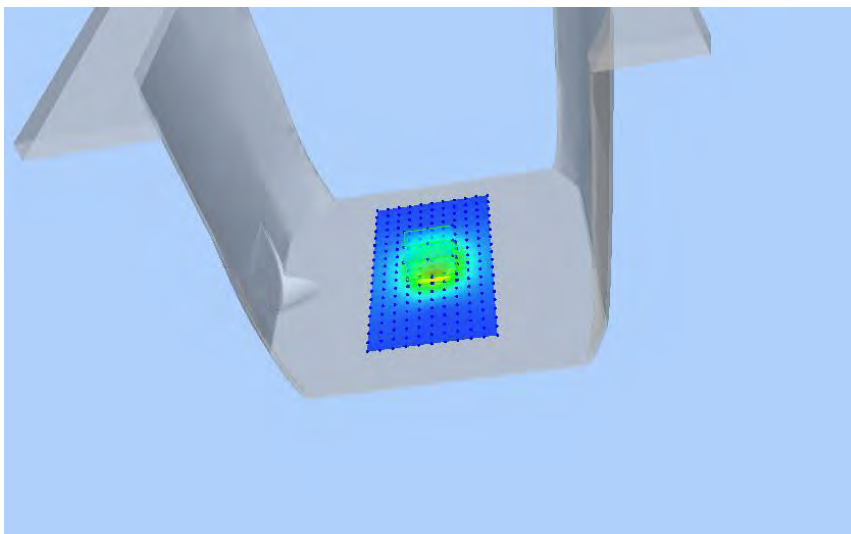
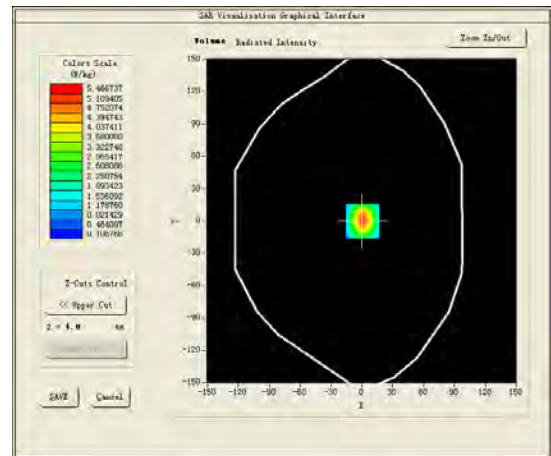
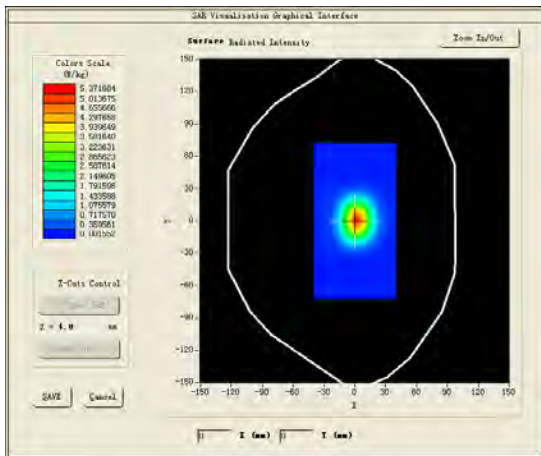

Test mode:2600MHz(Body)
 Product Description:Validation
 Model:Dipole SID2600
 E-Field Probe:SSE2(SN 45/15 EPGO281)
 Test Date: Oct 23, 2018

Medium(liquid type)	MSL_2600
Frequency (MHz)	2600.0000
Relative permittivity (real part)	51.35
Conductivity (S/m)	2.18
Input power	100mW
Crest Factor	1.0
Conversion Factor	2.38
Variation (%)	-4.300000
SAR 10g (W/Kg)	2.435824
SAR 1g (W/Kg)	5.587584

SURFACE SAR

VOLUME SAR

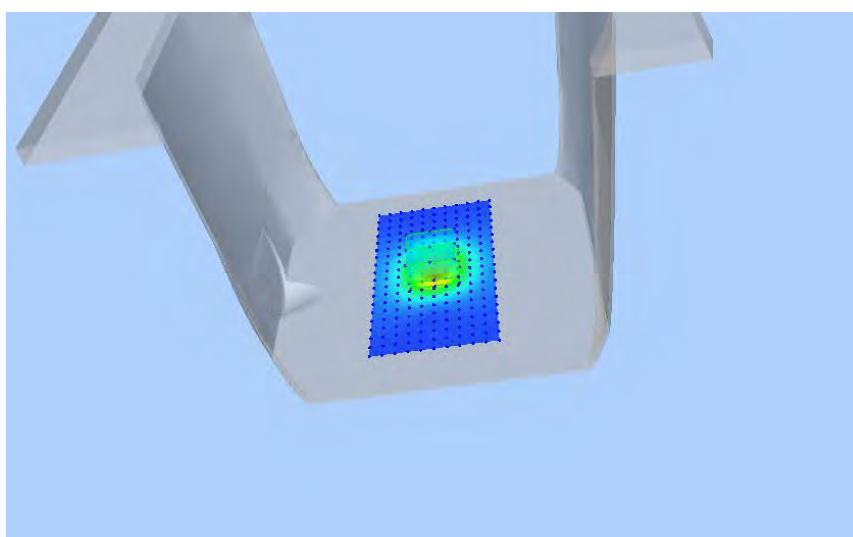
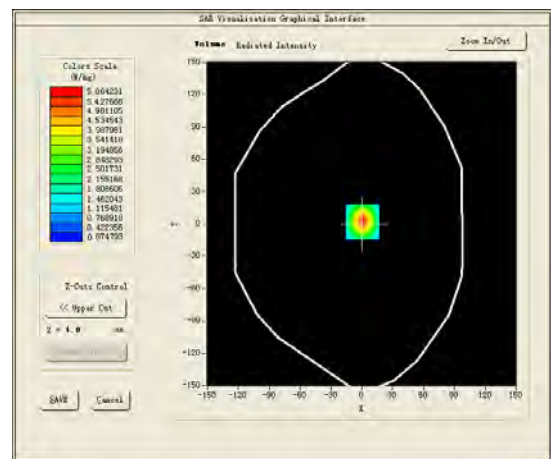
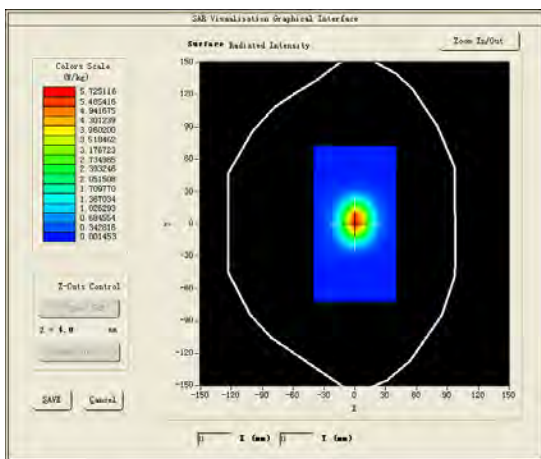

4.10 SAR Test Graph Results

SAR plots for the highest measured SAR in each exposure configuration, wireless mode and frequency band combination according to FCC KDB 865664 D02;

#1

Test Mode:GSM 850MHz,High channel(Head Left Cheek)

Product Description: 4G Smartphone

Model: T50

Test Date:Oct 10, 2018

Medium(liquid type)	HSL 850
Frequency (MHz)	848.8000
Relative permittivity (real part)	41.92
Conductivity (S/m)	0.88
E-Field Probe	SN 45/15 EPGO281
Crest Factor	8
Conversion Factor	1.78
Sensor	4mm
Area Scan	dx=8mm dy=8mm
Zoom Scan	5x5x7,dx=8mm dy=8mm dz=5mm
Variation (%)	2.750000
SAR 10g (W/Kg)	0.046520
SAR 1g (W/Kg)	0.063700
SURFACE SAR	VOLUME SAR

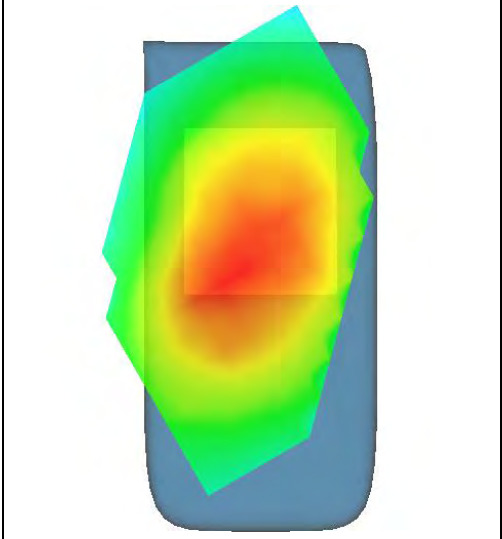
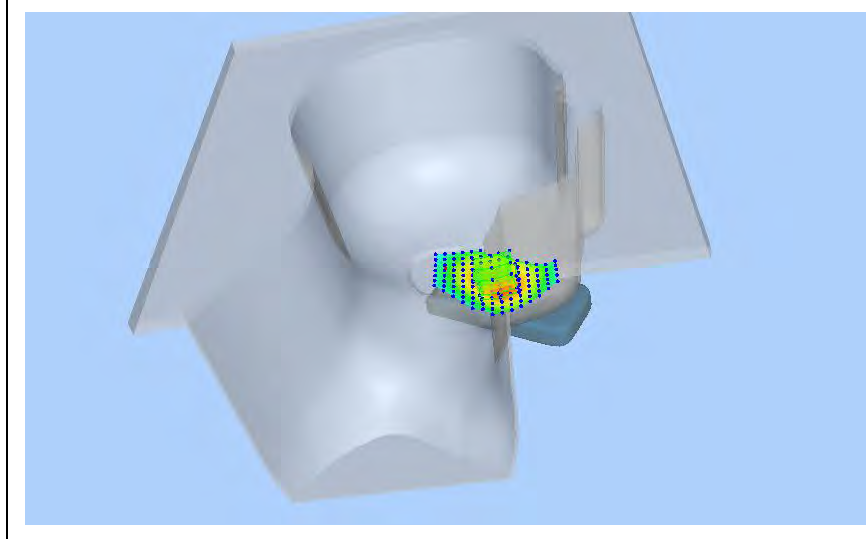
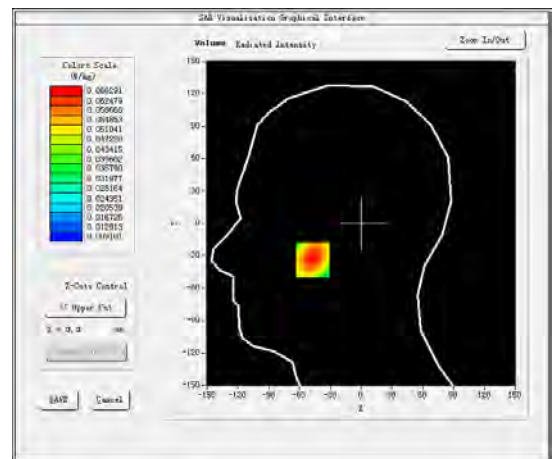
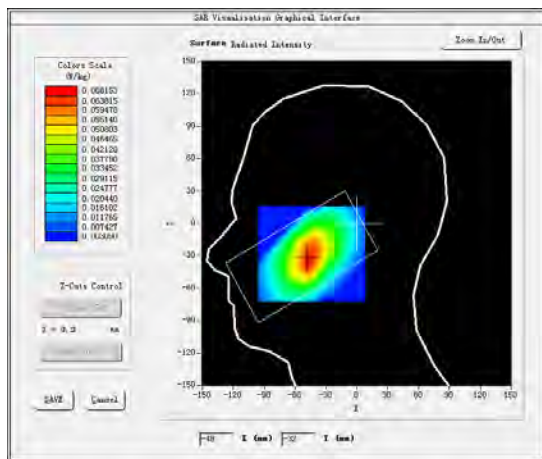

#2

Test Mode: Hotspot GSM850MHz,High channel(Body Rear Side)

Product Description: 4G Smartphone

Model: T50

Test Date: Oct 11, 2018

Medium(liquid type)	MSL 850
Frequency (MHz)	848.8000
Relative permittivity (real part)	54.61
Conductivity (S/m)	0.96
E-Field Probe	SN 45/15 EPGO281
Crest Factor	2.67
Conversion Factor	1.85
Sensor	4mm
Area Scan	dx=8mm dy=8mm
Zoom Scan	5x5x7,dx=8mm dy=8mm dz=5mm
Variation (%)	0.260000
SAR 10g (W/Kg)	0.112264
SAR 1g (W/Kg)	0.151394
SURFACE SAR	VOLUME SAR

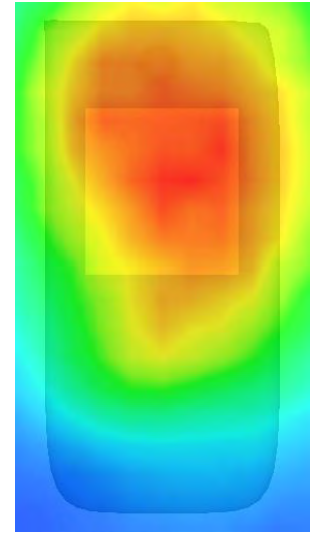
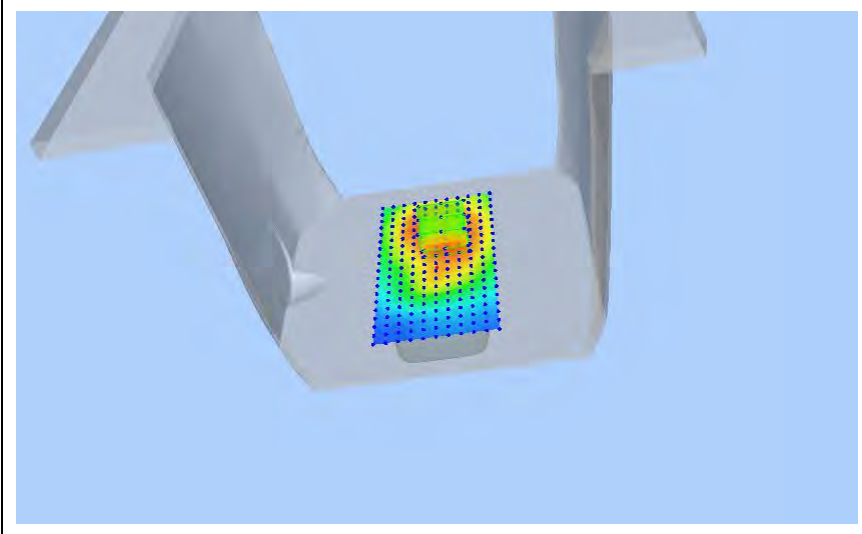
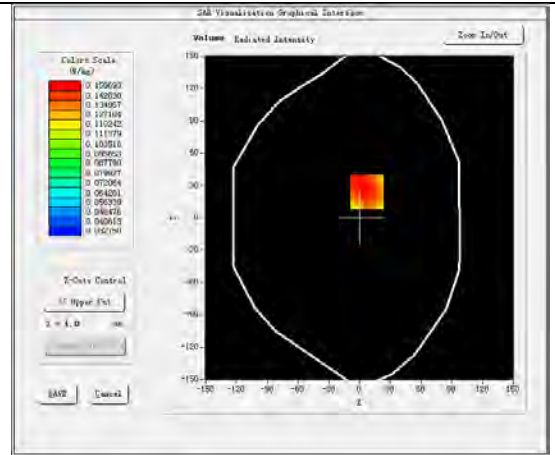
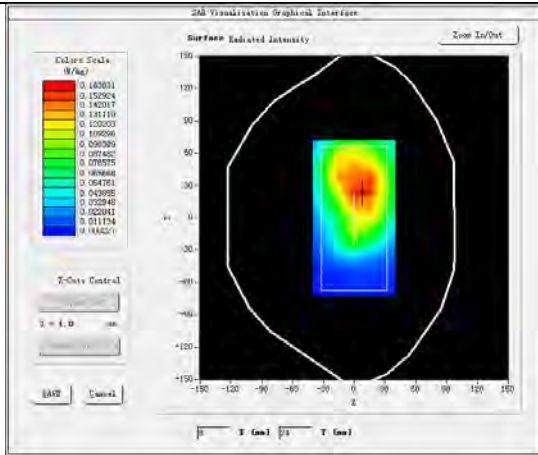

#3

Test Mode:GSM 1900MHz,Middle channel(Head Left Cheek)

Product Description: 4G Smartphone

Model: T50

Test Date: Oct 12, 2018

Medium(liquid type)	HSL_1800
Frequency (MHz)	1880.0000
Relative permittivity (real part)	41.07
Conductivity (S/m)	1.42
E-Field Probe	SN 45/15 EPGO281
Crest Factor	8
Conversion Factor	2.10
Sensor	4mm
Area Scan	dx=8mm dy=8mm
Zoom Scan	5x5x7,dx=8mm dy=8mm dz=5mm
Variation (%)	3.880000
SAR 10g (W/Kg)	0.064529
SAR 1g (W/Kg)	0.116672

SURFACE SAR

VOLUME SAR

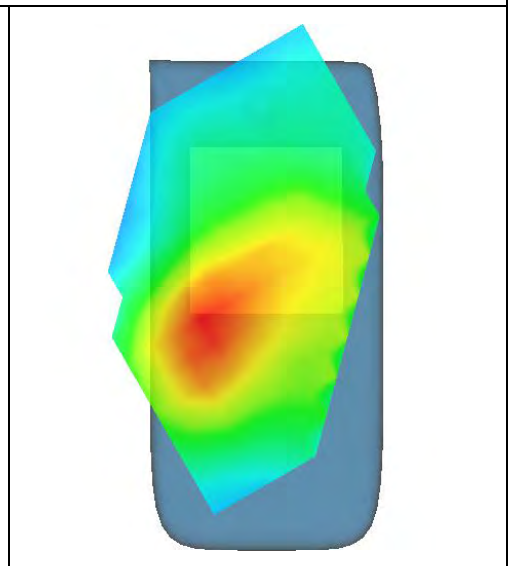
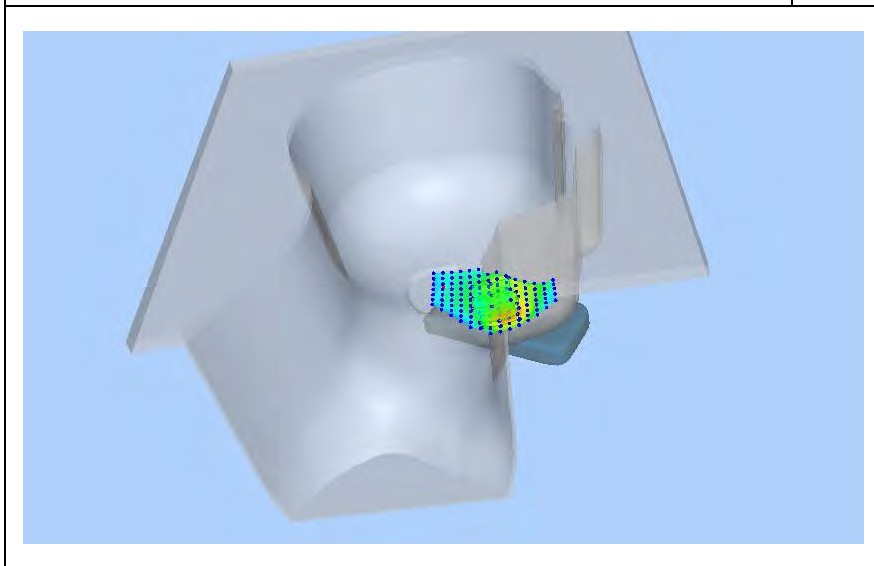
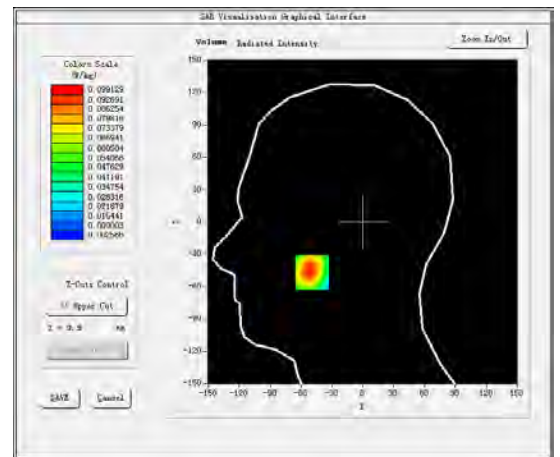
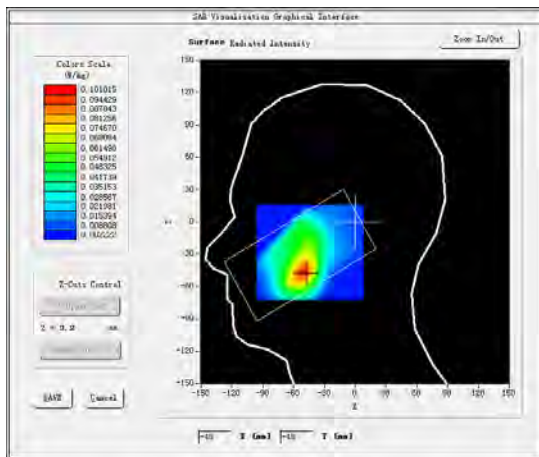

#4

Test Mode: Hotspot GPRS1900MHz,High channel(Body Rear Side)

Product Description: 4G Smartphone

Model: T50

Test Date: Oct 15, 2018

Medium(liquid type)	MSL_1800
Frequency (MHz)	1909.8000
Relative permittivity (real part)	54.71
Conductivity (S/m)	1.53
E-Field Probe	SN 45/15 EPGO281
Crest Factor	2.67
Conversion Factor	2.16
Sensor	4mm
Area Scan	dx=8mm dy=8mm
Zoom Scan	5x5x7,dx=8mm dy=8mm dz=5mm
Variation (%)	3.420000
SAR 10g (W/Kg)	0.146794
SAR 1g (W/Kg)	0.264464

SURFACE SAR

VOLUME SAR

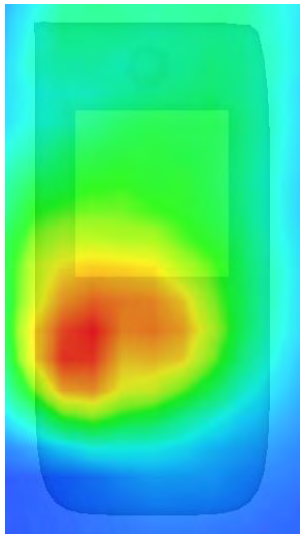
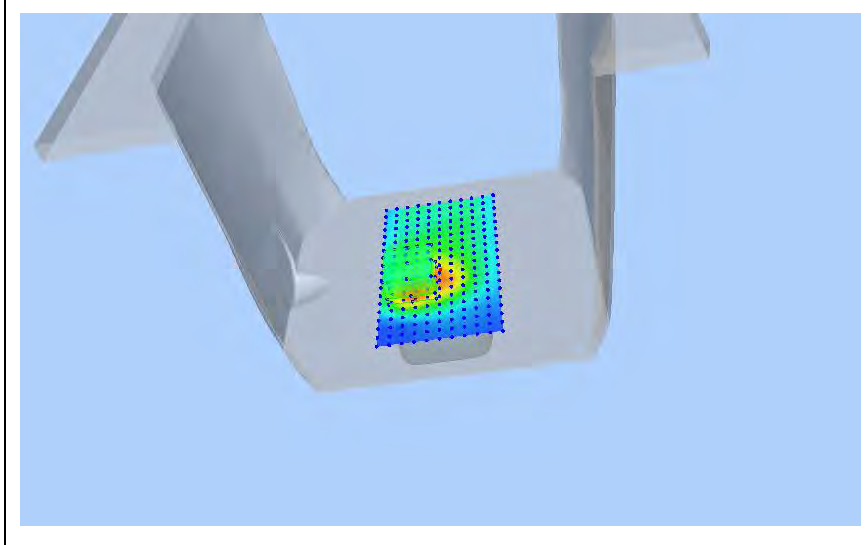
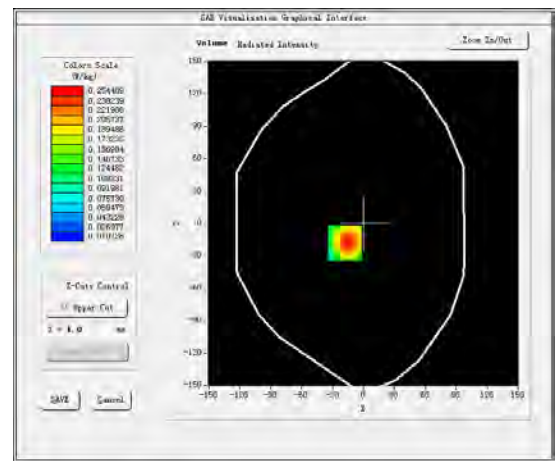
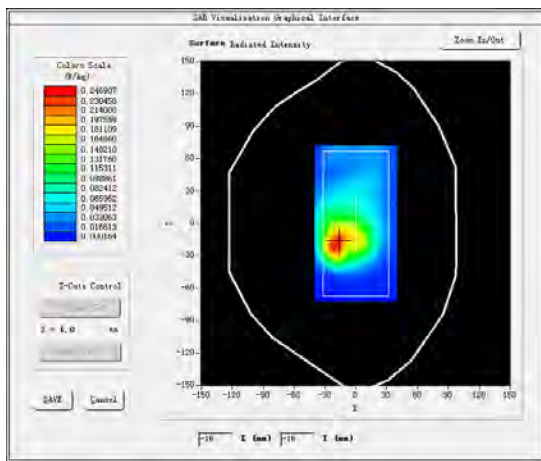

#5

Test Mode:WCDMA Band V,Middle channel(Head Right Cheek)

Product Description: 4G Smartphone

Model: T50

Test Date:Oct 10, 2018

Medium(liquid type)	HSL 850
Frequency (MHz)	836.6000
Relative permittivity (real part)	41.92
Conductivity (S/m)	0.88
E-Field Probe	SN 45/15 EPGO281
Crest Factor	1.0
Conversion Factor	1.78
Sensor	4mm
Area Scan	dx=8mm dy=8mm
Zoom Scan	5x5x7,dx=8mm dy=8mm dz=5mm
Variation (%)	-0.660000
SAR 10g (W/Kg)	0.037096
SAR 1g (W/Kg)	0.050607

SURFACE SAR

VOLUME SAR

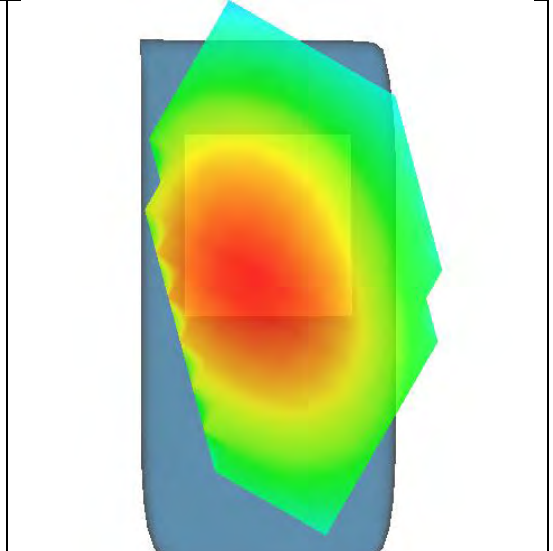
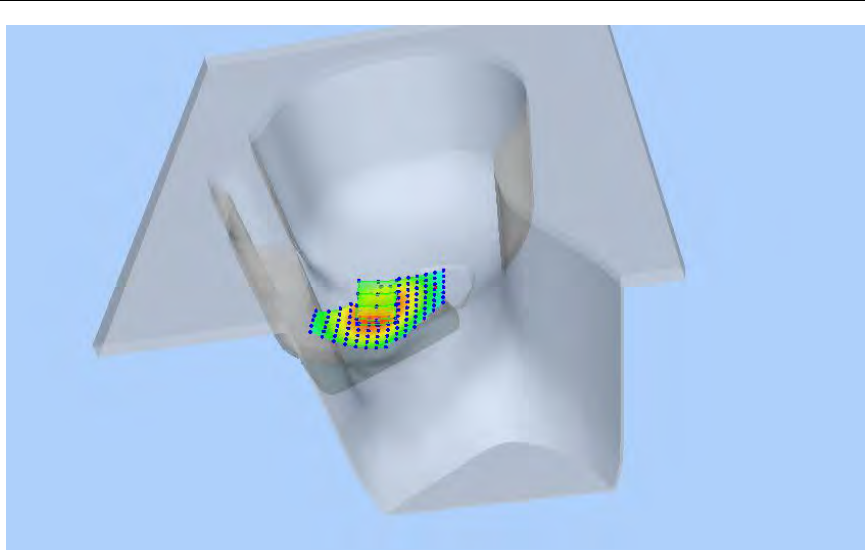
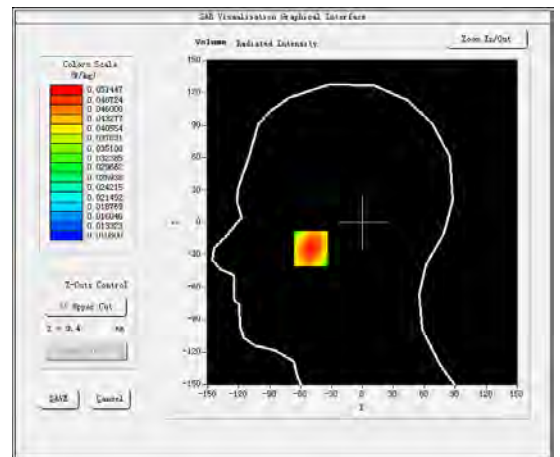
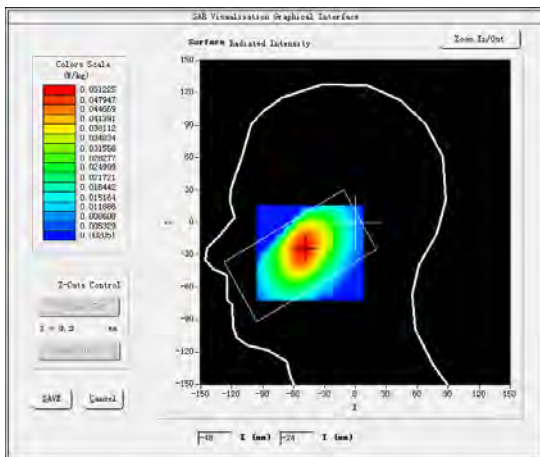

#6

Test Mode: Hotspot WCDMA Band V, Middle channel (Body Rear Side)

Product Description: 4G Smartphone

Model: T50

Test Date: Oct 11, 2018

Medium (liquid type)	MSL_850
Frequency (MHz)	836.6000
Relative permittivity (real part)	54.61
Conductivity (S/m)	0.96
E-Field Probe	SN 45/15 EPGO281
Crest Factor	1.0
Conversion Factor	1.85
Sensor	4mm
Area Scan	dx=8mm dy=8mm
Zoom Scan	5x5x7, dx=8mm dy=8mm dz=5mm
Variation (%)	-3.880000
SAR 10g (W/Kg)	0.069072
SAR 1g (W/Kg)	0.093401
SURFACE SAR	VOLUME SAR

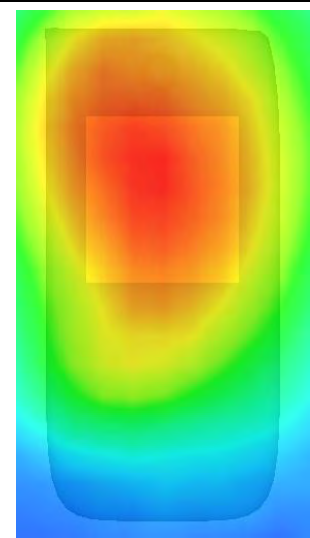
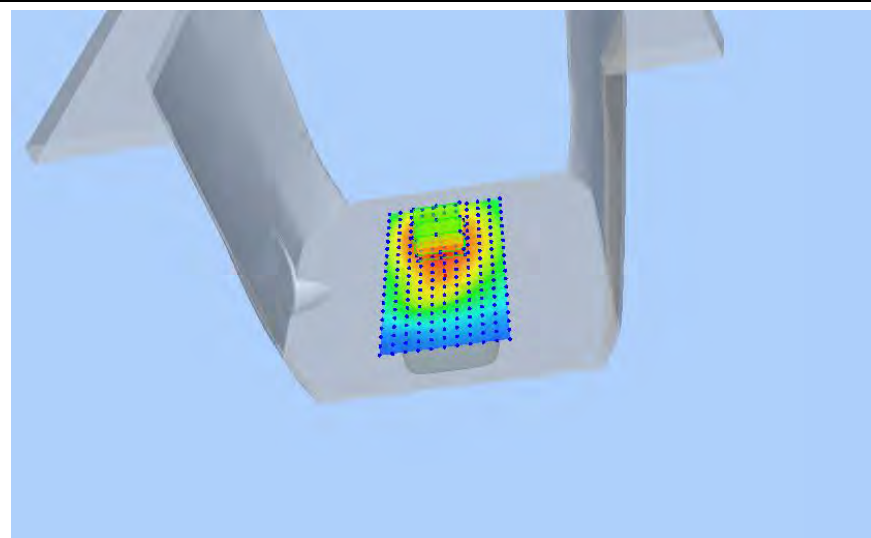
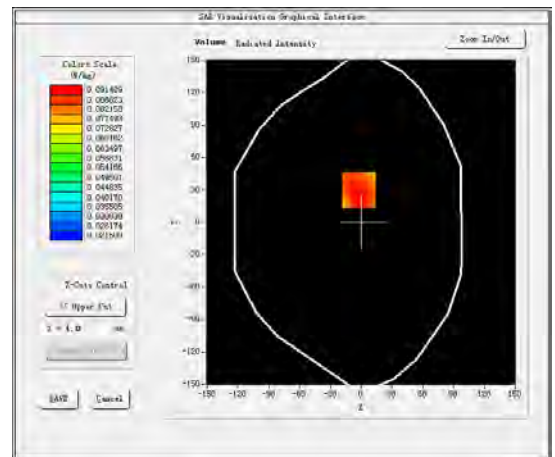
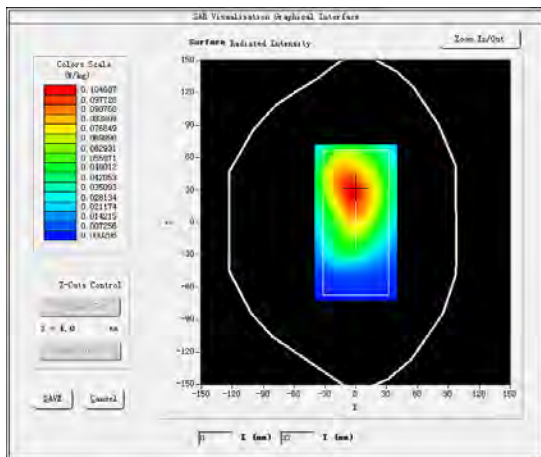

#7

Test Mode:WCDMA Band II,High channel(Head Left Cheek)

Product Description: 4G Smartphone

Model: T50

Test Date: Oct 16, 2018

Medium(liquid type)	HSL_1900
Frequency (MHz)	1907.6000
Relative permittivity (real part)	41.92
Conductivity (S/m)	1.42
E-Field Probe	SN 45/15 EPGO281
Crest Factor	1.0
Conversion Factor	2.10
Sensor	4mm
Area Scan	dx=8mm dy=8mm
Zoom Scan	5x5x7,dx=8mm dy=8mm dz=5mm
Variation (%)	-1.940000
SAR 10g (W/Kg)	0.138766
SAR 1g (W/Kg)	0.226873

SURFACE SAR

VOLUME SAR

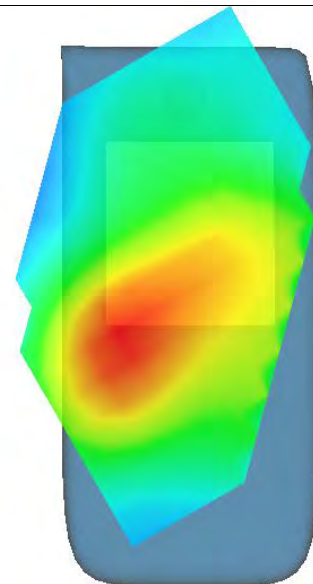
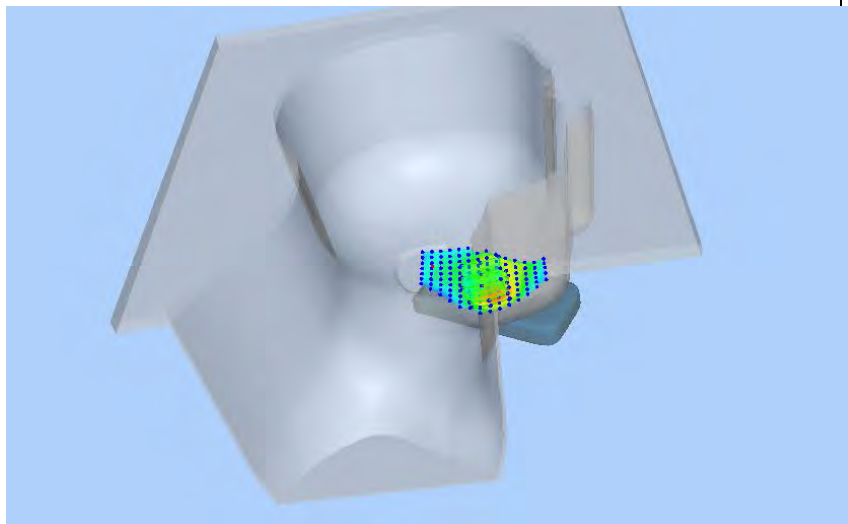
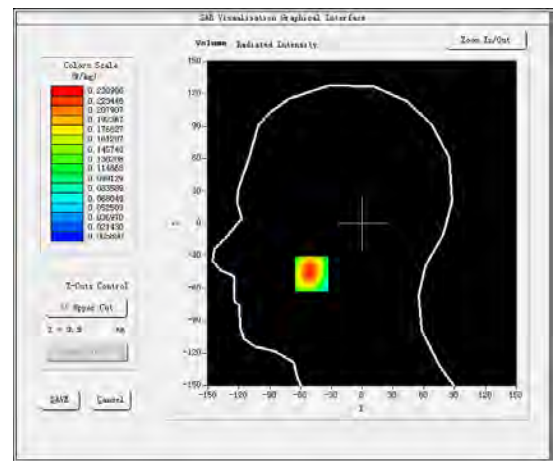
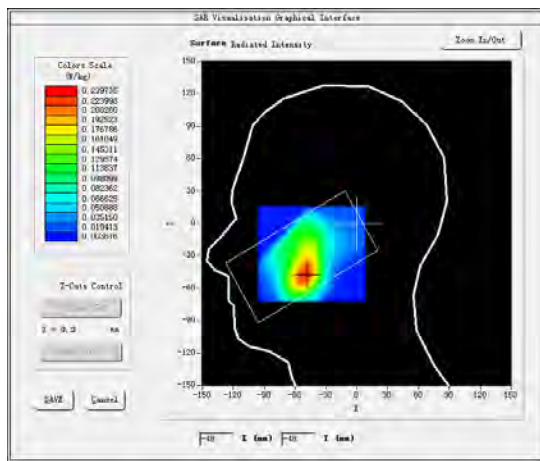

#8

Test Mode: Hotspot WCDMA Band II,High channel(Body Rear Side)

Product Description: 4G Smartphone

Model: T50

Test Date: Oct 17, 2018

Medium(liquid type)	MSL_1900
Frequency (MHz)	1907.6000
Relative permittivity (real part)	54.71
Conductivity (S/m)	1.53
E-Field Probe	SN 45/15 EPGO281
Crest Factor	1.0
Conversion Factor	2.16
Sensor	4mm
Area Scan	dx=8mm dy=8mm
Zoom Scan	5x5x7,dx=8mm dy=8mm dz=5mm
Variation (%)	-0.270000
SAR 10g (W/Kg)	0.243878
SAR 1g (W/Kg)	0.429483

SURFACE SAR

VOLUME SAR

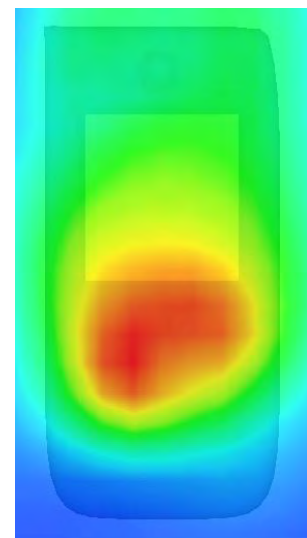
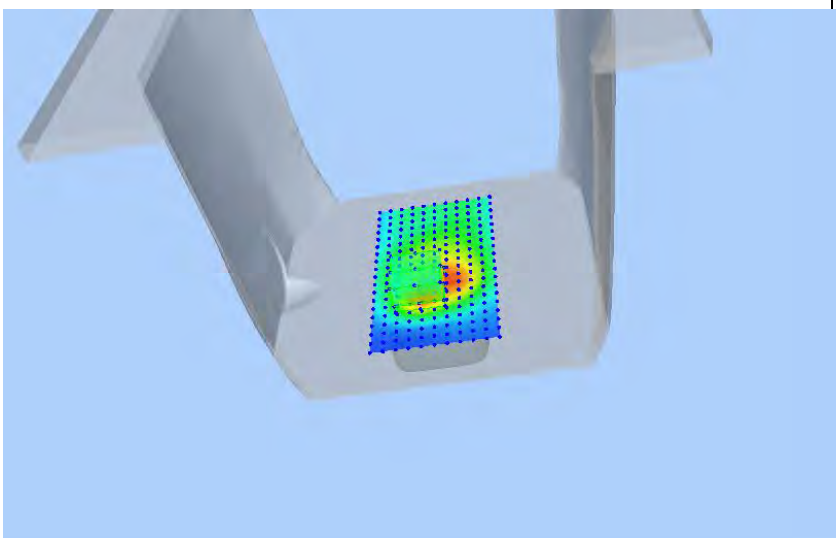
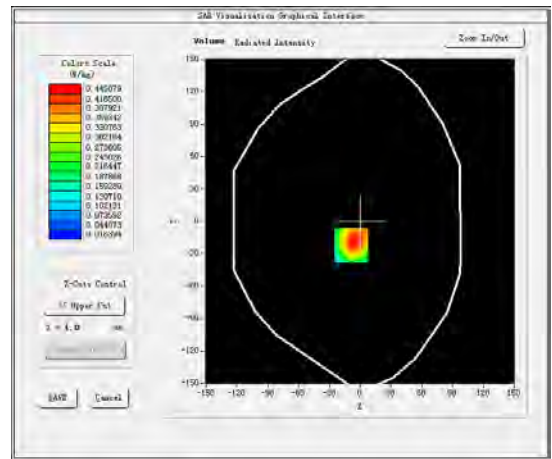
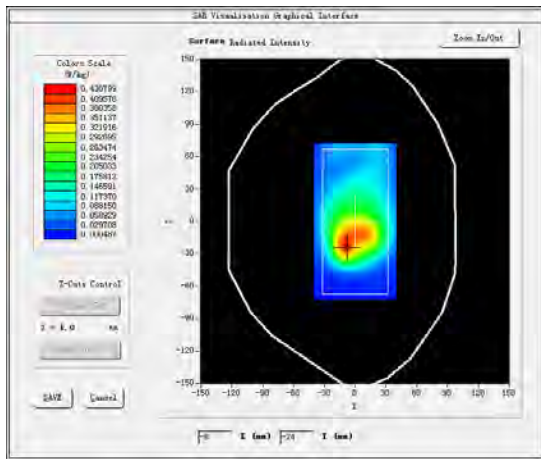

#9

Test Mode:LTE Band 2, 1RB,Middle channel(Head Left Cheek)

Product Description: 4G Smartphone

Model: T50

Test Date: Oct 12, 2018

Medium(liquid type)	HSL_1800
Frequency (MHz)	1880.0000
Relative permittivity (real part)	41.92
Conductivity (S/m)	1.41
E-Field Probe	SN 45/15 EPGO281
Crest Factor	1.0
Conversion Factor	2.10
Sensor	4mm
Area Scan	dx=8mm dy=8mm
Zoom Scan	5x5x7,dx=8mm dy=8mm dz=5mm
Variation (%)	-0.640000
SAR 10g (W/Kg)	0.111646
SAR 1g (W/Kg)	0.169151

SURFACE SAR

VOLUME SAR

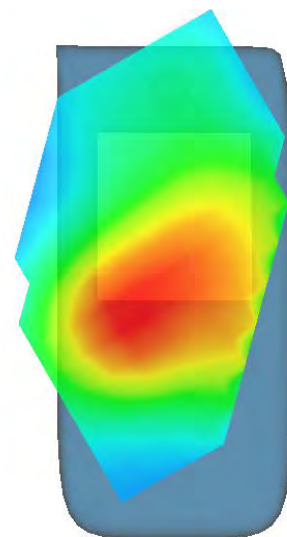
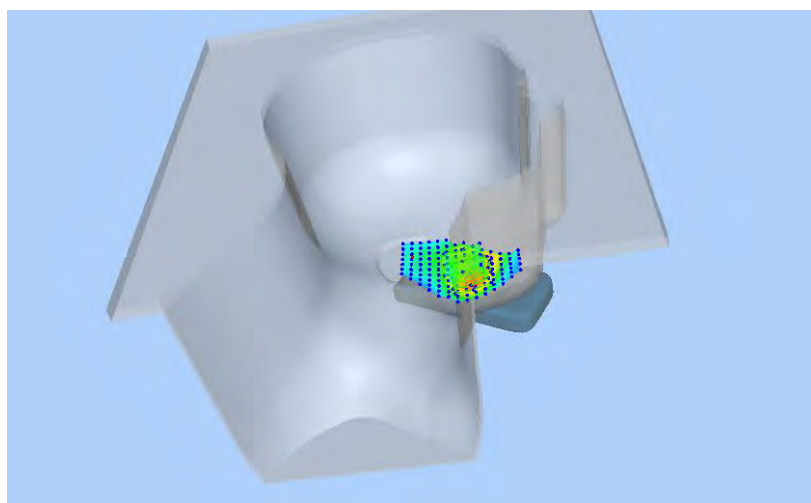
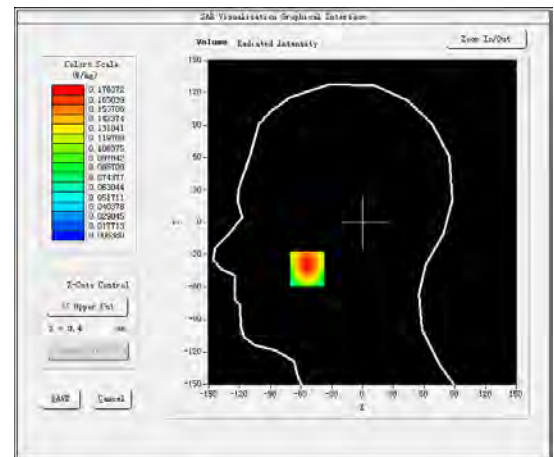
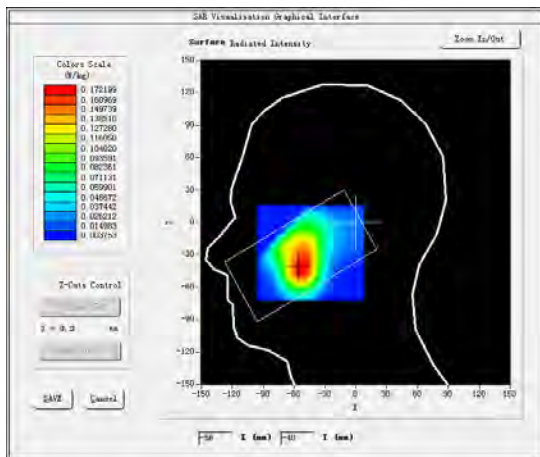

#10

Test Mode: Hotspot LTE Band 2, 1RB,Middle channel(Body Rear Side)

Product Description: 4G Smartphone

Model: T50

Test Date: Oct 15, 2018

Medium(liquid type)	MSL_1800
Frequency (MHz)	1880.0000
Relative permittivity (real part)	52.47
Conductivity (S/m)	1.54
E-Field Probe	SN 45/15 EPGO281
Crest Factor	1.0
Conversion Factor	2.16
Sensor	4mm
Area Scan	dx=8mm dy=8mm
Zoom Scan	5x5x7,dx=8mm dy=8mm dz=5mm
Variation (%)	-0.460000
SAR 10g (W/Kg)	0.270281
SAR 1g (W/Kg)	0.453438

SURFACE SAR

VOLUME SAR

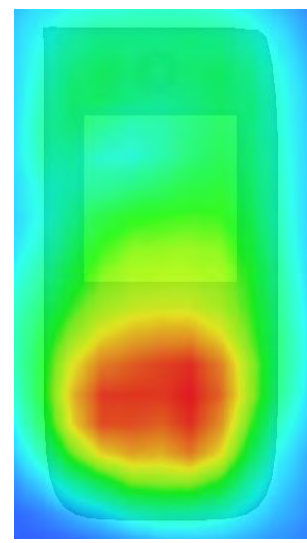
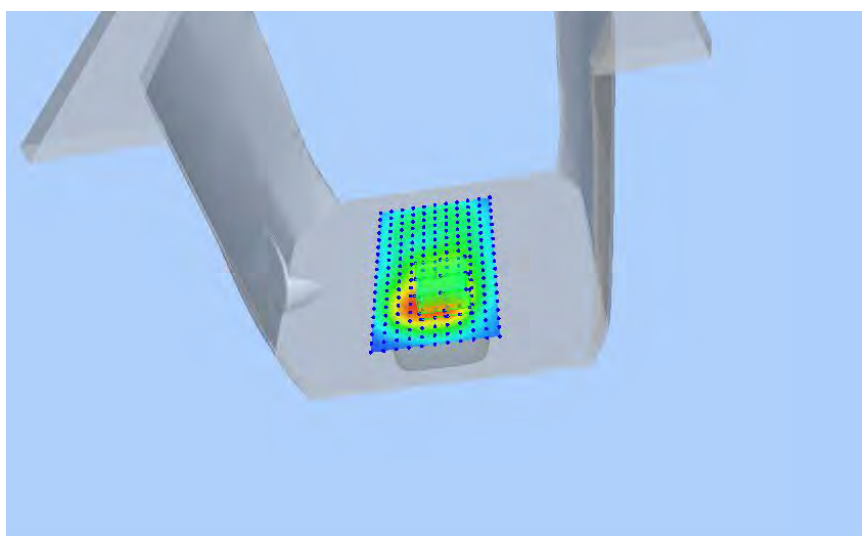
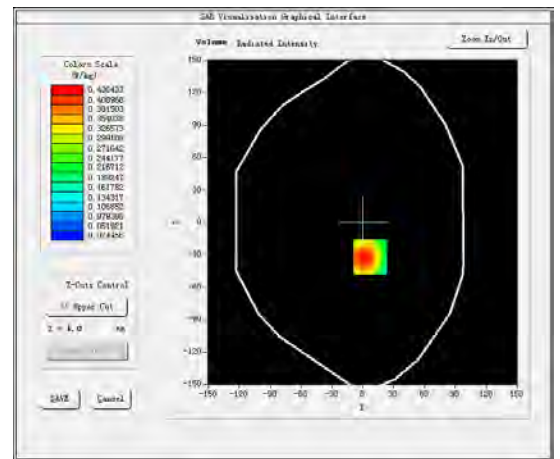
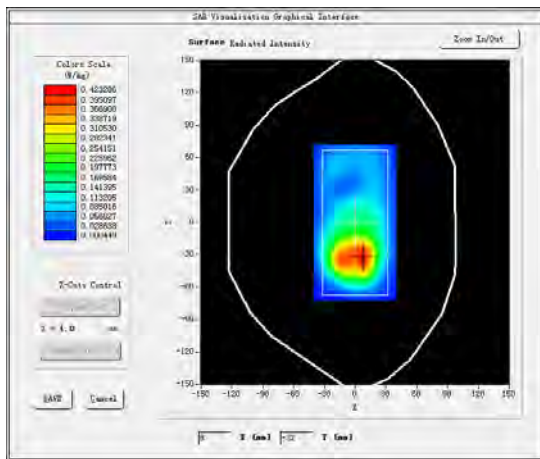

#11

Test Mode: LTE Band 4, 1RB, High channel (Head Left Cheek)

Product Description: 4G Smartphone

Model: T50

Test Date: Oct 12, 2018

Medium (liquid type)	HSL_1800
Frequency (MHz)	1745.0000
Relative permittivity (real part)	39.65
Conductivity (S/m)	1.41
E-Field Probe	SN 45/15 EPGO281
Crest Factor	1.0
Conversion Factor	1.87
Sensor	4mm
Area Scan	dx=8mm dy=8mm
Zoom Scan	5x5x7, dx=8mm dy=8mm dz=5mm
Variation (%)	1.170000
SAR 10g (W/Kg)	0.103284
SAR 1g (W/Kg)	0.165474

SURFACE SAR

VOLUME SAR

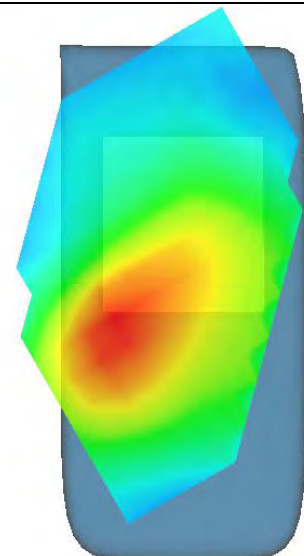
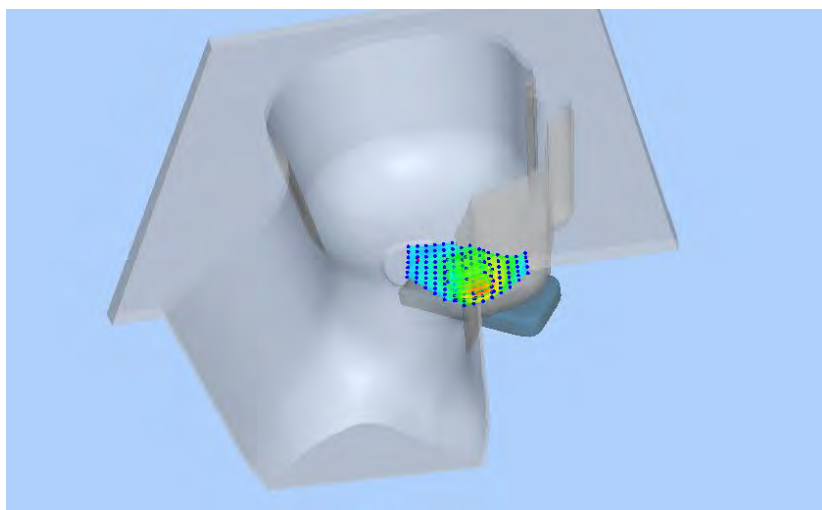
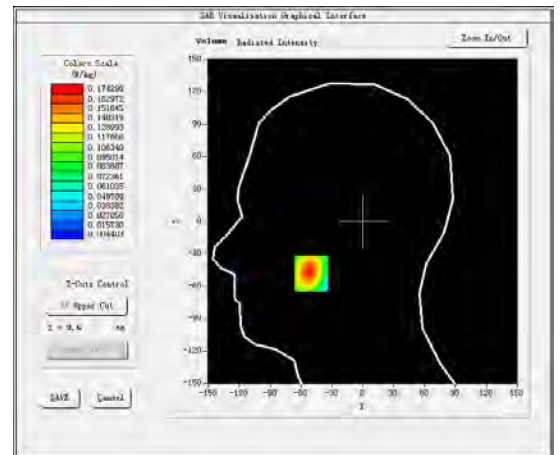
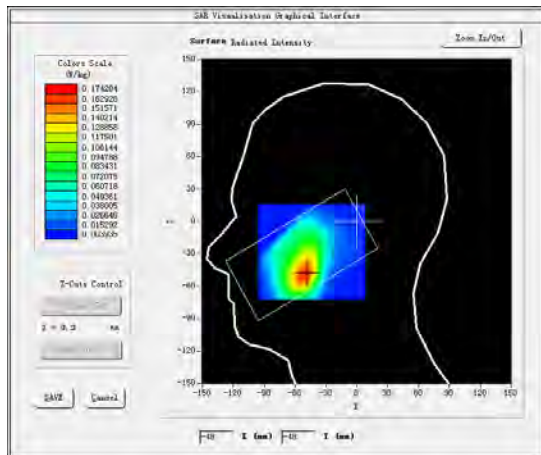

#12

Test Mode: LTE Band 4, 1RB, High channel (Body Rear Side)

Product Description: 4G Smartphone

Model: T50

Test Date: Oct 15, 2018

Medium (liquid type)	MSL_1800
Frequency (MHz)	1745.0000
Relative permittivity (real part)	52.47
Conductivity (S/m)	1.54
E-Field Probe	SN 45/15 EPGO281
Crest Factor	1.0
Conversion Factor	1.87
Sensor	4mm
Area Scan	dx=8mm dy=8mm
Zoom Scan	5x5x7, dx=8mm dy=8mm dz=5mm
Variation (%)	-2.350000
SAR 10g (W/Kg)	0.202618
SAR 1g (W/Kg)	0.332050

SURFACE SAR

VOLUME SAR

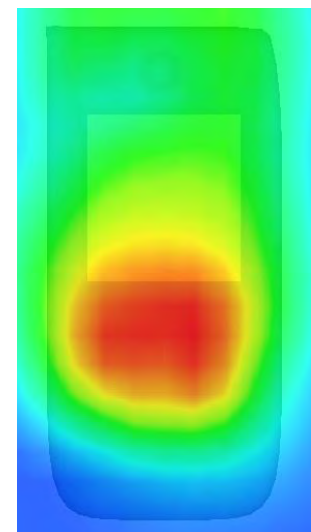
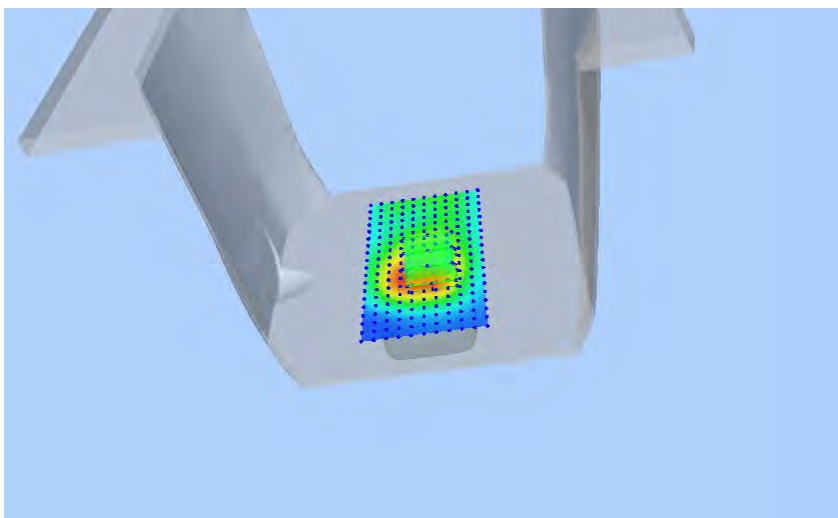
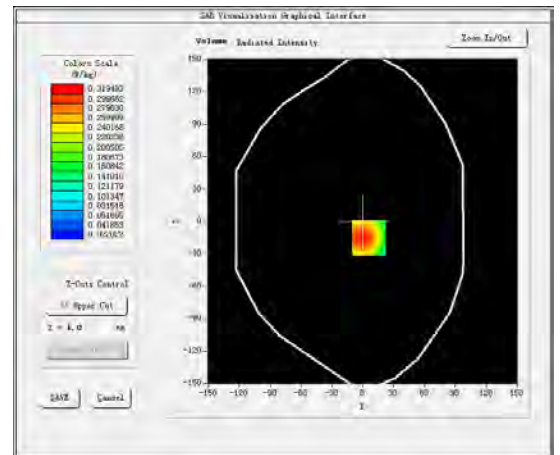
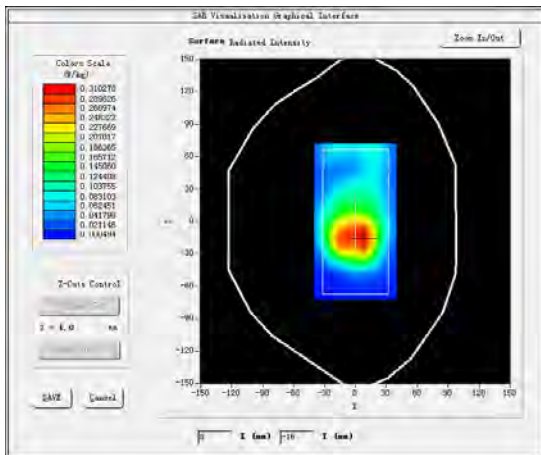

#13

Test Mode: LTE Band 7, 1RB, Middle channel (Head Right Cheek)
 Product Description: 4G Smartphone
 Model: T50
 Test Date: Oct 22, 2018

Medium (liquid type)	HSL_2600
Frequency (MHz)	2535.0000
Relative permittivity (real part)	39.55
Conductivity (S/m)	1.78
E-Field Probe	SN 45/15 EPGO281
Crest Factor	1.0
Conversion Factor	2.32
Sensor	4mm
Area Scan	dx=8mm dy=8mm
Zoom Scan	5x5x7, dx=8mm dy=8mm dz=5mm
Variation (%)	3.430000
SAR 10g (W/Kg)	0.154966
SAR 1g (W/Kg)	0.304835

SURFACE SAR

VOLUME SAR

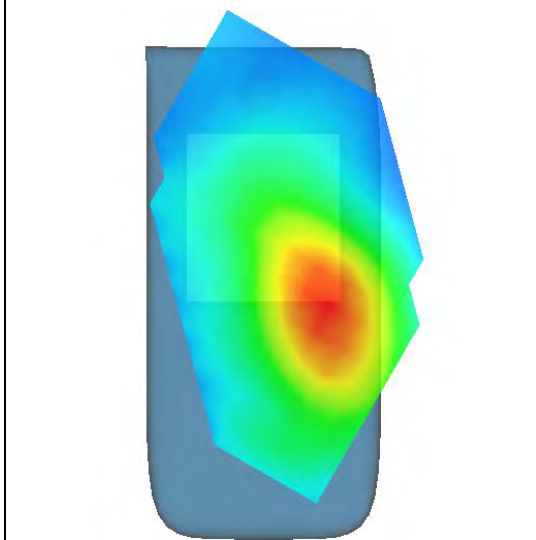
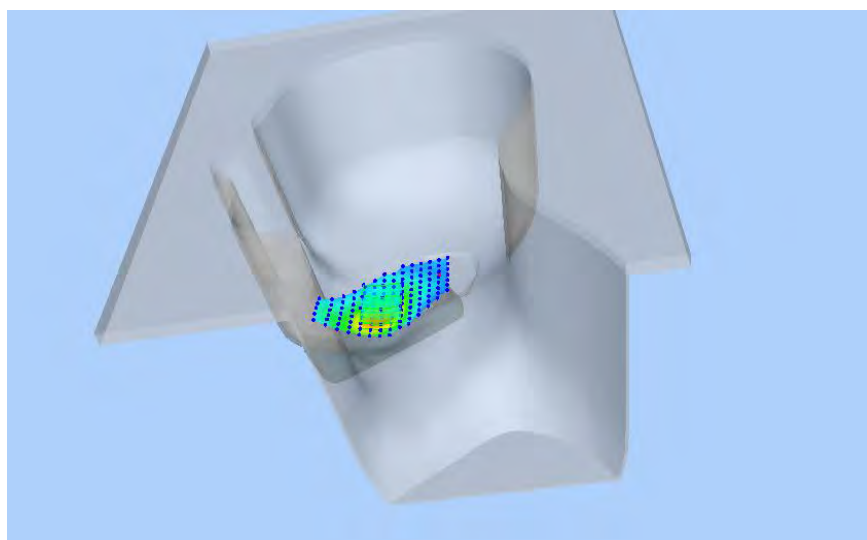
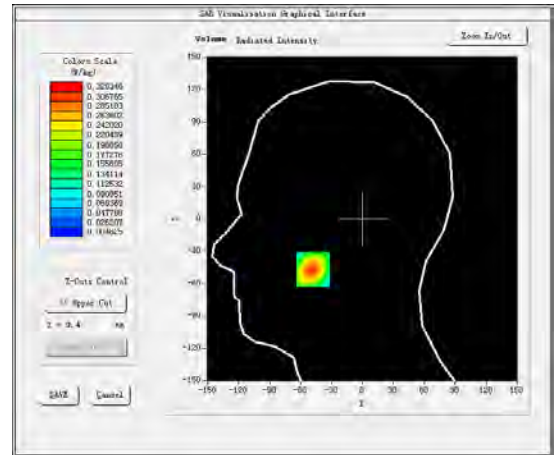
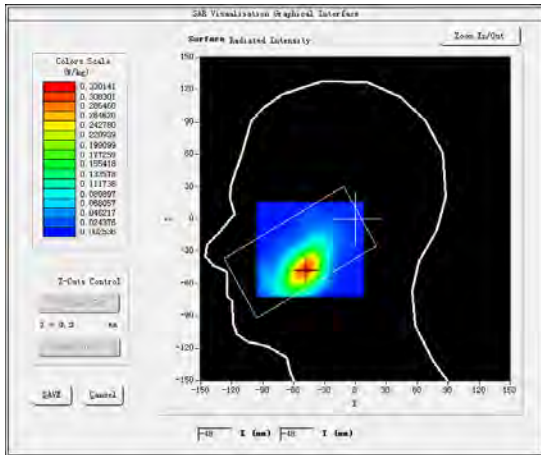

Test Mode: Hotspot LTE Band 7, 1RB, Middle channel(Body Rear Side)
 Product Description: 4G Smartphone
 Model: T50
 Test Date: Oct 30, 2018

Medium(liquid type)	MSL_2600
Frequency (MHz)	2535.0000
Relative permittivity (real part)	51.35
Conductivity (S/m)	2.18
E-Field Probe	SN 45/15 EPGO281
Crest Factor	1.0
Conversion Factor	2.38
Sensor	4mm
Area Scan	dx=8mm dy=8mm
Zoom Scan	5x5x7,dx=8mm dy=8mm dz=5mm
Variation (%)	-0.490000
SAR 10g (W/Kg)	0.109541
SAR 1g (W/Kg)	0.236686

SURFACE SAR

VOLUME SAR

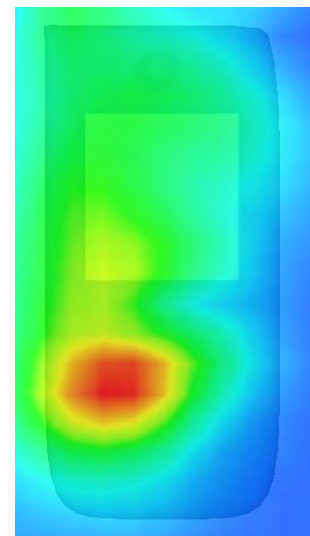
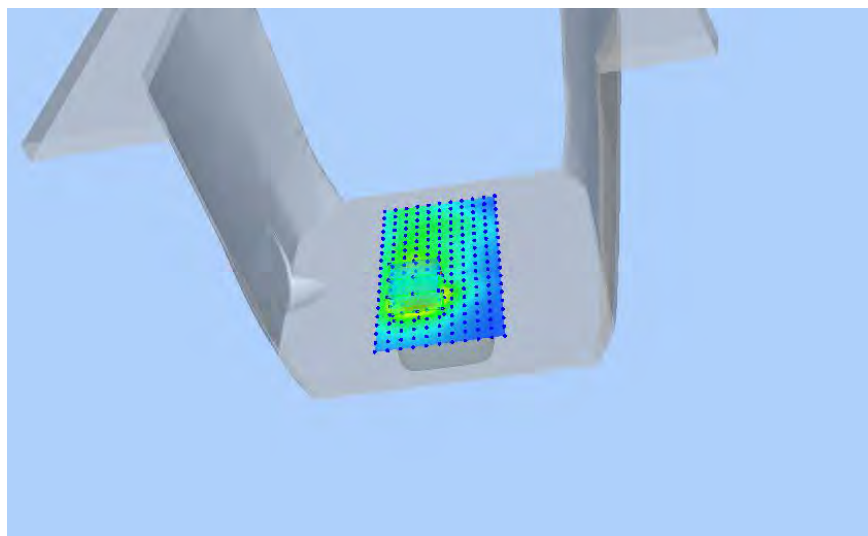
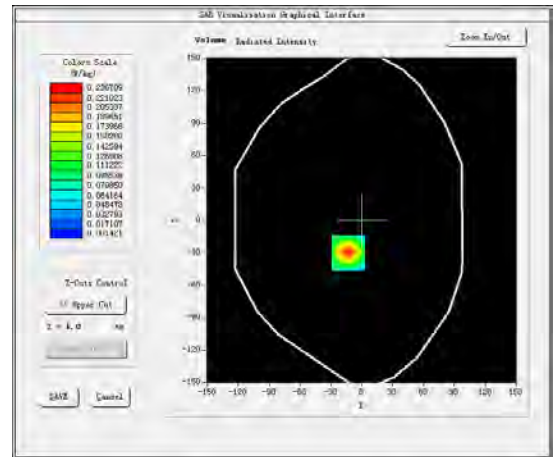
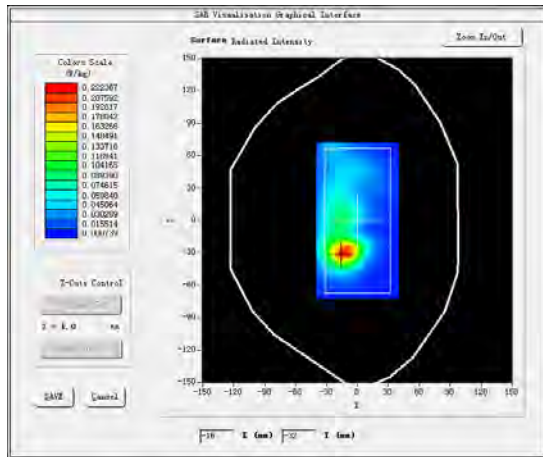

#15

Test Mode:802.11b(WiFi2.4G),Middle channel (Head Left Cheek)

Product Description: 4G Smartphone

Model: T50

Test Date: Oct 18, 2018

Medium(liquid type)	HSL_2450
Frequency (MHz)	2437.0000
Relative permittivity (real part)	39.51
Conductivity (S/m)	1.78
E-Field Probe	SN 45/15 EPGO281
Crest Factor	1.0
Conversion Factor	2.21
Sensor	4mm
Area Scan	dx=8mm dy=8mm
Zoom Scan	5x5x7,dx=8mm dy=8mm dz=5mm
Variation (%)	-0.480000
SAR 10g (W/Kg)	0.073078
SAR 1g (W/Kg)	0.142623

SURFACE SAR

VOLUME SAR

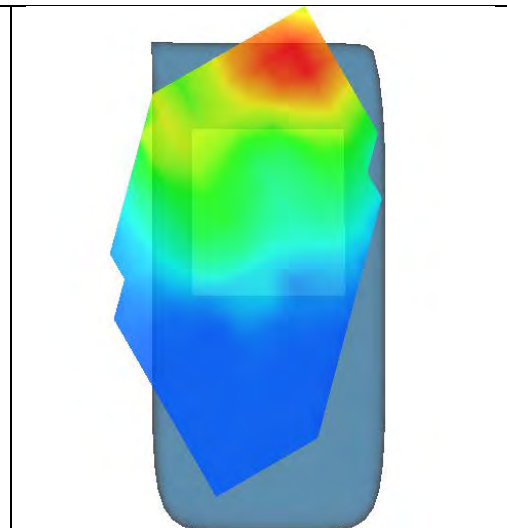
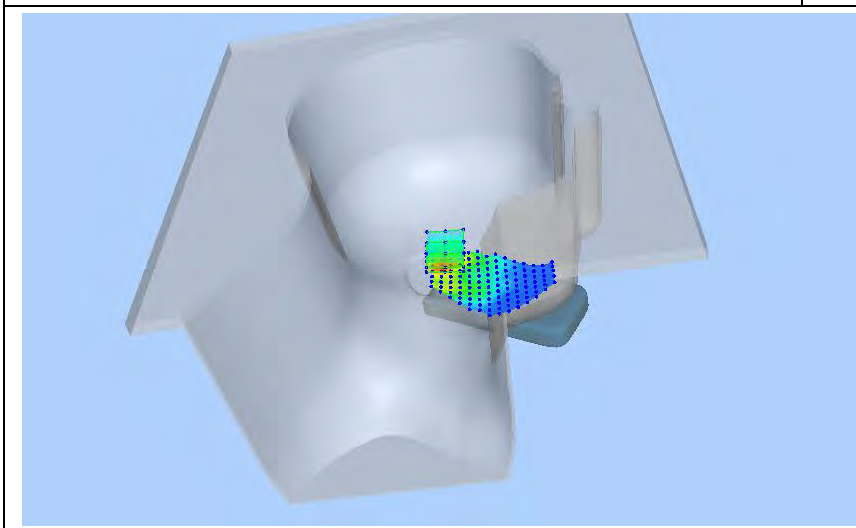
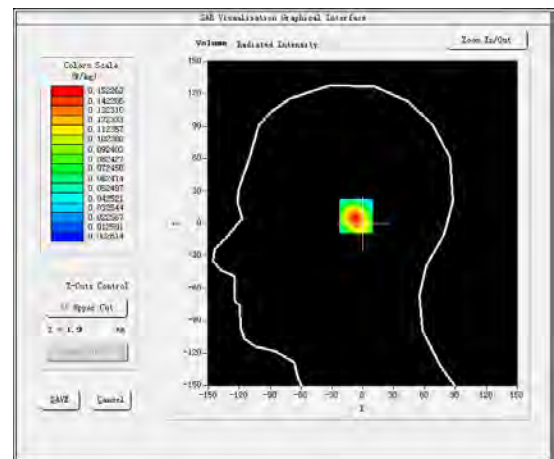
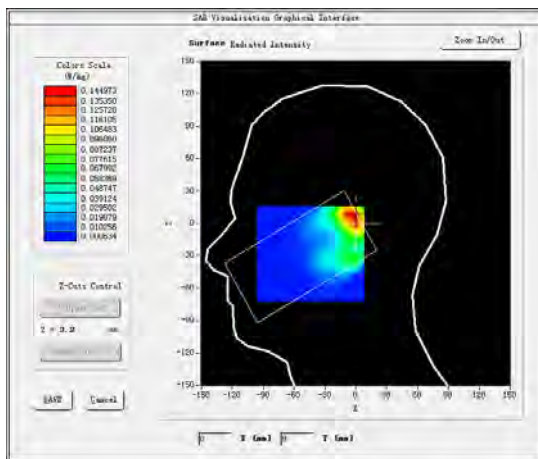

#16

Test Mode: Hotspot 802.11b(WiFi2.4G),Middle channel (Body Rear Side)

Product Description: 4G Smartphone

Model: T50

Test Date: Oct 19, 2018

Medium(liquid type)	MSL_2450
Frequency (MHz)	2437.0000
Relative permittivity (real part)	51.54
Conductivity (S/m)	1.97
E-Field Probe	SN 45/15 EPGO281
Crest Factor	1.0
Conversion Factor	2.28
Sensor	4mm
Area Scan	dx=8mm dy=8mm
Zoom Scan	5x5x7,dx=8mm dy=8mm dz=5mm
Variation (%)	3.740000
SAR 10g (W/Kg)	0.054308
SAR 1g (W/Kg)	0.108653

SURFACE SAR

VOLUME SAR

