

**SAR TEST REPORT**

For

**SHENZHEN KENXINDA TECHNOLOGY CO.,LTD**

Feature phone

Model No.: C3330

List Model No.: C338, C3340, C3350

Prepared for : SHENZHEN KENXINDA TECHNOLOGY CO.,LTD  
Address : 18th Floors, Fuchun Orient Building. No 7006 Shennan AV,  
Futian District, Shenzhen City, China.

Prepared by : Shenzhen LCS Compliance Testing Laboratory Ltd.  
Address : 1/F., Xingyuan Industrial Park, Tongda Road, Bao'an  
Avenue, Bao'an District, Shenzhen, Guangdong, China  
Tel : (86)755-82591330  
Fax : (86)755-82591332  
Web : www.LCS-cert.com  
Mail : webmaster@LCS-cert.com

Date of receipt of test sample : September 01, 2018  
Number of tested samples : 1  
Serial number : Prototype  
Date of Test : September 03, 2018~ September 21, 2018  
Date of Report : October 11, 2018

**SAR TEST REPORT****Report Reference No. ....: LCS180829042AEB**

Date Of Issue .....: October 11, 2018

**Testing Laboratory Name .....: Shenzhen LCS Compliance Testing Laboratory Ltd.**Address .....: 1/F., Xingyuan Industrial Park, Tongda Road, Bao'an Avenue,  
Bao'an District, Shenzhen, Guangdong, ChinaTesting Location/ Procedure.....: Full application of Harmonised standards   
Partial application of Harmonised standards   
Other standard testing method **Applicant's Name .....: SHENZHEN KENXINDA TECHNOLOGY CO.,LTD**Address .....: 18th Floors, Fuchun Orient Building. No 7006 Shennan AV,  
Futian District, Shenzhen City, China.**Test Specification:**Standard.....: IEEE Std C95.1, 2005&IEEE Std 1528™-2013&& FCC Part  
2.1093

Test Report Form No.....: LCSEMC-1.0

TRF Originator .....: Shenzhen LCS Compliance Testing Laboratory Ltd.

Master TRF.....: Dated 2014-09

**Shenzhen LCS Compliance Testing Laboratory Ltd. All rights reserved.**

This publication may be reproduced in whole or in part for non-commercial purposes as long as the Shenzhen LCS Compliance Testing Laboratory Ltd. is acknowledged as copyright owner and source of the material. Shenzhen LCS Compliance Testing Laboratory Ltd. takes no responsibility for and will not assume liability for damages resulting from the reader's interpretation of the reproduced material due to its placement and context.

**Test Item Description.....: Feature phone**

Trade Mark .....: KENXINDA

Model/Type Reference .....: C3330

Operation Frequency .....: GSM 850/PCS1900, Bluetooth2.1+EDR

Modulation Type .....: GSM(GMSK), Bluetooth(GFSK,8DPSK, $\pi/4$ -DQPSK)Ratings.....: DC 3.7V by Rechargeable Li-ion Battery(1400mAh)  
Charging Voltage: DC 5V/500mA**Result .....: Positive****Compiled by:**

Vera Deng/ File administrators

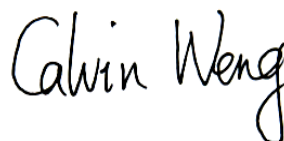
**Supervised by:**

Calvin Weng/ Technique principal

**Approved by:**

Gavin Liang/ Manager

## SAR -- TEST REPORT

<b>Test Report No. :</b> <b>LCS180829042AEB</b>	<u>October 11, 2018</u> Date of issue
---	--

Type / Model.....	: C3330
EUT.....	: Feature phone
<b>Applicant.....</b>	<b>: SHENZHEN KENXINDA TECHNOLOGY CO.,LTD</b>
Address.....	: 18th Floors, Fuchun Orient Building. No 7006 Shennan AV, Futian District, Shenzhen City, China.
Telephone.....	: /
Fax.....	: /
<b>Manufacturer.....</b>	<b>: SHENZHEN KENXINDA TECHNOLOGY CO.,LTD</b>
Address.....	: 18th Floors, Fuchun Orient Building. No 7006 Shennan AV, Futian District, Shenzhen City, China.
Telephone.....	: /
Fax.....	: /
<b>Factory.....</b>	<b>: SHENZHEN KENXINDA TECHNOLOGY CO.,LTD</b>
Address.....	: No.8 Building, Shiao Second Industrial Zone, Dalang Clothing Base, Longhua New District, Shenzhen, China
Telephone.....	: /
Fax.....	: /

<b>Test Result</b>	<b>Positive</b>
--------------------	-----------------

The test report merely corresponds to the test sample.  
It is not permitted to copy extracts of these test result without the written permission of the test laboratory.

### Revision History

Revision	Issue Date	Revisions	Revised By
000	October 11, 2018	Initial Issue	Gavin Liang

## TABLE OF CONTENTS

<b>1. TEST STANDARDS AND TEST DESCRIPTION.....</b>	<b>6</b>
1.1. TEST STANDARDS .....	6
1.2. TEST DESCRIPTION.....	6
1.3. GENERAL REMARKS.....	6
1.4. PRODUCT DESCRIPTION .....	6
1.5. STATEMENT OF COMPLIANCE .....	8
<b>2. TEST ENVIRONMENT .....</b>	<b>9</b>
2.1. TEST FACILITY .....	9
2.2. ENVIRONMENTAL CONDITIONS .....	9
2.3. SAR LIMITS .....	9
2.4. EQUIPMENTS USED DURING THE TEST .....	10
<b>3. SAR MEASUREMENTS SYSTEM CONFIGURATION .....</b>	<b>12</b>
3.1. SAR MEASUREMENT SET-UP .....	12
3.2. OPENSAR E-FIELD PROBE SYSTEM.....	13
3.3. PHANTOMS.....	14
3.4. DEVICE HOLDER .....	14
3.5. SCANNING PROCEDURE.....	15
3.6. DATA STORAGE AND EVALUATION.....	17
3.7. POSITION OF THE WIRELESS DEVICE IN RELATION TO THE PHANTOM .....	18
3.8. TISSUE DIELECTRIC PARAMETERS FOR HEAD AND BODY PHANTOMS .....	20
3.9. TISSUE EQUIVALENT LIQUID PROPERTIES .....	20
3.10. SYSTEM CHECK.....	21
3.11. SAR MEASUREMENT PROCEDURE .....	23
3.12. POWER REDUCTION .....	23
3.13. POWER DRIFT.....	23
<b>4. TEST CONDITIONS AND RESULTS .....</b>	<b>24</b>
4.1. CONDUCTED POWER RESULTS .....	24
4.2. MANUFACTURING TOLERANCE .....	26
4.3. TRANSMIT ANTENNAS AND SAR MEASUREMENT POSITION .....	27
4.4. SAR MEASUREMENT RESULTS .....	28
4.5. SIMULTANEOUS TX SAR CONSIDERATIONS.....	29
4.6. SAR MEASUREMENT VARIABILITY .....	32
4.7. GENERAL DESCRIPTION OF TEST PROCEDURES .....	33
4.8. MEASUREMENT UNCERTAINTY (300MHZ-3GHZ).....	33
4.9. SYSTEM CHECK RESULTS .....	34
4.10 SAR TEST GRAPH RESULTS.....	38
<b>5. CALIBRATION CERTIFICATES .....</b>	<b>42</b>
5.1 PROBE-EPGO281 CALIBRATION CERTIFICATE.....	42
5.2 SID835DIPOLE CALIBRATION CERITICATE.....	52
5.3 SID1900 DIPOLE CALIBRATION CERTIFICATE .....	63
<b>6. EUT TEST PHOTOGRAPHS .....</b>	<b>74</b>
6.1 PHOTOGRAPH OF LIQUIDDEPTH.....	74
6.2 PHOTOGRAPH OF THE TEST .....	76
<b>7. EUT PHOTOGRAPHS.....</b>	<b>79</b>

# 1. TEST STANDARDS AND TEST DESCRIPTION

## 1.1. Test Standards

[IEEE Std C95.1, 2005](#): IEEE Standard for Safety Levels with Respect to Human Exposure to Radio Frequency Electromagnetic Fields, 3 KHz to 300 GHz. It specifies the maximum exposure limit of 1.6 W/kg as averaged over any 1 gram of tissue for portable devices being used within 20 cm of the user in the uncontrolled environment.

[IEEE Std 1528™-2013](#): IEEE Recommended Practice for Determining the Peak Spatial-Average Specific Absorption Rate (SAR) in the Human Head from Wireless Communications Devices: Measurement Techniques.

[FCC Part 2.1093](#): Radiofrequency Radiation Exposure Evaluation: Portable Devices

[KDB447498 D01 General RF Exposure Guidance](#): Mobile and Portable Device RF Exposure Procedures and Equipment Authorization Policies

[KDB648474 D04 Handset SAR v01r03](#): SAR Evaluation Considerations for Wireless Handsets

[KDB865664 D01 SAR Measurement 100 MHz to 6 GHz](#): SAR Measurement Requirements for 100 MHz to 6 GHz

[KDB865664 D02 RF Exposure Reporting](#): RF Exposure Compliance Reporting and Documentation Considerations

[KDB941225 D01 3G SAR Procedures](#): 3G SAR MEASUREMENT PROCEDURES

[KDB 941225 D06 Hotspot Mode](#): SAR EVALUATION PROCEDURES FOR PORTABLE DEVICES WITH WIRELESS ROUTER CAPABILITIES

## 1.2. Test Description

The EUT battery must be fully charged and checked periodically during the test to ascertain uniform power. And Test device is identical prototype.

## 1.3. General Remarks

Date of receipt of test sample	:	September 01, 2018
Testing commenced on	:	September 03, 2018
Testing concluded on	:	September 21, 2018

## 1.4. Product Description

The SHENZHEN KENXINDA TECHNOLOGY CO.,LTD.'s Model: C3330 or the "EUT" as referred to in this report; more general information as follows, for more details, refer to the user's manual of the EUT.

General Description	
Product Name:	Feature phone
Model/Type reference:	C3330
List Model No.:	C338, C3340, C3350
Model Declaration:	PCB board, structure and internal of these model(s) are the same, So no additional models were tested.
Modulation Type:	GMSK for GSM/GPRS
Device category:	Portable Device
Exposure category:	General population/uncontrolled environment
EUT Type:	Production Unit
Hardware Version	V1.3
Software Version:	V1.01
Power supply:	DC 3.7V by Rechargeable Li-ion Battery(1400mAh) Charging Voltage: DC 5V/500mA

*The EUT is GSM mobile phone. the mobile phone is intended for speech and Multimedia Message Service (MMS) transmission. It is equipped with GPRS class 12 for GSM850, PCS1900, and Bluetooth, For more information see the following datasheet*

Technical Characteristics	
GSM	
Support Networks	GSM, GPRS
Support Band	GSM850/PCS1900/GPRS850/GPRS1900
Frequency	GSM850: 824.2~848.8MHz GSM1900: 1850.2~1909.8MHz
Power Class:	GSM850: Power Class 4

	PCS1900:Power Class 1
Modulation Type:	GMSK for GSM/GPRS
Antenna Description:	Integral Antenna, 0.6dBi(Max.) for GSM 850 Integral Antenna, 1.2dBi(Max.) for PCS 1900
GSM Release Version	R99
GPRS Multislot Class	12
EGPRS Multislot Class	Not Supported
DTM Mode	Not Supported
<b>Bluetooth</b>	
Bluetooth Version:	2.1+EDR
Modulation:	GFSK(1Mbps) , $\pi/4$ -DQPSK(2Mbps), 8DPSK(3Mbps)
Operation frequency:	2402MHz~2480MHz
Channel number:	79
Channel separation:	1MHz
Antenna Description	Integral Antenna, 1.2dBi (Max.)

## 1.5. Statement of Compliance

The maximum of results of SAR found during testing for C3330 are follows:

### <Highest Reported standalone SAR Summary>

Class/Class	Frequency Band	Head (Report SAR <sub>1-g</sub> (W/Kg))	Body-worn (Report SAR <sub>1-g</sub> (W/Kg))
PCE	GSM 850	0.376	0.862
	GSM1900	0.688	<b>1.071</b>

This device is in compliance with Specific Absorption Rate (SAR) for general population/uncontrolled exposure limits (1.6 W/kg) specified in FCC 47 CFR part 2 (2.1093) and ANSI/IEEE C95.1-2005, and had been tested in accordance with the measurement methods and procedures specified in IEEE 1528-2013.

### <Highest Reported simultaneous SAR Summary>

Exposure Position	Frequency Band	Reported SAR <sub>1-g</sub> (W/kg)	Class/Class	Highest Reported Simultaneous Transmission SAR <sub>1-g</sub> (W/Kg)
Body-worn	GSM 1900	1.071	PCE	<b>1.097</b>
	BT	0.026	DSS	



## 2. TEST ENVIRONMENT

### 2.1. Test Facility

The test facility is recognized, certified, or accredited by the following organizations:

Site Description  
EMC Lab. : FCC Registration Number. is 254912  
Industry Canada Registration Number. is 9642A-1.  
ESMD Registration Number. is ARCB0108.  
UL Registration Number. is 100571-492.  
TUV SUD Registration Number. is SCN1081.  
TUV RH Registration Number. is UA 50296516-001  
NVLAP Registration Code is 600167-0.

### 2.2. Environmental conditions

During the measurement the environmental conditions were within the listed ranges:

Temperature:	18-25 ° C
Humidity:	40-65 %
Atmospheric pressure:	950-1050mbar

### 2.3. SAR Limits

EXPOSURE LIMITS	FCC Limit (1g Tissue)	
	SAR (W/kg)	
	(General Population / Uncontrolled Exposure Environment)	(Occupational / Controlled Exposure Environment)
Spatial Average(averaged over the whole body)	0.08	0.4
Spatial Peak(averaged over any 1 g of tissue)	1.6	8.0
Spatial Peak(hands/wrists/ feet/anklesaveraged over 10 g)	4.0	20.0

Population/Uncontrolled Environments are defined as locations where there is the exposure of individual who have no knowledge or control of their exposure.

Occupational/Controlled Environments are defined as locations where there is exposure that may be incurred by people who are aware of the potential for exposure (i.e. as a result of employment or occupation).

## 2.4. Equipments Used during the Test

Test Equipment	Manufacturer	Type/Model	Serial Number	Calibration	
				Calibration Date	Calibration Due
PC	Lenovo	G5005	MY42081102	N/A	N/A
SAR Measurement system	SATIMO	4014_01	SAR_4014_01	N/A	N/A
Signal Generator	Agilent	E4438C	MY42081396	11/18/2017	11/18/2018
Multimeter	Keithley	MiltiMeter 2000	4059164	11/18/2017	11/18/2018
S-parameter Network Analyzer	Agilent	8753ES	US38432944	11/18/2017	11/18/2018
Wireless Communication Test Set	R & S	CMU200	105988	11/18/2017	11/18/2018
Wideband Radia Communication Tester	R&S	CMW500	1201.0002K50	11/18/2017	11/18/2018
E-Field PROBE	SATIMO	SSE2	SN 45/15 EPGO281	02/04/2018	02/03/2019
DIPOLE 835	SATIMO	SID 835	SN 07/14 DIP 0G835-303	10/01/2015	09/30/2018
DIPOLE 1900	SATIMO	SID 1900	SN 30/14 DIP 1G900-333	10/01/2015	09/30/2018
COMOSAR OPEN Coaxial Probe	SATIMO	OCPG 68	SN 40/14 OCPG68	11/18/2017	11/18/2018
SARLocator	SATIMO	VPS51	SN 40/14 VPS51	11/18/2017	11/18/2018
Communication Antenna	SATIMO	ANTA57	SN 39/14 ANTA57	11/18/2017	11/18/2018
Mobile Phone POSITIONING DEVICE	SATIMO	MSH98	SN 40/14 MSH98	N/A	N/A
DUMMY PROBE	SATIMO	DP60	SN 03/14 DP60	N/A	N/A
SAM PHANTOM	SATIMO	SAM117	SN 40/14 SAM117	N/A	N/A
Liquid measurement Kit	HP	85033D	3423A03482	11/18/2017	11/18/2018
Power meter	Agilent	E4419B	MY45104493	06/16/2018	06/15/2019
Power meter	Agilent	E4418B	GB4331256	06/16/2018	06/15/2019
Power sensor	Agilent	E9301H	MY41497725	06/16/2018	06/15/2019
Power sensor	Agilent	E9301H	MY41495234	06/16/2018	06/15/2019
Directional Coupler	MCLI/USA	4426-20	0D2L51502	06/16/2018	06/15/2019

### Note:

- 1) Per KDB865664D01 requirements for dipole calibration, the test laboratory has adopted three year extended calibration interval. Each measured dipole is expected to evaluate with following criteria at least on annual interval.
  - a) There is no physical damage on the dipole;
  - b) System check with specific dipole is within 10% of calibrated values;
  - c) The most recent return-loss results,measued at least annually,deviates by no more than 20% from the previous measurement;

- d) The most recent measurement of the real or imaginary parts of the impedance, measured at least annually is within  $5\Omega$  from the previous measurement.
- 2) Network analyzer probe calibration against air, distilled water and a shorting block performed before measuring liquid parameters.

### 3. SAR MEASUREMENTS SYSTEM CONFIGURATION

#### 3.1. SAR Measurement Set-up

The OPENSAR system for performing compliance tests consist of the following items:

A standard high precision 6-axis robot (KUKA) with controller and software.

KUKA Control Panel (KCP)

A dosimetric probe, i.e., an isotropic E-field probe optimized and calibrated for usage in tissue simulating liquid. The probe is equipped with a Video Positioning System(VPS).

The stress sensor is composed with mechanical and electronic when the electronic part detects a change on the electro-mechanical switch,It sends an "Emergency signal" to the robot controller that to stop robot's moves

A computer operating Windows XP.

OPENSAR software

Remote control with teaches pendant and additional circuitry for robot safety such as warning lamps, etc.

The SAM phantom enabling testing left-hand right-hand and body usage.

The Position device for handheld EUT

Tissue simulating liquid mixed according to the given recipes .

System validation dipoles to validate the proper functioning of the system.

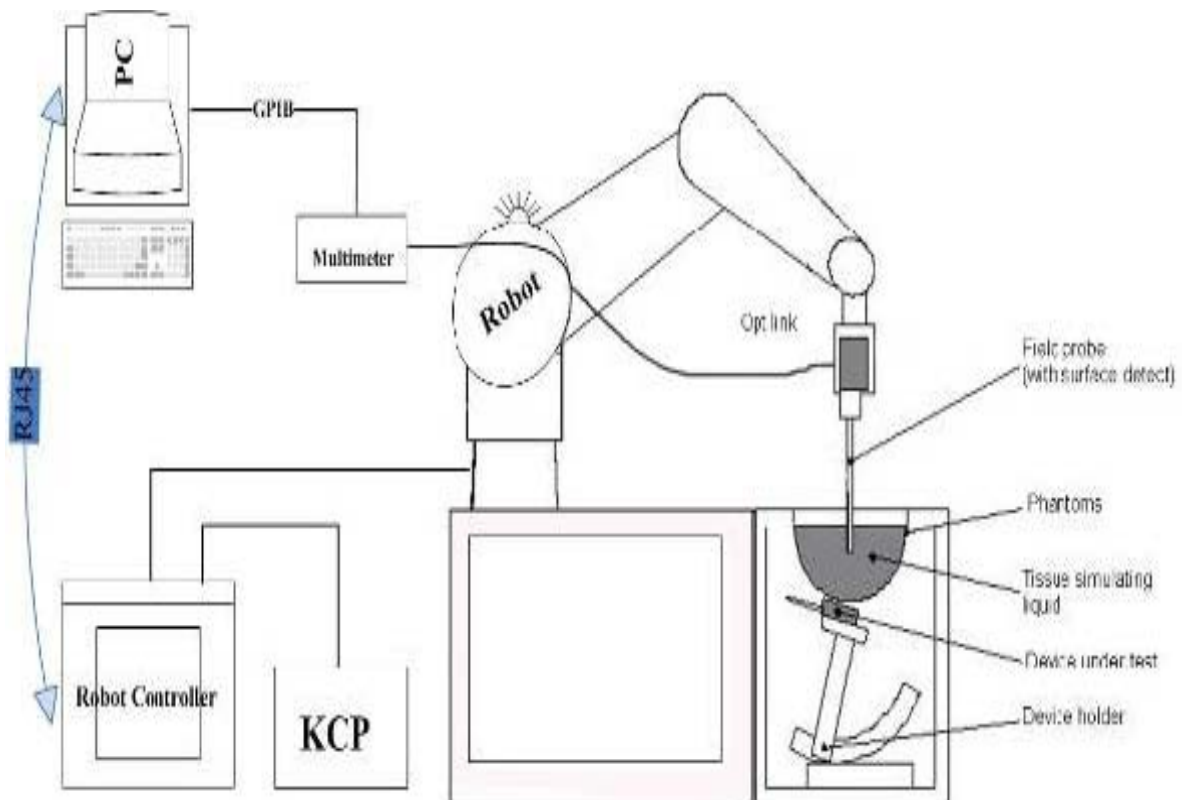

### 3.2. OPENSAR E-field Probe System

The SAR measurements were conducted with the dosimetric probe EPGO281 (manufactured by SATIMO), designed in the classical triangular configuration and optimized for dosimetric evaluation.

#### Probe Specification

Construction Symmetrical design with triangular core  
 Interleaved sensors  
 Built-in shielding against static charges  
 PEEK enclosure material (resistant to organic solvents, e.g., DGBE)

Calibration ISO/IEC 17025 calibration service available.

Frequency	450 MHz to 6GHz; Linearity: 0.25dB(450 MHz to 6GHz)
Directivity	0.25 dB in HSL (rotation around probe axis) 0.5 dB in tissue material (rotation normal to probe axis)
Dynamic Range	0.01W/kg to > 100 W/kg; Linearity: 0.25 dB
Dimensions	Overall length: 330 mm (Tip: 16mm) Tip diameter: 5 mm (Body: 8 mm) Distance from probe tip to sensor centers: 2.5 mm
Application	General dosimetry up to 6 GHz Dosimetry in strong gradient fields Compliance tests of Mobile Phones



#### Isotropic E-Field Probe

The isotropic E-Field probe has been fully calibrated and assessed for isotropicity, and boundary effect within a controlled environment. Depending on the frequency for which the probe is calibrated the method utilized for calibration will change.

The E-Field probe utilizes a triangular sensor arrangement as detailed in the diagram below:

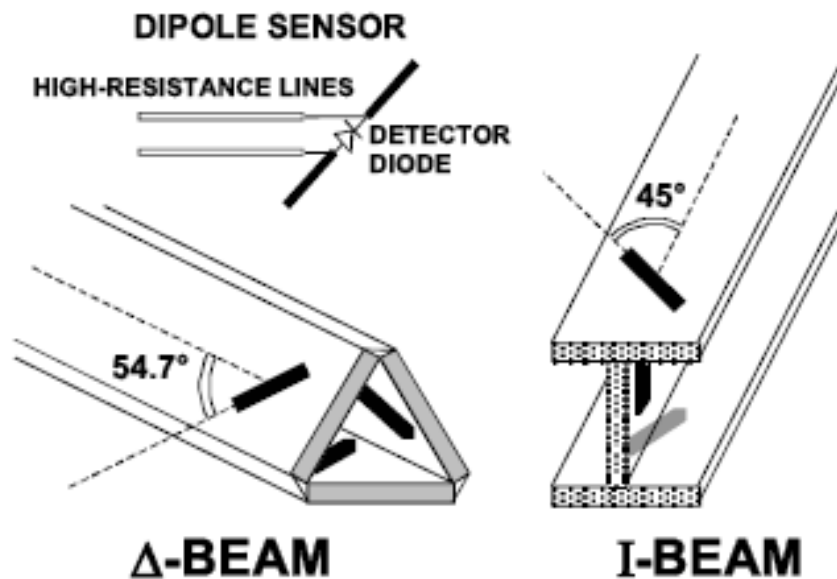

### 3.3. Phantoms

The SAM Phantom SAM117 is constructed of a fiberglass shell integrated in a wooden table. The shape of the shell is in compliance with the specification set in IEEE P1528 and CENELEC EN62209-1, EN62209-2:2010. The phantom enables the dosimetric evaluation of left and right hand phone usage as well as body mounted usage at the flat phantom region. A cover prevents the evaporation of the liquid. Reference markings on the Phantom allow the complete setup of all predefined phantom positions and measurement grids by manually teaching three points in the robot.

System checking was performed using the flat section, whilst Head SAR tests used the left and right head profile sections. Body SAR testing also used the flat section between the head profiles.

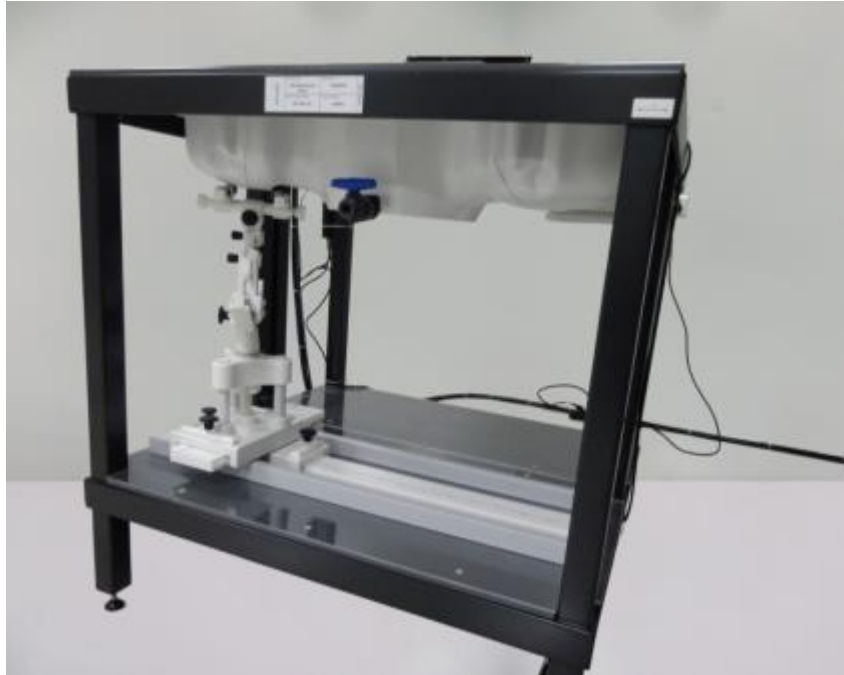

SAM Twin Phantom

### 3.4. Device Holder

In combination with the Generic Twin Phantom SAM117, the Mounting Device enables the rotation of the mounted transmitter in spherical coordinates whereby the rotation points is the ear opening. The devices can be easily, accurately, and repeatedly positioned according to the FCC and CENELEC specifications. The device holder can be locked at different phantom locations (left head, right head, flat phantom).



Device holder supplied by SATIMO

### 3.5. Scanning Procedure

The procedure for assessing the peak spatial-average SAR value consists of the following steps

#### Power Reference Measurement

The reference and drift jobs are useful jobs for monitoring the power drift of the device under test in the batch process. Both jobs measure the field at a specified reference position, at a selectable distance from the phantom surface. The reference position can be either the selected section's grid reference point or a user point in this section. The reference job projects the selected point onto the phantom surface, orients the probe perpendicularly to the surface, and approaches the surface using the selected detection method.

#### Area Scan

The Area Scan is used as a fast scan in two dimensions to find the area of high field values before running a detailed measurement around the hot spot. Before starting the area scan a grid spacing of 15 mm x 15 mm is set. During the scan the distance of the probe to the phantom remains unchanged. After finishing area scan, the field maxima within a range of 2 dB will be ascertained.

	≤ 3 GHz	> 3 GHz
Maximum distance from closest measurement point (geometric center of probe sensors) to phantom surface	5 mm ± 1 mm	$\frac{1}{2} \cdot \delta \cdot \ln(2)$ mm ± 0.5 mm
Maximum probe angle from probe axis to phantom surface normal at the measurement location	30° ± 1°	20° ± 1°
Maximum area scan spatial resolution: $\Delta x_{Area}$ , $\Delta y_{Area}$	≤ 2 GHz: ≤ 15 mm 2 – 3 GHz: ≤ 12 mm	3 – 4 GHz: ≤ 12 mm 4 – 6 GHz: ≤ 10 mm
	When the x or y dimension of the test device, in the measurement plane orientation, is smaller than the above, the measurement resolution must be ≤ the corresponding x or y dimension of the test device with at least one measurement point on the test device.	

#### Zoom Scan

Zoom Scans are used to estimate the peak spatial SAR values within a cubic averaging volume containing 1 g and 10 g of simulated tissue. The default Zoom Scan is done by 7x7x7 points within a cube whose base is centered around the maxima found in the preceding area scan.

Maximum zoom scan spatial resolution: $\Delta x_{Zoom}$ , $\Delta y_{Zoom}$		≤ 2 GHz: ≤ 8 mm 2 – 3 GHz: ≤ 5 mm*	3 – 4 GHz: ≤ 5 mm* 4 – 6 GHz: ≤ 4 mm*	
Maximum zoom scan spatial resolution, normal to phantom surface	uniform grid: $\Delta z_{Zoom}(n)$	≤ 5 mm	3 – 4 GHz: ≤ 4 mm 4 – 5 GHz: ≤ 3 mm 5 – 6 GHz: ≤ 2 mm	
	graded grid	$\Delta z_{Zoom}(1)$ : between 1 <sup>st</sup> two points closest to phantom surface	≤ 4 mm	3 – 4 GHz: ≤ 3 mm 4 – 5 GHz: ≤ 2.5 mm 5 – 6 GHz: ≤ 2 mm
		$\Delta z_{Zoom}(n>1)$ : between subsequent points	≤ 1.5 · $\Delta z_{Zoom}(n-1)$ mm	
Minimum zoom scan volume	x, y, z	≥ 30 mm	3 – 4 GHz: ≥ 28 mm 4 – 5 GHz: ≥ 25 mm 5 – 6 GHz: ≥ 22 mm	
Note: $\delta$ is the penetration depth of a plane-wave at normal incidence to the tissue medium; see IEEE Std 1528-2013 for details.				
* When zoom scan is required and the <i>reported</i> SAR from the <i>area scan based 1-g SAR estimation</i> procedures of KDB Publication 447498 is ≤ 1.4 W/kg, ≤ 8 mm, ≤ 7 mm and ≤ 5 mm zoom scan resolution may be applied, respectively, for 2 GHz to 3 GHz, 3 GHz to 4 GHz and 4 GHz to 6 GHz.				

### Power Drift measurement

The drift job measures the field at the same location as the most recent reference job within the same procedure, and with the same settings. The drift measurement gives the field difference in dB from the reading conducted within the last reference measurement. Several drift measurements are possible for one reference measurement. This allows a user to monitor the power drift of the device under test within a batch process. In the properties of the Drift job, the user can specify a limit for the drift and have OPENSAR software stop the measurements if this limit is exceeded.

## 3.6. Data Storage and Evaluation

### Data Storage

The OPENSAR software stores the acquired data from the data acquisition electronics as raw data (in microvolt readings from the probe sensors), together with all necessary software parameters for the data evaluation (probe calibration data, liquid parameters and device frequency and modulation data) in measurement files. The software evaluates the desired unit and format for output each time the data is visualized or exported. This allows verification of the complete software setup even after the measurement and allows correction of incorrect parameter settings. For example, if a measurement has been performed with a wrong crest factor parameter in the device setup, the parameter can be corrected afterwards and the data can be re-evaluated.

The measured data can be visualized or exported in different units or formats, depending on the selected probe type ([V/m], [A/m], [°C], [mW/g], [mW/cm<sup>2</sup>], [dBrel], etc.). Some of these units are not available in certain situations or show meaningless results, e.g., a SAR output in a lossless media will always be zero. Raw data can also be exported to perform the evaluation with other software packages.

### Data Evaluation

The OPENSAR software automatically executes the following procedures to calculate the field units from the microvolt readings at the probe connector. The parameters used in the evaluation are stored in the configuration modules of the software:

Probe parameters:	- Sensitivity	Normi, ai0, ai1, ai2
	- Conversion factor	ConvFi
	- Diode compression point	Dcpi
Device parameters:	- Frequency	f
	- Crest factor	cf
Media parameters:	- Conductivity	σ
	- Density	ρ

These parameters must be set correctly in the software. They can be found in the component documents or they can be imported into the software from the configuration files issued for the OPENSAR components. In the direct measuring mode of the multimeter option, the parameters of the actual system setup are used. In the scan visualization and export modes, the parameters stored in the corresponding document files are used.

The first step of the evaluation is a linearization of the filtered input signal to account for the compression characteristics of the detector diode. The compensation depends on the input signal, the diode type and the DC-transmission factor from the diode to the evaluation electronics. If the exciting field is pulsed, the crest factor of the signal must be known to correctly compensate for peak power. The formula for each channel can be given as:

$$V_i = U_i + U_i^2 \cdot \frac{cf}{dcp_i}$$

With  $V_i$  = compensated signal of channel  $i$  ( $i = x, y, z$ )  
 $U_i$  = input signal of channel  $i$  ( $i = x, y, z$ )  
 $cf$  = crest factor of exciting field  
 $dcp_i$  = diode compression point

From the compensated input signals the primary field data for each channel can be evaluated:

$$E - \text{fieldprobes} : E_i = \sqrt{\frac{V_i}{Norm_i \cdot ConvF}}$$

$$H - \text{fieldprobes} : H_i = \sqrt{V_i} \cdot \frac{a_{i0} + a_{i1}f + a_{i2}f^2}{f}$$

With  $V_i$  = compensated signal of channel  $i$  ( $i = x, y, z$ )  
 $Norm_i$  = sensor sensitivity of channel  $i$  ( $i = x, y, z$ )  
 [mV/(V/m)<sup>2</sup>] for E-field Probes  
 $ConvF$  = sensitivity enhancement in solution



- aij = sensor sensitivity factors for H-field probes
- f = carrier frequency [GHz]
- Ei = electric field strength of channel i in V/m
- Hi = magnetic field strength of channel i in A/m

The RSS value of the field components gives the total field strength (Hermitian magnitude):

$$E_{tot} = \sqrt{E_x^2 + E_y^2 + E_z^2}$$

The primary field data are used to calculate the derived field units.

$$SAR = E_{tot}^2 \cdot \frac{\sigma}{\rho \cdot 1'000}$$

- with SAR = local specific absorption rate in mW/g
- Etot = total field strength in V/m
- σ = conductivity in [mho/m] or [Siemens/m]
- ρ = equivalent tissue density in g/cm3

Note that the density is normally set to 1 (or 1.06), to account for actual brain density rather than the density of the simulation liquid.

### 3.7. Position of the wireless device in relation to the phantom

#### General considerations

This standard specifies two handset test positions against the head phantom – the “cheek” position and the “tilt” position.

The power flow density is calculated assuming the excitation field as a free space field

$$P_{(pwe)} = \frac{E_{tot}^2}{3770} \text{ or } P_{(pwe)} = H_{tot}^2 \cdot 37.7$$

Where P<sub>pwe</sub>=Equivalent power density of a plane wave in mW/cm2

E<sub>tot</sub>=total electric field strength in V/m

H<sub>tot</sub>=total magnetic field strength in A/m

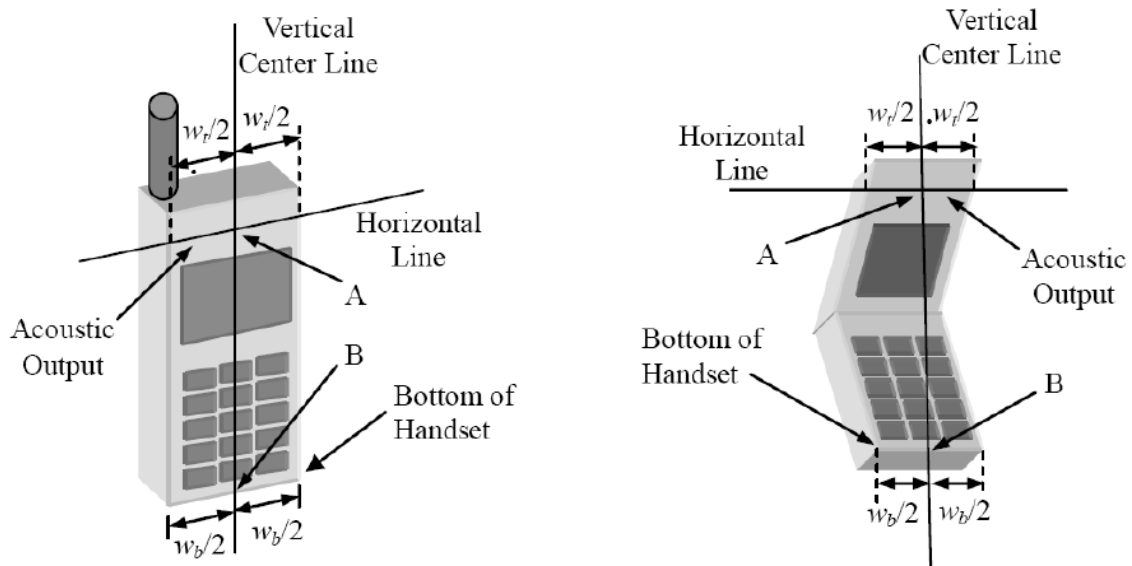

- W<sub>t</sub> Width of the handset at the level of the acoustic
- W<sub>b</sub> Width of the bottom of the handset
- A Midpoint of the width w<sub>t</sub> of the handset at the level of the acoustic output
- B Midpoint of the width w<sub>b</sub> of the bottom of the handset

Picture 1-a Typical “fixed” case handset Picture 1-b Typical “clam-shell” case handset

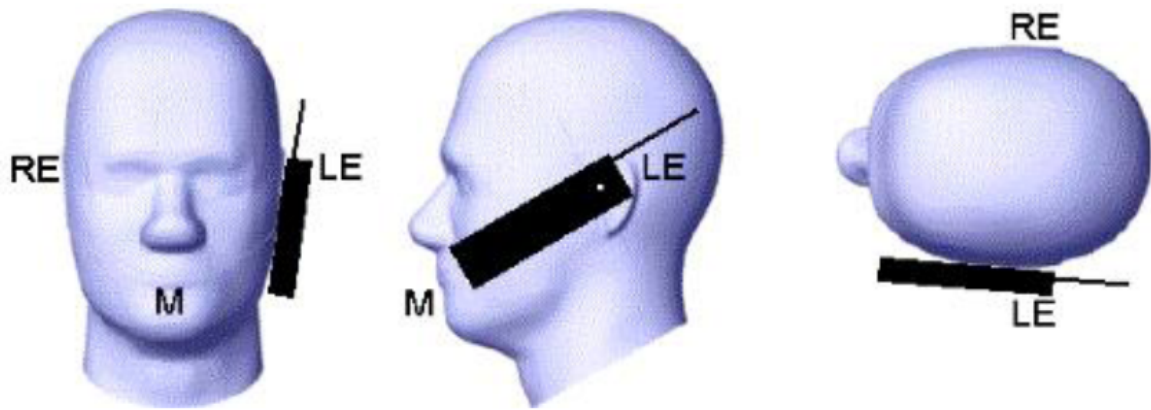

Picture 2 Cheek position of the wireless device on the left side of SAM

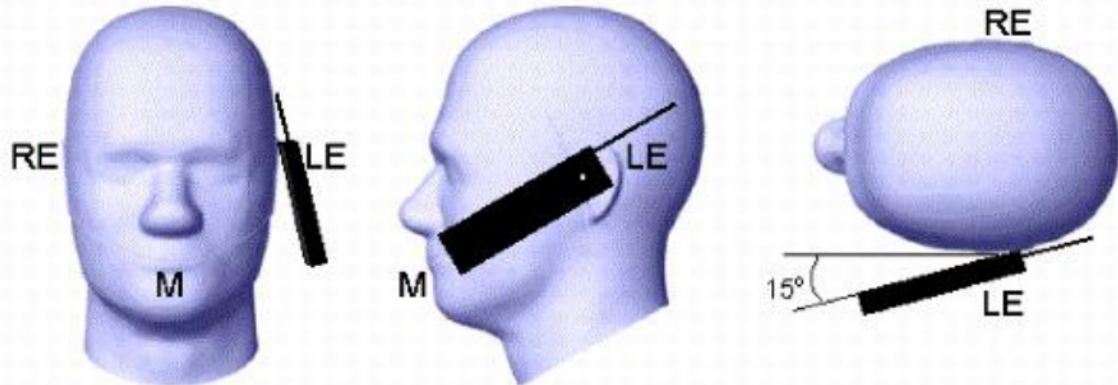

Picture 3 Tilt position of the wireless device on the left side of SAM

For body SAR test we applied to FCC KDB941225, KDB447498, KDB248227, KDB648654;

### 3.8. Tissue Dielectric Parameters for Head and Body Phantoms

The liquid is consisted of water, salt, Glycol, Sugar, Preventol and Cellulose. The liquid has previously been proven to be suited for worst-case. It's satisfying the latest tissue dielectric parameters requirements proposed by the KDB865664.

The composition of the tissue simulating liquid

Ingredient (% Weight)	750MHz		835MHz		1800 MHz		1900 MHz		2450MHz		2600MHz		5000MHz	
	Head	Body	Head	Body	Head	Body	Head	Body	Head	Body	Head	Body	Head	Body
Water	39.28	51.3	41.45	52.5	54.5	40.2	54.9	40.4	62.7	73.2	60.3	71.4	65.5	78.6
Preventol	0.10	0.10	0.10	0.10	0.00	0.00	0.00	0.00	0.00	0.00	0.00	0.00	0.00	0.00
HEC	1.00	1.00	1.00	1.00	0.00	0.00	0.00	0.00	0.00	0.00	0.00	0.00	0.00	0.00
DGBE	0.00	0.00	0.00	0.00	45.33	59.31	44.92	59.10	36.80	26.70	39.10	28.40	0.00	0.00
Triton X-100	0.00	0.00	0.00	0.00	0.00	0.00	0.00	0.00	0.00	0.00	0.00	0.00	17.2	10.7

Target Frequency (MHz)	Head		Body	
	$\epsilon_r$	$\sigma$ (S/m)	$\epsilon_r$	$\sigma$ (S/m)
150	52.3	0.76	61.9	0.80
300	45.3	0.87	58.2	0.92
450	43.5	0.87	56.7	0.94
835	41.5	0.90	55.2	0.97
900	41.5	0.97	55.0	1.05
915	41.5	0.98	55.0	1.06
1450	40.5	1.20	54.0	1.30
1610	40.3	1.29	53.8	1.40
1800-2000	40.0	1.40	53.3	1.52
2450	39.2	1.80	52.7	1.95
3000	38.5	2.40	52.0	2.73
5800	35.3	5.27	48.2	6.00

### 3.9. Tissue equivalent liquid properties

Dielectric Performance of Head and Body Tissue Simulating Liquid

Tissue Type	Measured Frequency (MHz)	Target Tissue		Measured Tissue				Liquid Temp.	Test Data
		$\sigma$	$\epsilon_r$	$\sigma$	Dev.	$\epsilon_r$	Dev.		
835H	835	0.90	41.50	0.88	-2.22%	41.01	-1.18%	21.1	09/03/2018
1900H	1800	1.40	40.00	1.41	0.71%	40.52	1.30%	20.5	09/12/2018
835B	835	0.97	55.20	0.98	1.03%	55.05	-0.27%	20.3	09/13/2018
1900B	1800	1.52	53.30	1.56	2.63%	54.33	1.93%	21.4	09/21/2018

### 3.10. System Check

The purpose of the system check is to verify that the system operates within its specifications at the device test frequency. The system check is simple check of repeatability to make sure that the system works correctly at the time of the compliance test;

System check results have to be equal or near the values determined during dipole calibration with the relevant liquids and test system ( $\pm 10\%$ ).

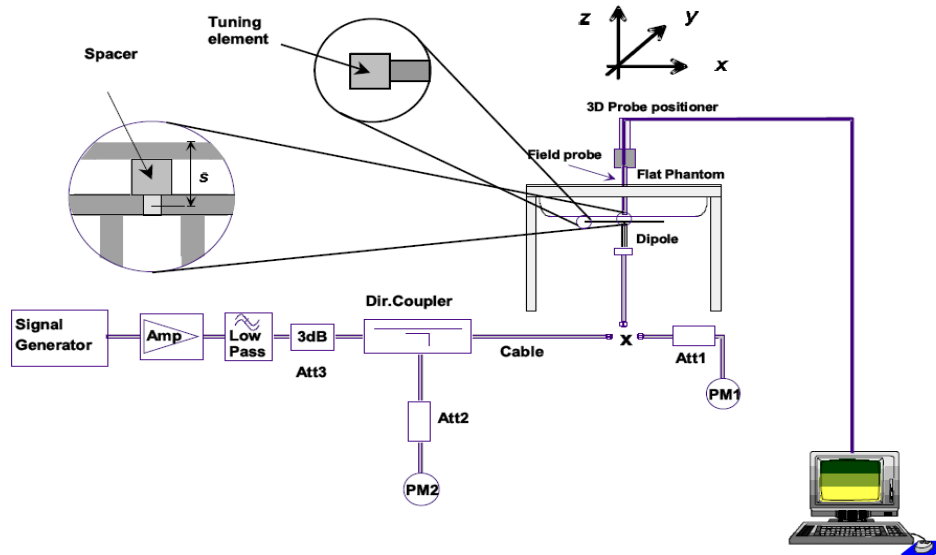

The output power on dipole port must be calibrated to 20 dBm (100mW) before dipole is connected.



Photo of Dipole Setup

**Justification for Extended SAR Dipole Calibrations**

Referring to KDB 865664D01V01r04, if dipoles are verified in return loss (<-20dB, within 20% of prior calibration), and in impedance (within 5 ohm of prior calibration), the annual calibration is not necessary and the calibration interval can be extended. While calibration intervals not exceed 3 years.

SID835SN 07/14 DIP 0G835-303 Extend Dipole Calibrations

Date of Measurement	Return-Loss (dB)	Delta (%)	Real Impedance (ohm)	Delta (ohm)	Imaginary Impedance (ohm)	Delta (ohm)
2015-10-01	-24.46		55.4		2.4	
2016-09-30	-25.53	4.374	56.1	0.7	1.352	-1.048
2017-09-30	-25.16	2.862	55.8	0.4	1.832	-0.568

SID1900 SN 30/14 DIP 1G900-333 Extend Dipole Calibrations

Date of Measurement	Return-Loss (dB)	Delta (%)	Real Impedance (ohm)	Delta (ohm)	Imaginary Impedance (ohm)	Delta (ohm)
2015-10-01	-23.68		51.2		6.4	
2016-09-30	-23.40	-1.182	50.188	-1.012	3.562	-2.838
2017-09-30	-23.55	-0.549	50.395	-0.805	4.261	-2.139

Mixture Type	Frequency (MHz)	Power	SAR <sub>1g</sub> (W/Kg)	SAR <sub>10g</sub> (W/Kg)	Drift (%)	1W Target		Difference percentage		Liquid Temp	Date
						SAR <sub>1g</sub> (W/Kg)	SAR <sub>10g</sub> (W/Kg)	1g	10g		
Head	835	100 mW	0.986	0.635	1.02	9.60	6.20	2.71%	2.42%	21.1	09/03/2018
		Normalize to 1 Watt	9.86	6.35							
Body	835	100 mW	0.972	0.637	0.65	9.90	6.39	-1.82%	-0.31%	20.3	09/13/2018
		Normalize to 1 Watt	9.72	6.37							
Head	1900	100 mW	3.928	2.006	-3.64	39.84	20.20	-1.41%	-0.69%	20.5	09/12/2018
		Normalize to 1 Watt	39.28	20.06							
Body	1900	100 mW	4.114	2.054	-1.07	43.33	21.59	-5.05%	4.86%	21.4	09/21/2018
		Normalize to 1 Watt	41.14	20.54							

### 3.11. SAR measurement procedure

The measurement procedures are as follows:

#### 3.11.1 Conducted power measurement

- a. For WWAN power measurement, use base station simulator connection with RF cable, at maximum power in each supported wireless interface and frequency band.
- b. Read the WWAN RF power level from the base station simulator.
- c. For WLAN/BT power measurement, use engineering software to configure EUT WLAN/BT continuously Transmission, at maximum RF power in each supported wireless interface and frequency band.
- d. Connect EUT RF port through RF cable to the power meter, and measure WLAN/BT output power.

#### 3.11.2 GSM Test Configuration

SAR tests for GSM 850 and GSM 1900, a communication link is set up with a System Simulator (SS) by air link. Using CMU200 the power level is set to "5" for GSM 850, set to "0" for GSM 1900. Since the GPRS class is 12 for this EUT, it has at most 4 timeslots in uplink and at most 4 timeslots in downlink, the maximum total timeslots is 5. the EGPRS class is 12 for this EUT, it has at most 4 timeslots in uplink and at most 4 timeslots in downlink, the maximum total timeslots is 5.

SAR test reduction for GPRS and EDGE modes is determined by the source-based time-averaged output power specified for production units, including tune-up tolerance. The data mode with highest specified time-averaged output power should be tested for SAR compliance in the applicable exposure conditions. For modes with the same specified maximum output power and tolerance, the higher number time-slot configuration should be tested. GSM voice and GPRS data use GMSK, which is a constant amplitude modulation with minimal peak to average power difference within the time-slot burst. For EDGE, GMSK is used for MCS 1 – MCS 4 and 8-PSK is used for MCS 5 – MCS 9; where 8-PSK has an inherently higher peak-to-average power ratio. The GMSK and 8-PSK EDGE configurations are considered separately for SAR compliance. The GMSK EDGE configurations are grouped with GPRS and considered with respect to time-averaged maximum output power to determine compliance. The 3G SAR test reduction procedure is applied to 8-PSK EDGE with GMSK GPRS/EDGE as the primary mode.

### 3.12. Power Reduction

The product without any power reduction.

### 3.13. Power Drift

To control the output power stability during the SAR test, SAR system calculates the power drift by measuring the E-field at the same location at the beginning and at the end of the measurement for each test position. This ensures that the power drift during one measurement is within 5%.

## 4. TEST CONDITIONS AND RESULTS

### 4.1. Conducted Power Results

According KDB 447498D01 General RF Exposure Guidance v06 Section 4.1 2) states that “Unless it is specified differently in the published RF exposure KDB procedures, these requirements also apply to test reduction and test exclusion considerations. Time-averaged maximum conducted output power applies to SAR and, as required by § 2.1091(c), time-averaged ERP applies to MPE. When an antenna port is not available on the device to support conducted power measurement, such as FRS and certain Part 15 transmitters with built-in integral antennas, the maximum output power allowed for production units should be used to determine RF exposure test exclusion and compliance.”

#### <GSM Conducted Power>

General Note:

1. Per KDB 447498 D01v06, the maximum output power channel is used for SAR testing and for further SAR testreduction.
2. According to October 2013TCB Workshop, for GSM / GPRS / EGPRS, the number of time slots to test for SARshould correspond to the highest frame-average maximum output power configuration, considering the possibility ofe.g. 3rd party VoIP operation for head and body-worn SAR testing, the EUT was set in GPRS (2Tx slot)forGSM850/GSM1900 band due to their highest frame-average power.
3. For body-worn mode SAR testing, GPRS should be evaluated, therefore the EUT was set in GPRS (3 Tx slots)for GSM850/GSM1900 band due to its highest frame-average power.

#### Conducted power measurement results for GSM850/PCS1900

##### <SIM1>

GSM 850		Tune-up	Burst Conducted power (dBm)			Division Factors	Tune-up	Average power (dBm)		
			Channel/Frequency(MHz)					Channel/Frequency(MHz)		
Max			128/824.2	190/836.6	251/848.8		Max	128/824.2	190/836.6	251/848.8
GSM		33.00	32.84	32.74	32.69	-9.03dB	23.97	23.81	23.71	23.66
GPRS (GMSK)	1TX slot	33.00	32.54	32.51	32.35	-9.03dB	23.97	23.51	23.48	23.32
	<b>2TX slot</b>	<b>32.00</b>	<b>31.55</b>	<b>31.32</b>	<b>31.45</b>	<b>-6.02dB</b>	<b>25.98</b>	<b>25.53</b>	<b>25.30</b>	<b>25.43</b>
	3TX slot	29.50	29.35	29.48	29.26	-4.26dB	25.24	25.09	25.22	25.00
	4TX slot	28.00	27.48	27.62	27.14	-3.01dB	24.99	24.47	24.61	24.13
GSM 1900		Tune-up	Burst Conducted power (dBm)			Division Factors	Tune-up	Average power (dBm)		
			Channel/Frequency(MHz)					Channel/Frequency(MHz)		
Max			512/1850.2	661/1880	810/1909.8		Max.	512/1850.2	661/1880	810/1909.8
GSM		30.00	29.85	29.77	29.67	-9.03dB	20.97	20.82	20.74	20.64
GPRS (GMSK)	1TX slot	30.00	29.36	29.15	29.51	-9.03dB	20.97	20.33	20.12	20.48
	2TX slot	28.00	27.51	27.45	27.32	-6.02dB	21.98	21.49	21.43	21.30
	3TX slot	26.50	26.48	26.32	26.44	-4.26dB	22.24	22.22	22.06	22.18
	<b>4TX slot</b>	<b>26.00</b>	<b>25.32</b>	<b>25.45</b>	<b>25.53</b>	<b>-3.01dB</b>	<b>22.99</b>	<b>22.31</b>	<b>22.44</b>	<b>22.52</b>

#### Notes:

##### 1. Division Factors

To average the power, the division factor is as follows:

1TX-slot = 1 transmit time slot out of 8 time slots=> conducted power divided by (8/1) => -9.00dB

2TX-slots = 2 transmit time slots out of 8 time slots=> conducted power divided by (8/2) => -6.00dB

3TX-slots = 3 transmit time slots out of 8 time slots=> conducted power divided by (8/3) => -4.26dB

4TX-slots = 4 transmit time slots out of 8 time slots=> conducted power divided by (8/4) => -3.00dB

2. According to the conducted power as above, the GPRS measurements are performed with 2Txslot for GPRS850 and 4TxslotGPRS1900.

3. This EUT owns two SIM cards , we found the SIM 1 is the worst case ,so its result is recorded in this report.

**<BT Conducted Power>**

Mode	channel	Frequency (MHz)	Conducted AVG output power (dBm)
GFSK	0	2402	-0.120
	39	2441	0.591
	78	2480	0.701
π/4-DQPSK	0	2402	-0.437
	39	2441	-0.135
	78	2480	-0.152
8DPSK	0	2402	-0.716
	39	2441	-0.133
	78	2480	-0.295

Per KDB 447498 D01v06, the 1-g and 10-g SAR test exclusion thresholds for 100 MHz to 6 GHz at test separation distances  $\leq 50$  mm are determined by:

$$[(\text{max. power of channel, including tune-up tolerance, mW}) / (\text{min. test separation distance, mm})] \cdot [\sqrt{f(\text{GHz})}] \leq 3.0$$

for 1-g SAR and  $\leq 7.5$  for 10-g extremity SAR

- $f(\text{GHz})$  is the RF channel transmit frequency in GHz
- Power and distance are rounded to the nearest mW and mm before calculation
- The result is rounded to one decimal place for comparison

Bluetooth Turn up Power (dBm)	Separation Distance (mm)	Frequency (GHz)	Exclusion Thresholds
1.0	5	2.45	0.4

Per KDB 447498 D01v06, when the minimum test separation distance is  $< 5$  mm, a distance of 5 mm is applied to determine SAR test exclusion. The test exclusion threshold is  $0.4 < 3.0$ , SAR testing is not required.



## 4.2. Manufacturing tolerance

### GSM Speech <SIM1>

GSM 850 (GMSK) (Burst Average Power)			
Channel	Channel 128	Channel 190	Channel 251
Target (dBm)	32.0	32.0	32.0
Tolerance $\pm$ (dB)	1.0	1.0	1.0
GSM 1900 (GMSK) (Burst Average Power)			
Channel	Channel 512	Channel 661	Channel 810
Target (dBm)	29.0	29.0	29.0
Tolerance $\pm$ (dB)	1.0	1.0	1.0

### <SIM1>

GSM 850 GPRS (GMSK) (Burst Average Power)				
Channel		128	190	251
1 Txslot	Target (dBm)	32.0	32.0	32.0
	Tolerance $\pm$ (dB)	1.0	1.0	1.0
2 Txslot	Target (dBm)	31.0	31.0	31.0
	Tolerance $\pm$ (dB)	1.0	1.0	1.0
3 Txslot	Target (dBm)	28.5	28.5	28.5
	Tolerance $\pm$ (dB)	1.0	1.0	1.0
4 Txslot	Target (dBm)	27.0	27.0	27.0
	Tolerance $\pm$ (dB)	1.0	1.0	1.0
GSM 1900 GPRS (GMSK) (Burst Average Power)				
Channel		512	661	810
1 Txslot	Target (dBm)	29.0	29.0	29.0
	Tolerance $\pm$ (dB)	1.0	1.0	1.0
2 Txslot	Target (dBm)	27.0	27.0	27.0
	Tolerance $\pm$ (dB)	1.0	1.0	1.0
3 Txslot	Target (dBm)	25.5	25.5	25.5
	Tolerance $\pm$ (dB)	1.0	1.0	1.0
4 Txslot	Target (dBm)	25.0	25.0	25.0
	Tolerance $\pm$ (dB)	1.0	1.0	1.0

### Bluetooth V2.1+EDR

GFSK (Average)			
Channel	Channel 0	Channel 39	Channel 78
Target (dBm)	0.0	0.0	0.0
Tolerance $\pm$ (dB)	1.0	1.0	1.0
8DPSK (Average)			
Channel	Channel 0	Channel 39	Channel 78
Target (dBm)	0.0	0.0	0.0
Tolerance $\pm$ (dB)	1.0	1.0	1.0
$\pi/4$ DQPSK (Average)			
Channel	Channel 0	Channel 39	Channel 78
Target (dBm)	0.0	0.0	0.0
Tolerance $\pm$ (dB)	1.0	1.0	1.0

### 4.3. Transmit Antennas and SAR Measurement Position

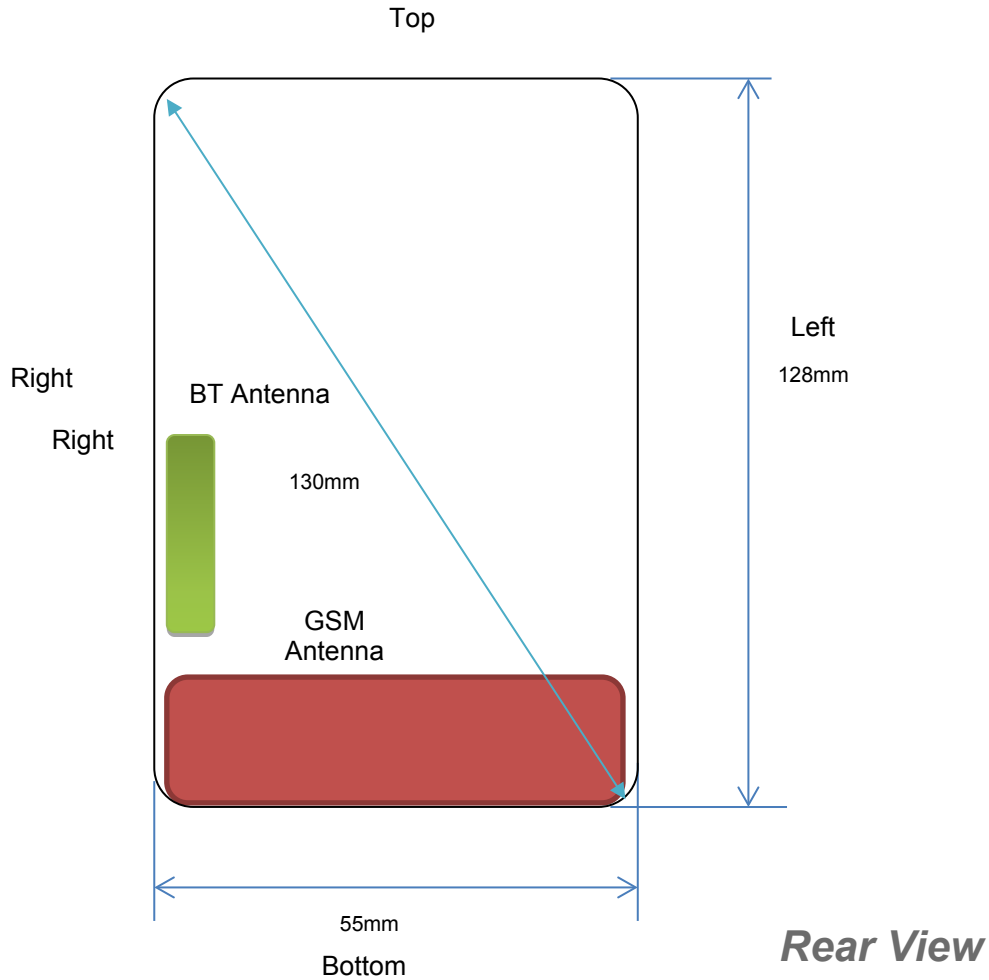

Antenna information:

WWAN Main Antenna	GSM TX/RX
BT Antenna	BT TX/RX

Note:

- 1). Per KDB648474 D04, because the overall diagonal distance of this devices is 130mm<160mm, it is considered as "Phablet" device.
- 2). Per KDB648474 D04, 10-g extremity SAR is not required when Body-Worn mode 1-g reported SAR < 1.2 W/Kg.

#### 4.4. SAR Measurement Results

The calculated SAR is obtained by the following formula:

$$\text{Reported SAR} = \text{Measured SAR} * 10^{(P_{\text{target}} - P_{\text{measured}})/10}$$

$$\text{Scaling factor} = 10^{(P_{\text{target}} - P_{\text{measured}})/10}$$

$$\text{Reported SAR} = \text{Measured SAR} * \text{Scaling factor}$$

Where

$P_{\text{target}}$  is the power of manufacturing upper limit;

$P_{\text{measured}}$  is the measured power;

Measured SAR is measured SAR at measured power which including power drift)

Reported SAR which including Power Drift and Scaling factor

#### Duty Cycle

Test Mode	Duty Cycle
Speech for GSM850/1900	1:8
GPRS850	1:2.67
GPRS1900	1:2.67

#### 4.4.1 SAR Results

##### SAR Values [GSM 850]

Ch.	Freq. (MHz)	Time slots	Test Position	Conducted Power (dBm)	Maximum Allowed Power (dBm)	Power Drift (%)	Scaling Factor	SAR <sub>1-g</sub> results(W/kg)		Graph Results
								Measured	Reported	
<i>measured / reported SAR numbers –Head&lt;SIM1&gt;</i>										
128	824.2	Voice	Left Cheek	32.84	33.00	-3.91	1.038	<b>0.362</b>	<b>0.376</b>	<b>Plot 1</b>
128	824.2	Voice	Left Tilt	32.84	33.00	1.06	1.038	0.165	0.171	
128	824.2	Voice	Right Cheek	32.84	33.00	-1.95	1.038	0.250	0.259	
128	824.2	Voice	Right Tilt	32.84	33.00	-0.67	1.038	0.152	0.158	
<i>measured / reported SAR numbers - Body (distance 10mm)&lt;SIM1&gt;</i>										
128	824.2	2Txslots	Front	31.55	32.00	0.92	1.109	0.567	0.629	
128	824.2	2Txslots	Rear	31.55	32.00	0.66	1.109	<b>0.862</b>	<b>0.956</b>	<b>Plot 2</b>
190	836.6	2Txslots	Rear	31.32	32.00	-1.30	1.169	0.629	0.736	
251	848.8	2Txslots	Rear	31.45	32.00	-1.67	1.135	0.704	0.799	

Remark:

- The value with black color is the maximum SAR Value of each test band.
- The frame average of GPRS (2Tx slots) higher than GSM and sample can support VoIP function, tested at GPRS (2Tx slots) mode for head.
- Per FCC KDB Publication 447498 D01, if the reported (scaled) SAR measured at the middle channel or highest output power channel for each test configuration is  $\leq 0.8$  W/kg then testing at the other channels is optional for such test configuration(s).

##### SAR Values [GSM 1900]

Ch.	Freq. (MHz)	time slots	Test Position	Conducted Power (dBm)	Maximum Allowed Power (dBm)	Power Drift (%)	Scaling Factor	SAR <sub>1-g</sub> results(W/kg)		Graph Results
								Measured	Reported	
<i>measured / reported SAR numbers –Head&lt;SIM1&gt;</i>										
512	1850.2	Voice	Left Cheek	29.85	30.00	-3.24	1.035	<b>0.665</b>	<b>0.688</b>	Plot 3
512	1850.2	Voice	Left Tilt	29.85	30.00	-0.34	1.035	0.368	0.381	
512	1850.2	Voice	Right Cheek	29.85	30.00	-1.22	1.035	0.501	0.519	
512	1850.2	Voice	Right Tilt	29.85	30.00	0.55	1.035	0.330	0.342	
<i>measured / reported SAR numbers – Body (distance 10mm)</i>										
810	1909.8	4Txslots	Front	25.53	26.00	2.67	1.114	0.530	0.591	
810	1909.8	4Txslots	Rear	25.53	26.00	-2.42	1.114	<b>0.961</b>	<b>1.071</b>	<b>Plot 4</b>
512	1850.2	4Txslots	Rear	25.32	26.00	-0.67	1.169	0.731	0.855	
661	1880.0	4Txslots	Rear	25.45	26.00	-1.68	1.135	0.768	0.872	

Remark:

- The value with black color is the maximum SAR Value of each test band.
- The frame average of GPRS (4Tx slots) higher than GSM and sample can support VoIP function, tested at GPRS (4Tx slots) mode for head.
- Per FCC KDB Publication 447498 D01, if the reported (scaled) SAR measured at the middle channel or highest output power channel for each test configuration is  $\leq 0.8$  W/kg then testing at the other channels is optional for such test configuration(s).

#### 4.4.2 Standalone SAR Test Exclusion Considerations and Estimated SAR

Per KDB447498 requires when the standalone SAR test exclusion of section 4.3.1 is applied to an antenna that transmits simultaneously with other antennas, the standalone SAR must be estimated according to the following to determine simultaneous transmission SAR test exclusion;

•  $(\text{max. power of channel, including tune-up tolerance, mW}) / (\text{min. test separation distance, mm}) \cdot [\sqrt{f(\text{GHz})} \cdot x]$  W/kg for test separation distances  $\leq 50$  mm;

where  $x = 7.5$  for 1-g SAR, and  $x = 18.75$  for 10-g SAR.

• 0.4 W/kg for 1-g SAR and 1.0 W/kg for 10-g SAR, when the test separation distances is  $> 50$  mm

Per FCC KD B447498 D01, simultaneous transmission SAR test exclusion may be applied when the sum of the 1-g SAR for all the transmitting antenna in a specific a physical test configuration is  $\leq 1.6$  W/Kg. When the sum is greater than the SAR limit, SAR test exclusion is determined by the SAR to peak location separation ratio.

$$\text{Ratio} = \frac{(\text{SAR}_1 + \text{SAR}_2)^{1.5}}{(\text{peak location separation, mm})} < 0.04$$

Estimated stand alone SAR					
Communication system	Frequency (MHz)	Configuration	Maximum Power (dBm)	Separation Distance (mm)	Estimated SAR <sub>1-g</sub> (W/kg)
Bluetooth*	2450	Head	1.00	5	0.053
Bluetooth*	2450	Body-worn	1.00	10	0.026

Remark:

1. Bluetooth\*- Including Lower power Bluetooth
2. Maximum average power including tune-up tolerance;
3. When the minimum test separation distance is  $< 5$  mm, a distance of 5 mm is applied to determine SAR test exclusion
4. Body as body use distance is 10mm from manufacturer declaration of user manual

#### 4.5. Simultaneous TX SAR Considerations

##### 4.5.1 Introduction

The following procedures adopted from "FCC SAR Considerations for Cell Phones with Multiple Transmitters" are applicable to handsets with built-in unlicensed transmitters such as Bluetooth devices which may simultaneously transmit with the licensed transmitter.

For the DUT, the BT modules sharing same antenna, GSME modules sharing a single antenna; BT and GSM can simultaneous transmit;

Application Simultaneous Transmission information:

Air-Interface	Band (MHz)	Type	Simultaneous Transmissions	Voice over Digital Transport(Data)
GSM	850	VO	Yes, BT	N/A
	1900	VO		
	GPRS	DT	Yes, BT	N/A
BT	2450	DT	Yes, GSM, GPRS	N/A

Note: VO-Voice Service only; DT-Digital Transport

Note:

BT- Classical Bluetooth;

#### 4.5.2 Evaluation of Simultaneous SAR

##### Head Exposure Conditions

##### Simultaneous transmission SAR for BT and GSM

Test Position	GSM850 Reported SAR <sub>1-g</sub> (W/Kg)	GSM1900 Reported SAR <sub>1-g</sub> (W/Kg)	BT Estimated SAR <sub>1-g</sub> (W/Kg)	MAX. $\Sigma$ SAR <sub>1-g</sub> (W/Kg)	SAR <sub>1-g</sub> Limit (W/Kg)	Peak location separation ratio	Simut Meas. Required
Left Cheek	<b>0.376</b>	<b>0.688</b>	0.053	<b>0.741</b>	1.6	no	no
Left Tilt	0.171	0.381	0.053	0.434	1.6	no	no
Right Cheek	0.259	0.519	0.053	0.572	1.6	no	no
Right Tilt	0.158	0.342	0.053	0.395	1.6	no	no

### Body-worn Exposure Conditions

#### Simultaneous transmission SAR for BT and GSM

Test Position	GSM850 Reported SAR <sub>1-g</sub> (W/Kg)	GSM1900 Reported SAR <sub>1-g</sub> (W/Kg)	BT Estimated SAR <sub>1-g</sub> (W/Kg)	MAX. $\Sigma$ SAR <sub>1-g</sub> (W/Kg)	SAR <sub>1-g</sub> Limit (W/Kg)	Peak location separation ratio	Simut Meas. Required
Front	0.629	0.591	0.026	0.655	1.6	no	no
Rear	<b>0.956</b>	<b>1.071</b>	0.026	<b>1.097</b>	1.6	no	no

#### Note:

1. The value with black color is the maximum values of standalone
2. The value with blue color is the maximum values of  $\Sigma$ SAR<sub>1-g</sub>

#### 4.6. SAR Measurement Variability

According to KDB865664, Repeated measurements are required only when the measured SAR is  $\geq 0.80$  W/kg. If the measured SAR value of the initial repeated measurement is  $< 1.45$  W/kg with  $\leq 20\%$  variation, only one repeated measurement is required to reaffirm that the results are not expected to have substantial variations, which may introduce significant compliance concerns. A second repeated measurement is required only if the measured result for the initial repeated measurement is within 10% of the SAR limit and vary by more than 20%, which are often related to device and measurement setup difficulties. The following procedures are applied to determine if repeated measurements are required. The same procedures should be adapted for measurements according to extremity and occupational exposure limits by applying a factor of 2.5 for extremity exposure and a factor of 5 for occupational exposure to the corresponding SAR thresholds.<sup>19</sup> The repeated measurement results must be clearly identified in the SAR report. All measured SAR, including the repeated results, must be considered to determine compliance and for reporting according to KDB 690783. Repeated measurement is not required when the original highest measured SAR is  $< 0.80$  W/kg; steps 2) through 4) do not apply.

- 1) When the original highest measured SAR is  $\geq 0.80$  W/kg, repeat that measurement once.
- 2) Perform a second repeated measurement only if the ratio of largest to smallest SAR for the original and first repeated measurements is  $> 1.20$  or when the original or repeated measurement is  $\geq 1.45$  W/kg ( $\sim 10\%$  from the 1-g SAR limit).
- 3) Perform a third repeated measurement only if the original, first or second repeated measurement is  $\geq 1.5$  W/kg and the ratio of largest to smallest SAR for the original, first and second repeated measurements is  $> 1.20$ .
- 4) Perform a third repeated measurement only if the original, first or second repeated measurement is  $\geq 1.5$  W/kg and the ratio of largest to smallest SAR for the original, first and second repeated measurements is  $> 1.20$ .

Frequency Band (MHz)	Air Interface	RF Exposure Configuration	Test Position	Repeated SAR (yes/no)	Highest Measured SAR <sub>1-g</sub> (W/Kg)	First Repeated	
						Measured SAR <sub>1-g</sub> (W/Kg)	Largest to Smallest SAR Ratio
850	GSM850	Standalone	Body-Rear	no	0.862	0.794	0.765
1900	GSM1900	Standalone	Body-Rear	no	0.961	0.814	0.731

**Remark:**

1. *Second Repeated Measurement is not required since the ratio of the largest to smallest SAR for the original and first repeated measurement is not  $> 1.20$  or 3 (1-g or 10-g respectively)*

#### 4.7. General description of test procedures

1. The DUT is tested using CMU 200 communications testers as controller unit to set test channels and maximum output power to the DUT, as well as for measuring the conducted peak power.
2. Test positions as described in the tables above are in accordance with the specified test standard.
3. Tests in body position were performed in that configuration, which generates the highest time based averaged output power (see conducted power results).
4. Tests in head position with GSM were performed in voice mode with 1 timeslot unless GPRS/EGPRS/DTM function allows parallel voice and data traffic on 2 or more timeslots.
5. UMTS was tested in RMC mode with 12.2 kbit/s and TPC bits set to 'all 1'.
6. WiFi was tested in 802.11b/g/n mode with 1 Mbit/s and 6 Mbit/s. According to KDB 248227 the SAR testing for 802.11g/n is not required since When the highest reported SAR for DSSS is adjusted by the ratio of OFDM to DSSS specified maximum output power and the adjusted SAR is  $\leq 1.2$  W/kg.
7. Required WiFi test channels were selected according to KDB 248227
8. According to FCC KDB pub 248227 D01, When there are multiple test channels with the same measured maximum output power, the channel closest to mid-band frequency is selected for SAR measurement and when there are multiple test channels with the same measured maximum output power and equal separation from mid-band frequency; for example, high and low channels or two mid-band channels, the higher frequency (number) channel is selected for SAR measurement.
9. According to FCC KDB pub 941225 D06 this device has been tested with 10 mm distance to the phantom for operation in WiFi hot spot mode.
10. Per FCC KDB pub 941225 D06 the edges with antennas within 2.5 cm are required to be evaluated for SAR to cover WiFi hot spot function.
11. According to IEEE 1528 the SAR test shall be performed at middle channel. Testing of top and bottom channel is optional.
12. According to KDB 447498 D01 testing of other required channels within the operating mode of a frequency band is not required when the reported 1-g or 10-g SAR for the mid-band or highest output power channel is:
  - $\leq 0.8$  W/kg or 2.0 W/kg, for 1-g or 10-g respectively, when the transmission band is  $\leq 100$  MHz
  - $\leq 0.6$  W/kg or 1.5 W/kg, for 1-g or 10-g respectively, when the transmission band is between 100 MHz and 200 MHz
  - $\leq 0.4$  W/kg or 1.0 W/kg, for 1-g or 10-g respectively, when the transmission band is  $\geq 200$  MHz
13. IEEE 1528-2003 require the middle channel to be tested first. This generally applies to wireless devices that are designed to operate in technologies with tight tolerances for maximum output power variations across channels in the band.
14. Per KDB648474 D04 require when the reported SAR for a body-worn accessory, measured without a headset connected to the handset, is  $< 1.2$  W/kg.
15. Per KDB648474 D04 require when the separation distance required for body-worn accessory testing is larger than or equal to that tested for hotspot mode, using the same wireless mode test configuration for voice and data, such as UMTS, LTE and Wi-Fi, and for the same surface of the phone, the hotspot mode SAR data may be used to support body-worn accessory SAR compliance for that particular configuration (surface)

#### 4.8. Measurement Uncertainty (300MHz-3GHz)

Not required as SAR measurement uncertainty analysis is required in SAR reports only when the highest measured SAR in a frequency band is  $\geq 1.5$  W/kg for 1-g SAR according to KDB865664D01.

### 4.9. System Check Results

Test mode:835MHz(Head)  
 Product Description:Validation  
 Model:Dipole SID835  
 E-Field Probe:SSE2(SN 45/15 EPGO281)  
 Test Date:September 03, 2018

Medium(liquid type)	HSL_850
Frequency (MHz)	835.0000
Relative permittivity (real part)	41.01
Conductivity (S/m)	0.88
Input power	100mW
Crest Factor	1.0
Conversion Factor	2.04
Variation (%)	1.020000
SAR 10g (W/Kg)	0.635201
SAR 1g (W/Kg)	0.986312

#### SURFACE SAR

#### VOLUME SAR

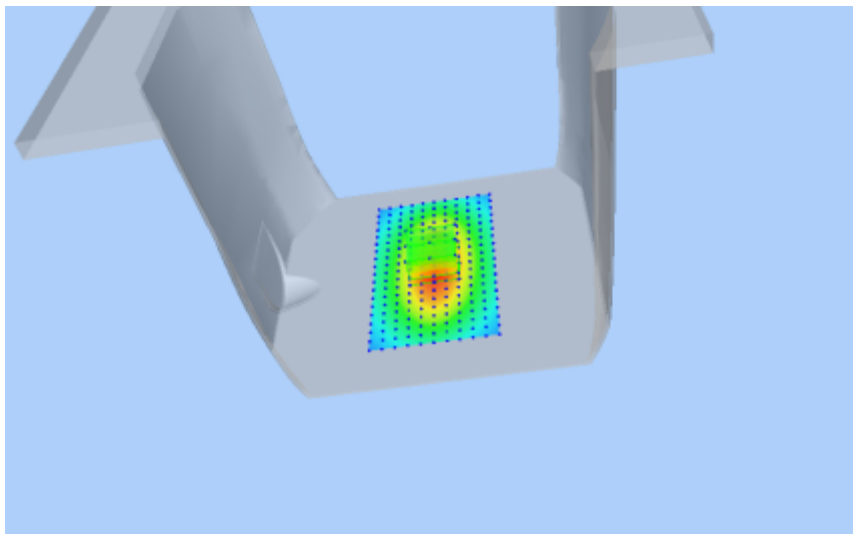
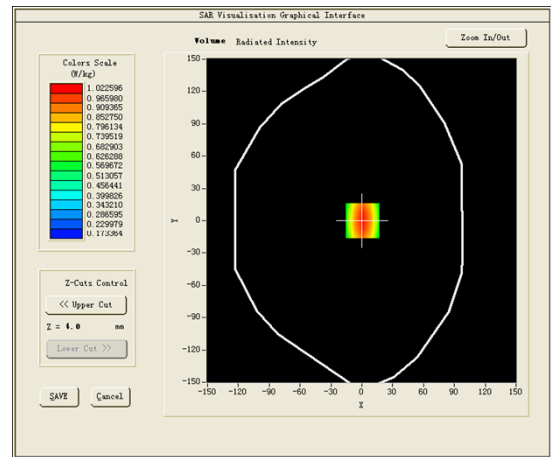
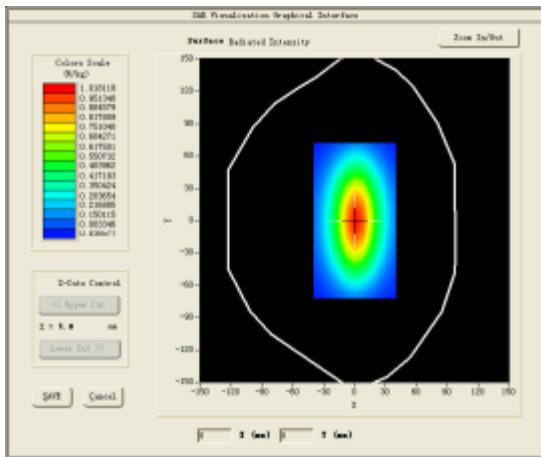



Test mode:835MHz(Body)  
 Product Description:Validation  
 Model:Dipole SID835  
 E-Field Probe:SSE2(SN 45/15 EPGO281)  
 Test Date:September 13, 2018

Medium(liquid type)	MSL_850
Frequency (MHz)	835.0000
Relative permittivity (real part)	55.05
Conductivity (S/m)	0.98
Input power	100mW
Crest Factor	1.0
Conversion Factor	1.85
Variation (%)	0.650000
SAR 10g (W/Kg)	0.637215
SAR 1g (W/Kg)	0.972012

**SURFACE SAR**

**VOLUME SAR**

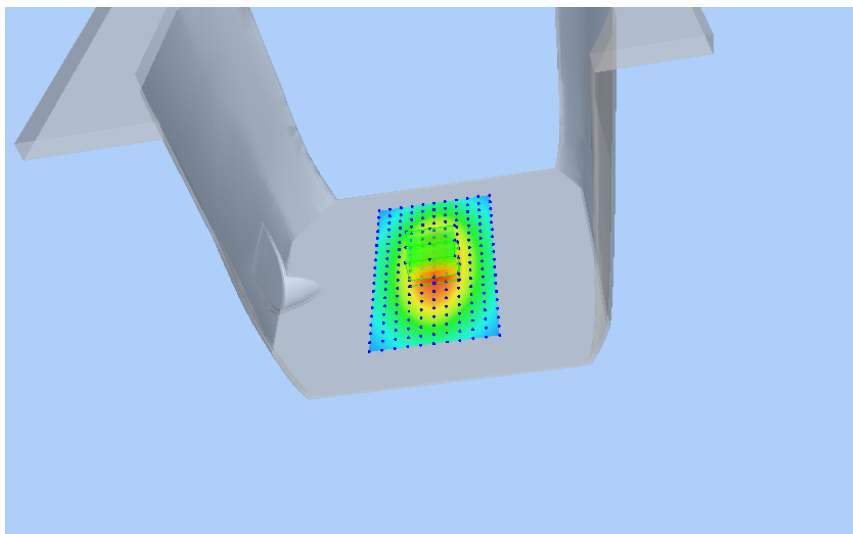
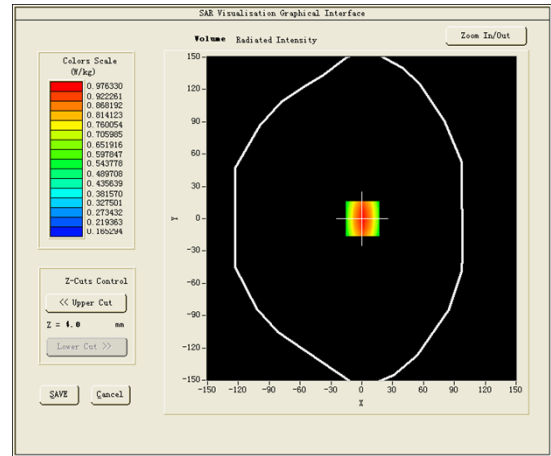
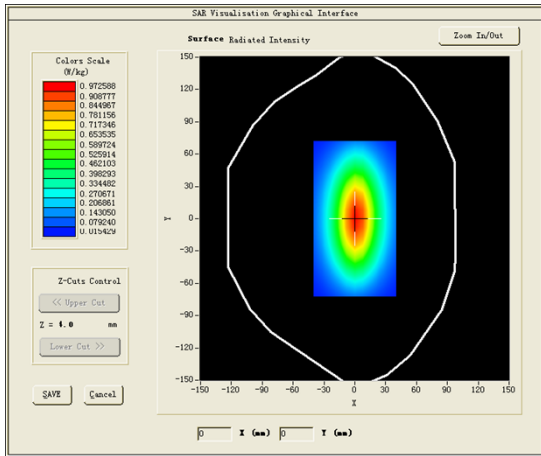

Test mode:1900MHz(Head)  
 Product Description:Validation  
 Model :Dipole SID1900  
 E-Field Probe:SSE2(SN 45/15 EPGO281)  
 Test Date: September 12, 2018

Medium(liquid type)	HSL_1900
Frequency (MHz)	1900.0000
Relative permittivity (real part)	40.52
Conductivity (S/m)	1.41
Input power	100mW
Crest Factor	1.0
Conversion Factor	2.10
Variation (%)	-3.640000
SAR 10g (W/Kg)	2.006210
SAR 1g (W/Kg)	3.928254

**SURFACE SAR**

**VOLUME SAR**

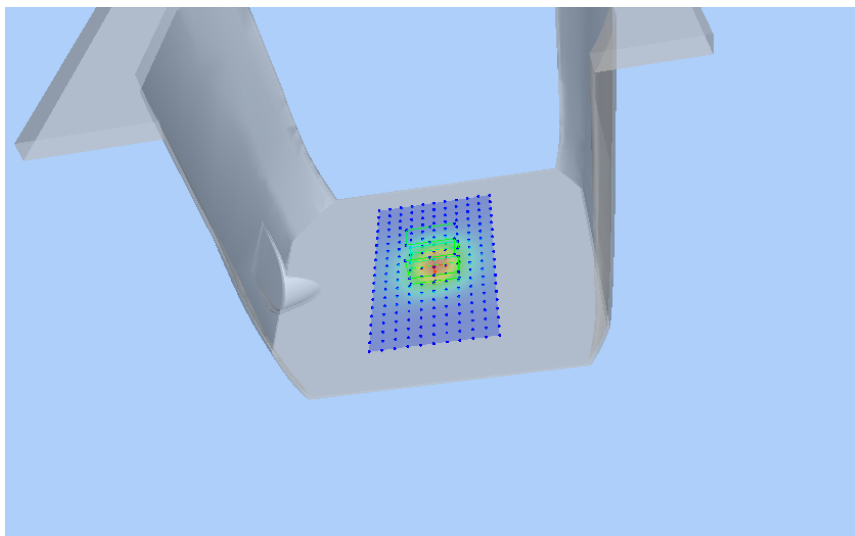
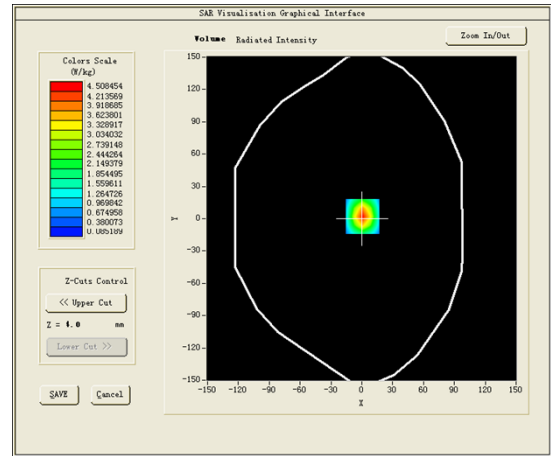
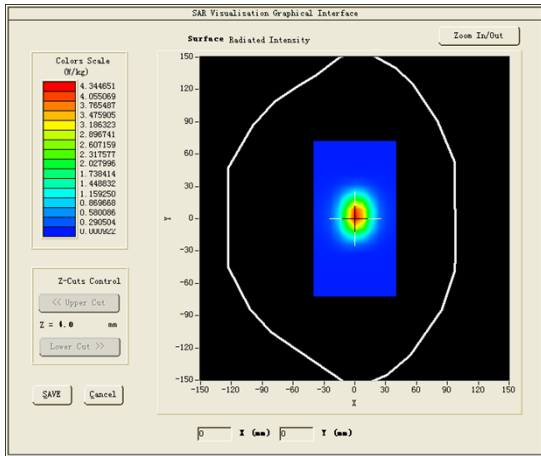

Test mode:1900MHz(Body)  
 Product Description:Validation  
 Model :Dipole SID1900  
 E-Field Probe:SSE2(SN 45/15 EPGO281)  
 Test Date: September 21, 2018

Medium(liquid type)	MSL_1900
Frequency (MHz)	1900.0000
Relative permittivity (real part)	54.33
Conductivity (S/m)	1.56
Input power	100mW
Crest Factor	1.0
Conversion Factor	2.16
Variation (%)	-1.070000
SAR 10g (W/Kg)	2.054325
SAR 1g (W/Kg)	4.114120

**SURFACE SAR**

**VOLUME SAR**

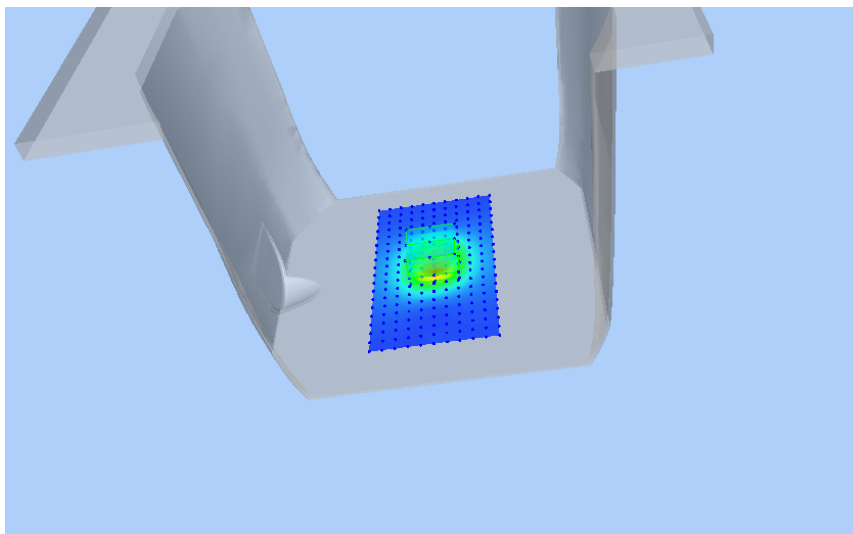
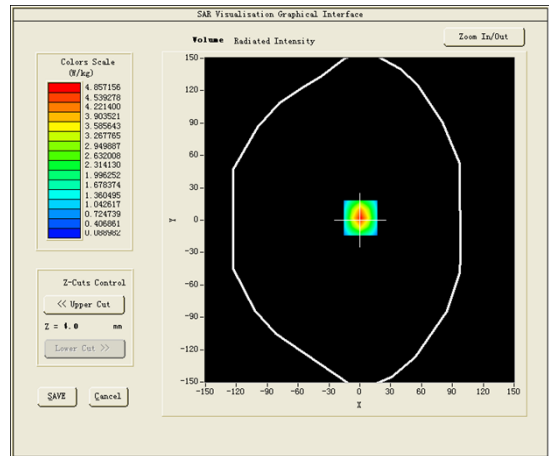
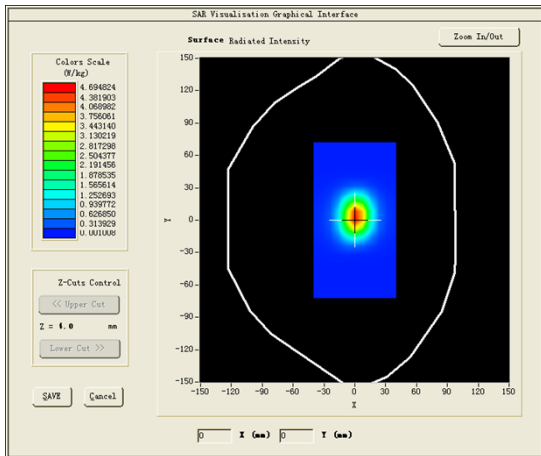

**4.10 SAR Test Graph Results**

SAR plots for the highest measured SAR in each exposure configuration, wireless mode and frequency band combination according to FCC KDB 865664 D02;

#1

Test Mode: GSM 850MHz, Low channel (Head Left Cheek)

Product Description: Feature phone

Model: C3330

Test Date: September 03, 2018

Medium (liquid type)	HSL 850
Frequency (MHz)	824.2000
Relative permittivity (real part)	41.01
Conductivity (S/m)	0.88
E-Field Probe	SN 45/15 EPG0281
Crest Factor	2.67
Conversion Factor	1.78
Sensor	4mm
Area Scan	dx=8mm dy=8mm
Zoom Scan	5x5x7, dx=8mm dy=8mm dz=5mm
Variation (%)	-3.910000
SAR 10g (W/Kg)	0.240044
SAR 1g (W/Kg)	0.362257
<b>SURFACE SAR</b>	<b>VOLUME SAR</b>

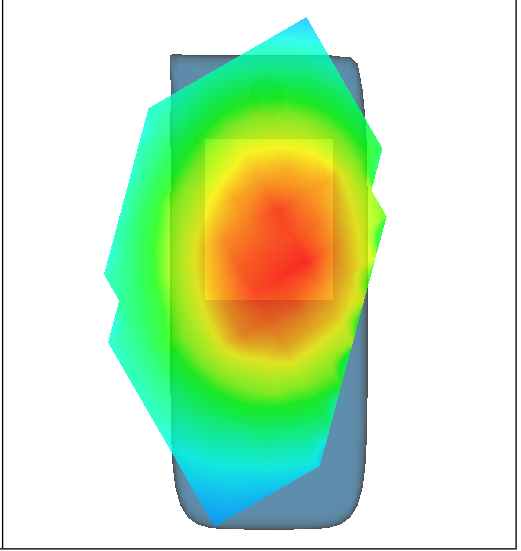
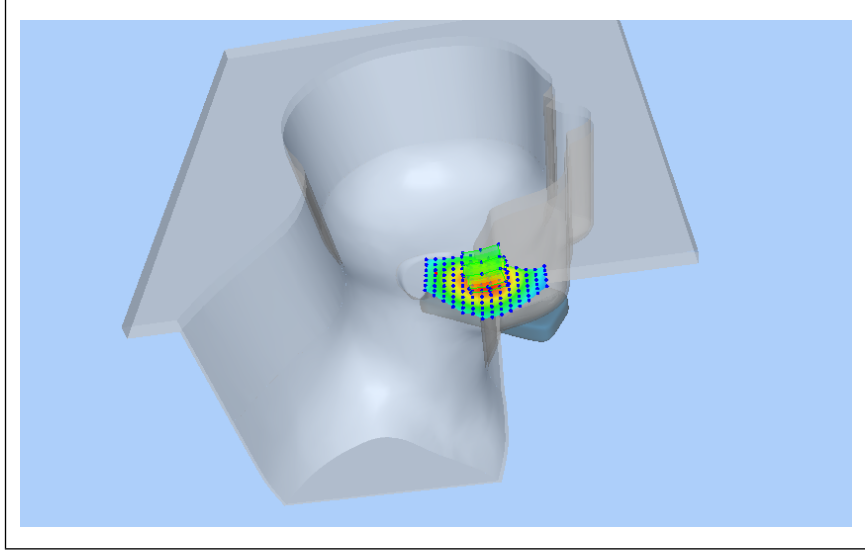
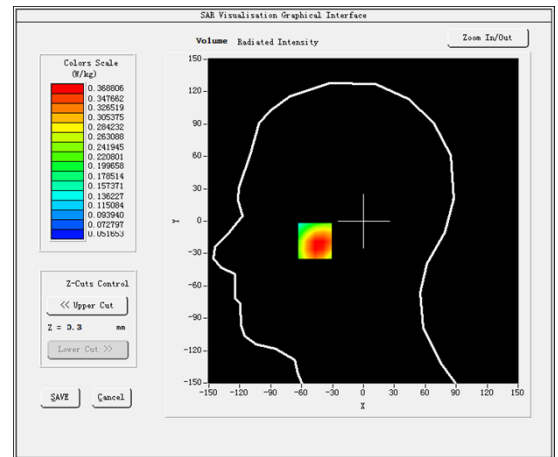
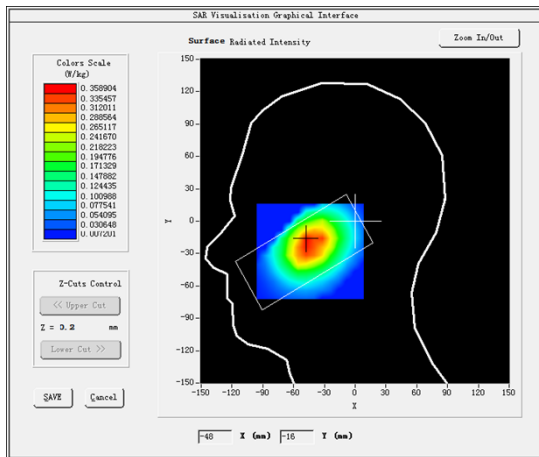

#2

Test Mode: GPPS850MHz, Low channel(Body Rear Side)  
 Product Description: Feature phone  
 Model: C3330  
 Test Date: September 13, 2018

Medium(liquid type)	MSL 850
Frequency (MHz)	824.2000
Relative permittivity (real part)	55.05
Conductivity (S/m)	0.98
E-Field Probe	SN 45/15 EPGO281
Crest Factor	2.67
Conversion Factor	1.85
Sensor	4mm
Area Scan	dx=8mm dy=8mm
Zoom Scan	5x5x7, dx=8mm dy=8mm dz=5mm
Variation (%)	0.660000
SAR 10g (W/Kg)	0.568584
SAR 1g (W/Kg)	0.862412
SURFACE SAR	VOLUME SAR

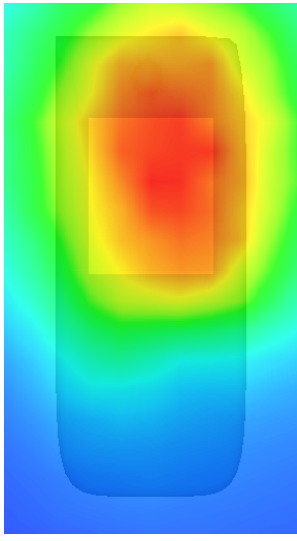
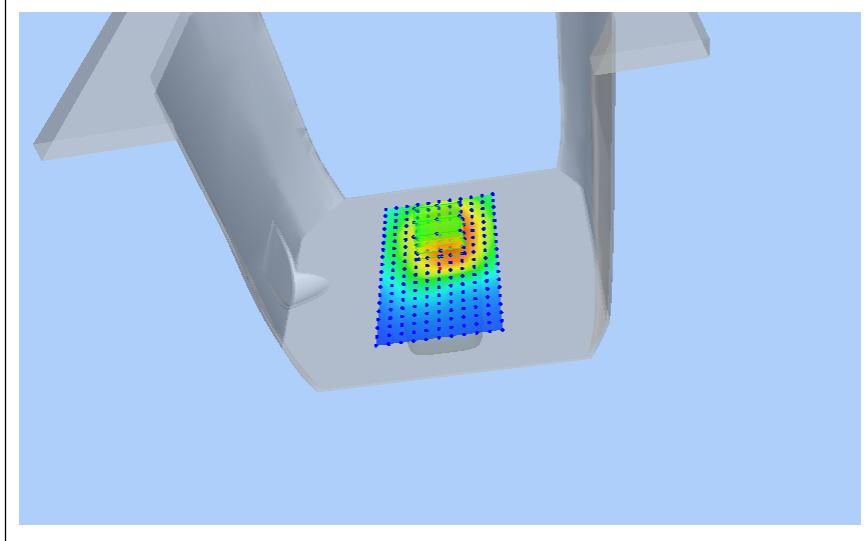
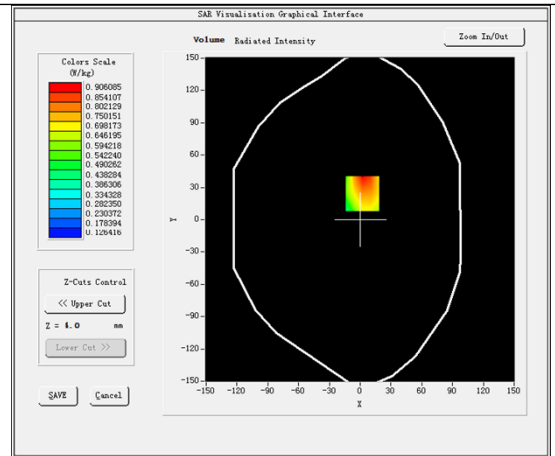
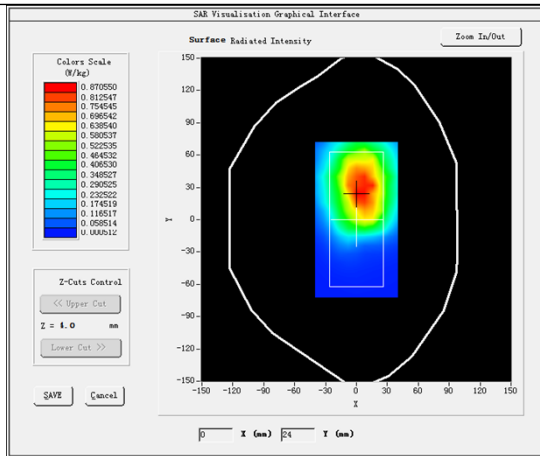

#3

Test Mode:GSM 1900MHz,Low channel(Head Left Cheek)  
 Product Description:Feature phone  
 Model:C3330  
 Test Date:September 12, 2018

Medium(liquid type)	HSL 1900
Frequency (MHz)	1850.2000
Relative permittivity (real part)	40.52
Conductivity (S/m)	1.41
E-Field Probe	SN 45/15 EPGO281
Crest Factor	2.67
Conversion Factor	1.83
Sensor	4mm
Area Scan	dx=8mm dy=8mm
Zoom Scan	5x5x7,dx=8mm dy=8mm dz=5mm
Variation (%)	-3.240000
SAR 10g (W/Kg)	0.414492
SAR 1g (W/Kg)	0.664550
<b>SURFACE SAR</b>	<b>VOLUME SAR</b>

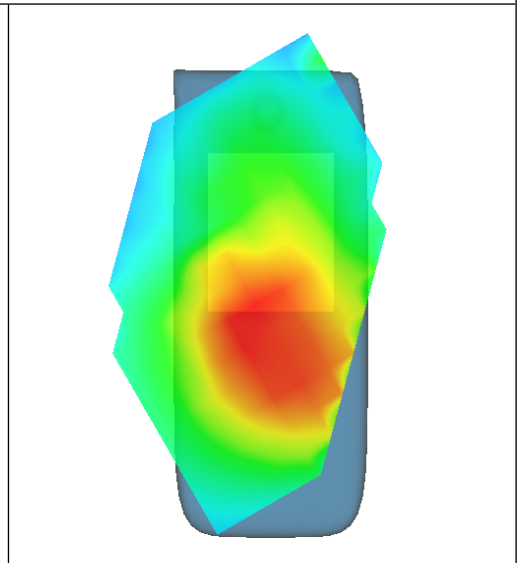
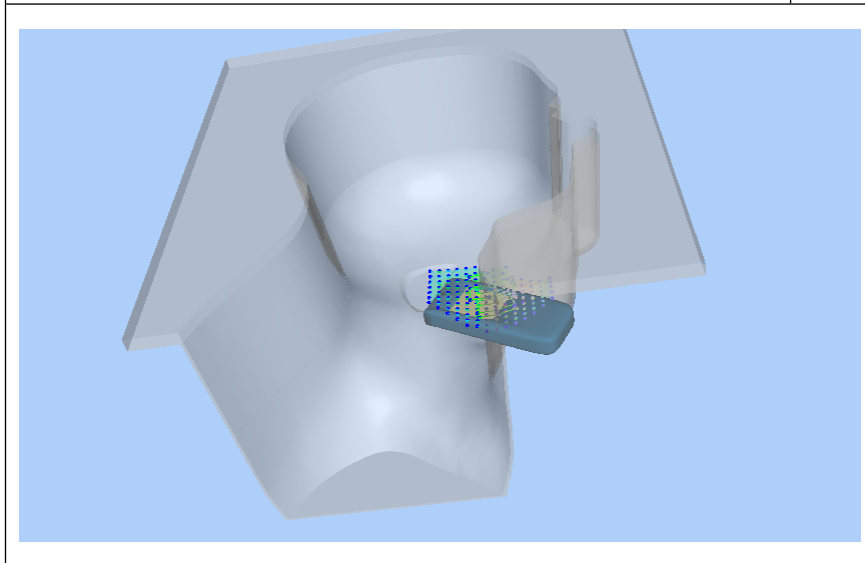
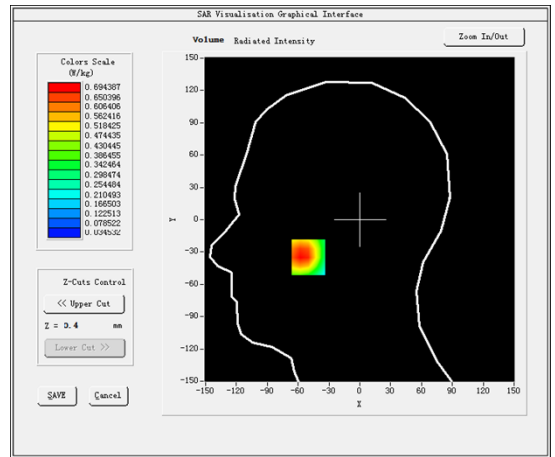
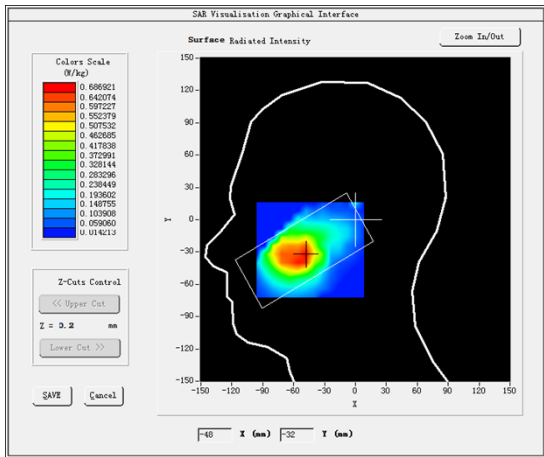

#4

Test Mode: GPRS1900MHz,High channel(Body Rear Side)

Product Description:Feature phone

Model:C3330

Test Date:September 21, 2018

Medium(liquid type)	MSL_1900
Frequency (MHz)	1909.8000
Relative permittivity (real part)	54.33
Conductivity (S/m)	1.56
E-Field Probe	SN45/15 EPGO281
Crest Factor	2.67
Conversion Factor	1.87
Sensor	4mm
Area Scan	dx=8mm dy=8mm
Zoom Scan	5x5x7,dx=8mm dy=8mm dz=5mm
Variation (%)	-2.420000
SAR 10g (W/Kg)	0.488340
SAR 1g (W/Kg)	0.961207

**SURFACE SAR**

**VOLUME SAR**

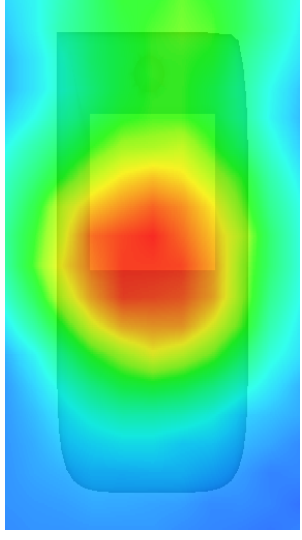
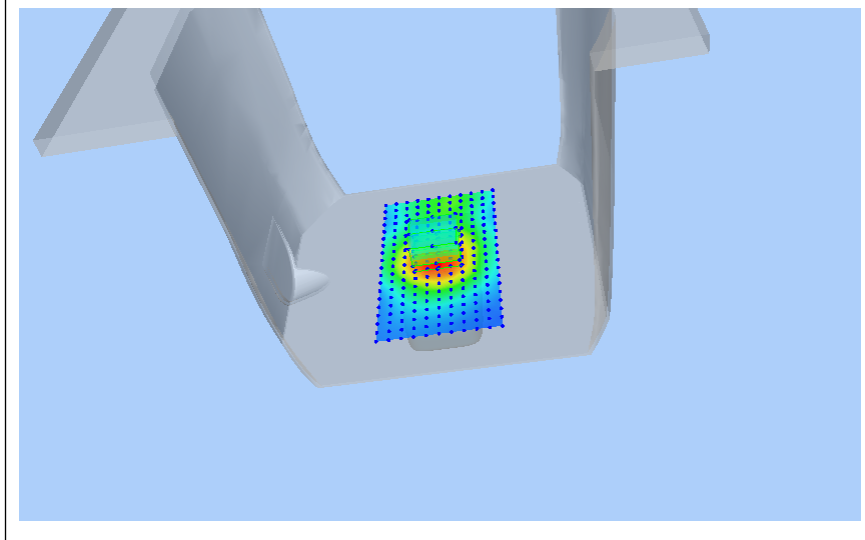
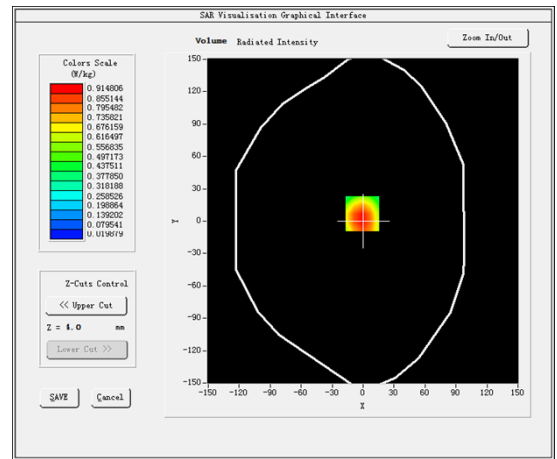
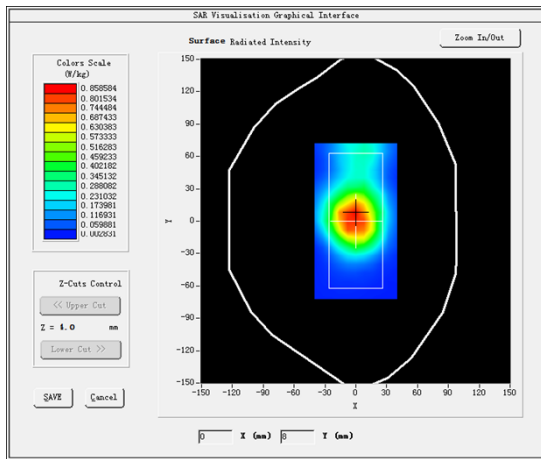

## 5. CALIBRATION CERTIFICATES

### 5.1 Probe-EPGO281 Calibration Certificate



## COMOSAR E-Field Probe Calibration Report

Ref : ACR.348.1.15.SATU.A

**SHENZHEN LCS COMPLIANCE TESTING  
LABORATORY LTD.**  
1F., XINGYUAN INDUSTRIAL PARK, TONGDA ROAD,  
BAO'AN BLVD  
BAO'AN DISTRICT, SHENZHEN, GUANGDONG, CHINA  
MVG COMOSAR DOSIMETRIC E-FIELD PROBE  
SERIAL NO.: SN 45/15 EPGO281

Calibrated at MVG US  
2105 Barrett Park Dr. - Kennesaw, GA 30144



Calibration Date: 02/04/2018

*Summary:*

This document presents the method and results from an accredited COMOSAR Dosimetric E-Field Probe calibration performed in MVG USA using the CALISAR / CALIBAIR test bench, for use with a COMOSAR system only. All calibration results are traceable to national metrology institutions.





COMOSAR E-FIELD PROBE CALIBRATION REPORT

Ref: ACR.348.1.15.SATU.A

	<i>Name</i>	<i>Function</i>	<i>Date</i>	<i>Signature</i>
<i>Prepared by :</i>	Jérôme LUC	Product Manager	02/08/2018	<i>JL</i>
<i>Checked by :</i>	Jérôme LUC	Product Manager	02/08/2018	<i>JL</i>
<i>Approved by :</i>	Kim RUTKOWSKI	Quality Manager	02/08/2018	<i>Kim Rutkowski</i>

	<i>Customer Name</i>
<i>Distribution :</i>	Shenzhen LCS Compliance Testing Laboratory Ltd.

<i>Issue</i>	<i>Date</i>	<i>Modifications</i>
A	02/08/2018	Initial release

*This document shall not be reproduced, except in full or in part, without the written approval of MVG.  
The information contained herein is to be used only for the purpose for which it is submitted and is not to be released in whole or part without written approval of MVG.*



## COMOSAR E-FIELD PROBE CALIBRATION REPORT

Ref: ACR.348.1.15.SATU.A

## TABLE OF CONTENTS

1	Device Under Test .....	4
2	Product Description .....	4
2.1	General Information .....	4
3	Measurement Method .....	4
3.1	Linearity .....	4
3.2	Sensitivity .....	5
3.3	Lower Detection Limit .....	5
3.4	Isotropy .....	5
3.5	Boundary Effect .....	5
4	Measurement Uncertainty .....	5
5	Calibration Measurement Results .....	6
5.1	Sensitivity in air .....	6
5.2	Linearity .....	7
5.3	Sensitivity in liquid .....	7
5.4	Isotropy .....	8
6	List of Equipment .....	10

Page: 3/10

*This document shall not be reproduced, except in full or in part, without the written approval of MVG.  
The information contained herein is to be used only for the purpose for which it is submitted and is not to  
be released in whole or part without written approval of MVG.*



## COMOSAR E-FIELD PROBE CALIBRATION REPORT

Ref: ACR\_348.1.15.SATU.A

## 1 DEVICE UNDER TEST

Device Under Test	
Device Type	COMOSAR DOSIMETRIC E FIELD PROBE
Manufacturer	MVG
Model	SSE2
Serial Number	SN 45/15 EPGO281
Product Condition (new / used)	New
Frequency Range of Probe	0.45 GHz-6GHz
Resistance of Three Dipoles at Connector	Dipole 1: R1=0.186 MΩ Dipole 2: R2=0.194 MΩ Dipole 3: R3=0.191 MΩ

A yearly calibration interval is recommended.

## 2 PRODUCT DESCRIPTION

### 2.1 GENERAL INFORMATION

MVG's COMOSAR E field Probes are built in accordance to the IEEE 1528, OET 65 Bulletin C and CEI/IEC 62209 standards.



Figure 1 – MVG COMOSAR Dosimetric E field Dipole

Probe Length	330 mm
Length of Individual Dipoles	2 mm
Maximum external diameter	8 mm
Probe Tip External Diameter	2.5 mm
Distance between dipoles / probe extremity	1 mm

## 3 MEASUREMENT METHOD

The IEEE 1528, OET 65 Bulletin C, CENELEC EN50361 and CEI/IEC 62209 standards provide recommended practices for the probe calibrations, including the performance characteristics of interest and methods by which to assess their affect. All calibrations / measurements performed meet the fore mentioned standards.

### 3.1 LINEARITY

The evaluation of the linearity was done in free space using the waveguide, performing a power sweep to cover the SAR range 0.01W/kg to 100W/kg.

Page: 4/10

*This document shall not be reproduced, except in full or in part, without the written approval of MVG.  
The information contained herein is to be used only for the purpose for which it is submitted and is not to be released in whole or part without written approval of MVG.*



## COMOSAR E-FIELD PROBE CALIBRATION REPORT

Ref: ACR.348.1.15.SATU.A

### 3.2 SENSITIVITY

The sensitivity factors of the three dipoles were determined using a two step calibration method (air and tissue simulating liquid) using waveguides as outlined in the standards.

### 3.3 LOWER DETECTION LIMIT

The lower detection limit was assessed using the same measurement set up as used for the linearity measurement. The required lower detection limit is 10 mW/kg.

### 3.4 ISOTROPY

The axial isotropy was evaluated by exposing the probe to a reference wave from a standard dipole with the dipole mounted under the flat phantom in the test configuration suggested for system validations and checks. The probe was rotated along its main axis from 0 - 360 degrees in 15 degree steps. The hemispherical isotropy is determined by inserting the probe in a thin plastic box filled with tissue-equivalent liquid, with the plastic box illuminated with the fields from a half wave dipole. The dipole is rotated about its axis (0°–180°) in 15° increments. At each step the probe is rotated about its axis (0°–360°).

### 3.5 BOUNDARY EFFECT

The boundary effect is defined as the deviation between the SAR measured data and the expected exponential decay in the liquid when the probe is oriented normal to the interface. To evaluate this effect, the liquid filled flat phantom is exposed to fields from either a reference dipole or waveguide. With the probe normal to the phantom surface, the peak spatial average SAR is measured and compared to the analytical value at the surface.

## 4 MEASUREMENT UNCERTAINTY

The guidelines outlined in the IEEE 1528, OET 65 Bulletin C, CENELEC EN50361 and CEI/IEC 62209 standards were followed to generate the measurement uncertainty associated with an E-field probe calibration using the waveguide technique. All uncertainties listed below represent an expanded uncertainty expressed at approximately the 95% confidence level using a coverage factor of k=2, traceable to the Internationally Accepted Guides to Measurement Uncertainty.

Uncertainty analysis of the probe calibration in waveguide					
ERROR SOURCES	Uncertainty value (%)	Probability Distribution	Divisor	ci	Standard Uncertainty (%)
Incident or forward power	3.00%	Rectangular	$\sqrt{3}$	1	1.732%
Reflected power	3.00%	Rectangular	$\sqrt{3}$	1	1.732%
Liquid conductivity	5.00%	Rectangular	$\sqrt{3}$	1	2.887%
Liquid permittivity	4.00%	Rectangular	$\sqrt{3}$	1	2.309%
Field homogeneity	3.00%	Rectangular	$\sqrt{3}$	1	1.732%
Field probe positioning	5.00%	Rectangular	$\sqrt{3}$	1	2.887%

Page: 5/10

*This document shall not be reproduced, except in full or in part, without the written approval of MVG.  
The information contained herein is to be used only for the purpose for which it is submitted and is not to be released in whole or part without written approval of MVG.*



COMOSAR E-FIELD PROBE CALIBRATION REPORT

Ref: ACR.348.1.15.SATU.A

Field probe linearity	3.00%	Rectangular	$\sqrt{3}$	1	1.732%
<b>Combined standard uncertainty</b>					5.831%
<b>Expanded uncertainty</b> 95 % confidence level k = 2					12.0%

5 CALIBRATION MEASUREMENT RESULTS

Calibration Parameters	
Liquid Temperature	21 °C
Lab Temperature	21 °C
Lab Humidity	45 %

5.1 SENSITIVITY IN AIR

Normx dipole 1 ( $\mu\text{V}/(\text{V}/\text{m})^2$ )	Normy dipole 2 ( $\mu\text{V}/(\text{V}/\text{m})^2$ )	Normz dipole 3 ( $\mu\text{V}/(\text{V}/\text{m})^2$ )
0.77	0.83	0.67

DCP dipole 1 (mV)	DCP dipole 2 (mV)	DCP dipole 3 (mV)
91	90	95

Calibration curves  $e_i=f(V)$  ( $i=1,2,3$ ) allow to obtain H-field value using the formula:

$$E = \sqrt{E_1^2 + E_2^2 + E_3^2}$$

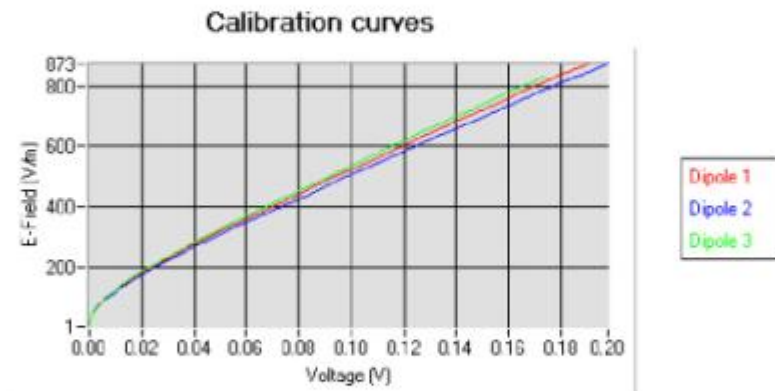

*This document shall not be reproduced, except in full or in part, without the written approval of MVG. The information contained herein is to be used only for the purpose for which it is submitted and is not to be released in whole or part without written approval of MVG.*



COMOSAR E-FIELD PROBE CALIBRATION REPORT

Ref: ACR.348.1.15.SATU.A

5.2 LINEARITY

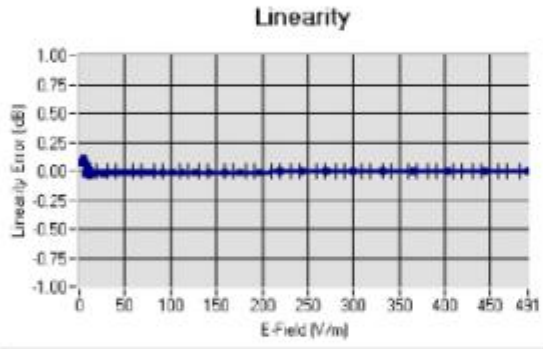

Linearity  $\pm 2.60\%$  ( $\pm 0.11$  dB)

5.3 SENSITIVITY IN LIQUID

Liquid	Frequency (MHz +/- 100MHz)	Permittivity	Epsilon (S/m)	ConvF
HL450	450	44.12	0.88	1.76
BL450	450	58.92	1.00	1.81
HL750	750	42.24	0.90	1.53
BL750	750	56.85	0.99	1.59
HL850	835	43.02	0.90	1.78
BL850	835	53.72	0.98	1.85
HL900	900	42.47	0.99	1.62
BL900	900	56.97	1.09	1.67
HL1800	1800	42.24	1.40	1.83
BL1800	1800	53.53	1.53	1.87
HL1900	1900	40.79	1.42	2.10
BL1900	1900	54.47	1.57	2.16
HL2000	2000	40.52	1.44	2.01
BL2000	2000	54.18	1.56	2.09
HL2450	2450	38.73	1.81	2.21
BL2450	2450	53.23	1.96	2.28
HL2600	2600	38.54	1.95	2.32
BL2600	2600	52.07	2.23	2.38
HL5200	5200	36.80	4.84	2.46
BL5200	5200	51.21	5.16	2.52
HL5400	5400	36.35	4.96	2.70
BL5400	5400	50.51	5.70	2.79
HL5600	5600	35.57	5.23	2.74
BL5600	5600	49.83	5.91	2.83
HL5800	5800	35.30	5.47	2.53
BL5800	5800	49.03	6.28	2.60

LOWER DETECTION LIMIT: 9mW/kg

*This document shall not be reproduced, except in full or in part, without the written approval of MVG. The information contained herein is to be used only for the purpose for which it is submitted and is not to be released in whole or part without written approval of MVG.*



COMOSAR E-FIELD PROBE CALIBRATION REPORT

Ref: ACR\_348.1.15.SATU.A

5.4 ISOTROPY

**HL900 MHz**

- Axial isotropy: 0.04 dB
- Hemispherical isotropy: 0.06 dB

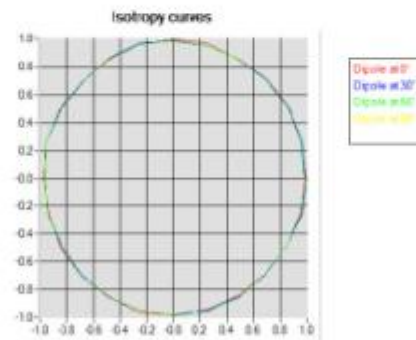

**HL1800 MHz**

- Axial isotropy: 0.04 dB
- Hemispherical isotropy: 0.08 dB

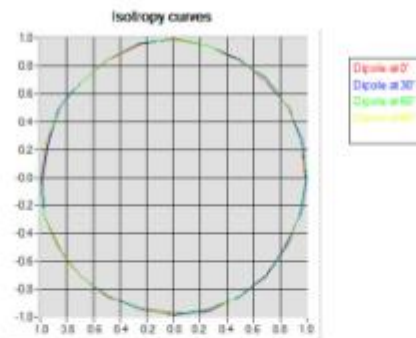

*This document shall not be reproduced, except in full or in part, without the written approval of MVG. The information contained herein is to be used only for the purpose for which it is submitted and is not to be released in whole or part without written approval of MVG.*



COMOSAR E-FIELD PROBE CALIBRATION REPORT

Ref: ACR-348.1.15.SATU.A

**HL5600 MHz**

- Axial isotropy: 0.06 dB
- Hemispherical isotropy: 0.08 dB

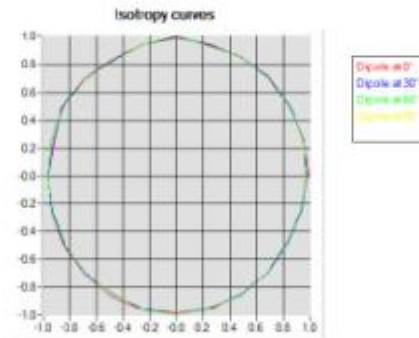

*This document shall not be reproduced, except in full or in part, without the written approval of MVG.  
The information contained herein is to be used only for the purpose for which it is submitted and is not to be released in whole or part without written approval of MVG.*





## COMOSAR E-FIELD PROBE CALIBRATION REPORT

Ref: ACR-348.1.15.SATU.A

## 6 LIST OF EQUIPMENT

Equipment Summary Sheet				
Equipment Description	Manufacturer / Model	Identification No.	Current Calibration Date	Next Calibration Date
Flat Phantom	MVG	SN-20/09-SAM71	Validated. No cal required.	Validated. No cal required.
COMOSAR Test Bench	Version 3	NA	Validated. No cal required.	Validated. No cal required.
Network Analyzer	Rhode & Schwarz ZVA	SN100132	02/2018	02/2021
Reference Probe	MVG	EP 94 SN 37/08	10/2017	10/2018
Multimeter	Keithley 2000	1188656	12/2015	12/2018
Signal Generator	Agilent E4438C	MY49070581	12/2015	12/2018
Amplifier	Aethercomm	SN 046	Characterized prior to test. No cal required.	Characterized prior to test. No cal required.
Power Meter	HP E4418A	US38261498	12/2015	12/2018
Power Sensor	HP ECP-E26A	US37181460	12/2015	12/2018
Directional Coupler	Narda 4216-20	01386	Characterized prior to test. No cal required.	Characterized prior to test. No cal required.
Waveguide	Mega Industries	069Y7-158-13-712	Validated. No cal required.	Validated. No cal required.
Waveguide Transition	Mega Industries	069Y7-158-13-701	Validated. No cal required.	Validated. No cal required.
Waveguide Termination	Mega Industries	069Y7-158-13-701	Validated. No cal required.	Validated. No cal required.
Temperature / Humidity Sensor	Control Company	150798832	10/2016	10/2018

Page: 10/10

*This document shall not be reproduced, except in full or in part, without the written approval of MVG.  
The information contained herein is to be used only for the purpose for which it is submitted and is not to be released in whole or part without written approval of MVG.*