



SGS-CSTC Standards
Technical Services (Shanghai)Co., Ltd.

KD-972 Internal Photos

Applicant: ANDON HEALTH Co., Ltd
Address of Applicant: No. 3 Jin Ping Street, Ya An Road, Nankai District, Tianjin 300190, China
Equipment Under Test (EUT):
EUT Name: Wireless blood pressure wrist monitor
Model No: KD-972(BP7)
Brand Name: iHealth



1 Contents

	Page
1 CONTENTS.....	2
2 INTERNAL PHOTOS	3

2 Internal Photos

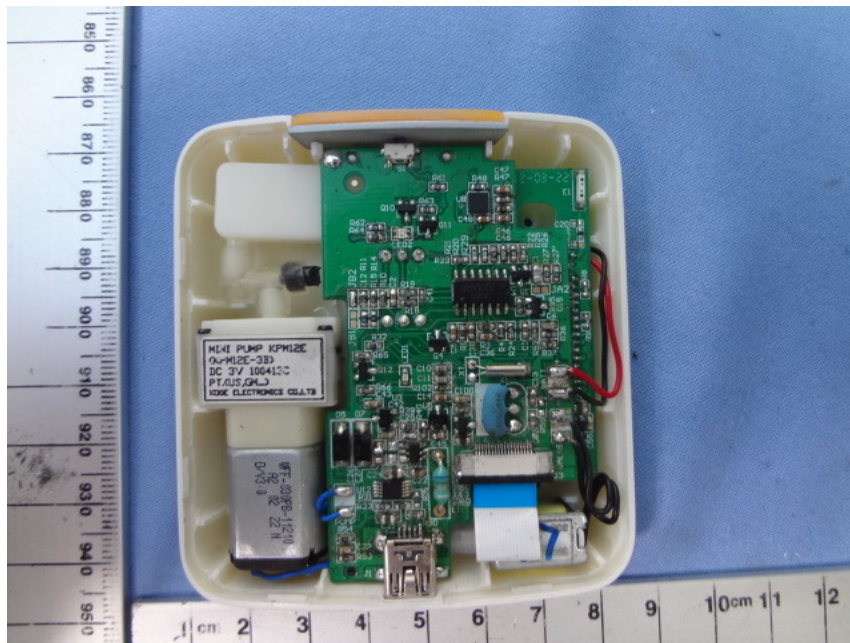

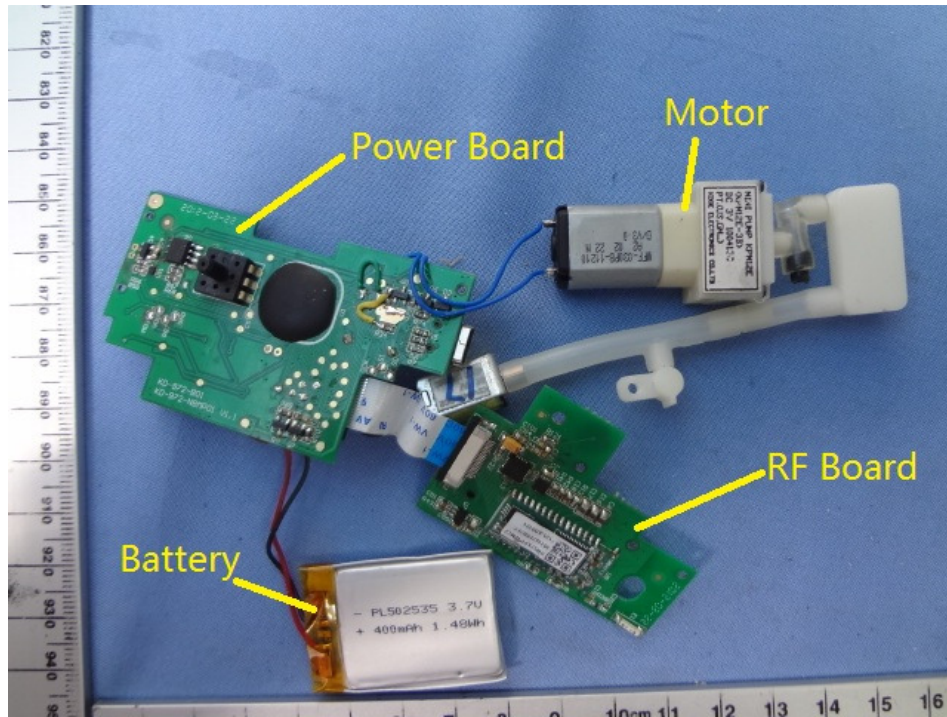

General View

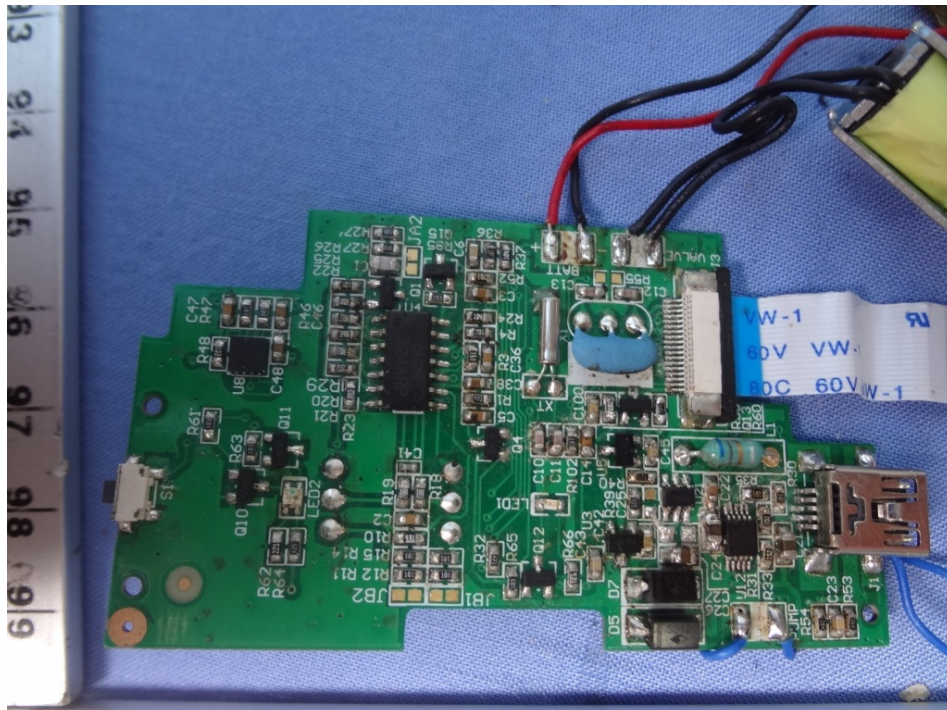

Power Board Front View

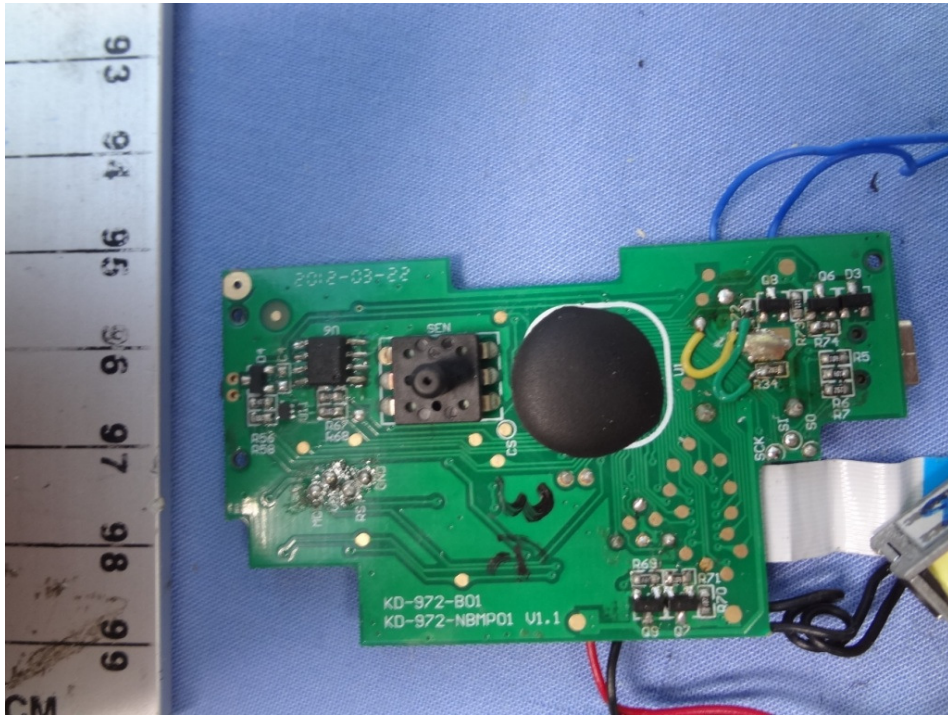

Power Board Rear View

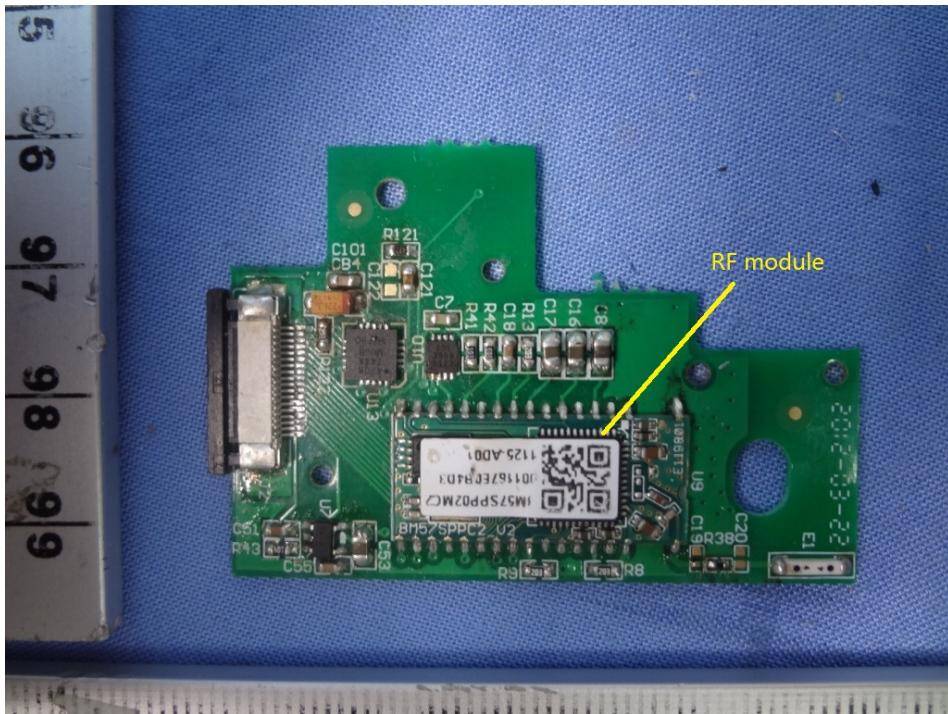

RF Board Front View

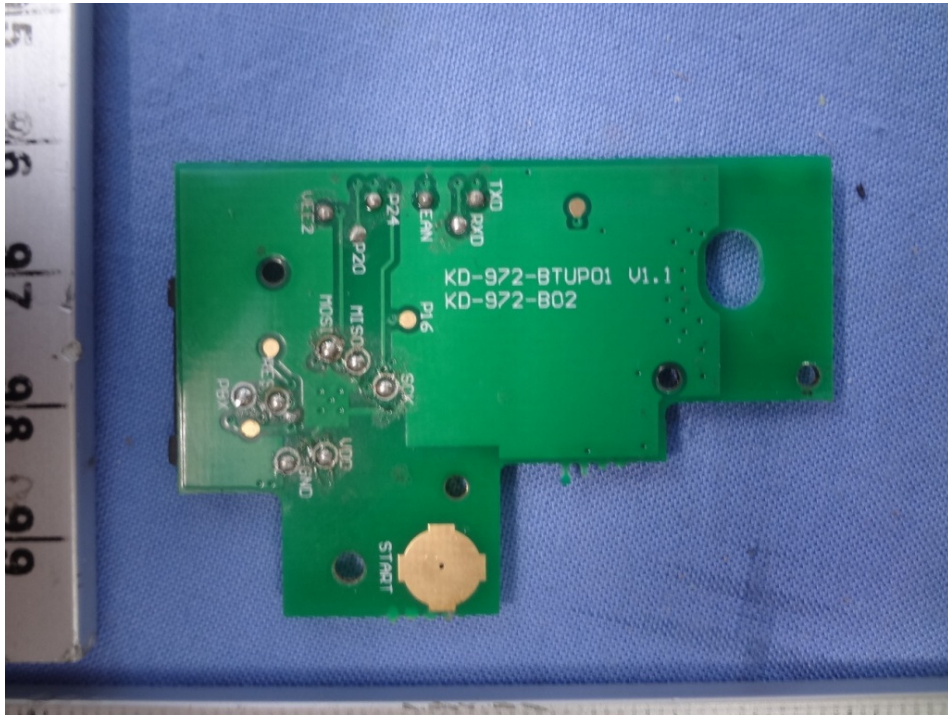

RF Board Rear View

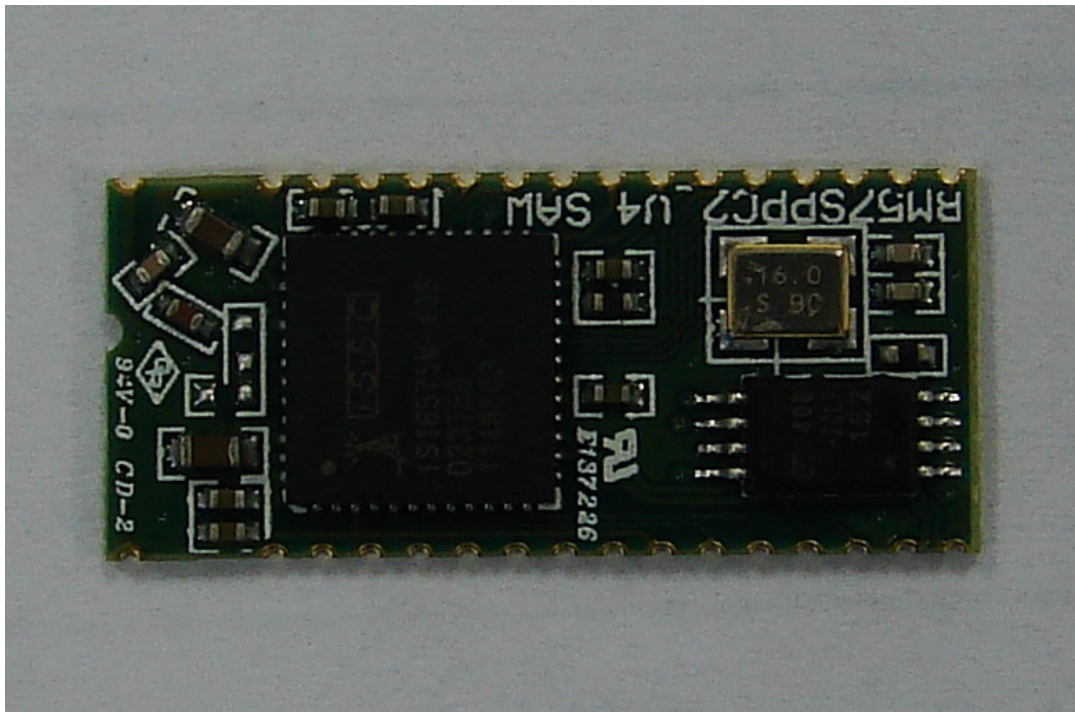

RF Module Front View

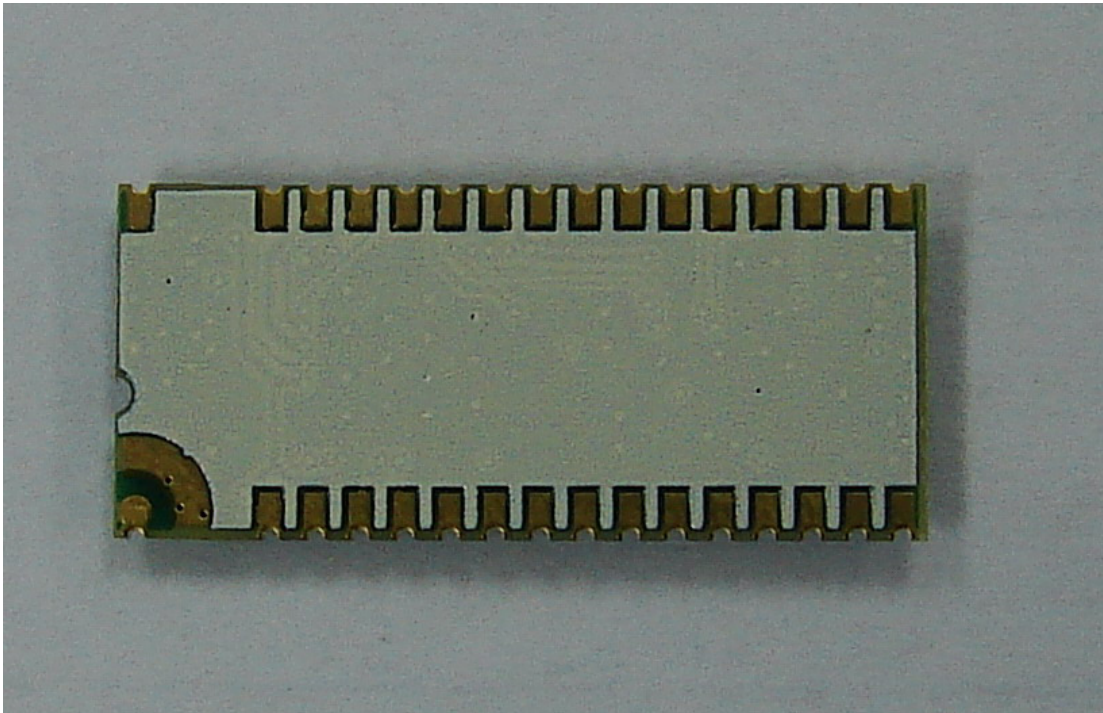

RF Module Rear View

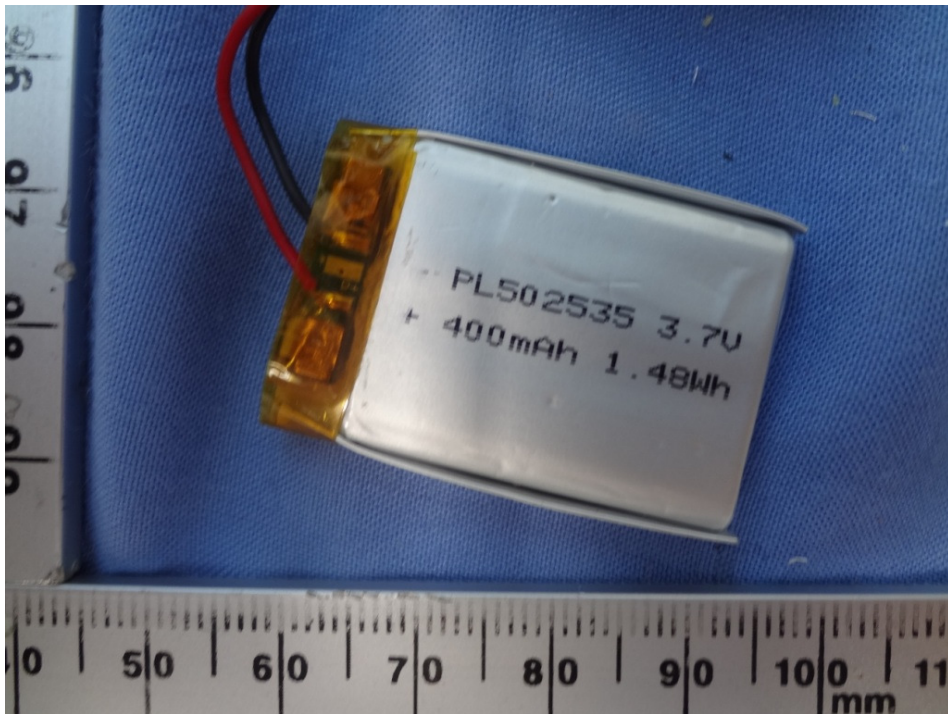

Battery Front

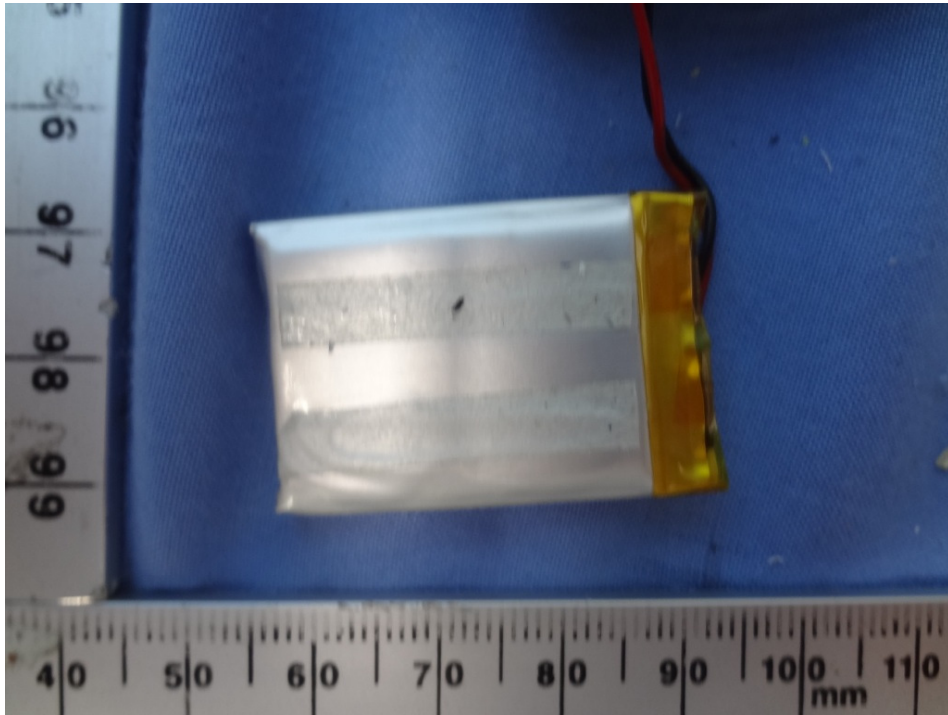

Battery Rear View



Motor Front View

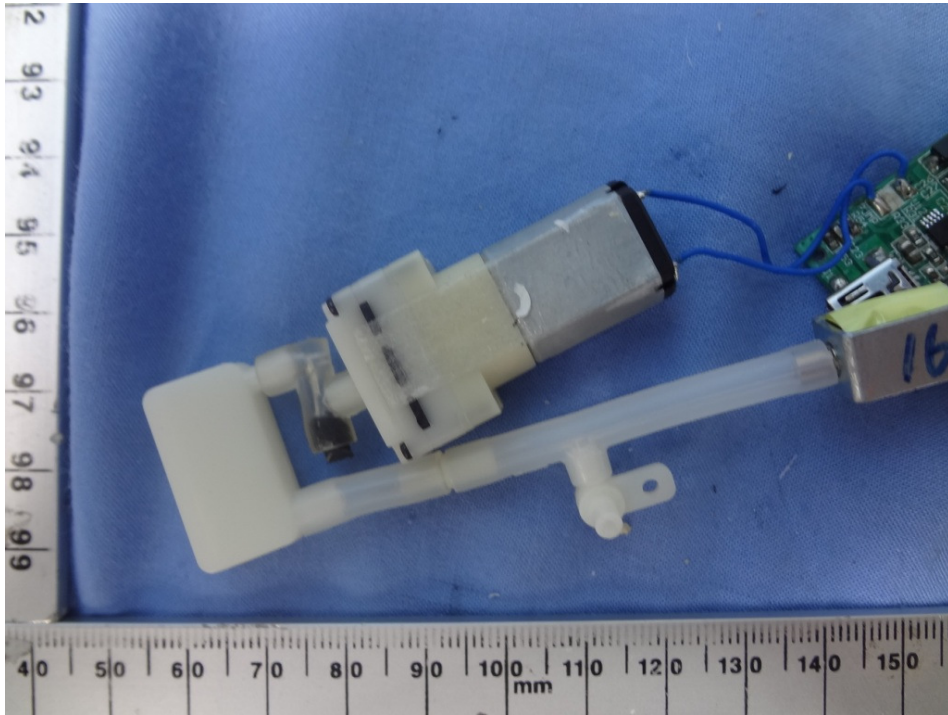

Battery Rear View

End