

FCC Test Report

Part 15 subpart C

Client Information:

Applicant : Shenzhen Adition Audio Science & Technology CO., LTD.
Applicant add.: Mingzhuo Industry Park, Guangming Main Street, Guangming New District, Shenzhen, China

EUT Information:

EUT Name : smart activity & sleep tracker
Model No. : IR125B
Brand Name : Keefit / Keenetic / Adition
FCC ID : ZRR-IR125B

Prepared By:

Dongguan Yaxu(AiT) Technology Limited

Add. : No. 22, JinQianLing Street 3, JiTiGang Village HuangJiang Town, DongGuan, GuangDong, China.

Date of Receipt: Jun. 01, 2015

Date of Test: Jun. 01~06, 2015

Date of Issue: Jun. 16, 2015

Test Result: **Pass**

Test procedure used: ANSI C63.4-2009

This device described above has been tested by Dongguan Yaxu(AiT) Technology Limited, and the test results show that the equipment under test (EUT) is in compliance with the FCC requirements. And it is applicable only to the tested sample identified in the report.

*This test report must not be used by the client to claim product endorsement by any agency of the U.S. government.

Reviewed by:



Seal.Chen

Approved by:



Jackie.Deng

1 Contents

	Page
COVER PAGE	
1 CONTENTS	2
2 TEST SUMMARY	4
2.1 COMPLIANCE WITH FCC PART 15 SUBPART C	4
2.2 MEASUREMENT UNCERTAINTY	5
3 TEST FACILITY	6
3.1 DEVIATION FROM STANDARD	6
3.2 ABNORMALITIES FROM STANDARD CONDITIONS	6
4 GENERAL INFORMATION	7
4.1 GENERAL DESCRIPTION OF EUT	7
4.2 DESCRIPTION OF TEST CONDITIONS	9
4.3 EUT PERIPHERAL LIST	10
4.4 TEST PERIPHERAL LIST	10
5 EQUIPMENTS LIST FOR ALL TEST ITEMS	11
6 TEST RESULT	12
6.1 ANTENNA REQUIREMENT	12
6.1.1 Standard requirement.....	12
6.1.2 EUT Antenna.....	12
6.2 CONDUCTION EMISSIONS MEASUREMENT.....	13
6.2.1 Applied procedures / Limit.....	13
6.2.2 Test procedure	13
6.2.3 Test setup.....	13
6.2.4 Test results.....	14
6.3 RADIATED EMISSIONS MEASUREMENT.....	16
6.3.1 Applied procedures / Limit.....	16
6.3.2 Test setup.....	16
6.3.3 Test procedure	18
6.3.4 Test Result	19
6.3.5 TEST RESULTS (Restricted Bands Requirements).....	24
6.4 BANDWIDTH TEST	25
6.4.1 Applied procedures / Limit.....	25
6.4.2 Test procedure	25
6.4.3 Deviation from standard	25
6.4.4 Test setup.....	25
6.4.5 Test results.....	26
6.5 PEAK POWER DENSITY.....	29
6.5.1 Applied procedures / Limit.....	29



6.5.2	Test procedure	29
6.5.3	Deviation from standard	29
6.5.4	Test results	30
6.6	MAXIMUM PEAK OUTPUT POWER	33
6.6.1	Applied procedures / Limit.....	33
6.6.2	Test procedure	33
6.6.3	Deviation from standard	33
6.6.4	Test setup.....	33
6.6.5	Test results	34
6.7	BAND EDGE.....	37
6.7.1	Applied procedures / Limit.....	37
6.7.2	Test procedure	37
6.7.3	Deviation from standard	37
6.7.4	Test setup.....	37
6.7.5	Test results	38
6.8	CONDUCTED SPURIOUS EMISSIONS	39
6.8.1	Applied procedures / Limit.....	39
6.8.2	Test procedure	39
6.8.3	Deviation from standard	39
6.8.4	Test setup.....	39
6.8.5	Test results	40

2 Test Summary

2.1 Compliance with FCC Part 15 subpart C

Test	Test Requirement	Standard Paragraph	Result
Antenna Requirement	FCC Part 15 C:2013	Section 15.247(c)	PASS
Conduction Emissions	FCC Part 15 C:2013	Section 15.207(a)	PASS
Radiated Emissions	FCC Part 15 C:2013	Section 15.247(d)	PASS
Occupied Bandwidth	FCC Part 15 C:2013	Section 15.247(a)(2)	PASS
Peak power density	FCC Part 15 C:2013	Section 15.247(e)	PASS
Maximum Peak Output Power	FCC Part 15 C:2013	Section 15.247(b)(1)	PASS
Band edge	FCC Part 15 C:2013	Section 15.247(d)	PASS
Conducted Spurious Emissions	FCC Part 15 C:2013	Section 15.247(d)	PASS
Note: Reference to the KDB 558074 D01 DTS Meas Guidance v03r03			

2.2 Measurement Uncertainty

All measurements involve certain levels of uncertainties, The following measurements uncertainty Levels have estimated based on ANSI C63.4:2009, the maximum value of the uncertainty as below

No.	Item	Uncertainty
1	Conducted Emission Test	1.20dB
2	Radiated Emission Test	3.30dB

3 Test Facility

The test facility is recognized, certified or accredited by the following organizations:

.CNAS- Registration No: L6177

Dongguan Yaxu (AiT) technology Limited is accredited to ISO/IEC 17025:2005 general Requirements for the competence of testing and calibration laboratories (CNAS-CL01 Accreditation Criteria for the competence of testing and calibration laboratories) on Apr. 18, 2013

.FCC- Registration No: 248337

The 3m Semi-Anechoic Chamber, 3m/10m Open Area Test Site and Shielding Room of Dong Guan Yaxu (Ait) Technology Limited have been registered by Federal Communications Commission (FCC) on Aug.29, 2014.

.Industry Canada(IC)-Registration No: IC6819A-1 & IC6819A-2

The 3m Semi-Anechoic Chamber and 3m/10m Open Area Test Site of Dong Guan Yaxu (Ait) Technology Limited have been registered by Certification and Engineering Bureau of Industry Canada for radio equipment testing on Oct. 12, 2014.

.VCCI- Registration No: 2705

The 3m/10m Open Area Test Site, Shielding Room and 3m Chamber of Dong Guan Yaxu (Ait) Technology Limited have been registered by Voluntary Control Council for Interference on Nov. 21, 2012. The Telecommunication Ports Conducted Disturbance Measurement of Dong Guan Yaxu (Ait) Technology Limited have been registered by Voluntary Control Council for Interference on May. 13, 2013.

.TUV NORD

Dong Guan Yaxu (Ait) Technology Limited has been assessed on Jun. 13, 2013 that it can carry out EMC tests by order and under supervision of TUV NORD.

.ITS- Registration No: TMPSHA031

Dong Guan Yaxu (Ait) Technology Limited has been assessed and included in Intertek Shanghai TMP Program regarding Laboratory facilities and test equipment on Jul.22, 2012.

3.1 Deviation from standard

None

3.2 Abnormalities from standard conditions

None

4 General Information

4.1 General Description of EUT

Manufacturer:	Shenzhen Adition Audio Science & Technology CO., LTD.
Manufacturer Address:	Mingzhuo Industry Park, Guangming Main Street, Guangming New District , Shenzhen, China
EUT Name:	smart activity & sleep tracker
Model No:	IR125B
Operation frequency:	2402 MHz to 2480 MHz
NUMBER OF CHANNEL:	40
Modulation Technology:	GFSK(1Mbps)
Bluetooth version:	BT4.0 low energy mode
Antenna Type:	PCB layout
Antenna Gain:	max 1.0dBi
H/W No.:	REV:00
S/W No.:	GNC_20150313_v1.2.8
Brand Name:	Keefit /Keenetic/Adition
Serial No:	N/A(prototype)
Power Supply Range:	DC 5.0V from adapter or DC 3.7V from battery
Power Supply:	DC 5.0V from adapter or DC 3.7V from battery
Power Cord:	USB cable 30cm / unshielded
Output power (max) :	-4.66dBm
Model description:	None
Note:	
	1. For a more detailed features description, please refer to the manufacturer's specifications or the User's Manual.
	2. This device is charged via USB cable, can not transmit data.

Description of Channel:			
Channel	Frequency (MHz)	Channel	Frequency (MHz)
00	2402	20	2442
01	2404	21	2444
02	2406	22	2446
03	2408	23	2448
04	2410	24	2450
05	2412	25	2452
06	2414	26	2454
07	2416	27	2456
08	2418	28	2458
09	2420	29	2460
10	2422	30	2462
11	2424	31	2464
12	2426	32	2466
13	2428	33	2468
14	2430	34	2470
15	2432	35	2472
16	2434	36	2474
17	2436	37	2476
18	2438	38	2478
19	2440	39	2480

4.2 Description of Test conditions

(1) EUT was tested in normal configuration (Please See following Block diagram)

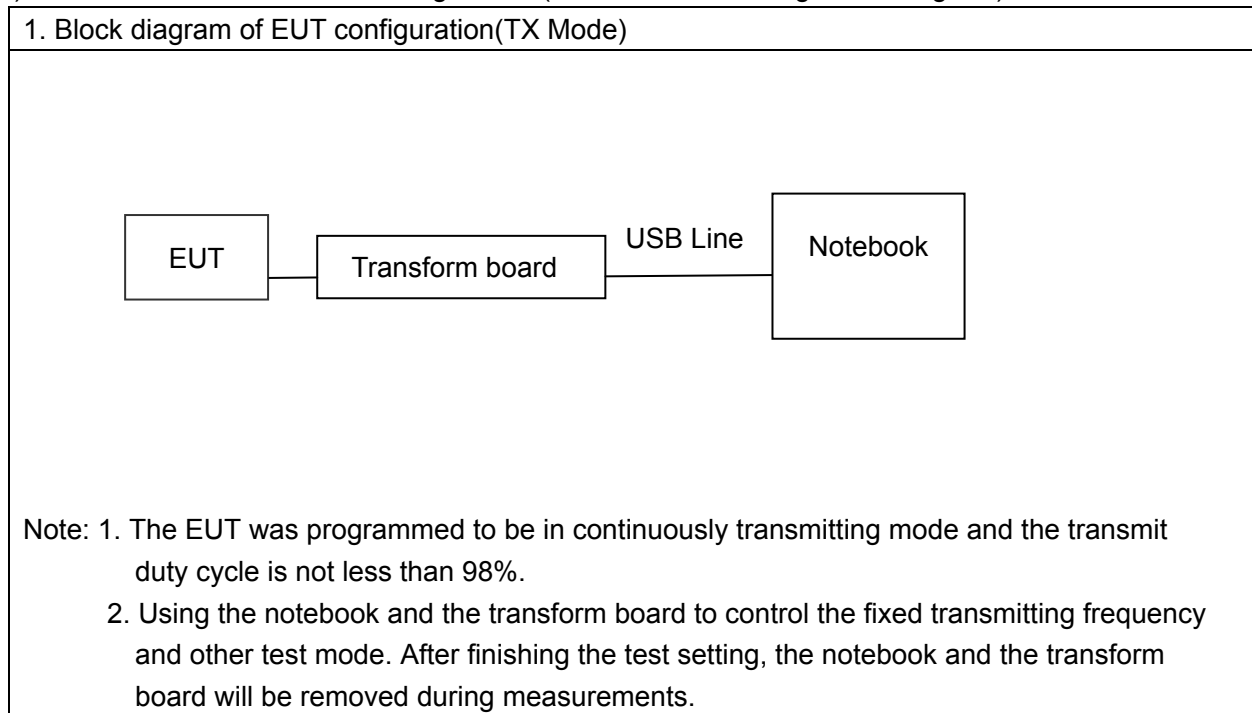

(2) E.U.T. test conditions:

15.31(e): For intentional radiators, measurements of the variation of the input power or the adiated signal level of the fundamental frequency component of the emission, as appropriate, shall be performed with the supply voltage varied between 85% and 115% of the nominal rated supply voltage. For battery operated equipment, the equipment tests shall be performed using a new battery.

(3) Test frequencies:

According to the 15.31(m) Measurements on intentional radiators or receivers, other than TV broadcast receivers, shall be performed and. If required reported for each band in which the device can be operated with the device operating at the number of frequencies in each band specified in the following table:

Frequency range over which device operates	Number of frequencies	Location in the range of operation
1 MHz or less	1	Middle
1 to 10 MHz	2	1 near top and 1 near bottom
More than 10 MHz	3	1 near top, 1 near middle and 1 near bottom

(4) Frequency range of radiated measurements:

According to the 15.33, the test range will be up to the tenth harmonic of the highest fundamental frequency.

4.3 EUT Peripheral List

No.	Equipment	Manufacturer	Model No.	Serial No.	Power cord	signal cable
1	USB line	N/A	N/A	N/A	0.3m/shielded /undetachable	N/A

4.4 Test Peripheral List

No.	Equipment	Manufacturer	EMC Compliance	Model No.	Serial No.	Power cord	Remark
1	Adapter	Salcomp	FCC	SC0602B TA	121700004658	N/A	Provided by AiT

5 Equipments List for All Test Items

No	Test Equipment	Manufacturer	Model No	Serial No	Cal. Date	Cal. Due Date
1	Spectrum Analyzer	ADVANTEST	R3182	150900201	2014.06.27	2015.06.26
2	EMI Measuring Receiver	R&S	ESR	101660	2014.12.01	2015.11.30
3	Low Noise Pre Amplifier	Tsj	MLA-10K01-B01-27	1205323	2014.06.27	2015.06.26
4	Low Noise Pre Amplifier	Tsj	MLA-0120-A02-34	2648A04738	2014.12.02	2015.12.01
5	TRILOG Super Broadband test Antenna	SCHWARZBECK	VULB9160	9160-3206	2014.12.03	2015.12.02
6	Broadband Horn Antenna	SCHWARZBECK	BBHA9120D	452	2014.12.03	2015.12.02
7	SHF-EHF Horn	SCHWARZBECK	BBHA9170	BBHA9170367	2014.12.03	2015.12.02
8	50Ω Coaxial Switch	Anritsu	MP59B	6200264416	2014.09.26	2015.09.25
9	EMI Test Receiver	R&S	ESCI	100124	2014.06.20	2015.06.19
10	LISN	Kyoritsu	KNW-242	8-837-4	2014.06.20	2015.06.19
11	LISN	Kyoritsu	KNW-407	8-1789-3	2014.06.20	2015.06.19
12	50Ω Coaxial Switch	Anritsu	MP59B	6200264417	2014.09.25	2015.09.24
13	Loop Antenna	ARA	PLA-1030/B	1029	2015.03.19	2016.03.18
14	Radiated Cable 1# (30MHz-1GHz)	FUJIKURA	5D-2W	01	2015.01.04	2016.01.03
15	Radiated Cable 2# (1GHz -25GHz)	FUJIKURA	10D2W	02	2014.12.25	2015.12.24
16	Conducted Cable 1#(9KHz-30MHz)	FUJIKURA	1D-2W	01	2015.01.04	2016.01.03
17	SMA Antenna connector	Dosin	Dosin-SMA	N/A	N/A	N/A

Note: The temporary antenna connector is soldered on the PCB board in order to perform conducted tests and this temporary antenna connector is listed in the equipment list.

6 Test Result

6.1 Antenna Requirement

6.1.1 Standard requirement

15.203 requirement: For intentional device, according to 15.203: an intentional radiator shall be designed to ensure that no antenna other than that furnished by the responsible party shall be used with the device.

15.247(c) (1)(i) requirement: (i) Systems operating in the 2400-2483.5 MHz band that is used exclusively for fixed. Point-to-point operations may employ transmitting antennas with directional gain greater than 6dBi provided the maximum conducted output power of the intentional radiator is reduced by 1 dB for every 3 dB that the directional gain of the antenna exceeds 6dBi.

6.1.2 EUT Antenna

The antenna is layout on PCB in the EUT and no consideration of replacement. Antenna gain is Max1.0dBi from 2.4GHz to 2.5GHz.

6.2 Conduction Emissions Measurement

6.2.1 Applied procedures / Limit

Frequency of Emission (MHz)	Conducted Limit (dB μ V)	
	Quasi-peak	Average
0.15-0.5	66 to 56 *	56 to 46 *
0.5-5	56	46
5-30	60	50

Note: Decreases with the logarithm of the frequency.

6.2.2 Test procedure

EUT was placed upon a wooden test table 0.8m above the horizontal metal reference plane and 0.4m from the vertical ground plane, and it was connected to an AMN. The closest distance between the boundary of the EUT and the surface of the AMN is 0.8m. All peripherals were connected to another AMN, and placed at a distance of 10cm from each other. A spectrum and receiver was connected to the RF output port of the AMN. Both average and quasi-peak value were detected.

6.2.3 Test setup

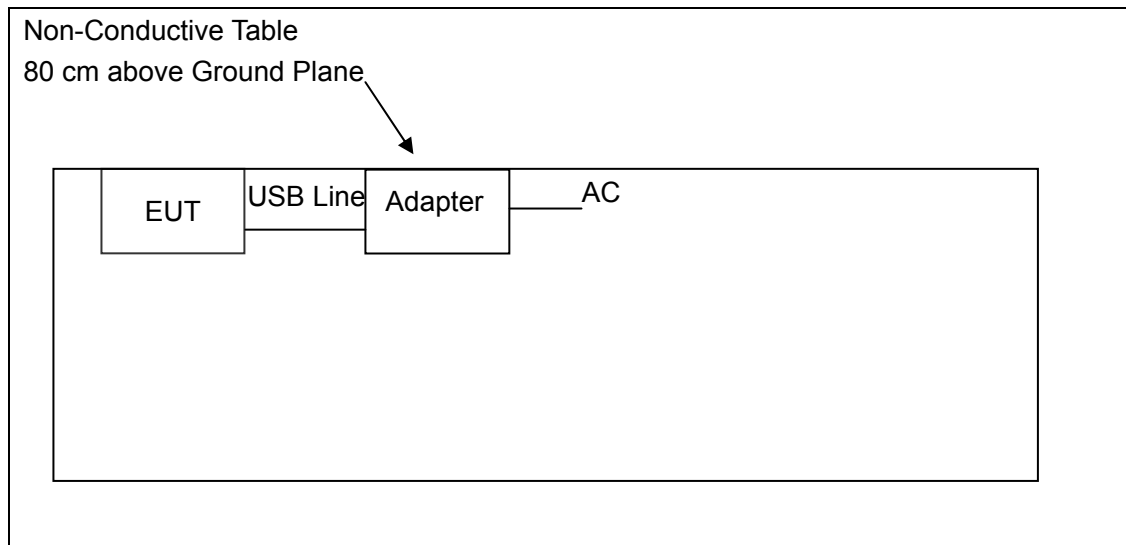

6.2.4 Test results

EUT:	smart activity & sleep tracker	Model Name. :	IR125B
Temperature:	26 °C	Relative Humidity:	54%
Pressure:	1010hPa	Test Date :	2015-06-03
Test Mode:	TX CH00 (worst case)	Phase :	Line
Test Voltage :	DC 5.0V from adapter, AC 120V/60Hz for adapter		

Frequency (MHz)	Meter Reading (dBμV)	Factor(dB)	Emission Level (dBμV)	Limits (dBμV)	Margin (dB)	Detector
*0.4220	25.80	10.11	35.91	57.41	-21.50	Quasi-Peak
0.4220	13.64	10.11	23.75	47.41	-23.66	Average
3.8140	17.03	10.05	27.08	56.00	-28.92	Quasi-Peak
3.7220	6.27	10.05	16.32	46.00	-29.68	Average
11.0020	22.45	10.32	32.77	60.00	-27.23	Quasi-Peak
12.8740	13.20	10.34	23.54	50.00	-26.46	Average

Remark:

- Factor = Insertion Loss + Cable Loss + Pulse limit.
- ** means the worst case.

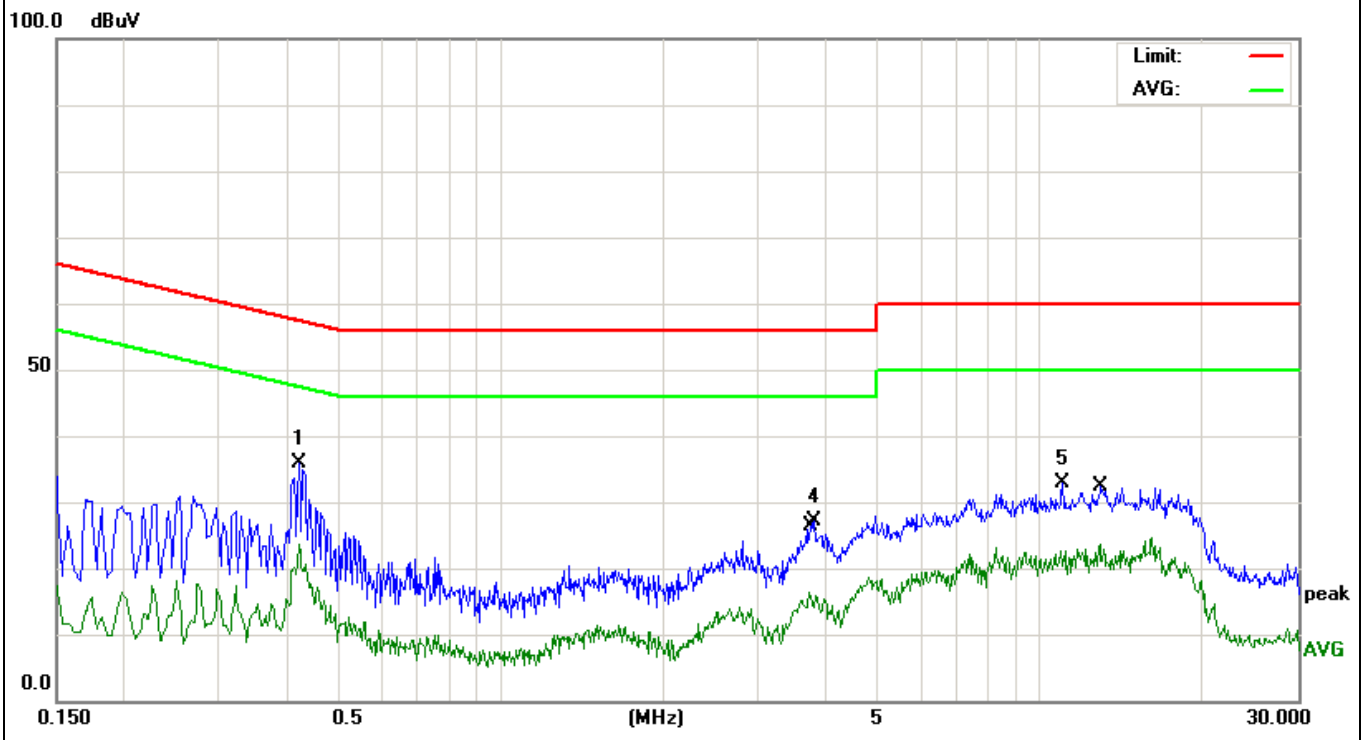

EUT:	smart activity & sleep tracker	Model Name. :	IR125B
Temperature:	26 °C	Relative Humidity:	54%
Pressure:	1010hPa	Test Date :	2015-06-03
Test Mode:	TX CH00 (worst case)	Phase :	Neutral
Test Voltage :	DC 5.0V from adapter, AC 120V/60Hz for adapter		

Frequency (MHz)	Meter Reading (dBμV)	Factor(dB)	Emission Level (dBμV)	Limits (dBμV)	Margin (dB)	Detector
0.4220	23.79	10.11	33.90	57.41	-23.51	Quasi-Peak
*0.4260	15.75	10.10	25.85	47.33	-21.48	Average
3.4860	13.59	10.04	23.63	56.00	-32.37	Quasi-Peak
2.6500	4.55	10.02	14.57	46.00	-31.43	Average
12.8258	16.00	10.34	26.34	60.00	-33.66	Quasi-Peak
15.7659	5.76	10.40	16.16	50.00	-33.84	Average

Remark:

- Factor = Insertion Loss + Cable Loss + Pulse limit.
- '*' means the worst case.

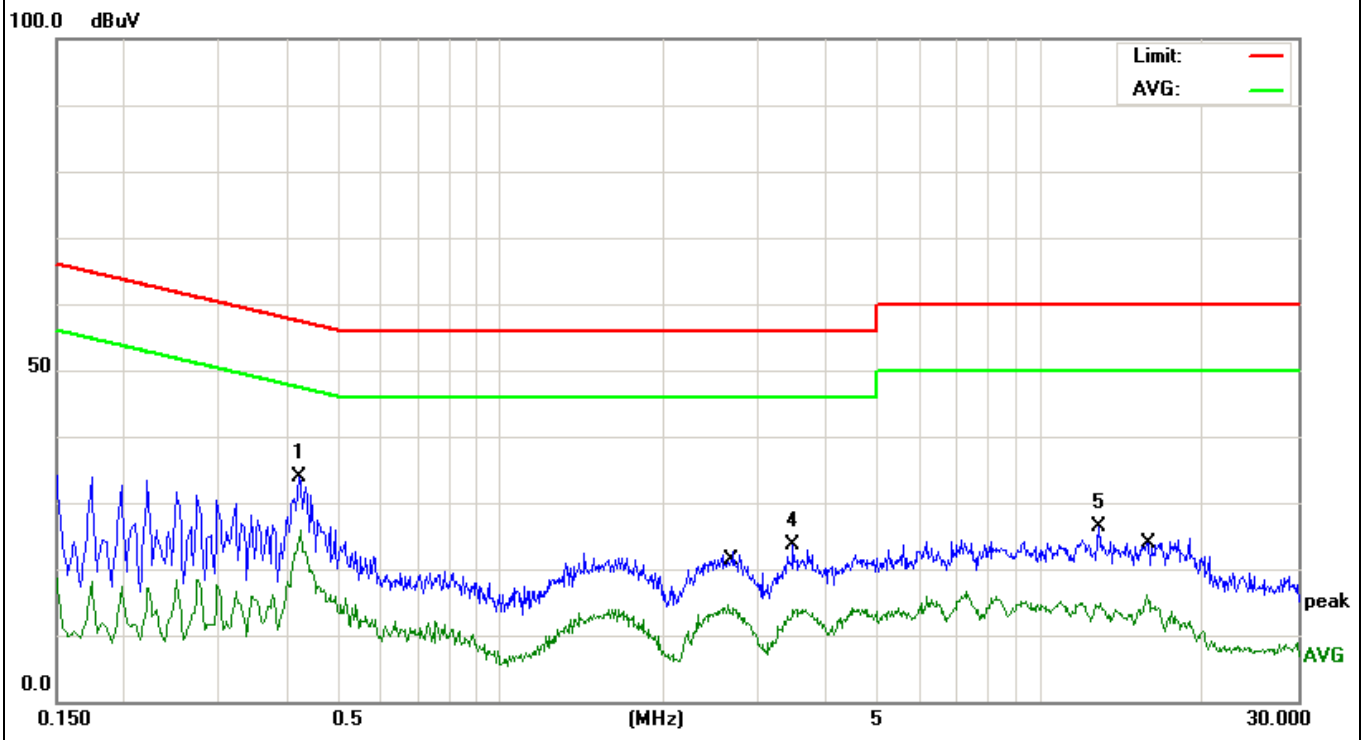

6.3 Radiated Emissions Measurement

6.3.1 Applied procedures / Limit

15.247(d) In any 100 kHz bandwidth outside the frequency band in which the spread spectrum or digitally modulated intentional radiator is operating, the radio frequency power that is produced by the intentional radiator shall be at least 20 dB below that in the 100 kHz bandwidth within the band that contains the highest level of the desired power, based on either an RF conducted or a radiated measurement, provided the transmitter demonstrates compliance with the peak conducted power limits. If the transmitter complies with the conducted power limits based on the use of RMS averaging over a time interval, as permitted under paragraph (b)(3) of this section, the attenuation required under this paragraph shall be 30 dB instead of 20 dB. Attenuation below the general limits specified in Section 15.209(a) is not required. In addition, radiated emissions which fall in the restricted bands, as defined in Section 15.205(a), must also comply with the radiated emission limits specified in Section 15.209(a) (see Section 15.205(c)).

Frequency of Emission (MHz)	Field Strength		Measurement Distance (meters)
	$\mu\text{V/m}$	$\text{dB}\mu\text{V/m}$	
0.009-0.49	2400/F(kHz)		300
0.49-1.705	24000/F(kHz)		30
1.705-30	30		30
30-88	100	40	3
88-216	150	43.5	3
216-960	200	46	3
Above 960	500	54	3

6.3.2 Test setup

Test Configuration:

- 1) 9 kHz to 30 MHz emissions:

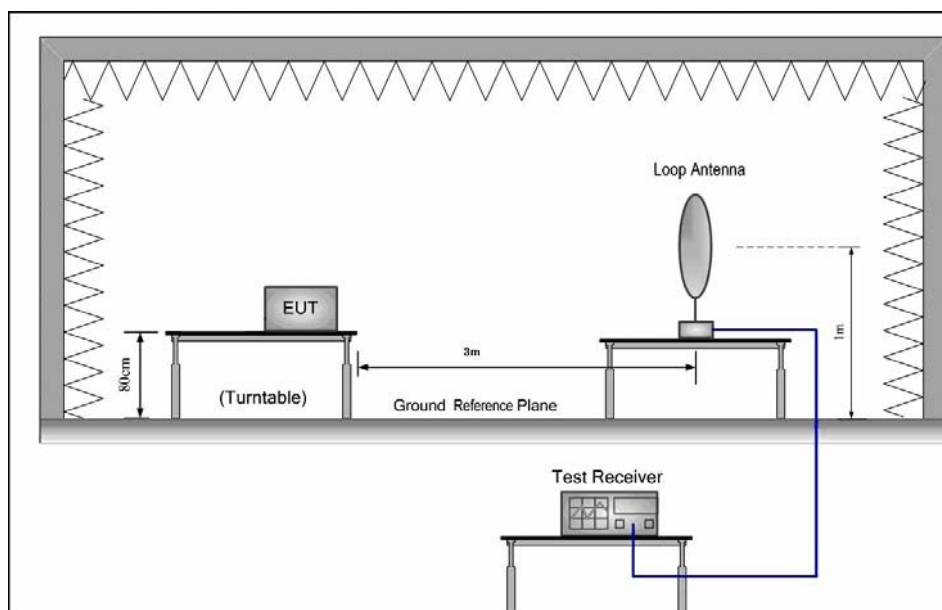

2) 30 MHz to 1 GHz emissions:

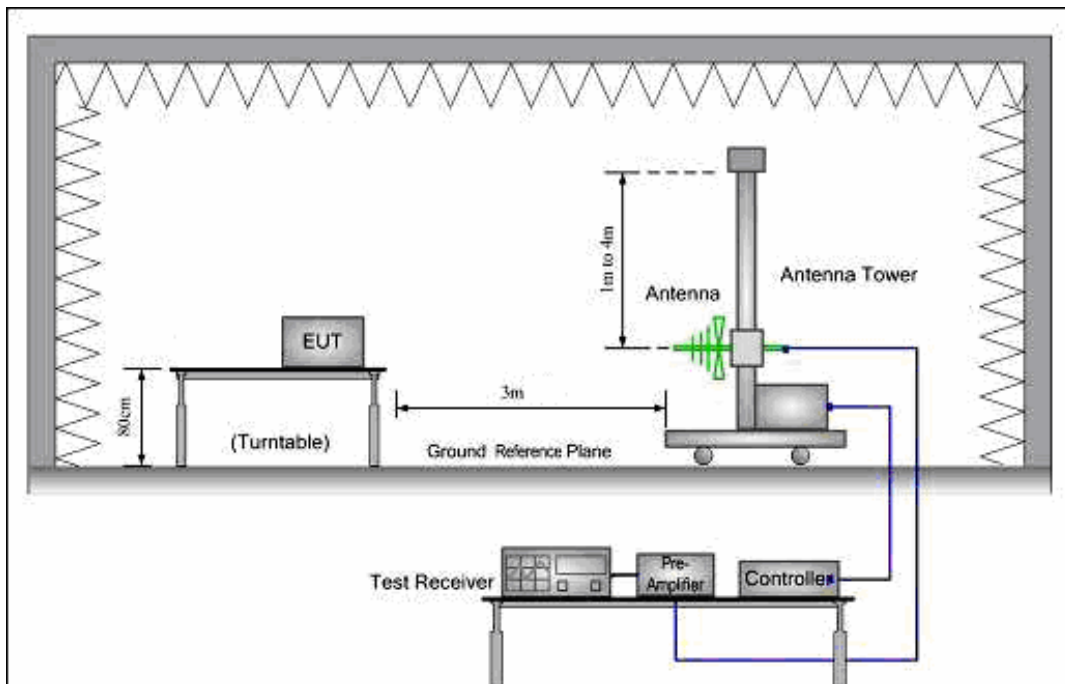

3) 1 GHz to 25 GHz emissions:

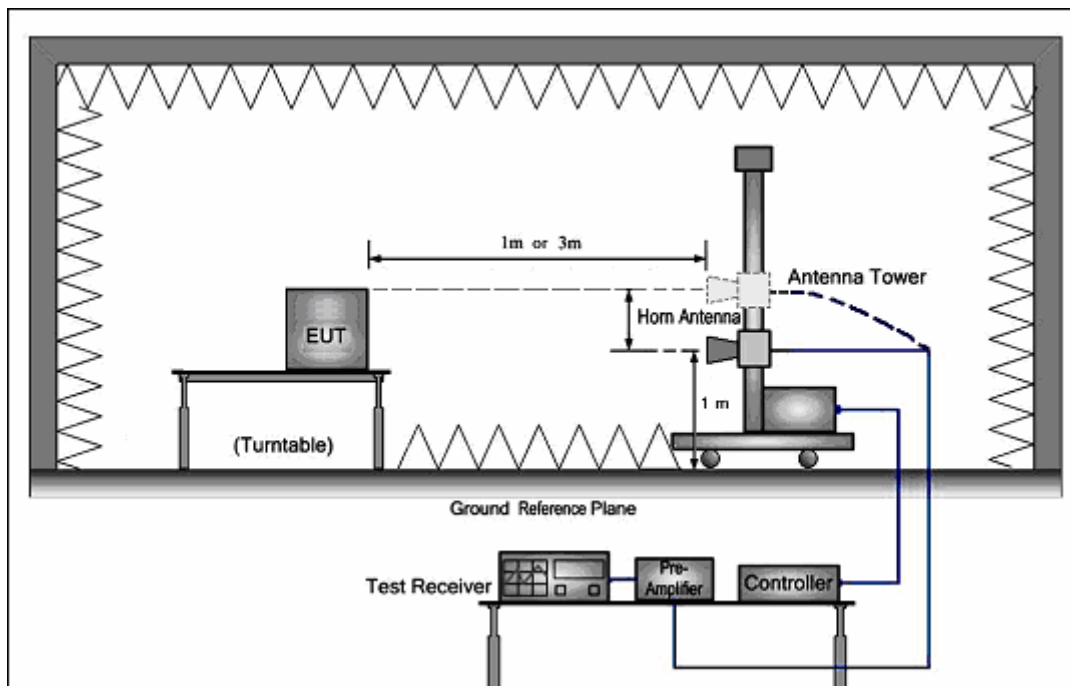

6.3.3 Test procedure

- a. The EUT was placed on the top of a rotating table 0.8 meters above the ground at a 3 meter semi-anechoic chamber. The table was rotated 360 degrees to determine the position of the highest radiation.
- b. The EUT was set 3 meters away from the interference-receiving antenna, which was mounted on the top of a variable-height antenna tower.
- c. The antenna height is varied from one meter to four meters above the ground to determine the maximum value of the field strength. Both horizontal and vertical polarizations of the antenna are set to make the measurement.
- d. For each suspected emission, the EUT was arranged to its worst case and then the antenna was tuned to heights from 1 meter to 4 meters (for the test frequency of below 30MHz, the antenna was tuned to heights 1 meter, for the test frequency of above 1GHz, horn antenna opening in the test would have been facing the EUT when rise or fall) and the table was turned from 0 degrees to 360 degrees to find the maximum reading.
- e. The test-receiver system was set to Peak Detect Function and Specified Bandwidth with Maximum Hold Mode.
- f. If the emission level of the EUT in peak mode was 10dB lower than the limit specified, then testing could be stopped and the peak values of the EUT would be reported. Otherwise the emissions that did not have 10dB margin would be re-tested one by one using peak, quasi-peak or average method as specified and then reported in a data sheet. The resolution bandwidth and video bandwidth of the test receiver was 1MHz and 1MHz for Peak detection at frequency above 1GHz.
- g. Test the EUT in the lowest channel (2402MHz), the middle channel (2440MHz), the Highest channel (2480MHz)
- h. The radiation measurements are performed in X, Y, Z axis positioning. And found the X axis positioning which it is worse case, only the test worst case mode is recorded in the report.
- i. Repeat above procedures until all frequencies measured was complete.

For Average measurement at frequency above 1GHz. The resolution bandwidth of the test receiver was 1MHz; due to the shortest pulse width T is 116us, according the video bandwidth should not smaller than $1/T$, so the video bandwidth is 10Hz.

In 18GHz to 25GHz, The EUT was checked by Horn ANT. But the test result at least have 20dB margin.

The EUT was tested in Chamber Site.

6.3.4 Test Result

Radiated Emissions Test Data Below 30MHz

EUT:	smart activity & sleep tracker	Model Name :	IR125B
Temperature:	25 °C	Test Data	2015-06-03
Pressure:	1005 hPa	Relative Humidity:	60%
Test Mode :	TX(1Mbps worst case)	Test Voltage :	DC 3.7V from battery
Measurement Distance	3 m	Frequency Range	9KHz to 30MHz
RBW/VBW	9KHz~150KHz/RB 200Hz for QP, 150KHz~30MHz/RB 9KHz for QP		

No emission found between lowest internal used/generated frequencies to 30MHz.

Radiated Emissions Test Data Below 1GHz

EUT:	smart activity & sleep tracker	Model Name :	IR125B
Temperature:	25 °C	Test Data	2015-06-03
Pressure:	1010 hPa	Relative Humidity:	60%
Test Mode :	TX (1Mbps) CH00 (worst case)	Test Voltage :	DC 3.7V from battery
Measurement Distance	3 m	Frenqucy Range	30MHz to 1GHz
RBW/VBW	100KHz / 300KHz for spectrum, RBW=120KHz for receiver.		

(a) Antenna polarization: Horizontal

Frequency (MHz)	Reading Level (dBuV)	Correct Factor (dB)	Measure Level (dBuV/m)	Limit (dBuV/m)	Margin (dB)	Detector Type
39.4371	29.13	- 14.36	14.77	40.00	- 25.23	QUASIPeAK
107.5101	31.72	- 15.31	16.41	43.50	- 27.09	QUASIPeAK
183.2005	30.99	- 10.39	20.60	43.50	- 22.90	QUASIPeAK
242.5253	31.87	- 11.41	20.46	46.00	- 25.54	QUASIPeAK
293.0842	31.19	- 9.87	21.32	46.00	- 24.68	QUASIPeAK
*699.3046	30.51	0.14	30.65	46.00	- 15.35	QUASIPeAK

(b) Antenna polarization: vertical

Frequency (MHz)	Reading Level (dBuV)	Correct Factor (dB)	Measure Level (dBuV/m)	Limit (dBuV/m)	Margin (dB)	Detector Type
36.1272	38.94	-16.64	22.30	40.00	-17.70	QUASIPeAK
49.0144	33.48	-18.42	15.06	40.00	-24.94	QUASIPeAK
*103.0799	39.91	-13.54	26.37	43.50	-17.13	QUASIPeAK
115.7256	38.22	-14.13	24.09	43.50	-19.41	QUASIPeAK
377.2590	29.63	-7.65	21.98	46.00	-24.02	QUASIPeAK
798.9796	29.56	3.24	32.80	46.00	-13.20	QUASIPeAK

Note: '*' means the worst case

Measurement Level = Reading Level + Factor

Factor = Ant Factor + Cable Loss - Pre-amplifier

Radiated Emissions Test Data Above 1GHz

EUT:	smart activity & sleep tracker	Model Name :	IR125B
Temperature:	25 °C	Test Data	2015-06-03
Pressure:	1010 hPa	Relative Humidity:	60%
Test Mode :	TX(1Mbps)	Test Voltage :	DC 3.7V from battery
Measurement Distance	3 m	Frenqucy Range	1GHz to 25GHz
RBW/VBW	Spurious emission: 1MHz/1MHz for Peak, 1MHz/10Hz for Average. non-restricted band: 100KHz/300KHz for Peak.		

(a) Antenna polarization: Horizontal

Frequency (MHz)	Reading Level (dBuV)	Correct Factor (dB)	Measure Level (dBuV/m)	Limit (dBuV/m)	Margin (dB)	Detector Type
4804.000	47.18	5.06	52.24	74.00	-21.76	PEAK
*4804.000	34.83	5.06	39.89	54.00	-14.11	AVERAGE
7206.000	44.02	7.03	51.05	74.00	-22.95	PEAK
7206.000	32.37	7.03	39.40	54.00	-14.60	AVERAGE

(b) Antenna polarization: Vertical

Frequency (MHz)	Reading Level (dBuV)	Correct Factor (dB)	Measure Level (dBuV/m)	Limit (dBuV/m)	Margin (dB)	Detector Type
4804.000	43.67	5.06	48.73	74.00	-25.27	PEAK
*4804.000	32.60	5.06	37.66	54.00	-16.34	AVERAGE
7206.000	40.95	7.03	47.98	74.00	-26.02	PEAK
7206.000	30.49	7.03	37.52	54.00	-16.48	AVERAGE

Note: '*' means the worst case

8~25GHz at least have 20dB margin. No recording in the test report.

Measurement Level = Reading Level + Factor

Factor = Ant Factor + Cable Loss - Pre-amplifier

Low Channel 00: 2402 MHz

Data rate: 1Mbps

(a) Antenna polarization: Horizontal

Frequency (MHz)	Reading Level (dBuV)	Correct Factor (dB)	Measure Level (dBuV/m)	Limit (dBuV/m)	Margin (dB)	Detector Type
4880.000	44.41	5.14	49.55	74.00	-24.45	PEAK
*4880.000	32.56	5.14	37.70	54.00	-16.30	AVERAGE
7320.000	40.67	7.52	48.19	74.00	-25.81	PEAK
7320.000	29.49	7.52	37.01	54.00	-16.99	AVERAGE

(b) Antenna polarization: Vertical

Frequency (MHz)	Reading Level (dBuV)	Correct Factor (dB)	Measure Level (dBuV/m)	Limit (dBuV/m)	Margin (dB)	Detector Type
4880.000	43.53	5.14	48.67	74.00	-25.33	PEAK
*4880.000	33.62	5.14	38.76	54.00	-15.24	AVERAGE
7320.000	41.22	7.52	48.74	74.00	-25.26	PEAK
7320.000	30.04	7.52	37.56	54.00	-16.44	AVERAGE

Note: '*' means the worst case

8~25GHz at least have 20dB margin. No recording in the test report.

Measurement Level = Reading Level + Factor

Factor= Ant Factor + Cable Loss - Pre-amplifier

Middle Channel 19: 2440 MHz

Data rate: 1Mbps

(a) Antenna polarization: Horizontal

Frequency (MHz)	Reading Level (dBuV)	Correct Factor (dB)	Measure Level (dBuV/m)	Limit (dBuV/m)	Margin (dB)	Detector Type
4960.000	43.66	5.22	48.88	74.00	-25.12	PEAK
*4960.000	34.12	5.22	39.34	54.00	-14.66	AVERAGE
7440.000	40.14	8.06	48.20	74.00	-25.80	PEAK
7440.000	29.98	8.06	38.04	54.00	-15.96	AVERAGE

(b) Antenna polarization: Vertical

Frequency (MHz)	Reading Level (dBuV)	Correct Factor (dB)	Measure Level (dBuV/m)	Limit (dBuV/m)	Margin (dB)	Detector Type
4960.000	42.74	5.22	47.96	74.00	-26.04	PEAK
4960.000	32.78	5.22	38.00	54.00	-16.00	AVERAGE
7440.000	39.67	8.06	47.73	74.00	-26.27	PEAK
*7440.000	30.18	8.06	38.24	54.00	-15.76	AVERAGE

Note: '*' means the worst case

8~25GHz at least have 20dB margin. No recording in the test report.

Measurement Level = Reading Level + Factor

Factor= Ant Factor + Cable Loss - Pre-amplifier

Low Channel 39: 2480 MHz

Data rate: 1Mbps

6.3.5 TEST RESULTS (Restricted Bands Requirements)

EUT:	smart activity & sleep tracker	Model Name :	IR125B
Temperature:	25 °C	Test Data	2015-06-03
Pressure:	1010 hPa	Relative Humidity:	60%
Test Mode :	TX(1Mbps)	Test Voltage :	DC 3.7V from battery
RBW/VBW	1MHz/1MHz for Peak, 1MHz/10Hz for Average.		
Note:	<ol style="list-style-type: none"> 1. The transmitter was setup to transmit at the lowest channel. Then the field strength was measured at 2310-2390 MHz. 2. The transmitter was setup to transmit at the highest channel. Then the field strength was measured at 2483.5-2500 MHz. 3. The data of 2390MHz and 2483.5MHz was the worst. 		

Test Mode	Ant.Pol. H/V	Freq. (MHz)	Reading		Ant/CF CF(dB)	Act		Limit	
			Peak (dBuv)	AV (dBuv)		Peak (dBuv/m)	AV (dBuv/m)	Peak (dBuv/m)	AV (dBuv/m)
TX Data rate 1Mbps	H	2390.00	47.34	36.25	-5.79	41.55	30.46	74.00	54.00
	V	2390.00	48.15	37.26	-5.79	42.36	31.47	74.00	54.00
	H	2483.50	45.79	35.27	-4.98	40.81	30.29	74.00	54.00
	V	2483.50	46.11	35.27	-4.98	41.13	30.29	74.00	54.00

6.4 BANDWIDTH TEST

6.4.1 Applied procedures / Limit

15.247(a) (2) Systems using digital modulation techniques may operate in the 902 - 928 MHz, 2400 - 2483.5 MHz, and 5725 - 5850 MHz bands. The minimum 6 dB bandwidth shall be at least 500 kHz.

6.4.2 Test procedure

- a. The testing follows FCC KDB publication No. 558074 D01 DTS Meas. Guidance v03r03
- b. The EUT was directly connected to the spectrum analyzer and antenna output port as show in the block diagram below.
- c. Spectrum Setting: RBW= 100KHz, VBW \geq 3 \times RBW, Sweep time = Auto, Detector Function = Peak, centering on a hopping channel Trace = Max Hold.
- d. Mark the peak frequency and -6 dB points bandwidth.

6.4.3 Deviation from standard

No deviation.

6.4.4 Test setup



6.4.5 Test results

EUT:	smart activity & sleep tracker	Model Name :	IR125B
Temperature:	26 °C	Relative Humidity:	53%
Pressure:	1010 hPa	Test Power :	DC 3.7V from battery
Test Mode :	TX(1Mbps)		

Test Mode	Test Channel	Frequency (MHz)	6 dB Bandwidth (KHz)	Limit (kHz)
Data rate 1Mbps	CH00	2402	677.3	≧ 500
	CH19	2440	680.3	≧ 500
	CH39	2480	680.3	≧ 500

(1Mbps)
 The Lowest Channel 00: 2402 MHz

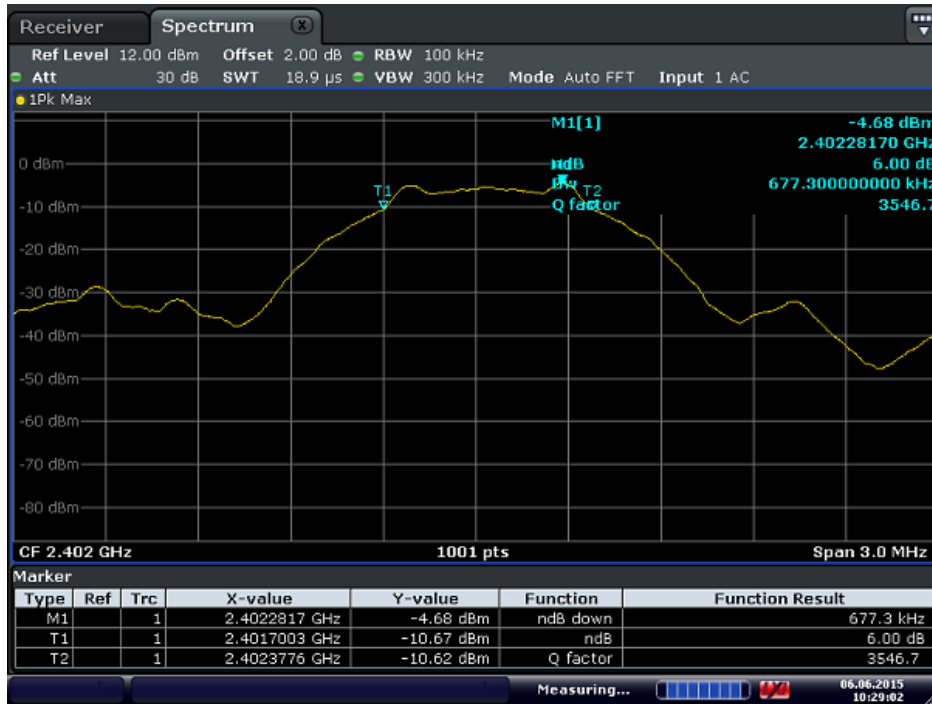

Date: 6.JUN.2015 10:29:02

(1Mbps)
 The Middle Channel 19: 2440 MHz

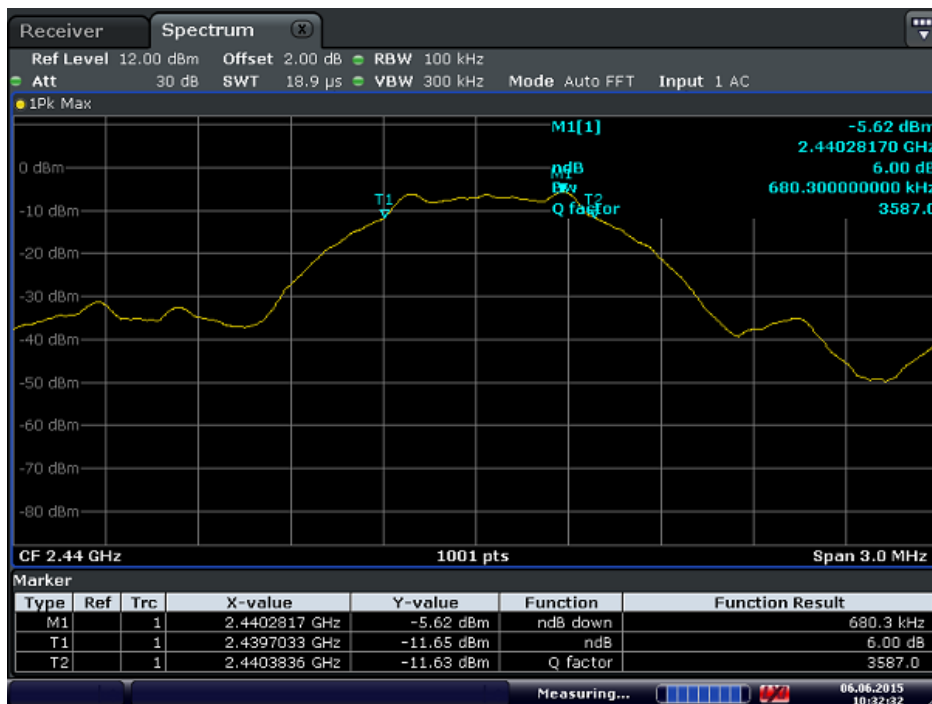

Date: 6.JUN.2015 10:32:32

(1Mbps)
 The High Channel 39: 2480MHz

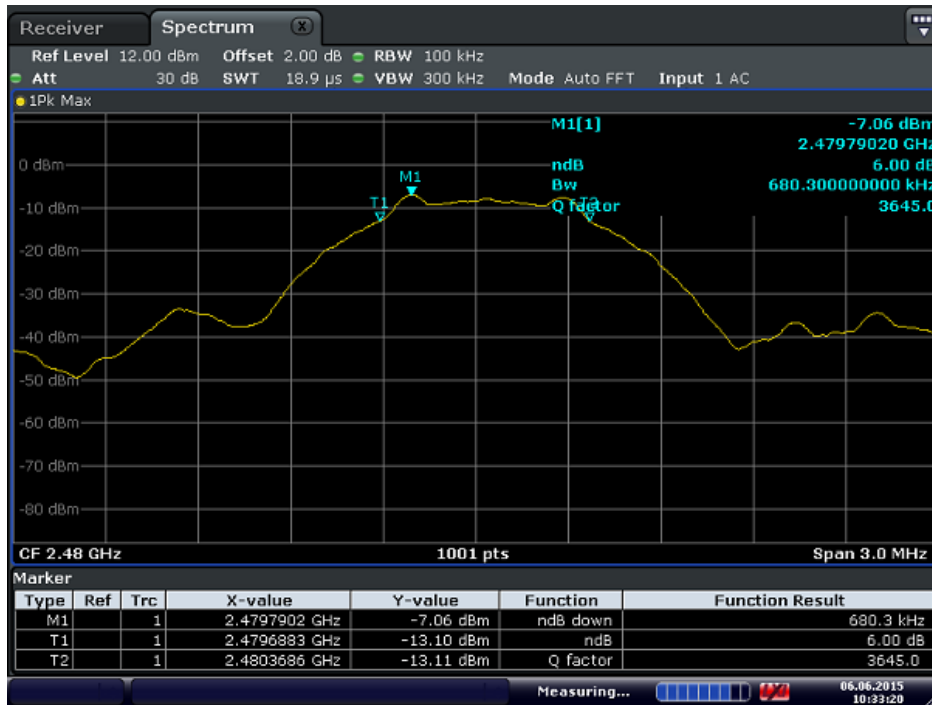

Date: 6.JUN.2015 10:33:20

6.5 Peak Power Density

6.5.1 Applied procedures / Limit

15.247(a) (e) For digitally modulated systems, the power spectral density conducted from the intentional radiator to the antenna shall not be greater than 8 dBm in any 3 kHz band during any time interval of continuous transmission. This power spectral density shall be determined in accordance with the provisions of paragraph (b) of this section. The same method of determining the conducted output power shall be used to determine the power spectral density.

6.5.2 Test procedure

- a. The testing follows Measurement procedure 10.2 Method PKPSD of FCC KDB publication No. 558074 D01 DTS Meas. Guidance v03r03
- b. The EUT was directly connected to the spectrum analyzer and antenna output port as show in the block diagram below.
- c. Connected the antenna port to the Spectrum Analyzer, set the Spectrum Analyzer as center frequency to channel center frequency, span=1.5 times the bandwidth, detector = peak
 $3\text{kHz} \leq \text{RBW} \leq 100\text{kHz}$, $\text{VBW} \geq 3 \times \text{RBW}$ kHz, Sweep time=Auto.
- d. Trace mode = max hold. Mark the peak.
- e. If measured value exceeds limit, reduce RBW (no less than 3 kHz) and repeat.

6.5.3 Deviation from standard

No deviation.

6.5.4 Test results

EUT:	smart activity & sleep tracker	Model Name :	IR125B
Temperature:	24 °C	Relative Humidity:	53%
Pressure:	1010 hPa	Test Power :	DC 3.7V from battery
Test Mode :	TX(1Mbps)		

Test Mode	Channel frequency (MHz)	Power Density	Limit (dBm/3kHz)	Result
		PSD 100kHz (dBm/100kHz)		
TX (1Mbps)	2402	-4.71	8	Pass
	2440	-5.55	8	Pass
	2480	-7.09	8	Pass

Note: The cable loss is 2.0dB

PSD 100kHz (1Mbps)
The Lowest Channel 00: 2402MHz

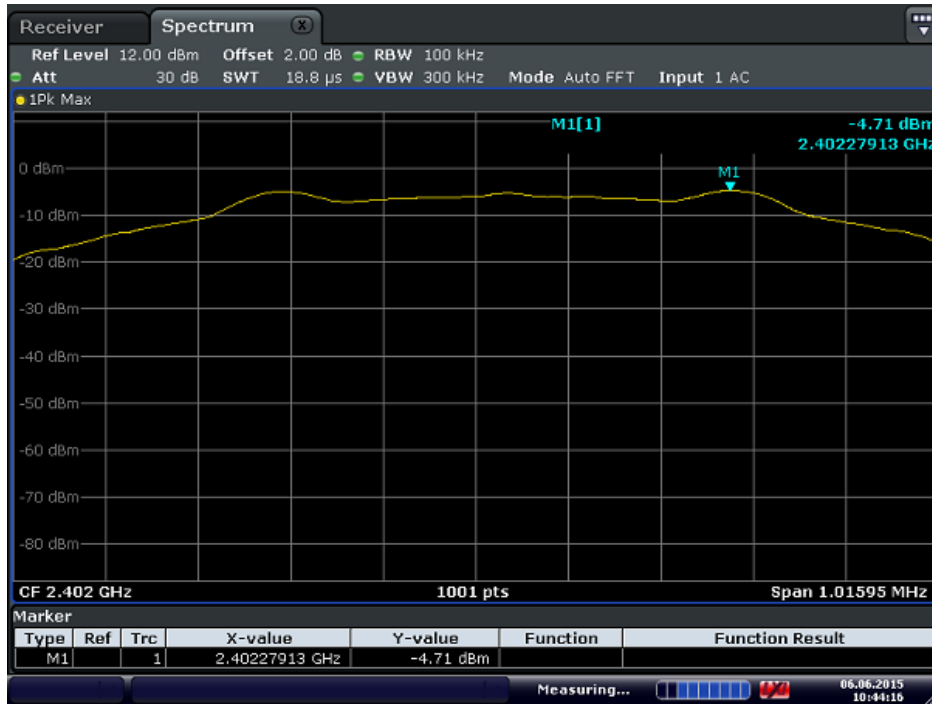

Date: 6. JUN. 2015 10:44:16

PSD 100kHz (1Mbps)
The Middle Channel 19: 2440MHz

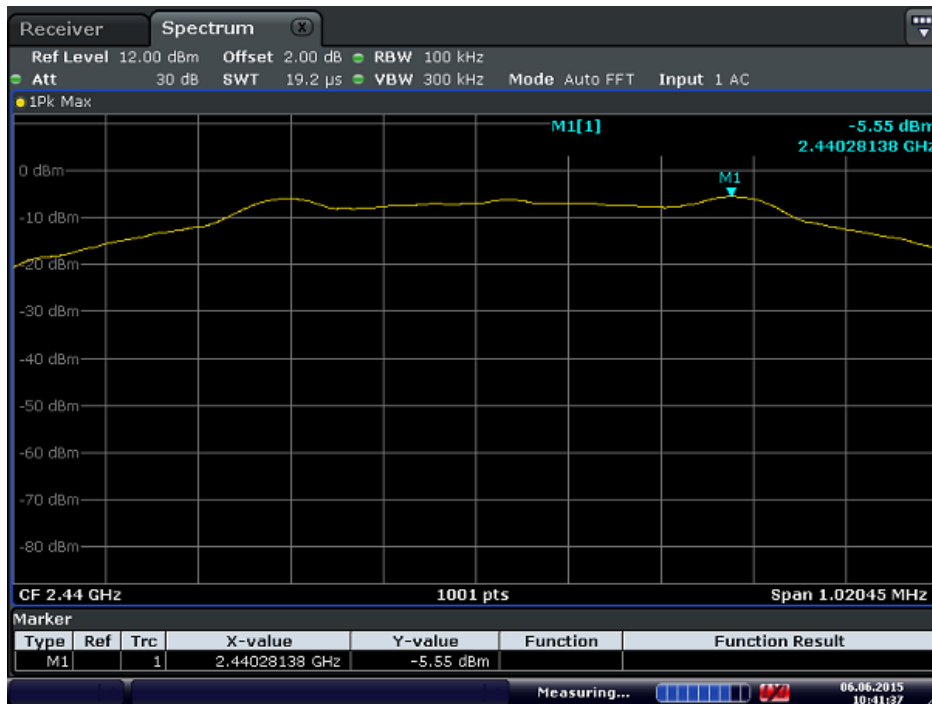

Date: 6. JUN. 2015 10:41:37

PSD 100kHz (1Mbps)
The High Channel 39: 2480MHz

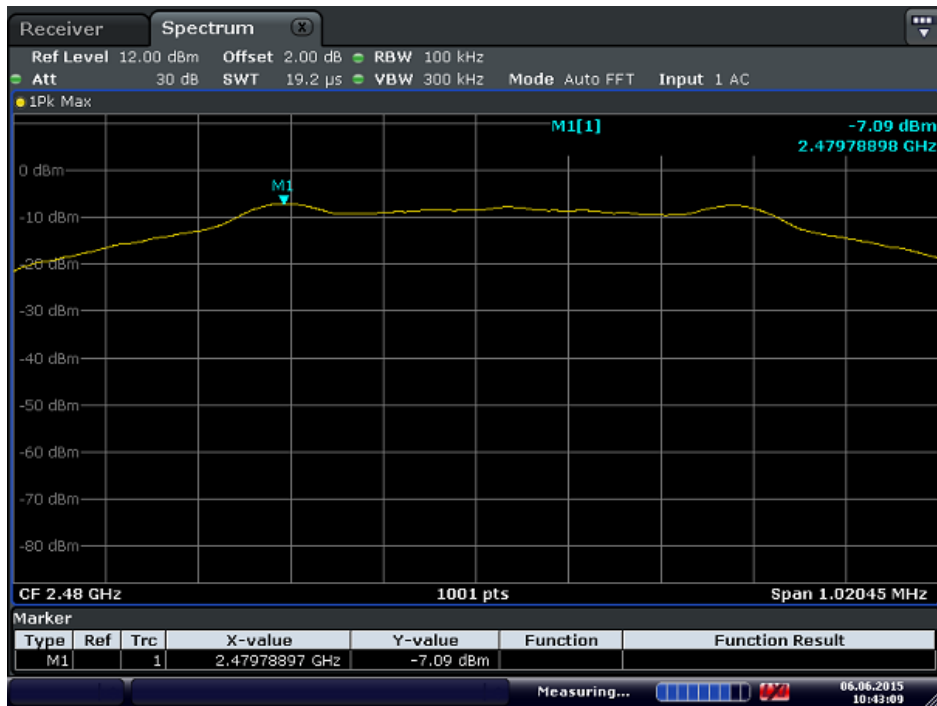

Date: 6.JUN.2015 10:43:09

6.6 Maximum Peak Output Power

6.6.1 Applied procedures / Limit

15.247(b) (3) For systems using digital modulation in the 902-928 MHz, 2400-2483.5 MHz, and 5725-5850 MHz bands: 1 Watt. As an alternative to a peak power measurement, compliance with the one Watt limit can be based on a measurement of the maximum conducted output power. Maximum Conducted Output Power is defined as the total transmit power delivered to all antennas and antenna elements averaged across all symbols in the signaling alphabet when the transmitter is operating at its maximum power control level. Power must be summed across all antennas and antenna elements. The average must not include any time intervals during which the transmitter is off or is transmitting at a reduced power level. If multiple modes of operation are possible (e.g., alternative modulation methods), the maximum conducted output power is the highest total transmit power occurring in any mode.

6.6.2 Test procedure

- a. The testing follows FCC KDB publication No. 558074 D01 DTS Meas. Guidance v03r03
- b. The EUT was directly connected to the spectrum analyzer and antenna output port as show in the block diagram below.
- c. Spectrum Setting: $RBW \geq \text{Bandwidth}$, $VBW \geq 3 \times RBW$, Sweep time = Auto, $\text{Span} \geq 3 \times RBW$,
- d. Detector = peak. Trace mode = max hold.
- e. Use peak marker function to determine the peak amplitude level.

6.6.3 Deviation from standard

No deviation.

6.6.4 Test setup



6.6.5 Test results

EUT:	smart activity & sleep tracker	Model Name :	IR125B
Temperature:	26 °C	Relative Humidity:	60%
Pressure:	1010 hPa	Test Voltage :	DC 3.7V from battery
Test Mode :	TX (1Mbps)		
Note: N/A			

Test Mode	Frequency	Peak Output Power (dBm)	Limit (dBm)	Result
Data rate 1Mbps	2402 MHz	-4.66	30	Pass
	2440 MHz	-5.61	30	Pass
	2480 MHz	-7.11	30	Pass

Note: The cable loss is 2.0dB

(1Mbps)
 The Lowest Channel 00: 2402MHz

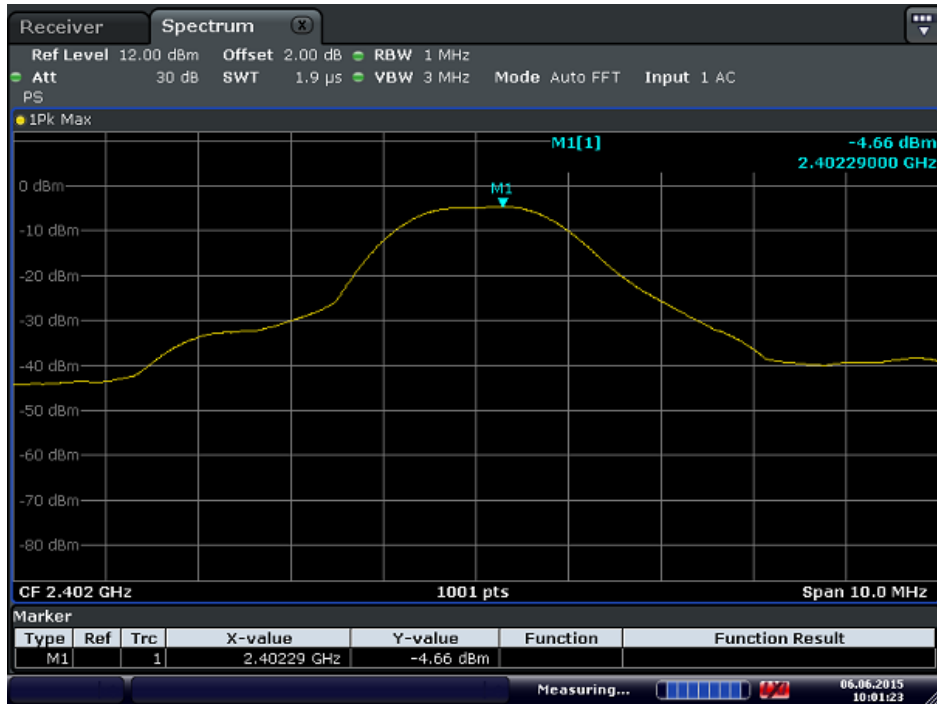

Date: 6.JUN.2015 10:01:23

(1Mbps)
 The Middle Channel 19: 2440MHz



Date: 6.JUN.2015 10:06:05

(1Mbps)
 The High Channel 39: 2480MHz

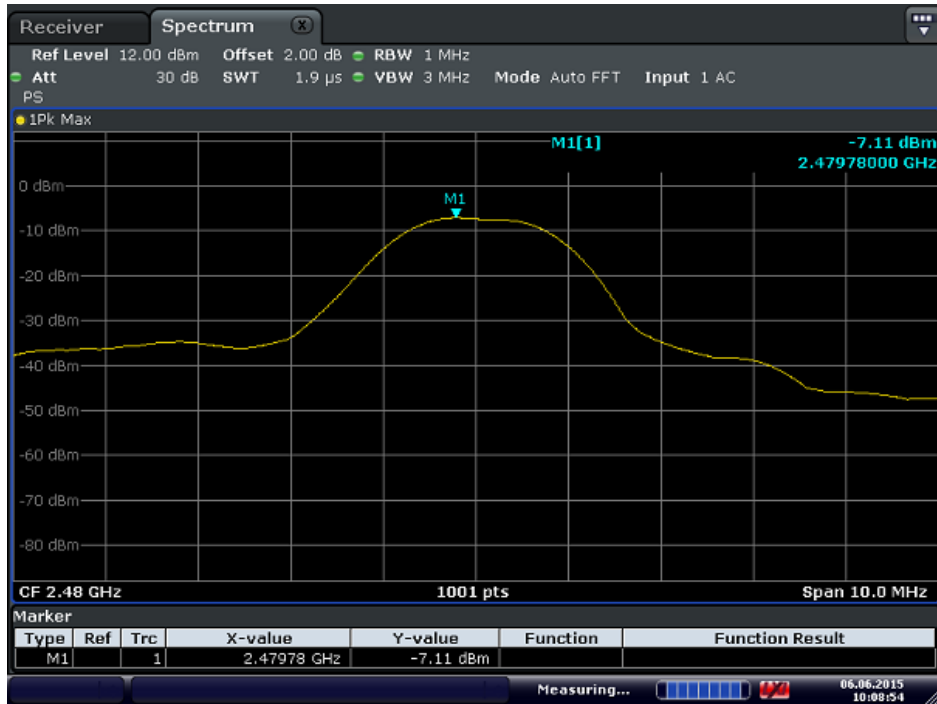

Date: 6.JUN.2015 10:08:53

6.7 Band edge

6.7.1 Applied procedures / Limit

15.247(d) In any 100 kHz bandwidth outside the frequency band in which the spread spectrum or digitally modulated intentional radiator is operating, the radio frequency power that is produced by the intentional radiator shall be at least 20 dB below that in the 100 kHz bandwidth within the band that contains the highest level of the desired power, based on either an RF conducted or a radiated measurement, provided the transmitter demonstrates compliance with the peak conducted power limits. If the transmitter complies with the conducted power limits based on the use of RMS averaging over a time interval, as permitted under paragraph (b)(3) of this section, the attenuation required under this paragraph shall be 30 dB instead of 20 dB. Attenuation below the general limits specified in Section 15.209(a) is not required. In addition, radiated emissions which fall in the restricted bands, as defined in Section 15.205(a), must also comply with the radiated emission limits specified in Section 15.209(a) (see Section 15.205(c)).

6.7.2 Test procedure

- a. The testing follows FCC KDB publication No. 558074 D01 DTS Meas. Guidance v03r03
- b. The EUT was directly connected to the spectrum analyzer and antenna output port as show in the block diagram below.
- c. Spectrum Setting: RBW=100kHz, VBW \geq 300kHz, Sweep time=Auto, Detector Function=Peak.
- d. The band edges was measured and recorded Result:
The Lower Edges attenuated more than 20dB.
The Upper Edges attenuated more than 20dB.

6.7.3 Deviation from standard

No deviation.

6.7.4 Test setup

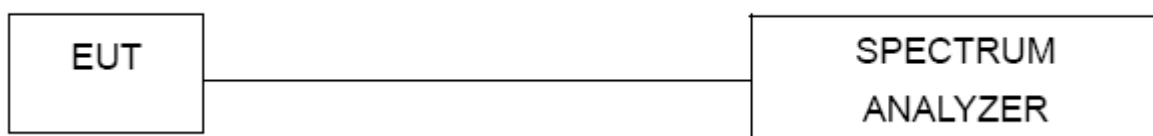

6.7.5 Test results

(1Mbps) The Lowest Channel 00: 2402MHz

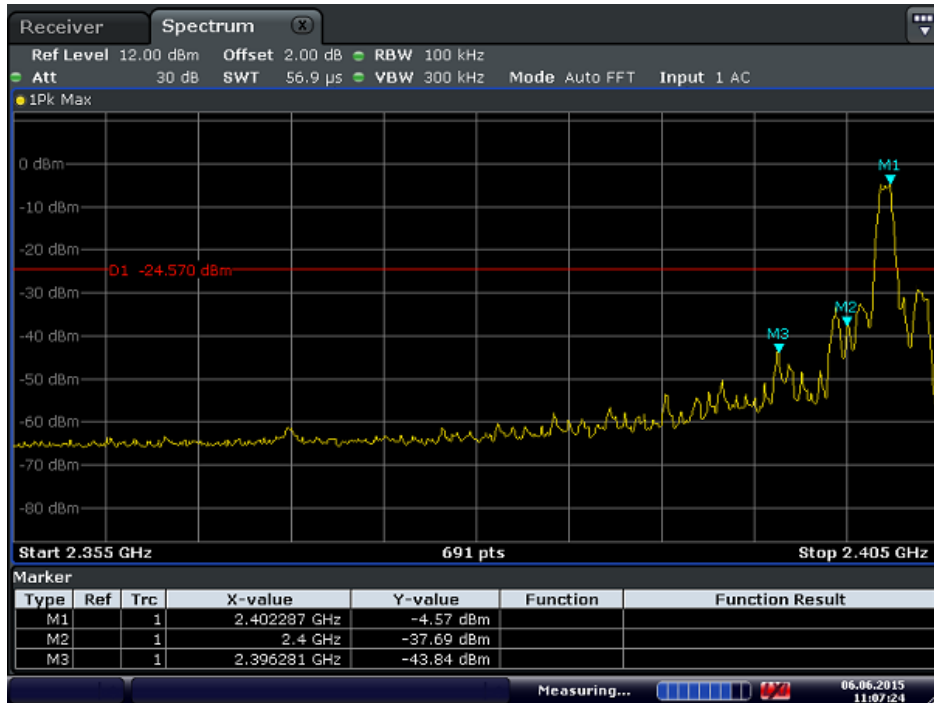

Date: 5. JUN. 2015 11:07:24

(1Mbps) The High Channel 39: 2480MHz



Date: 5. JUN. 2015 11:10:36

6.8 Conducted Spurious Emissions

6.8.1 Applied procedures / Limit

15.247(d) In any 100 kHz bandwidth outside the frequency band in which the spread spectrum or digitally modulated intentional radiator is operating, the radio frequency power that is produced by the intentional radiator shall be at least 20 dB below that in the 100 kHz bandwidth within the band that contains the highest level of the desired power, based on either an RF conducted or a radiated measurement, provided the transmitter demonstrates compliance with the peak conducted power limits. If the transmitter complies with the conducted power limits based on the use of RMS averaging over a time interval, as permitted under paragraph (b)(3) of this section, the attenuation required under this paragraph shall be 30 dB instead of 20 dB. Attenuation below the general limits specified in Section 15.209(a) is not required. In addition, radiated emissions which fall in the restricted bands, as defined in Section 15.205(a), must also comply with the radiated emission limits specified in Section 15.209(a) (see Section 15.205(c)).

6.8.2 Test procedure

- a. The testing follows FCC KDB publication No. 558074 D01 DTS Meas. Guidance v03r03
- b. The EUT was directly connected to the spectrum analyzer and antenna output port as show in the block diagram below.
- c. Spectrum Setting: RBW=100kHz, VBW=300kHz, Sweep time=Auto, Detector Function=Peak, sweep points \geq investigated frequency range/RBW.

6.8.3 Deviation from standard

No deviation.

6.8.4 Test setup



6.8.5 Test results

The Lowest Channel 00 (1Mbps): 2402MHz

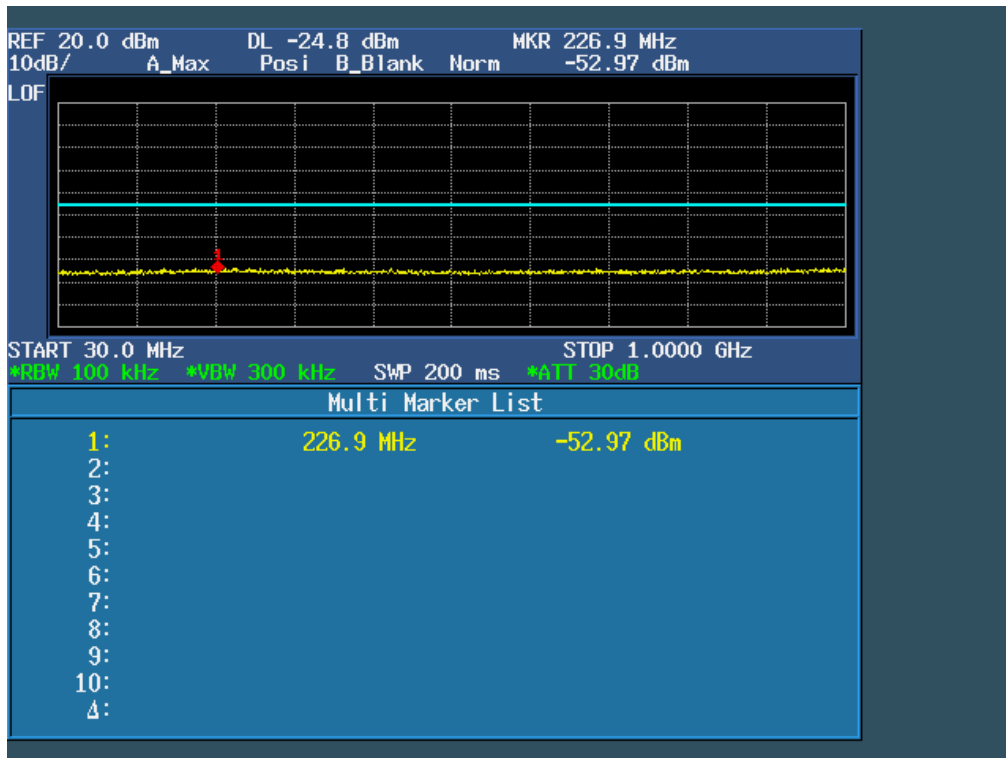

Note: Sweep Points=9700

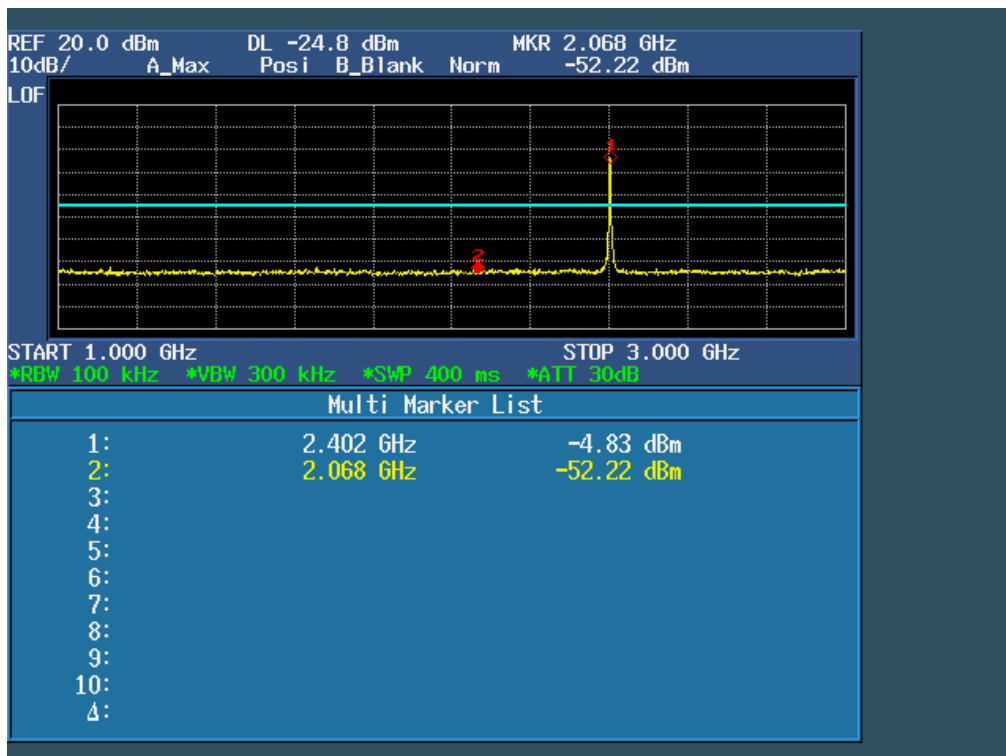

Note: Sweep Points=20000

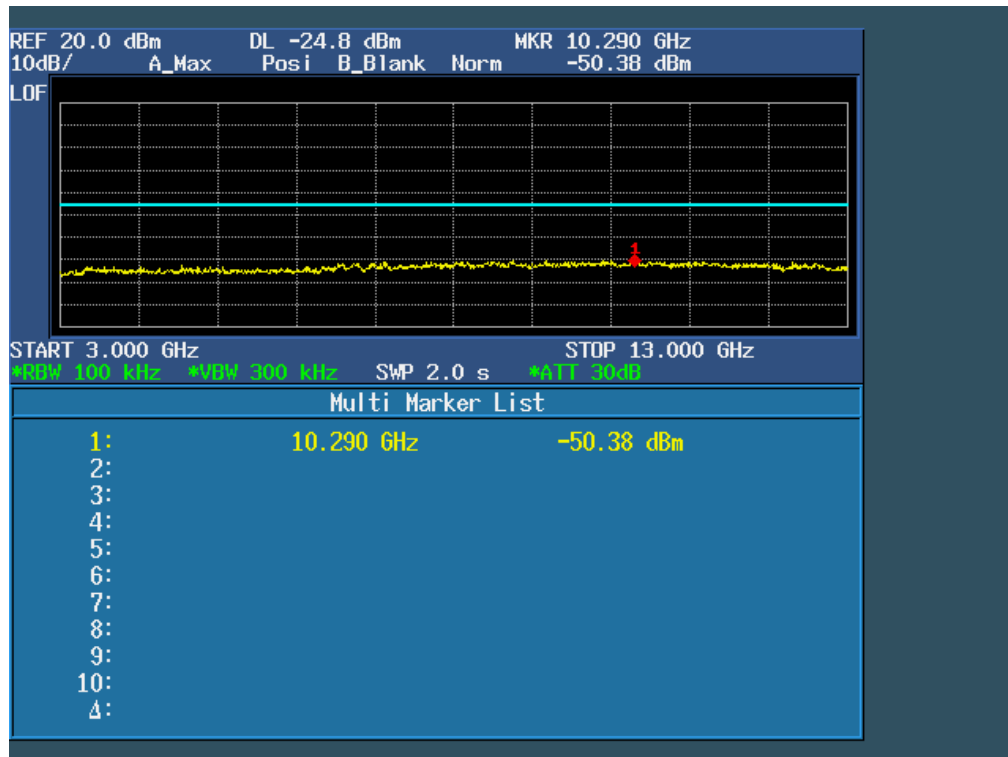

Note: Sweep Points=100000

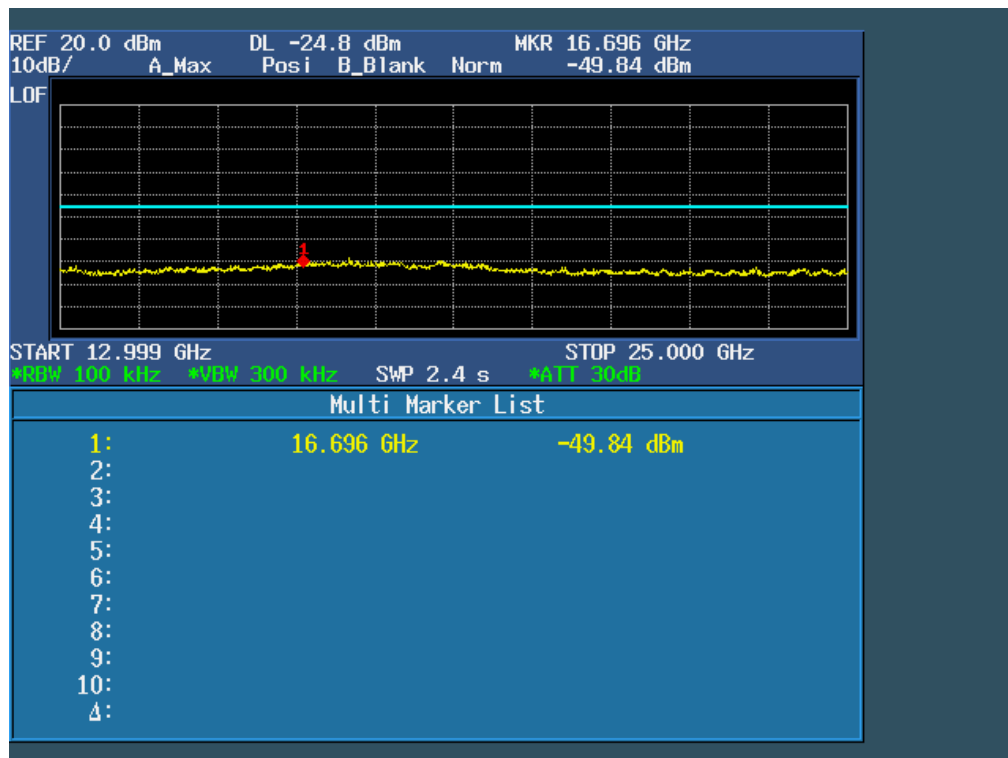

Note: Sweep Points=120000

The Middle Channel 19(1Mbps): 2440MHz

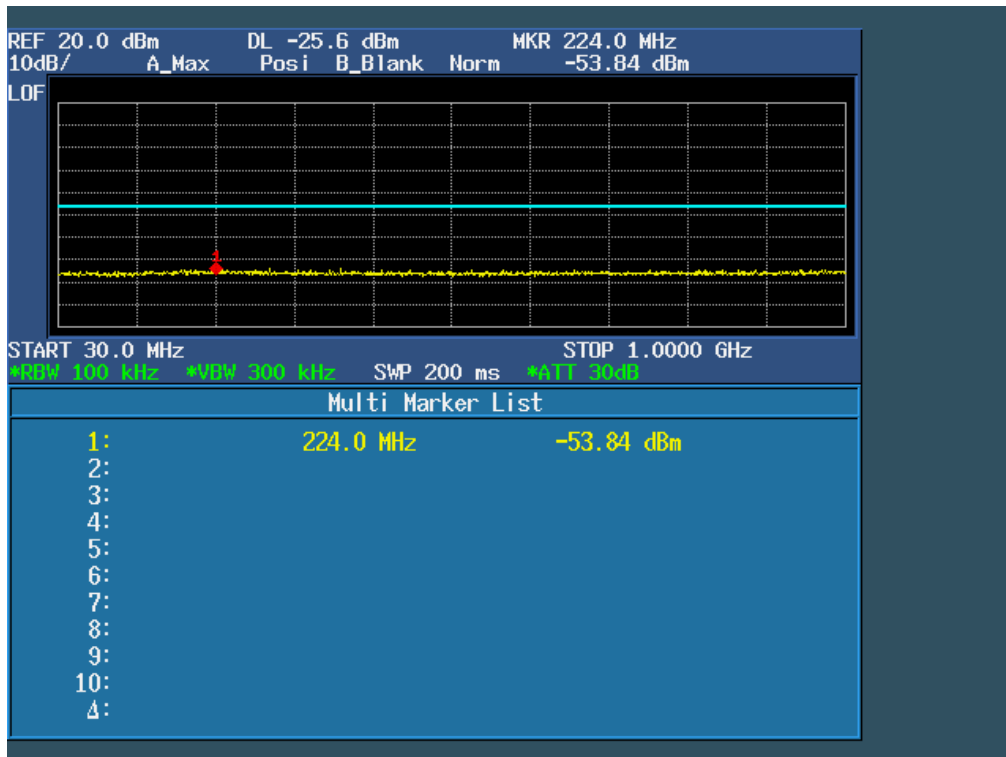

Note: Sweep Points=9700

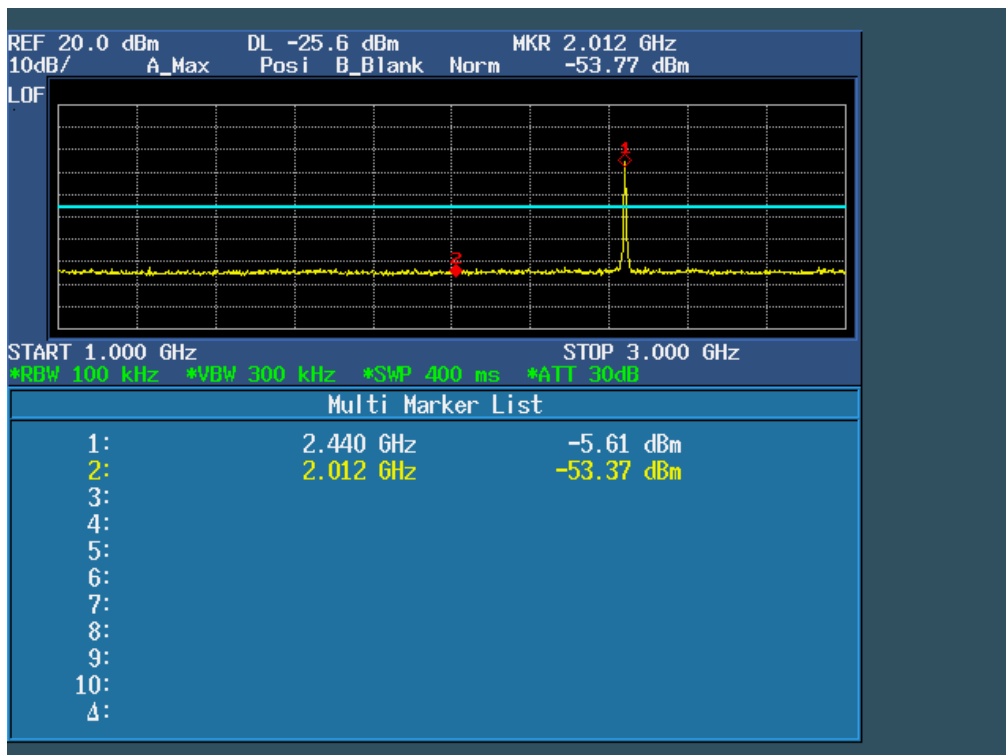

Note: Sweep Points=20000

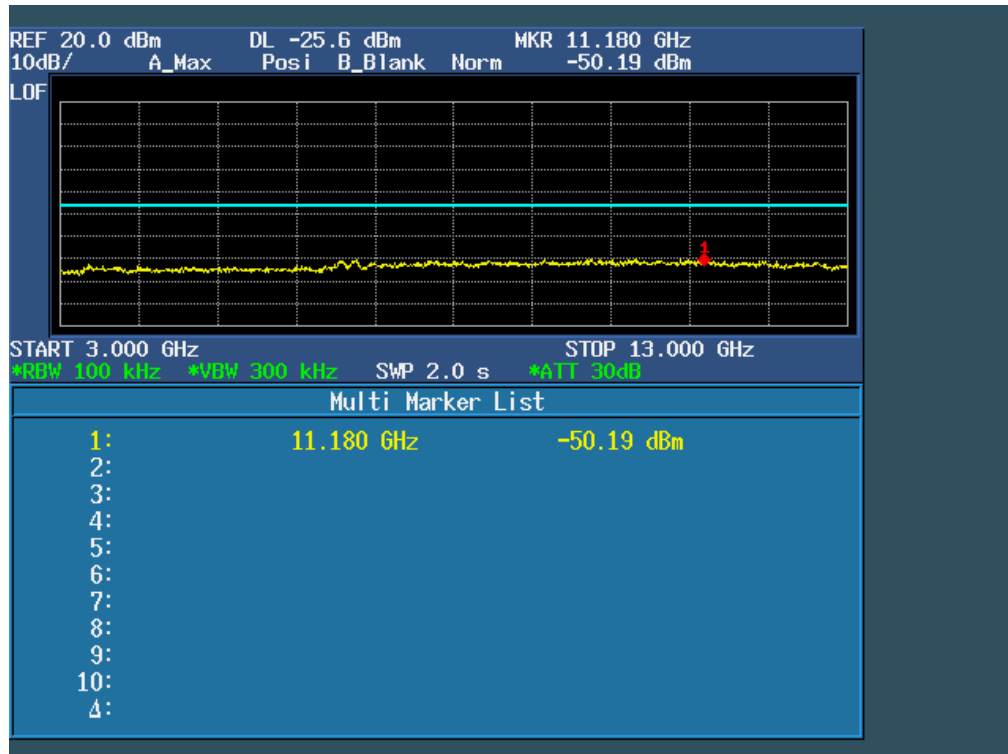

Note: Sweep Points=100000

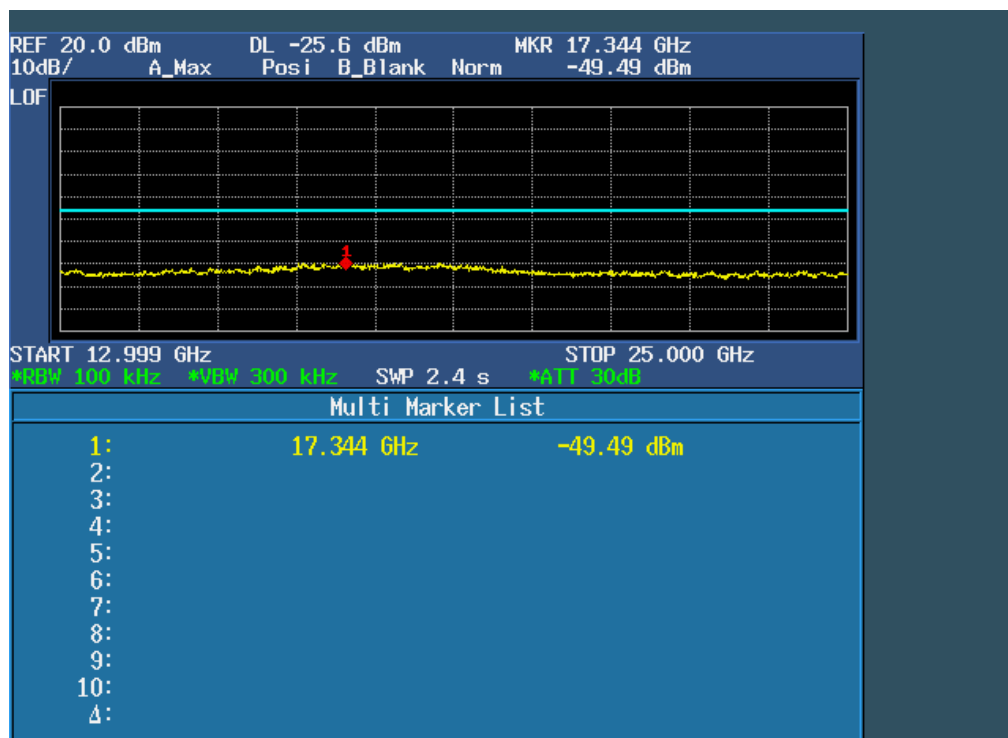

Note: Sweep Points=120000

The High Channel 39(1Mbps): 2480MHz

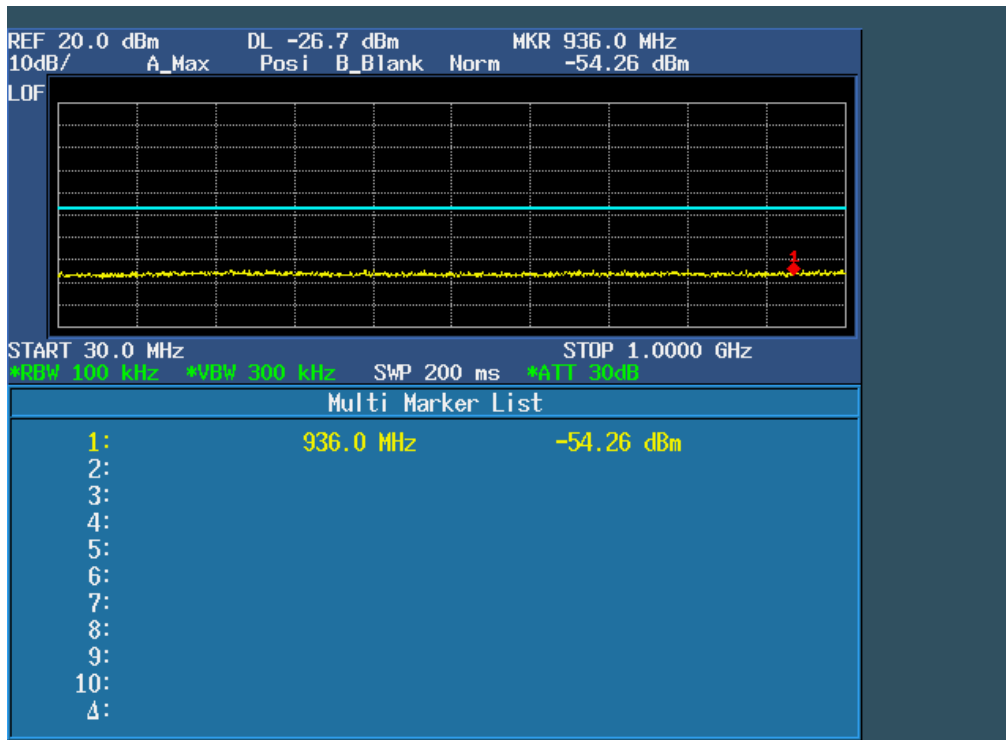

Note: Sweep Points=9700

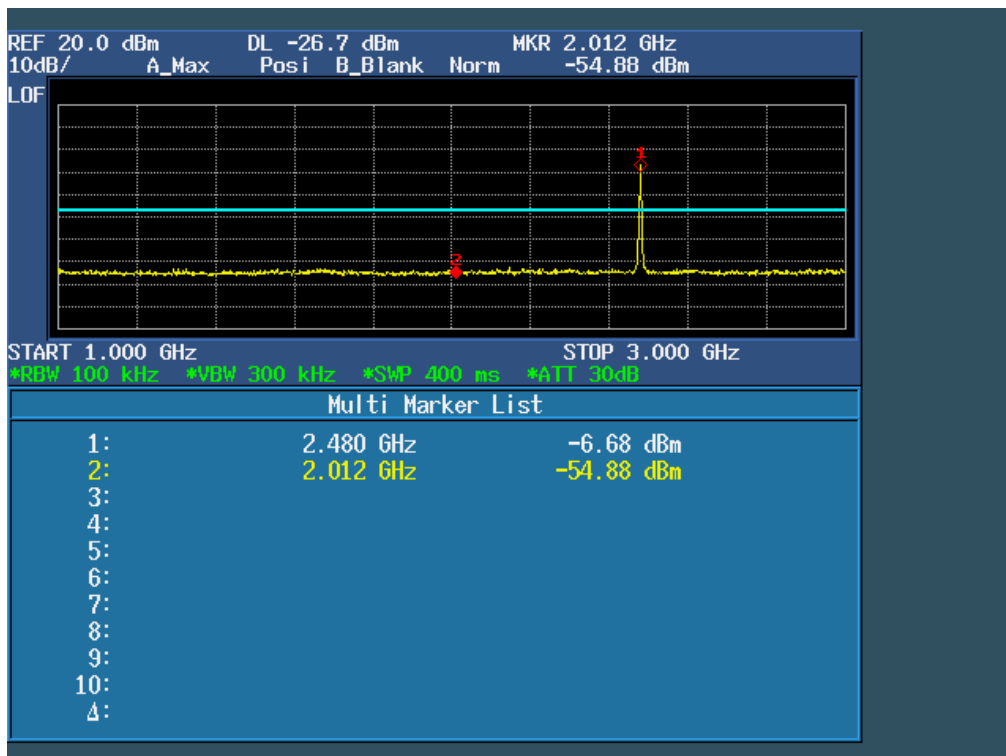

Note: Sweep Points=20000

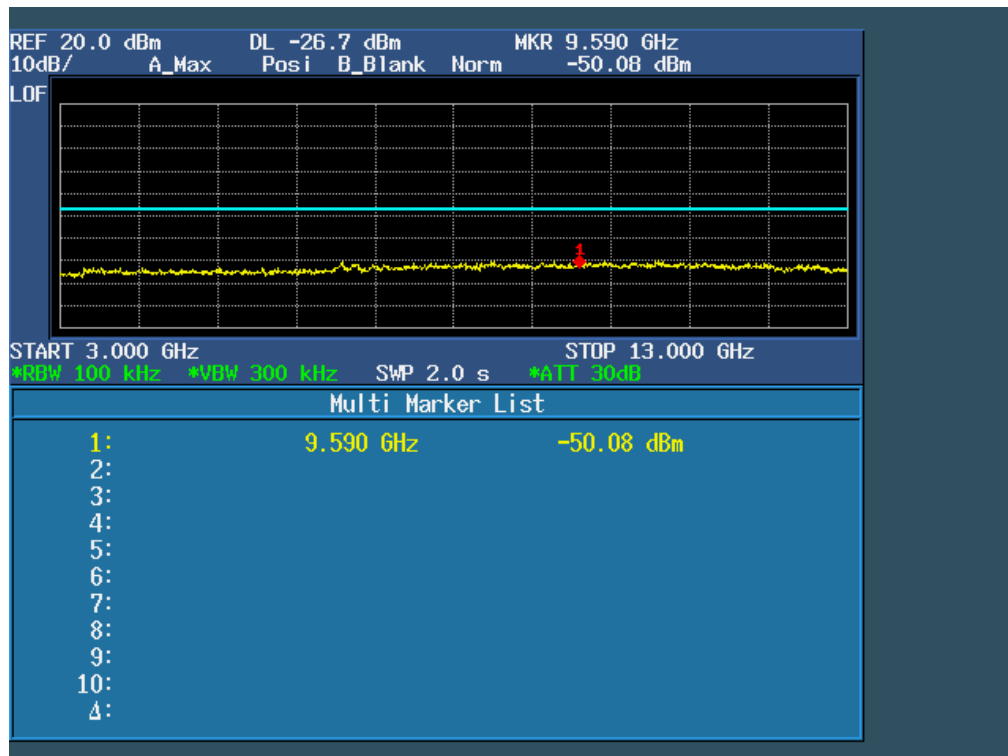

Note: Sweep Points=100000

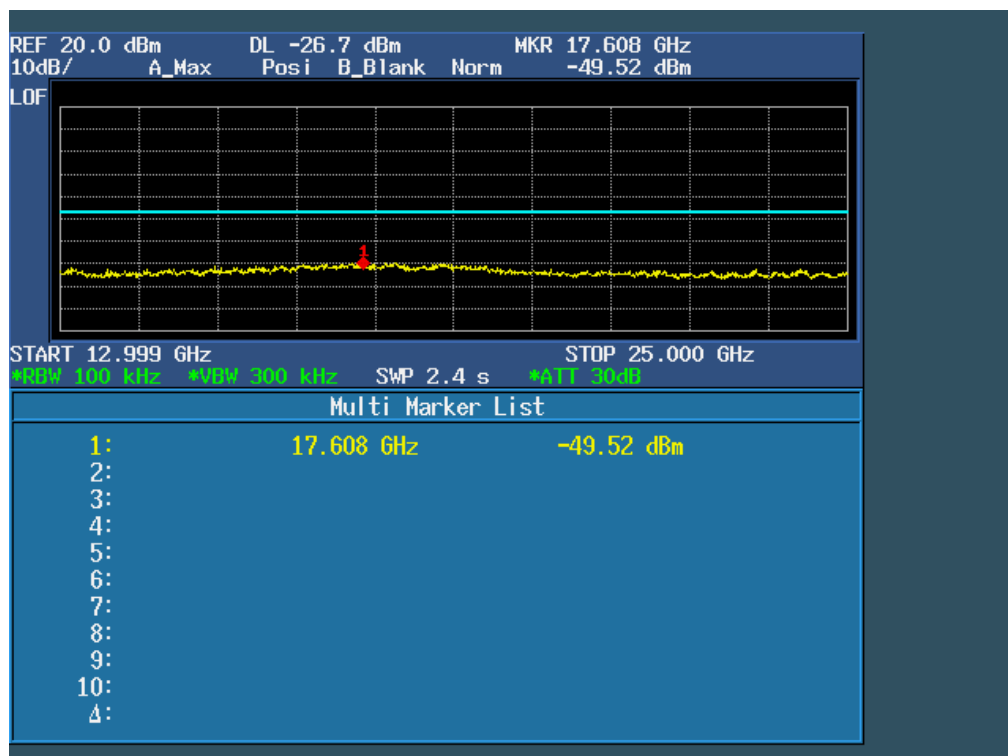

Note: Sweep Points=120000